



THE  
MICROSCOPE:

ITS

HISTORY, CONSTRUCTION, AND APPLICATION:

BEING

A FAMILIAR INTRODUCTION TO THE USE OF THE INSTRUMENT,  
AND THE STUDY OF MICROSCOPICAL SCIENCE.

BY JABEZ HOGG, M.R.C.S., F.R.M.S.,

CONSULTING SURGEON TO THE ROYAL WESTMINSTER OPHTHALMIC HOSPITAL;  
LATE PRESIDENT OF THE MEDICAL MICROSCOPICAL SOCIETY; LL.D.;  
HONORARY FELLOW OF THE ACADEMY OF SCIENCES, PHILADELPHIA. OF  
THE MEDICO-LEGAL SOCIETY, NEW YORK; OF THE BELGIAN MICRO-  
SCOPICAL SOCIETY, ETC.; AUTHOR OF "ELEMENTS OF NATURAL PHILO-  
SOPHY," "A MANUAL OF OPHTHALMOSCOPIC SURGERY," ETC.

*WITH UPWARDS OF FIVE HUNDRED ENGRAVINGS, AND  
COLOURED ILLUSTRATIONS BY TUFFEN WEST.*

*Thirteenth Edition.*

LONDON

GEORGE ROUTLEDGE AND SONS, LIMITED

BROADWAY, LUDGATE HILL

GLASGOW, MANCHESTER, AND NEW YORK





## PREFACE TO THE TENTH EDITION.



**T**WENTY-EIGHT YEARS have passed away since the first edition of this book on the microscope was published. It was hailed as the pioneer of a more useful form of literature than had heretofore appeared on the history, construction and application of the instrument. In this period of time, nine large editions, exceeding in the aggregate 60,000 copies, have been sold out, and yet another edition is called for—a proof, if it were wanting, that the book has not only maintained its ground, but its popularity.

In issuing a tenth edition, the Author, by a careful revision of the text, and by an addition of no fewer than fifty new woodcuts, trusts that his book has been made more acceptable and useful to those for whom it was originally intended. Part I. has been almost wholly rewritten and rearranged. To Mr. Frank Crisp the Author is indebted for Professor Abbe's theory of microscopic vision. To the processes of hardening, section-cutting and staining much in vogue, and which have created a new era in physiological studies, have been assigned the space they seem to merit. Part II. has been carefully revised; a chapter added on the application of the microscope to mineralogical and spectroscopical analysis, and the examination of potable water. That his book may for some years to come be found a familiar introduction to the use of the microscope, and the study of microscopical science, is the earnest wish of the Author.

## PREFACE TO THE EIGHTH EDITION.

**I**N issuing the Eighth Edition of this Work on the MICROSCOPE, I may say that it has been thoroughly revised and for the most part rewritten. Eight carefully and beautifully executed Plates are added, which were drawn by Mr. Tuffen West from natural objects, engraved and printed by Mr. Edmund Evans in his usual excellent manner.

The Author cannot but express his grateful surprise at the extraordinary popular reception which his book has met with: a sale of fifty thousand is an unprecedented event for a work of the kind. This circumstance is extremely gratifying to him, because it affords reasonable grounds for believing that his work has been useful, and encourages renewed effort to make the volume still more acceptable. It has been his endeavour to bring the information contained in its pages up to the most recent discoveries; although, in a daily progressing field of science, it is almost impossible to keep pace with the advance of knowledge in all its ramifications.

1, BEDFORD SQUARE,  
October, 1867.

## PREFACE TO THE FIRST EDITION.



THE Author of this Publication entered upon his task with some hesitation and diffidence ; but the reasons which influenced him to undertake it may be briefly told, and they at once explain his motives, and plead his justification, for the work which he now ventures to submit to the indulgent consideration of his readers.

It had been to him for some time a subject of regret, that one of the most useful and fascinating studies—that which belongs to the domain of microscopic observation—should be, if not wholly neglected, at best but coldly and indifferently appreciated by the great mass of the general public ; and he formed a strong opinion, that this apathy and inattention were mainly attributable to the want of some concise, yet sufficiently comprehensive, *popular* account of the Microscope, both as regards the management and manipulation of the instrument, and the varied wonders and hidden realms of beauty that are disclosed and developed by its aid. He saw around him valuable, erudite, and splendid volumes, which, however, being chiefly designed for circulation amongst a special class of readers, were necessarily pub

lished at a price that renders them practically unattainable by the great bulk of the public. They are careful and beautiful contributions to the objects of science, but they cannot adequately bring the value and charm of microscopic studies home, so to speak, to the firesides of the people. Day after day, new and interesting discoveries, and amplifications of truth already discerned, have been made, but they have been either sacrificed in serials, or, more usually, devoted to the pages of class publications; and thus this most important and attractive study has been, in a great measure, the province of the few only, who have derived from it a rich store of enlightenment and gratification: the many not having, however, participated, to any great extent, in the instruction and entertainment which always follow in the train of microscopical studies.<sup>1</sup>

The manifold uses and advantages of the Microscope crowd upon us in such profusion, that we can only attempt to enumerate them in the briefest and most rapid manner in these prefatory pages.

It is not many years since this invaluable instrument was regarded in the light of a costly toy; it is now the inseparable companion of the man of science. In the medical world, its utility and necessity are fully appreciated, even by those who formerly were slow to perceive its benefits; now, knowledge which could not be obtained even by the minutest dissection is acquired readily by its assistance, which has become as essential to the anatomist and pathologist as are the scalpel and bedside observation. The smallest portion of a diseased structure, placed under a Microscope, will tell more in one minute to the experienced eye, than could be ascertained by long examina-

(1) At the time this work was written, scarcely a book of the kind had been published at a price within the reach of the working classes

tion of the mass of disease in the ordinary method. Microscopic agency, in thus assisting the medical man, contributes much to the alleviation of those multiplied "ills which flesh is heir to." So fully impressed were the Council of the Royal College of Surgeons with the importance of the facts brought to light in a short space of time, that, in 1841, they determined to establish a Professorship of Histology, and to form a collection of preparations of the elementary tissues of both animals and vegetables, healthy and morbid, which should illustrate the value of microscopical investigations in physiology and medical science. From that time, histological anatomy deservedly became an important branch of the education of the medical student.

In the study of Vegetable Physiology, the Microscope is an indispensable instrument ; it enables the student to trace the earliest forms of vegetable life, and the functions of the different tissues and vessels in plants. Valuable assistance is derived from its agency in the detection of adulterations. In the examination of flour, an article of so much importance to all, the Microscope enables us to judge of the size and shape of the starch-grains, their markings, their isolation and agglomeration, and thus to distinguish the starch-grains of one meal from those of another. It detects these and other ingredients, invisible to the naked eye, whether precipitated in atoms or aggregated in crystals, which adulterate our food, our drink, and our medicines. It discloses the lurking poison in the minute crystallisations which its solutions precipitate. "It tells the murderer that the blood which stains him is that of his brother, and not of the other life which he pretends to have taken ; and as a witness against the criminal, it on one occasion appealed to the very sand on which he trod at midnight."

The zoologist finds in the Microscope a necessary co-operator. To the geologist it reveals, among a multiplicity of other facts, "that our large coal-beds are the ruins of a gigantic vegetation ; and the vast limestone rocks, which are so abundant on the earth's surface, are the catacombs of myriads of animal tribes, too minute to be perceived by the unaided vision."

By "conducting the eye to the confines of the visible form," the Microscope proves an effective auxiliary in defining the geometric properties of bodies. Its influence as an instrument of research upon the structure of bodies has been compared to that of the galvanic battery, in the hands of Davy, upon Chemistry. It detects the smallest structural difference, heretofore inappreciable, and, as an ally of Chemistry, enables us to discover the very small changes of form and colour effected by test-fluids upon solids ; and dissects for us, so to speak, the most multiplex compounds. It opens out to the mind an extended and vast tract, opulent in wonders, rich in beauties, and boundless in extent.

The Microscope not only assists studies, and develops objects of profound interest, but also opens up innumerable sources of entertainment and amusement, in the ordinary conventional acceptation of these terms ;—discussing to us peculiarities and attractions in abundance ;—impressing us with the wonderful and beautifully-skilful adaptation of all parts of creation, and filling our minds with additional reverence and admiration for the beneficent and Almighty Creator.

The Author will conclude these prefatory observations with a few words in explanation of his arrangements, and by way of acknowledgment to those to whom he is indebted. He has sought, in the volume that he now lays before the public, to point out and elucidate at once in a

practical manner and in a popular style, the vast fund of utility and amusement which the Microscope affords, and has endeavoured to touch upon most of the interesting subjects for microscopic observation as fully as the restrictions of a limited space, and the nature of the succinct summary, would permit. To have dwelt upon each in complete detail would have necessitated the issue of many expensive volumes—and this would have entirely frustrated the aim which the writer had in view; he has, therefore, contented himself with the humble, but, he trusts, not useless, task of setting up a finger-post, so to say, to direct the inquirer into the wider road. In the section of the work devoted to the minuter portion of creation, he has ventured to dwell somewhat longer, in the belief that that department is more especially the province of the microscopist. He has arranged his topics under special headings, and in separate chapters, for the sake of perspicuity and precision; and has brought the ever-welcome aid of illustrations to convey his explanatory remarks more vividly to the minds of his readers. He is peculiarly indebted to Professor Quekett, whose valuable lectures, delivered annually in the Royal College of Surgeons, and whose multifarious and successful researches, have pre-eminently distinguished him as *the* microscopist of the day. From notes made during the lectures spoken of, and from the many admirable papers which this gentleman has published, much sound information has been gleaned; and the Author has to thank him, in the most sincere and cordial manner, for placing at his disposal the mass of contributions with which he has enriched microscopical science. A free use has been made of the researches of scientific investigators generally—Leeuwenhoek, Ehrenberg, Carpenter, Johnston, Balguy, Busk, Gosse, Huxley, Hassall, Quekett, Carter, and other members of the Microscopical Society of London. His



acknowledgments are likewise due to Mr. George Pearson, for the great care he has bestowed upon the engravings which illustrate these pages.

Finally, it is the Author's hope that, by the instrumentality of this volume, he may possibly assist in bringing the Microscope, and its most valuable and delightful studies, before the general public in a more familiar, compendious, and economical form than has hitherto been attempted; and that he may thus, in these days of a diffused taste for reading and the spread of cheap publications, supply further exercise for the intellectual faculties,—contribute to the additional amusement and instruction of the family circle,—and aid the student of nature in investigating the wonderful and exquisite works of the Almighty. If it shall be the good fortune of this work, which is now confided with great diffidence to the consideration of the public, to succeed in however slight a degree, in furthering this design, the Author will feel sincerely happy, and will be fully repaid for the attention, time, and labour that he has expended.

LONDON, May, 1854.

# CONTENTS

## PART I.

### HISTORY OF THE INVENTION AND IMPROVEMENTS OF THE MICROSCOPE.

#### CHAPTER I.

	PAGE
HISTORY OF THE INVENTION AND IMPROVEMENTS MADE IN THE MICROSCOPE . . . . .	1

#### CHAPTER II.

FORMATION OF IMAGES BY THE ORGAN OF VISION—THEORY OF MICROSCOPICAL VISION, CHROMATIC AND SPHERICAL ABERRATION OF LENSES—MECHANICAL AND OPTICAL PRINCIPLES INVOLVED IN THE CONSTRUCTION OF THE MICROSCOPE—LENSES—MODE OF ESTIMATING THEIR POWER—ACHROMATIC LENSES—MAGNIFYING POWER—WOLLASTON'S DOUBLET—CODDINGTON'S LENS—SIMPLE AND COMPOUND MICROSCOPES—ROSS'S, POWELL AND LEALAND'S, BECK'S, BAKER'S, PILLISCHER'S, LADD'S, MURRAY'S, COLLINS'S, BROWNING'S, WATSON'S, SWIFT'S, HOW'S—MECHANICAL AND SWING STAGE—EYE-PIECES—OBJECTIVES—MODE OF CORRECTING—APERTURE OF—IMMERSION, ETC.—MICROMETERS—POLARISED LIGHT—CAMERA LUCIDA—BINOCULAR—PHOTOGRAPHIC-DRAWING—MICROSPECTROSCOPY. . .	16
--	----

## CHAPTER III.

	PAGE
PRELIMINARY DIRECTIONS—ILLUMINATION—ACCESSORY APPARATUS	
— ACHROMATIC CONDENSERS — GILLETT'S, ROSS'S, BECK'S,	
POWELL AND LEALAND'S, WEBSTER'S, AND OTHERS—	
STEPHENSON'S OBLIQUE ILLUMINATION—ANGULAR APERTURE	
— HOMOGENEOUS-IMMERSION—DIAPHRAGMS—LIEBERKUHN—	
SIDE-REFLECTOR—OBJECT-FINDERS—SECTION-CUTTERS—PRE-	
PARING AND MOUNTING OBJECTS—STAINING VEGETABLE AND	
ANIMAL TISSUES . . . . .	162

## PART II.

## CHAPTER I.

VEGETABLE KINGDOM—VITAL AND CHEMICAL CHARACTERISTICS	
OF CELLS—MICROSCOPIC FORMS OF VEGETABLE CELLS—FUNGI	
— FUNGOID DISEASES—ALGÆ—CONFERVÆ—DESMIDIACEÆ—	
MOSESSES—FERNS—STRUCTURE OF PLANTS—ADULTERATION OF	
ARTICLES USED FOR FOOD—PREPARATION AND MOUNTING—	
FOSSIL PLANTS . . . . .	255

## CHAPTER II.

PROTOZOA — GREGARINÆ — RHIZOPODA — POLYCYSTINA — DIA-	
TOMACEÆ — FOSSIL INFUSORIA — SPONGES — VORTICELLA—	
ACTINIZOA — ROTIFERA — POLYPIPERA — ACALEPHA—ECHI-	
WODERMATA . . . . .	366

## CHAPTER III.

POLYPODA — MOLLUSCA — GASTEROPODA — BRACHIOPODA—CON-	
CHIFERA — CEPHALOPODA — PTEROPODA — TUNICATA—CRUS-	
TACEA — ENTOMOSTRACA—CIRRIPEDA—ENTOZOA — ANNULOZA	
—ANNELIDA . . . . .	511

**CONTENTS.**

**IV**

**CHAPTER IV.**

	<b>PAGE</b>
<b>SUB-KINGDOM ARTICULATA—INSECTA—ARACHNIDA, ETC. . . . .</b>	<b>579</b>

**CHAPTER V.**

<b>VERTEBRATA — PHYSIOLOGY — HISTOLOGY—BOUNDARY BETWEEN THE TWO KINGDOMS—CELL THEORY—GROWTH OF TISSUES —SPECIAL TISSUES — SKIN, NERVES, CARTILAGE, TEETH, BONE, ETC. . . . .</b>	<b>654</b>
--	------------

**CHAPTER VI.**

<b>INORGANIC OR MINERAL KINGDOM—FORMATION OF CRYSTALS— POLARISATION—SPECTRUM ANALYSIS, ETC. . . . .</b>	<b>728</b>
---	------------

**APPENDIX.**

<b>MICROSCOPICAL EXAMINATION OF DRINKING WATER . . . . .</b>	<b>743</b>
--	------------



## DESCRIPTION OF COLOURED PLATES.

### PLATE I.—Page 255.

#### PROTOPHYTA.

**Fig. 1.** *Peziza bicolor*—2. Truffle—3. *Sphaeria herbarum*: a. piece of dead plant, with *S. herbarum* natural size; b. section of same, slightly magnified; d. Ascus with spores, and paraphyses more magnified—4. *Peziza pygmaea*—5. Proliferous form of same—6. *P. corpulans*: Ascus with spores and paraphyses, merely given as a further illustration of structure in *Peziza*—7. Yeast, good—8. Yeast, exhausted—9. *Phyllactinia guttata*—10. Yeast with favus spores and mycelium—11. Favus ferment, with torulae and bacteria-like bodies—12. Puccinia-like-form in ditto, growing from saccharine solution—13. *Aerozoa*—14. Sporules, &c. from eczema produced by yeast—15. *Volvox globator*—16. Amoeboid condition of portion of volvox—17. Puccinia buxi—18. Ditto, more enlarged—(17 to 20 illustrate *Cosmiomyces*)—19. *Æcidium grossulariae*, transverse section of leaf of currant affected by: a. spermatogones on upper surface; b. perithecia with spores—20. Phragmidium bulbosum, development of—21. *Parmelia parietina*, trans. section through a spermatogone, showing green gonidia and spermatia escaping—22. *Æcidium herberidis*, from leaf of herry—23. *Vaucheria sessilis*—24. *Stephanosphaera pluvialis*: a. Full-grown example, germ-cells spindle-shaped, with protoplasmic elongations b. Resting-cell. c. division into four. d. Free swimming ciliated young specimen. e. Amoeboid condition—25. a, b, c, d, e, f and g. Development of Lichen gonidia—26. *Parmelia stellaris* (Lichen), vertical section through apothecium, showing asci, spores, and paraphyses, with gonidia and filamentous medulla. a. Spermatophore with spermatia—27. Moss gonidia assuming amoeboid form.

The intention aimed at is that of furnishing the microscopist with typical forms of Protophytes, as the lowest types of vegetable structure; from 7 to 14, supposed modes of development or rudimentary conditions; Confervoidea illustrated by *Vaucheria* in the Siphonaceae, f. 23, *Stephanosphaera* 24, and *Volvox* 15, in the Volvocineae; their remarkable amoeboid conditions illustrated 16, 24 e, and 27. The protozoan forms assumed in development 7 to 14; 24 a to e; 25 a to g, and 27.

### PLATE II.—Page 274.

#### PROTOPHYTA. ALGÆ.

**Fig. 27.** *Ceramium acanthotum*—28. *Triploceras gracile*—29. *Cosmarium radiatum*—30. *Micrasterias denticulata*—31. *Docidium pristida*—32. *Callithamnion plumula*—33. Diatomaceae, living: a. *Licmophora splendida*; b. *Achnanthes longipes*; c. *Grammatophora marina*. These figures are intended to show the general character of the endochrome and growth of frustule—34. *Callithamnion refractum*—35. *Jungermannia albicans*. b represents elater and spores—36. Leaf with antheridia, or male elements, which are represented more magnified at a to the left of the figure—37. *Ceramium echinotum*—38. *Pleurosigma angulatum*, side view—39. *Delesseria hypoglossum*—40. *Pleurosigma angulatum*, front view, endochrome not represented—41. *Ceramium flabelligerum*.

This plate is chiefly intended to show various forms of Algae. The figures of Desmids, 28 to 33, illustrate the appearance of the

endochrome, and introduce some new forms, described by E. G. Lobb and W. Archer, *Quar. Jour. Micro. Sci.* vol. v. 1865, p. 255; and 38, 40 to illustrate diatom circulation.

### PLATE III.—Page 376.

#### PROTOZOA—RHIZOPODA.

*Fig.* 43, 44, 45, 46, 47, 48, 49, 50, 51, 52. These figures are from diagrams by Major Owen, to illustrate a paper given in *Jour. Linn. Soc.* vol. viii. p. 202. They illustrate forms of living Polycystina, sketched from life by Major Owen, and show the richly coloured appearance of the sarcode; figs. 48 to 52—53. *Monocystis lumbricorum*, round form—54. *Monocystis lumbricorum*, the usual elongated shape—55. *Monocystis serpulæ*—56. *Gregarina Sieboldii*; illustration of septate form, with reflexed hook-like processes—57. *Monocystis lumbricorum*, encysted—58. *Monocystis lumbricorum*, more advanced and pseudo-navicellæ forming—59. *Monocystis lumbricorum*, free pseudo-navicella of—60, 61. *Monocystis lumbricorum*, ameboid forms of—62. Cruciate sponge-spicule—63. *Asteronima Humboldtii*—64. *Eozoon Canadense*, represents appearance of a portion of the natural size—65. *Eozoon Canadense*, magnified, showing portions of cell-walls left uncoloured, the animal sarcode inhabiting it coloured dark green as in nature, and converted by fossilization into a siliceous mineral: the narrow bands passing between these are processes (*stolons*) of the same substance—66. *Actinophrys* Sol, budding—67. *Euglena viridis*: a. contracted, b. elongated form—68. *Acineta tuberosa*—69. *Cécistes longicornis* (Davis).—70. *Oxytricha gibba* (side view)—71. *Oxytricha peillonella*—72. *Limnias* (f. n. sp.)—73. *Cyclidium glaucoma*—74. *Glaucoma scintillans*—75 to 79, 80 to 85, illustrate forms of Foraminifera found by Major Owen, living—75. *Globigerina* (*Orbulina*) *acerosa*, n. sp. broken open to show interior—76. *Globigerina* (*Orbulina*) *contingens*, n. sp. broken open to show interior—77. *Globigerina hirsuta*—78. *Globigerina* (*Orbulina*) *universa*—79. *Globigerina bulloides*—80. *Conochilus vorticella*—81. *Globigerina bulloides*—82. *Globigerina inflata*, sinistral shell—83. *Pulvinulina Micheliniana*—84. *Pulvinulina Canariensis*—85. *P. Menardii*.

The figures of recent Polycystina illustrate the surface-fauna of mid-ocean; the original drawings were made from living specimens, as were those of the Foraminifera; they well represent in their natural state these elegant and interesting objects. 53 to 61 give some idea of the state of our knowledge of forms and life-history of the Gregarinæ. Figures of Infusoria 67, 68, 70, 71, 73, 74: 69, 72, new forms of Rotifera.

### PLATE IV.—Page 511.

#### POLYZOA.

*Fig.* 86. *Harteria elegans*—87. Side view of *Synapta spicula*—88. *Ophiocoma rosula* (very immature specimen), a. Claw hooks, b. Palmate spicula. The development of this creature has been described by G. Hodge, in *Transactions of Tyneside Naturalists' Field-Club*—89. Spine of a star-fish, particularly interesting as showing the reticular calcareous network obtaining in this as in all other hard parts of the Echinodermata—90. Very minute *Spatangus*, obtained from stomach of a bream: many of the spines are gone, but the structure of the shell is intact and forms a beautiful object, interesting in connexion with the source whence obtained—91. *Ophiocoma neglecta*: wriggling or brittle Starfish. The plate does not admit of a figure on a scale sufficient to show the full beauty of this object—92. *Tubularia Dumortieri*—93. *Podicellaria mandibulata* from *Uraster glacialis*—94. *Pedi-*

*cellaria forcepiforma*, from the same—95. *Cristatella mucedo*, statoblast—96. *Cristatella mucedo*, statoblast, edge-view—97. Early stage of development of same—98. *Lophopus crystallinus*—99. *Plumatella repens* and ova, on a piece of submerged stem—100. *Tenia echinococcus*—101. Hydatids in human liver—102. *Bilharzia hæmatobia*—103. *Amphistoma conicum*—104. *Trichina spiralis* from Hambro' pork—105. *Trichina spiralis* extracted—106. 107. *Fasciola gigantea*, after Cobbold.

## PLATE V.—Page 538.

## MOLLUSCA.

*Fig.* 108. *Velutina lævigata*, portion of lingual membrane—109. *Velutina lævigata*, part of mandible—110. *Hydrocystis bleunus*, portion of palate—111. *Sepia officinalis*, portion of palate—112. *Aplysia hybrida*, part of mandible—113. *Loligo vulgaris*, part of palate—114. *Haliotis tuberculatus*, part of palate—115. *Cistula catenata*, part of palate—116. *Patella radiata*, part of palate—117. *Acmecea virginea*, part of palate—118. *Cymba olla*, part of palate—119. *Scapander ligniarius*—120. *Oncidoris bilamellata*, part of palate—121. *Testacella Maugei*, part of palate—122. *Pleurobranchus plumula*, part of mandible—123. *Turbo marmoratus*, part of palate.

Figs. 108 to 123, Lingual membranes of Molluscs; the drawings made by Mrs. Maples from specimens in the late S. P. Woodward's collection, now the property of F. E. Edwards, Esq.

Chosen without any special order; simply as showing typical examples of the wonderful forms met with in the mouth armature of Gasteropod and Cephalopod Mollusca; viewed by polarised light and on a selenite stage.

## PLATE VI.—Page 576.

## INSECTA.

*Fig.* 134. Egg of *Caradina Morpheus*, Mottled Rustic Moth—125. Egg of Tortoise-shell Butterfly, *Vanessa Urtica*—126. Egg of Common Footman, *Lithosia complanula*—127. Egg of Shark Moth, *Cucullia Umbratica*—128. *Mapleaphis*—129. Egg-shell of *Acarus*, empty—130. Egg of House-Fly—131. Mouth of Tsetse-Fly, *Glossina morsitans*—132. Vapourer Moth, *Orgyia antiqua*: antenna of male—133. Vapourer Moth, antenna of female; a. branch more magnified to show rudimentary condition of the parts—134. Tortoise-shell Butterfly; head in profile, showing large compound eye, one of the palpi, and spiral tongue—135. Tortoise-beetle, *Cassida viridis*; under surface of left fore-foot, to show the bifurcate tenent appendages, one of which is given at a more magnified. This form of appendage is characteristic of the family. See West on Feet of Insecta, *Linn. Trans.* vol. xxiii. tab. 43—136. Egg of Blue Argus Butterfly, *Polygonatus Argus*—137. Egg of Mottled Umber, *Eranthis Defoliaria*—138. Egg of *Ennomos erosaria*, Thorn-Moth—139. Egg of *Aspilates Gilvaria*, Straw Belle—140. Blow-fly, *Musca Vomitoria*: left fore-foot, under-surface, to show tenent hairs; a b more magnified; a from below, b from the side—141. House-fly larva—142. *Amara communis*, left fore-foot, under-surface, to show form of tenent appendages, of which one is given more magnified at a. These, in the ground beetles, are met with only in the males, and seem to be used for sexual purposes. The way in which they are protected when not in use is shown by T. West—143. *Ephydra riparia*: left fore-foot, under-surface. This fly is met with sometimes in immense numbers on the water in salt-marshes; it has no power of climbing on glass, which is explained by the structure of the tenent hairs; the central tactile organ also is very peculiar, the whole acting as a float, one to each foot, to enable the fly to rest on the surface of the water; a. one



of the external hairs—144. Egg of Bot-Fly; the larva just escaping—145. Egg of parasite of Pheasant—146. Egg of *Scatophaga*—147. Egg of parasite of magpie—148. Egg of *Jodisvernaria* (Small Emerald Butterfly).

## PLATE VII.—Page 654.

### VERTEBRATA.

*Fig. 149.* Toe of mouse, integuments, bone of foot, and vessels—150. Tongue of mouse, showing erectile papilla, muscular layer, &c.—151. Brain of rat, showing its vascular supply—152. Tongue of cat, showing fungi-form papillæ, with capillary loops passing into them, vessels, &c.; perpendicular section—153. Kidney of cat, showing Malpighian turfts and arteries—154. Small intestine of rat, showing villi and layer of mucous membrane—155. Nose of mouse, showing vascular supply to roots of whiskers—156. Vascular supply to internal gill of tadpole, during one phase of its development—157. Section through sclerotic and retina of cat's-eye, showing vascular supply of choroid and other coats—158. Interior of a fully-developed tadpole, exhibiting heart, vascular arrangement and vascular system throughout, after Whitney.

This plate is designed to show the value of injected preparations in the delineation of animal structures. By thus artificially restoring the blood and distending the tissue, a much better idea is obtained of the relative condition of parts during life, while we receive much assistance in the elucidation of complicated and delicate membranes, the appearance of erectile tissues, papillæ, &c.

## PLATE VIII.—To face Title.

### POLARISCOPE OBJECTS.

*Fig. 158.* New Red Sandstone—159. Quartz—160. Granite—161. Sulph Copper—162. Saliginine—163. Sulph. Iron and Cobalt, crystallized in the way described by Thomas—164. Borax—165. Sulph. Nickel and Potash—166. Kreatine—167. Starch granules—168. Aspartic Acid—169. Fibro-Cells, Orchid—170. Equisetum cuticle—171. Spicula *Holothuria*, Australia—172. Spicula *Holothuria*, Port Essington—173. *Deutzia Scabra*; upper and under surface—174. Cat's tongue, process—175. Prawn shell, exuvia with crystals of lime—176. Grayling scale—177. *Scyllium* caniculus scale—178. Rhinoceros horn, transverse section—179. Horse hoof—180. *Dytiscus*, elytra with crystals of lime.

This plate is especially intended to illustrate the beautiful and gorgeous spectacle produced by polarised light on the various objects here grouped together. It will be seen that structures belonging either to the animal, vegetable, or mineral kingdoms in which the power of unequal or double refraction is suspected to be present, may be submitted to this mode of *micro-chemical* investigation with advantage.

## PLATE IX.—Woodcut.—Page 498.

### ASTEROIDEA—ECHINIDÆ—CRUSTACEA, &c.

Grouped to show the animal and vegetable life of an ordinary window salt-water aquarium.

# THE MICROSCOPE.

## PART I.

### HISTORY OF THE INVENTION AND IMPROVEMENTS OF THE MICROSCOPE.

#### CHAPTER I.

##### HISTORY OF THE MICROSCOPE.

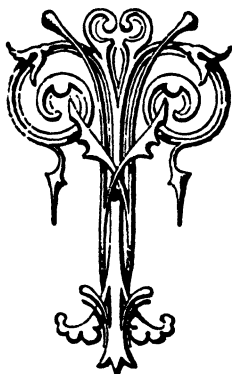

THE instrument known as the Microscope derives its name from two Greek words, *μικρός*, *small*, and *σκοπέω*, *to view*; that is, to see or view such minute objects as without its aid would be invisible.

The honour of the invention is claimed by the Italians and the Dutch; the name of the inventor, however, is lost. Probably the discovery did not at first appear sufficiently important to engage the attention of those men who, by their reputation in science, were able to establish an opinion of its merit, and to hand down the name of its inventor to succeeding ages.

If we consider the microscope as an instrument consisting of one lens only, it is not at all improbable that it was known at a very early period, nay even in a degree to

the Greeks and Romans ; at any rate, it is tolerably certain that spectacles were used as early as the thirteenth century. Now as the glasses of these were made of different convexities, and consequently of different magnifying powers, it is natural to suppose that smaller and more convex lenses were made, and applied to the examination of minute objects. Many among the learned refuse to the ancients a knowledge of magnifying lenses, and *à fortiori* that of refracting telescopes, since, according to them, the Greeks and Romans had only very imperfect notions with respect to the fabrication of glass.

From a passage in Aristophanes it is plain that globules of glass were sold at the shops of the grocers of Athens, in the time of that comic author. He speaks of them as "burning spheres."

Pliny states that the immense theatre (it was capable of containing eighty thousand persons) erected at Rome by Scaurus, son-in-law of Sylla, was three stories in height, and that the second of these stories was entirely inlaid with a mosaic of glass.

Ptolemy, in his "Optics," has inserted a table of the refractions which light experiences under different angles of incidence, in passing from air into glass. The values of these angles, which differ only in a slight degree from those obtained in the present day by means of similar experiments, prove that the glass of the ancients differed very little from that manufactured in our own times.

There is in the French Cabinet of Medals a seal, said to have belonged to Michael Angelo, the fabrication of which, it is believed, ascends to a very remote epoch, and upon which fifteen figures have been engraven in a circular space of fourteen millimètres in diameter. These figures *are not all visible to the naked eye.*

Cicero makes mention of an Iliad of Homer written upon parchment, which was comprised in a nutshell.

Pliny relates that Myrmecides, a Milesian, executed in ivory a square figure which a fly covered with its wings.

Unless it be maintained that the powers of vision of our ancestors surpassed those of the most skilful modern artists, these facts establish that the magnifying property of lenses was known to the Greeks and Romans nearly

two thousand years ago. We may besides advance a step further, and borrow from Seneca a passage whence the same truth will emerge in a manner still more direct and decisive. In the "Natural Questions" we read: "However small and obscure the writing may be, it appears larger and clearer when viewed through a globule of glass filled with water."

Dutens has seen in the Museum of Portici ancient lenses which had a focal length of only nine millimètres. He actually possessed one of these lenses, but of a longer focus, which was extracted from the ruins of Herculaneum.

At the meeting of the British Association, held at Belfast in the year 1852, Sir David Brewster showed a plate of rock-crystal worked into the form of a lens, which was recently found among the ruins of Nineveh. Sir David Brewster, so competent a judge in a question of this kind, maintained that this lens had been destined for optical purposes, and that it never was an article of dress.

It is not difficult to fix the period when the microscope first began to be generally known, and to be used for the purpose of examining minute objects; for though we are ignorant of the name of the first inventor, we are acquainted with the names of those who introduced it to public view. Zacharias Jansens and his son are said to have made microscopes before the year 1590: about that time the ingenious Cornelius Drebell brought one made by them with him to England, and showed it to William Borrell and others. It is possible this instrument of Drebell's was not strictly what is now called a microscope, but was rather a kind of microscopic telescope, something similar in principle to that lately described by M. Aepinus in a letter to the Academy of Sciences at St. Petersburg. It was formed of a copper tube six feet long and one inch in diameter, supported by three brass pillars in the shape of dolphins; these were fixed to a base of ebony, on which the objects to be viewed by the microscope were placed. Fontana, in a work which he published in 1646, says that he had made microscopes in the year 1618: this may be perfectly true, without derogating from the merit of the Jansens; for we have many instances in our own times of more than

one person having made the same invention nearly simultaneously, without any communication from one to the other. In 1685 Stelluti published a description of the parts of a bee, which he had examined with a microscope.

The history of the microscope, like that of nations and arts, has had its brilliant periods, in which it shone with uncommon splendour, and was cultivated with extraordinary ardour; and these have been succeeded by intervals marked with no discovery, and in which the science seemed to fade away, or at least to lie dormant, till some favourable circumstance—the discovery of a new object, or some new improvement in the instruments of observation—awakened the attention of the curious, and reanimated their researches. Thus, soon after the invention of the microscope, the field it presented to observation was cultivated by men of the first rank in science, who enriched almost every branch of natural history by the discoveries they made by means of this instrument.

*The Single, or Simple Microscope.*—We shall first speak of the single microscope, that having been invented and used long before the double or compound microscope. When the lenses of the single microscope are very convex, and consequently the magnifying power great, the field of view is small; and it is so difficult to adjust with accuracy their focal distance, that it requires some practice to render the use of them familiar. It was with an instrument of this kind that Leeuwenhoek and Swammerdam, Lyonet and Ellis, examined the invisible forms of nature, and by their example stimulated others to the same pursuit.

About the year 1665, small glass globules began to be occasionally applied to the single microscope, instead of convex lenses; and by these globules an immense magnifying power was obtained. Their invention has been generally attributed to M. Hartsoeker; though it appears that we are really indebted to the celebrated Dr. Hooke for this discovery, for he described the manner of making them in the preface to his *Micrographia Illustrata*, published in the year 1656.

Mr. Stephen Gray<sup>1</sup> having observed some irregular particles within a glass globule, and finding that they

(1) *Philosophical Transactions*, 1696.

appeared distinct and prodigiously magnified when held close to his eye, concluded, that if he placed a globule of water in which there were any particles more opaque than the water near his eye, he should see those particles distinctly and highly magnified. The result of this idea far exceeded his expectation. His method was, to take on a pin a small portion of water which he knew contained some minute animalcules; this he laid on the end of a small piece of brass wire, till there was formed somewhat more than a hemisphere of water; on applying it then to the eye, he found the animalcules enormously magnified; for those which were scarcely discernible with his glass globules, with this appeared as large as ordinary-sized peas.

Dr. Hooke thus describes the method of using this water-microscope: "If you are desirous," he says, "of obtaining a microscope with one single refraction, and consequently capable of procuring the greatest clearness and brightness any one kind of microscope is susceptible of, spread a little of the fluid you intend to examine on a glass plate; bring this under one of your globules, then move it gently upwards till the fluid touches the globule, to which it will soon adhere, and that so firmly as to bear being moved a little backwards or forwards. By looking through the globule, you will then have a perfect view of the animalcules in the drop."

The construction of the single microscope is so simple, that it is susceptible of but little improvement, and has therefore undergone few alterations; and these have been chiefly confined to the mode of mounting it, or to additions to its apparatus. The greatest improvement this instrument has received was made by Lieberkuhn,<sup>1</sup> about the year 1740: it consists in placing the small lens in the centre of a highly-polished concave speculum of silver, by which means a strong light is reflected upon the upper surface of an object, which is thus examined with great ease and pleasure. Before this contrivance, it was almost impossible to examine small opaque objects with any degree of exactness; for the dark side of the object being next the eye, and also overshadowed by the proximity of

(1) Dr. Nathaniel Lieberkuhn of Berlin.

the instrument, its appearance was necessarily obscure and indistinct. Lieberkuhn adapted a separate microscope to every object: but all this labour was not bestowed on trifling objects; his were generally the most curious anatomical preparations, twelve of which, with their microscopes, are deposited in the Museum of the Royal College of Surgeons.

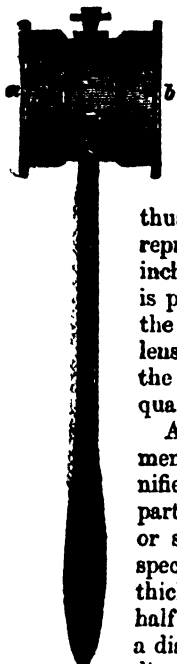

Lieberkuhn's instrument, fig. 1, is thus described by Professor Quekett:<sup>1</sup> *a b* represents a piece of brass tube, about an inch long and an inch in diameter, which is provided with a cap at each extremity; the one at *a* carries a small double-convex lens of half an inch in focal length, whilst the one at *b* carries a condensing lens three-quarters of an inch in diameter.

A vertical section of one of these instruments is seen in fig. 2: *a* represents the magnifier, which is lodged in a cavity formed partly by the cap *a*, and by the silver cup or speculum *l*. In front of the lens is the speculum *l*, which is a quarter of an inch thick at its edge, and whose focus is about half an inch; in front of this again there is a disk of metal *c*, three-eighths of an inch in diameter, connected by a wire with the small knob *d*; upon this disk the injected object is fastened, and is covered over with some

kind of varnish which has dried of a hemispherical figure.

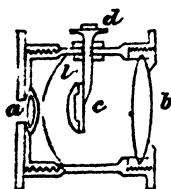

Fig. 2.  
Lieberkuhn's Microscope.

Between this knob and the inside and outside of the tube there are two slips of thin brass, which act as springs to keep the wire and disk steady. When the knob is moved, the injected object is carried to or from the lens, so as to be in its focus, and to be seen distinctly, whilst the condensing lens *b* serves to concentrate the light on the speculum. To the

(1) Practical Treatise on the Microscope, p. 16.

lower part of the tube a handle of ebony, about three inches in length, is attached by a brass ferrule and two screws. The use of this instrument is obvious: it is held in the hand in such a position that the rays of light from a lamp or white cloud may fall on the condenser *b*, by which they are concentrated on the speculum *l*; this, again, further condenses them on the object and the disk *c*, which object, when so illuminated, can readily be adjusted by the little knob *d*, so as to be in the focus of the small magnifier at *a*.

We must not omit in this place some account of Leeuwenhoek's microscopes, which were rendered famous throughout all Europe, on account of the numerous discoveries he had made with them. At his death he bequeathed a part of them to the Royal Society.

The microscopes he used were all single, and fitted up in a convenient and simple manner: each consisted of a very small double-convex lens, let into a socket between two plates riveted together, and pierced with a small hole; the object was placed on a silver point or needle, which, by means of screws adapted for that purpose, might be turned about, raised or depressed at pleasure, and thus be brought nearer to, or be removed farther from the glass, as the eye of the observer, the nature of the object, and the convenient examination of its parts required.

Leeuwenhoek fixed his objects, if they were solid, to these points with glue; if they were fluid, he fitted them on a little plate of talc, or thin-blown glass, which he afterwards glued to the needle in the same manner as his other objects. The glasses were all exceedingly clear, and of different magnifying powers, proportioned to the nature of the object and the parts designed to be examined. He observed, in his letter to the Royal Society, that "from upwards of forty years' experience, he had found the most considerable discoveries were to be made with glasses of moderate magnifying power, which exhibited the object with the most perfect brightness and distinctness." Each instrument was devoted to one or two objects; hence he had always some hundreds by him.

The three first compound microscopes that attract our notice are those of Dr. Hooke, Eustachio Divini, and Philip



Bonnani. Dr. Hooke gives us an account of his in the preface to his *Micrographia*, published in the year 1667: it was about three inches in diameter, seven inches long, and furnished with four draw-out tubes, by which it might be lengthened as occasion required; it had three glasses—a small object-glass, a middle glass, and a deep eye-glass. Dr. Hooke used all the glasses when he wanted to take in a considerable part of an object at once, as by the middle glass a number of radiating pencils were conveyed to the eye which would otherwise have been lost; but when he wanted to examine with accuracy the small parts of any substance, he took out the middle glass, and only made use of the eye and object lenses; “for,” he writes, “the fewer the refractions are, the clearer and brighter the object appears.”

Dr. Hooke also gave us the first and most simple method of finding how much any compound microscope magnifies an object. He placed an accurate scale, divided into very minute parts of an inch, on the stage of the microscope; adjusted the microscope till the divisions appeared distinct, and then observed with the other eye how many divisions of a rule similarly divided and laid on the stage were included in one of the magnified divisions; “for if one division, as seen with one eye through the microscope, extends to thirty divisions on the rule, which is seen by the naked eye, it is evident that the diameter of the object is increased or magnified thirty times.”

An account of Eustachio Divini's microscope was read at the Royal Society in 1668. It consisted of an object-lens, a middle glass, and two eye-glasses, which were plano-convex lenses, and were placed so that they touched each other in the centre of their convex surfaces. The tube in which the glasses were enclosed was as large as a man's leg, and the eye-glasses as broad as the palm of the hand. It had four several lengths: when shut up was 16 inches long, and magnified the diameter of an object 41 times, at the second length 90, at the third length 111, and at the fourth length 143 times. It does not appear that Divini varied the object-glasses.

Philip Bonnani published an account of his two microscopes in 1698. Both were compound. The first was

similar to that which Mr. Martin published as new, in his *Micrographia Nova*, in 1712. His second was like the former, composed of three glasses, one for the eye, a middle glass, and an object lens; they were mounted in a cylindrical tube, which was placed in a horizontal position; behind the stage was a small tube with a convex lens at each end; beyond this was a lamp; the whole capable of various adjustments, and regulated by a pinion and rack. The small tube was used to condense the light on to the object.

A short time before this, Sir Isaac Newton having discovered his celebrated theory of light and colours, was led to improve the telescope, and apply his principles most successfully to the construction of a compound reflecting microscope. On the 6th of February, 1672, he communicated to the Royal Society his "design of a microscope by reflection." It consisted of a concave spherical speculum of metal, and an eye-glass which magnified the reflected image of any object placed between them in the conjugate focus of the speculum. He also pointed out the proper mode of illuminating objects by artificial light, as he describes it, "of any convenient colour not too much compounded," *mono-chromatic*. We find other two plans of this kind; the first that of Dr. Robert Barker, and the second that of Dr. Smith. In the latter there were two reflecting mirrors, one concave, and the other convex: the image was viewed by a lens. This microscope, though far from being executed in the best manner, performed, says Dr. Smith, very well, so that he did not doubt it would have excelled others, had it been properly finished.

In 1738, Lieberkuhn's invention of the solar microscope was communicated to the public. The vast magnifying power obtained by this instrument, the colossal grandeur with which it exhibited the "minutiae of nature," the pleasure which arose from being able to display the same object to a number of observers at the same time, by affording a new source of rational amusement, increased the number of microscopic observers, who were further stimulated to the same pursuits by Mr. Trembley's famous discovery of the polype. The discovery of the wonderful properties of this little animal, together with the works of Mr. Trembley

Mr. Baker, and Mr. Adams, combined to spread the reputation of the instrument.

In 1742, Mr. Henry Baker, F.R.S., published an admirable treatise on the microscope. He also read several papers before the Royal Society on the subject of his microscopic discoveries. In the wood-cut (fig. 3) at the end of this chapter we have represented an elegant scroll "pocket microscope with a speculum," described by him as a new invention.

In 1770, Dr. Hill published a treatise, in which he endeavours by means of the microscope to explain the construction of timber, and to show the number, the nature, and office of its several parts, their various arrangements and proportions in the different kinds; and he points out a way of judging, from the structure of trees, the uses they will best serve in the affairs of life.

M. L. F. Delabarre published an account of his microscope in 1777. It does not appear that it was superior in any respect to those that were then made in England. It was inferior to some; for those made by Mr. Adams, in 1771, possessed all the advantages of Delabarre's in a higher degree, except that of changing the eye-glasses.

In 1774, Mr. George Adams, the son of the above, improved his father's invention, and rendered it useful for viewing opaque as well as transparent objects. This instrument, made and described by him,<sup>1</sup> continued in use up to the time of the invention of the achromatic improvement, proposed and made in 1815 for Amici, who subsequently gave so much time to the investigation of polarised light, and the adaptation of a polarising apparatus to the microscope.

In 1812, Dr. Wollaston proposed a doublet in which the glasses were in contact, under the name of a "Periscopic Microscope." And he says, "with this doublet I have seen the finest striæ and serratures on the scales of the *lepisma* and *podura*, and the scales on a gnat's wing."

In the year 1816, Fraunhofer, a celebrated optician of Munich, constructed object-glasses for the microscope of a single achromatic lens, in which the two glasses, although in juxtaposition, were not cemented together: these glasses

(1) *Microscopical Essays*, 1787.

were very thick, and of long focus. Although such considerable improvements had taken place in the making of achromatic object-glasses since their first discovery by Euler in 1776, we find, even at so late a period as 1821, M. Biot writing, "that opticians regarded as impossible the construction of a good achromatic microscope." Dr. Wollaston also was of the same opinion, "that the compound instrument would never rival the single."

In 1823, experiments were commenced in France by M. Selligues, which were followed up by Fraunhofer in Munich, by Amici in Modena, by M. Chevalier in Paris, and by the late Dr. Goring and Mr. Tulley in London. To M. Selligues we are indebted for the first plan of making an object-glass composed of four achromatic compound lenses, each consisting of two lenses. The focal length of each object-glass was eighteen lines, its diameter six lines, and its thickness in the centre six lines, the aperture only one line. They could be used combined or separated.

A microscope constructed on this principle, by M. Chevalier, was presented by M. Selligues to the *Académie des Sciences* on the 5th of April, 1824. In the same year, and without a knowledge of what had been done on the Continent, the late Mr. Tulley, at the suggestion of Dr. Goring, constructed an achromatic object-glass for a compound microscope of nine-tenths of an inch focal length, composed of three lenses, and transmitting a pencil of eighteen degrees; this was the first that had been made in England.

Sir David Brewster first pointed out in 1813, the value of precious stones, the diamond, ruby, garnet, &c., for the construction of microscopes. "The durability," he says, "of lenses made of precious stones is one of their greatest recommendations. Lenses of glass undergo decomposition, and lose their polish in course of time. Mr. Baker found the glass lenses of Leeuwenhoek utterly useless after they became the property of the Royal Society. The glass articles found in Nimroud were decomposed, while the rock crystal lens was uninjured." Mr. Pritchard at one time made two plano-convex lenses from a very perfect diamond, one the twentieth of an inch focus, which was

purchased by the late Duke of Buckingham, and another the thirtieth of an inch focus.

In March 1825, M. Chevalier presented to the Society for the Encouragement of the Sciences, an achromatic lens of four lines focus, two lines in diameter, and one line in thickness in the centre. This lens was greatly superior to the one before noticed, which had been made by him for M. Selligues.

In 1826, Professor Amici, of Modena, who from the year 1815 to 1824 had abandoned his experiments on the achromatic object-glass, was induced, after the report of Fresnel to the Academy of Science, to resume them; and in 1827 he brought to this country and to Paris a horizontal microscope, in which the object-glass was composed of three lenses superposed, each having a focus of six lines and a large aperture. This microscope had also extra eye-pieces, by which the magnifying power could be increased. A microscope constructed on Amici's plan by Chevalier, during the stay of that physician in Paris, was exhibited at the Louvre, and a silver medal was awarded to its maker.<sup>1</sup>

"While these practical investigations were in progress," says Mr. Ross, "the subject of achromatism engaged the attention of some of the most profound mathematicians in England. Sir John Herschel, Professors Airy and Barlow, Mr. Coddington, and others, contributed largely to the theoretical examination of the subject; and though the results of their labours were not immediately applicable to the microscope, they essentially promoted its improvement."

Mr. Jackson Lister, in 1829, succeeded in forming a combination of lenses upon the theory propounded by these gentlemen, and effected one of the greatest improvements in the manufacture of object-glasses, by joining together a plano-concave flint lens and a convex, by means of a transparent cement, Canada balsam. This is desirable

(1) In 1855, when the Jury on Microscopes at the Paris Exposition were comparing the rival instruments, Professor Amici brought a compound achromatic microscope, comparatively of small dimensions, which exhibited certain striæ in test objects better than any of the instruments under examination. This superiority was produced by the introduction of a drop of water between the object and the object-glass.

to be taken as a basis for the microscopic object-glass; it diminishes very nearly half the loss of light from reflection, which is considerable at the numerous surfaces of a combination; the clearness of the field and brightness of the picture is evidently increased by doing this; and it prevents any dewiness or vegetation from forming on the inner surfaces. Since this time, Mr. Ross has been constantly employed in bringing the manufacture of object-glasses to their greatest perfection, and at length they have attained to their present improved manufacture. Having applied Mr. Lister's principles with a degree of success never anticipated, so perfect were the corrections given to the achromatic object-glass, so completely were the errors of sphericity and dispersion balanced or destroyed, that the circumstance of covering the object with a plate of the thinnest glass or talc disturbed the corrections, if they had been adapted to an uncovered object, and rendered an object-glass which was perfect under one condition sensibly defective under the other. Here was another and unexpected difficulty to be overcome, but which was finally accomplished; for in a communication made to the Society of Arts in 1837, Mr. Ross stated, that by separating the anterior lens in the combination from the other two, he had been completely successful. The construction of this object-glass will be illustrated and explained in a subsequent chapter.

The rapid improvement of the achromatic microscope was greatly furthered by the spirit of liberality evinced by the late Sir David Brewster, Dr. Goring, Messrs. R. H. Solly, Bowerbank, and Wenham. To Dr. Goring we are indebted for the first triplet achromatic object-glass, for the diamond lens, and for the improved reflecting instrument of Amici by Cuthbert.

The instruments manufactured by the leading London makers, Messrs. Ross, Powell and Lealand, and Smith and Beck, are unsurpassed in any part of the world.

American opticians have shown themselves quite equal to their brethren of the old country. The improved forms of instruments manufactured by Tolles,

Zentmayer, Sidle, Spencer, and Gundlach, prove worthy rivals of those of London makers. Indeed, the Ross-Zentmayer model has been generally admired, and its principle of construction is admittedly of the highest order of mechanical skill. On the Continent, Hartnach, Zeiss, Mertz, Verich, Nacet, etc., hold equal rank as makers of first-class instruments. Hartnach's accurately fitted concentric stage is the admiration of microscopists, and has consequently been very generally adopted. The greatest and most important improvement the instrument has received is that of the immersion objective. Amici, some fifty years ago, first applied the immersion system. Professor Scæmmering, writing of its adaptation to a microscope of Amici's, says of it, "Its magnifying power, and the admirable precision and clearness with which the object is seen, seems astonishing." The immense importance of the system was only slowly realized in England, and when, some ten or a dozen years ago, the Author and Mr. John Mayall, Jun., made an attempt to bring the immersion objective to the notice of the Microscopical Society, much opposition was offered, especially by opticians. Its advantages are now fully acknowledged; it is understood to give increase of light, superior definition and clearness to the optical image, an image obtained by simpler means of illumination, whilst a much greater working distance between the object and the objective is secured.

Further improvements remain to be noticed; first, that of the adaptation of the "Homogeneous Immersion" system, the principle of the construction of which is also due to Professor Amici; its realization for microscopy is, however, the work of Messrs. J. W. Stephenson, and of the learned Professor E. Abbe, of Jena; secondly, that effected in the microscope stand itself, as my pages were passing through the press—"The Universal Inclining and Rotating Microscope," devised by Mr. Wenham, to whom the instrument is already so much indebted. This great change in the form of the instrument has been made with the special object of obtaining a large range of effects of oblique light both

in altitude and azimuth. Fig. 3a shows the instrument inclined at about the usual position for working with central lights; and fig. 3b shows the section at the lowest point in the horizontal position and with the sub-stage removed. The principal movements of this improved form of Ross-Wenham microscope were described in the *Journal of the Royal Microscopical Society*, April, 1882, p. 255. Briefly stated, the leading principle followed in the construction of the stand is that when it is inclined backwards, or turned laterally or horizontally, or rotated on the base-plate, a pencil of light from a fixed source will always reach the object, all the movements, whether separate or combined, radiating from the object—or the prolongation of its axis—as a centre.

The stage rotates completely and is a modification of Tolles', in which

the rectangular motions are effected by milled heads acting on the surface and entirely within the circumference. This instrument, which is mounted on the Ross-Zentmayer system, will be the microscope of the future.

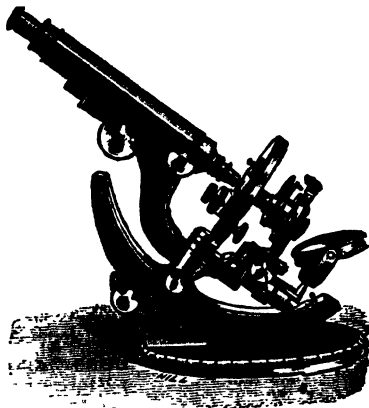

FIG. 3a.

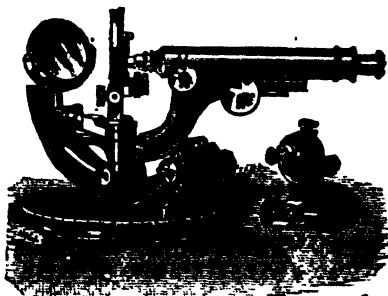

FIG. 3b.

*The Ross-Wenham Microscope.*



## CHAPTER II.

THE FORMATION OF IMAGES BY THE ORGAN OF VISION—THEORY OF MICROSCOPICAL VISION—CHROMATIC AND SPHERICAL ABERRATION OF LENSES—MECHANICAL AND OPTICAL PRINCIPLES INVOLVED IN THE CONSTRUCTION OF THE MICROSCOPE—LENSES—ACHROMATIC LENSES—MAGNIFYING POWER—WOLLASTON'S DOUBLET—CODDINGTON'S LENS—EYE-PIECES—SIMPLE AND COMPOUND MICROSCOPES—CONSTRUCTION—APERTURE—IMMERSION SYSTEM, ETC.

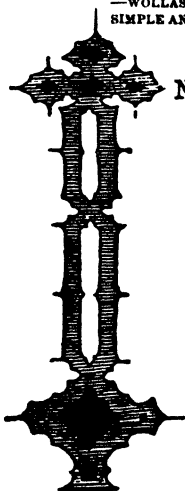

**N** the construction of the modern microscope, optical and mechanical principles of some importance are involved. These principles, together with the more recent improvements effected in the instrument generally, I shall proceed to explain.<sup>1</sup>

The microscope depends for its utility and operation upon concave and convex lenses, and the course of rays of light passing through them. Lenses are usually defined as pieces of glass, or other transparent substances, having their two surfaces so formed that the rays of light, in passing through them, have their direction changed, are made to converge or diverge from their original parallelism, or to become parallel after converging or diverging. When a ray of light passes in an oblique direction from one transparent medium to another of a different density, the direction of the ray is changed both on entering and leaving; this influence is the result of the well-known law of *refraction*,—that a ray of light passing from a *rare* into a *dense* medium is refracted towards the perpendicular, and *vice versa*.

(1) For an explanation of the optical laws as applied to the microscope see "The Microscope, in Theory and Practice," Nagell and Schwendener, translated and published by Swan Sonnenschein and Allen, 15, Paternoster Square E.C. Also "A Treatise on Optics," by J. Parkinson.

*The Organ of Vision.*—Before passing to the consideration of the formation of images by the human eye, let me say that owing to want of space, I am unable to enter as fully as I could wish on the consideration of the microscope as an optical instrument. Those of my readers, however, who desire to become better acquainted with the physical optics of the instrument, will do well to consult one or more of the numerous standard works devoted to this special branch of physics, or, what may even be more profitable, secure a book specially devoted to it. I can confidently recommend for profitable study the translation (already indicated) of Nägeli and Schwendener, "Theory and Practice of the Microscope," by the indefatigable Secretary of the Royal Microscopical Society, Mr. Frank Crisp.

The formation of images by the organ of vision; the way in which the waves of light impinge upon the nervous tissue of the eye, and there leave behind an impression of external objects, to be conveyed to the sensory organ, the brain, comprises a series of vital and physical actions of a marvellously complicated nature. A recent philosophical writer sums up the various operations associated with seeing as follows:—"Sight may be defined as an aggregation of colour feelings, and muscle feelings, and the objects of sight groups of such feelings, suggesting other feelings in all individuals. All the sensations which go along with the sensation of sight, interpret it, just as language is interpreted by the brain. That is, a sensation calls up a conception, which is made up of an aggregation of beliefs, and is a link between sensation and action." (Clifford.) In the terser language of a sage, "The eye sees only what it brings with it the power of seeing" (Carlyle); and which, translated, means, that the unaided eye sees but little, and that little imperfectly or incorrectly unless assisted, as students of the microscope soon discover. The power of seeing, undoubtedly, has a definite limit assigned to it, which differs in most individuals, and varies with increasing age, and from functional causes. The act of seeing is partly voluntary, and partly muscular, consequently it is capable of

being increased, or rather strengthened, by the judicious exercise, and at will, of a power termed accommodation. The near-point of useful sight is fixed, for the normal eye, at about ten inches from the object. It is for this reason that English opticians have taken an arbitrary measurement of ten inches for the length of the body of the microscope. The most distant point of distinct vision is placed where the image of the object falls exactly on the most sensitive spot of the retina, termed the far-point of vision. When the eye is accommodated for viewing a near object, the curvature of the lens is slightly changed, and its front surface approaches somewhat closer to the cornea. The range of the field of vision is computed to be about 160 degrees on the horizontal plane, and 120 degrees in the vertical. The eye is perfectly adjusted for parallel rays of light, but when it has to do with divergent rays it is frequently found unequal to the task of uniting them. The great mobility of the eye-ball, however, almost wholly compensates for this slight defect; and, practically, all rays are parallel which proceed from distant objects, that is from objects at twenty feet or upwards.

Good visual accommodation depends upon three causes: 1st, changes in the indices of refraction of the media (cornea, lens, &c.); 2nd, displacement of the surface of projection (the retina, analogous to the artificial production of accommodation by the adjustment of the camera obscura); and 3rd, alteration in the forms of the refracting surfaces.

Physicists assure us that the organ of vision, heretofore regarded as the most wonderful instance of creative wisdom, is not perfectly achromatic; that, in fact, it possesses no proper provision for the correction of its own chromatic and spherical aberrations, nor for the correction of the chromatic aberration arising from defects as an optical instrument, nor that arising from the compound nature of light, the rays of which, it is known, are refracted in different degrees and intensities—a defect slightly exaggerated by defective centering of the refractive surfaces of the internal eye. The

want of perfect achromatism is a fact somewhat analogous to that belonging to the flint and crown-glass construction of the lenses of optical instruments. On the other hand, with regard to its spherical aberration—straying away of the rays of light—it is said that the great mobility of the iris corrects this defect. The iris acts somewhat as the diaphragm does in the microscope, shuts off the circumferential rays of light—those rays which, straying away, produce distortion of images in lenses, and increase the circles of dispersion over the retina. Luminous rays on entering the eye are partly absorbed and partly reflected, and on issuing once more follow the same course as they did in the first instance. A certain portion, however, of each bundle of axial rays, after having undergone refraction, are brought to an accurate focus on points of the retina, and excite a limited number of the outer layer of rods and cones. The sharpness with which the aerial image is seen depends upon the magnitude of the retinal image and the diameter of the visual angle. Other considerations enter into the theory of vision, as that of the situation of the retinal image, etc. By education and experience we become acquainted with the fact that objects are not so well defined under a small visual angle, and for seeing minute objects it is absolutely necessary to resort to artificial means. Withal, to view the infinitely little in all their beauty of form and complexity of design, we require, for the most part, associated with light, a difference and intensity of brightness and of colour; for the delicacy of visual perception is found to depend less upon the number of the retinal elements, set in motion by the waves of light, than upon the number of elements capable of appreciating and separating the many delicately coloured tints, which are embraced by the images. (Hermann.)

#### *Theory of Microscopical Vision.*

Recently, however, Professor Abbe, of Jena, a high authority on all that relates to microscopical optics, has propounded a theory of the formation of the images

of minute objects, which is the most important contribution to the theory of the microscope that has yet appeared, furnishing, as it does, an explanation of many points which have hitherto greatly puzzled and perplexed microscopists, and showing that the conditions of ordinary vision do not apply to objects of *minute* size, so that microscopical vision is in this case a thing *sui generis*, in regard to which nothing can be legitimately inferred from the optical phenomena connected with objects of larger size.

The essential point in the Abbe theory is that the images of minute objects in the microscope are not formed, as was formerly supposed, exclusively on the ordinary *dioptric* method (that is in the same way in which they are formed in the camera or telescope), but that they are very largely affected by the peculiar manner in which the minute constitution of the object breaks up the incident rays, giving rise to *diffraction*.

The phenomena of diffraction in general may be observed experimentally by plates of glass ruled with fine lines. Fig. 4 shows the appearance presented by a single candle-flame seen through such a plate, an uncoloured image of the flame occupying the centre,



FIG. 4.

the flame, which become dimmer as they recede from the centre. A similar phenomenon may be produced by dust scattered over a glass plate,

and by other objects whose structure contains very minute particles, the rays suffering a characteristic change in passing through such objects; that change consisting in the breaking up of a parallel beam of light into a group of rays, diverging with wide angle and forming a regular series of maxima and minima of intensity of light, due to difference of phase of vibration.

In the same way, in the microscope, the diffraction pencil originating from a beam incident upon, for instance, a diatom, appears as a fan of isolated rays,

decreasing in intensity as they are further removed from the direction of the incident beam transmitted through the structure, the interference of the primary waves giving a number of successive maxima of light with dark interspaces.

When a diaphragm opening is interposed between the mirror, and a plate of ruled lines placed upon the stage such as fig. 5, the appearance shown in fig. 5a, will be observed at the back of the objective on removing the eye-piece and looking down the tube of the microscope. The centre circles are the images of the diaphragm opening produced by the direct rays, while those on the other side (always at right angles to the direction of the lines) are the diffraction images produced by the rays which are bent off from the incident pencil.

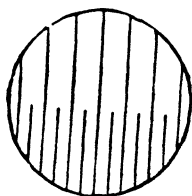

FIG. 5.

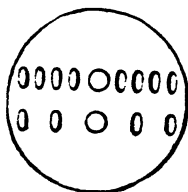

FIG. 5a

In homogeneous light the central and lateral images agree in size and form, but in white light the diffraction images are radially drawn out, with the outer edges red and the inner blue (the reverse of the ordinary spectrum), forming, in fact, regular spectra, the distance separating each of which varies inversely as the closeness of the lines, being, for instance, twice as far apart when the lines are twice as close.

The influence of these diffraction spectra may be demonstrated by some very striking experiments, which show that they are not by any means accidental phenomena, but are directly connected with the image which is seen by the eye.

The first experiment shows that with, for instance, the central beam, or any one of the spectral beams

alone, only the contour of the object is seen, the addition of at least one diffraction spectrum being essential to the visibility of the structure.

When by a diaphragm placed at the back of the objective, as in fig. 6, we cover up all the diffraction spectra of fig. 5a, and allow only the central rays to reach the image, the object will appear to be wholly deprived of fine

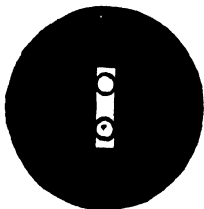

FIG. 6.

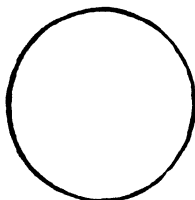

FIG. 6a.

details, the outline alone will remain, and every delineation of minute structure will disappear, just as if the microscope had suddenly lost its optical power, as in fig. 6a.

This experiment illustrates a case of the *obliteration* of structure by obstructing the passage of the diffraction spectra to the eye-piece. The next experiment shows how the appearance of fine structure may be *created* by manipulating the spectra.

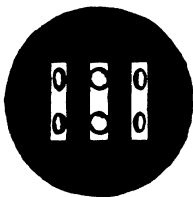

FIG. 7.

FIG. 7a.

When a diaphragm such as that shown in fig. 7 is placed at the back of the objective, so as to cut off each alternate one of the upper row of spectra in fig. 5a, that row will obviously become identical with the lower one, and if the theory holds good, we

should find the image of the upper lines identical with that of the lower. On replacing the eye-piece, we see that it is so, the upper set of lines are doubled in number, a new line appearing in the centre of the space between each of the old (upper) ones, and upper and lower set having become to all appearance identical, as seen in fig. 7a.

In the same way, if we stop off all but the outer

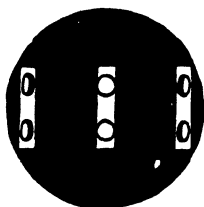

FIG. 8.

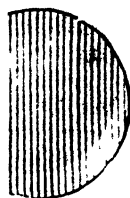

FIG. 8a.

spectra, as in fig. 8, the lines are apparently again doubled, as seen in fig. 8a.

A case of apparent creation of structure, similar in principle to the foregoing, though more striking, is afforded by a network of squares, as in fig. 9, having sides *parallel* to this page, which gives the



FIG. 9.

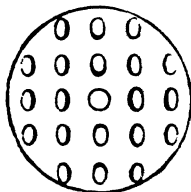

FIG. 9a.

spectra shown in fig. 9a, consisting of vertical rows for the horizontal lines and horizontal rows for the vertical ones. But it is readily seen that two diagonal rows of spectra exist at right angles to the two diagonals of the squares, just as would arise from sets of lines in the direction of the diagonals, so that if the theory holds good we ought to find, on obstructing all



the other spectra and allowing only the diagonal ones to pass to the eye-piece, that the vertical and horizontal lines have disappeared and are replaced by two new sets of lines at *right angles to the diagonals*.

On inserting the diaphragm, fig. 10, and replacing the eye-piece, we find in the place of the old network the one shown in fig. 16, the squares being, however,

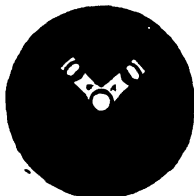

FIG. 10.

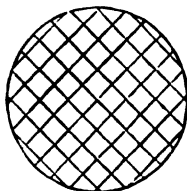

FIG. 10a.

smaller in the proportion of  $1 : \sqrt{2}$ , as they should be in exact accordance with theory.

An object such as *Pleurosigma angulatum*, which gives six diffraction spectra arranged as in fig. 11 should, according to theory, show markings in a hexagonal arrangement. For there will be one set of lines at right angles to  $b, a, e$ , another set at right angles to  $c, a, f$ , and a third at right angles to  $g, a, d$ .

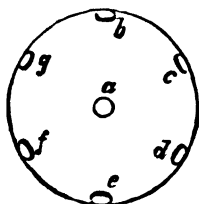

FIG. 11.

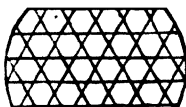

FIG. 11a.

These three sets of lines will obviously produce the appearance shown in fig. 11a.

A great variety of appearances may be produced with the same arrangement of spectra. Any two adjacent spectra with the central beam (as  $b, c, a$ ) will form equilateral triangles and give hexagonal

markings. Or by stopping off all but  $g, c, e$  (or  $b, d, f$ ), we again have the spectra in the form of equilateral triangles; but as they are now further apart, the sides of the triangles in the two cases being as  $\sqrt{3} : 1$ , the hexagons will be smaller and three times as numerous. Their sides will also be arranged at a different angle to those of the first set. The hexagons may be entirely obliterated by admitting only the spectra  $g, c$ , or  $g, f$ , or  $b, f$ , etc., when new lines will appear at right angles, or obliquely inclined, to the median line. By varying the combinations of the spectra, therefore, different figures of varying size and positions are produced, all of which cannot, of course, represent the true structure. Not only, however, may the appearance of particular structure be obliterated or created, but it may even be *predicted* before it has been actually seen under the microscope. If the position and relative intensity of the spectra in any particular case are given, the character of the resultant image may be worked out by mathematical calculations solely. A remarkable instance of such a prediction is to be found in the case recorded by Mr. Stephenson, where a mathematical student who had never seen a diatom, worked out the purely mathematical result of the interference of the six spectra  $b - g$  of fig. 11 (identical with *P. angulatum*), giving the drawing copied in fig. 12. The special feature was the small markings between the hexagons, which had not before been noticed on *P. angulatum*. On more closely scrutinizing a valve, stopping out the central beam and allowing the six spectra only to pass, the small markings were found actually to exist, though they were so faint that they had escaped observation until the result of the mathematical deduction had shown that they *ought* to be seen.

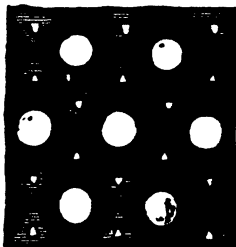

FIG. 12.

These experiments prove that diffraction plays a

most important part in the formation of microscopical images, since dissimilar structures give identical images when the difference of their diffractive effect is removed, and conversely similar structures may give dissimilar images when their diffractive images are made dissimilar. Whilst a purely dioptric image answers point for point to the object on the stage, and enables a safe inference to be drawn as to the actual nature of that object, the visible indications of minute structure in a microscopical image are not always or necessarily conformable to the real nature of the object examined, so that nothing more can safely be inferred from the image as presented to the eye, than the presence in the object of such structural peculiarities as will produce the particular diffraction phenomena on which these images depend.

It should be carefully noted that diffraction is not limited to lined objects, it applies to structures of all kinds. But lined objects give brighter and more distinct diffraction spectra, and are best suited for experimental illustration. Nor, again, is diffraction limited to transparent or semi-transparent objects viewed by transmitted light. It equally applies to opaque objects, and is, in fact, universal whenever the strictly uniform propagation of the luminous waves is disturbed by the interposition either of opaque or semi-opaque elements, or of transparent elements of unequal refraction, which give rise to unequal retardations of the waves.

### *The Simple Microscope.*

A single lens, or a sphere of glass or water, forms a simple microscope, or, as it is more familiarly called, a magnifying glass. Lenses are ground of various forms, as represented in fig. 13; *a* is a plane glass of equal thickness throughout; *b*, a meniscus, concave on one side, convex on the other; *c*, a double-concave; *d*, a plano-concave; *e*, a double-convex; *f*, a plano-convex.

By a proper combination of certain forms of lenses, we unite on the same sensible point a number of rays, proceeding from the same point of an object, each

ray carrying with it the image of the point from whence it proceeds, and as all the rays unite to form an image of the object from whence they were emitted, this image is brighter in proportion as there are more rays united, and more distinct in proportion as the order in which they have proceeded is perfectly preserved and in perfect union. The point at which parallel rays meet, after passing through a lens, is known as its principal focus, and its distance from the middle of the lens, the focal length. The radiant point and its image after refraction are known as the conjugate foci. In every lens the right line perpendicular to the two surfaces is the *axis* of the lens. This is indicated by the line drawn through the several lenses, as seen in the diagram. The point where the axis cuts the surface of the lens is termed the *vertex*.



FIG. 13.

Parallel rays falling on a *double-convex* lens are brought to a focus in the centre of its diameter; conversely, rays diverging from that point are rendered parallel. Hence the focus of a *double-convex* lens will be at just half the distance, or half the length, of the focus of a *plano-convex* lens having the same curvature on one side. The distance of the focus from the lens will depend as much on the degree of curvature as upon the refracting power (called the index of refraction) of the glass of which it may be formed. A lens of crown-glass will have a longer focus than a similar one of flint-glass; since the latter has a greater refracting power than the former. For all ordinary practical purposes, we may consider the *principal focus*—as the

focus for parallel rays is termed—of a double-convex lens to be at the distance of its radius, that is, in its centre of curvature; and that of a plano-convex lens to be at the distance of twice its radius, that is, at the other end of the diameter of its sphere of curvature. The converse of all this occurs when divergent rays are made to fall on a convex lens. Rays already converging are brought together at a point nearer than the principal focus; whereas rays diverging from a point within the principal focus are rendered still more diverging, though in a diminished degree. Rays diverging from points more distant than the principal focus on either side, are brought to a focus beyond it: if the point of divergence be within the circle of curvature, the focus of convergence will be beyond it; and *vice versa*. The same principles apply equally to a *plano-convex lens*; allowance being made for the double distance of its principal focus. They also apply to a lens whose surfaces have different curvatures; the principal focus of such a lens is found by multiplying the radius of one surface by the radius of the other, and dividing this product by half the sum of the radii.

The refracting influence of *concave lenses* will be precisely the opposite of that of convex. Rays which fall upon them in a parallel direction, will be made to diverge as if from the principal focus, which is here called the *negative focus*. This will be, for a *plano-concave lens*, at the distance of the diameter of the sphere of curvature; and for a *double-concave*, in the centre of that sphere. A lens convex on one side and concave on the other, is known as a *meniscus*.

In the construction of the microscope, either simple or compound, the curvature of the lenses employed is spherical. Convergent lenses, however, with spherical curvatures, have the defect of not bringing all the rays of light which pass through them to one and the same focus. Each circle of rays from the axis of the lens to its circumference has a different focus, as shown in fig. 14. The rays *a a*, which pass through the lens near its circumference, is seen to be *more refracted*, or come to a focus at a shorter distance

behind it than the rays *b b*, which pass through near its centre or axis, and are *less refracted*. The consequence of this defect of lenses with spherical curvatures, which is called *spherical aberration*, is that a well-defined image or picture is not formed by them, for when the object is focussed, for the circumferential rays, the picture projected to the eye is rendered indis-

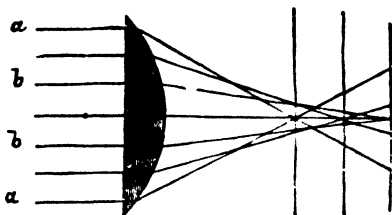

FIG. 14.

tinct by a halo or confusion produced by the central rays falling in a circle of dissipation, before they have come to a focus. On the other hand, when placed in the focus of the central rays, the picture formed by them is rendered indistinct by the halo produced by the circumferential rays, which have already come to a focus and crossed, and now fall in a state of divergence, forming a circle of dissipation. The grosser defects of spherical aberration are corrected by cutting off the passage of the rays *a a*, through the circumferences of the lens, by means of a stop diaphragm, so that the central rays, *b b*, only are concerned in the formation of the picture. This defect is reduced to a minimum, by using the meniscus form of lens, which is the segment of an ellipsoid instead of a sphere.

The ellipse and the hyperbola are forms of lenses in which the curvature diminishes from the central ray, or axis, to the circumference *b*; and mathematicians have shown that spherical aberration may be practically got rid of by employing lenses whose sections are ellipses or hyperbolas. The remarkable discovery of

this fact was made by Descartes, who mathematically demonstrated it.

If  $al, al'$ , for example, fig. 15, be part of an ellipse whose greater axis is to the distance between its foci  $ff$  as the index of refraction is to unity, then parallel rays  $r'l, r'l'$  incident upon the elliptical surface  $l'a'l$ , will be refracted by the single action of that surface into lines which would meet exactly in the farther focus  $f$ , if there were no second surface intervening between  $l'a'l$  and  $f$ . But as every useful lens must have two surfaces, we have only to describe a circle  $l'a'l'$  round  $f$  as a centre, for the second surface of the lens  $l'l$ .

As all the rays refracted at the surface  $l'a'l'$  converge

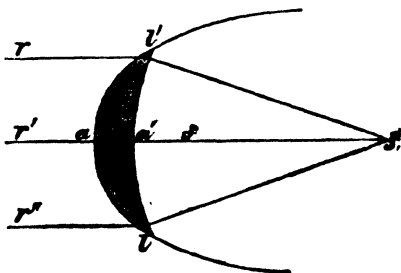

FIG. 15.

accurately to  $f$ , and as the circular surface  $l'a'l'$  is perpendicular to every one of the refracted rays, all these rays will go on to  $f$  without suffering any refraction at the circular surface. Hence it should follow, that a meniscus whose convex surface is part of an ellipsoid, and whose concave surface is part of any spherical surface whose centre is in the farther focus, will have no appreciable spherical aberration, and will refract parallel rays incident on its convex surface to the farther focus.

It is almost impossible to give microscopical lenses other than the spherical form. The best made convex single lenses do not bring rays of light to an exact focus. If a true elliptical or hyperbolic curve could be

got, lenses would not only be very nearly perfect, but spherical aberration would be nearly overcome. But even this serious defect can be considerably reduced in practice by observing a certain ratio between the radii of the anterior and posterior surfaces of lenses; thus the spherical aberration of a lens, the radius of one

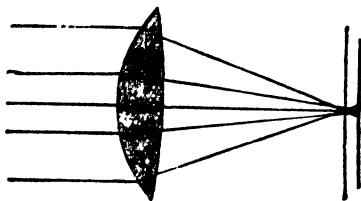

FIG. 16.

surface of which is six or seven times greater than that of the other, as in fig. 16, will be much reduced when its more convex surface is turned forward to receive parallel rays, than when its less convex surface is turned forwards.<sup>1</sup>

Two forms of lenses may be so combined, that their opposite aberrations shall neutralize each other, and magnifying power be gained. The aberration of a concave lens is exactly the opposite of that of a convex lens, so that the aberration of a convex lens placed in its most favourable position may be corrected by a concave lens of much less power in its most favourable position. This principle of a combination was proposed by Sir John F. W. Herschel; his "aplanatic doublet," fig. 17, consists of a double-convex lens and a meniscus. A doublet of this kind is an extremely useful and available one for microscopic purposes. By a skilful combination of crown and flint glass lenses with spherical curves—assisted by the Lister adjusting collar, or, what is even more efficient, the homogeneous immersion



FIG. 17.

(1) It must be borne in mind that in lenses having curvatures of the kind the object would only be correctly seen in focus at one point—the mathematical or geometrical axis of the lens.



system—theoretical and practical difficulties have been overcome in the construction of the modern microscope, and which, until quite lately, were thought to be insurmountable, thus greatly adding to the value of the instrument as a means of scientific research.

*Chromatic Aberration.*—A far greater difficulty arises from the unequal refrangibility of the different coloured rays which together make up white light. It is this difference in refrangibility that produces a complete separation of rays by the prism, forming the spectrum.

The correction of chromatic and spherical aberration is effected in a very ingenious manner, by combining a convex lens made of crown-glass, and a concave lens of flint-glass. If we examine closely the image projected on the table of a camera obscura provided with a common lens, we see that it is fringed with the colours of the rainbow; again, if we look through a common mag-

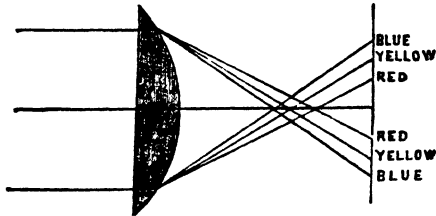

FIG 18.

nifying-glass at the letters on the title-page of a book, we see them slightly coloured at their edges in a similar manner. The cause of this iridescent border is that the primitive rays—red, yellow, and blue,—of which a colourless ray of light is composed, are not equally refrangible. Hence they are not simultaneously brought to one point or focus; the blue rays being the most refrangible, come to a focus nearer the lens than the yellow, which are less refrangible, and the yellow rays than the red, which are the least refrangible. It is seen, in fig. 18, chromatic aberration proves still more detrimental to the distinct definition of images formed by a lens, than spherical aberration. This arises more

from the sizes of the circles of dissipation, than from the iridescent border, and it may still exist, although the spherical aberration of the lens is quite corrected. Chromatic aberration is, as before stated, corrected by combining, in the construction of lenses, two media of opposite forms, differing from each other in the proportion in which they respectively refract and disperse the rays of light; so that the one medium may, by equal and contrary dispersion, neutralize the dispersion caused by the other, without, at the same time, wholly neutralizing its refraction. It is a remarkable fact that the media found most valuable for the purpose should be a combination of pieces of crown and flint glass, of *crown-glass* whose index of refraction is 1.519, and dispersive power 0.036, and of *flint-glass* whose index of refraction is 1.589, and dispersive power

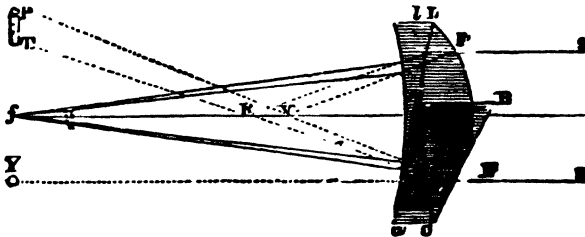

FIG 19.

0.0393. The focal length of the convex crown-glass lens must be  $4\frac{1}{3}$  inches, and that of the concave flint-glass lens  $7\frac{2}{3}$  inches, the combined focal length of which is 10 inches. The diagram, fig. 19, shows how rays of light are brought to a focus, free from colour.

In this diagram, L L is a *convex* lens of *crown-glass*, and l l a *concave* one of *flint-glass*. A convex lens will refract a ray of light (s) falling at F on it exactly in the same manner as the prism A B C, whose faces touch the two surfaces of the lens at the points where the ray enters, and quits. The ray s F, thus refracted by the lens L L, or prism A B C, would have formed a spectrum (P T) on a screen or wall, had there been no other lens,

the violet ray ( $F V$ ) crossing the axis of the lens at  $v$ , and going to the upper end ( $\nu$ ) of the spectrum; and the red ray ( $F R$ ) going to the lower end ( $T$ ). But, as the flint-glass lens ( $l l$ ) or the prism  $A a c$ , which receives the rays  $F V$ ,  $F R$ , at the same points, is interposed, these rays will be united at  $f$ , and form a small circle of white light, the ray ( $S F$ ) being now refracted without colour from its primitive direction ( $S F Y$ ) into the new direction ( $F f$ ). In like manner, the corresponding ray ( $S' F'$ ) will be refracted to  $f$ , and a white and colourless image there formed by the two lenses.

*Magnification.*—The apparent size of an object is the angle it subtends to the eye, or the angle formed by two

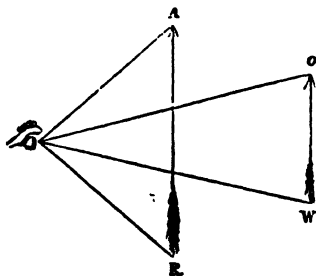

FIG. 20.

lines drawn from the centre of the eye to the extremity of the object. This will be understood on reference to fig. 20. The lines drawn from the eye to  $A$  and  $R$  form an angle, which, when the distance is small, is nearly twice as great as the angle from the eye to  $O W$ , formed by lines drawn at twice the distance. The arrow at

$A R$  will therefore appear nearly twice as long as  $O W$ , being seen under twice the angle; and in the same proportion for any greater or less difference in distance. This, then, is called the angle of vision, or the visual angle. Now the utility of a convex lens interposed between a near object and the eye consists in its reducing the divergence of the rays forming the several pencils issuing from it; so that they enter the eye in a state of moderate divergence, as if they were issuing from an object beyond the near point of distinct vision; when a well-defined image will be formed upon the retina. In fig. 21, a double-convex lens is placed before the eye, near which is a small arrow, representing the object under examination; the cones

issuing from it are portions of the rays of light diverging from the several points and falling upon the lens. These rays, if permitted to fall at once upon the pupil, would be too divergent to allow of their being brought to an exact focus upon the retina by the dioptric media of the eye. But being first passed through the lens, they are bent into nearly parallel lines, or lines diverging from some points within the limits of distinct vision. Thus altered, the eye receives rays precisely as if they had emanated directly from a larger arrow placed at ten inches from the eye. The difference

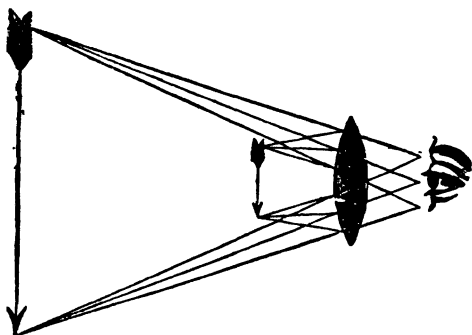

FIG. 21.

between the real and the imaginary arrow is called the magnifying power of the lens. The object, when thus seen, appears to be magnified nearly in the proportion which the focal distance of the lens bears to the distance of the object when viewed by the unassisted eye; and is entirely owing to the object being distinctly viewed so much nearer to the eye than it could be without the lens.<sup>1</sup> With these preliminary remarks as to the medium by which microscopic power is obtained, we shall proceed to apply them to its construction.

*The Microscope.*—A Microscope, as I have before said, may be either a *single*, or *simple*, or a *compound*

(1) "The Magnifying Power of Short Spaces" has been ably elucidated by John Gorham, Esq., M.R.C.S. *Journal of Microscopical Society* October, 1854.

instrument. The *simple* microscope may consist of one, as seen in fig. 21, or of two or three lenses; if the latter, then so arranged as to have the effect only of a *single lens*. In the *compound microscope*, not less than two lenses can be employed: one to form an inverted image of the object, which, being the nearest to the object, is called the *object-glass*; the other to magnify this image, and from being near the eye of the observer, is called the *eye-glass*.

I have so far considered a lens simply with reference to its enlargement of the object, the increase of the angle under which the object is seen. A further and equally important consideration is that of the number of rays or quantity of light by which every point of the object is rendered visible; and much may be accomplished, as I have already pointed out, by the combination of two or more lenses, which will at once reduce the angles of incidence and refraction. The first satisfactory combination for the purpose was the invention of the celebrated Dr. Wollaston. His doublet (fig. 22) consists of two plano-convex lenses having their focal lengths in the proportion of one to three, or nearly so, and mounted at a distance which is readily ascertained by experiment. The plane sides of the lenses should be towards the object, and the lens of shortest focal length next the object.

It appears that Dr. Wollaston was led to this invention by considering that the achromatic Huyghenian eye-piece, presently to be described, would, if reversed, possess a power equal to that of the simple microscope. But it will be evident, when the eye-piece is understood, that the circumstances which render it achromatic are very imperfectly applicable to the simple microscope, and that the doublet, without a nice adjustment or a stop, would be valueless.

The nature of the corrections which take place in the doublet is explained in the annexed diagram, where  $l o l'$  is the object,  $p$  a portion of the cornea of the eye, and  $d d$  the stop, or limiting aperture (fig. 22).

Now it will be observed that each pencil of light proceeding from  $l l'$  of the object is rendered

### THE DOUBLET.

excentric by the diaphragm  $d, d$ ; consequently, they pass through the lenses on opposite sides of their common axis  $o p$ ; thus each becomes affected by opposite errors, which to some extent balance and correct each other. To take the pencil  $l$ , for instance, which enters the eye at  $r b, r b$ : it is bent to the right

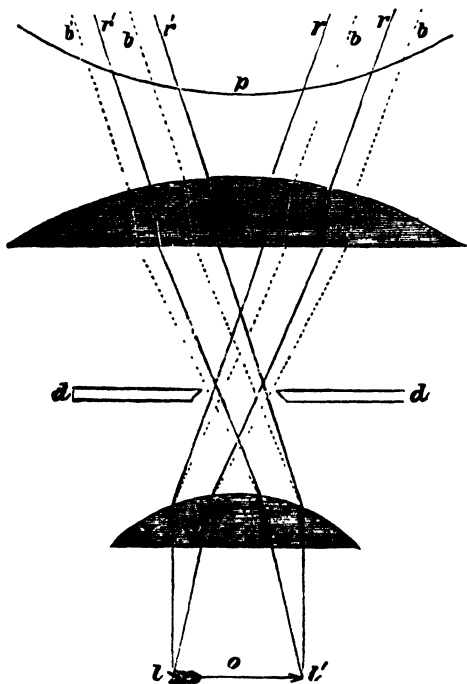

FIG. 22.

at the first lens, and to the left at the second; and as each bending alters the direction of the blue ray more than the red, and, moreover, as the blue ray falls nearer the margin of the second lens, where the refraction being more powerful than nearer the centre, compensates in some degree for the greater focal length of the second lens, the blue rays will emerge very

nearly parallel, and of consequence colourless to the eye. At the same time the spherical aberration has much diminished, because the side of the pencil as it proceeds through one lens passes nearest the axis and in the other nearest the margin.

This explanation applies to pencils farthest from the centre of the object. The central pencils, it is obvious, would pass both lenses symmetrically, the same portions of rays occupying nearly the same relative places in both lenses. The blue ray would enter the second lens nearer to its axis than the red; and being thus less refracted than the red by the second lens, a small amount of compensation would take place, quite different in principle, and inferior in degree, to that which is produced in the excentrical pencils. In the intermediate spaces the corrections are still more imperfect and uncertain; and this explains the cause of the aberrations which must of necessity exist even in the best-made doublet. It is, however, infinitely superior to a single lens, and will transmit a pencil of an angle of from  $35^{\circ}$  to  $50^{\circ}$ .

The next step towards improving the simple microscope was in relation to the eye-piece; this was effected by Mr. Holland. It consists in substituting two lenses for the first in the doublet, and placing a stop between them and the third. The first bending of the pencils of light being effected by two lenses instead of one, produces less aberration, and this is more completely balanced or corrected at the second bending, and in the opposite direction, by the third lens.

A useful form of pocket lens was proposed by Dr. Wollaston, named by him "Periscopic." This combination consists of two hemispherical lenses cemented together by their plane faces, with a stop between them to limit the aperture. A similar proposal, made by Sir David Brewster in 1820, is well known as the Coddington lens,<sup>1</sup> shown at fig. 23: this gives a

(1) The late Mr. Coddington, of Cambridge, who had a high opinion of the value of this lens, had one of these grooved spheres executed by Mr. Carey, who gave it the name of the Coddington Lens, supposing that it was invented by the person who employed him, whereas Mr. Coddington never laid claim to it, and the circumstance of his having one made was not until nine years after it was described by Sir David Brewster in the "Edinburgh Journal."

larger field of view, and is equally good in all directions, as it is evident that the pencils *a b* and *b a* pass through under precisely the same circumstances. Its spherical form has the further advantage of rendering the position in which it is held of comparatively little consequence. It is very generally used as a hand magnifier; but its definition is certainly not so good as that of a well-made doublet or achromatic lens. It is usually set in a folding case, as represented in the figure, and so contrived as to be admirably adapted for the waistcoat-pocket. It is sold with the small holder, fig. 23*a*, for holding and securing small objects



FIG. 23.

FIG. 23*a*.

during examination. Browning's Platyscopic Pocket Lens is a useful form for botanists and mineralogists. Its focus is about three times farther from the object than the Coddington, and allows of opaque objects being easily examined; it has also three degrees of magnifying power of 15, 20, and 30 diameters.

When the magnifying power of a lens is considerable, or when its focal length is short, and its proper distance from the object equally short, it then becomes necessary to be placed at a proper distance with great precision; it cannot therefore be held with sufficient



accuracy and steadiness by the unassisted hand, but must be mounted in a frame, having a rack or screw to move it towards or from another frame or stage which holds the object. It is then called a microscope; and it is furnished, according to circumstances, with lenses and mirrors to collect and reflect the light upon the object, with other conveniences.

The best of the kind, contrived by the late Mr. Ross, is represented in fig. 24; and consists of a circular

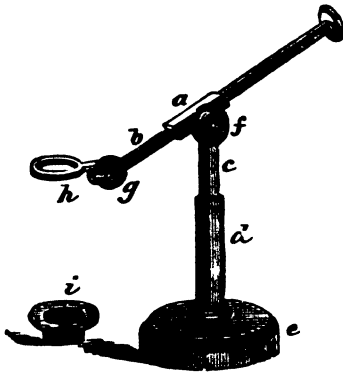

FIG. 24.—Ross's Simple Microscope.

foot *e*, from which rises a short tubular stem *d*, into which slides another short tube *c*, carrying at its top a joint *f*; to this joint is fixed a square tube *a*, through which a rod *b* slides; this rod has at one end another but smaller joint *g*, to which is attached a collar *h*, for receiving the lens *i*. By means of the joint at *f*, the square rod can be moved up or down, so as to bring the lens close to the object; and by the rod sliding through the square tube *a*, the distance between the stand and the lens may be either increased or diminished: the joint *g*, at the end of the rod, is for the purpose of allowing the lens to be brought either horizontally or at an angle to the subject to be investigated. By means of the sliding arm the distance between the table and the jointed arm can be increased or diminished. This microscope is provided with lenses of one-inch and half-inch focal length, and is thereby most useful for the examination and dissection of objects. It is readily unscrewed and taken to pieces, and may be packed in a small case for the pocket.

**THE COMPOUND MICROSCOPE.**—The compound microscope consists of two essential parts, the stand and optical arrangement; the first image being further magnified by one or more lenses forming the eye-piece. The mechanical principles involved in the construction of the compound instrument are few and simple. The more finished form of microscope has assumed a degree of solidity and luxurious elegance heretofore unknown, whilst its accessories have multiplied to an almost unlimited extent. This has resulted from a desire to save time or overcome difficulties, as the practical skill and experience of the microscopist or optician may have suggested, so that whilst the wants of the amateur have been duly considered, the more modest demands of the student have in no way been overlooked or forgotten.

Fortunately for the student, no large and expensive form of instrument is absolutely necessary for the pursuit of microscopical science. A small and simple microscope is as well adapted to his wants—indeed is all that he requires for the work he has to perform. And as for his cabinet of objects, these will grow day by day, and by the labour of his hands. It was with a very unpretending form of microscope that John Quekett worked; that John Ralfs studied the “British Desmidiaceæ;” John Denny the “Anoplura;” William Smith the “British Diatomaceæ;” George Johnson the “British Zoophytes;” and Dr. Bowerbank the “British Spongiidæ.” The microscope has its place in the educational movement of the age, and it is the more incumbent on opticians to manufacture an economic form of instrument, adapted to the wants of a large and increasing class. In the selection of an instrument, it must be borne in mind that a firm stand and a well corrected object-glass are indispensably necessary. It may be of some advantage to those who are about to purchase an instrument if I were to shortly describe its several parts—the stand, body, stage, sub-stage, mirror, eye-piece and objective, *seriatim*. The stand, the bearings upon which the superstructure of the microscope rests, should be solid; and the foot

or claw horseshoe shaped, that it may steadily grasp the table and assist in maintaining the centre of gravity in any position the instrument may be placed. To the foot should be attached two upright pillars, with trunnions, for making the attachments and securing the sliding bar which carries the tubular body and stage.

The tubular body should be about eight or ten inches in length, with a second or inner tube, "the draw-tube," of five or six inches in length, sliding within it. The "draw-tube" assists in the magnification of the image, and is usually engraved with a scale of inches and parts of an inch, for measuring the distance between the eye-piece and the front of the object-glass. The eye-piece surmounts the body, while to the other extremity is attached or screwed the object-glass. The focus is obtained by either a sliding or rack-and-pinion motion, termed the "coarse-adjustment," the fine-adjustment being obtained by a milled-head screw acting upon the long end of a lever, or by other mechanical means. Whatever the kind of motion adopted, neither jumping nor lateral movement of the body should take place, otherwise the object, when placed on the stage, will appear to change its position either to the right or left. A fine-adjustment is very necessary, as without it the highest magnifying powers can hardly be used without risk of damage being done either to the object or the objective.

Fig. 25 represents the body of an ordinary compound microscope with triple object-glass; *o* is an object, above it is seen the triple achromatic object-glass, in connection with the eye-piece *e e*, *f f* the plano-convex lens; *e e* being the eye-glass, and *f f* the field-glass, and between them, at *b b*, a dark spot or diaphragm. The course of the light is shown by three rays drawn from the centre, and three from each end of the object *o*; these rays, if not prevented by the lens *f f*, or the diaphragm at *b b*, would form an image at *a a*; but as they meet with the lens *f f* in their passage, they are converged by it, and meeting at *b b*, where a diaphragm is placed to intercept all extraneous

light, excepting that required for the formation of the image; a further magnification of the image is effected by the eye-lens  $e e$ , and precisely as if it were an original object.

*The Stage.*—The stage of the microscope should be perfectly flat and rigid, without flexure, and as thin as may be consistent with these essential qualities. It should rotate on its axis, as a revolving stage possesses great advantages. It enables the observer to keep a diatom in view, while it is presented in succession to rays of greater or less obliquity, and thus a better insight is obtained into structure. Supposing fig. 26 were an object marked by longitudinal striæ, but too faint to be seen by ordinary direct light, the light most useful for bringing these into view will be that proceeding obliquely in either of the directions  $c$  and  $d$ ; whilst rays of light falling upon it in the directions  $A$  and  $B$  would tend to obscure the striæ rather than disclose them. If the markings, however, are due to furrows or prominences having one side inclined and the other side abrupt, they will not be brought into view indifferently by light from  $c$ , or from  $d$ , but will be seen best by that which produces the strongest shadow; hence, if there be a projecting ridge, with an abrupt side looking towards  $c$ , they will be best seen by light from  $d$ ; if, however, there be a furrow with a steep bank on the side of  $c$ , they will be seen by light from the same side. It not unfrequently happens that longitudinal striæ, or lines,

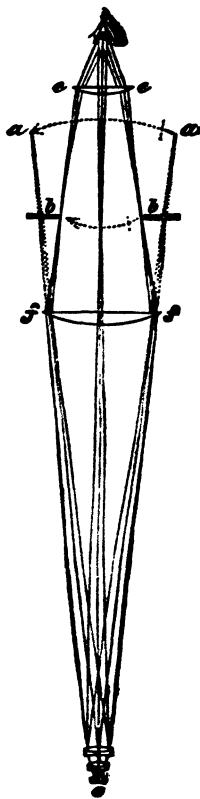

FIG. 25.

are crossed by others, and then these transverse striæ will be better seen by an illuminating pencil less favourable for longitudinal, so that, in order to bring them into distinct view, either the illuminating pencil or the object must be moved or rotated a quarter round.

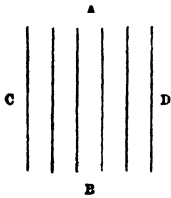

FIG. 26.

*Swinging Sub-stage, or Tailpiece.*—

The swinging sub-stage, although a revival of an invention contrived by Mr. T. Grubb some twenty years ago, has been very generally adopted, since it is thought by manufacturers to be an important and

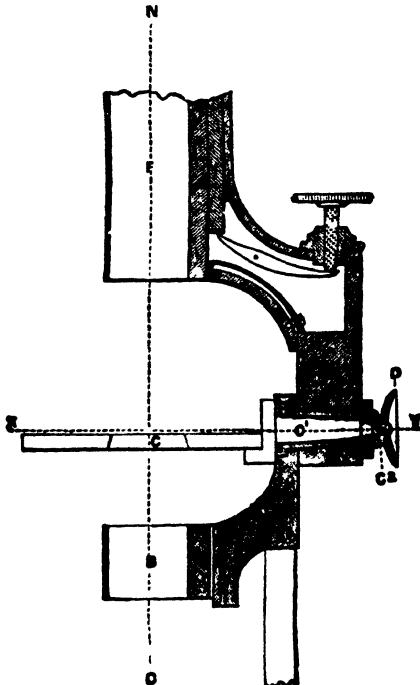

FIG. 27.

useful addition to the more perfected forms of instruments. This tailpiece, represented in sectional elevation fig. 27, consists of *s*, the limb carrying the body, with coarse and fine adjustments; *A*, the stem carrying the sub-stage, *B*, and mirror. *A* is attached to *s* by the sleeve or socket *I*, clamped by the nut *J*, and on *I* *A* may be swung sideways in either direction to the right or left, either below or above the stage, the axis of revolution of which is the line *x y*; that is, a line in the plane of the object to be viewed on the stage *c*, intersected by the optical axis of the instrument; that is, the line *n o*, passing through the centre of the body and the object-glass of the microscope. The stage *c* is also attached to *s* by the pin *c*<sup>1</sup>, terminated by the screen *c*<sup>2</sup>, which pin passes through the centre of the socket *I*, and moves therein so that the stage *c* may readily turn in either direction in conjunction with or independent of *A*, the axis of its revolution being also the line *x y*. By this kind of arrangement the stage *c* and the stem *A* can be set at any angle to the axis of the microscope, either below or above *x y*, intersecting the plane of the object to be viewed, and relatively to each other, and when so set the stage *c* can be clamped at the desired angle by the nut *D* on the screw *c*<sup>2</sup> acting on *s* and the collar *K*.

A mechanical stage is one consisting of two or more plates, the rectangular motions of which are obtained by rack and pinion. It is considered a necessary appendage to the more finished instruments. The cheaper kinds are provided with a simple form of sliding plate, the lower part of which is a raised edge for the objects to rest against. It is often found convenient to have a means of watching growing and other processes, which are either promoted or assisted by maintaining the object for a time at a certain temperature. For this purpose many forms of apparatus have been contrived. A very inexpensive form is that of Mr. Bartley's, fig. 28.

The vessel *E*, three parts filled with water, and supported on a ring-stand, is kept at any temperature by the spirit lamp *c*, a syphon-tube *d* conveys the hot

water along *f* and through the bent tubing which sur-

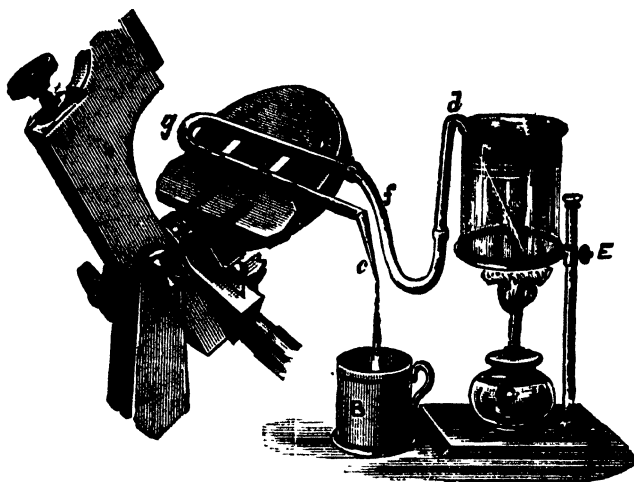

FIG. 28.—Bartley's Warm Stage.

rounds the object on the stage *D*, and passing off through the open end *c* into the receptacle *B*, placed to receive the overflow.

Mr. Stephenson's safety-stage is one of those happy

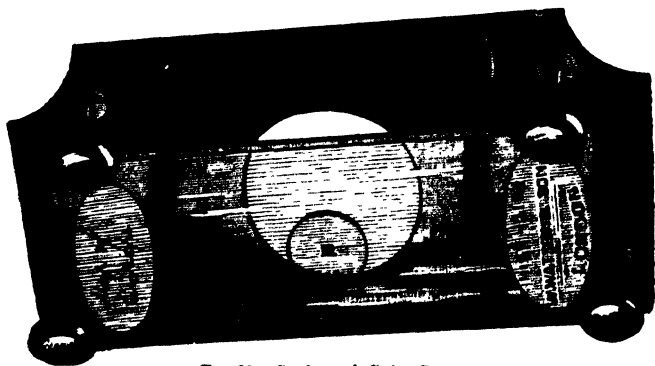

FIG. 29.—Stephenson's Safety-Stage.

contrivances by means of which an accident to either

the object or objective will be prevented. When about to be used it is simply necessary to place it on the fixed stage of the microscope. The object about to be examined is supported and kept in place by a couple of clips or projecting springs. Should a tyro in the use of the instrument hastily rack down the body, all undue force is broken by the elasticity of the springs. Messrs. Watson and Son, of Holborn, manufacture a light and elegant form in ebonite of this accessory safety-stage.

*The Mirror.*—The mode in which an object is illuminated is, in the words of Andrew Ross, “second only in importance to the excellence of the glass through which it is seen.” To ensure good illumination the mirror should be in direct co-ordination with the objective and eye-piece; it must be regarded as a part of the same instrument, and tending by a combined series of acts to a common result. Illumination is spoken of as of three kinds or qualities—reflected, transmitted, and refracted light. For the illumination of transparent objects, transmitted light is brought into use; for opaque objects, reflected. The transmitted illuminating pencil should be as large as can well be received by the lens, and no larger. Any light beyond this is liable to produce confusion of image. In using the mirror the reflected light can be made brighter, more concentrated, by employing a bull’s-eye condensing lens.

*The Eye-piece.*—The eye-piece of the compound microscope consists of two plano-convex lenses; that furthest from the eye, as I have already explained, is the field-glass, and that nearest the eye is the eye-glass. The former increases the field of vision, the latter magnifies, the enlarged inverted image. Combined together, the two materially assist in correcting residual imperfections of the objective. The magnifying power of the microscope depends in a measure, then, upon the eye-piece, but the limit of usefulness in this direction is soon reached, for, although the size of the image is thereby increased, this increase is achieved at the expense of per-



fect definition; and it should be observed that only objectives of the finest construction will bear the deeper eye-pieces. Opticians furnish with most of their instruments two, three, or more oculars: A, B, and C; these, together with a Kellner or orthoscopic eye-piece, D, the field-lens of which is bi-convex, and therefore gives a larger field, are all the microscopist will require. The Huyghenian eye-piece, which is still in use, consists of two plano-convex lenses, with their plane sides turned towards the eye, and at a distance apart equal to half the sum of their focal lengths, and having a stop or diaphragm midway between the lenses. Huyghens was not aware of the value of his eye-piece; it was reserved for Boscovich

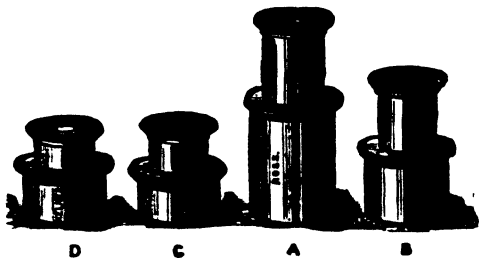

16. 30 — Eye-pieces.

to point out that, by this important arrangement, he had accidentally corrected a portion of the chromatic aberration incidental to the earlier forms. Let fig. 31 represent the Huyghenian eye-piece of a microscope,  $f f$  being the field-glass, and  $e e$  the eye-glass, and  $l m n$  the two extreme rays of each of the three pencils emanating from the centre and ends of the object, of which, but for the field-glass, a series of coloured images would be formed from  $r r$  to  $b b$ ; those near  $r r$  being red, those near  $b b$  blue, and the intermediate ones green, yellow, and so on, corresponding with the colours of the prismatic spectrum. This order of colours is the reverse of that of the common compound microscope, in which the single object-glass projects the red image beyond the blue.

The effect just described, of projecting the blue image beyond the red, is purposely produced for reasons presently to be given, and is called over-correcting the object-glass as to colour. It is to be observed, also, that the images  $b b$  and  $r r$  are curved

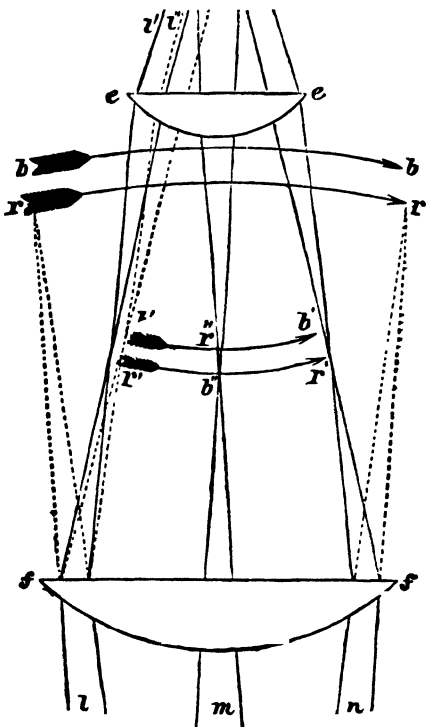

FIG. 31.

in the wrong direction to be distinctly seen by a convex eye-lens, and this is a further defect of the compound microscope of two lenses. But the field-glass, at the same time that it bends the rays and converges them to foci at  $b' b'$  and  $r' r'$ , also reverses the curvature of the images as here shown, giving

them the form best adapted for distinct vision by the eye-glass  $e e$ . The field-glass has at the same time brought the blue and red images closer together, so that they are adapted to pass uncoloured through the eye-glass. To render this important point more intelligible, let it be supposed that the object-glass had not been over-corrected, that it had been perfectly achromatic; the rays would then have become coloured as soon as they had passed the field-glass; the blue rays, to take the central pencil, for example, would converge at  $b''$ , and the red rays at  $r''$ , which is just the reverse of what the eye-lens requires; for as its blue focus is also shorter than its red, it would demand rather that the blue image should be at  $r''$ , and the red at  $b''$ . This effect has already been referred to as due to over-correction of the object-glass, which removes the blue foci  $b b$  as much beyond the red foci  $r r$  as the sum of the distances between the red and the blue foci of the field-lens and eye-lens; so that the separation  $b r$  is exactly taken up in passing through those two lenses, and the several colours coincide, so far as focal distance is concerned, as the rays pass the eye-lens. But while they coincide as to distance, they differ in another respect,—the blue images are rendered smaller than the red by the greater refractive power of the field-glass upon the blue rays. In tracing the pencil  $l$ , for instance, it will be noticed that, after passing the field-glass, two sets of lines are drawn, one whole and one dotted, the former representing the red, and the latter the blue rays. This is the accidental effect in the Huyghenian eye-piece pointed out by Boscovich. The separation into colours of the field-glass is like the over-correction of the object-glass,—and leads to subsequent complete correction. For if the differently coloured rays were kept together till they reached the eye-glass, they would then become coloured, and present coloured images to the eye; but fortunately, and most usefully, the separation effected by the field-glass causes the blue rays to fall so much nearer the centre of the eye-glass, where, owing to the spherical figure, the

refractive power is less than at the margin, so that spherical error of the eye-lens constitutes a nearly perfect balance to the chromatic dispersion of the field-lens, and the blue and red rays  $l'$  and  $l''$  emerge sensibly parallel, presenting, in consequence, the perfect definition of a single point to the eye. The same reasoning is true of the intermediate colours and of the other pencils. The eye-glass thus constructed not only brings together the images  $l' l'$ ,  $l'' l''$ , but it likewise has the most important effect of rendering them flat, and at once correcting both chromatic and spherical aberrations.

The Huyghenian eye-piece described, has served the purpose of illustrating the optical effects of this part of the instrument; but when it is required to measure the magnified image, we use the eye-piece invented by Ramsden, and called by him the micrometer eye-piece. The arrangement will be readily understood upon reference to fig. 32. The field-

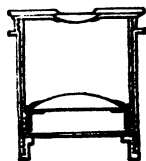

FIG. 32.

glass having its plane face turned towards the object, so that the rays from the object are made to converge immediately in front of the field-glass; and here is placed a plane-glass, on which is engraved divisions of 1-100th of an inch or more. The markings

of these divisions come into focus, therefore, at the same time as the image of the object, both being distinctly seen together. The glass with its divisions is shown in fig. 33, on which, at A, are seen some magnified grains of starch. Thus the measure of the magnified image is given by mere inspection; and the value of such measurements, in

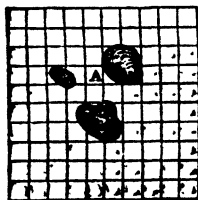

FIG. 33.

reference to the real object, when once obtained, is constant for the same object-glass.<sup>1</sup>

(1) It was affirmed by Ross, that if the achromatic principle were applied

Mr. Lister proposed to place on the stage of the microscope a divided scale, of a certain value; viewing the scale as a microscopic object, he observed how many of the divisions on the scale attached to the eye-piece corresponded with one or more of a magnified image. If, for instance, ten of those in the eye-piece correspond with one of those in the image, and if the divisions are known to be equal, then the image is ten times larger than the object, and the dimensions of the object ten times less than that indicated by the micrometer. If the divisions on the micrometer and on the magnified scale are not equal, it becomes a mere rule-of-three sum; but in general this trouble is taken by the maker of the instrument, who furnishes a table showing the value of each division of the micrometer for every object-glass with which it may be employed.

Mr. Jackson invented the simple and cheap form of micrometer, represented in fig. 34, which he described in the *Microscopical Society's Transactions*, 1840. It consists of a slip of glass placed in the focus of the eye-glass, with the divisions sufficiently fine to have the value of the ten-thousandth of an inch with the quarter-inch object-glass, and the twenty-thousandth with the eighth; at the same time the half, or even the quarter of a division may be estimated, thus affording the means of attaining all the accuracy that is really available. It may therefore entirely supersede the more complicated and expensive screw-micrometer, being much handier to use, and not liable to derangement in inexperienced hands.

The positive eye-piece gives the best view of the micrometer, the negative of the object. The former is quite free from distortion, even to the edges of the field; but the object is slightly coloured. The latter is free from colour, but is slightly distorted at the edges. In the centre of the field, however, to the

to the construction of eye-pieces, the Ramsden is the form by which greater perfection should be obtained. That such an adaptation might be productive of valuable results, appears from Mr. Brooke's statement, that he has employed as an eye-piece, a triplet objective of one-inch focus, the definition obtained by it being superior to that afforded by the ordinary Huyghenian eye-piece. An inch or half-inch achromatic object-glass answers extremely well as an eye-piece.

extent of half its diameter, there is no perceptible distortion; and the clearness of the definition gives a precision to the measurement which is very satisfactory.

Short bold lines are ruled on a piece of glass, *a*, fig. 34; to facilitate counting, the fifth is drawn longer, and the tenth still longer, as in the common rule. Very finely levigated plumbago is rubbed into the lines to render them visible; and they are covered with a piece of thin glass, cemented by Canada balsam, to prevent the plumbago from being wiped out. The slip of glass thus prepared is secured in a thin brass frame, so that

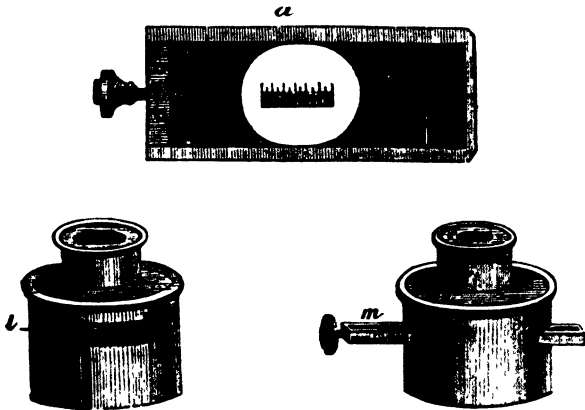

FIG. 34.—*Jackson's Micrometer Eye-piece.*

it may slide freely; it is acted on at one end by a pushing screw, and at the other by a slight spring.

Slips are cut in the negative eye-piece on each side, *b*, so that the brass frame may be pressed across the field in the focus of the eye-glass, as at *m*; the cell of which should have a longer screw than usual, to admit of adjustment for different eyes. The brass frame is retained in its place by a spring within the tube of the eye-piece; and in using it the object is brought to the centre of the field by the stage movements; and the coincidence between one side of it and one of the long lines is made with great accuracy by means of the

small screw acting upon the slip of glass. The divisions are then read off as easily as the inches and tenths on a common rule. The operation, indeed, is nothing more than the laying a rule across the body to be measured; and it matters not whether the object be transparent or opaque, mounted or not mounted, if its edges can be distinctly seen, its diameter can be taken.

Previously, however, to using the micrometer, the value of its divisions should be ascertained with each object-glass; the method of doing this is as follows:—

Lay a slip of ruled glass on the stage; and having turned the eye-piece so that the lines on the two glasses are parallel, read off the number of divisions in the eye-piece which cover one on the stage. Repeat this process with different portions of the stage-micrometer, and if there be any difference, take the mean. Suppose the hundredth of an inch on the stage requires eighteen divisions in the eye-piece to cover it; it is quite plain that an inch would require eighteen hundred, and an object which occupied nine of these divisions would measure the two-hundredth of an inch. Take the instance supposed, and let the microscope be furnished with a draw-tube, marked on the side with inches and tenths. By drawing this out a short distance, the image of the stage micrometer may be expanded until one division is covered by twenty in the eye-piece. These will then have the value of two-thousandths of an inch, and the object which before measured nine will then measure ten: which, divided by 2,000, gives the decimal fraction  $\cdot 005$ .

Enter in a table the length to which the tube is drawn out, and the number of divisions on the eye-piece micrometer equivalent to an inch on the stage; and any measurements afterwards taken with that micrometer and object-glass may, by a short process of mental arithmetic, be reduced to the decimal parts of an inch, if not actually observed in them. In ascertaining the value of the micrometer with a deep object-glass, if the hundredth of an inch on the stage occupies too much of the field, then the two-hundredth or five-hundredth should be used, and

the number of divisions corresponding to that quantity be multiplied by two hundred or five hundred, as the case may be.

The micrometer should not be fitted into too deep an eye-piece, for it is essential to preserve clear definition. A middle power or Kellner eye-piece is the best, provided the object-glass be of the first quality; otherwise, use the eye-piece of lowest power. The lens above the micrometer should not be of shorter focus than three-quarters of an inch, even with the best object-glasses; and the slit cut in the tube can be closed at any time by a small sliding bar, placed at *l*, *m*, fig. 34.

The wonderful tracings on glass executed by the late M. Nobert, of Barth, deserve attention. The plan adopted by him was to trace on glass ten or more separate bands at equal distances from each other, each band being composed of parallel lines of a fractional part of a Prussian inch apart; in some they are 1-1000th, and in others only 1-4000th of a Prussian inch separated. The distance of these parallel lines forms part of a geometric series:—

0·001000 lines.	0·000463 lines.
0·000857 "	0·000397 "
0·000735 "	0·000340 "
0·000630 "	0·000292 "
0·000540 "	0·000225 "

To see these lines at all, it is requisite to use a microscope with a magnifying power of 100 diameters; the bands containing the fewest number of lines will then be visible. To distinguish the finer lines, it will be necessary to use a magnifying power of 300, and then the lines which are only 1-4700th of an inch (Prussian) apart will be seen perfectly traced. Of all the tests yet found for object-glasses of high power, these would seem the most valuable. Nobert's tracings have tended to confirm the undulating theory of light, the different colours of the spectrum being exhibited in the ruled spaces varying with the separation of the lines; in those cases where the distances between the lines are smaller than the length of the violet-coloured waves, no colour is perceived; while, on the other hand, if



inequalities amounting to  $\cdot 000002$  line occur, stripes of another colour appear in them.

Schmidt's goniometer positive eye-piece, for measuring the angles of crystals, is so arranged as to be easily rotated within a large and accurately graduated circle. In the focus of the eye-piece a single cobweb is drawn across, and to the upper part is attached a vernier. The crystals being placed in the field of the microscope, care being taken that they lie *perfectly flat*, the vernier is brought to zero, and then the whole apparatus turned until the line is parallel with one face of the crystal; the frame-work bearing the cobweb, with the vernier, is now rotated until the cobweb becomes parallel with the next face of the crystal, and the number of degrees which it has traversed may then be accurately read off.

Erector eye-pieces and erecting prisms are employed for the purpose of making the image presented to the eye correspond with the position of the object. They are most useful for minute dissections, but the loss of light occasioned by sending it through two additional surfaces is a drawback—impairs the sharpness of the image. Nacet designed an extremely ingenious arrangement whereby the inverted image became erect; he adapted a simple rectangular prism to the eye-piece. The obliquity which a prism gives to the visual rays, when the microscope is used in the erect position, as for dissecting, is an advantage, as it brings the image to the eye at an angle very nearly corresponding to the inclined position in which the microscope is ordinarily used.

*The Value of Eye-pieces.*—The magnifying power of Ross's lowest eye-piece A is about 5; that of B, 8 to 10; C, 15; D, 20; and E, 25.

For viewing thin sections of recent or fossil woods, coal, the fructification of ferns and mosses, fossil-shells, seeds, small insects, or parts of larger ones; molluscs, the circulation in the frog, etc., the A eye-piece is best adapted.

For the examination of details of minuter objects, the B eye-piece is preferred; the pollen of flowers,

dissected insects, the vascular and cellular tissues of plants, the Haversian canals, the lacunæ of bone, and the serrated laminæ of the crystalline lens of the eyes of birds and fishes require the B eye-piece.

The c eye-piece is brought into use when it is necessary to investigate the structure of very delicate tissues; and in observations upon minute diatoms and desmids, scales of moths, gnats, raphides, etc. The employment of a deep eye-piece sometimes obviates the necessity of using a deeper object-glass, and which always occasions a re-arrangement of the illumination generally. It must be borne in mind, that the more powerful the eye-piece, the more palpable will the imperfections of the object-glass become; hence less confidence should be placed in observations made with a powerful eye-piece than when amplification is obtained with a shallow one and a deeper object-glass.<sup>1</sup>

*The Draw-tube* is an intermediate tube, which when

(1) AMPLIFICATION OF OBJECTIVES AND EYE-PIECES.

OBJECTIVES.		EYE-PIECES AND OBJECTIVES COMBINED.							
Focal Length.	Magnifying Power	With Beck's 1. Powell's 1. Ross's A	With Beck's 2. Powell's 2. Ross's B	With Powell's 3	With Ross's C	With Beck's 3.	With Powell's 4. Ross's D.	With Beck's 5. Ross's E.	
100									
5	2	10	15	20	25	30	40	50	
4	2½	12½	18½	25	31½	37½	50	62½	
3	3½	16½	25	33½	41½	50	66½	83½	
2	5	25	37½	50	62½	75	100	125	
1½	6½	33½	50	66½	83½	100	133½	166½	
1	10	50	75	100	125	150	200	250	
¾	12½	62½	93½	125	156½	187½	250	312½	
½	15	75	112½	150	187½	225	300	375	
¼	20	100	150	200	250	300	400	500	
1/10	25	125	187½	250	312½	375	500	625	
1/15	30	150	225	300	375	450	600	750	
1/20	33½	166½	250	333½	416½	500	666½	833½	
1/25	40	200	300	400	500	600	800	1000	
1/30	50	250	375	500	625	750	1000	1250	
1/40	60	300	450	600	750	900	1200	1500	
1/50	70	350	525	700	875	1050	1400	1750	
1/60	80	400	600	800	1000	1200	1600	2000	
1/70	90	450	675	900	1125	1350	1800	2250	
1/80	100	500	750	1000	1250	1500	2000	2500	

Reduced from a comprehensive table of the magnifying power of eye-pieces, and the amplification of objectives and eye-pieces combined, issued in a separate form with the *Journal of the Royal Microscopical Society*.

drawn out increases the magnification of the image, without having to change the eye-piece. When using the micrometer eye-piece, we are enabled by the aid of the draw-tube to fill the whole field of view and make a precise comparison between the divisions of the eye-piece and the stage micrometer. In Messrs. Beck's microscopes, the draw-tube is furnished with a rack-and-pinion movement for the purpose of facilitating adjustment.

*The Object-glass.*—The microscope depends so much for its effectiveness and general utility upon the perfection of the object-glass or objective, that it is absolutely necessary for any one about to use the instrument to make himself perfectly familiar with its relative qualities. It will scarcely be possible to form any just estimate of the value of this or that maker's objective by a comparison of magnification; indeed the proportional amplification of the object-glasses of the most conscientious opticians will on comparison be found to differ materially.

To arrive at a literally correct judgment of the value of an objective to the microscopist, there are special qualifications by which it should be judged. These, for the sake of convenience, may be divided into:—Its defining power; its penetrating power, or focal depth; its resolving power; its working distance and its flatness of field: all of which are qualifications of the greatest importance, especially when an objective is about to be employed in scientific research.

*The Defining Power* of the objective depends upon the perfection with which the corrections of its chromatic and spherical aberrations are made. When these are nicely balanced, the image will be sharp, and the minutest details of an object seen with greater clearness. Whatever other qualities may be absent in the object-glass, fine definition must be secured. This quality may be tested by taking a known test-object, as it is termed, a blood corpuscle, a diatom mounted in balsam, or a Podura-scale, and comparing the sharpness and perfection of the image produced by one objective, against that of another.

*Penetrating Power*, or focal depth, is a quality

which affords the observer a deeper insight into structure. The objective having the longest working distance, as a rule, possesses the greatest amount of penetration. Theoretically, according to Professor Abbe, the penetration of an objective decreases as the square of the angular aperture increases. The botanist or physiologist, studying the minute anatomy of plant or animal, would gain a very imperfect idea of the structural elements entering into either, unless the objective possessed good penetration. It is, however, somewhat unusual to find good penetrating or separating power combined with equally good definition in any objective. The latter quality is compatible only with the highest attainable aperture.

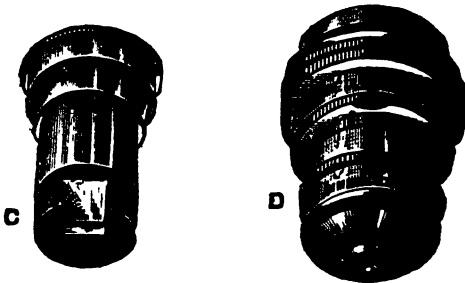

FIG. 35.—Wenham's Binocular Objective.

Penetration is an indispensable quality for the binocular microscope, consequently opticians have been induced to furnish special forms of object-glasses for use with this form of instrument. Mr. Wenham carried a kind of speciality into the construction of high-power objectives for the binocular, by mounting a prism in a separate tube, and slipping it down the objective, and letting it almost touch the back lens. Fig. 35 represents a  $\frac{1}{8}$ th objective of the kind, full size, with correcting adjustment. *D* being the objective complete, and *C* the tube with prism fixed in its place. The objective, it will be seen, is shorter than an ordinary  $\frac{1}{8}$ th, and can be made to answer a double purpose. It becomes more effective as a homogeneous-immersion

objective, and if intended to be so used, the correcting adjustment will be unnecessary, since the body part can be made shorter, and the back lens brought into close contact with the binocular prism.

Messrs. Swift have also constructed a series of object-glasses for a similar purpose. The taper front objectives (fig. 36) are for use with their erecting Stephenson's binocular instrument, and for the better illumination of opaque objects. From their peculiar construction, the illuminating rays from the bull's-eye condenser are made to impinge somewhat more vertically upon the object, thus avoiding deep shadows, which often give rise to false appearances when the light is thrown too obliquely on the object.

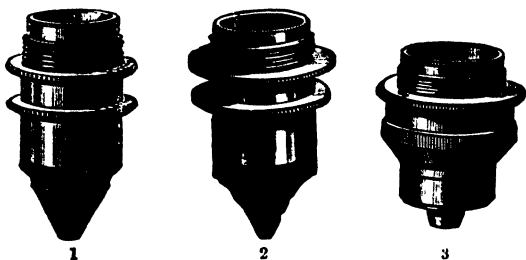

FIG. 36.—Swift's Taper Object-glasses.

With regard to the binocular microscope, it should be understood, writes Professor Abbe, that fairly satisfactory stereoscopic observation cannot be extended beyond moderate amplification, not even when the binocular arrangement allows of the use of high powers. In fact, as soon as the use of higher powers is resorted to, stereoscopic vision is limited to objects of so little depth that a merely plastic view of them can hardly be productive of any scientific advantage, although effective images may still be obtained.

*Resolving Power* is the power or capacity of the objective to resolve the finest lines, striæ or dots; that is, separate and define them distinctly. Resolution increases with width of aperture, and may therefore be regarded as another expression for definition. The

maximum attainable resolving power of an objective of  $180^\circ$  aperture, according to Professor Abbe, is the separation or resolution of fine lines ruled 118000th of an inch apart. Resolution depends more or less upon the quality and quantity of the light admitted, the power of collecting the greatest number of rays, and the perfection of centring. In other words, upon the co-ordination of the illuminating system of the microscope—mirror, achromatic condenser, objective and eye-piece. If diatoms are employed as test-objects, it should be borne in mind that there are great differences even in the same species, and in the distances their lines are apart. For this reason ruled lines of known value, as Nobert's lines, are much to be preferred. The following example may be taken as a test of the value of a dry  $\frac{1}{8}$ th objective of  $120^\circ$  in defining the rulings of a 19-band plate, which is equivalent to the 1-67000th of an inch. This objective, with careful illumination, showed them all; but when cut down by a diaphragm to  $110^\circ$ , the eighteenth line was not separable; further cut down to  $100^\circ$  the seventeenth was the limit, to  $80^\circ$  the fourteenth, and to  $60^\circ$  the tenth barely reached.

*Flatness of Field* is a quality of some importance, and must be included in the general practical value of the objective, denoting its capacity to exhibit the peripheral portions of the field with the same degree of sharpness as the central. Flatness of field is much enhanced by the width of the opening or angular aperture. In all high-angled objectives the image should be sharp and quite free from colour to the very marginal portions of the field. In experimenting on the comparative merits of two object-glasses as to flatness of field, an eye-piece of large aperture should be used. For testing flatness of field, Cole's exquisitely prepared double-stained sections of woods will be found in every way suitable objects. The proboscis of the fly is also recommended, and if its details have not been destroyed by being mounted in balsam, it is a good test. Glycerine is the proper medium for displaying its several structures. The cover-glass of the object, it must be remembered, as Amici pointed out, is not an unimpor-

tant factor in the production of the image. An object viewed without a cover-glass is more clearly defined than one with. The late Andrew Ross explained the cause of this difference in a paper published in the "Transactions of the Society of Arts," vol. 41.

Perfect definition is the quality most sought after by those engaged in histological pursuits; whilst perfect resolution is more highly esteemed by those who take especial interest in the finest diatoms and test objects of a similar nature. Various modifications have taken place in the construction of the object-glass of the

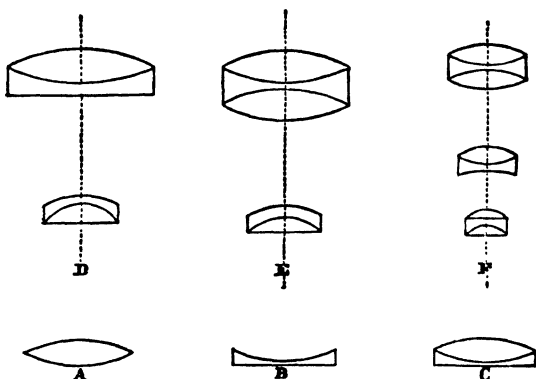

FIG. 37.—Forms of Object-glasses.

A, Double-convex lens; B, Plano-concave; C, Bi-convex and plano-concave united; shown in their various combinations, as at D, form the 3-in., 2-in. or 1½-in. ; at E, 1-in. and ¾-in. ; and at F, the ½-in., ⅓-in., ¼-in. and ⅓-in. objectives.

microscope: opticians, however, are quite agreed that the highest theoretical perfection will be obtained by an increase rather than a decrease in the number of lenses entering into its combination. Both at home and abroad first-class makers, such as Ross, Powell and Lealand, Beck, Dallmeyer, Tolles, Wales, Zeiss, &c., have been working on this principle. To a well-considered combination formula they have added a single front plano-convex lens of crown-glass, which gives increase of power with a longer working distance to the objective.

The accompanying diagram is intended to show the several lenses that enter into the construction of the ordinary achromatic object-glass. A double convex lens and plano-convex lens of crown-glass, and a plano and double concave lens and a miniscus lens of flint-glass, are ingeniously cemented with Canada balsam into a solid mass. Each objective, from the  $\frac{1}{4}$ -inch to the  $\frac{1}{12}$ -inch and upwards, is thus made up of at least eight original lenses, the back combination of each being a triplet formed of two double convex lenses of crown-glass, with an intermediate double concave lens of flint-glass.

I cannot bring these brief observations on the object-glass to a close without referring more directly to the great improvement effected in balancing its aberrations by the late Mr. Lister. This gentleman devised the very important screw-collar adjustment, by means of which the front lens of the objective is brought nearer to the back lens; this at once compensates for the disturbance produced by rays of light being made to pass through different thicknesses of glass covers.

When an objective has its aberrations balanced for viewing an opaque object, and it is required to examine that object by transmitted light, the correction will remain; but if it is necessary to immerse the object in a fluid, or to cover it with glass, an aberration arises from either circumstance which will disturb the previous correction, and deteriorate the definition; and this defect will be more obvious from the increase of distance between the object and objective.

How this very important correction is effected may be further explained. If an object-glass be constructed as represented in fig. 38, where the posterior combination  $p$  and the middle  $m$  have together an excess of negative aberration, and if this be corrected by the anterior combination  $a$  having an excess of positive aberration, then this latter combination can be made to act more or less powerfully upon  $p$  and  $m$ , by making it approach to or recede from them; for when the three act in close contact, the distance of the object from the object-glass is greatest, and conse-



quently the rays from the object are diverging from a point at a greater distance than when the combinations are separated; and as a lens bends the rays more, or acts with greater effect, the more distant the object is from which the rays diverge, the effect of the anterior combination  $a$  upon the other two,  $p$  and  $m$ , will vary with its distance from thence.

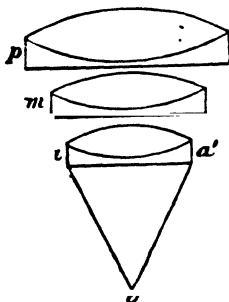

FIG. 38.

When, therefore, the correction of the whole is effected for an opaque object, with a certain distance between the anterior and middle combination, if they are then put in contact, the distance between the object and object-glass will be increased; consequently, the anterior combination will act more powerfully, and the whole will have an excess of positive aberration. Now the effect of the aberration produced by a piece of flat

and parallel glass being of a negative character, it is obvious that the above considerations suggest the means of correction, by moving the lenses nearer together, and the positive aberration is made to balance the negative aberration caused by the medium.

The preceding refers only to the spherical aberration; but the effect of the chromatic is also seen when an object is covered with a piece of glass: it produces chromatic thickening of the outline of Podura and other delicate scales; and if diverging rays near the axis and at the margin are projected through a piece of flat parallel glass, with the various indices of refraction for the different colours, it will be seen that each ray will emerge, separated, into a beam consisting of the component colours of the ray, and that each beam is widely different in form. This difference, being magnified by the objective of the microscope, readily accounts for the chromatic thickening of the outline just mentioned. Therefore, to obtain the finest definition of extremely delicate and minute objects,

they should be viewed without a covering; if it be desirable to immerse them in a fluid, they should be covered with the thinnest possible film of talc, as, from the character of the chromatic aberration, it will be seen that varying the distances of the combinations will not sensibly affect the correction; though object-lenses may be made to include a given fluid, or solid medium, in their correction for colour.

The mechanism for applying these principles to the correction of an object-glass under the various circumstances, is represented in fig. 39, where the anterior lens is set in the end of a tube *a*, which slides on the cylinder *b*, containing the remainder of the combination; the tube *a*, holding the lens nearest the object, may then be moved upon the cylinder *b*, for the purpose of varying the distance, according to the thickness of the glass covering the object, by turning the screwed ring *c*, or more simply by sliding the one on the other, and clamping them together when adjusted. An aperture is made in the tube *a*, within

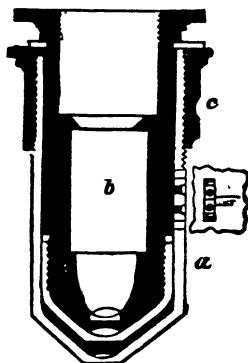

FIG 39.

which is seen a mark engraved on the cylinder; and on the edge of which are two marks, a longer and a shorter, engraved upon the tube. When the mark on the cylinder coincides with the longer mark on the tube, the adjustment is perfect for an uncovered object; and when the coincidence is with the short mark, the proper distance is obtained to balance the aberrations produced by glass the hundredth of an inch thick, and such glass can be readily supplied. This adjustment should be tested experimentally by moving the milled edge, so as to separate or close together the combinations, and then bringing the object to distinct vision by the screw adjustment of the microscope. In this process the milled edge of

the object-glass will be employed to adjust for character of definition, and the fine screw movement of the microscope for correct focus.

The graduations on the correction-collar are merely for convenience of registering the point of "best correction" for particular objects, so that the objective may be set at the same correction if the observation has to be repeated. It is usual with amateurs, who have not practised themselves thoroughly in rapidly adjusting their objectives by inspection of the image, to note on their slides the best point of adjustment as well as the position of the object, either with reference to stage graduations or to Maltwood's finder. The registration of the position may save time in repeating an observation; but the registration of the best point of adjustment should, generally speaking, be regarded as an approximative process only, for the adjusting collar is seldom made so accurately that absolute reliance can be placed on the index. To obtain fine definition test the correction in both directions, and take care to follow the image with the fine adjustment. With objectives of large aperture this process is of much importance, as the exact "distancing" makes or mars the definition.

Mr. Wenham recommends the following method of securing the most efficient performance of an object-glass. Select any dark speck or opaque portion of the object, and bring the outline into perfect focus; then lay the finger on the milled head of the fine adjustment, and move it briskly backwards and forwards in both directions from the first position. Observe the expansion of the dark outline of the object, both when within and when without the focus. If the greater expansion, or coma, be when the object is *without* the focus, or farther from the objective, the lenses must be placed farther asunder, or towards the mark "uncovered." If the greater coma be when the object is *within* the focus, or nearer to the objective, the lenses must be brought closer together, or towards the mark "covered." When the object-glass is in proper adjustment, the expansion of the outline is exactly the

same both within and without the focus. A different indication, however, is afforded by such test-objects as present (like the Podura-scale, the Diatoms, &c.) a set of distinct dots or other markings. If the dots have a tendency to run into lines when the object is *without* the focus, the glasses should be brought closer together; on the contrary, if the lines appear when the object is *within* the focal point, the glasses must be farther separated.

The Podura-scale is an excellent test-object. The structure consists of a delicate transparent lamina or membrane, covered with an imbricated arrangement of epithelial plates, the length of which is six or eight times their breadth, and arranged like the tiles on a roof, or the long pile of some kinds of plush. The scales may be readily obtained by putting a live Podura into a small test-tube, and inverting it on a glass-slide; the insect should then be allowed for a time to leap and run about in the confined space. By this means the scales will be freely deposited on the glass; and being subsequently trodden on by the insect, several will be found from which the epithelial plates have been partially rubbed off, and at the margin of the undisturbed portion the form and position of the plates may be readily recognized. Their structure appears to be rendered more palpable by mounting the scales thus obtained in Canada balsam, and illuminating them by means of Wenham's parabolic reflector. The structure may also be very clearly recognized when the scale is seen as an opaque object under a Ross's  $\frac{1}{2}$  (specially adjusted for uncovered objects), illuminated by a combination of the parabola and a flat Lieberkuhn. The under-side of the scale appears as a smooth glistening surface, with very slight markings, corresponding, probably, to the points of insertion of the plates on the contrary side. The minuteness and close proximity of the epithelial plates may account for their being found a good test of *definition*, while their prominence renders them independent of the *separating* power due to larger aperture.

The structure of another class of test-objects, the

diatomaceæ, differs entirely from that above described; it will suffice for my present purpose to notice the valves of three species only of the genus *Pleurosigma*; these, arranged in the order of easy visibility, are, *P. formosum*, *P. hippocampus*, *P. angulatum*. All appear to consist of laminæ of homogeneous transparent silex, studded with dots, or rather protuberances, which in *P. formosum* and *P. angulatum* have a triangular arrangement, and in *hippocampus* a quadrangular. The "dots" have been described as depressions; but if the frustule be broken the fracture is invariably observed to take place *between* the rows of dots, and not *through* them, as would naturally occur if the dots were depressions, for the substance is thinner there than elsewhere.

This, in fact, is always observed to take place in the siliceous loriceæ of some of the border tribes that occupy a sort of neutral, and yet not undisputed, ground between the confines of the animal and vegetable kingdoms; as, for example, the *Isthmia*, which possess a reticulated structure, with depressions between the meshes, somewhat analogous to that which would result from pasting together bobbin-net and tissue-paper. The valves of *P. angulatum*, and similar objects, have been by some investigators supposed to be made up of two substances possessing different degrees of refractive power; but this hypothesis is purely speculative, since the observed phenomena will naturally result from a series of rounded or lenticular protuberances of one homogeneous substance. Moreover, if the centres of the markings were centres of greatest density, if, in fact, the structure were at all analogous to that of the crystalline lens of the eye, it is difficult to conceive why oblique rays only should be visibly affected. When *P. hippocampus* or *P. formosum* is illuminated by a proper condenser, with a central stop placed under the lenses, and viewed by a quarter-inch object-glass of 70° aperture, both being accurately adjusted, we may observe in succession, as the object-glass approaches the object, first a series of well-defined bright dots; secondly, a series of dark dots replacing these; and thirdly, the

latter again replaced by bright dots, not, however, so well defined as the first series. A similar succession of bright and dark points may be observed in the centre of the markings of some species of *Coscinodiscus* from Bermuda when viewed by transmitted light.

These appearances would result if a thin plate of glass were studded with minute, equal, and equidistant plano-convex lenses, the foci of which would necessarily lie in the same plane. If the focal surface, or plane of vision, of the object-glass be made to coincide with this plane, a series of bright points would result from the accumulation of the light falling on each lens. If the plane of vision be next made to coincide with the surfaces of the lenses, these points would appear dark, in consequence of the rays being refracted towards points now out of focus. Lastly, if the plane of vision be made to coincide with the plane beneath the lenses that contain their several foci, so that each lens may be, as it were, combined with the object-glass, then a second series of bright points will result from the accumulation of the rays transmitted at those points. Moreover, as all rays capable of entering the object-glass are concerned in the formation of the second series of bright focal points, whereas the first series being formed by the rays of a conical shell of light only, it is evident that the circle of least confusion must be much less, and therefore the bright points better defined in the first than in the last series.

*The Aperture of the Object-glass.*—The aperture of an objective has been, down to a comparatively recent period, the occasion of much controversy. It was contended that the aperture of a dry objective of  $180^\circ$  angle represented the largest aperture possible, that this could not be exceeded by any immersion objectives, the advantages of the latter resting solely upon the increase in light, through the absence of reflection at the surface of the front lens, and their greater working distance.

The confusion into which the aperture question was brought by this contention, arose almost entirely from the fact that its supporters had not appreciated the

proper definition of the term "aperture," but had assumed it to be synonymous with what was known as "angular aperture." The angles of the pencils admitted by objectives cannot however serve as a measure of their apertures. When the medium in which they work is the *same*, as air, it is not the angles but the sines of those angles which enable the proper comparison to be made, thus: if two dry objectives admit pencils of  $60^\circ$  and  $180^\circ$ , their real apertures are not as 1 : 3, but as 1 : 2 only. When the media are *different*, as air, water and oil, the angles are still more misleading, as there may be three angles all with the same number of degrees, and yet representing entirely different apertures.

Whilst, however, those who insisted upon the increase of the apertures of objectives with the increase in the refractive index of the immersion fluid, were right in their contention, a somewhat similar lack of proper definition of the term aperture prevented the question being at that time effectually disposed of. The whole matter was, however, recently exhaustively dealt with in the course of a renewal of the "aperture question," before the Royal Microscopical Society, and in the papers of Professor Abbe (of Jena), and Mr. Crisp (Sec. R. Micr. Soc.), printed in the journal of that society,<sup>1</sup> the subject of aperture will be found to be at last placed on a scientific basis. To follow the question in all its details, reference must be made to these papers, but a brief *résumé* of the leading points will be found instructive and useful.

The first essential step in the consideration of aperture is, as I have said, to understand clearly what is meant by the term. It will be at once recognized that its definition must necessarily refer to its primary meaning of "opening," and must, in the case of an optical instrument, define its capacity for receiving rays from the object, and transmitting them to the image.

In the case of the telescope-objective, its capacity for receiving and transmitting rays is necessarily mea-

(1) *Journ. R. Micr. Soc.*, I. (1881), pp. 202-60 and pp. 388-423.

sured by the expression of its absolute diameter or "opening." No such absolute measure can be applied in the case of microscope-objectives, the largest lenses having by no means the largest apertures, but being, in fact, found with the low powers, whose apertures are but small. The capacity of a microscope-objective for receiving and transmitting rays is, however, as will be seen, estimated by its *relative* opening, that is, its opening in relation to its focal length. When this relative opening has been ascertained, it may be regarded as synonymous with that denoted in the telescope by *absolute* opening. That this is so will be better appreciated by the following consideration:—

In a single lens, the rays admitted within one meridional plane evidently increase as the diameter of the lens (all other circumstances remaining the same), for in the microscope we have, at the back of the lens, the same circumstances as are in front in the case of the telescope. The larger or smaller number of emergent rays will therefore be measured by the clear diameter, and as no rays can emerge that have not first been admitted, this must also give the measure of the admitted rays.

If the lenses compared have different focal lengths but the same clear "openings," they will transmit the same number of rays to equal areas of an image at a definite distance, because they would admit the same number if an object were substituted for the image; that is, if the lens were used as a telescope-objective. But as the focal lengths are different, the amplification of the images is different also, and equal areas of these images correspond to different areas of the object from which the rays are collected. Therefore, the higher power lens with the same opening as the lower power, will admit a *greater* number of rays in all from the same object, because it admits the *same* number as the latter from a *smaller* portion of the object. Thus, if the focal lengths of two lenses are as 2 : 1, and the first amplifies  $n$  diameters, the second will amplify  $2n$  with the same distance of the image, so that the rays which are collected to a given field of 1 mm. diameter of the



image are admitted *from* a field of  $\frac{1}{N}$  mm. in the first case, and of  $\frac{1}{2N}$  mm. in the second. As the "opening" of the objective is estimated by the diameter (and not by the area) the higher power lens admits *twice* as many rays as the lower power, because it admits the same number from a field of half the diameter, and, in general, the admission of rays by the same opening, but different powers, must be in the inverse ratio of the focal lengths.

In the case of the single lens, therefore, its aperture is determined by the ratio between the clear opening and the focal length. The same considerations apply to the case of a compound objective, substituting, however, for the clear opening of the single lens the diameter of the pencil at its emergence from the objective, that is, the clear utilized diameter of the back lens.

All equally holds good whether the medium in which the objective is placed is the same in the case of the two objectives or different, as an alteration of the medium makes no difference in the power.

Thus we arrive at a general proposition for all kinds of objectives: 1st, when the power is the same, the admission of rays (or aperture) varies with the diameter of the pencil at its emergence; 2nd, when the powers are different, the same aperture requires different openings in the ratio of the focal lengths, or conversely with the same opening the aperture is in inverse ratio to the focal lengths. We see, therefore, that just as in the telescope the absolute diameter of the object-glass defines its aperture, so in the microscope *the ratio between the utilized diameter of the back lens and the focal length* of the objective defines its aperture also, and this is clearly a definition of aperture in its primary and only legitimate meaning as "opening;" that is, the capacity of the objective for admitting rays from the object and transmitting them to the image.

If, by way of illustration, we compare a series of dry and oil-immersion objectives, and commencing with small air angles, progress up to  $180^\circ$  air angle, and then take an oil-immersion of  $82^\circ$  and progress

again to  $180^\circ$  oil angle, the ratio of opening to power progresses also, and attains its maximum, not in the case of the air angle of  $180^\circ$  (when it is exactly equivalent to the oil angle of only  $82^\circ$ ), but is greatest at the oil angle of  $180^\circ$ . If we assume the objectives to have the same power throughout we get rid of one of the factors of the ratio, and we have only to compare the diameters of the emergent beams, and can represent their relations by diagrams.

Fig. 40 illustrates five cases of different apertures of  $\frac{1}{4}$ -in. objectives, viz.: those of dry objectives of  $60^\circ$ ,  $97^\circ$ , and  $180^\circ$  air angle, a water-immersion of  $180^\circ$  water angle, and an oil-immersion of  $180^\circ$  oil angle. The inner dotted circles in the two latter cases are of the same size as that corresponding to the  $180^\circ$  air angle.

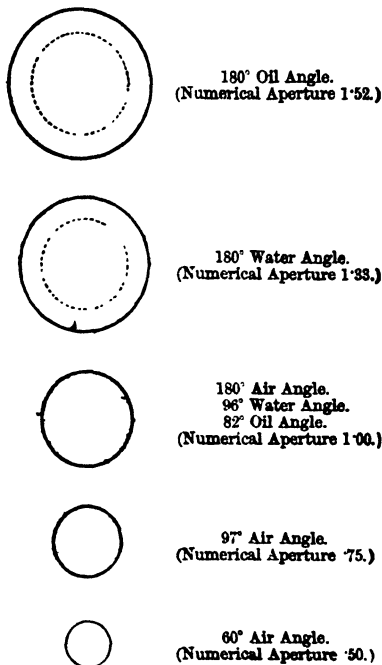

FIG. 40.

Relative diameters of the (utilized) back lenses of various dry and immersion objectives of the same power ( $\frac{1}{4}$ -in.) from an air angle of  $60^\circ$  to an oil angle of  $180^\circ$ .

A dry objective of the maximum air angle of  $180^\circ$  is only able to utilize a diameter of back lens equal to twice the focal length, while an immersion lens of even only  $100^\circ$  utilizes a larger diameter, i.e., it is able to

transmit more rays from the object to the image than any dry objective is capable of transmitting. Whenever the angle of an immersion lens exceeds twice the critical angle for the immersion fluid, *i.e.*,  $96^\circ$  for water or  $82^\circ$  for oil, its aperture is in excess of that of a dry objective of  $180^\circ$ .

This excess will be *seen* if we take an oil-immersion objective of, say  $122^\circ$  balsam-angle, illuminating it so that the whole field is filled with the incident rays, and use it first on an object not mounted in balsam, but dry. We then have a *dry objective* of nearly  $180^\circ$  angular aperture, for, as will be seen by reference to fig. 41, the cover-glass is virtually the first surface of the objective, as the front lens, the immersion fluid, and the cover-glass are all approximately of the same index, and

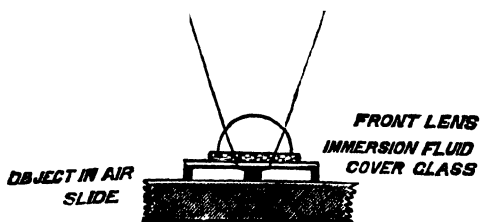

FIG. 41.

form, therefore, a front lens of extra thickness. When the object is close to the cover-glass the pencil radiating from it will be very nearly  $180^\circ$ , and the emergent pencil (observed by removing the eye-piece) will be seen to utilize as much of the back lens of the objective as is equal to twice the focal length, that is the *inner* of the two circles at the head of fig. 40.

If now balsam is run in beneath the cover-glass so that the angle of the pencil taken up by the objective is no longer  $180^\circ$ , but  $122^\circ$  only (that is, *smaller*), the diameter of the emergent pencil is *larger* than it was before, when the angle of the pencil was  $180^\circ$  in air, and will be approximately represented by the *outer* circle of fig. 40. As the power remains the same in both cases, the larger diameter denotes the greater

aperture of the immersion objective over a dry objective of even  $180^\circ$  angle, and the excess of aperture is made plainly visible.

Having settled the principle, it is still necessary, however, to find a proper *notation* for comparing apertures. The astronomer can compare the apertures of his various objectives by simply expressing them in inches, but this is obviously not available to the microscopist, who has to deal with the ratio of two varying quantities.

In consequence of a discovery made by Professor Abbe in 1873, that a general relation existed between the pencil admitted into the front of the objective, and that emerging from the back of the objective, he was able to show that the ratio of the semi-diameter of the emergent pencil to the focal length of the objective could be expressed by the formula  $n \sin u$ , i.e., by the sine of half the angle of aperture ( $u$ ) multiplied by the refractive index of the medium ( $n$ ) in front of the objective ( $n$  being 1.0 for air, 1.33 for water, and 1.52 for oil or balsam).

When, then, the values in any given cases of the expression  $n \sin u$  (which is known as the "numerical aperture") has been ascertained, the objectives are instantly compared as regards their aperture, and, moreover, as  $180^\circ$  in air is equal to 1.0 (since  $n=1.0$  and the sine of half  $180^\circ=1.0$ ) we see, with equal readiness, whether the aperture is smaller or larger than that corresponding to  $180^\circ$  in air. Thus, suppose we desire to compare the apertures of three objectives, one a dry objective, the second a water immersion, and the third an oil immersion; these would be compared on the angular aperture view as, say  $74^\circ$  air angle,  $85^\circ$  water angle, and  $118^\circ$  oil angle, so that a calculation must be worked out to arrive at the actual relation between them. Applying, however, the "numerical" notation, which gives .60 for the dry objective, .90 for the water immersion, and 1.30 for the oil immersion, their relative apertures are immediately recognized, and it is seen, for instance, that the aperture of the water immersion is some-

what less than that of a dry objective of  $180^\circ$ , and that the aperture of the oil immersion exceeds that of the latter by 30%

The advantage of immersion, in comparison with dry objectives, is also at once apparent. Instead of consisting merely in a diminution of the loss of light by reflection or increased working distance, it is seen that a wide-angled immersion objective has a larger aperture than a dry objective of maximum angle, so that for any of the purposes for which aperture is essential an immersion must necessarily be preferred to a dry objective.

That pencils of identical angular extension but in different media are different physically, will cease to appear in any way paradoxical if we recall the simple optical fact that rays, which in air are spread out over the whole hemisphere, are in a medium of higher refractive index such as oil *compressed* into a cone of  $82^\circ$  round the perpendicular, *i.e.*, twice the critical angle. A cone exceeding twice the critical angle of the medium will therefore embrace a *surplus* of rays which do not exist even in the hemisphere when the object is in air.

The whole aperture question, notwithstanding the innumerable perplexities with which it has hitherto been surrounded, is in reality completely solved by these two simple considerations: First, that "aperture" is to be applied in its ordinary meaning as representing the greater or less capacity of the objective for receiving and transmitting rays; and second, that when so applied the aperture of an objective is determined by the ratio between its opening and its focal length; the objective that utilizes the larger back lens (or opening) relatively to its focal length having necessarily the larger aperture. It would hardly, therefore, serve any useful purpose if we were here to discuss the various erroneous ideas that gave rise to the contention that  $180^\circ$  in air must be the maximum aperture. Amongst these was the suggestion that the larger emergent beams of immersion objectives were due to the fact that the immersion

fluid abolished the refractive action of the first plane surface which, in the case of air, prevented there any pencil exceeding  $82^\circ$  within the glass. Also the very curious mistake which arose from the assumption that a hemisphere did not magnify an object at its centre because the rays passed through without refraction. A further erroneous view has, however, been so widespread that it will be desirable to devote a few lines to it, especially as it always seems at first sight to be both simple and conclusive.

If a dry objective is used upon an object in air as in fig. 42, the angle may approach  $180^\circ$ , but when the object is mounted in balsam as in fig. 42a, the angle at the object cannot exceed  $82^\circ$ , all rays outside that limit (shown by dotted lines) being reflected back at the cover-glass and not emerging into air. On using an immersion objective, however, the immersion fluid which replaces the air above the cover-glass allows the rays formerly reflected back to pass through to the objective so that the angle at the object may again



FIG. 42.



FIG. 42a.

be nearly  $180^\circ$  as with the dry lens. The action of the immersion objective was, therefore, supposed to be simply that it repaired the loss in angle which was occasioned when the object was transferred from air to balsam, and merely restored the conditions existing in fig. 43a with the dry objective on a dry object.

As the result of this erroneous supposition, it followed that an immersion objective could have no advantage over a dry objective, except in the case of the latter being used upon a balsam-mounted object, its aperture then being (as was supposed) "cut down." The error lies simply in overlooking the fact that the rays which are reflected back when the object is mounted in balsam (fig. 42a) are not rays which are found when the object is in air (fig. 42), but are *additional and different rays* which do not exist in air, as they cannot be emitted in a substance of so low a refractive index.

Lastly, it should also be noted that it is numerical and not angular aperture which measures the quantity of light admitted to the objective by different pencils.

First take the case of the medium being the same. The popular notion of a pencil of light may be illustrated by fig. 43, which assumes that there is equal intensity of emission in all directions, so that the quantity of light contained in any given pencils may be compared by simply comparing the contents of the solid cones. The Bouguer-Lambert law, however, shows that the quantity of light emitted by any bright point varies with the obliquity of the direction of emission, being *greater* in a perpendicular than in an oblique direction. The rays are less intense in proportion as they are more inclined to the surface

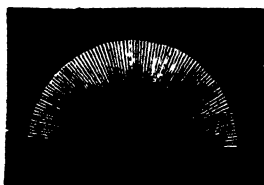

FIG. 43.

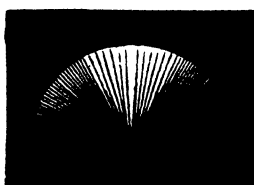

FIG. 43a.

which emits them, so that a pencil is not correctly represented by fig. 43, but by fig. 43a, the density of the rays decreasing continuously from the vertical to the horizontal, and the squares of the sines of the semi-angles (*i.e.*, of the numerical aperture) constituting the true measure of the quantity of light contained in any solid pencil.

If, again, the media are of different refractive indices, as air (1.0), water (1.33), and oil (1.52), the total amount of light emitted over the whole 180° from radiant points in these media under a given illumination is not the same, but is *greater* in the case of the media of greater refractive indices in the ratio of the squares of those indices (*i.e.*, as 1.0, 1.77 and 2.25). The quantity of light in pencils of different angle and in different media must therefore be compared by squaring the

product of the sines and the refractive indices, i.e. ( $n \sin u^2$ ), for the square of the numerical aperture.

The fact is therefore established that the aperture of a dry objective of  $180^\circ$  does not represent, as was supposed, a maximum, but that aperture increases with the increase in the refractive index of the immersion fluid; and it should be borne in mind that this result has been arrived at in strict accordance with the ordinary propositions of geometrical optics, and without any reference to or deductions from the diffraction theory of Prof. Abbe.

We have, however, still to determine the proper function of aperture, immersion objectives of large aperture excelling, as is well known, any dry objective in the delineation of minute structures.

The old explanation of the increased power of vision obtained by increase of aperture was, that by the greater obliquity of the rays to the object "shadow effects" were produced, a view which overlooked the fact, first, that the utilization of increased aperture depends not on the obliquity of the rays to the *object*, but to the *axis of the microscope*; and secondly, that just as there is no acoustic shadow produced by an obstacle, which is only a few multiples of the length of the sound waves, so there can be no shadow produced by minute objects which are only a few multiples of the light waves, the latter then passing completely *round* the object. The Abbe diffraction theory, however, supplies the true explanation, and shows that the increased performance of immersion objectives of large aperture is directly connected (as might have been anticipated) with the larger "openings" in the proper sense of the term, which, as we have just seen, such objectives necessarily possess. It has also been shown, then, in order that the image should exactly correspond with the object, all the diffracted rays must be gathered up by the objective. If any are lost we then get not an image of the real object but a spurious one. Now, if we have a coarse object, the diffracted rays are all comprised within a narrow cone round the direct beam, and an objective of small



aperture will transmit them all. With a minute object, however, the diffracted rays are widely spread out so that a small aperture can admit only a fractional part—to admit the whole or a very large part, and consequently to see the minute structure of the object, or to see it truly, a large aperture is necessary, and in this lies the value of *aperture* and of a *wide-angled immersion-objective* for the observation of minute structures.

*Object-glasses.*—With regard to the selection of object-glasses, this will depend on the work in which we may be about to engage. The amateur or student will be well advised to commence with moderate or even low powers, as a 3-inch, a 2-inch, a 1-inch, and a  $\frac{3}{4}$ -inch focus. These powers used with the A eye-piece will give a range of magnification of from 20 to 70 diameters; and with the B eye-piece will be increased to 120 diameters. Zeiss, of Jena, has lately constructed a very useful adjustable objective; by an ingenious screw-collar arrangement the relative position of the front lens is changed, and a range of power, varying from 12 to 24, or 30 diameters, is obtained. This object-glass consists of a convex back lens and a concave front lens (both achromatic), the distance of which is changed by means of a screw acting in the manner of a correcting collar of wide range. When the collar is put to 10, the objective has its minimum focal length or maximum power, approximately corresponding to that of a single 2-inch lens. By closing the collar the equivalent focal length increases, the back lens is made to approach nearer the eye-piece, and the magnifying power is varied, so that when the collar is put to 0 the actual power of the objective corresponds to that of a 4-inch lens. By a judicious use of the draw-tube of the microscope a further magnification of the image can be obtained, which is of value if botanical sections, opaque objects, and whole insects are under examination. With an erecting eye-piece the lower powers above mentioned are most useful for dissection purposes.

Objectives of medium power are the  $\frac{3}{4}$ -inch, 4-10ths,

$\frac{1}{4}$  and  $\frac{1}{2}$ th, with a magnification ranging from about 125 to 250 diameters with the A eye-piece, and increasing with the B eye-piece to 375 diameters. I have in my possession a fine  $\frac{1}{4}$  made for me by Dallmeyer, with an aperture of  $120^\circ$ . It bears an extra deep eye-piece, and will then give a magnification of 1,000 diameters—in every way satisfactory. It also works through almost any thickness of cover-glass; its aberrations being equally well balanced for uncovered objects, no mean test of a good objective. These several points prove that its working aperture has been brought to the maximum of utility. On the whole, the power is one of considerable value for the investigation of organized structure and for viewing living action. Every one aiming at original observations upon the morphology of living creatures should become skilled in the use of high magnifying powers, as the  $\frac{1}{8}$ ,  $\frac{1}{10}$ ,  $\frac{1}{12}$ ,  $\frac{1}{16}$  and  $\frac{1}{20}$ . I have, however, always pointed to the futility of constructing higher power object-glasses, except with a proportionately increased width of aperture. As the maximum angle appears to be  $180^\circ$ , or  $160^\circ$ , for the odd  $20^\circ$  are not worth the having (compare the chords of  $180^\circ$  and  $160^\circ$  there is hardly any difference), and as a  $\frac{1}{12}$  can be made to transmit an angle of  $160^\circ$ , I maintain that it will possess as much resolving power as any dry  $\frac{1}{12}$  or  $\frac{1}{15}$ th.<sup>1</sup> This is seen in the series of wonderful photographs of muscular tissue, blood corpuscles, etc., taken by Dr. Woodward, of Washington, U.S., and which certainly prove that the photographic eye sees—after making every allowance for what is due to the nature and undulations of light—what the human eye cannot see.

*The Immersion System.*—About fifty years ago Amici demonstrated the value of a drop of water inserted as an adjustable film between the object and the objective, and showed that it materially assisted in

(1) Professor Abbe has shown that no objective can possess at the same time penetrating power and perfect definition. The practical outcome of this observation is, that neither penetrating objectives nor defining objectives are alone sufficient for every kind of microscopical work. Both are necessary. If, however, the student is limited in the number of his objectives, then he should at least provide himself with a low-power defining lens, a  $\frac{1}{8}$ -inch Ross, and high-power penetrating immersion.

balancing certain uncorrected aberrations. Soemering, writing of one of Amici's microscopes, observes:—"The magnifying power, admirable precision, and clearness with which the object is seen, seems to me quite astonishing." It is not difficult to perceive that this optician's method of connecting the objective with the cover-glass of the object by means of a drop of water should diminish the reflection which takes place in the incidence of oblique light when the dry objective is used. The limiting angle of refraction of water being nearly  $48^\circ$ , it follows that whatever the degree of obliquity in the incident light falling on the object, the immersion lens can never have to deal with rays of greater obliquity than  $48^\circ$ . To this circumstance, as well as to the greater number of parallel rays brought to a focus, and to the increased angle of aperture is due the greater clearness and precision and sharpness of the image. The film of water not only furnishes increased angle of aperture, but it also collects the straying away peripheral rays of light, and sends them on to the eye-piece, to assist in rendering the image more perfect; becomes, indeed, an integral part of the optical system, and very materially aids in the removal of residuary secondary aberrations. The water-immersion system was warmly advocated and fully developed by continental makers—Hartnack, Merz, Nacet, and others—long before English opticians could be persuaded to acknowledge its advantages. Messrs. Powell and Lealand were the first opticians who made a  $\frac{1}{4}$ -inch and a  $\frac{1}{8}$ th objective, which, by a mere change of the front lens, could be used either as a wet or dry lens.

The immersion principle has recently been still further developed. The substitution of oil for water was first proposed by Amici, in 1844, who abandoned it as it seemed unmanageable and without corresponding advantages as compared with water, an opinion shared by Oberhauser and Wenham. At this time, however, it was supposed that the chief gain of the immersion consisted in a diminished loss by reflection at the front lens and an increase of working distance;

it was not recognized that additional aperture was also obtained. In 1877 Mr. J. W. Stephenson demonstrated that as the aperture of an objective increased with the increase in the refractive index of the immersion fluid great practical advantage would result from using instead of water a *homogeneous* fluid; that is, one not merely of the same refractive index, but also of the same dispersive power as the glass of the front lens of the objective. This suggestion was immediately acted upon by Professor Abbe, and in December, 1877, the first objective on the new system was issued from Zeiss's workshop, giving an increase in aperture of upwards of 50 per cent. over a dry objective of equal angle. In addition to increase of aperture, the use of a *homogeneous* fluid gives a previously unlooked-for advantage that it is possible to correct a "homogeneous immersion" objective with more facility than one which works in such media as air and water, both of which differ considerably in refractive and dispersive power from the glass of the lenses.

With air, or even water objectives, there is a large amount of aberration affecting the pencils on their passage from the radiant to the medium of the front lens, which bears a considerable ratio to the total spherical aberration within the objective, and in the case of wide angles increases disproportionately from the axis outwards. This can only be corrected by a rough method of balancing, that is, by introducing an excess of opposite aberration at the posterior lenses. An uncorrected residuum, rapidly increasing with larger apertures, is then left, and this appears in the image amplified by the total power of the objective, so that with a non-homogeneous medium there is a maximum angular aperture which cannot be surpassed without undergoing a perceptible loss of definition, provided working distance is required. If we abolish the anterior aberration for all colours, by an immersion fluid which is equal to crown-glass in refractive and dispersive power, the difficulty will be at once overcome. If, for instance, we have an objective of  $140^\circ$  in glass (= 1.25 N.A.) and water as the immersion fluid, the

aberration in front would affect a pencil of  $140^\circ$ . Substituting a homogeneous medium, the same pencil, contracted to the equivalent angle in that medium of  $112^\circ$ , will be admitted to the front lens without any aberration, and may be made to emerge from the curved surface also without any detrimental aberration, but contracted to an angle varying from  $70^\circ$  to  $90^\circ$ . The first considerable spherical aberration of the pencil then occurs at the anterior surface of the *second* lens, where the maximum obliquity of the rays is already considerably diminished.

Figs. 44 and 44a will serve to further elucidate this. If the objective of  $140^\circ$  works with water (fig. 44), there would be a cone of rays extending up to  $70^\circ$  on

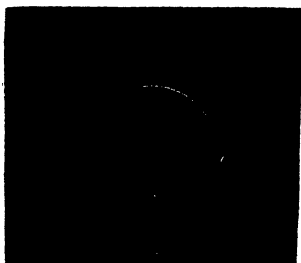

FIG. 44.



FIG. 44a.

both sides of the axis, and this large cone would be submitted to spherical aberration at the front surface *a*. But with homogeneous immersion (fig. 44a) the whole cone of  $112^\circ$  is admitted to the front lens without any aberration, there being no refraction at the plane surface; and as the spherical surface of the front lens is without notable spherical aberration, the incident pencil is brought from the focus *F* to the conjugate focus *F'*, and contracted to an angle of divergence of  $70^\circ - 90^\circ$  without having undergone any spherical aberration at all.

Thus the problem of correcting a very wide-angled objective is reduced by the homogeneous-immersion

system, both in theory and in practice, to the problem of correcting an objective having a moderate air angle.<sup>1</sup>

The adoption of the Homogeneous-immersion system is at present warmly advocated by all opticians. Messrs. Powell and Lealand take the lead with their new formula  $\frac{1}{8}$ , which, illuminated by their oil immersion-illuminator, will resolve the most difficult test-objects. This objective has an aperture, measured in crown-glass, of  $150^\circ = 1.47$  N.A.—“the widest aperture yet produced.” The same firm have constructed a  $\frac{1}{10}$  and a  $\frac{1}{15}$  on the homogeneous system, but the apertures are not so high as the  $\frac{1}{8}$ th. “By the homogeneous-immersion formula adopted by Powell and Lealand<sup>2</sup> the focal distance is practically a constant quantity, and it follows that reduction of aperture by making the front lens thinner ensures a much greater working distance without affecting the aberrations; for as the first refraction takes place at the posterior or curved surface of the front lens, the removal of any portion of thickness at the anterior or plane surface simply cuts off zones of peripheral rays without altering the distance—any space being filled up by the homogeneous-immersion fluid, or by an extra thickness of cover-glass.

“By applying an extra front lens to the back construction of such a  $\frac{1}{12}$ th, the observer is enabled to view an object through a cover-glass that would be practically a maximum thickness for a  $\frac{1}{8}$ th (aperture= $90^\circ$ ) constructed on the usual formula where the setting encroaches on the active spherical refracting surfaces. A second front might give a high average aperture for a  $\frac{1}{12}$  ( $115^\circ$ ), while the thickest front representing the maximum aperture of the whole construction ( $142^\circ$ ) would enable the observer to view an object with a greater aperture than has hitherto been obtained with any  $\frac{1}{10}$ th, owing to difficulties of construction, and through a thicker cover-glass than a  $\frac{1}{10}$ th of the same

(1) See Prof. Abbe “On Stephenson’s System of Homogeneous Immersion for Microscope Objectives,” *Journ. R. Micr. Soc.*, II (1879), p. 256, and also “The Essence of Homogeneous Immersion” *Ibid.*, I. (1881), p. 131.

(2) *Jou-nal of the R. M. S.*, Vol. III., p. 1030 (1880).

aperture will admit of;<sup>1</sup> hence three different fronts would give a great range of aperture with a corresponding working distance, which is practically what is sought by having objectives constructed of the three different foci,  $\frac{1}{8}$ ,  $\frac{1}{7}$ , and  $\frac{1}{6}$ ."

"There can be no doubt," adds the writer, "English Mechanic," "that the development of the homogeneous-immersion system, is the problem of the future as regards attaining the limit of resolution with the microscope." But to ensure the fullest advantages the system is capable of, a fluid is wanted which will meet all its requirements. Professor Abbe, Mr. Stephenson and others have experimented on various substances, and the conclusion come to is that the essential oils of cedar wood, or fennel, which so nearly correspond to glass in their refractive and dispersive power, will be found to afford the best results. Oil of aniseed, chloral hydrate and glycerine, various turpentine, and lead solutions have been tried and ultimately abandoned. One precaution is required with regard to all essential oils, they can only be used with objectives having their fronts specially cemented. Very fine objectives constructed on the homogeneous immersion system by Zeiss, and requiring no adjusting collar, may be had of Baker, Holborn, the London agent of this optician.

#### THE CONSTRUCTION OF THE MICROSCOPE.—THE MICROSCOPE STAND.

*The Principal Forms of Microscopes.*—Having duly considered the essential parts of the compound achromatic microscope, I shall proceed to offer a few remarks on typical forms of English manufacture. I must not attempt a critical examination of the very numerous stands known to practical microscopists. This would be impossible in a limited space. Neither shall I attempt to institute invidious comparisons, as, in my opinion, most forms of instruments brought to notice possess some feature of a useful and praise-

(1) Powell and Lealand have also constructed a  $\frac{1}{7}$  and  $\frac{1}{5}$  on the homogeneous system, but the apertures are not so high as in the  $\frac{1}{8}$  just mentioned

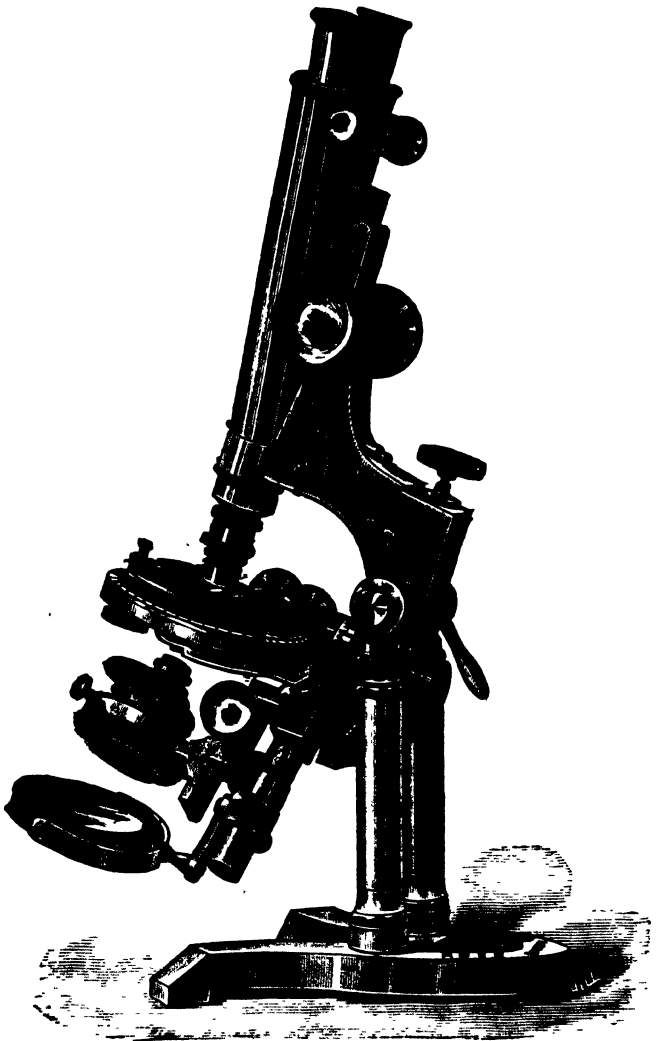

FIG 45.—The Improved Ross-Zentmayer Model.



The sub-stage, with its apparatus in place, can be instantly removed, by being drawn out sideways, so as to use the mirror alone, which is a great convenience.

The mechanical movements of this instrument are perfect, and well adapted to their purpose, and the excellence of the workmanship is such as might have been expected from the long-established reputation of the house of Ross.

The Ross-Zentmayer Student's Stand (fig. 46) is a useful instrument on a small scale, possessing all the advantages of a larger microscope. It has an excellent fine adjustment, the milled-head for working which is in as convenient a place as that of more expensive stands. It is not so costly as more pretentious instruments, a consideration often of importance to the student of the collateral sciences. Messrs. Ross make a very good and cheap series of object-glasses for histological work, especially adapted for use with this instrument.

The general plan of Powell and Lealand's Compound Microscope is represented in fig. 47. The tripod-stand gives a firm support to the trunnions that carry the tube to which the stage is attached, and from which a triangular stem is raised by the rack-and-pinion movement set in action by the double-milled head, whereby the coarse adjustment of the focus is obtained. To the upper part of the triangular bar a broad arm is fixed, bearing the compound body; this arm is hollow, and contains the mechanism for the fine adjustment, which is effected by turning the small milled-head. The arm is connected with the triangular bar by a strong conical pin, on which it turns, so that the compound body may be moved aside from the stage when necessary; by a mechanical arrangement it stops when central. The stage has been improved in construction, having vertical, horizontal, and circular movements, and graduated for the purpose of registering objects so as to be found at pleasure; and in order to do this effectually a clamping piece is provided against which the object slide rests, and the circular motion of the stage is stopped. It is an exceedingly effectual method of finding a favourite object. The

stage is firm and strong, and at the same time so thin, that the utmost obliquity of illumination is attainable, the under portion being entirely turned out; it has a dove-tailed sliding bar movable by rack and pinion; into this bar slides the sub-stage, having vertical and horizontal motions for centring, and also a circular motion; the sub-stage carries the various

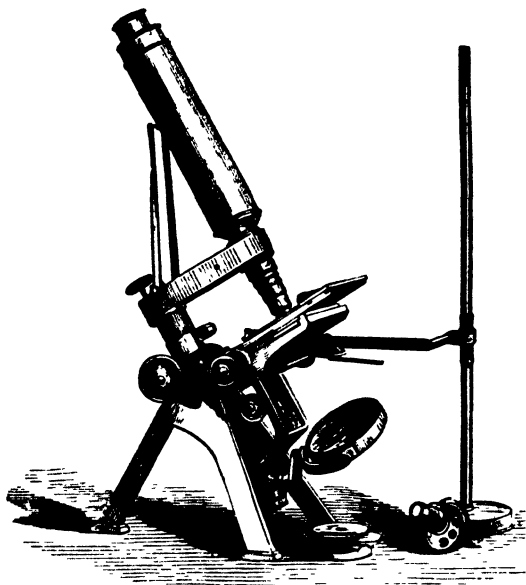

FIG. 47.—Powell and Lealand's Microscope, with Amici prism arranged for oblique illumination.

appliances for underneath illumination, removed in the woodcut. The achromatic condenser is seen detached.

Powell and Lealand have another pattern, larger and more massive in its general arrangements. The construction of the stage and sub-stage differ somewhat; both resting on a large solid brass ring, firmly attached to the stem of the instrument. The upper side of this ring bears a sort of carriage that supports

the stage, and to this carriage a rotatory motion is given by a milled-head, the amount of the movement, which may be carried through an entire revolution, being exactly measured by the graduation of a circle of gun metal, which is borne on the upper surface of the ring. The rotatory action of the stage being effected beneath the traversing movement, the centring of an object brought into the axis of the microscope is not disturbed by it; and the workmanship is so accu-

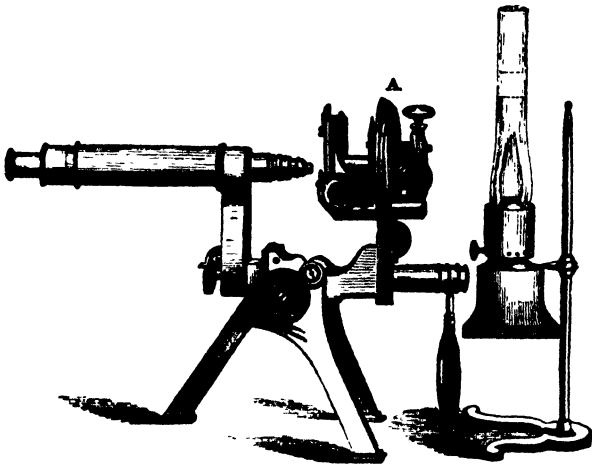

FIG. 48.—*Powell and Lealand's Microscope arranged for direct illumination.*  
*A. Secondary Stage racked up to bring the Achromatic Condenser close to the object.*

rate that the stage may be driven through its whole revolution without throwing out of the field an object viewed with the  $\frac{1}{16}$ th objective. The stage withal is made thin enough to admit of the most oblique light being thrown on the object. This instrument combines remarkable steadiness with great solidity, and is so well balanced on its horizontal axis that it requires no clamping in whatever position it may be placed.

Cheaper instruments are furnished by Powell and Lealand; a student's microscope, with  $\frac{3}{4}$ -inch stage

movement, coarse and fine adjustments to body, plane and concave mirrors, revolving diaphragm, Lister's dark-wells, and two eye-pieces, for £8.

An increasing demand for good, useful, and moderately priced instruments for students and general use, has had the effect of inducing makers to vie with each other in their endeavours to give a better class microscope for a small sum. Among those manufacturers, and to whom the microscope owes very many improvements, I may mention the firm of R. and J. Beck. Their Popular Microscope, fig. 49, is a fair example of their excellent workmanship.

The body, A (in the illustration shown as binocular), is carried by a strong arm, B; and this is attached to a square bar, C, which may be moved up or down by a rack-work and pinion in the lower part of the stand, where the stage, D, and the mirror, E, are attached.

The base, F, is triangular; and it is connected with the parts of the instrument already described by a broad stay, G, which moves on centres at the top and bottom, so as to allow the end of the tube, H, to fit by its projecting pin into various holes along the medial line of the base. With this arrangement, if the body of the microscope be required in a more or less inclined position as in the figure, four holes are provided near the extremity of the base for the pin of the tube to fit into. A hole near the stout pin, L, is used when a vertical position is wanted; while to obtain the horizontal position, the pin of the tube is placed in a hole in the stud, K, the inner surface of the stay, G, resting at the same time on the top of the stout pin, L. This form of construction is novel, and possesses the following advantages; it is strong, firm, and yet light; the instrument cannot alter from any particular inclination it is put into, which is not unfrequently the case when the ordinary joint works loose; and in every position the heavier part of the stand is brought over the centre of the base, to ensure an equality of balance.

To adjust the focus of the object-glass, turn the milled-heads O for a quick movement, or the milled-head P for a slow one.

The stage, *D*, is circular, and upon it fits a plate, *T*;

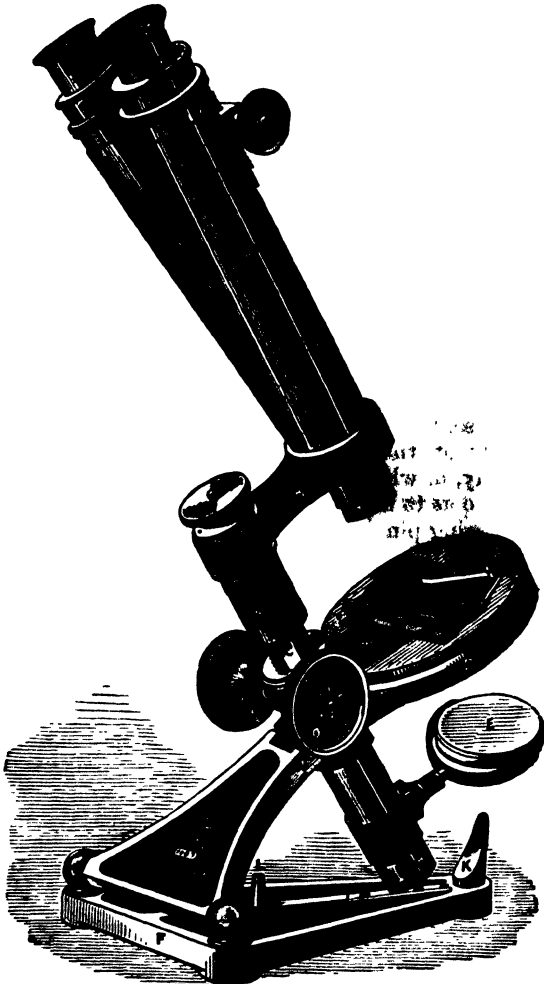

FIG. 49.—*Beck's Popular Microscope.*

this again carries the object-holder, *U*, which is pro-

vided with a ledge, *v*, and a light spring, *w*; it is held on the plate *t* by a spring underneath, so that it can be moved about easily and smoothly by one or by both



FIG. 50.—Beck's "Ideal" Microscope.

hands. Messrs. Beck's latest improvement consists in a glass friction stage, and this is adapted to all their Students' microscopes. A polished glass plate is firmly embedded in the brass stage-plate, and there held in

contact by a strong wire ring. A piece of velvet cemented to the under surface renders the stage movements extremely smooth and easy. The mirror, E, besides swinging in a rotating semi-circle, will slide up or down the tube, H, or it will turn on either side for oblique illumination.

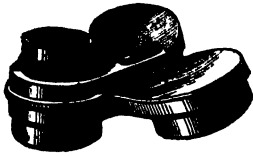

FIG. 51.—Beck's Double Nose-piece.

*Beck's "Ideal" Microscope.*—In this excellent and novel instrument (shown as a monocular in fig. 50)

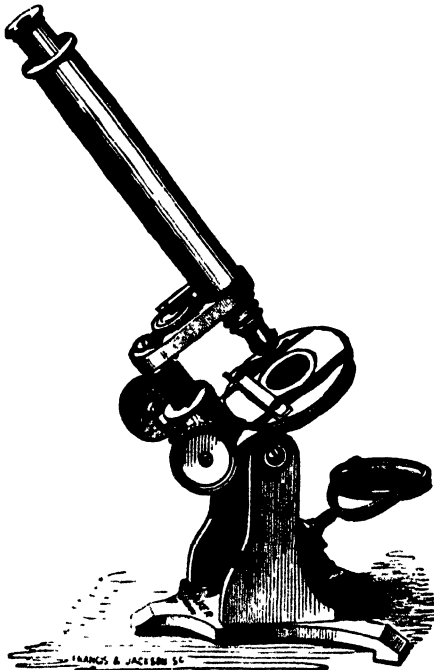

FIG. 52.—Baker's Student's Microscope.

the stage is of very thin and stiff brass, with a large

opening, and provided with reversible spring clips so as to attach an object to the underside if required. To the stage can be adapted either a circular stage-plate of thin sheet-brass revolving concentrically, or the glass stage-plate shown detached, with brass object-carrier, and allowing one inch of movement in all directions. The mirror and sub-stage slide



FIG 53 — *Baker's Model Histological Microscope.*

upon a swinging tailpiece, the latter being attached to a graduated circle, and allowing a wide range of motion above and below the stage. The body draws out to the standard length (10 inches), and takes a full-sized eye-piece. It has an adapter for the broad-gauge screw. When fully extended it is 15 inches in height, or can be reduced to 10 inches.



The working microscopist will find Beck's double or triple nose-piece (fig. 51) a useful addition and an economizer of time, as enabling him to find a minute object, which he may wish to submit to a more thorough examination under a high power.

Mr. Baker (Holborn) has kept pace with most opticians, and his *first-class* microscopes are not inferior to those of any other manufacturer. One of his best, the

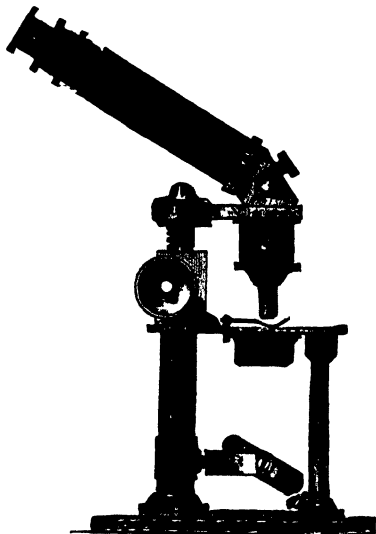

FIG. 54 — Baker's Stephenson's Binocular Dissecting Microscope

old Ross form, combines good workmanship with solidity and completeness in most of its details.

The Student's Microscope (fig. 52) is a well-finished instrument, with quick and slow motions, circular rotating stage, live-box, stage and dissecting forceps, packed in mahogany case. It has a universal sub-stage fitting, capable of receiving all accessories, and being provided with good object-glasses and other apparatus, is certainly a very complete and useful microscope.

Baker's Model Histological Microscope (fig. 53), a highly-finished instrument, having sliding body, micro-

meter screw fine-adjustment, glass concentric rotating stage, double mirror, universal sub-stage fitting to carry



FIG. 55.—*Browning's Improved Rotating Microscope.*

all apparatus, and one eye-piece, packed in mahogany case, for the small price of £3 10s.

An excellent form of binocular, in which the lowest

and the highest objective can be used with equal advantage, has been adapted by Mr. Baker to a microscope stand (fig. 54), well suited for laboratory use, and for many practical purposes. It is superior to the ordinary dissecting microscope; the erecting principle renders it generally serviceable, as, for example, in selecting and arranging shells, and in the proper disposition of specimens in the process of mounting.

The double bodies are attached by an arm to a rack-work of unusual length, suspended, as it were, over a stage 6 in.  $\times$  3 in. in the horizontal position; it has the usual double mirror of large size, the whole being supported by three solid uprights to a heavy base. The figure scarcely does the instrument justice; it fails to show the second body.

Browning's (63, Strand) Rotating Microscope (fig. 55) is well adapted for pathological work. It has a circular glass sunk in to the stage, and is consequently not likely to be damaged by moist preparations. The utility of a turning-stage, as already explained, gives the command of varying the position and illumination of the object to be examined. In the construction of this instrument this fact has been kept in view; the stage and the eye-piece revolving together on the same axis; and the image remaining in the field of vision during the whole revolution. The microscope stand aims at combining, in the simplest and least expensive form, the high qualities of the best English models.

Browning's Complete Binocular has a well-finished stand, with the latest improvements, mechanical motions to stage, secondary stage, with removable fittings, etc., and is, in every respect, a complete instrument.

Watson's Microscope Stand (fig. 56) presents points of novelty, the most notable among which is the inclining motion of the limb, carrying the optical body and stage on an axis in a line with the object on the stage. By the simple inclination of the limb, varying effects of oblique illumination can be obtained direct from the mirror, which can be attached for this purpose to the centre of the base, and is then independent of the inclination of the limb.

The base of the stand is circular, with three projecting claws; on this base a disc of metal, carrying the pillar-support (of the limb, stage, etc.), is made to

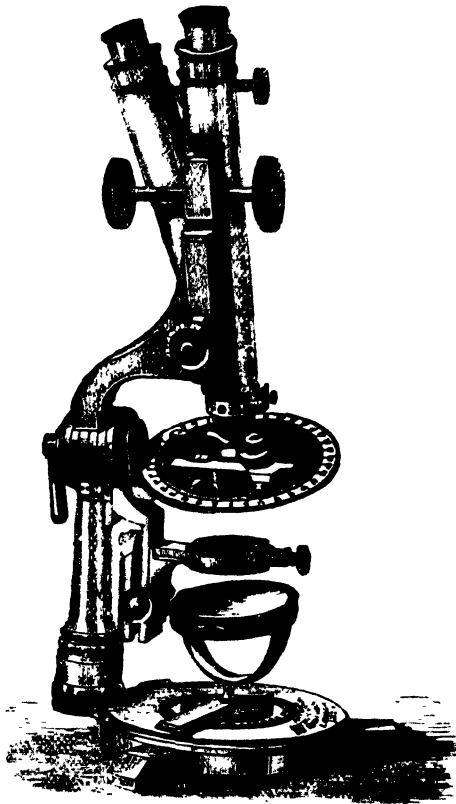

FIG. 56. — Watson and Son's New Microscope Stand.

rotate on the perpendicular optic axis; a graduated zone shows the angle of rotation.

In the centre of the base a smaller disc (projecting slightly above the general plane) is made to rotate; this disc has a groove into which the mirror-fitting

slides, and a spring-notch shows the axial position. The sliding fitting allows the mirror to be placed some distance out of the axis radially, and then the rotation of the circular moving base plate gives a considerable range of obliquity of light in azimuth; the light from the mirror remaining constantly directed upon the object, this facility obtains with all inclinations of the limb and stage, because the object itself forms the centre both of the azimuthal rotation and of the inclination in altitude. The limb is mounted in a "cradle" joint, at the top of the pillar, permitting inclination from the perpendicular.

The angle of inclination is registered upon a graduated ring against the clamping screw. The optical body is mounted, not as usual on the front of the "Jackson" limb, but on the side of it; thus converting the side of the limb into the front.

The coarse-adjustment is by the ordinary rack and pinion; the fine-adjustment lifts the optical body in a separate slide-fitting by means of a wedge-shaped block acted upon by the conical end of a fine micrometer-screw. The focal distance can be measured by the scale engraved on the slide-fitting.

The stage is of the newest construction, and beneath which is the sub-stage arm, carrying the usual screw-centring and rack-adjusting sub-stage, so attached to a sector in the rear of the stage in which it traverses concentric with the object. The sub-stage bar also carries the usual centring fitting for condenser, etc., and swings forwards or backwards concentric with the object on the main stage, and the obliquity of the swing can be registered on a graduated ring immediately behind the stage. The construction is similar to that of the Ross-Zentmayer. An extra swinging bar is attached behind, into which the mirror can be slid for use in combination with the condenser, etc. It should be noticed that there is a third divided circle on the sub-stage sector giving the inclination of the sub-stage to the axis of the body. A strong clamp on the other side of the cradle joint holds the body firmly at any inclination, and a graduation on the slide of

the coarse-adjustment enables the working distance of objectives to be measured and compared.

Watson's Medical or College Microscope (fig. 57) is an economical form of instrument, having a sliding body for coarse-adjustment, fine-adjustment, draw-tube, wheel of diaphragms, tube-fitting for under-stage apparatus, plane and concave mirrors, with one eye-piece,

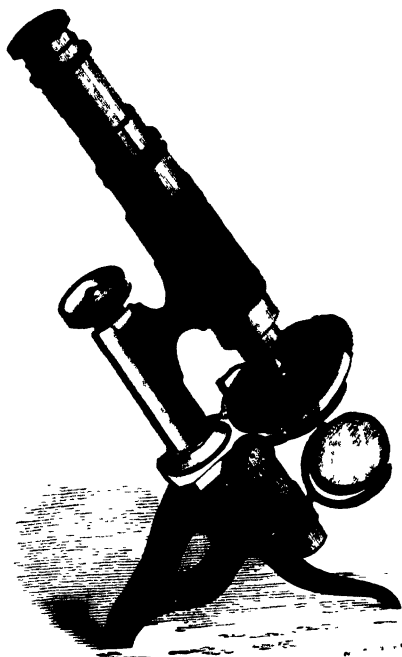

FIG. 57.—*Watson's Medical or College Microscope*

$\frac{1}{4}$ -inch and 1-inch objectives, and stand condenser. It is well adapted for class or laboratory use. The maker strongly recommends it for the use of the brewer, and amateur, as a cheap and useful instrument.

Mr. Pillischer (New Bond Street) is favourably known for the excellency of his instruments. His No. 1 Microscope (fig. 58) is of good workmanship, and

somewhat novel in design. It is constructed on a plan

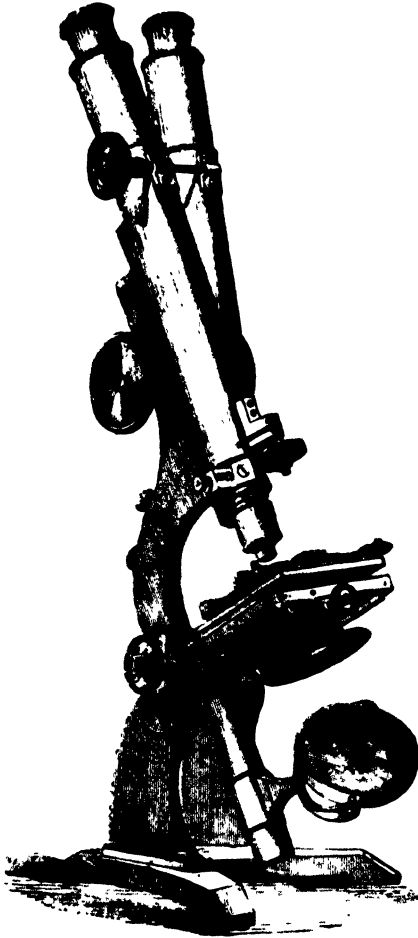

FIG. 58 — *Pillhofer's Binocular Microscope*

which may be described as intermediate between that of Smith and Beck and Ross's well-known pattern, and

in point of finish is equal to the students' microscopes of first-class manufacturers. The semicircular form given to the arm carrying the body increases the strength and solidity of the instrument, although it is doubtful whether it adds to its steadiness when placed in the horizontal position. The straight body rests for a great part of its length upon a parallel bar of solid brass, ploughed into which is a groove for the reception of the rack attached to the body, the groove being of such a form that the rack is held firmly while the pinion glides smoothly through it. A steady uniform motion is thus obtained, and which almost renders the fine-adjustment unnecessary. The fine-adjustment screw is removed from the usual position and placed in front of the body, just above and in front of the Wenham prism. The binocular bodies are inclined at a smaller angle to one another than in most instruments; nevertheless, the range of motion given to the eye-pieces by the rack and pinion, enables those whose eyes are widely separated to use the instrument with comfort. The prism is so well set that it illuminates both fields with equal intensity. The stage is provided with rectangular traversing movements to the extent of an inch and a quarter in each direction. The milled-heads which effect these are placed on the same axis, instead of side by side, one of them—the vertical one—being repeated on the left of the stage, so that the movements may be communicated either by the right hand alone or by both hands acting in concert. The stage-plate has the ordinary vertical and rotatory motions, but to a much greater extent than usual; and the platform which carries the object is provided with a spring clip to secure the object when the stage is placed in the vertical position. A regularly fitted sub-stage with centring screws is made in the usual way to carry an achromatic condenser, diaphragm, polarising and other apparatus.

Collins's Student's Microscope (fig. 59) has a 10-inch body and a draw-tube for increasing its length. The diameter of the tube is of full English size; the field is consequently large. The fittings for objectives and



accessory apparatus are all of standard size, and can, therefore, be applied to any of the larger and more elaborate instruments of English model. The fine-adjustment is ingeniously modified, very delicate, and quite free from lateral motion. Not only is the field of all the objectives supplied with it excellent, but their

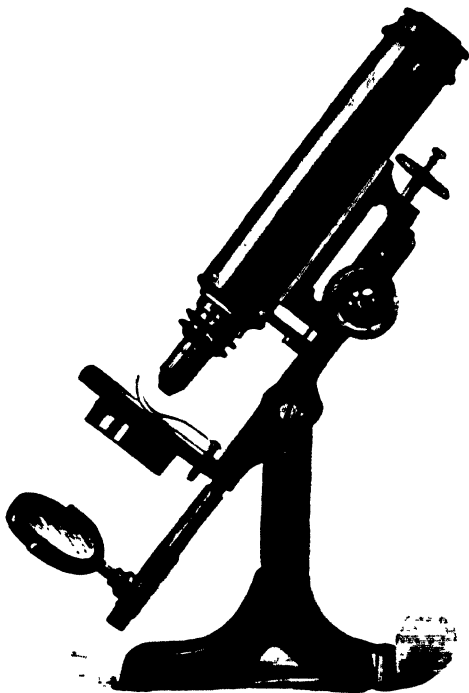

FIG. 59.—Collins's *Heterogeneous or Student's Microscope.*

penetration is of a high standard. The stand alone can be had at a lower price with eye-piece and case. On the whole, the instrument is of excellent workmanship, and possesses all the advantages and conveniences which belong to students' microscopes.

Collins's Binocular Microscope Stand (fig. 60), on the "Jackson" principle, is extremely steady and solid.

The limb that carries the body, stage, sub-stage, and mirror, is in one piece, with a machine-planed groove from end to end, thus ensuring considerable accuracy. A rack-work movement of 6 in. is given to the body,

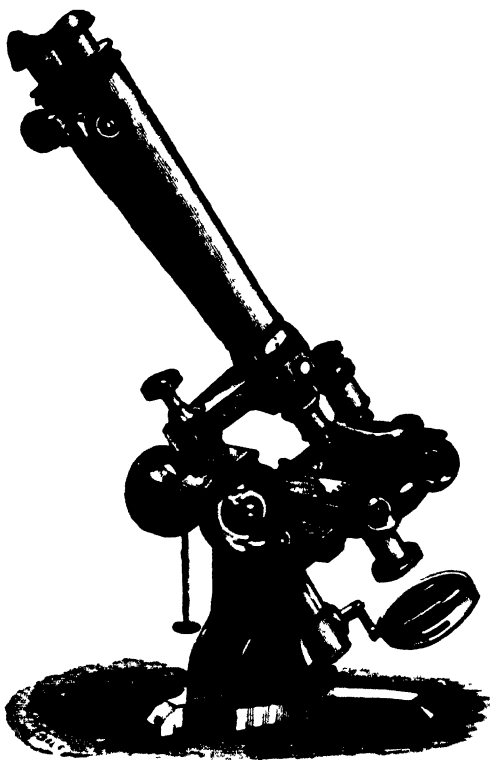

FIG. 69.—Collins's Binocular Microscope.

allowing the use of low-power objectives, so much appreciated in binocular microscopes. The Wenham prism box is made on the Harley plan, enabling the polariscope to be brought into action without removal of the objectives or putting the same out of focus.

The stage is circular in form, with concentric rotation, horizontal and vertical mechanical movements, and top slide for holding the objects, trough, etc., while under examination. It has a clear aperture underneath of 3 in. when the apparatus plate is removed, and, in consequence of the improved plan of mounting the mirrors from the back, a great obliquity of illumination can be obtained as well as a considerable range of movement when a sub-stage is fitted.

Collins's Dissecting Microscope, for plant or insect dissection (fig. 61), has a firm metal stand, sliding adjustment for focussing, two simple lenses, to be used together or separate, with mirror for illuminating.

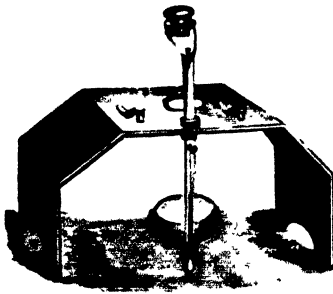

FIG. 61.—Collins's Dissecting Microscope, on Prof. Huxley's Plan.

Swift's Challenge Microscope (fig. 62), of the Jackson-Lister form,—which experienced microscopists still believe, for many reasons, to be one of the best,—is well finished in every way, the coarse-adjustment is sensi-

tive: the focussing can be accurately done by it alone, whilst the fine-adjustment is so conveniently placed as to be within easy reach of one of the fingers of the hand which works the rack. By a somewhat novel arrangement, Messrs. Swift have succeeded in mounting the analyzer above the Wenham's prism within the binocular body, so that it can be easily brought into use by pushing it into the optic axis of the instrument, without any screwing or unscrewing of the objective. To those in the habit of frequently employing the polariscope, this simple arrangement must commend itself, as the definition of the object-glass is much less interfered with by this method of mounting the analyzer than where the Wenham prism intervenes between it and the eye-piece. The instru-

ment is furnished either with a simple rotating and

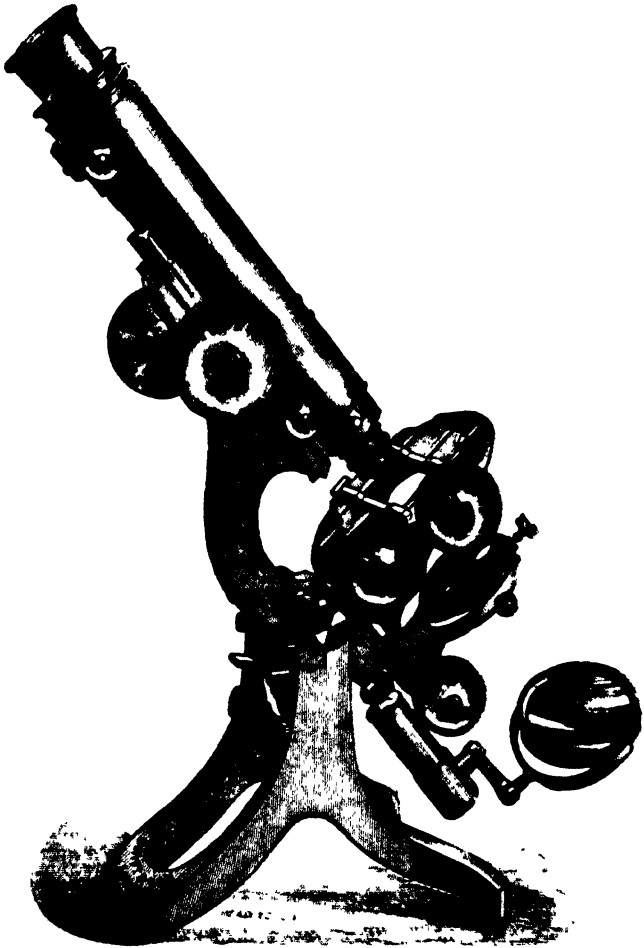

FIG. 62. -- Swift's New Challenge Microscope

universal movement stage, or a very thin mechanical stage with rectangular as well as rotatory adjustments,

and also with a centring and focussing sub-stage, for the adaptation of the achromatic condenser, paraboloid, polariscope, etc. The mirror moves by a double elbow joint, and is arranged to be used at any angle.

Swift's College or Student's Microscope is a solid,



FIG. 63. Swift's College or Student's Microscope.

well-made, handy instrument, designed for class use, and it may be expected to take the place of the continental microscope hitherto much employed in our colleges and schools of medicine.

Crouch's Microscope possesses certain advantages as a cheap microscope, since it combines perfect perform-

ance with good workmanship in the construction of the stand.

The chief point of novelty is the fine-adjustment, shown in detail in fig. 63. The solid bar *A*, carrying the optical body *B*, is suspended on the front ends of the two broad, flat, parallel tempered-steel springs *C C*, the other ends of which are attached to the limb *D*. The pressure of the focussing screw *E*, by the point at *F* on the solid bar, forces down this bar, the springs bending sufficiently to allow about  $\frac{1}{2}$ -in. range of motion downwards from the normal position. The actual motion of focussing displaces the optic axis slightly; but this displacement is attended with no inconvenience, except where the microscope is provided with a rotating stage. This mode of focussing must be regarded as practically free from friction, as there are no metal surfaces in contact; the only friction is between the point of the screw at *F*, where it acts on the bar by pressure. The suspension of the optical body is strictly on the two springs *C C*.<sup>1</sup>

How's (Farrington Street) Student's instrument (fig. 64) is deserving of a place among microscopes designed for general use. The stand is of brass, firm and well finished; the body is fitted with coarse and fine adjustments for focussing; and a draw-tube for increasing the magnifying power of the eye-piece. The stage has an arrangement, simple but novel in construction, by which a near approach to a universal movement is obtained. The movable, or upper plate, is held to the fixed lower plate with springs, and, although offering a convenient resistance, allows of a smoothness of motion quite remarkable. It resembles the magnetic stage, but is far more reliable, and can be moved upwards, downwards, laterally, or in a slanting direction, thus enabling the microscopist to follow living objects with great facility, superseding to some extent the more expensive mechanical stage. A dividing set of object-glasses is supplied with the *B* eye-piece, thus giving a range of power varying from 40 to about 200 diameters.

(1, *Journal R. M. S.*, p 112. 1851.

Murray and Heath's Student's Microscope (fig. 65) is a good solid form of instrument with a bent tripod-stand. The stand is remarkably firm, and, being



FIG. 64.—How's Student's Microscope.

bronzed over, is well adapted for daily use in the class-room or laboratory. The adjustment is effected by a *chain-movement*, which gives sufficient delicacy for powers up to the  $\frac{1}{8}$ -inch. The stage is perfectly

flat, and the slide-rest moves smoothly and freely over it. If the instrument is intended for use in the laboratory, a glass stage is made to replace the brass one. The objectives furnished with this microscope

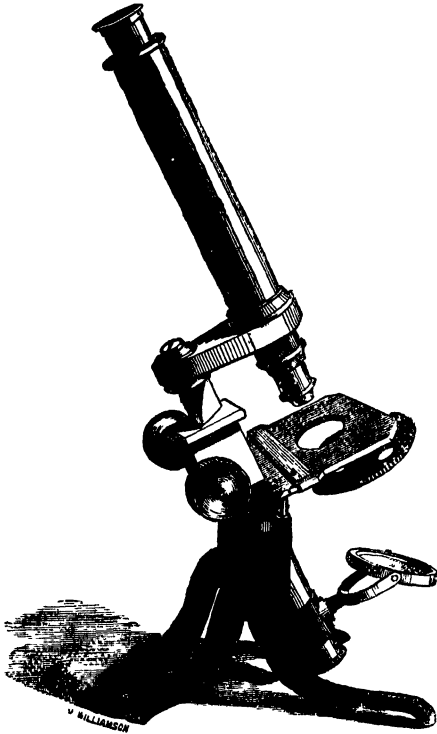

FIG. 65.—Murray and Heath's Student's Microscope

are a  $\frac{1}{4}$ -inch of  $75^\circ$  angular aperture, and a 1-inch of  $15^\circ$ , both of excellent quality.

Murray and Heath's Class Microscope, represented in fig. 66, is especially intended for the use of teachers in the demonstration of objects to a class of students. The instrument consists of the usual microscope body



(A), which can be inclined at any angle, with a mirror (C) on a ball-and-socket joint; and a stage-plate with universal movement. When about to be used as a class microscope, the slide is placed in a shallow box, into which it is locked by means of a key. The same key locks this box firmly on the stage-plate. When the object has been found, this latter can be secured firmly on the stage in the same manner. After focusing, the body is also locked in its place with the same key, which is seen at D, the final adjustment being made with the eye-piece. The body is then placed in the horizontal position, and fastened with a screw. The instrument can now be passed round a class-room

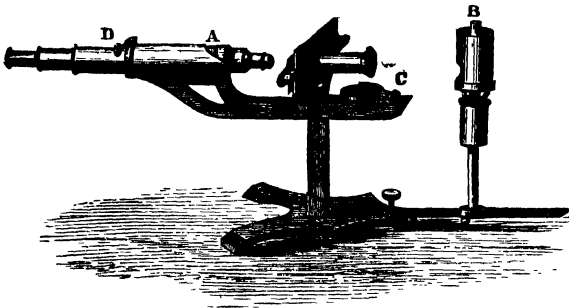

FIG 66 — *Murray and Heath's Class Microscope.*

without possibility of injury either to object or object-glass. The illumination is obtained either by directing the instrument towards the window, or by means of a small lamp (B), similar to that employed by Dr. Beale, and which can be so adjusted as to be used either for opaque or transparent objects.

In Mr. Ladd's student instrument, such as that represented in fig. 67, he has taken great care to obtain a perfect balance in any position, even when placed in the horizontal axis; no instrument can be better adapted than this to the wants of the microscopist; it is certainly one combining many of the advantages of the more expensive forms.

Nachet and Hartnack of Paris, and Merz of Munich, hold an almost equal rank as makers of first-class

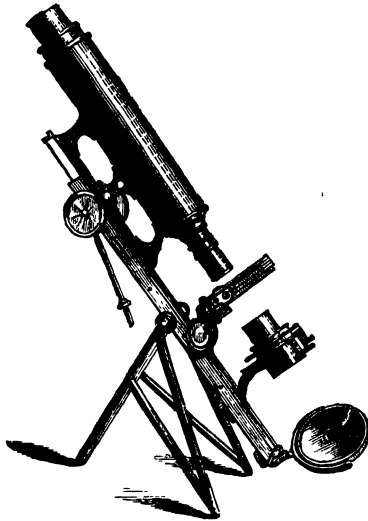

FIG. 67.—*Ladd's Student's Microscope.*

microscopes, and in point of excellence of workmanship fairly rival those of English makers.

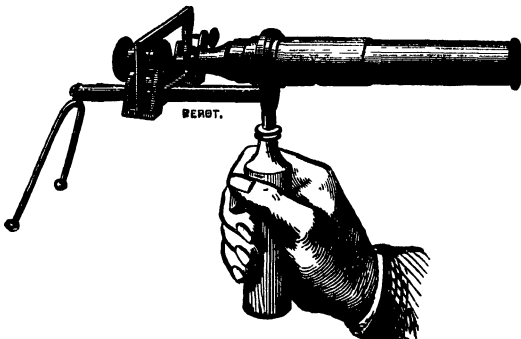

FIG. 68.—*Nachet's Portable Demonstrating Microscope.*

## APPLICATION OF BINOCULARITY TO THE MICROSCOPE.

The application of this principle to microscopic purposes seems to have been tried as early as 1677, by a French philosopher, le Père Cherubin, of Orleans, a Capuchin friar. The following is an extract from the description given by him of his instrument: "Some years ago I resolved to effect what I had long before premeditated, to make a microscope to see the smallest objects with the two eyes conjointly; and this project has succeeded even beyond my expectation, with advantages above the single instrument so extraordinary and so surprising, that every intelligent person to whom I have shown the effect, has assured me that inquiring philosophers will be highly pleased with the communication."

This communication long slumbered and was forgotten, and nothing more was heard of the subject until Professor Wheatstone's very surprising invention of the stereoscope, which he evidently expected to apply to the microscope, for he applied to both Ross and Powell to make him a binocular microscope. But this was not done; and during the year 1853 a notice appeared in *Silliman's American Journal* of a binocular instrument constructed by Professor Riddel of America, who contrived a binocular microscope in 1851, with the view "of rendering both eyes serviceable in microscopic observations." "Behind the objective," he says, "and as near thereto as possible, the light is equally divided and bent at right angles, and made to travel in opposite directions, by means of two rectangular prisms, which are in contact by their edges somewhat ground away, the reflected rays are received, at a proper distance for binocular vision, upon two other rectangular prisms, and again bent at right angles, being thus either completely inverted for an inverted microscope, or restored to their first direction for the direct microscope." M. Nachet also constructed a binocular microscope, upon the same principle as his double microscope, with the tubes placed vertically and  $2\frac{1}{2}$  inches distant. This had many disadvantages and inconveniences, which Mr. F. H. Wenham ingeniously succeeded in modifying and improving.

In describing his improvements, he observes : " That in obtaining binocularity with the compound achromatic microscope, in its complete acting state, there are far greater practical difficulties to contend against, and which it is highly important to overcome, in order to correct some of the false appearances arising from what is considered the very perfection of the instrument.

" All the object-glasses, from the one-inch upwards, are possessed of considerable angular aperture ; consequently, images of the object are obtained from a different point of view, with the two opposite extremes of the margin of the cone of rays ; and the resulting effect is, that there are a number of dissimilar perspectives of the object all blended together upon the single retina at once. For this reason, if the object has any considerable bulk, we shall have a more accurate notion of its form by reducing the aperture of the object-glass.

" Select any object lying in an inclined position, and place it in the centre of the field of view of the microscope ; then, with a card held close to the object-glass, stop off alternately the right or left hand portion of the front lens : it will be seen that during each alternate change certain parts of the object will alter in their relative position.

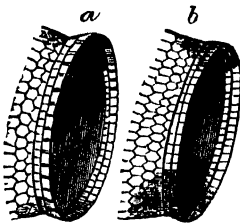

Fig. 69

" To illustrate this, fig. 69 *a*, *b* are enlarged drawings of a portion of the egg of the common bed-bug (*Cimex lecticularis*), the operculum which covers the orifice having been forced off at the time the young was hatched. The figures exactly represent the two positions that the inclined orifice will occupy when the right and left hand portions of the object-glass are stopped off. It was illuminated as an opaque object, and drawn under a two-thirds object-glass of about  $28^{\circ}$  of aperture. If this experiment is repeated, by holding the card over the eye-piece, and stopping off alternately the right and left half of the ultimate emergent pencil, exactly the same changes and appearances will be observed in the object under view.

The two different images just produced are such as are required for obtaining stereoscopic vision. It is therefore evident that if, instead of bringing them confusedly together into one eye, we can separate them so as to bring fig. 96 *a b* into the left and right eye, in the combined effect of the two projections, we shall obtain all that is necessary to enable us to form a correct judgment of the solidity and distances of the various parts of the object.

“Diagram 3, fig. 70, represents the methods that I have contrived for obtaining the effect of bringing the two eyes

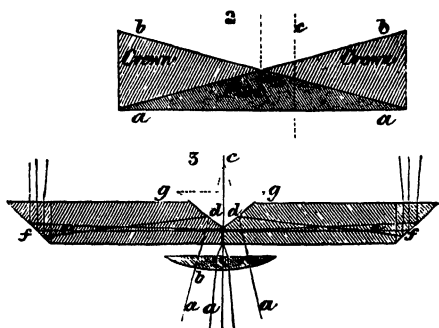

Fig. 70.

sufficiently close to each other to enable them both to see through the same eye-piece together. *a a a* are rays converging from the field lens of the eye-piece; after passing the eye-lens *b*, if not intercepted, they would come to a focus at *c*; but they are arrested by the inclined surfaces, *d d*, of two solid glass prisms. From the refraction of the under incident surface of the prisms, the focus of the eye-piece becomes elongated, and falls within the substance of the glass at *e*. The rays then diverge, and after being reflected by the second inclined surface *f*, emerge from the upper side of the prism, when their course is rendered still more divergent, as shown by the figure. The reflecting angle that I have given to the prisms is  $47\frac{1}{2}^\circ$ . I also find it is requisite to grind away the contact edges of the prisms, as represented, as it prevents the extreme margins

of the reflecting surfaces from coming into operation, which can seldom be made very perfect.

The purpose of the binocular microscope is to give a stereoscopic view of objects, whereby the form, distance and position of their various parts are simultaneously seen; the result is often as striking as if the minute object were placed in the hand as a model. To produce a stereoscopic effect there must be an equal division of the rays after they have passed through the object-glass, so that each eye may be furnished with an appropriate one-sided view of the object; but the methods hitherto contrived to effect this not only materially injure the definition of the object-glasses, but also require expensive alterations in their adaptation, or, more frequently still, a separate stand; whereas the arrangement contrived by Mr. Wenham is no obstacle to the use of the monocular instrument, and the definition even of the highest powers is scarcely impaired. Nachet of Paris has throughout endeavoured to vie with Wenham, and he substituted a double eye-piece for the binocular body. This idea was improved upon by Tolles, of Boston, U.S., and more recently it has received some improvement from Professor Abbe. Fig. 71 presents a sectional view of Abbe's stereoscopic eye-piece, and which consists of three prisms of crown glass, *a*, *b* and *b'*, placed below the field-glass of the two eye-pieces; the tube *c* is slipped into the tube or body like an ordinary eye-piece. The two prisms *a* and *b* are united so as to form a thick plate with parallel sides, inclined to the axis at an angle of  $38.5^\circ$ . The cone of rays from the objective is thus divided into two parts, one being transmitted and the other reflected; that transmitted passing through *a* *b* and forming an image of the object in the axial eye-piece B. Adjustment for different distances between the eyes is effected by the screw placed to the right-hand side of the figure, which moves the eye-piece B', together with the prism *b'*, in a parallel direction. The tubes can also be drawn out, if greater separation is required. The special feature of the instrument is an ingenious arrangement for

halving the cones of rays above the eye-pieces, where, by simply turning the caps with the diaphragms, orthoscopic or pseudoscopic effects can be instantaneously produced. This arrangement is particularly suitable for the cheaper forms of microscopes, and for those of foreign manufacture, which are usually shorter in the body than English-made instruments.

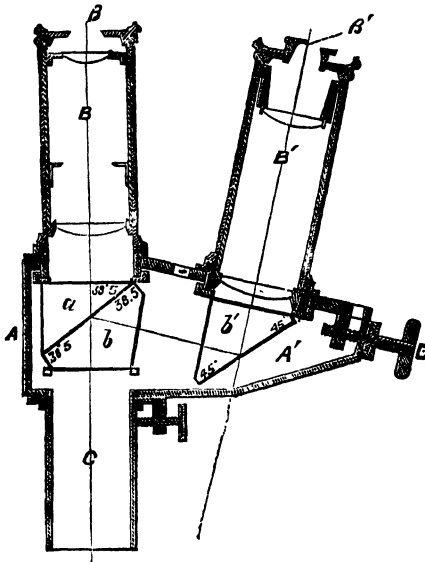

FIG 71 — Professor Abbe's Stereoscopic Eye-pieces.

The most important improvement effected by Wenham consists in splitting up or dividing the pencil of rays proceeding from the objective by the interposition of a prism of the form shown in fig. 72. This is placed in the body or tube of the microscope (fig. 72a, a) so as to interrupt only one-half ( $a c$ ) of the pencil, the other half ( $a b$ ) going on continuously to the field-glass, eye-piece, of the principal body. The interrupted half of the pencil, on its entrance into the prism, is subjected to very slight refraction, since its axial ray is perpen-

dicular to the surface it meets. Within the prism it is subjected to two reflections at *b* and *c*, which send it forth again obliquely on the line *b* towards the eyepiece of the secondary body, to the left-hand side of the figure; and since at its emergence its axial ray is again perpendicular to the surface of the glass, it suffers no more refraction on passing out of the prism than on entering it. By this arrangement, the image

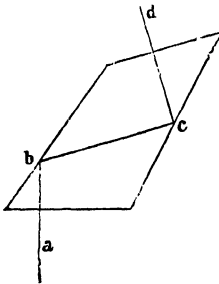

FIG. 72.

received by the right eye is formed by the rays which have passed through the left half of the objective; whilst the image received by the left eye is formed by the rays which have passed through the right half, and which have been subjective to two reflections within the prism, passing through only two surfaces of glass. The prism is held by the ends only on the sides of a small brass drawer, so that all the four polished surfaces are accessible, and should slide in so far that its edge may just reach the central line of the objective, and be drawn back against a stop, so as to clear the aperture of the same. In this case the straight tube acts as a single microscope.

The binocular constructed as we have described performs satisfactorily up to the  $\frac{1}{4}$ th inch; but for

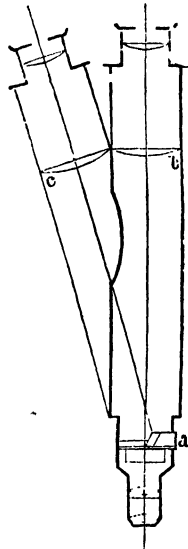

FIG. 72a.



powers above this a special arrangement is needed for the prism, which must be set close behind the lens of the  $\frac{1}{8}$ th or  $\frac{1}{12}$ th inch, in order to obtain an entire field of view in each eye.

A strong light should be avoided for the illumination of objects observed with the binocular microscope, as direct rays tend to destroy the stereoscopic effect. The illuminator that has been found to give an excellent effect consists of three plano-convex lenses, so combined as to give a very large *area* of light, as well as great intensity.

The improvement effected in Nacet's binocular eye-piece by Mr. Tolles, optician, of Boston, U.S., consists in mounting the prisms in a light material, vulcanite, which are made to fit into the monocular microscope body, taking the place of the ordinary eye-piece. The image transmitted by the objective is brought to a focus on the face of the first equilateral triangular prism by the intervention of an erector eye-piece inserted beneath it. The second set of prisms are by a rack-and-pinion movement adjusted to suit any visual angle; thus the illumination of both fields is of nearly equal brightness

### *Spectro-Microscopy.*

The application of the spectroscope to the microscope is one of the most beautiful additions the instrument has ever received. The honour of the invention appears to belong to H. C. Sorby, F.R.S., whose first experiments were made with a simple triangular prism, arranged and fixed below the stage, so that a minute spectrum of any transparent object might be readily examined, when placed in position immediately before the slit. Shortly after the publication of Mr. Sorby's paper, Mr. Huggins proposed to adapt a direct vision spectroscope to the eye-piece, for the purpose of viewing the spectra of opaque as well as transparent objects. The exact form since adopted is the Sorby-Browning Spectroscope.

The first spectroscope made by Mr. Browning (63 Strand) is represented in fig. 73. A prism is placed at P, which is enclosed in a box, so as to give a black field, by excluding

extraneous light. The rays of light, after passing between the knife-edges at  $\kappa$ , are rendered parallel by means of the lens at  $L$ . Then passing through the prism and condenser ( $o$ ), they reach the object at  $o$ . The light is placed at  $w$ , and if it be proposed to examine a liquid, it can be placed in a small tube ( $\tau$ ), closed at one end; or a transparent object may be placed on the stage in the usual

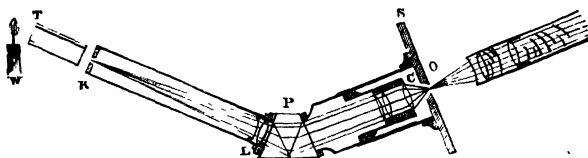

Fig. 73.—Sectional view of the Browning Spectroscope.

manner. By the addition of a small telescope, instead of a condenser, this contrivance can be applied to a microscope in place of the eye-piece, and it can then be used for the examination of opaque objects.

The great objection to this form is its limited range, and the constant shifting of parts it requires for finding and focussing the object, and the awkward position of the microscope, whether it be used under the stage or as an eye-piece.

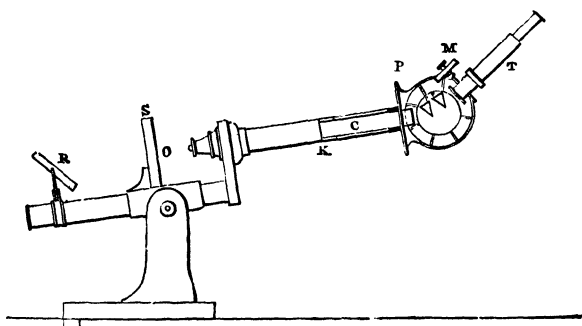

Fig. 74.—The Browning Huggins' Micro-spectroscop.

The apparatus used by Mr. Huggins (fig. 74) was a star

## THE MICROSCOPE.

spectroscope, of which the collimative-tube was inserted in the body of the microscope, instead of an eye-piece. With this apparatus he has succeeded in obtaining a spectrum showing the absorption-bands from a mere fragment of single blood-disc, when mounted as a transparent object. In fig. 74. *k* represents the knife-edges, *o* the tube containing the collimating-lens, *p* the prisms, *t* the telescope, and *m* the micrometer; the object is placed on the stages at *o*, and must be illuminated from below if transparent, or, if opaque, from above by any kind of condenser.

Mr. Sorby suggested that a prism might be made of dense flint-glass, of such a form that it could be used in two different positions, and that in one it should give twice the dispersion that it would in the other, but that the angle made by the incident and emergent rays should be the same in both positions.

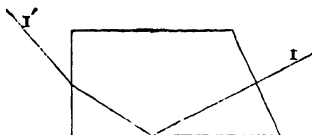

Fig. 75.

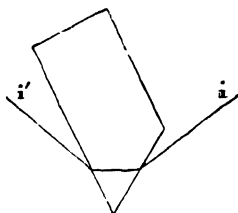

Fig. 75a.

Figs. 75 and 75<sub>a</sub> represent prisms of the kind made by Mr. Browning, used in two different positions, *i* and *i'* being the same angle as *i* and *i'*.

For most absorption-bands, particularly if faint, the prism would be used in the first position, in which it gives the least dispersion; but when greater dispersion is required, so as to separate some particular lines more widely, or to show the spectra of the metals, or Fraunhofer's lines in the solar spectrum, then the prism must be used as in fig 75<sub>a</sub>. This answers well for liquids or transparent objects, but it is, of course, not applicable to opaque objects.

To combine both purposes, some form of direct vision-prisms which can be applied to the body of the microscope is required. Fig. 76 represents the arrangement of direct vision-prisms, invented by A. Herschel. The line  $R R'$  shows the path of a ray of light through the prisms, where it would be seen that the emergent ray  $R'$  is parallel and coincident with the incident ray  $R$ .

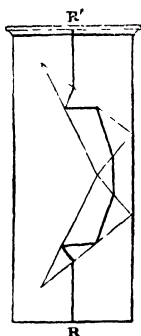

Fig 76.

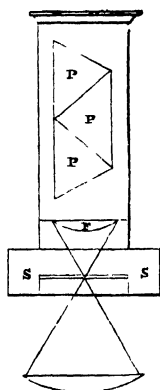

Fig 76a

Another very compact combination is shown in fig. 76a. Any number of these prisms (P P P) may be used, according to the amount of dispersion required. They are mounted in a similar way to a Nicols' prism, and are applied directly over the eye-piece of the microscope. The slit  $s s$  is placed in the focus of the first glass (P) if a negative, or below the second glass if a positive eye-piece be employed. One edge of the slit is moveable, and, in using the instrument, the slit is first opened wide, so that a clear view of the object is obtained. The part of the object of which the spectrum is to be examined is then made to coincide with the fixed edge of the slit, and the moveable edge is screwed up, until a brilliant coloured spectrum is produced. The absorption-bands will then be readily found by slightly altering the focus. This contrivance answers perfectly for opaque objects,

without any preparation; and, when desirable, the same prism can be placed below the stage, and a micrometer used in the eye-piece of the microscope, thus avoiding a multiplication of apparatus.

The latest improvement is that shown in fig. 77, also effected by Mr. Browning, who deserves great credit for the skill displayed in the invention and construction of this new and elegant micro-spectroscope.

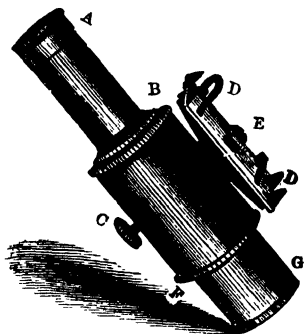

Fig 77.--The Sorby-Browning Micro-spectroscope.

The prism is contained in a small tube, which can be removed at pleasure. Below the prism is an achromatic eye-piece, having an adjustable slit between the two lenses, the upper lens being furnished with a screw motion to focus the slit. A side slit, capable of adjustment, admits, when required, a second beam of light from any object whose spectrum it is desired to compare with that of the object placed on the stage of the microscope. This second beam of light strikes against a very small prism, suitably placed inside the apparatus, and is reflected up through the compound prism, forming a spectrum in the same field with that obtained from the object on the stage.

A is a brass tube, carrying the compound direct vision prism. B, a milled head, with screw motion to adjust the focus of the achromatic eye lens. C, milled head, with screw motion to open or shut the slit vertically. Another

screw at right angles to *c*, but which from its position could not be shown in the cut, regulates the slit horizontally. This screw has a larger head, and when once recognised cannot be mistaken for the other. *DD* is an apparatus for holding a small tube, that the spectrum given by its contents may be compared with that from an object on the stage. *E* is a square-headed screw, opening and shutting a slit to admit the quantity of light required to form the second spectrum. A light entering the round hole near *E*, strikes against the right-angled prism, which we have mentioned as being placed inside the apparatus, and is reflected up through the slit belonging to the compound prism. If any incandescent object be placed in a suitable position with reference to the round hole, its spectrum will be obtained. *F* shows the position of the field lens of the eye-piece. *G* is a tube made to fit the microscope to which the instrument is applied. To use this instrument insert *G*, like an eye-piece in the microscope tube, taking care that the slit at the top of the eye-piece is in the same direction as the slit below the prism. Screw on to the microscope the object-glass required, and place the object whose spectrum is to be viewed on the stage. Illuminate with the stage mirror if it be transparent; with mirror, Lieberkühn, and dark well, by side reflector, or bull's-eye condenser if opaque. Remove *A*, and open the slit by means of the milled-head, not shown in cut, but which is at right angles to *DD*. When the slit is sufficiently open the rest of the apparatus acts like an ordinary eye-piece, and any object can be focussed in the usual way. Having focussed the object, replace *A*, and gradually close the slit till a good spectrum is obtained. The spectrum will be much improved by throwing the object a little out of focus.

Every part of the spectrum differs a little from adjacent parts in refrangibility, and delicate bands or lines can only be brought out by accurately focussing that particular part of the spectrum. This can be done by the milled head *B*. Disappointment will occur in any attempt at delicate investigation if this direction be not carefully attended to.

At *m* a small mirror is attached, which is omitted in the diagram to prevent confusion. It is like the mirror below

the stage of a microscope, and is mounted in a similar manner. By means of this mirror light may be reflected into the eye-piece, and in this way two spectra may be procured from one lamp.

For observing the spectra of liquids in cells or tubes of considerable diameter, say not less than  $\frac{1}{16}$ th of an inch, powers from 2 inch to 1 inch will be the most suitable, and of course low powers only can be used to investigate the spectra of opaque objects; but when the spectra of very minute objects are to be viewed, powers of from half an inch to one-twentieth, or even higher, may be employed.

Blood, madder, aniline red, permanganate of potash, in crystals or solution, are convenient substances to begin experiments with. Solutions when made too strong produce dark clouds instead of absorption bands. Professor Church has recently pointed out that zircon, an almost colourless stone, gives well-defined absorption-bands.

Mr. Sorby says of the correct performance of a spectrum adaptation, "The best tests are, first, that the absorption-bands in blood can be seen when they are very faint; second, to well divide the bands in permanganate of potash; and, third, to see distinctly the very fine line given in the red by a solution of chloride of cobalt dissolved in a concentrated cold solution of chloride of calcium: there is a line so fine that it looks like a Fraunhofer's line. An instrument that shows all these well is all that can be desired.

"The objects most easily obtained, and which furnish us with the greatest variety of spectra, are coloured crystals, coloured solutions, and coloured glasses. The spectrum microscope enables us to examine the spectra of very minute crystals, of very small quantities of material in solution, and of small blow-pipe beads. As previously named, the thickness of the object makes a very great difference in the spectrum. For example, an extremely thin crystal of ferricyanide of potassium cuts off all the blue rays, and leaves merely red, orange, yellow, and more or less green; but on increasing the thickness, the green and yellow disappear; and when very much thicker, little else but a bright red light is transmitted. In all such

cases, the apparent magnitude of the effect of an increase in thickness is far greater when the object is thin than when thick, and past a certain thickness the change is comparatively very slight. If only small crystals can be obtained, it is well to mount a number of different thicknesses; but when it is possible to obtain crystals of sufficient size, it is far better to make them into wedge-shaped objects, since then the effect of gradual change in thickness can easily be observed. Different kinds of crystals require different treatment, but, as a general rule, I find that it is best to grind them on moderately soft Water-of-Ayr stone with a small quantity of water, which soon becomes a saturated solution, and then to polish them with a little rouge spread on paper laid over a flat surface; or else, in some cases, to dissolve off a thin layer by carefully rubbing the crystal on moist blotting-paper until the scratches are removed. Then, whenever it is admissible, I mount the crystal on a glass, and also cover it with a piece of thin glass with Canada balsam. Strongly coloured solutions may be examined in test-tubes, or may be kept sealed up in small bottles made out of glass tubes, the light then examined being that which passes through the centre of the tube from side to side. (Most of these solutions require the addition of a little gum Arabic to make them keep.) Such tubes may be laid on the ordinary stage, or laid on the stage attached to the eye-piece. Smaller quantities may be examined in cells cut out of thick glass tubes, one side being fixed on the ordinary glass with Canada balsam, like a microscopic object, and the other covered with thin glass, which readily holds on by capillary attraction, or may be cemented fast with gold size or Canada balsam, if it be desirable to keep it as a permanent object. Such tubes may be made of any length that may be required for very slightly-coloured solutions. Cells made out of spirit thermometer tubes, so as to be about  $\frac{1}{10}$ th of an inch in diameter, and  $\frac{1}{2}$  an inch long, are very suitable for the examination of very small quantities; but where plenty of material can be obtained, it is far better to use cells cut out of strong tubes, having an interior diameter of about  $\frac{1}{4}$ ths of an inch, cut wedge-shape, so that the thickness of the solution may be  $\frac{1}{4}$ th



of an inch, or more, on one side, and not above  $\frac{1}{10}$ th on the other ; and then the effect of different thicknesses can easily be ascertained.

“ Fortunately, the various modifications of the colouring matter of blood yield such well-marked and characteristic spectra, that there are few subjects to which the spectrum-microscope can be applied with greater advantage than the detection of blood-stains, even when perfectly dry. For this purpose condensed light may be used, provided a sufficiently bright light be thrown on the object by means of a parabolic reflector or bull’s-eye condenser. A speck of blood on white paper shows the spectrum very well, provided it be fresh, and the colour be neither too dark nor too light, and the thickness of the colouring matter neither too great nor too little. A mere atom, invisible to the naked eye, which would not weigh above the  $\frac{1}{1000000}$ th of a grain, is then sufficient to show the characteristic absorption-bands. They are, however, far better seen in solution. About  $\frac{1}{100}$ th of a grain of liquid blood, in a cell of  $\frac{1}{10}$ th of an inch in diameter, and  $\frac{1}{2}$  an inch long, gives a spectrum as well marked as could be desired. In exhibiting the instrument to a number of persons at a meeting, I have found that no object is more convenient, or excites more attention, than one in which a number of cells are fixed in a line, side by side, containing a solution of various red-colouring matters. In one I mount blood, which gives two well-marked absorption-bands in the green ; in another magenta, which gives only one distinct band in the green ; and in another I place the juice of some red-coloured fruit, which shows no well-defined absorption-band. Keeping a larger cell containing blood on the stage attached to the eye-piece, these three objects can be passed one after another in front of the object-glass, and the total difference between the spectrum of blood and that of either fruit-juice or magenta, and the perfect identity of the spectra when both are blood, can be seen at a glance. By holding coloured glasses, which cut off the red, but allow the green rays to pass, we can readily show how the presence of any foreign colouring-matter, which entirely alters the general colour, might not in any degree disguise the characteristic part of the spectrum ; and by

changing the cell held on the eye-piece for a tube containing an ammoniacal solution of cochineal, it is easy to show that, though it yields a spectrum with two absorption-bands, more like those due to blood than I have seen in any other substance, they differ so much in relation, size, and position, that there is no chance of their being confounded when compared together side by side." <sup>1</sup>

We have been usually taught that the red-blood corpuscles consisted of two substances, hæmatin and globulin; but later researches lead to the belief that they consist of one crystalline substance, termed *globulin* or *hæmato-globulin*. A solution of this substance, as well as of certain products of its decomposition, produces the absorption-bands referred to. Hoppe was the first to demonstrate this fact: he found that a very dilute solution of blood was sufficient for the purpose. Professor Stokes proved that this colouring-matter is



No. 1. Arterial Blood, Scarlet Cruorine.



No. 2. Venous Blood, Purple Cruorine.



No. 3. Blood treated with Acetic Acid.



No. 4. Solution of Hæmatin.

ABSORPTION BANDS, AFTER STOKES.

capable of existing in two states of oxidation, and that a very different spectrum is produced according as the substance, which he has termed *cruorine*, is in a more or less oxidised condition. <sup>2</sup> Proto-sulphate of iron, or proto-chloride of tin, causes the reduction of the colouring-matter, and, by exposure to air, oxygen is absorbed, and the solution again exhibits the spectrum characteristic of the more oxidised state. The different substances obtained from blood colouring-matter produce different bands. Thus, *hæmatin* gives rise to a band in the red spectrum, *hæmato-globulin* produces two bands, the second twice the breadth of the first in the yellow portion of the spectrum between the lines D and F. No. 1. The absorption-bands differ according to the strength of the solution employed, and the medium in which the blood-salt is dissolved; but an exceedingly minute proportion dissolved in water is sufficient to bring out very distinct bands.

(1) *Popular Science Review*, January, 1866.

(2) Professor Stokes, "On the Reduction and Oxidation of the Colouring-matter of the Blood" (*Proceed. Royal Soc* vol. xiii. p 355). The oxidising solution is made as follows:—To a solution of proto-sulphate of iron, enough tartaric acid is added to prevent precipitation by alkalis. A small quantity of this solution, made slightly alkaline by ammonia or carbonate of soda, is to be added to the weak solution of blood in water.

*The Camera Lucida.*

The main point to be observed when using the Camera Lucida is that the microscope shall be placed in the horizontal position, and the object well lighted. The Ross-Wollaston Neutral Tint Camera Lucida consists of a metallic cylinder, cut at an angle of  $45^\circ$  to its axis, thus producing an elliptical opening, into which

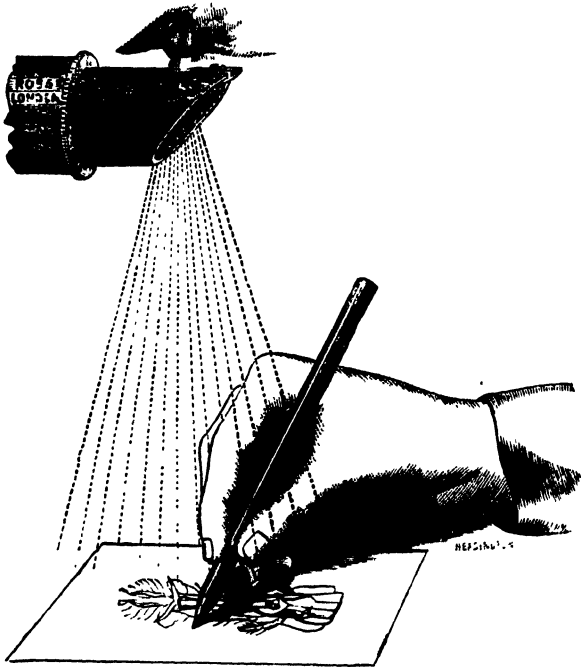

FIG. 78.—*The Ross-Wollaston Camera Lucida.*

a plate of neutral tint glass is fitted. Opposite to this is an opening about half an inch in diameter, through which the student may view, and trace or measure the object on drawing-paper, the microscope with the camera attached to the eye-piece having been previously brought into a horizontal position.

*Microscopical Drawing.*—The proper method of drawing microscopic objects is acquired by looking down the tube of the microscope with one eye (preferably the left), and at the paper on which the drawing is to be made with the other. Place the microscope in the horizontal position, having first secured the object to be copied to the stage, focus it carefully, and take care *not* to place it too centrally, but as far towards the right as it will go without taking it out of the field of view. If the right eye is now opened, while the other is looking down the tube, the object will be seen projected on the paper, and can thus be easily traced in all its details.

#### *The Polarisation of Light.*

Common light moves in two planes at right angles to each other, polarised light moves only in one plane. Common light may be turned into polarised light either by transmission or reflection; in the first instance, one of the planes of common light is got rid of by reflection, in the other, by absorption. Huyghens was among the first to notice that a ray of light has not the same properties in every part of its circumference, and he compared it to a magnet or a collection of magnets; and supposed that the minute particles of which it was said to be composed had different poles, which, when acted on in certain ways, arranged themselves in particular positions; and thence the term *polarisation*, a term having neither reference to cause nor effect. It is to Malus, however, who, in 1808, discovered polarisation by reflection, that we are indebted for the series of splendid phenomena which have since that period been developed; phenomena of such surpassing beauty as far to exceed all ordinary objects presented to our eyes under the microscope. It has been truly observed by Sir David Brewster, that “the application of the principles of double refraction to the examination of structures is of the highest value. The chemist may perform the most dexterous analysis; the crystallographer may examine crystals by the nicest determination of their forms and cleavage: the anatomist or botanist may use the dissecting knife and microscope with the most exquisite skill; but there are still structures in the mineral,

vegetable, and animal kingdoms, which defy all such modes of examination, and which will yield only to the magical analysis of polarised light. A body which is quite transparent to the eye, and which might be judged as monotonous in structure as it is in aspect, will yet exhibit, under polarised light, the most exquisite organisation, and will display the result of new laws of combination which the imagination even could scarcely have conceived. In evidence of the utility of this agent in exploring mineral, vegetable, and animal structures, the extraordinary organisation of Apophyllite and Analcime may be referred to; also the symmetrical and figurate depositions of siliceous crystals in the epidermis of equisetaceous plants, and the wonderful variations of density in the crystalline lenses of the eyes of animals.

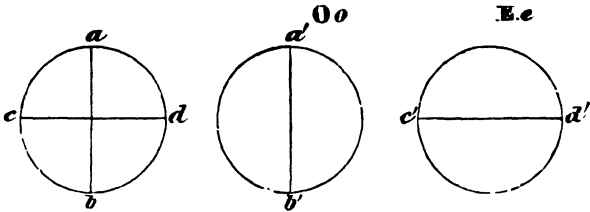

Fig. 79.

If we transmit a beam of the sun's light through a circular aperture into a darkened room, and if we reflect it from any crystallised or uncrystallised body, or transmit it through a thin plate of either of them, it will be reflected and transmitted in the very same manner, and with the same intensity, whether the surface of the body is held above or below the beam, or on the right side or left, provided that in all cases it falls upon the surface in the same manner; or, what amounts to the same thing, the beam of solar light has the same properties on all its sides; and this is true, whether it is white light as directly emitted from the sun, or from a candle or any burning or self-luminous body; and all such light is called *common* light. A section of such a beam of light will be a circle, like  $a b c d$ , fig. 79; and we shall distinguish the section of a beam

of common light by a circle with two diameters  $ab, cd$ , at right angles to each other.

If we now allow the same beam of light to fall upon a rhomb of Iceland spar, and examine the two circular beams,  $Oo, Ee$ , formed by double refraction, we shall find, 1st, that the beams  $Oo, Ee$  have different properties on different sides, so that each of them differs in this respect from the beam of common light.

2d. That the beam  $Oo$  differs from  $Ee$  in nothing excepting that the former has the same properties at the sides  $a'b'$  that the latter has at the sides  $c'$  and  $d'$ ; or in general that the diameters of the beam, at the extremities of which the beam has similar properties, are at right angles to each other, as  $a'b'$  and  $c'd'$  for example.

These two beams,  $Oo, Ee$ , are therefore said to be *polarised*, or to be beams of *polarised* light, because they have sides or *poles* of different properties and planes passing through the lines  $ab, cd$ ; or  $a'b', c'd'$ , are said to be the *planes* of *polarisation* of each beam, because they have the same property, and one which no other plane passing through the beam possesses.

Now it is a curious fact, that if we cause the two polarised beams  $Oo, Ee$  to be united into one, or if we produce them by a thin plate of Iceland spar, which is not capable of separating them, we obtain a beam which has exactly the same properties as the beam  $abcd$  of common light. Hence we infer that a beam of common light,  $abcd$ , consists of *two* beams of polarised light, whose plane of polarisation, or whose diameters of similar properties, are at right angles to one another. If  $Oo$  be laid above  $Ee$ , it will produce a figure like  $abcd$ ; and we shall therefore represent polarised light by such figures. If we were to place  $Oo$  above  $Ee$ , so that the planes of polarisation  $a'b'$  and  $c'd'$  coincide, then we should have a beam of polarised light twice as luminous as either  $Oo$  or  $Ee$ , and possessing exactly the same properties; for the lines of similar property in the one beam coincide with the lines of similar property in the other. Hence it follows that there are three ways of converting a beam of common light,  $abcd$ , into a beam or beams of polarised light.

1st. We may separate the beam of common light,  $abcd$ ,

component parts  $O o$  and  $E e$ . 2d. We may turn round the planes of polarisation,  $a b c d$ , till they coincide or are parallel to each other. 3d. We may absorb or stop one of the beams, and leave the other, which will consequently be in a state of polarisation."<sup>1</sup>

The first of these methods of producing polarised light is that in which we employ a doubly refracting crystal, and was first discovered to exist in a transparent mineral substance called *Iceland spar*, *calcareous spar*, or *carbonate of lime*. This substance is admirably adapted for exhibiting this phenomenon, and is the one generally used by microscopists. Iceland spar is composed of fifty-six parts of lime and forty-four parts of carbonic acid; it is found in various shapes in almost all countries; but whether found in crystals or in masses, we can always cleave it or split it into shapes represented by fig. 80, which is called a rhomb of Iceland spar, a solid bounded by six equal and similar rhomboidal surfaces, whose sides are parallel, and whose angles  $b a c$ ,  $a c d$ , are  $101^{\circ} 55'$  and  $78^{\circ} 5'$ . The

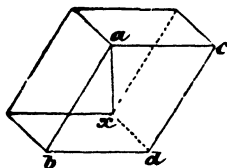

Fig. 80.

line  $a x$ , called the *axis of the rhomb*, or of the crystal, is equally inclined to each of the six faces at an angle of  $45^{\circ} 23'$ . It is very transparent, and generally colourless. Its natural faces when it is split are commonly even and perfectly polished; but when they are not so, we may, by a new cleavage, replace the imperfect face by a better one, or we may grind and polish an imperfect face.

It is found that in all bodies where there seems to be an irregularity of structure, as salts, crystallised minerals, &c., on light passing through them, it is divided into two distinct pencils. If we take a crystal of Iceland spar, and look at a black line or dot on a sheet of paper, there will appear to be two lines or dots; and on turning the spar round, these objects will seem to turn round also; and twice in the revolution they will fall upon each other, which occurs when the two positions of the spar are exactly opposite, that is, when turned one-half from the position

(1) Brewster's "Optics"

where it is first observed. In the accompanying diagram, fig. 81, the line appears double, as  $ab$  and  $cd$ , or the dot,

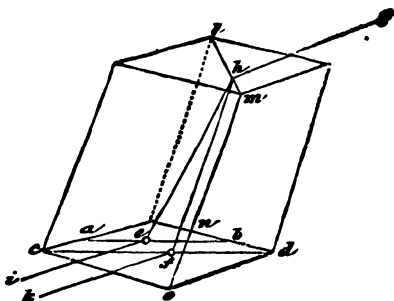

Fig. 81.

as  $e$  and  $f$ . Or allow a ray of light,  $gh$ , to fall thus on the crystal, it will in its passage through be separated into two rays,  $hf$ ,  $he$ ; and on coming to the opposite surface of the crystal, they will pass out at  $ef$  in the direction of  $ik$ , parallel to  $gh$ . The plane  $lmno$  is designated the principal section of the crystal, and the line drawn from the solid angle  $l$  to the angle  $o$  is where the axis of the crystal is contained; it is also the optic axis of the mineral. Now when a ray of light passes along this axis, it is undivided, and there is only one image; but in all other directions there are two.

If two crystals of Iceland spar be used, the only difference will be, that the objects seem farther apart, from the increased thickness. But if two crystals be placed with their principal sections at right angles to each other, the ordinary ray refracted in the first will be the extraordinary in the second, and so on *vice versa*. At the intermediate position of the two crystals there is a subdivision of each ray, and therefore four images are seen; when the crystals are at an angle of  $45^\circ$  to each other, then the images are all seen of equal intensity.

Mr. Nicol first succeeded in making rhombs of Iceland spar into *single-image prisms*, by dividing one into two equal portions. His mode of proceeding is thus described in the *Edinburgh Philosophical Journal* (vol. vi. p. 83):



"A rhomb of Iceland spar of one-fourth of an inch in length, and about four-eighths of an inch in breadth and thickness, is divided into two equal portions in a plane, passing through the acute lateral angle, and nearly touching the obtuse solid angle. The sectional plane of each of these halves must be carefully polished, and the portions cemented firmly with Canada balsam, so as to form a rhomb similar to what it was before its division; by this management the ordinary and extraordinary rays are so separated that only one of them is transmitted: the cause of this great divergence of the rays is considered to be owing to the action of the Canada balsam, the refractive index of which (1.549) is that between the ordinary (1.6543) and the extraordinary (1.4833) refraction of calcareous spar, and which will change the direction of both rays in an opposite manner before they enter the posterior half of the combination." The direction of rays

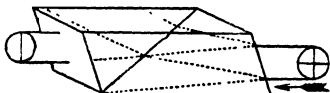

Fig. 82.

passing through such a prism is indicated by the arrow, fig. 82. and the combination is shown mounted, one for



Fig. 83

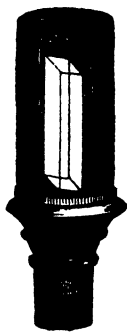

Fig. 83a.

use under the stage of the microscope, fig. 83, termed the *polariser*; another, fig. 83a. screwed on to and above the

object-glasses, is called the *analyser*. The definition is better if the analyser be placed at top of the *A* eye-piece, and it is more easily rotated than the polariser.

*Method of using the polarising Prism, fig. 83.*—After having adapted it to slide into a groove on the under-surface of the stage, it is held in its place by turning the small milled-head screw at one end: the other prism, fig. 83*a*, is screwed on above the object-glasses, and made to pass into the body of the microscope itself. The light having been reflected through them by the mirror, it becomes necessary to make the axes of the two prisms coincide; this is done by regulating the milled-head screw, until by revolving the *polarising prism*, the field of view is entirely darkened twice during one revolution. This should be ascertained, and carefully corrected by the maker and adapter of the apparatus. If very minute salts or crystals are to be viewed, it is preferable to place the analyser above the eye-piece; it will then require to be mounted as in fig. 84. Thus the *polariscope* consists of two parts; one for *polarising*, the other for *analysing* or testing the light. There is no essential difference between the two parts, except what convenience or economy may lead us to adopt; and either part, therefore, may be used as polariser or analyser; but whichever we use as the polariser, the other becomes the analyser.

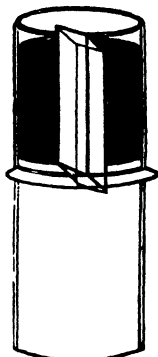

Fig. 84.

The *tourmaline*, a precious stone of a neutral or bluish tint, forms an excellent analyser; it should be cut about  $\frac{1}{20}$ th of an inch thick, and parallel to its axis. The great objection to it is, that the transmitted polarised beam is more or less coloured. The best tourmaline to choose is the one that stops the most light when its axis is at right angles to that of the polariser, and yet admits the most when in the same plane. It is necessary to choose the stone as perfect as possible, the size is of no importance when used with the microscope.

In the illumination of objects by polarised light, when under view with high powers, for the purpose of obtaining

the maximum effect, it is also requisite that the angle of aperture of the polariser should be the same as the object-glass, each ray of which should be directly opposed by a ray of polarised light. The *Polarising Condenser* is merely an ordinary achromatic condenser of large aperture, close under the bottom lens of which is placed a plate of tourmaline, used in combination with a superposed film of selenite or not, as required. The effect of this arrangement on some objects is very remarkable, bringing out strongly colours which are almost invisible by the usual mode.

The production of colour by polarised light has been thus most clearly and comprehensively explained by Mr. Woodward, in his "Introduction to the Study of Polarised Light."<sup>1</sup>

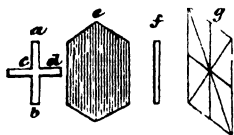

Fig. 85.

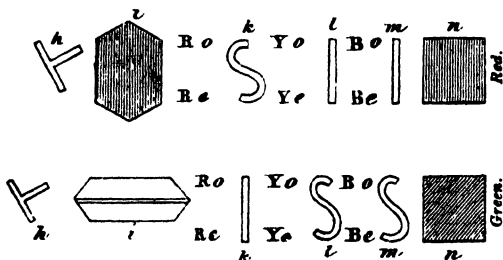

Fig. 85a

$a b c d$  represent the rectangular vibrations by which a ray of common light is supposed to be propagated.

$e$ , a plate of tourmaline, called in this situation the polariser, and so turned that  $a b$  may vibrate in the plane of its crystallographical axis.

(1) Mr. Woodward constructed a very available form of polariscope for most purposes; the instrument is described in *Elements of Natural Philosophy*, by Jabez Hogg.

*j*, light polarised by *e*, by stopping the vibrations *c d*, and transmitting those of *a b*.

*g*, a piece of selenite of such a thickness as to produce red light, and its complementary colour green.

*h*, the polarised light *f* bifurcated, or divided into ordinary and extraordinary rays, and thus said to be depolarised by the double refractor *g*, and forming two planes of polarised light, *o* and *e*, vibrating at right angles to each other.

*i*, a second plate of tourmaline, here called the analyser, with its axis in the same direction as that of *e*, through which the several systems of waves of the ordinary and extraordinary rays *h*, not being inclined at a greater angle to the axis of the analyser than that of 45 degrees, are transmitted and brought together under conditions that may produce interferences.

*k*, the waves *R o* and *R e*, for red light of the ordinary and extraordinary systems meeting in the same state of vibration, occasioned by a difference of an even number of half undulations, and thus forming a wave of doubled intensity for red light.

*l m*, the waves *Y o* and *Y e* and *B o* and *B e* for yellow and blue of the ordinary and extraordinary systems respectively meeting together, with a difference of an odd number of half undulations, and thus neutralising each other by interferences.

*n*, red light, the result of the coincidence of the waves for red light, and the neutralisation by interferences of those for yellow and blue respectively.

*h*, fig. 85*a*, depolarised light, as fig. 85.

*i*, the analyser turned one quarter of a circle, its axis being at right angles to that of *i* in fig. 85.

*k*, the waves *R o* *R e*, for red light of the ordinary and extraordinary systems meeting together with a difference of an odd number of half undulations, and thus neutralising each other by interference.

*l m*, the waves *Y o* *Y e* and *B o* *B e*, for yellow and blue of the two systems severally meeting together in the same state of vibration, occasioned by the difference of an even number of half undulations, and forming by their coincidences waves of doubled intensity for yellow and blue light.

is, green light, the result of the coincidences of the waves for yellow and blue light respectively, and the neutralisation by interference of those for red light.

By substituting Nicol's prisms for the two plates of tourmaline, and by the addition of the object-glass and eye-piece, the diagrams would then represent the passage of polarised light through a microscope.

For showing objects by polarised light under the microscope that are not in themselves doubly refractive, put upon the stage a film of selenite, which exhibits, under ordinary circumstances, the red ray in one position of the polarising prism, and the green ray in another, using a double-image prism over the eye-piece; each arc will assume one of these complementary colours, whilst the centre of the field will remain colourless. Into this field introduce any microscopic object which in the usual arrangement of the polariscope undergoes no change in colour, when it will immediately display the most brilliant effects. Sections of wood, feathers, algæ, and scales, are among the objects best suited for this kind of exhibition. The power suited for the purpose is a two-inch object-glass, the intensity of colour, as well as the separating power of the prism, being impaired under much higher amplification; although in some few instances, such as in viewing animalcules, the one-inch object-glass is perhaps to be preferred.

*Selenite* is the native crystallised hydrated sulphate of lime. A beautiful fibrous variety called *satin gypsum* is found in Derbyshire. It is found also at Shotover Hill, near Oxford, where the labourers call it *quarry-glass*. Very large crystals of it are found at Montmartre, near Paris. The form of the crystal most frequently met with is that of an oblique rectangular prism, with ten rhomboidal faces, two of which are much larger than the rest. It is usually slit into thin laminæ parallel to these large lateral faces; the film having a thickness of from one-twentieth to the one-sixtieth of an inch. In the two rectangular directions they allow perpendicular rays of polarised light to traverse them unchanged; these directions are called the *neutral axes*. In two other directions, however, which form respectively angles of  $45^\circ$  with the

neutral axes, these films have the property of double refraction. These directions are known as the *depolarising axes*.

The thickness of the film of selenite determines the particular tint. If, therefore, we use a film of irregular thickness, different colours are presented by the different thicknesses. These facts admit of very curious and beautiful illustration, when used under the object placed on the stage of the microscope. The films employed should be mounted between two glasses for protection. Some persons employ a large film mounted in this way between plates of glass, with a raised edge, to act as a stage for supporting the object, it is then called the "selenite stage." The best film for the microscope is that which gives blue, and its complementary colour yellow. Mr. Darker has constructed a very neat stage of brass for this purpose, producing a mixture of all the colours by superimposing three films, one on the other; by a slight variation in their positions, produced by means of an endless-screw motion, all the colours of the spectrum are shown. When objects are thus exhibited, we must bear in mind that all the negative tints, as we term them, are diminished, and all the positive ones increased; the effect of this plate is to mask the true character of the phenomena. Polarised structures should therefore never be drawn and coloured under such conditions.

Dr. Herapath, of Bristol, described a salt of quinine, which is remarkable for its polarising properties. The salt was first accidentally observed by Mr. Phelps, a pupil of Dr. Herapath's, in a bottle which contained a solution of disulphate of quinine: the salt is formed by dissolving disulphate of quinine in concentrated acetic acid, then warming the solution, and dropping into it carefully, and by small quantities at a time, a spirituous solution of iodine. On placing this mixture aside for some hours, brilliant plates of the new salt will be formed. The crystals of this salt, when examined by reflected light, have a brilliant emerald-green colour, with almost a metallic lustre; they appear like portions of the elytræ of cantharides, and are also very similar to murexide in appearance. When examined by transmitted light, they scarcely possess

any colour, there is only a slightly olive-green tinge; but if two crystals, crossing at right angles, be examined, the spot where they intersect appears perfectly black, even if the crystals are not one five-hundredth of an inch in thickness. If the light be in the slightest degree polarised—as by reflection from a cloud, or by the blue sky, or from the glass surface of the mirror of the microscope placed at the polarising angle  $56^{\circ} 45'$ —these little prisms immediately assume complementary colours: one appears green, and the other pink, and the part at which they cross is a chocolate or deep chestnut-brown, instead of black. As the result of a series of very elaborate experiments, Dr. Herapath finds that this salt possesses the properties of tourmaline in a very exalted degree, as well as of a plate of selenite; so that it combines the properties of polarising a ray and of depolarising it. Dr. Herapath has succeeded in making artificial tourmalines large enough to surmount the eye-piece of the microscope; so that all experiments with those crystals upon polarised light may be made without the tourmaline or Nicol's prism. The brilliancy of the colours is much more intense with the artificial crystal than when employing the natural tourmaline. As an analyser *above the eye-piece*, it offers some advantages over the Nicol's prism *in the same position*, as it gives a perfectly uniform tint of colour over a much more extensive field than can be had with the prism.<sup>1</sup> These crystals are liable to be injured by damp.

“The following experiments, if carefully performed, will illustrate the most striking phenomena of double refraction, and form a useful introduction to the practical application of this principle.

(1) Dr. Herapath subsequently furnished a better process for the manufacture of these artificial tourmalines, see *Quarterly Journal of Microscopical Science* for January, 1854. “These beautiful rosette crystals are made as follows:—Take a moderately strong solution of *Cinchonidine* in Herapath's test-fluid (as already described). A little of this is dropped on the centre of a slide and laid down for a time, until the first crystals are observed to be formed near the margin. The slide should now be placed upon the stage of the microscope, and the progress of formation of the crystals closely watched. When these are seen to be large enough, and it is deemed necessary to stop their further development, the slide must be quickly transferred to the palm of the hand, the warmth of which will be found sufficient to stop further crystallization.”

"A plate of brass, fig. 86, three inches by one, perforated with a series of holes from about one-sixteenth to one-

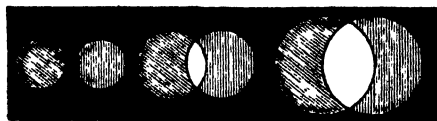

Fig. 86.—Red is represented by perpendicular lines; Green by oblique.

fourth of an inch in diameter; the size of the smallest should be in accordance with the power of the object-glass, and the separating power of the double refraction.

"*Experiment 1.*—Place the brass plate so that the smallest hole shall be in the centre of the stage of the instrument; employ a low power ( $1\frac{1}{2}$  or 2 inch) object-glass, and adjust the focus as for an ordinary microscopic object; place the double image prism over the eye-piece, and there will appear two distinct images; then, by revolving the prism, these will describe a circle, the circumference of which cuts the centre of the field of view; the one is called the ordinary, the other the extraordinary ray. By passing the slide along, that the larger orifices may appear in the field, the images will not be completely separated, but will overlap, as represented in the figure.

"*Experiment 2.*—Screw the Nicol's prism into its place under the stage, still retaining the double image prism over the eye-piece; then, by examining the object, there will appear in some positions two, but in others only one image; and it will be observed, that at  $90^\circ$  from the latter position this ray will be cut off, and that which was first observed will become visible; at  $180^\circ$ , or one-half the circle, an alternate change will take place; at  $270^\circ$ , another change; and at  $360^\circ$ , or the completion of the circle, the original appearance.

"Before proceeding to the next experiment, it will be as well to observe the position of the Nicol's prism, which should be adjusted with its angles parallel to the square parts of the stage. In order to secure the greatest brilliancy in the experiment, the proper relative position of the selenite may be determined by noticing the natural



flaws in the film, which will be observed to run parallel with each other; these flaws should be adjusted at about  $46^\circ$  from the square parts of the stage, to obtain the greatest amount of depolarisation.

*Experiment 3.*—If we now take the plate of selenite thus prepared, and place it under the piece of brass on the stage, we shall see, instead of the alternate black and white images, two coloured images composed of the constituents of white light, which will alternately change by revolving the eye-piece at every quarter of the circle; then, by passing along the brass, the images will overlap; and at the point at which they do so, white light will be produced. If, by accident, the prism be placed at an angle of  $45^\circ$  from the square part of the stage, no particular colour will be perceived; and it will then illustrate the phenomena of the neutral axis of the selenite, because when placed in that relative position no depolarisation takes place. The phenomena of polarised light may be further illustrated by the addition of a second double image prism, and a film of selenite adapted between the two. The systems of coloured rings in crystals cut perpendicularly to the principal axis of the crystal are best seen by employing the lowest object-glass."

To show the phenomena of the rings round the optic axes of the crystals, the following plan, which is by far the best, must be followed, and the rings will appear in perfection:—

1. The B eye-piece without a diaphragm, and the lens ~~so~~ adjusted that the field-lens may be brought nearer to, or farther from the eye-lens as occasion may require; thus giving different powers, and different fields, and when adjusted for the largest field it will be full 15 inches, and take in the widest separation of the axis of the aragonite.

2. A crystal stage to receive the crystals, and to be placed over the eye-piece, so constructed as to receive a tourmaline, and that to turn round.

3. A tourmaline of a blue tint.

4. A large Nicol's prism as a polariser.

5. A common two-inch lens, not achromatic; which **must be set in a brass tube long enough when screwed into**

the microscope to reach the polariser, that all extraneous light may be excluded.

The concave mirror should be used with a bull's-eye condenser by lamplight. The condenser may be dispensed with by daylight. The above apparatus is furnished by Messrs. Powell and Lealand.

The crystals best adapted to show the phenomena of rings round the optic axes, are:—

*Quartz.*—A uniaxial crystal, one system of rings, no entire cross of black, only the ends of it, the centre being coloured, and as the tourmaline is revolved, the colour gradually changing into all the colours of the spectrum, one colour only displayed at once.

*Quartz.*—Cut so as to exhibit right-handed polarisation.

*Quartz.*—Cut so as to exhibit left-handed polarisation; that is, the one shows the same phenomena when the tourmaline is turned to the right, as the other does when turned to the left.

*Quartz.*—Cut so as to exhibit straight lines.

*Calc Spar.*—A uniaxial crystal, one system of rings, and a black cross, which changes into a white cross on revolving the tourmaline, and the colours of the rings into their complementary colours.

*Topaz.*—A biaxial crystal, although it has two axes, only exhibits one system of rings with one fringe, owing to the wide separation of the axes. The fringe and colours change on revolving the tourmaline; this is the case in all the crystals.

*Borax.*—A biaxial crystal; the colours more intense than in topaz, but the rings not so complete,—only one set of rings taken in, from the same cause as topaz.

*Rochelle Salt.*—A biaxial crystal; the colours more widely spread. Very beautiful. Only one set of rings taken in

*Carbonate of Lead.*—A biaxial crystal, axes not much separated, both systems of rings exhibited, far more widely spread than those of nitre.

*Aragonite.*—A biaxial crystal, axes widely separated; but both systems of rings exhibited, and decidedly the best crystal for displaying the phenomena of biaxial crystals.

The field-lens of the eye-piece requires to be brought as

close as possible to the eye-lens, to see properly the phenomena in quartz and aragonite; it must be placed at an intermediate distance for viewing topaz, borax, Rochelle salt, and carbonate of lead; it must be drawn out to its full extent to view nitre and calc spar.

It was long believed that all crystals had only one axis of double refraction; but Brewster found that the great body of crystals, which are either formed by art, or which occur in the mineral kingdom, have *two axes* of double refraction, or rather axes around which the double refraction takes place; in the axes themselves there is no double refraction.

Nitre crystallises in six-sided prisms with angles of

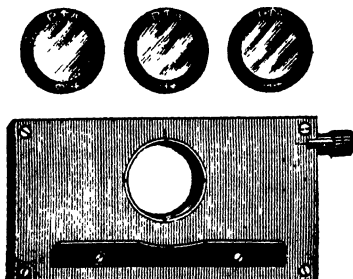

FIG 87.—Darker's Selenite Films and Stage.

about  $120^\circ$ . It has two axes of double refraction, along which a ray of light is not divided into two. These axes are each inclined about  $2\frac{1}{2}^\circ$  to the axes of the prism, and  $5^\circ$  to each other. If, therefore, we cut off a piece from a prism of nitre with a knife driven by a smart blow of a hammer, and polish the two surfaces perpendicular to the axes of the prism, so as to leave the thickness of the sixth or eighth of an inch, and then transmit a ray of polarised light along the axes of the prism, we shall see the double system of rings shown in figs. 88 and 88a.

When the line connecting the two axes of the crystal is inclined  $45^\circ$  to the plane of primitive polarisation, a cross is seen as at fig. 88; on revolving the nitre, it gradually

assumes the form of the two hyperbolic curves, fig 88a. But if the tourmaline be revolved, the black crossed lines will

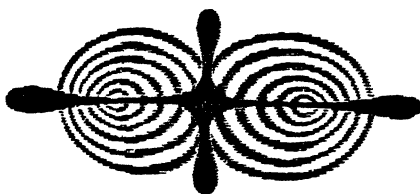

Fig. 88



Fig. 88a.

be replaced by white spaces, and the red rings by green, the yellow by indigo, and so on. These systems of rings have, generally speaking, the same colours as those of thin plates, or as those of a system of rings round one axis. The orders of the colours commence at the centres of each system; but at a certain distance, which corresponds to the sixth ring, the rings, instead of returning and encircling each pole, encircle the two poles as an ellipse does its two foci. When we diminish or increase the thickness of the plate of *nitre*, the rings are diminished or increased accordingly.

Small specimens of salts may also be crystallised and mounted in Canada balsam for viewing under the stage of the microscope; by arresting the crystallisation at certain stages, a greater variety of forms and colours will be obtained: we may enumerate salicine, asparagine, acetate of copper, phospho-borate of soda, sugar, carbonate of lime, chlorate of potassa, oxalic acid, and all the oxalates found in urine, with the other salts from the same fluid, a few of which are shown at fig. 89.

Dr. W. B. Herapath contributed an interesting addition to the uses of polarised light, by applying it to discover the salts of alkaloids, quinine, &c. in the urine of patients.

He says : " It has long been a favourite subject of inquiry with the professional man to trace the course of remedies

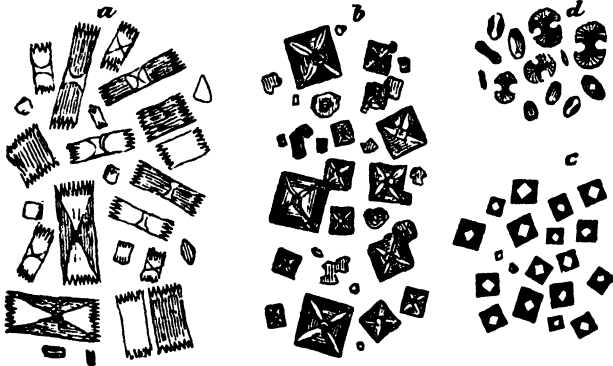

Fig. 89. — Urinary Salts.

*a*, Uric acid; *b*, Oxalate of lime, octahedral crystals of; *c*, Oxalate of lime allowed to dry, forming a black cube; *d*, Oxalate of lime, as it occasionally appears, termed the dumb-bell crystal.

in the system of the patient under his care, and to know what has become of the various substances which he might have administered during the treatment of the disease.

" Having been struck with the facility of application, and the extreme delicacy of the reaction of polarised light, when going through the series of experiments upon the sulphate of iodo-quinine, I determined upon attempting to bring this method practically into use for the detection of minute quantities of quinine in organic fluids; and after more or less success by different methods of experimenting. I have at length discovered a process by which it is possible to obtain demonstrative evidence of the presence of quinine, even if in quantities not exceeding the one-millionth part of a grain; in fact, in quantities so exceedingly minute, that all other methods would fail in recognising its existence. Take for *test-fluid* a mixture of three drachms of pure acetic acid, with one fluid-drachm of rectified spirits-of-wine, to which add six drops of diluted sulphuric acid

" One drop of this test-fluid placed on a glass-slide, and the merest atom of the alkaloid added, in a short time

solution will take place ; then, upon the tip of a very fine glass-rod let an extremely minute drop of the alcoholic solution of iodine be added. The first effect is the production of the yellow or cinnamon-coloured compound of iodine and quinine, which forms as a small circular spot ; the alcohol separates in little drops, which by a sort of repulsive movement, drive the fluid away ; after a time, the acid liquid again flows over the spot, and the polarising crystals of sulphate of iodo-quinine are slowly produced in beautiful rosettes. This succeeds best without the aid of heat.

“To render these crystals evident, it merely remains to bring the glass-slide upon the field of the microscope, with the selenite stage and single tourmaline, or Nicol’s prism, beneath it ; instantly the crystals assume the two complementary colours of the stage ; red and green, supposing that the pink stage is employed, or blue and yellow, provided the blue selenite is made use of. All those crystals at right angles to the plane of the tourmaline, producing

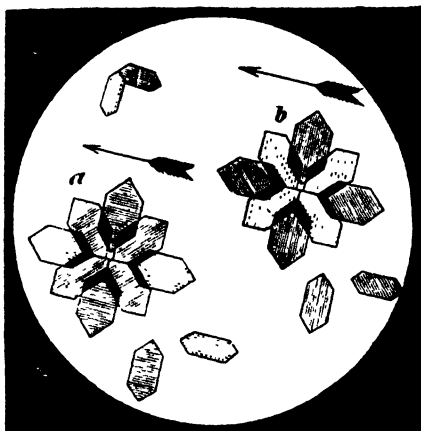

FIG 90.—In this figure heraldic lines are adopted to denote colour. The dotted parts indicate *yellow*, the straight lines *red*, the horizontal lines *blue*, and the diagonal, or oblique lines, *green*. The arrows show the plane of the tourmaline, *a*, blue stage ; *b*, red stage of selenite employed.

that tint which an analysing-plate of tourmaline would produce when at right angles to the polarising-plate ;

whilst those at  $90^\circ$  to these educe the complementary tint, as the analysing-plate would also have done if revolved through an arc of  $90^\circ$ .

"This test is so ready of application, and so delicate, that it must become *the test, par excellence*, for quinine: fig. 90, *a* and *b*. Not only do these peculiar crystals act in the way just related, but they may be easily proved to possess the whole of the optical properties of that remarkable salt of quinine, the sulphate of iodo-quinine.

"To test for quinidine, it is merely necessary to allow the drop of acid solution to evaporate to dryness upon the slide, and to examine the crystalline mass by two tourmalines, crossed at right angles, and without the stage. Immediately little circular discs of white, with a well-defined black cross very vividly shown, start into existence, should quinidine be present even in very minute traces. These crystals are represented in fig. 91.

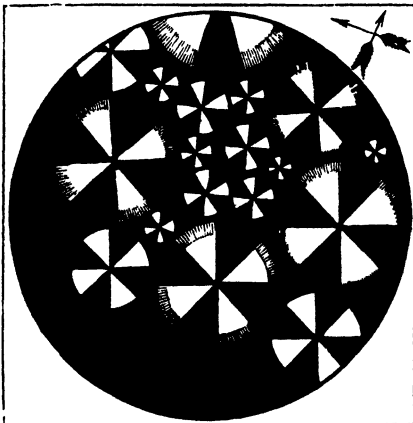

Fig. 91.

"If we employ the selenite stage in the examination of this object, we obtain one of the most gorgeous appearances in the whole domain of the polarising-microscope: the black cross at once disappears, and is replaced by one which consists of two colours, being divided into a cross

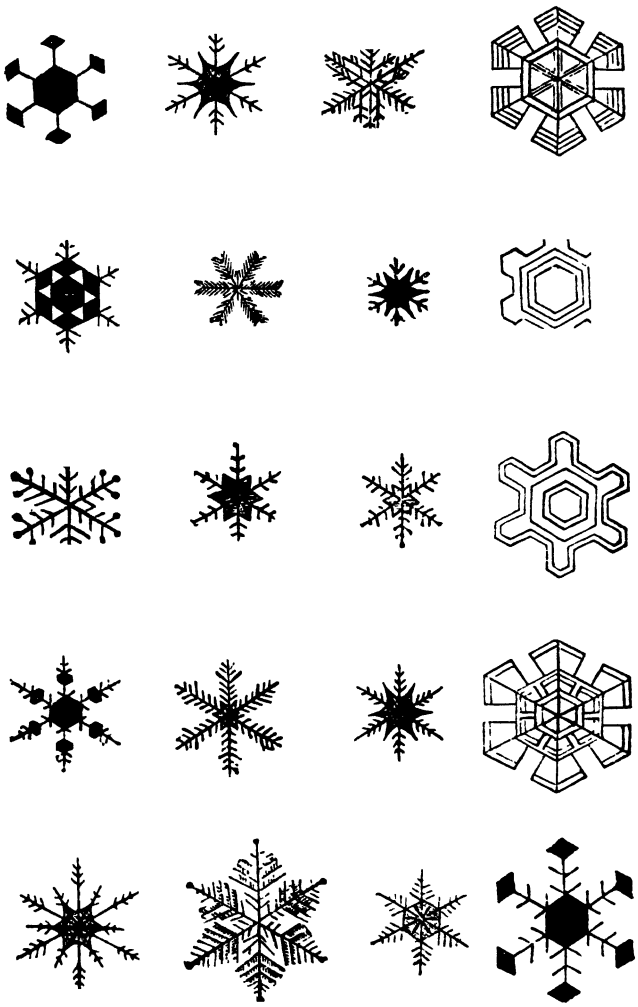

Fig. 92 — Snow Crystals.



having a red and green fringe, whilst the four intermediate sectors are of a gorgeous orange-yellow. These appearances alter upon the revolution of the analysing-plate of tourmaline; when the blue stage is employed, the cross will assume a blue or yellow tint, according to the position of the analysing-plate. These phenomena are analogous to those exhibited by certain circular crystals of boracic acid, and to those circular discs of salicine (prepared by fusion); the difference being, that the salts of quinidine have more intense depolarising powers than either of the other substances; besides which, the mode of preparation effectually excludes these from consideration. Quinine prepared in the same manner as quinidine has a very different mode of crystallisation; but it occasionally presents circular corneous plates, also exhibiting the black cross and white sectors, but not with one-tenth part of the brilliancy, which of course enables us readily to discriminate the two."

Ice doubly refracts, while water singly refracts. Ice takes the rhomboidic form; and snow in its crystalline form may be regarded as the skeleton crystals of this system. A sheet of clear ice, of about one inch thick, and slowly formed in still weather, will show the circular rings and cross if viewed by polarised light.

It is probable that the conditions of snow formation are more complex than might be imagined, familiar as we are with the conditions relating to the crystallisation of water on the earth's surface. Dr. Smallwood, of Isle Jesus, Canada East, has traced an apparent connection between the form of the compound varieties of snow crystals and the electrical condition of the atmosphere, whether negative or positive; and is instituting experiments for his better information on the subject.

A great variety of animal, vegetable, and other substances possess a doubly refracting or depolarising structure, as: a quill cut and laid out flat on glass; the cornea of a sheep's eye; skin, hair, a thin section of a finger-nail; sections of bone, teeth, horn, silk, cotton, whalebone; stems of plants containing silica or flint; barley, wheat, &c. The larger-grained starches form splendid objects: *tousses-mois*, being the largest, may be taken as a type of all

the others. It presents a black cross, the meet at the hilum. On rotating the arms of which

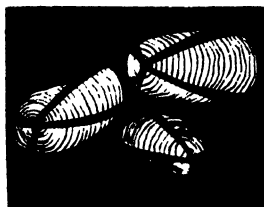

Fig. 98.

*Potato Starch, seen under polarised light.*

black cross disappears, the at  $90^\circ$  is replaced by arms, and cross; another, but white fainter black cross being perceived between the arms of the white cross. Hitherto; however, no colour is perceptible. But if a thin plate of selenite be interposed between the starch-grains and the polariser, most splendid and delicate colours appear. All

the colours change by revolving the analyser, and become complementary at every quadrant of the circle. West and East India arrow-root, sago, tapioca, and many other starch-grains, present a similar appearance; but in proportion as the grains are smaller, so are their markings and colourings less distinct.

“The application of this modification of light to the illumination of very minute structures has not yet been fully carried out; but still there is no test of differences in density between any two or more parts of the same substance that can at all approach it in delicacy. All structures, therefore, belonging either to the animal, vegetable, or mineral kingdom, in which the power of unequal or double refraction is suspected to be present, are those that should especially be investigated by polarized light. Some of the most delicate of the elementary tissues of animal, such as the tubes of nerves, the ultimate fibrillæ of muscles, &c., are amongst the most striking subjects that may be studied with advantage under this method of illumination. Every structure that the microscopist is investigating should be examined by this light, as well as by that either transmitted or reflected. Objects mounted in Canada balsam, that are far too delicate to exhibit any structure under transmitted, will often be well seen under polarised light; its uses, therefore, are manifold.”<sup>1</sup>

(1) Quekett's *Practical Treatise on the Use of the Microscope*.

having a red rotation.—For the purpose of studying sectors and interesting phenomena of molecular rotation, and necessary pieces of apparatus must be added to the microscope. First, an ordinary iron three-armed stand, to the lower arm of which must be attached either a polarising prism or a bundle of glass plates inclined at the polarising angle. In the upper arm is placed an analysing prism. The fluid to be examined should be contained in a narrow glass tube about eight inches in height, and this must be attached to the middle arm. If the prisms be crossed before inserting a fluid, possessing rotatory power, the light passing through the analyser will be coloured. If a solution of sugar be employed, and the light which passes through the second prism is seen to be red, but on rotating the analyser towards the right, the colour changes to yellow, and passes through green to violet, it may be concluded that the rotation is right-handed. If, on the contrary, the analyser requires to be turned towards the left hand, we conclude that the polarisation is left-handed. These phenomena are wholly distinct from those accompanying the action of doubly refracting substances upon plane polarised light. It is not easy to explain in a limited space the course to be followed in ascertaining the amount of rotation produced by different substances. Monochromatic light should be used. If we are about to examine a sugar solution with the prisms crossed, the index attached to the analyser must first be made to point to zero. The sugar is then introduced, when it will be necessary to rotate the analyser  $23^\circ$  to the right, in order that the light may be extinguished. This is the amount of rotation for that particular fluid at a given density and that height of column. As the arc varies with increase or decrease of density and height of the fluid, it is needful to reduce it to a unit of height and density. The following formula is that given by Biot:— $P =$  quantity of matter in a unit of solution;  $d =$  sp. gr.;  $l =$  length of column;  $a =$  arc of rotation;  $m =$  molecular rotation. Then  $m = \frac{a}{l p d}$ .

A fine effect may be obtained by using Furze's spotted lens, with a Herapathite polariser; see *Mic. Soc. Trans.* 2d series. vol. iii. p. 63.

#### APPLICATION OF PHOTOGRAPHY TO THE MICROSCOPE.

At the time this book was projected, it was thought that if the objects so beautifully exhibited under the microscope could be drawn by light on the page of the book, or on the wood-blocks, so that the engraver might work directly from the drawings thus made, truthfulness would be insured, and we should present to the reader a valuable record of microscopic research never before seen or attempted. But in this we were doomed to disappointment by the existence of a patent, which presented obstacles too great to be surmounted; and the idea was abandoned, with the exception of a few drawings then prepared, and ready to hand: the patent restrictions having been since removed, we have embodied them in our pages. The eye and feet of fly, antenna of moth, paddles of whirligig, with a few others, were first taken on a film of collodion, then floated off the glass on to the surface of a block of wood, the wood having been previously and lightly inked with printer's ink or amber-varnish, and the film gently rubbed or smoothed down to an even surface, at the same time carefully pressing out all bubbles of air or fluid.

For the purposes of photography the only necessary addition to the ordinary microscope is that of a dark chamber; it should indeed form a camera obscura, having at one end an aperture for the insertion of the eye-piece end of the microscopic tube, and at the other a groove for carrying the crown-glass for focussing. This dark chamber must not exceed eighteen inches in length; for if longer, the pencil of light transmitted by the object-glass is diffused over too large a surface, and a faint and unsatisfactory picture results therefrom. Another advantage is, that pictures at this distance are in size very nearly equal to the object seen in the microscope. In some instances, better pictures are produced by taking away the eye-piece

of the microscope altogether. The time of producing the picture varies from five to twenty seconds, with the strength of the daylight. A camphine lamp, light Cannel coal-gas, or the lime-light, will enable a good manipulator to produce pictures nearly equal to those produced by sun-light. Collodion offers the best medium, as a strong negative can be made to produce any number of printed positives.

The light is transmitted from the mirror through the object and lenses, and brought to a focus on the ground-glass, or prepared surface of collodion, in the usual manner. Care must be taken not to use the burning focus of the lenses. The gas microscope may be used to make an enlarged copy of an object, it is only necessary to pin up against the screen a piece of prepared calotype paper to receive the reflected image. Mr. Wenham gives directions for improving "microscopic photography" in the *Quarterly Journal of Microscopical Science* for January, 1855. In this paper he has shown how to insure quick and accurate focussing; or, in other words, the making of the *actinic* and *visual* foci of the objective coincident. The simplest and cheapest way of producing coincidence is to screw a biconvex lens into the place of the back-stop of the object-glass, which thus acts as part of its optical combination. An ordinary spectacle lens, carefully centred and turned down to the required size, answers the purpose exceedingly well.

An excellent method has been proposed and adopted by Mr. Wenham, for exhibiting the form of certain very minute markings upon objects. A negative photographic impression of the object is first taken on collodion, in the ordinary way, with the highest power of the microscope that can be used. After this has been properly fixed, it is placed in the sliding frame of an ordinary camera, and the frame end of the latter adjusted into an opening cut in the shutter of a perfectly dark room. Parallel rays of sunlight are then thrown through the picture by means of a flat piece of looking-glass fixed outside the shutter at such an angle as to catch and reflect the rays through the camera. A screen standing in the room, opposite the lens of the camera, will now receive an image, exactly as from a magic lantern, and the size of the image will be propor,

tionate to the distance. On this screen is placed a sheet of photogenic paper intended to receive the magnified picture. We ought to add, however, that it requires considerable practice to avoid the distortion and error of definition occasioned by a want of coincidence in the chemical and visual foci. Imperfections are much increased when the highest powers of the microscope are employed; false notions of structure are also given, which is the case in Mr. Wenham's photograph of *P. Angulatum*.

Mr. S. Highley has a mode of adapting an object-glass to the ordinary camera, for the purpose of taking microscopic objects on collodion and other surfaces, fig. 94; a sectional view of his arrangement is here given, which is

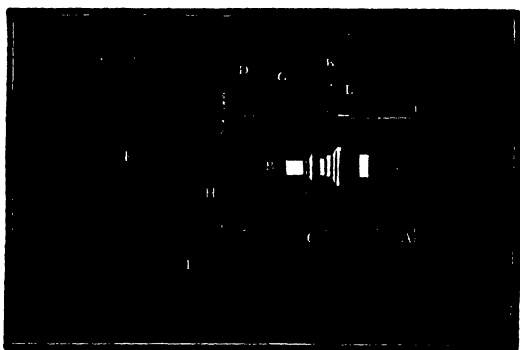

Fig. 94. —Highley's Camera.

very compact, steady, and ever ready for immediate use. The tube A screws into the flange of a camera which has a range of twenty-four inches; the front of this tube is closed, and into it screws the object-glass B. Over A slides another tube C; this is closed by a plate, D, which extends beyond the upper and lower circumference of C, and carries a small tube, E, on which the mirror F is adjusted. To the upper part of D the fine adjustment G is attached; this consists of a spring-wire coil acting on an inner tube, to which the stage-plate H is fixed, and is regulated by a graduated head, K, acting on a fine screw, likewise attached to

the stage-plate, after the manner of Oberhauser's microscopes. An index *L* is affixed opposite the graduated head *K*. The stage and clamp slides vertically on *H*; and by sliding this up or down, and the glass object-slide horizontally, the requisite amount of movement is obtained to bring the object into the field. The object being brought into view, the image is roughly adjusted on the focussing-glass by sliding *C* on *A*; the focussing is completed by aid of the fine adjustments *G* *K*, and allowance then made for the amount of non-coincidence between the chemical and visual foci of the object-glass. The difference in each glass employed should be ascertained by experiment in the first instance, and then noted. By employing a finely-ground focussing-glass greased with oil, this arrangement forms an agreeable method of viewing microscopical objects with both eyes, and is less fatiguing. As a very large field is presented to the observer, this arrangement might be advantageously employed for class demonstration.

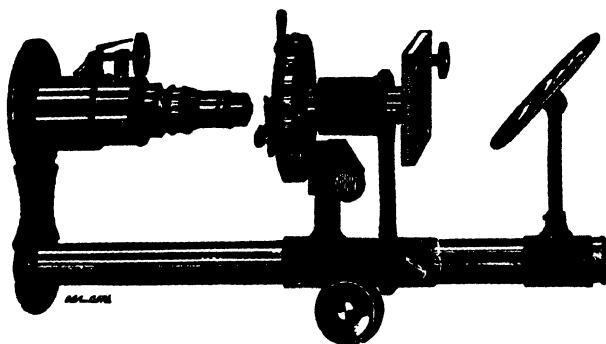

Fig. 95.—Highley's Photo-micrographic A-arrangement.

This arrangement combines the most recent improvements of Dr. Maddox, and consists of a lens-carrier with ordinary adjustments; stage with gymbal motions so as to bring any object parallel to the surface of the object-glass; bright ground illuminator, graduating diaphragm; and a speculum reflector for giving the light from a single surface.

Professor Draper employed the following form of lantern for microphotography:—*a* is a zirconia light rendered incandescent by the mixed gases; *b b* a very short condensing lens; *c* the stage or support carrying the object to be photographed; *d* the projecting lens, formed of three sets of lenses, and giving a flat rectilinear field; *a*, *c*, *d* are mounted on a base board, *e, f*, to the end of which the lantern box *a b* is attached, and which is freely opened above and below for perfect ventilation. The lateral grooves *a*, *c*, *d* slide and allow of an adjusting movement by the screw *r*, and by means of which the change of distance between *a* and *c* admits of a correct focus being obtained. By means of the hinge at *h* the whole can be adjusted at any angle.

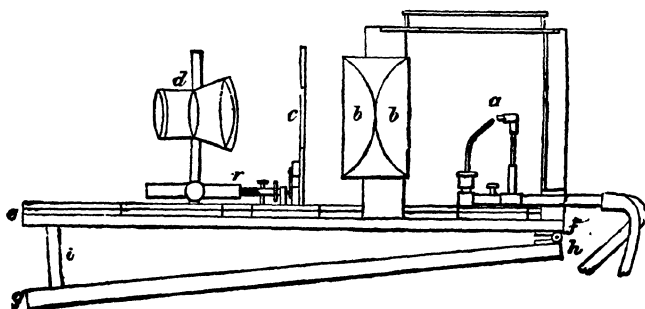
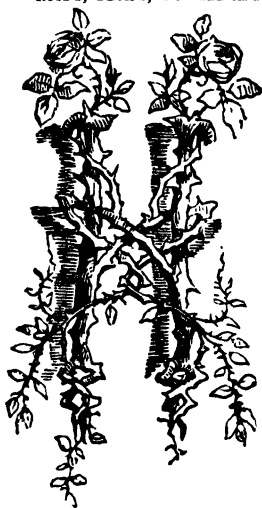

FIG. 95a.—*Draper's Microphotographic Apparatus.*



## CHAPTER III.

RELIMINARY DIRECTIONS—ILLUMINATION—ACCESSORY APPARATUS—GILLETT'S, ROSS'S, BECK'S, POWELL AND LEALAND'S, AND OTHER CONDENSERS—THE LIEBERKUHN—SIDE REFLECTOR—LAMP—OBJECT FINDER—COLLECTING STICK—ANIMALCULE CAGE—SECTION CUTTER—PREPARING AND MOUNTING OBJECTS—DOUBLE STARRING, ETC.



HAVING selected an apartment with a northern aspect, and, if possible, with only one window, and that not overshadowed by trees or buildings—in such a room, on a firm, steady table, keep your instruments and apparatus open, and at all times ready for observation. A large bell-glass will be found most convenient for keeping dust from the microscope when set up for use. In winter it will be proper to slightly warm the instrument before using it,

otherwise the perspiration from the eye will condense on the eye-glass, and obscure vision.

*Management of the Microscope.*—Should the microscope not have been used for some time, dust and moisture will in all probability collect and settle on the eye-piece. The foggy atmosphere of large towns may insinuate itself into the interior of the objective. In such cases, dust and moisture can only be removed by gently wiping the glasses with a piece of soft, well-used chamois leather. When necessary to clean the eye-piece, unscrew one glass at a time and replace it before removing another. The objective can only

be unscrewed, or tampered with, at the risk of damaging the cement which binds the lenses together. If the objective be an immersion, carefully wipe off the fluid from the front lens as soon as it is done with, for even distilled water will leave a stain behind.

When looking through the eye-piece be sure to place the eye close to the lens, otherwise the whole field will not be perfectly visible; it should appear as an equally well-illuminated circular disc. The position of the observer should be easy and comfortable, and the microscope inclined to an agreeable working angle. This will prevent fatigue and congestion of the eyes, the first indication of which is small bodies moving about or floating before them. If the eyelashes are reflected from the eye-glass, the observer is looking upon the eye-piece, and not through it. For the examination of transparent mounted objects, it is simply necessary to place them upon the stage of the microscope, and throw light from the concave mirror through them. The distance at which the mirror should be set depends upon the source whence the illumination is derived, and whether it be daylight or lamp-light. The stem which carries the mirror is generally so arranged as to be capable of elongation. The working focal distance of the mirror is that which brings the images of the window bars sharply out upon the glass slip or object resting upon the stage. In other words, the focus of the mirror is that which brings parallel rays to a correct focus on the object-glass. If employing artificial light, then the flame of the lamp should be distinguishable; a slight change in the inclination of the mirror will be required to throw the image of the lamp-flame out of the field.

A good illumination having been obtained, the diaphragm must be brought into use to regulate the amount of light. The more transparent the object, the less light will it require to display it properly. Some microscopists carefully tone down the light, by interposing a piece of monochromatic glass, or a fluid medium, a weak solution of sulphate of copper, between the light and the object. The best artificial source

of illumination is the steady flame of a paraffin lamp, with a flat wick (fig. 96). Collins's Bocket Lamp, with bull's-eye condenser mounted on a stem, so as to be adjustable at any height, is a suitable form of lamp. Whatever be the source of light, the objects should on no account be over-illuminated: a flood of light mars the image, and spoils the performance of the object-glass.

For viewing opaque objects, or whole insects, the eletra of a beetle, etc., the light must be thrown down or condensed upon it, by the condensing or bull's-eye lens; or by Beck's parabolic side-silver reflector, placed at a proper angle to the source of illumination.

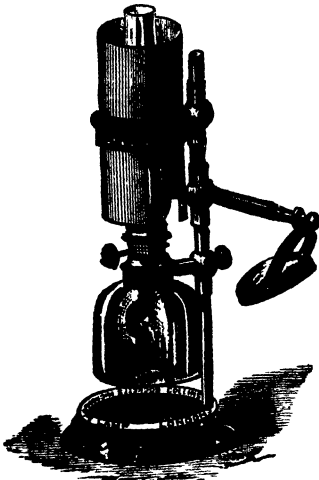

FIG. 96.—Collins's Bocket Lamp

For examining partially opaque minute objects, as the Podura-scale, under high-power magnification, the vertical illuminator is useful. If the object is a small portion of a dissected animal or plant, or a pathological specimen in a fluid medium, the microscope should be employed in the vertical or upright position. The object

should be covered with a thin cover-glass, to prevent the escape of the fluid, which, should it run over, might damage the stage and its mechanical movements.

*Test for Illumination.*—Dr. C. Seiler recommends the human blood corpuscle as the best test of good illumination. He prepares the object in the following manner:—Take for the purpose a clean glass slide of the ordinary kind, and place near its extreme edge a drop of fresh blood drawn by pricking the finger with a needle. Then take another slide of the same size, with

ground edges, and bring one end in contact with the drop of blood, as shown in fig. 97, at an angle of  $45^\circ$ ; then draw it evenly and quickly across the under-slide, and the result will be to spread out the corpuscles evenly throughout. The blood discs being lenticular bodies, with depressed centres, act like so many little glass-lenses, and show diffraction rings if the light is not properly adjusted. In the *Journal of the Royal Microscopical Society*, page 542, vol. iv., Dr. Seiler fully describes the arrangement of the lamp, condenser, and mirror.

*Errors of Interpretation.*—To be in a position to draw accurate conclusions of the nature and properties of the object under examination is a matter of the greatest importance to the microscopist. The viewing of objects by

transmitted light is quite of an exceptional character, much calculated to mislead the judgment as well as the eye.

It requires, therefore, an unusual

amount of care to avoid falling into errors of interpretation. There are perhaps no set of objects with which I have become acquainted, and which have given rise to more discussion as to the precise nature of their structural elements than those of certain of the diatomaceæ. The minute scales of the *Podura* (*Lepidocyrtus cervicollis*) and their congeners *Lepisma saccharina* are equally debatable. Mr. R. Beck, in an instructive paper published in the *Transactions of the Royal Microscopical Society*, says that the scales of the latter can be made to put on an appearance which bears little resemblance to their actual structure.

On the more abundant kind of scales the prominent markings appear as a series of double lines, these run parallel and at considerable intervals from end to end of the scale, whilst other lines, generally much fainter,

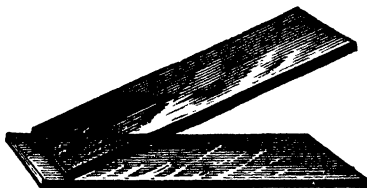

FIG. 97.—Seiler's Test-slide.

radiate from the quill, and take the same direction as the outline of the scale when near the fixed or quill end; but there is, in addition, an interrupted appearance at the sides of the scale which is very different from the mere union, or 'cross-hatchings,' of the two sets of lines. (Fig 98, Nos. 1 and 2, the upper portions.)

The scales themselves are formed of some truly transparent substance, for water instantly and almost entirely obliterates their markings, but they reappear

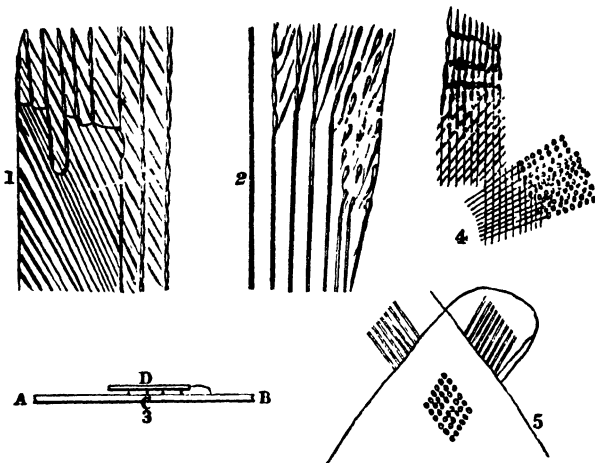

FIG. 98.—Portions of Scales of *Lepisma*, after Beck.

unaltered as the moisture leaves them; therefore the fact of their being visible at all, under any circumstances, is due to the refraction of light by superficial irregularities, and the following experiment establishes this fact, whilst it determines at the same time the structure of each side of the scale, a matter which it is impossible to do from the appearance of the markings in their unaltered state:—

“Remove some of the scales by pressing a clean and dry slide against the body of the insect, and cover them with a piece of thin glass, which may be pre-

vented from moving by a little paste at each corner. No. 3 may then be taken as an exaggerated section of the various parts. *AB* is the glass slide, with a scale, *C*, closely adherent to it, and *D* the thin glass-cover. If a very small drop of water be placed at the edge of the thin glass, it will run under by capillary attraction; but when it reaches the scale, *C*, it will run first between it and the glass slide *AB*, because the attraction there will be greater, and consequently the markings on that side of the scale which is in contact with the slide will be obliterated, while those on the other side will, for some time at least, remain unaltered: when such is the case, the strongly marked vertical lines disappear, and the radiating ones become continuous. (See No. 1, the lower left-hand portion.) To try the same experiment with the other, or inner surface of the scales, it is only requisite to transfer them, by pressing the first piece of glass, by which they were taken from the insect, upon another piece, and then the same process as before may be repeated with the scales that have adhered to the second slide; the radiating lines will now disappear, and the vertical ones become continuous. (See No. 2, left portion.) These results, therefore, show that the interrupted appearance is produced by two sets of uninterrupted lines on different surfaces, the lines in each instance being caused by corrugations or folds on the external surfaces of the scales. Nos. 1 and 2 are parts of a camera lucida drawing of a scale which happened to have the opposite surfaces obliterated in different parts. No. 4 shows parts of a small scale in a dry and natural state; at the upper part the interrupted appearance is not much unlike that seen at the sides of the larger scales, but lower down, where lines of equal strength cross nearly at right angles, the lines are entirely lost in a series of dots, and exactly the same appearance is shown in No. 5 to be produced by two scales at a part where they overlie each other, although each one separately shows only parallel vertical lines."

Another very characteristic fallacy resulting from configuration is furnished in the supposed tubular

structure of human hair. When we view this object by transmitted light, it presents the appearance of a flattened band with a darkish centre; this, however, is entirely due to the convergence of the rays of light produced by the convexity of the surface of the hair. That it is a solid structure is proved by making a transverse section of the hair-shaft, when it is seen quite filled by medullary substance, with the centre somewhat darker than the other part. It is, in fact, a spiral outgrowth of epithelial scales, overlapping each other like tiles on a house-top, which impart a striated appearance to the surface. A cylindrical thread of glass in balsam appears as a flattened, band-like streak, of little brilliancy. Another instance of fallacy arising from diversity in the refractive power of the internal parts of an object, is furnished by the mistakes formerly made with regard to the true character of the *lacunæ* and *canaliculi* of bone structure, which were long supposed to be solid corpuscles, with radiating opaque filaments proceeding from a dense centre; on the contrary, they are minute chambers, with diverging passages, excavations in the solid osseous substance. That such is the case, is shown by the effects of Canada balsam, which infiltrates the osseous substance.

The molecular movements of finely divided particles, seen in nearly all cases when certain objects are first suspended in water, or other fluids, is another source of embarrassment to beginners. If a minute portion of indigo or carmine be rubbed up with a little water, and a drop placed on a glass slide under the microscope, it will at once exhibit a peculiar *perpetual motion* appearance. This movement was first observed in the granular particles seen among pollen grains of plants, known as *fovilla*, and which are set free when the pollen is crushed. Important vital endowments were formerly attributed to these particles, but Dr. Robert Brown showed that such granules were common enough both in organic and inorganic substances, and were in no way "indicative of life."

*Accessory Apparatus.*—In the more perfectly furnished instruments, a number of accessory pieces of apparatus

are usually included, many of which are essentially necessary for the prosecution of microscopical pursuits and for the perfect examination of most objects.

The *Diaphragm*, fig. 99, is a circular plate with a series of circular apertures cut in it. In fact, there

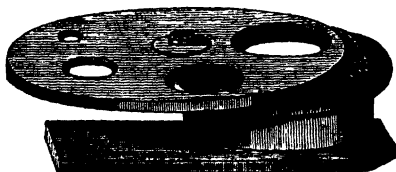

FIG. 99.—*The Diaphragm.*

are two plates of brass, one being perforated with four or five holes of different sizes, and arranged to revolve upon another plate by a central pin or axis, the last being also provided with a hole as large as the largest in the diaphragm-plate, and corresponding in situation to the axis of the compound body. The holes

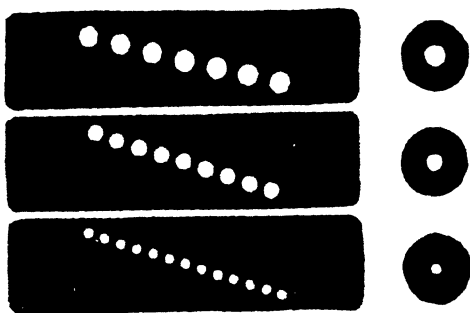

FIG. 100.—*Dr. Anthony's Stage Diaphragm.*

in the diaphragm-plate are centred and retained by a bent spring that fits into the second plate, which rubs against the edge of the diaphragm-plate and catches in a notch. The blank space shuts off the light from the mirror when condensed light is used. It is impossible to dispense with the use of the diaphragm,



as without it the transmitted rays would in many cases produce confusion of the image. Dr. Anthony advocates the use of a stage-diaphragm, and which consists, as seen in fig. 100, of three slips of smooth blackened cardboard or vellum with perforations, any of which can be brought into the centre and clamped, and retained in its place under the glass slip. The larger perforated discs form an additional slide; while various other forms, slits, slots, cat's-eyes, bars, &c., may be added at pleasure.

The *Iris Diaphragm*, fig. 101, is an inexpensive and ingenious form of iris diaphragm designed by Wale, of America, for use with his "Working, or Student's," microscope. It consists of a piece of very thin cylindrical tube, A, about  $\frac{3}{4}$  of an inch in length and  $\frac{5}{8}$  of an inch in

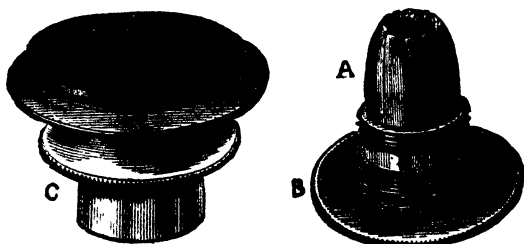

FIG. 101 — Wale's *Iris Diaphragm*.

diameter, the circumference of which is cut throughout with shears to nearly the whole length, and at intervals of about  $\frac{1}{4}$  of an inch; by means of a screw collar B attached below, this cut tube is forced into a parabolic metal shell, contained within C, whose apex is truncated to an aperture of about  $\frac{3}{8}$  of an inch; the pressure of the screw causes the thin metal tongues to turn and to overlap in a spiral, which gradually diminishes the aperture to the size of a pin-hole. On unscrewing the collar B, the spiral overlapping of the tongues is released, and by their elasticity causing the aperture gradually to expand. The whole device is fitted into the opening of the stage from beneath, so as to be flush with the upper surface, with one turn of a coarse screw on the edge of C.

Beck's Iris Diaphragm (fig. 102) is very simple, and on that account preferred. By pressing the lever handle placed at the side of the brass box the aperture is gradually made to close up, and without for a moment losing sight of the object.



FIG. 102.—Beck-Brown's  
Iris Diaphragm.

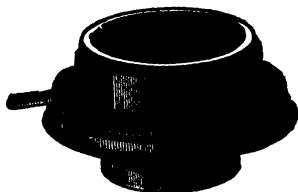

FIG. 102a—Collins-Davis's Iris Nose-  
piece Diaphragm

*Collins's Limiting Diaphragm, or Aperture Shutter.*—Fig. 102a shows the instrument as a nose-piece for screwing on to the lower end of the microscope tube. This form of aperture shutter enables the observer to adjust his objective to any aperture he wishes, and the closing of the shutter does not contract the absolute size of the field, but limits its brightness; in this way the true value of *penetration* is observed without moving the eye from the tube.

Mr. Nelson suggests the application of a series of diaphragms in connection with an ingenious centring *nose-piece* devised likewise as a sub-stage. This piece of apparatus is recommended as a useful addition, and as a convenient and inexpensive centring sub-stage for small instruments. The optical part of a  $\frac{4}{10}$  objective forming the condenser, and which for the purpose should be fitted with the shortest possible adapter, so that the diaphragms may be brought close to the back lens. The sub-stage is seen in fig. 103.

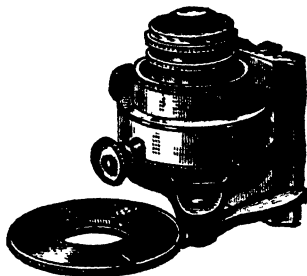

FIG. 103.—Nelson's Sub-stage Condenser.

Mr. Nelson recommends as the most useful of his diaphragms those represented in fig. 104, in which *a* may be regarded as a type shape for one pencil of light, and *b* for two, at right angles. The superposition of stops *c* will cut off more or less of the central light, *d* will stop out more or less of the peripheral zone; while *e* is a combination intended to utilize the most



FIG. 104.—Nelson's Diaphragms.

oblique pencil required for the resolution of fine lined objects. A variety of discs of the forms *c* and *d* may be used; any of which, dropped into a metal holder with an inner ring made deep enough to receive two or three, which when in place can be rotated by a milled edge, or moved out of the axis by the handle.<sup>1</sup>

*Dark Field Illuminators.*—To Mr. F. H. Wenham's the microscope is deeply indebted for many valuable improvements; not the least important being the dark-



FIG. 105.—Wenham's Parabolic Condenser.

field or parabolic illuminator, invented in 1851. The operation of the parabolic condenser (fig. 105) depends for its action on rays thrown on the object at an angle extending beyond that known as the aperture of the object-glass, and which otherwise would be lost; consequently, as the source from which the light comes is without the range of the pencil of rays of the objective, the field must be dark; but if an object possessing a partial opacity is placed exactly in focus, it becomes brilliantly luminous by means of these rays. Dark-ground illumination is not suitable for very transparent objects—that is, unless there is a considerable difference in their refraction, or they are pervaded by air-cells.

One very remarkable example of this fact may be

(1) *Journal of the Royal Microscopical Society*, Vol. IV., p. 126 (1861)

seen in the tracheal system of insects. If any of the transparent larvæ of the various kinds of gnat found about ponds in spring-time, be mounted in the elastic gelatine and glycerine jelly (which must be warmed only enough to run, and not kill the insect at the time), on about the third day afterwards all the water is absorbed from the tubes, and they become filled with air. Illuminated by the parabolic condenser, and viewed with the binocular microscope, and a low power, the gnat-larva is a superb object. The body of the insect is but faintly visible, but, in its place, is displayed a marvellous tracheal skeleton, with each tube

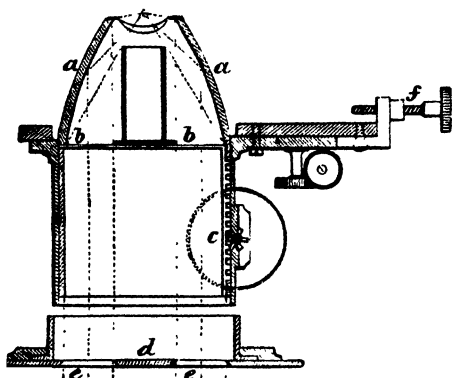

FIG. 106.—A sectional view of Wenham's Parabolic Illuminator.

standing out in perspective, shining brilliantly, like a structure of burnished silver. Unfortunately, such objects are not permanent, for when the whole of the free water dries up, the tracheal tubes either collapse or become refilled with fluid.

As the blackness of field, and luminosity of the object, depends upon the excess of light from the paraboloid received beyond the angle of aperture of the object-glass, it is found in practice that more and more of the inner annulus of rays from the paraboloid has to be stopped off, until, at last, with high-angled objectives, it is scarcely possible to obtain a black field.

The parabola answers quite well for objects in balsam or mounted dry, but its application scarcely extends to object-glasses higher than 1-5th, unless of large aperture.<sup>1</sup>

Wenham's parabolic reflector, seen in section, fig. 106, *a a*, of a tenth of an inch focus, has a polished silver surface, the apex of which is cut away so as to bring the focal point at a proper distance above the top of the apparatus (which is closed with a screw-cap when not in use), thus allowing the pencil of light to pass through the thickest glass cover used for mounting. At the base of the parabola is a disc of thin glass *b b*, in the centre of which is cemented a dark well, with a flange equal in diameter to the aperture at the top of the reflector, for the purpose of stopping all direct rays from passing.

The reflector is moved to and from the object by means of the rack and pinion *c*, with a similar adjustment for centring, and is either fixed under the stage of the microscope or made to slide into the sub-stage; in addition, there is a revolving diaphragm *d*, with two apertures *e e*, placed diametrically, for the purpose of obtaining two pencils of oblique light in opposite directions.

In using the paraboloid, the *plane* mirror is so adjusted that parallel rays enter it and impinge on the parabolic sides of the reflector, in such a manner as to be totally reflected without suffering refraction, and meet in the centre of a spherical hollow made in the top of the paraboloid. The adjustable stop being either raised or lowered, will effectually arrest all superfluous rays.

The light most suitable for this method of illumination is lamp, the rays of which should in all cases be rendered more parallel by means of a large plano-convex lens, or condenser.

*The Immersion Illuminator.*—Mr. Wenham, in the year 1856, described various forms of oblique illuminators, one of which was an immersion; a simple right-

(1) See an excellent summary of the value of parabolic illumination and immersion illuminators by Mr. J. Mayall, junr., Vol. II, p. 27, *Journal of the Royal Microscopical Society* (1879).

angled prism, connected by a fluid medium of oil of turpentine, or oil of cloves. This, however, was abandoned for a nearly hemispherical lens, connected with the slide, and which, although a great improvement, did not reach the point of excellence Mr. Wenham was looking for. Ultimately he adopted a semicircular disc of glass of the exact form and size represented in the drawing,—fig. 107, being a side view, and fig. 107a, an edge view of the same,—and having a quarter-inch radius, with a well-polished rounded edge, the sides being grasped by a simple kind of open clip attached to the sub-stage. The fluid medium used for connecting the upper surface with the slide being either water, glycerine, or oil; a certain increase of obliquity being obtained by swinging the ordinary mirror sideways. By means of an illuminator of the kind difficult objects mounted in balsam were resolved. This simple piece of glass, in appearance somewhat resembling the half of a broken button half an inch in diameter, collects and concentrates light in a surprising way, and is by no means a bad substitute for the more costly forms of achromatic condenser. It can be used either in fluid contact with the slide, or dry, as an ordinary condenser.



FIG 107.



FIG. 107a.

Mr. Wenham subsequently contrived a small truncated glass paraboloid, for use in fluid contact with the slide; water, glycerine, gum, oil, or other substance being employed as a contact medium. The rays of light in this illuminator being internally reflected from a convex surface of glass, impinge very obliquely on the under surface of the slide, and are transmitted by the fluid uniting medium, and internally reflected from the upper surface of the cover-glass to the objective. To use the reflex illuminator efficiently it must be racked up to a level with the stage. The centre of rotation is then set true by a dot on the fitting, seen with a low power, a drop of water is then placed on the top, and upon this the slide is laid. Minute objects

on the slide, found by the aid of a low power, and distinguished by their brilliancy, or by rotating the illuminator; the effect on the Podura is superb, the whole scale appearing dotted with bright blue spots in a zig-zag direction. Objects for this illuminator should be specially selected or mounted on the slide.

Mr. J. Mayall, Jun.'s, semi-cylinder or prism for oblique illumination (fig. 108) is a convenient form,



FIG. 108.—*Mayall's*  
*Semi-Cylinder*  
*Illuminator.*

as it permits of the semi-cylinder being tilted and placed excentrically; in this manner, without immersion contact, and by suitable adjustment, a dry object can be viewed with any colour of monochromatic light. If placed in immersion contact with the slide, the utmost obliquity of incident light can be obtained. Objects in fluid may be placed on the plane-surface of the semi-cylinder, and illuminated by ordinary transmitted light, or rendered "self-luminous" in a dark field, as with the hemispherical illuminator or Wenham's immersion paraboloid. A concave mirror with a double arm is quite sufficient to direct the illuminating pencil. This semi-cylinder was originally made by Tolles, of Boston, for measuring apertures, but, at Mr. Mayall's suggestion, Messrs. Ross mounted it as an illuminator.

### *The Achromatic Condenser.*

The aim of the microscopists in bringing the achromatic condenser into use, is to secure a pencil of light that shall approximately fill the aperture of the objective, and by the intervention of central stops, or slots, the various portions of the cone of condensed light, according to the kind of object under examination, shall fully utilize the same.

The peculiar advantages of employing an achromatic condenser for the purpose indicated, were first pointed out by Dujardin, since which time an object-glass

has been frequently but inconveniently employed; and more recently much attention has been bestowed upon achromatic illuminators by most of our instrument makers. It is now some years since Mr. Gillett was led by observation to appreciate the importance of controlling and condensing the quantity of light by a diaphragm placed anywhere between the source of light and the object. This he found more fully effected by a diaphragm placed immediately behind the achromatic illuminating combination. Such a diaphragm is represented in fig. 109, Ross's original Gillett. It consists of an achromatic illuminating lens *c*, which is about

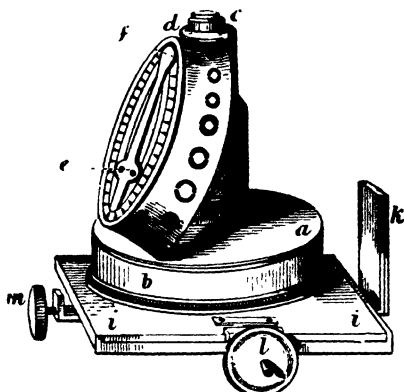

FIG. 109.—*The original form of Gillett's Achromatic Condenser.*

equal to an object-glass of one-quarter of an inch focal length, with an angular aperture of  $80^\circ$ . This lens is screwed on to the top of a brass tube, and intersecting which, at an angle of about  $25^\circ$ , is a circular rotating brass plate *a b*, provided with a conical diaphragm, having a series of circular apertures of different sizes *h g*, each of which in succession, as the diaphragm is rotated, proportionally limits the light transmitted through the illuminating lens. The circular plate in which the conical diaphragm is fixed is provided with a spring and catch *e f*, the latter indicating when an aperture is central with the illuminating lens, also the num-



ber of the aperture as marked on the graduated circular plate. Three of these apertures have central discs, for circularly oblique illumination, allowing only the passage of a hollow cone of light to illuminate the object. The illuminator above described is placed in the secondary stage *i i*, which is situated below the general stage of the microscope, and consists of a cylindrical tube having a rotatory motion, also a rectangular adjustment, which is effected by means of two screws *l m*, one in front, and the other on the left side of its frame. This tube receives and supports all the various illuminating and polarising apparatus, and other auxiliaries.

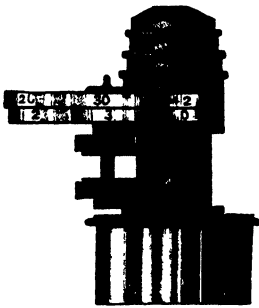

FIG 110.—Ross's Improved Achromatic Gillett Condenser

Very many modifications of Gillett's condenser are known to microscopists, by far too numerous to describe in detail. Ross's improved form is made to slip into the sub-stage in the same way as his Improved Achromatic Condenser (fig. 110), and when arranged for oblique illumination, is an extremely efficient instrument. The optical part is similar to a  $\frac{1}{10}$ ths object-

glass. It has two sets of revolving diaphragms with apertures and stops, for showing surface markings in a brilliant manner.

*Directions for Using Gillett's Condenser.*—In the adjustment of the compound body of the microscope for using with Gillett's illuminator, one or two important points should be observed—first, centricity, and secondly, the fittest compensation of the light to be employed. With regard to the first, place the illuminator in the cylindrical tube, and press upwards the sliding bar *k* in its place, until checked by the stop; move the microscope body either vertically or inclined for convenient use; and with the rack and pinion which regulates the sliding bar, bring the illuminating lens to a level with the upper surface of the object-stage; then move the

arm which holds the microscope body to the right, until it meets the stop, whereby its central position is attained; adjust the reflecting mirror so as to throw light up the illuminator, and place upon the mirror a piece of clean white paper to obtain a uniform disc of light. Then put on the low eye-piece, and a low power (the half-inch), as more convenient for the mere adjustment of the instrument; place a transparent object on the stage, adjust the microscope-tube, until vision is obtained of the object; then remove the object, and take off the cap of the eye-piece, and in its place fix on the eye-glass called the "centring eye-glass," described below, which will be found greatly to



FIG. 111 — *Beck's New Achromatic Condenser.*

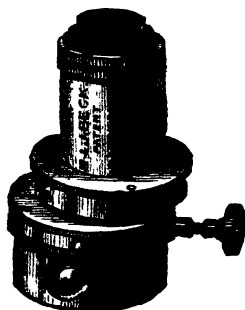

FIG. 111a. — *Beck's Dry Achromatic Condenser.*

facilitate the adjustment now under consideration, namely, the centring of the compound body of the microscope with the illuminating apparatus of whatever description. The centring-glass, being thus affixed to the top of the eye-piece, is then to be adjusted by its sliding-tube (without disturbing the microscope-tube) until the images of the diaphragms in the object-glass and centring lens are distinctly seen. The illuminator should now be moved by means of the left-hand screw on the secondary stage, while looking through the microscope, to enable the observer to recognize the diaphragm belonging to the illuminator, and by means of the two adjusting screws, to place this diaphragm

central with the others: thus, the first condition, that of centricity, will be accomplished. Remove the white paper from the mirror, and also the centring-glass, and replace the cap on the eye-piece, also the object on the stage, of which distinct vision should then be obtained by the rack and pinion, or fine screw adjustment, should it have become deranged.

*Beck's New "Wet and Dry" Condenser* (fig. 111).—In an earlier form of dry condenser (fig. 111a) Messrs. Beck made use of a revolving front, with the intention

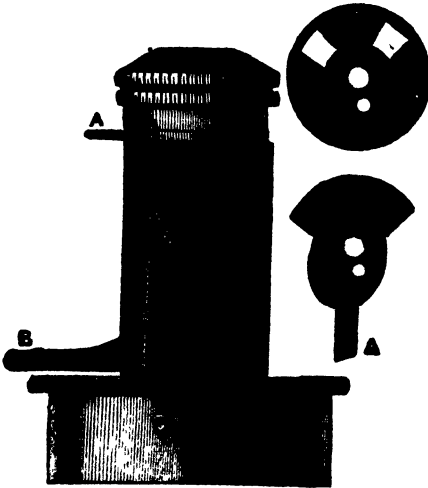

FIG 112. —*Powell and Laland's Condenser.*

of obtaining large angular aperture, and of rotating a series of lenses. They have more recently introduced a new form, and the advantages to be gained are—First, That it is available for either dry or immersion object-glasses up to 1.3 numerical aperture on diatoms, &c., or dry ones on histological objects. Secondly, That the spherical form of the front, worked by a milled head, enables a series of lenses to be used, and yet avoids the inconvenience of having the connecting fluid drawn away from the one in use by capillary attraction, as

would be the case if they were mounted on a flat surface. It also interferes less than the old form with the movements of the stage.

*Powell and Lealand's Immersion Condenser*, or non-achromatic condenser (fig. 112), is constructed on a somewhat novel plan. It admits of a very large angle of light, about 130 degrees, and allows of the use of either central light, or one or two oblique pencils of 90 degrees apart. Two diaphragm slots (shown in the woodcut apart from the condenser), fit in at A and B;

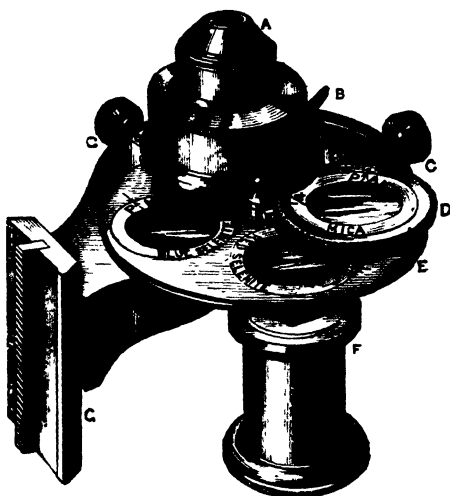

FIG. 113 — *Swift's Achromatic Condenser.*

by means of which two beams of light at right angles can be used. The movement of these diaphragms is effected by means of an outer sliding tube *b* with a slot at the top, and into which the arm *A* fits; whilst another at *B* gives a ready command of the rotation of the two, either together or separately, thus producing considerable modifications of light.

Swift and Son's Achromatic Condenser is conveniently arranged to supply the place of a compound sub-stage, and to receive accessory diaphragms. The optical

combination A is computed to be used as an effective spot-lens from a 3-inch objective up to a sixth. C C are two small milled heads by means of which the optical combination A is centred to the axis of the objective. The revolving diaphragm E has four apertures for the purpose of receiving central stops, oblique light discs, and selenite films. D is a frame carrying two revolving cells, into one of which a mica film is placed, which can be revolved with ease over either of the selenites below, whereby changes of colour can be obtained in experimenting with polarised light. The darts and P A's indicate the position of the positive axis of the mica and selenic films, and by this means results can be recorded, &c. Either of the revolving cells can be

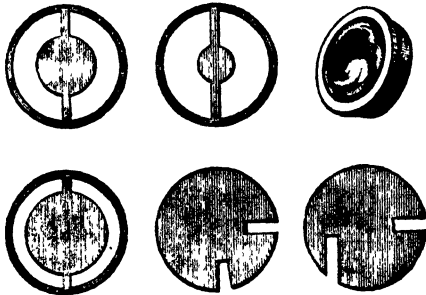

FIG. 114.—*Swift's Diaphragms and Central Stops.*

thrown into the centre of the condenser, and there stopped by means of a spring catch; when so arranged the mica film, &c., may be revolved in its place by turning the cell D, as both cells are geared together with fine racked teeth. F is a polarising prism mounted on an eccentric arm, rendered central when in use, or thrown out, as seen when out of use. G is the rack dove-tail slide for indicating focussing the condenser on the object. The advantages of this condenser consist in having the polarising prism, selenite films, dark ground and oblique light stops, so that they may be brought close under the optical combination.

Collins's Webster's Universal Achromatic Condenser (fig. 115) is a mechanical contrivance provided with

a shutter diaphragm. This addition to the microscope can be used with any instrument and without a sub-stage, and is on this account easily adapted to the

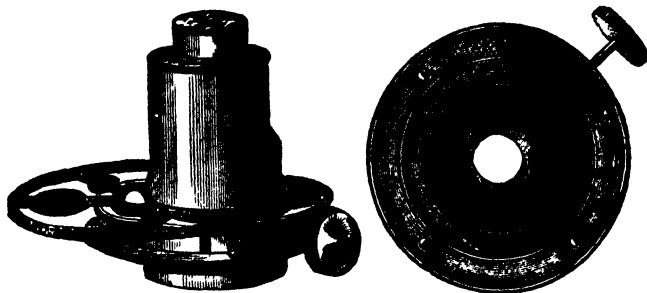

FIG. 115.—Collins's Webster's Universal Condenser.

Shutter Diaphragm seen separately

cheaper forms of microscopes. Its advantages are, that it is moderately cheap, is at once an achromatic condenser, parabolic illuminator, and graduating diaphragm and polariser. By means of a lever, the central aperture can be gradually closed, and, provided the object-glass has sufficient "resolving power," it facilitates the resolution of the more difficult test-objects. With a "spot-lens stop," the object is illuminated on a dark ground, and when high powers are used in connection with the polariscope, the advantage derived by such an addition to the ordinary mode of illumination is considerable.

Mr. Hyde's "Condenser" is constructed for use with immersion objectives, having apertures greater than correspond to  $180^\circ$  in air. The lens is a right-angled prism, having a plano-convex lens fitted in an upright, and mounted in brass to slip into the sub-stage (fig. 116), will condense parallel rays to a focus on a balsam-mounted object, through a slide of average

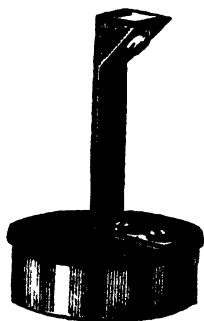

FIG. 116.—Hyde's Illuminator.

thickness, when the illuminator is brought into immersion contact. Its action is diagrammatically shown in fig. 117. A is the first lens of an immersive objective in fluid contact with the cover-glass; o the object in balsam; P a right-angled prism in immersion contact with the base of the slide; L a lens designed to focus

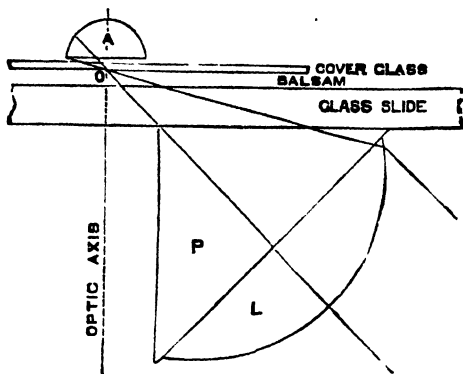
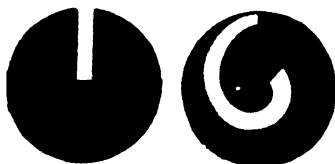

FIG. 117.

the illuminating rays on the object o. For oblique illumination, as seen in the figure, the apparatus must be thrown out of the axis of the microscope, and in this way and with any objective of less aperture than  $90^\circ$  in glass would give a dark field. If brought nearer the axial line it is evident that less oblique rays could be used.

Mr. John Mayall devised a set of spiral diaphragms

FIG. 118.—*Mayall's Spiral Diaphragm.*

as a convenient mode of obtaining oblique illumination in connection with high-angled condensers. If a slot diaphragm, fig. 118, be fixed close beneath the larger lens, such as those of Powell

and Lealand, Zeiss and other makers, the rotation under it of a diaphragm having a spiral opening,

will give a pencil of light at varying degrees of obliquity throughout the range of the aperture of the condenser. The azimuthal direction of the incident pencil will be controlled either by rotating the object or the condenser carrying the diaphragms; whilst the rotation of the spiral in the fixed slot will not change the direction in the azimuth but in altitude, so far as the aperture of the condenser will permit.

Mr. J. W. Stephenson's "Catoptric Immersion Illuminator" attains its object in a simple way. Fig. 119 represents the form and size of the little piece of apparatus.

It is a plano-convex lens worked on a 1-inch tool, and having a diameter of 1.2 inches, which is then edged down to 1 inch, as being more convenient in size, and as giving an aperture sufficient for the purpose. The upper or convex side of the lens is cut down or flattened, so as to give a surface of  $\frac{4}{10}$  of an inch in diameter, with which the slide is

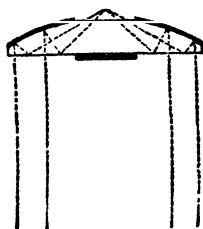

FIG. 119.—*Catoptric Immersion Illuminator.*

to be brought into contact, by a drop of oil, glycerine, or water. The upper curved surface is silvered; beneath the lens a flat silvered plate  $\frac{1}{6}$  of an inch thick, and corresponding in size and position with the upper flattened surface, is balsamed. The incident ray is thus rendered normal to the under surface, and is thrown back on the plane or under surface of the lens, whence the more oblique rays falling beyond the central angle are totally reflected and conveyed to a focus. A stop is placed about an  $\frac{1}{8}$ th of an inch or less below the condenser, and the opening used is of a lens-shaped form, which admits a broad beam of light without appreciable spherical aberration. The Iris diaphragm greatly improves this illuminator.<sup>1</sup>

*The Oil Immersion Condenser.*—In this is combined the latest improvement in immersion condensers. In operation, an oil-medium possesses superior advantages in connection with high-angled objectives. The oil

(1) *Journal of R. M. S.*, Vol. II., p. 36, 1879.



immersion condenser of Powell and Lealand is an improved form, consisting of the truncation of the vertex of the upper lens of the condenser, and admits of the lower lens being brought into closer proximity, when the marginal rays become more effective. Its speciality is the conversion of axial light into condensed obliquely incident light by the refraction of the condenser.

For the illumination of opaque objects under high powers, Tolles of Boston, U.S.A., introduced a vertical illuminator into the body of the microscope close to and above the objective.

*The Vertical Illuminator* consists of a small silver speculum (Professor Smith), or a movable disc of thin glass (Beck), or a small piece of parallel glass, placed at an angle of  $45^\circ$  (Powell and Lealand), and fixed in a short tube, with a side aperture, interposed between the objective and the body of the microscope; by which means a pencil of light entering at the aperture, and striking against the speculum or inclined surface of the disc, is reflected downwards through the objective and upon the object placed on the stage of the microscope. The object-glass is thus made its own achromatic condenser. When this form of illuminator was introduced, it was soon discarded on account of the halo or fog which surrounded the image, and which was caused, as Mr. Stephenson explained, by the reflection, at the upper surface of the cover-glass, of the rays transmitted through the objective. With the introduction of the oil-immersion objective all this fogging disappeared; the front lens of the objective, the intervening stratum of oil, and the cover-glass of the object all become optically continuous, so that the upper surface of the cover-glass virtually ceases to exist, the only reflection being from its under surface, when dry objects are used. "The explanation is that if the vertical illuminator be adjusted, and used with an immersion objective, having a numerical aperture greater than 1.0, focussed on a plane glass slip, it is evident that (practically) all that part of the pencil comprised within the numerical aperture 1.0 will

emerge at the plane base of the slip, and be lost to view; but the peripheral zone of the pencil beyond the numerical aperture 1.0 will *not* emerge, but is totally reflected at the internal surface of the base of the slip, and is seen as a luminous zone surrounding a nearly dark field (the field is not absolutely dark, because of the ordinary reflection of light that takes place before the emergence of the central pencil)."<sup>1</sup>

*Method of Using Condensers.*—Whatever the special form of apparatus, it should always subserve the purpose of condensing the light reflected by the mirror to a correct focus upon the object. The light reflected from either the plane or concave mirror should pass through the axis of the condenser, moving at the same time in all directions, and in the axis of the objective, body, and eye-piece of the microscope. The secondary stage should be made to admit of perfect centring and be provided with a racking adjustment. Upon changing the objective, Ross's centring eye-glass must be brought into use to ensure the centricity of the condenser and the body of the microscope.<sup>2</sup>



FIG. 120.—Beck's Amici's Prism.

The Amici Prism was originally designed for oblique illumination. It consists of a flattened triangular glass prism, the two narrower sides of which are slightly convex, while the third or broadest side forms the reflecting surface. When properly used, it is capable of transmitting a very oblique pencil of light. The prism is usually mounted, as in fig. 120, for slipping into the sub-stage.

*The Lieberkühn.*—The concave speculum termed a

(1) *English Mechanic.*

(2) This centring-glass consists of a tubular cap with a minute aperture, containing two plano-convex lenses, so adjusted that the image of the aperture in the object-glass, and the images of the apertures of the lenses and the diaphragms contained in the tube which holds the illuminating combination, may all be in focus at the same time, so that by the same adjustment they may be brought sufficiently near to recognize their centricity.

"Lieberkühn," from its celebrated inventor, was formerly much in use as a reflector, but is now almost abandoned, or rather replaced by other and better contrivances. The Lieberkühn is generally attached to the object-glass, in the manner represented at fig. 121, where

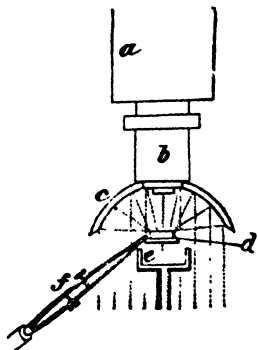

FIG. 121

*a* exhibits the lower part of the compound body, *b*, the object-glass, over which is slid a tube and the Lieberkühn, *c*, attached to it; the rays of light reflected from the mirror are brought to a focus upon an object *d*, placed between it and the mirror. The object may either be mounted on a slip of glass, or else held by the forceps, *f*; when very small, or when transparent, it is better to gum it to the dark well, *e*, or mount it on Beck's opaque disc-revolver (fig. 122).

Beck effected a considerable improvement upon the

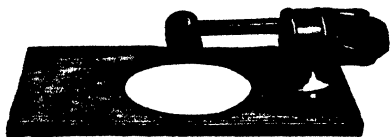

FIG. 122.—Beck's Opaque Disc revolver.

Lieberkühn by the introduction of the silver side-reflector (fig. 123), which causes the shadows to fall on the proper side, and is employed on this account. This is either fixed into the stage of the microscope or used on a separate stand, so that it may be turned in any direction towards the source of light. The parabolic side-reflector (fig. 123*a*) is adapted for use with high powers.

Sorby, while experimenting with a reflector of the kind, discovered the value of observing the peculiarities of objects under every kind of illumination; for, on viewing specimens of iron and steel with this reflector,

he found that, owing to the obliquity of illumination, the more brilliantly polished parts reflected the light beyond the aperture of the objective, and he could not therefore distinguish them from those parts which merely absorbed the light. To throw the illumination more perpendicularly upon the specimen, he was obliged to place a small flat mirror immediately in front of the objective, and cover half its aperture, and at the same time stop-off, by means of a semi-cylindrical tube, the light from the parabolic reflector. By such an arrangement, the light produces the reverse appearances of the former mode of illumination, and is a valuable aid in determining the true condition of the object.

*The Bull's-eye Condenser.* — The

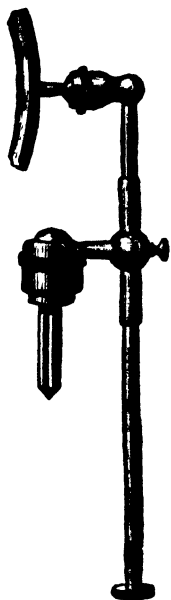

FIG. 123.—Beck's Silver Side-reflector



FIG. 123a.—Beck's Parabolic Reflector.

bull's-eye condensing lens (fig. 124) is used for converging rays from a lamp upon the mirror; or for reducing the diverging rays of the lamp to parallelism, for use either with the parabolic illuminator, or silver side-reflector. A plano-convex lens of about three inches focal length, is the form generally adopted; it is borne upon a swivel-joint, which allows of its being turned in any direction, and placed at any angle; the tube is double, and thus admits of being lengthened or shortened. When used by daylight, its plane side should be turned towards the object, and the same position should be given when used for converging the rays from a lamp; but when used with the parabolic

or side-reflector, the plane side must be turned towards the lamp.



FIG. 124. — *Bull's-eye Condensing Lens.*

*The Microscope Lamp.*—The introduction of paraffin into household use has somewhat modified our views with regard to the most suitable artificial source of illumination. Paraffin burns with a whiter and purer flame than either oil or gas, and consequently is less liable to produce fatigue or injury to the eyes. The first cost of the lamp is trifling; for a moderate sum a handy form of lamp can be procured, mounted on an adjustable sliding-ring stand, and with a porcelain, metal, or paper shade, to protect the eyes from scattered rays of light (fig. 125).

To give the increased effect of whiteness to the light ("white cloud illumination" as it is termed), take a piece of tissue paper, dip it into a hot

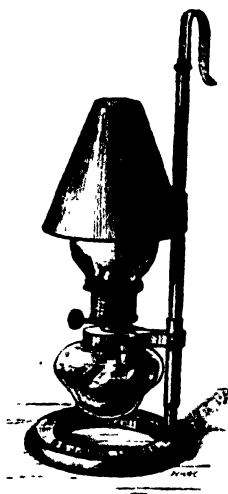

FIG. 125. — *Bull's Microscope Lamp.*

bath of spermaceti, and, when nearly cold, cut out a circular piece and secure it over the largest opening in the diaphragm plate. This will materially moderate and soften the light.

*Finders and Indicators.*—A finder, as applied to the microscope, is the means of registering the position of any particular object in a slide: as, for instance, some particularly good specimen of a diatom, so that it may be referred to at a future time. The subject will be found fully discussed in the pages of the *Journal of the Royal Microscopical Society*. The traversing stage of

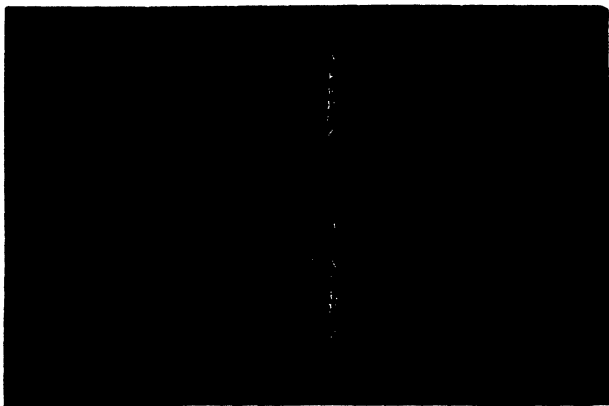

FIG. 126.—Amyot's Object Finder.

the microscope admits of such finders as those of Mr. Okeden, Mr. Tyrrell, Mr. Amyot (fig. 126), &c., being used. The first named (Mr. Okeden's) finder consists of two graduated scales, one of them *vertical*, attached to the fixed stage-plate, and the other *horizontal*, attached to an arm carried by the intermediate plate; the first of these scales enables the observer to "set" the vertically-sliding plate to any determinate position in relation to the fixed plate, while the second gives him the like power of setting the horizontally-sliding plate by the intermediate.

For those microscopists whose instruments are with-

out a traversing stage "Maltwood's finder" will be found an efficient substitute. It consists of a glass slide,  $3 \times 1\frac{1}{4}$  inches, on which is photographed a scale occupying a square inch; this is divided by horizontal and vertical lines into 2,500 squares, each of which contains two numbers marking its "latitude," or place in the vertical series, and its "longitude," or place in



FIG. 127 *Dipping-tubes.*



FIG. 127a — *Stock-bottle.*

the horizontal series. The scale is in each instance an exact distance from the bottom and left-hand end of the glass slide; and the slide when in use should rest upon the ledge of the stage of the microscope, and be made to abut against a stop, a simple pin, about an inch and a half from the centre of the stage. Messrs. Beck supply this finder with their microscopes.

*Dipping-tubes* are tubes of glass (fig. 127) about nine

inches in length, open at both ends, and from one-eighth to one-fourth of an inch in diameter. The ends must be nicely rounded off in the flame of a blow-pipe; some of them should be made perfectly straight, while others should be bent or drawn out to a fine point, and made either of the shapes represented.

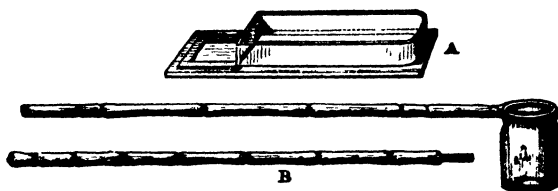

FIG 128

A. Trough for showing Circulation in Fish-tail.  
B. Collecting-bottle and Stick.

Fig. 128, at B, is represented a convenient and portable "Collecting-bottle and Stick;" an ordinary cane divided by a screw, or socket-joint, into two parts for the convenience of packing, and terminated by a brass ring, which is adapted to receive a wide-mouthed bottle. A small fine-gauze net and a hook can be screwed into the same stock, and the whole packed into a small compass.



FIG. 129.—Net for collecting Minute Animals.

*Compressorium*.—The purpose of this accessory is to apply a gradual pressure to objects whose structure can only be made out when they are pressed or thinned out by extension. The general plan of the compressorium is shown in fig. 130.

Ross's Compressorium consists of a stout plate of brass A, about three inches long, having in its centre a



piece of glass like the bottom of a live-box. This piece of glass is set in a frame *B*, which slides in and out so that it can be removed for the convenience of preparing

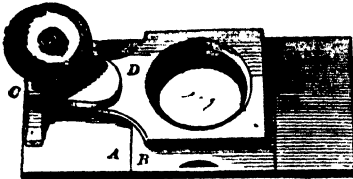

FIG. 130.—*Ross's Compressorium.*

any object upon it—under water if desirable. The upper movable part *D* is attached to a screw-motion at *C*; and at one end of the brass plate *A*, which forms the bed of the instrument, is an up-

right piece of brass *C*, grooved so as to receive a vertical plate, to which a downward motion is given by a

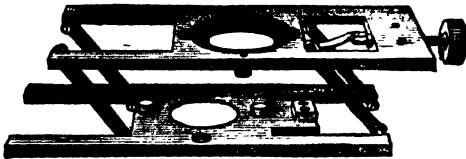

FIG. 131.—*Beck's Parallel-plate Compressor.*

single fine screw, surrounded by a spiral spring, which elevates the plate as soon as the screw-pressure is removed.

Beck's Parallel-plate Compressor, fig. 131, affords a



FIG. 132.—*Botterell's Live-trough.*

more exact means of regulating the pressure, and can be used for a variety of purposes. It is also easily cleaned.

Live-troughs are made to partake of a variety of

forms and shapes. Botterill's (fig. 132) consists of two brass plates, screwed together by binding screws, and holding between them two plates of thin glass, and which are maintained at a proper distance by inserting half of a circular flat disc of india-rubber.

Beck's glass trough for chara and polypes, a sectional view of which is shown at fig. 133, is made of three pieces of glass, the bottom being a thick strip, and the front *a* of thinner glass than the back *b*; the whole is cemented together with Jeffery's marine-glue. The method adopted for confining objects near to the front glass varies according to circumstances. One of the most convenient plans is to place in the trough a piece of glass that will stand across it diagonally, as at *c*; then if the object be heavier than water, it will sink, until stopped by this plate of glass. At other times, when used to view chara, the diagonal plate may be made to press it close to the front by means of thin strips of glass, a wedge of glass or cork, or even a folded spring. When using the trough, the microscope should be placed in a nearly horizontal position.



FIG. 133.

*Growing-cells.*—Considerable attention has been given



FIG. 134.—Weber's Slip with Convex Cell for use as a Live-trough.



FIG. 134a.—Beck's Current-slide Live-cell.

to various forms of growing-cells for maintaining a continuous supply of fresh water to objects under observation, and for the purpose of sustaining their vital energy for a long period. The employment of live-cells is strongly commended to microscopists, as there is yet much to be discovered concerning the metamorphoses which some of the lower microscopic forms of plant

and animal life pass through; a patient investigation will probably show that many which are now classed as distinct species are merely different phases of the same type, which alternate according to the varied

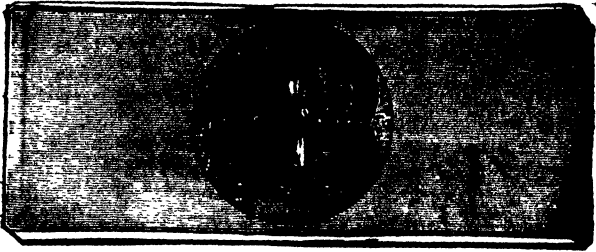

FIG. 135.—*Holman's Life Slide. Full size.*

conditions of temperature and nutrition under which they are placed.

Holman's life slide consists of a  $3 \times 1$  inch glass slide, with a deep oval cavity in the middle to receive the material for observation. A shallow oval is ground and polished around the deep cavity, forming a bevel.

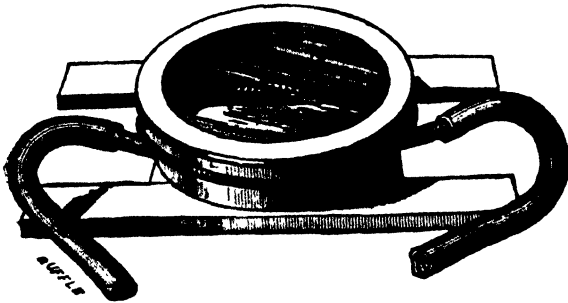

FIG. 136.—*Holman's Moist Chamber.*

From this bevel a fine cut extends, to furnish fresh air to the living low forms of life which invariably seek the bevelled edge of the cavity, thus bringing them within the reach of the highest powers.

Mr. Holman contrived a form of "moist chamber,"

or animalcule-cage, fig. 136, for the purpose of studying the growth of fungi and other delicate organisms, without in any way disturbing them for a lengthened period. This will also be found useful as a dry chamber for holding minute insects, and preserving them in a living condition for observation.

Zentmayer's Holman Syphon Slide (fig. 137) is used either as a hot or cold water cell. It should be deep enough to hold a small fish or newt, and retain it without any undue pressure. When in use it is only necessary

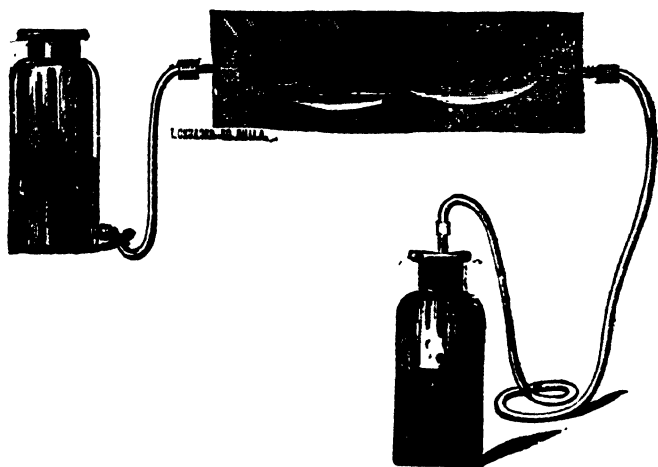

FIG. 137.—Holman's Syphon Slide.

to place the animal into the groove with some water, cover it with the glass cover, and immerse one of the rubber tubes in a jar of water, the other receiving it as it passes away. When the slide is on the stage of the microscope the jars should stand on a lower level, so that the slide be made the highest part of the syphon. The pressure of the atmosphere is sufficient to keep the cover-glass in its place. This apparatus is also adapted for the gas microscope.

The examination of various kinds of infusorial life will be greatly facilitated by the addition of the small-

est particle of colouring matter, either carmine or indigo. Mr. Thomas Bolton<sup>1</sup> directs a small quantity of either of these colours to be rubbed up in a little water in a watch-glass, and a portion taken up on the point of a brush, and the brush run along the top of the water in a trough; sufficient will be left behind to barely tinge the water with the colour, but this will gradually subside over the rotifers. Under the microscope this minute quantity will be seen like a rising cloud of dust, which as soon as it comes near a rotifer is whirled round in definite curves, showing at once the action of its wonderful coronary cilia. This colouring matter is greedily devoured by these creatures, and may be followed from the mouth to the digestive canal. If rotifers or infusoria are already in a cell and under a thin cover, a drop of the mixed colour may be placed at the edge of the cover-glass, and a piece of blotting paper touched at the other side will draw a current through the cell. The cilia and fine flagella on many of the small protophytes and infusoria, which are very difficult to see while they are in full activity, are easily seen when dying or after death from a drop of iodine. The effect of colouring matter on *Volvox globator*, *Euglena viridis*, and *Protococcus pluvialis* is very interesting; besides showing the cilia, it brings out many histological specialities, which are otherwise invisible. Aniline dyes are occasionally useful for colouring. Osmic acid is used for killing infusoria quickly in their expanded condition, and they may afterwards be stained advantageously with picrate of carmine. The most useful aquaria for preserving and breeding minute organisms is the ordinary confectionery cake-glass inverted. A square block of wood (8 in. square) with a hollow turned in the centre is required to receive the knob. It should be covered with a round glass to exclude the dust.

For finding or selecting minute animals, or dissecting botanical specimens, the Houston-Browning

(1) Mr. T. Bolton, of 57, Newhall Street, Birmingham, furnishes interesting tubes of living specimens for the microscope at a trifling cost to his correspondents.

Dissecting Microscope will be found a handy and useful form, fig. 138.

This instrument consists of a duplex lens of three powers, magnifying 4, 6, and 10 diameters, screwed to the end of a brass focussing tube, and moving upon a brass pillar attached to a sliding bar at the bottom of the box. The dissecting stage is a cork slide, plain on one side for general work, and a shallow cell on the other, for the dissection of such objects as small glossy seeds which "fly" under the needles, whilst a pitted glass slide, for carrying on dissections under water, is also provided.

*Microscopic Dissection.*—The mode of using needles for teasing out tissue is very simple. With a pair

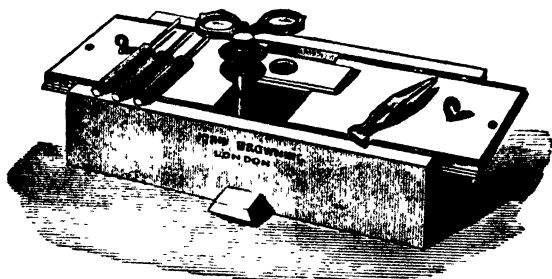

FIG. 138 —Brooking's Houston Botanical Dissecting Microscope.

of the small needles held firmly between the fore-finger and thumb, as shown in fig. 139, the structure must be *teased* out; an operation which requires some care. All substances should be carefully separated from dust and other impurities which render their structure indistinct or confusing. With delicate membranes, those of the nervous system of the smaller animals, insects, etc., it is necessary to make the dissection under water, or in fluid of some kind. For this purpose take a glass cell, and then throw a strong light down upon it by the aid of condensing lens, as represented in fig. 140. Delicate structures will be better teased out in a dilute solution of sugar or common salt, to prevent change from endosmose. Should the object

be a portion of an injected animal, it is better to pin it out on a leaded cork, covered with *white wax*, and immersed in a water-trough, as in fig. 140. The dissection of delicate vegetable structures is better carried on under water.

*Dissecting Needles, Knives, and Scissors.*—In addition



FIG. 139.—*Baker's Student's Dissecting Microscope.*

to forceps, needles, and knives, scissors are necessary for purposes of dissection. The most useful, straight and curved, are shown in fig. 141. In dissections under the microscope, the curved-pointed pair *f* will be convenient. In all the points should fit accurately together.

*Section-cutting Instruments.*—Solid tissues are, as a rule, much too hard to admit of being cut either by

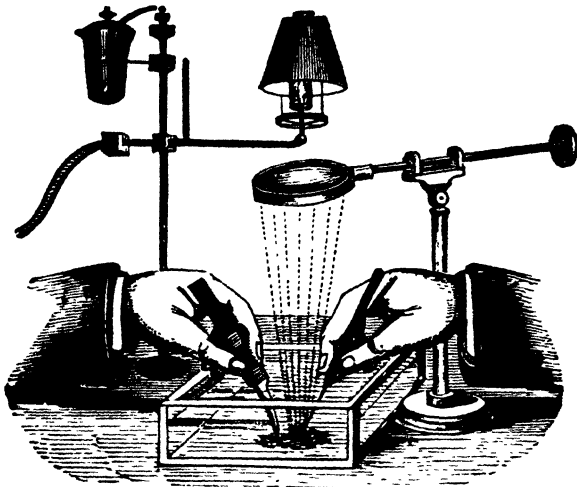

FIG. 140.—Dissecting in a fluid Medium.

scissors or Valentin's knife. As important information will be gained respecting the structure of such sub-



FIG. 141.—Dissecting Scissors and Forceps.

stances as stems and roots of plants, horns, hoofs, cartilages, and other firm parts of animals, by cutting



thin sections, it would be quite impossible for the microscopist to get on without a section-cutting instrument.

*Hailes' Section-cutting Machine.*—A is a short tube of about  $1\frac{1}{4}$  inches in diameter, provided with flanges B, B, at each end. The upper one of these flanges serves as a cutting bed or table. Inside the tube A is fitted, so as to slide freely up and down, a second tube C, in which is placed the material intended to be cut. This inner tube is provided with two clamping screws *d, d*, topped into a block which passes through a slot formed in the outer tube A, thereby preventing any



FIG. 142.—Dissecting Knives.

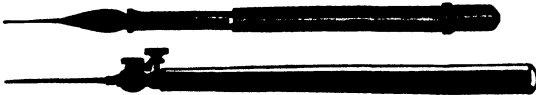

FIG. 142a.—Needles for teasing out Tissue.

rotary movement of the inner tube. Inside the tube C, and at its lower end, is secured the nut or boss D, through which passes the micrometer screw E, provided with a milled head *e*, and a divided collar *f*. This screw is carefully shouldered into a cock or bracket *F*, forming part of the lower flange B. In order to secure the machine firmly to the table, the upper flange B, is screwed to a transverse bar of wood G, which in its turn is secured to the table by the clamp H, thus avoiding all strain upon the machine itself. The material it is intended to cut may be packed in any convenient manner in the inner tube C, and secured by the clamping screws *d, d*. It will now be clearly seen

that by turning the micrometer screw *E* the inner tube *c* will be carried steadily upwards, and with it the material to be cut, without compression, and consequently without any jerking. The sections, however, may be cut with a chisel or with a razor in the usual manner.

The upper flange *B* of the machine, which serves as a cutting table, is provided with two strips of hardened and polished steel *a*. These form convenient surfaces over which the cutting tool may be passed, when cutting wood or softer sections, and they also serve another important purpose. At the back of the cutting table is secured, by means of a spring and screw and steady-pins, a metal block *b*. This block carries, fixed in it, two hard steel rods *c*, which overlie the strips *a*. By passing the blade of a fine

saw between the rods *c* and the strips *a*, sections of bone or other material too hard to be cut with a knife, may be sawn off as thin as the nature of the material will permit, in some cases sufficiently thin to permit of their being at once mounted. The rods *c* and strips *a*, being of the hardest steel, receive no injury from the teeth of the saw. The machine is made by Baker, 144, Holborn.

*Method of making Sections.*—If the wood be green, it should be cut to the required length, and be immersed for a few days in strong alcohol, to get rid of all resinous matters. When this is accomplished, it may be soaked in water for a week or ten days; it will then be ready for cutting. If the wood be dry, it should be first soaked in water and afterwards immersed in spirit, and before cutting placed in water again, as in the case of the green wood.

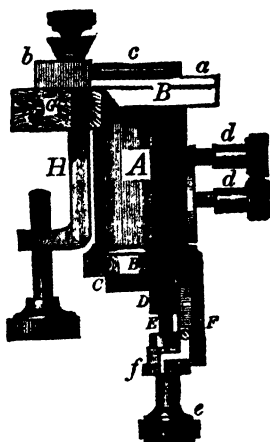

FIG. 143 — Hailes' Improved Section-cutting Machine.

With a little practice the finest and thinnest possible slices will be cut. It is usual to first slice off a few thicker slices to give a smooth and even surface to the specimen. Then turn the screw to raise it a little, sprinkle the surface with spirit and water, and cut with a light hand. Remove the cut sections with a fine camel's-hair brush or blotting-paper to a small vessel containing water, when the thinnest sections will float on the surface, and are more easily selected and removed to a bottle of spirit and water, where they should remain until they can be mounted. Sections of hard woods, and of those containing gum, resin, and other insoluble materials, must first be soaked in alcohol or ether and then transferred to oil of cloves, to render them sufficiently transparent for mounting.

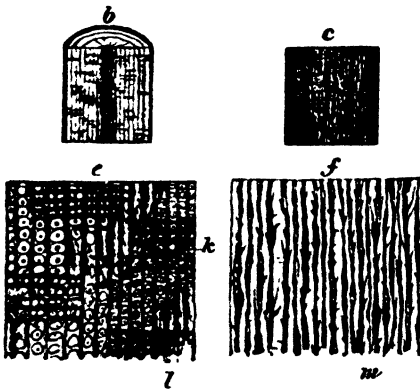

FIG. 143a —Sections of Wood.

If the entire structure of any exogenous wood is required to be examined, the sections must be made in at least three different ways: these may be termed the transverse, the longitudinal, and the oblique, or, as they are sometimes called, the horizontal, vertical, and tangential: each of these will exhibit different appearances, as may be seen upon reference to fig. 143a: *b* is a vertical section through the pith of a coniferous plant: this exhibits the medullary rays, which are known

to the cabinet-maker as the silver grain; and at *e* is a magnified view of a part of the same: the woody fibres are seen with their dots *l*, and the horizontal lines *k* indicating the medullary rays cut lengthwise; whilst at *c* is a tangential section, and *f* a portion of the same magnified: the openings of the medullary rays *m m*, and the woody fibres with vertical slices of the dots, are seen. Very instructive preparations may be made by cutting oblique sections of the stem, especially when large vessels are present, as then the internal structure of the walls of some of them may oftentimes be examined. The diagram above given refers only to sections of a pine; all exogenous stems, however, will exhibit three different appearances, according to the direction in which the cut is made; but in order to arrive at a true understanding of the arrangement of the woody and vascular bundles in endogens, horizontal and vertical sections only will be required. Specimens of wood that are very hard and brittle should be first softened by boiling in water; and as the cutting-machine will answer for other structures besides wood, it should be understood, that horny tissues will also be softened by boiling, and can then be cut very readily.

*Preparation of Hard Tissues.*—All sections of recent and greasy bones should be soaked in ether for some time, and afterwards dried in the air, before they are fit for the saw, file, and hone; by dissolving out the grease, the lacunæ and canaliculi show up very much better. When it is wished to examine the bone-cells of fossil bone, chippings only are required; these may be procured by striking the bone with the sharp edge of a small mineralogical-hammer: carefully select the thinnest of the chips, and mount them at once, without grinding, in Canada balsam. If desirable to compare bone structures, it must be borne in mind that the specimens for comparison should be cut in one and the same direction; as the bone-cells, on which we rely for our determination, are always longest in the direction of the shaft of the bone, it follows that if one section were transverse, and the other longitudinal, there must be a vast difference in the measurement of the bone-cells, in consequence of their long diameter being seen in the one case,

and their short diameter in the other. In all doubtful cases, the better plan is to examine a number of fragments, both transverse and longitudinal, taken from the same bone, and to form an opinion from the shape of bone-cell which most commonly prevails.

*The Teeth.*—The best mode of examining teeth is by making fine sections. Specimens should be taken, both from young and old teeth, to note the changes. A longitudinal or transverse slice should be first taken off; a circular saw, fitted to the lathe, fig. 143b, cuts sections very quickly—then rub down, first by the aid of the *corundum-wheel*,—which should also be fitted to the head-stock of the lathe,—then finish them off between two pieces of water-of-Ayr stone, and finally clean and polish between plates of glass, or on a polishing strap with putty powder. The section requires to be washed in ether, to remove all dirt and impurities; when well polished and dried, it may be preserved under thin glass, and cemented down with gold-size or varnish.

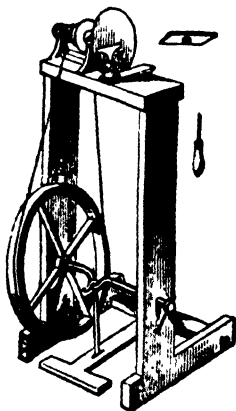

Fig 143b — *Small Lathe for polishing.*

Such polished sections are preferable to many others which, on account of their irregular surface, require to be covered with fluids, as Canada-balsam, turpentine, &c., in order to fit them for examination with high powers. It almost always happens, that some portion of these fluids enters the dentine, which then becomes indistinct, and almost invisible in its ramifications.

Two sections made perpendicularly to one another through the middle of the crown and fang of a tooth, from before backwards, and from right to left, are sufficient to exhibit the more important features of the teeth; but sections ought also to be prepared, showing the surface of the pulp cavity and that of the enamel; and likewise various oblique and transverse sections through the dentine

in the fangs, to exhibit the anastomoses of their branches. The dental cartilage is easily shown by maceration in hydrochloric-acid, a process which requires a longer or shorter time, according to the concentration of the acid. It is very instructive also to macerate thin sections in acid, and to examine them upon a slip of glass, at intervals, until they entirely break up. The enamel prisms are readily isolated in developing enamel in this way, and the transverse lines readily seen when the section is moistened with hydrochloric acid. The early development may be studied in embryos of two, three, or four months with the simple microscope; and in transverse sections of parts hardened in spirits of wine. The pulp of mature teeth is obtained by breaking them in a vice, and the nerves can be made out without difficulty on the addition of a dilute solution of caustic soda.

To cut through the enamel of the tooth, it will be necessary to lessen the friction, by dropping water upon the saw as it is made to revolve. The section is afterwards very quickly ground down by holding it against the flat side of the corundum-wheel.<sup>1</sup> A small handle, mounted with shell-lac, to fix the section in, forms a ready holder: polish, as before directed, between two pieces of the water-of-Ayr stone, or on a hone of Turkey-stone kept wet with water. As the flatness of the polished surface is a matter of the first importance, that of the stones themselves should be tested from time to time; and whenever they are found to have been rubbed down on one part more than another, they should be flattened on a paving stone with fine sand, or on a lead plate with emery. When this has been sufficiently accomplished, the section is to be secured, with Canada balsam, to a slip of thick well-annealed glass, in the following manner:—Some Canada balsam, previously rendered somewhat stiff by evaporation of part of its turpentine, is to be melted on the glass-slip, so as to form a thick drop, covering a space somewhat larger than the size of the section, and it should then be set aside to cool; during which process, the bubbles that may have formed in it will usually burst. When cold, its

(1) Corundum is a species of emery composition; alumina, red oxide of iron, and lime; it is much used by dentists as a polishing material.

hardness should be tested with the edge of the thumb-nail, for it should be with difficulty indented by pressure, and yet should not be so resinous as to be brittle. If it be too soft, as indicated by its too ready yielding to the thumb-nail, it should be boiled a little more; if too hard, which will be shown by its chipping, it should be re-melted and diluted with more fluid balsam, and then set aside to cool as before. When of the right consistence, the section should be laid upon its surface, with the polished side downwards; the slip of glass is next to be gradually warmed until the balsam is softened, care being taken to avoid the formation of bubbles, and the section is then to be gently pressed down upon the liquefied balsam in a sort of wave towards the side, and an equable pressure being finally made over the whole. When the section has been thus secured to the glass, it may be readily reduced in thickness by grinding. When the thinness of the section is such as to cause the water to spread around it between the glass and the stone, an excess of thickness on either side may often be detected by noticing the smaller distance to which the liquid extends. In proportion as the section attached to the glass is ground away, the superfluous balsam which may have exuded around it will be brought into contact with the stone; and this should be removed with a knife, care being taken that a margin be still left round the edge of the section. As the section approaches the degree of thinness which is most suitable for the display of its organization, great care must be taken that the grinding process is not carried too far; and frequent recourse should be had to the microscope to examine it. The final polish must be given upon a leathern strap, or upon the surface of a board covered with buff-leather, sprinkled with putty-powder and water, until all marks and scratches have been rubbed out of the section.

In mounting sections of bone, or teeth, it is important to avoid the penetration of the Canada balsam into the interior of the *lacunæ* and *canaliculi*; since, when these are filled by it, they become almost invisible. The benefit which is derived from covering the surfaces of the specimen with Canada balsam, may be obtained, without the injury resulting from the penetration of the balsam

into its interior, by adopting the following method:— A small quantity of balsam, proportioned to the size of the specimen, is to be spread upon a slip of glass, and to be rendered stiffer by boiling, until it becomes nearly solid when cold; the same is to be done to the thin glass cover; next, the specimen being placed on the balsamed surface, and being overlaid by the balsamed cover, such a degree of warmth is to be applied as will suffice to liquefy the balsam, without causing it to flow freely; and the glass cover is then to be quickly pressed down, and the slide to be rapidly cooled, so as to give as little time as possible for the penetration of the liquefied balsam.

*Circular Disc.*—For the purpose of cutting glass covers or making shallow cells with jappers' gold-size for mounting objects, Beck's Walmsley's turn-table (fig. 143c) is most useful.



FIG. 143c.—Beck's Walmsley's Cell-making Instrument.

For making cells, take a camel's-hair pencil, previously dipped in jappers' gold-size, hold it firmly between the finger and thumb, and set the wheel in motion, when a perfect circle will be rapidly formed; it must be put aside to dry. To cut cover-glasses secure a sheet of thin glass under the brass springs, and substituting for the pencil a cutting diamond, a circular cover may be readily cut out. A cutting diamond is not only useful to the microscopist for the above purpose, but also for writing the names of mounted objects on the ends of the glass slides.



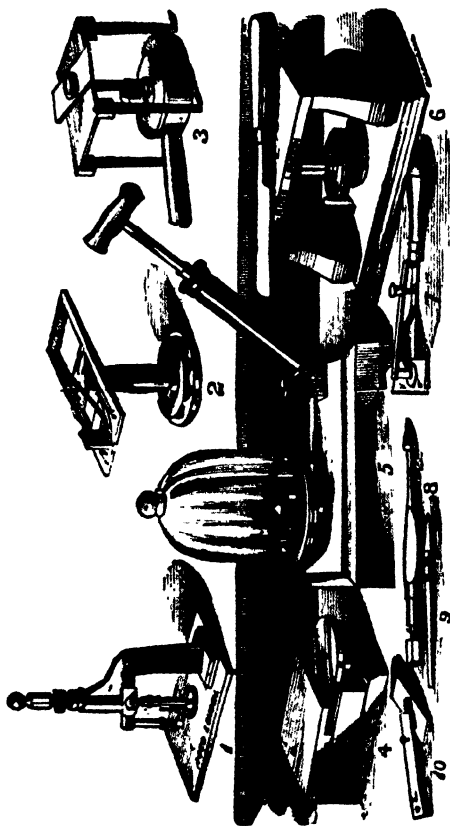

FIG. 143d. — Mounting Apparatus.<sup>1</sup>

1. Rees's instrument for cutting thin covering-glass for objects. This apparatus consists of a bent arm supporting the cutting portion of this apparatus, which consists of a vertical rod with a soft cork at one end. A brass arm at right angles carries the diamond parallel with and close to the main rod.

2. Rees's covering-glass measurer. To measure the thickness of covering-glass, place it between the brass plate and the steel bearing; the long end of the lever will then indicate the thickness on the scale, to 1-50th, 100th, or 1,000th inch.

3. Brass table on folding legs, with lamp for mounting objects.

4. Whirling table with eccentric adjustment for making cells and finishing off slides.

5. Air-pump with glass receiver, 3½-inch brass plate for mounting objects.

6. Improved table with knife for cutting soft sections. This consists of an absolutely flat brass table, with a square hole to receive the wood, or other matter, on a movable screw, which adjusts the thickness of the section.

7. Smith's holder with spring and screw for adjusting pressure when mounting objects.

8. Cutting diamonds for cell-making and cutting slips of glass.

9. Writing diamonds for cutting thin covering-glass and naming objects.

10. Page's wooden forceps, for holding glass slips or objects when heated, during mounting.

The various accessory pieces of apparatus represented on the opposite page will facilitate the process of mounting specimens.

By the aid of the Universal Spring-Clip (fig. 143e) objects of great delicacy when mounted may be left to dry and harden for any length of time.



FIG. 143e.—The Universal Spring-clip for Mounting.

**General Directions for the Preparation and Mounting Objects.**—Objects exhibited under the microscope are either opaque or transparent. The former, in the majority of instances, require little or no preparation beyond placing them in such a position as to show their external surface by *reflected* or condensed light, and covering with thin glass to exclude dust. Those objects, however, which it is intended to examine by *transmitted* light require, in most cases, to be prepared previously to mounting them, in whatever vehicle may be found most suitable for exhibiting their structure. The medium most used for exhibiting transparent objects is Canada balsam. The pure balsam is, however, too thick for use, and it requires to be diluted with spirit of turpentine to render it sufficiently fluid to permeate the structure to be exhibited. As a general rule, it should be just fluid enough to drop readily from the point of a needle. Those who desire to avoid the trouble of mixing their own mounting medium, can procure it ready for use from any of the microscope makers. There are some few objects whose structure is so transparent that they must be mounted dry. Scales from the wings of butterflies and moths, of the podura and lepisma saccharina, and some of the diatomaceæ are of this class. All that is necessary in preparing objects for dry mounting, is to take care that they are free from extraneous matter, and to fix them permanently in that position in which their structure will show to the best advantage. Care

should be taken to have no draught of air through the room while handling very delicate objects; many a beautiful object has been wafted from under the hand of the microscopist in this way, sometimes, even by his own breath.

The preparation of very minute objects which require particular chemical treatment before mounting, will be more fully described hereafter. To this class belong the diatomaceæ, whose delicate structure forms one of the most beautiful objects which can be exhibited. In mounting entomological specimens, the first thing, of course, is the dissection of the insect. This is best accomplished by the aid of Collins's Dissecting Microscope, a pair of small brass forceps, and very finely-pointed scissors; the parts to be prepared and mounted should first be carefully detached from the insect with the scissors, then immersed in a solution of caustic alkali (Liquor Potassæ) for a few days, to soften and dissolve out the fat and soft parts: the length of time it is necessary to immerse them can only be ascertained by experience, but, as a general rule, the objects assume a certain amount of transparency when they have been long enough in the alkali; when this is ascertained to be the case, the object is to be placed in a flat receptacle (a shallow pomatum pot is as good a thing as can be used), and put to soak for two or three hours in soft or distilled water. It is then to be placed between two slips of glass, and *gently* pressed till the softer parts, &c. are removed. These will frequently adhere to the edge of the object; it will, therefore, be necessary to wash the latter carefully in water to get rid of the superfluous matter, a process which will be much aided by delicate touches of a camel's-hair brush. Place the object now and then under the microscope to see that all extraneous matter is removed, and when this is accomplished take the specimen up carefully with the camel's-hair brush, and lay it on a piece of very smooth paper (thick ivory note is very good for the purpose), arrange it, if necessary, to its natural appearance with the brush and a finely-pointed needle, place a second piece of paper *over* it, and press it flat between two slips of glass, and compress it by one of the American clips which may be bought for a few pence per dozen.

When *thoroughly* dry (which it will probably be in about twenty-four hours, if in a warm room), separate the glasses, and gently unfold the paper; then, with a little careful manipulation, the object may be readily detached, and should be at once placed in a little spirit of turpentine, where it should remain for a few days till it is rendered transparent and fit for mounting. The time during which it should remain in this liquid will depend on the structure; some objects, such as wings of flies, will be quickly permeated, while horny and dense objects require an immersion of a fortnight or even longer. A pomatum pot with a *concave* bottom and well-fitting lid will be found to answer admirably for the soaking process, and it is well, in preparing several specimens at a time, to have two pots, one for large and medium, the other for very small objects, or the smaller ones will be found often to adhere to the larger.

The glasses on which objects are mounted are usually slips of *flatted crown* or sheet glass cut to a size of three inches by one, and ground at the edges. The mode of mounting the object is as follows:—Having chosen a glass slide, clean and polish it with a piece of chamois leather, ascertain the centre of the slide by means of a piece of paper or card of exactly the same size as itself, and in which a hole has been cut exactly in the centre. place the piece of paper under the slide, and, having removed the object to be mounted from the turpentine in

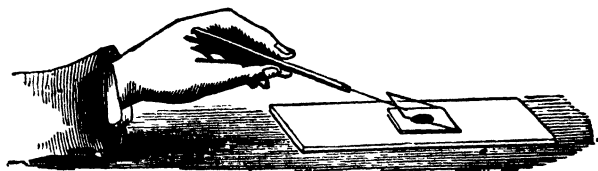

Fig 143f —Showing the mode of placing Glass Cover on the Object.

which it has been soaked, lay it on the slide on the spot corresponding to the hole in the card underneath; then take up a *small* quantity of the prepared Canada balsam on the point of a large needle or pointed pen-knife, and

drop it immediately over the object, *slightly* warm the under part of the slide over a spirit-lamp to diffuse the balsam and cause it thoroughly to penetrate the object, and immediately cover the latter with one of the small circles of thin glass, sold by opticians for the purpose. In laying the glass cover on the object, care should be taken to bring the *edge* of the circle down first, and let the other fall *slowly* on the object (see fig. 143*f*), to prevent the formation of bubbles from the sudden displacement of the air. It requires some little practice to keep the object in the centre of the circle.

Notwithstanding very great care in manipulation, air-bubbles will appear. These may, however, be removed by gently warming the under part of the slide over the spirit-lamp, when the bubbles will usually leave the object, and travel towards the edge of the circle. In most cases they will entirely disappear as the balsam becomes firmer and drier. If it be desired to dry the balsam quickly, the slide may be placed in some warm situation where the heat does not much exceed  $100^{\circ}$ , and it must be maintained in a perfectly horizontal position, to prevent displacement, until the balsam has become dry. When this has been ascertained to be the case, the superfluous balsam which surrounds the edge of the circle may be scraped off by the point of a penknife; and when the major part has been removed in this way, the remainder may be got rid of, and the edges of balsam rendered smooth by rubbing gently with an old silk handkerchief moistened with spirit of turpentine. The edge of the circle of balsam will probably appear white and dull, but it may be rendered transparent by gently warming the under part of the slide over a spirit-lamp, and again placing the object in a warm room till the balsam has a second time become hard and dry; after which the name of the object should be written with a small writing diamond at one end of the slide. Some microscopists prefer to cover the slide with ornamental paper, which may be procured very cheaply.

In covering the slides with paper, their edges need not be *ground*, but may be rubbed with a fine file, which will prevent the sharp glass from damaging the paper cover, and cutting the fingers of the operator. The foregoing is

the method by which objects are mounted in balsam ; there are, however, some specimens, the mounting of which, in balsam, would render them almost invisible, in which case—if not suitable for dry-mounting—they should be placed in fluid in cells, the size and depth of which must be regulated by the proportions of the object. If it be the scale of a fish, or the pollen of a flower, a very shallow cell will suffice, and it may be formed of "Brunswick black" in the manner already described. When the cell is quite dry, take the object (which should have been some time previously soaked in the fluid in which it is to be mounted to dispel the air from its substance), place it in the middle of the circle, fill the space *quite full* of the mounting fluid, and cover it with a glass circle ; *place the edge down first*, and bring the whole surface of the circle very gradually upon the cell as pointed out in the former case. Some of the fluid will immediately escape under the edge ; this may be absorbed by a piece of filtering paper. Should too much escape, a bubble will make its appearance in the cell ; in this case the process must be repeated. When this has been performed successfully, secure the glass circle in its place with a small spring-clip ; then take a camel's-hair brush, charged with varnish, and carry it round, and slightly over the edge of the cover. Allow the first layer to dry before another is added, and continue to add more gradually until the cell is made perfectly air-tight. Glass or metal cells must be employed for those objects whose bulk renders the method just described inadmissible. Glass-cells may be fastened to the glass-slide either by Canada balsam, by Jefferey's marine glue, or Brunswick black ; the latter will be rendered very durable by mixing it with a small quantity of India-rubber varnish (made by dissolving small strips of caoutchouc in gas-tar). The process of mounting in glass-cells is similar to that employed in making varnish-cells, except that a somewhat larger quantity of cementing medium is required on account of the greater weight of the cell. Objects mounted in this way should always be kept in the horizontal position, and a little fresh varnish applied now and then, if the cement show any tendency to crack.

In mounting objects in balsam, great care should be

taken to have the specimens *quite dry* before soaking them in turpentine. Objects mounted in cells, on the contrary should have become *perfectly saturated* with the mounting fluid before being finally secured.

It is preferable to mount and preserve specimens of animal tissues in shallow cells, to avoid undue pressure on the preparation. Cells intended to contain preparations immersed in fluid must be made of a substance impervious to the fluid used; on the whole, the most useful are those made with circles of thin glass, cemented to the glass-slide with marine glue, such as we have here represented (fig. 143*g*). The surface of the glass should be slightly roughened before applying the cement.

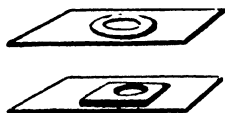

Fig 143*g*.—Glass-cells for mounting.

Different modes of mounting may be employed with advantage, to show different structures; entomological specimens, such as legs, wings, spiracles, tracheæ, ovipositors, stings, tongues, palates, corneæ, &c. show best in balsam: the trachea of the house-cricket, however should be mounted dry. Sections of bone show best when mounted dry, or in a cell with fluid. Scales of butterflies, moths, &c. should be mounted dry. Other objects, as sections of wood and stones of fruit, exhibit their structure best in a cell with fluid.

There are some objects much more difficult to prepare than others, and which tax the patience of the beginner in a manner which can hardly be imagined by any one who has never made the attempt. The structure of many creatures is so delicate, as to require the very greatest care to prevent mutilation, and consequent spoliation of the specimen. The beginner, therefore, must not be discouraged by a few failures in commencing, but should persevere in his attempts, and constant practice will soon teach him the best way of managing intricate and difficult objects. The room in which he operates should be free from dust, smoke, and intrusion, and everything used should be kept scrupulously clean, since a very small speck of dirt, which may be almost invisible by the naked eye, will assume unpleasant proportions under the microscope, and not only

mar the beauty, but possibly interrupt a clear view of a very splendid and delicate object. Then, again, if the microscopist prefers to cut and grind his own glass slips, he should be very careful that there are no sand-specks or air-bubbles in the centre of the slide, or of the glass cover: many a good object has been spoiled from neglect of this precaution. A good light by which to work is also highly important. In using the ordinary microscope, the microscopist should keep *both eyes open*, the practice of closing the eye not in use being injurious to the sight of both. The beginner who is about to purchase a microscope, will do well to procure a *binocular*, the price of which has been reduced so much as to bring it within the reach of those of even moderate means.

In mounting objects in fluid, the glass cover should come nearly, but *not quite*, to the edge of the cell; a slight margin being left for the cement, which ought to project slightly over the edge of the cover, in order to unite it securely to the cell.

To preserve and mount diatomaceæ in as nearly as possible a natural condition, they should be first well washed in distilled water and mounted in a medium composed of one part of spirits of wine to seven parts of distilled water. The siliceous coverings of the diatoms, however, which show various beautiful forms under the higher powers of the microscope, require more care in preparation. The guano, or infusorial earth containing them, should first be washed several times in water till the water is colourless, allowing sufficient time for precipitation between each washing. The deposit must then be put into nitrohydrochloric acid (equal parts of nitric and hydrochloric acids), when a violent effervescence will take place. When this has subsided, the whole should be subjected to heat, brought nearly up to the boiling-point, for six or eight hours. The acid must now be carefully poured off, and the precipitate washed in a *large* quantity of water, allowing some three or four hours between each washing, for the subsidence of some of the lighter forms. The sediment must be



examined under the microscope with an inch object-glass, and the siliceous valves of the diatoms picked out with a coarse hair or bristle.

Dr. Reznor's Mechanical Finger (fig. 143*h*) for selecting and arranging diatoms, adaptable to any microscope, is made to slip on to the objective far enough to have a firm bearing, and so that the bristle point can be brought into focus when depressed to its limit. It is clamped in its place by a small thumb-screw. The bristle holder slides into its place so that it can be brought into the centre of the field. When using the finger, the bristle is first raised by means of the micrometer screw till so far within focus as to be nearly or quite invisible, then the objective is focussed on to the

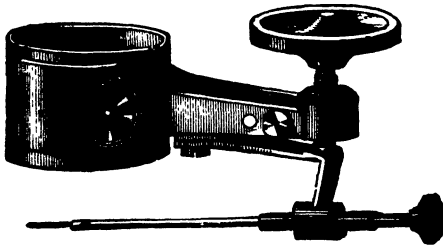

FIG. 143*h*.—Reznor's Mechanical Finger.

slide, and the desired object sought for and brought into the centre of the field; the bristle point is then lowered by the screw until it reaches the object, which usually adheres to it at once, and can then be examined by rotating the bristle wire by means of the milled head. Professor H. L. Smith offers some useful hints which will facilitate the use of this finger.<sup>1</sup>

The medium used for mounting diatomaceæ is of very considerable importance, inasmuch as their visibility is either diminished or much increased thereby. Professor Abbe, experimenting with the more minute test-objects, diatoms, &c., found monobromide of naphthaline gave increased definition to most of them. This liquid is colourless, somewhat of an

<sup>1</sup> *Journal of the Royal Microscopical Society*, Vol. II., 1879, pp. 952-3.

oleaginous nature, and is soluble in alcohol. Its density is 1.555, and refractive index 1.6. Its index of visibility is about twice that of Canada balsam. Mr. Stephenson, who first directed special attention to the subject, came to the conclusion that the *visibility* of lined objects depends upon the *difference* of the refractive indices of the *object* observed and the *medium* in which it is placed.

Taking the refractive index of air as 1.0, and diatomaceous silex as 1.43, the visibility may be expressed by the *difference* .43.

The following table may be constructed :—

Refractive indices (taken approximately).		Visibility of silex (Refr. index = 1.43).
Water ... ..	= 1.33	10
Canada balsam ... ..	= 1.54	11
Bisulphide of carbon ... ..	= 1.68	25
Sol. of sulphur in bisulph.	= 1.75	32
„ phosphorus „	= 2.11	67

These data relating to visibility must be taken in connection with the numerical aperture<sup>1</sup> of the objectives and of the illuminating pencil. The effect produced on diatoms is very remarkable, the markings on their siliceous frustules being visible under much lower powers.

So that the visibility of the diatom mounted in phosphorus as compared with balsam is as sixty-seven to eleven; in other words, the image is six times more visible. Mr. Stephenson's phosphorus medium is composed of a solution of solid or stick phosphorus dissolved in bisulphide of carbon. Great care is required in preparing the solution owing to the very inflammable nature of the materials. So small a quantity of the bisulphide of carbon is required to dissolve the phosphorus that the diatom may be said to be mounted in nearly pure phosphorus. Remarkable enough, this medium has the reverse effect upon some other test-objects, as Podura and Lepisma scales, which lose their characteristic markings.

F. M. Rimmington's Glycerine Jelly is especially

(1) Professor Abbe introduced a new expression for aperture (*i.e.*, "numerical aperture"), by which the relative resolving power of different objectives is seen by the reading of their numerical apertures.

adapted for mounting algæ, fungi, vegetable and animal tissues, urinary deposits, casts, epithelium, crystals, starch granules, diatomaceæ, &c. For certain delicate organisms, as the desmidiaceæ, whose plasma may be affected by too dense a medium, the jelly may be diluted one-quarter or one-third with camphor-water.

Dr. E. Kaiser describes a process for preparing a pure glycerized gelatine:—Take one part by weight of the finest French gelatine, steep for about two hours in six parts by weight of distilled water, and add seven parts of pure glycerine. Then to every 100 grams of the mixture 1 gram of concentrated carbolic acid. The whole must be warmed for ten or fifteen minutes, stirring all the while until the flakes produced by the carbolic acid have disappeared. Then filter while still warm through the finest spun glass, previously washed in distilled water. When cold the preparation can be used like Canada balsam. This medium is also an excellent embedding substance for section-making. For this purpose the objects must be placed in the glycerine-gelatine after again warming. When sections of objects have to be made so delicate that there is danger of their falling to pieces after cutting, the object must be left in the warmed glycerine-gelatine until it is thoroughly penetrated by the latter. The gelatine may be removed from the tissues by a fine jet of warm water after the section is made and placed on the slide. For imbedding hard tissues glycerine-gelatine is an excellent medium, for after it is set, any degree of hardness may be imparted to them by treating with absolute alcohol, the time required for this being from ten to thirty minutes. One special recommendation of this substance for imbedding is its transparency, which enables the operator to see the precise position of the object.

For mounting numerous minute objects, *Ralf's Carbolic Acid Fluid* is a very useful medium; it is more simple, cleanly and rapid than turpentine for insects, small crustaceans, moluscs, &c. The purest crystals of carbolic acid, with just sufficient water added to render them fluid, produces the best

results. No more should be dissolved than can be used up, as after solution the light spoils it, and gives it colour. Vegetable tissues, foraminifera, the palates of moluscs (the latter, after boiling in liquid potash, and washing in water to remove all traces of alkali), may be immersed in carbolic acid. If it be wished to mount them forthwith, then place the specimen, after washing in a glass slip, and drop one or two drops of acid upon it. Should it appear to be thick or cloudy, warm the slide over a spirit lamp; set it aside to get cool, and drain away the acid, or remove it with blotting-paper. If not perfectly clear add another drop or two of fresh carbolic acid and again warm it; place a cover-glass over it, remove as much of the acid as possible, and then let a drop of fluid Canada balsam run under the cover to take the place of the acid. Gently warming the slide will facilitate this operation. A number of specimens may be put into a test tube with the carbolic acid solution and boiled for a few minutes, corked up tightly, and put aside for mounting at leisure, either in balsam or dammar. When the balsam becomes too thick, it can be rendered fluid by adding either benzoline or chloroform.

Dammar varnish for cementing the cover-glass is prepared as follows:—

Take of gum dammar, 1 oz.; spirits of turpentine, 1 oz.; dissolve by gentle heat: then take gum mastic, 1 oz.; chloroform, 2 oz.; dissolve without heat, and, having filtered out all impurities, mix the two solutions together by shaking.

*Method of Cementing.*—After many years' experience, I have arrived at the conclusion that for cementing down the cover-glass, there is nothing better than either gold size or gum dammar varnish. The latter, for some preparations, will be improved by the addition of a small proportion of india-rubber dissolved in naphtha. Whichever is used, it should be applied with care and some skill. The brush should be held nearly in the upright position, and the turn-table spun round rapidly, so that the gold size may form a warm ring round the outside of the cover-glass. After the

gold size has become dry and the slide cleaned off, it may be coloured by aniline mixed in a little cement, or by a coating of water-colour, over which a final thin coating of gold size should be applied.

A good ringing medium for balsam mounts is dammar dissolved in chloroform, because if it is inclined to run under the cover it will readily mix with the mounting material without leaving a visible trace behind. It is better to apply the brush to the edge of the cover almost dry, the slide on the turn-table being made to spin rapidly round, so as to create a track in which the dammar solution will readily flow. The second application is made immediately to follow the first, with the brush full, so that there will be a small drop of solution on the end, and this is allowed to touch the edge of the cover without letting the brush itself come in contact with the glass. This process must be repeated until the ring is built up to the proper size. In drying, however, the ring of dammar will shrink considerably, and thus it is necessary to make a subsequent application in a few hours' time.

Wash away all surplus glycerine by syringing, then apply a ring of a waterproof cement around the cover. Such a cement may be bought under the name of Bell's cement. A better and less expensive cement may, however, be made by dissolving 10 grs. of gum-ammoniac in 1 oz. of acetic acid (No. 8); then add to this solution 2 drachms of Cox's gelatine. This liquid flows easily from the brush and is waterproof, rendered more so if subsequently brushed over with a solution of 10 grs. of bichromate of potash in 1 oz. of water. But what especially recommends this cement is its adhesive power to glass, even should there be a little glycerine left behind on the cover. After the gelatine ring is dry any kind of cement may be employed. When a considerable number of different objects are being prepared at the same time, write the name of each with pen and ink upon the glass slide.<sup>1</sup>

*Mounting Polyzoa.*—Mr. Morris, of Bath, has succeeded in obtaining beautiful specimens of polyzoa and

<sup>1</sup> Mr. C. Sellar, *Microscopical Journal*.

hydroid zoophytes, with tentacles expanded, by adding spirit of wine, drop by drop, to the salt-water cell in which they are confined. Animals should be killed in this way as soon as possible after capture.

A plan of mounting objects in a mixture of balsam and chloroform is described by Mr. Wm. Henry Heys in the *Microscopical Journal*:—Take a quantity of the oldest balsam procurable, and place it in an open glass cup, and mix with it as much chloroform as will make the whole quite fluid, so that a very small quantity will drop from the lip of the containing vessel. Then put this prepared balsam into long thin half-ounce phials, and cork and set them aside for at least a month. The advantage of having the medium ready-made is, that there is no waste, and none of the usual and troublesome preparation required for putting up objects in Canada balsam; if it has stood for some time, it loses the yellow tinge which is observable in most samples when first mixed, and, moreover, air-bubbles escape more readily.

Goadby's fluids are cheap and efficient for preserving and mounting animal structures. The following are his formulæ:—

Take for No. 1 solution, bay salt, 4 oz.; alum, 2 oz.; corrosive sublimate, 2 grains; boiling water, 1 quart: mix. For No. 2 solution, bay salt, 4 oz.; alum, 2 oz.; corrosive sublimate, 4 grs.; boiling-water, 2 quarts: mix.

The No. 1 is too strong for most purposes, and should only be employed where great astringency is needed to give form and support to very delicate structures. No. 2 is best adapted for permanent preparation; but neither should be used in the preservation of animals containing carbonate of lime (the mollusca), as the alum becomes decomposed, and sulphate of lime precipitated. For the preservation of crustaceans use the following:—

Bay salt, 8 oz.; corrosive sublimate, 2 grs.; water, 1 quart: mix.

The corrosive sublimate is used to prevent the growth of vegetation in the fluid; but it also pos-

esses the property of coagulating albumen, and therefore cannot be used in the preservation of ova, cellular tissue, the white corpuscles of the blood, &c.

Goadby's method of preparing *marine-glu*e for cementing cells is as follows: dissolve separately equal parts of shell-lac and india-rubber in coal or mineral naphtha, and afterwards mix the solutions carefully by the application of heat. It may be rendered thinner by the addition of more naphtha, and redissolved, when hard or dry, by adding naphtha, ether, or liquid potash.

### *Multiple Staining, Animal and Vegetable.*

Within a short period of time the staining of animal and vegetable tissues for microscopical examination may be said to have almost superseded injections. The results obtained lent a charm to the staining process, and it was soon seen that other and far more important advantages could be gained by its adoption and further development. Formative tissue and structural differences, heretofore difficult to differentiate, were by a method of double staining, that is dying the tissues of two or more colours, made instructive and palpable even by the aid of only moderate powers of the microscope.

Various methods, mostly differing in details, have been from time to time proposed for the combination of colours and producing striking and permanent results. One of the most useful manuals of reference on the subject is Dr. Thin's,<sup>1</sup> whose experience is founded on methods adopted by continental schools, and that of Ranvier's in particular. The student is recommended to provide himself for ordinary histological work, and which he should as far as possible become proficient in before he can expect to succeed in staining and preparing tissues, the following instruments:—Two needles fixed in handles; strong and fine scissors; a scalpel; a razor; flat on the under surface and slightly grooved on the upper; a section-lifter or

(1) An Introduction to Practical Histology, by George Thin, M.D. Bail-  
lère, Tindall & Cox, King William Street, Strand.

spud for removing sections from one fluid to another ; several glass-rods or pipettes ; a dozen glass phial bottles for containing reagents and staining fluids ; glycerine ; acetic acid, osmic acid, alcohol, methylated spirit, distilled water, &c. ; and lastly, a few camel's-hair brushes, watch-glasses, and two or three porcelain capsules. All spirits should be kept in well-stoppered bottles. For dissections and the examination of small animals, or portions of larger, and of tissues in general, a dissecting microscope fitted with two or three powers will be found most convenient. The method of teasing out with needles is shown in the annexed fig. 143*i*.

All animal tissues should be examined in as fresh a state as possible, and kept in blood serum, white of egg, or a very weak solution (1 part of salt in 200

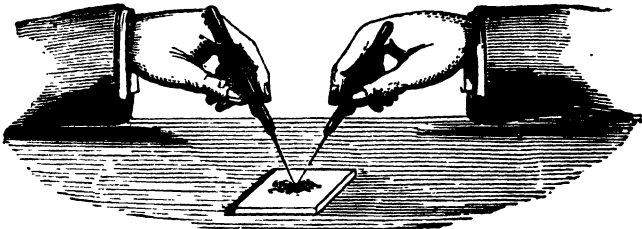

FIG. 143*i*.—*Microscopic Dissection. Teasing out with Needles.*

parts of water) of salt. For hardening tissues, sections, or organs, use the following reagents :—Absolute alcohol, methylated spirit, solutions of chromic acid (some prefer a mixture of the latter and alcohol), of bichromate of potash, picric acid, chloride of palladium, and Müller's fluid. All solutions of corrosive agents should be used weak. Chromic acid, a quarter or at most a 1 per cent. solution ; of bichromate of potash, 1 or 2 per cent., picric acid, a saturated solution ; chloride of palladium a one-tenth per cent., with a few drops of hydrochloric acid added to prevent change. Müller's fluid is made by adding together equal parts of a 2 per cent. solution of bichromate of potash and a 1 per cent. solution of sulphate of soda. A short immersion in either of these solutions prepares tissues



for teasing out; for hardening they require to be kept in either Müller's fluid or chromic acid for a few days, and to complete the process by transferring to alcohol or methylated spirit for from 12 to 24 hours. When employing chromic acid, bichromate of potash or picric acid, immerse only a small portion of tissue in a large quantity of either fluid, always changing it in 12 or 24 hours. Osmic acid not only hardens but stains tissues, and sections can be cut without subsequent immersion in alcohol. Sections of skin, and cornea, can also be made after reduction by the chloride of gold in acidulated water; a half per cent. of either chloride of gold or of nitrate of silver will be found strong enough for most purposes. A 1 or a  $1\frac{1}{2}$  per cent. of chloride of gold is recommended for very special specimens. The most commonly used colour stains are carmine, logwood, picro-carminate of ammonia (which combines the action of picric and carmine), hæmatoxyline and the aniline colours, as magenta, commercially known as roseine or acetate of rosaline, aniline red, eosin, aniline blue, violet, and methyl-aniline. Purpurine, a dye extracted from madder, is also highly spoken of as a stain by Ranvier; Dr. Thin strongly recommends it. It is prepared for use as follows:—"A solution of 1 part of alum in 200 parts of distilled water is brought to the boiling point in a porcelain capsule, and a small quantity of solid purpurine rubbed up in a little distilled water is added to it. The purpurine quickly dissolves, but there should remain a small quantity undissolved, which indicates that the solution is concentrated. It must be filtered whilst hot into rectified spirit. The alcohol should constitute a fourth part of the total volume of the mixture. The fluid obtained is of a beautiful orange red by transmitted light: it is, in fact, fluorescent. At the end of a month a slight precipitate is observed, and it begins to lose some of its colouring matter. Tissues should remain in it from twenty-four to forty-eight hours. Aniline blue-black is strongly recommended for staining the nerve-cells of the brain and spinal cord.

To produce a third stain, Schwarz proposed picric acid in combination. A mixture of picro-carmin, he tells us, is a preferable stain for the unstriped muscle of the intestines, &c. Ranvier also employs a picro-carminate; he discovered that a good green stain could be obtained by dissolving picric acid in glycerine, diluting it with a decoction of logwood, and adding a small quantity of a solution of chromate of potash in the proportion of 1 part to 1,000. The solutions must be mixed together just before they are wanted for use, as they rapidly spoil.

Dr. W. Stirling<sup>1</sup> furnishes a brief but useful account of the methods he has employed with success for some time for double and treble staining.

*Osmic Acid and Picro-carmin.*—Mix on a glass slide a drop of the blood of newt or frog and a drop of a 1 per cent. aqueous solution of osmic acid, and allow the slide to stand by. This will fix the corpuscles without altering their shape. At the end of five minutes remove any excess of acid with blotting-paper, add a drop of a solution of picro-carmin, and a trace of glycerine to prevent evaporation, and set aside for three or four hours to see that no overstaining takes place. At the end of this time the nucleus will be found to be stained red, and the perinuclear part yellow.

*Picric Acid and Picro-carmin.*—Place a drop of the blood of a frog or newt on a glass slide, and add a drop of a saturated solution of picric acid: put the slide aside and allow it to remain for five minutes; at the end of that time, when the acid has fixed the corpuscles (that is coagulated their contents), any excess of acid should be removed as before. A drop of a solution of picro-carmin should now be added, and a trace of glycerine, and the preparation set aside for an hour. At the end of that time remove the picro-carmin solution by means of a narrow slip of blotting-paper, and add a drop of Farrant's solution or glycerine and apply glass-cover. The perinuclear part of the corpuscles will be seen to be highly granular and of a deep orange colour, whilst the nucleus is stained red.

(1) *Journal of Anat. and Physiol.*, xx. 1881, p. 349.

Some of the corpuscles will appear of a delicate yellow colour, and threads are seen extending from the nucleus to the envelopes. The preparation should be preserved and mounted in glycerine.

*Picro-carmin and Aniline Dye.*—For glandular tissue, none of the aniline dyes answer so well as iodine green, used in the form of a 1 per cent. watery solution. Stain the tissue in picro-carmin, wash it in distilled water, acidulated with acetic acid, and stain it in a solution of iodine green. As it acts rapidly, care must be taken not to overstain. Wash the section in water, and then transfer it to alcohol; finally clear with oil of cloves. The washing should be done rapidly, as the spirit dissolves out the green dye. All preparations stained with iodine green must be mounted in dammar.

*Picro-carmin and Iodine Green.*—Stain a section of the cancellated head of a very young bone (foetal bone) in picro-carmin, wash it in distilled water, and stain it with iodine green and mount in dammar. All newly-formed bone is stained red; that in the centre of the osseous trabeculæ, the residue of the calcified cartilage in which the bone is deposited, is stained green. Many of the bone corpuscles are also stained green.

Ossifying cartilage, the back part of the tongue, Peyer's Patch, solitary-glands, trachea, and bronchus, may all be treated in the same way. In preparing the skin, take a vertical section from the sole of the foot of a foetus. The cuticle and superficial layers of the epithelium are dyed yellow, the rete Malpighii green, and the continuation of these cells can be traced into the ducts of the sweat-glands, which are green, and form a marked contrast to the red stained connective tissue of the cutis vera; through which they have to ascend to reach the surface. The outer layer of the grey matter of the cerebellum with Purkinje's cells is, when double stained, red, while the inner or granular layer is green. Logwood and iodine green stains the mucous glands of the tongue (green), and the serous glands, lilac logwood stain.

*Eosin and Iodine Green.*—Eosin is used as the ground

colour. Stain the tissue in an alcoholic solution of eosin, which will colour it very rapidly, usually in a few seconds. Wash the section thoroughly in water acidulated with acetic or hydrochloric acid, a 1 per cent. solution, and stain with iodine green. This will double stain bone and cerebellum; but if logwood is substituted for the latter, the cerebrum and general substance become stained by the eosin, while the logwood colours the nerve-cells a lilac.

*Gold Chloride and Aniline Dyes.*—The tissue must be impregnated with chloride of gold, and then stained with either aniline blue, iodine green, or rosein. The tail of a young rat, containing as it does so many different structures, is an excellent material for experimenting upon. Remove the skin from the tail, and place pieces half an inch long into the juice of a fresh lemon for five minutes, wash it to get rid of the acid. The fine tendons swell up under the action of the lemon acid, and permit of the more ready action of the chloride of gold solution. Place the piece for an hour or more in a 1 per cent. solution of gold, remove it and wash it thoroughly, and then place it in a 25 per cent. solution of formic acid for twenty-four hours. This reduces the gold: during the process of reduction the preparation must be kept in the dark. The osseous portion has then to be decalcified in the ordinary way, with a mixture of chromic and nitric acid. After decalcification preserve the whole in alcohol. Transverse sections of the decalcified tail are made, and may be stained with a red dye, as rosein, and afterwards with a watery solution of iodine green. Mounted in dammar.

Dr. Taffani found that solutions of aniline blue and picric acid produce beautiful green-coloured preparations of the lymphatics, spinal cord, &c. The action of picric acid is not like that of chromic acid, which enters into combination with the substances upon which it reacts, and which, after being hardened, will often part with all colour by repeated washings. The action of picric acid is decidedly less detrimental to most tissues than chromic acid.

Dr. Seiler uses by preference the simple carmine

solution of Dr. J. J. Woodward, made as follows:— Best carmine, 15 grains; borax, 1 drachm; water, 5½ ounces; alcohol (95 per cent.), 11 ounces: mix and filter. Sections placed in this fluid will be stained evenly, in a few seconds, of a violet-red colour. Remove quickly and immerse them in a solution of hydrochloric acid 1 part, alcohol 4 parts. Let them remain until they assume a bright rose colour—this will be accomplished in a few seconds. Wash the sections in distilled water and then transfer them to alcohol and finish off in the usual way. Specimens thus treated will have their nuclei and granules stained, while the cell contents and fibrous tissue remain uncoloured.

The second solution is one composed of carmine and indigo. The sections stained with the carmine solution must be immersed in a weak solution, 2 drops of sulphin-digotate of soda in one ounce of a 95 per cent. alcoholic solution, which should be filtered before using, and there left from 6 to 18 hours, according to the rapidity with which the elements take up the indigo. When sufficiently stained, the sections are immersed in strong alcohol; they are then ready for mounting. The sulphin-digotate of soda as prepared by Bullock makes a solution of a deep greenish-blue colour, and the effect of the paint upon the section is to leave the nuclei bright red, while the fully-formed material of the cell is slightly tinged blue. The connective tissue fibres become stained deep blue, and the blood vessels are purplish and mapped out with distinctness. Epithelium cells and hair take the stain in a distinctive manner, thus affording a means of differentiation in epithelioma, the so-called pearls being brought out of a different colour from the rest of the cells.

Mr. J. W. Groves,<sup>1</sup> in an instructive paper on stained sections of animal tissues, says the rule of almost universal application is that the fluid should be weak and the quantity large in proportion to the number of sections, or to the mass. A section placed in a solution so weak that 24 or 48 hours or more is required to give

(1) *Journal of the Quekett Microscopical Club*, Nov., 1879, p. 231.

it the requisite tint is always better stained than one which has been a much shorter time, because the surface becomes stained before the colour has reached the deeper parts. The sections, for the same reason, should be as thin as possible, as they take the stain more perfectly, and then the deeper portions are seen under the microscope as distinctly as the more superficial. Provided the staining is perfect and sufficient to show all details, the paler it is the better, as it requires less light, and is less likely to fatigue the eye. The tints to be preferred are those that convey a cool and pleasant sensation to the eye. Intense reds and yellows are not nearly so pleasant as lilacs and pale blues. Stains which impart only a body-colour are of no value in differentiating structure. Distilled water should always be used for washing and all staining purposes. A five per cent. neutral aqueous solution of molybdate of ammonia produces a cool blue-grey stain in 24 hours. Eosin is a selective body-stain, which may be used either before or after the sections have been coloured with logwood. One part of eosin dissolved in a 1,000 parts of water is quite strong enough. But there is no more useful selective stain, or one more pleasant to work with, in Mr. Groves's opinion, than logwood.

Kleinenburg's solution of logwood, modified by Golding Bird, is prepared as follows:—

1. Make saturated solutions of alum and calcium chloride, in proof spirit.
2. Mix in the proportions of eight of the former to one of the latter.
3. Pound a small piece of ext. hæmatoxyli (the older the better); add it to the mixed solution, and agitate. After it has been allowed to stand two days, filter for use. A watch-glass should be filled with water, and a few drops of the mixed solutions added, till the fluid acquires a mauve tint. Into this the sections should be placed, and allowed to remain for twenty-four hours or more.

Another stain.—Schäfer's acid logwood solution is especially useful for certain structures, as tendon, cells, &c. It is thus prepared:—A one per cent.

solution of acetic acid is coloured by the addition of 1.3 of its volume of logwood solution.

The aniline dyes, whether in aqueous or alcoholic solutions, give good results, and are prepared as follows: Roseanilin or magenta (1gr. to loz. of alcohol), red; Acetate of mauvein (4gr., alcohol loz., acid nitric 2 drops), blue; aniline black (2gr., water loz.), grey-black; Nicholson's soluble blue (1.6gr., alcohol loz. and nitric 2m.), blue.

These stains should be used weak; and specially observe that after sections are stained they should be passed through alcohol and oil of cloves as rapidly as possible; otherwise, the colour will dissolve out before they can be mounted in balsam.

Heidenhain, speaking of the use of aniline dyes, says:—"The sections, upon removal from alcohol, should remain for a day in a four per cent. neutral aqueous solution, in a moist place, and then be immediately mounted in glycerine and cemented."

Some aniline dyes are but sparingly soluble in alcohol, whereas they dissolve readily in water. Their colour is increased by acetic acid, and removed by ammonia. There are, however, exceptions. Use benzole for clearing instead of clove oil; this fixes the colours better, but it has a tendency to produce shrinking in certain structures.

The indigo carmine solution of Tiersch is a good and useful blue stain for sections of brain and spinal cord after they have been hardened in chromic acid; it possesses one convenient quality—viz., that if the sections are too deeply stained, any excess of colour may be removed by the action of a saturated solution of oxalic acid in alcohol. This reducing process should be used with caution. Tiersch's fluid consists of:—Oxalic acid, 1 part; distilled water, 22 to 30 parts; indigo carmine, as much as the solution will take up. A further dilution with alcohol may be necessary; the sections should be immersed in it from 12 to 48 hours; the colour will determine the time.

Beale's fluid is thus prepared:—Carminc, 10gr.; liq. amm. fort., 30m.; glycerine, 2oz.; distilled water,

2oz. ; Sp. vini rect.,  $\frac{1}{2}$ oz. Dissolve the carmine in the ammonia, boil for a few seconds, add the water, filter, and finally add the glycerine and spirit, and keep in a stoppered bottle. Beale says: "Let the excess of ammonia pass off;" but this is unnecessary, as the excess is very slight. This solution reduced, with eleven times its bulk of water, produces good results in from 12 to 48 hours.

Borax carmine, as follows:—(1) carmine,  $\frac{1}{2}$ dr.; (2) borax, 2dr.; (3) distilled water, 4oz. Rub 1 and 2 together in a mortar and gradually add the water; let them stand in a warm place for 24 hours, after which pour off the supernatant fluid, and the solution is ready for use.

There are stains which, being acted upon by light, get rapidly darker, and become opaque, and reach a stage when they are utterly useless.

*Nitrate of silver* darkens by exposure; it is used in a half per cent. watery solution. Specimens to be acted upon should be washed in distilled water to remove every trace of sodium chloride, and then steeped in the silver solution for some two or three minutes, after which they should be again washed until they cease to turn milky; then place them in glycerine and expose them to the action of light until they assume a dark brown colour, when they should be mounted in glycerine or glycerine jelly.

By means of this stain the endothelial cells of the lymphatics, blood-vessels, &c., and the nodes of Ranvier, in medullary nerves, are rendered visible. Sections of any of these may subsequently be stained by logwood or carmine.

Several methods have been adopted for staining with gold chloride. Dr. Klein's and Mr. Schäfer's are among the best.

1. Dr. Klein's method of showing the nerves of the cornea is as follows:—Remove the cornea within fifteen minutes of death; place it in a half per cent. chloride of gold solution for half an hour or an hour; wash in distilled water, and expose to the light for a few days; in the meantime occasionally change the water. Then



immerse it in glycerine and distilled water, in the proportion of one to two; lastly, place it in water, and brush gently with a sable pencil to remove any precipitate, when it will be fit for mounting in glycerine. The colour of the cornea should be grey violet.

Mr. Schäfer adopts another method—a double chloride of gold and potassium solution.

Osmic acid, first used by Schultze, is useful for the demonstration of fatty matters, all of which it colours black; it is also valuable for certain nerve preparations. Specimens should be allowed to remain in a 1-2 per cent. aqueous solution of the acid from a quarter to twenty-four hours, when the staining will be completed; but if it is desired to harden specimens at the same time, they should remain in it for some few days. Osmic acid does not penetrate very deeply, therefore small portions should be selected for its action.

Chloride of palladium, another of Schultze's staining fluids, is used to stain and harden the retina, crystalline lens, and other tissues of the eye; the cornified fat and connective tissues remaining uncoloured. The solution should be used very weak:—Chloride of palladium, 1 part; distilled water, 1,000 parts. Specimens should be mounted in glycerine at once, or further stained with carmine.

Schäfer also employs a silver nitrate and gelatine solution for demonstrating lung epithelium; this is made as follows:—Take of gelatine 10 grm., soak in cold water, dissolve, and add warm water to 100c.c. Dissolve a decigramme of nitrate of silver in a little distilled water, and add to the gelatine solution. Inject this with a glass syringe into the lung until distension is pretty complete. Leave it to rest in a cool place until the gelatine has set; then cut sections as thin as possible, place them on a slide with glycerine, and expose to light until ready for mounting.

Of the double stains Mr. Groves refers only to those where the double colour is produced by a single process. Those in which one colour is first employed, and then another. Those used as a single fluid are—Picro-

carmine, carmine and indigo carmine, aniline blue and aniline red.

Picro-carmine is specially useful for staining sections hardened in picric acid. It is prepared in several ways:—

1. Add to a saturated solution of picric acid in water a strong solution of carmine in ammonia to saturation.

2. Evaporate the mixture to one-fifth its bulk over a water bath, allow it to cool, filter from deposit, and evaporate to dryness, when picro-carmine is left as a crystalline powder of red-ochre colour.

Sections can be stained in a 1 per cent. aqueous solution, requiring only ten minutes for the process; wash well in distilled water, and transfer them to methylated alcohol, then to absolute alcohol, after which they can be made transparent by immersing in oil of cloves or benzole, before mounting in balsam or dammar.<sup>1</sup>

The carmine and indigo fluids adopted by Merbel give a blue and a red stain, and are very selective. To prepare the red fluid, take—Carmine, 2dr.; borax, 2dr.; distilled water, 4oz. For the blue fluid, take—Indigo carmine, 2dr.; borax, 2dr.; distilled water, 4oz.

Mix each in a mortar, and allow it to stand, then pour off the supernatant fluid. If the sections have been hardened in chromic acid, picric acid, or a bichromate, they must be washed in water till no tinge appears. Place them in alcohol for fifteen or twenty minutes, then in the two fluids mixed in equal proportions, after which wash them in a saturated aqueous solution of oxalic acid, where they should remain a rather shorter time than in the staining fluids. When sufficiently bleached, wash them in water, to get rid of the acid, then pass them through spirit and oil of cloves, and mount in balsam or dammar.

To summarize Mr. Groves' recommendations:—

1. Let the material be quite fresh.
2. *a.* Take care that the hardening or softening fluid

(1) See Rutherford, "Outlines of Practical Histology." Most of the staining agents mentioned may be obtained of W. Martindale, chemist, 10, New Cavendish Street, W.

is not too strong. *b.* Use a large bulk of fluid in proportion to the material. *c.* Change the fluid frequently. *d.* If freezing be employed, take care that the specimen is thoroughly frozen.

3. *a.* Always use a sharp razor. *b.* Take it with one diagonal sweep through the material. *c.* Make the sections as thin as possible; and *d.* Remove each one as soon as cut, for if sections accumulate on the knife or razor they are sure to get torn.

4. *a.* Do not be in a hurry to stain, but *b.* Remember that a weak colouring solution permeates the section better, and produces the best results; and *c.* That the thinner the section the better it will take the stains.

5. *a.* Always use glass slips and covers free from scratches and bubbles, and chemically clean. *b.* Never use any but extra thin circular covers, so that the specimens may be used with high powers. *c.* Always use cold preservatives, except in the case of glycerine jelly, and never use warmth to hasten the drying of balsam or dammar, but run a ring of cement round the cover.

6. Label specimens correctly, keep them in a flat tray and in the dark.

Dr. Cook pointed out that the results obtained by logwood were often unsatisfactory, and not fairly stable, because it must be understood that its colouring material consists of two substances, hæmatoxylin and hæmatein, differing from each other by two equivalents of hydrogen. The first named, containing the larger amount of hydrogen, is soluble in alum solution, while the latter, the hæmatein, is only slightly so, and is of no use for the colouring of animal tissues. Hæmatoxylin forms compounds with various metallic oxides; and a solution of hæmatoxylin, alum, and a metallic oxide, has a clear purple colour, becoming red on the addition of an acid. If an alkaline earth, hydrated earthy phosphate, be suspended in it, it will absorb the colour, and the solution will become purple. If the solution be treated with a very small percentage of a chromate, the purple will be gradually replaced by a yellowish-brown colour; or if a tissue, stained with

alum logwood, be immersed in an exceedingly dilute bichromate solution, the purple will be replaced by a yellow tint. It therefore follows that sections hardened in chromic acid solutions, will not colour nearly so readily as if immersed in the fresh state. But it has been found that this objection may be overcome if the sections are well washed and immersed in a modified solution of logwood. The most practical form is made as follows:—Take of logwood extract 6 parts; alum, 6 parts; sulphate of copper, 1 part; water, 40 parts. All ingredients must be free from iron. Grind up the powders together in a mortar, and when powdered add water sufficient to form a thin paste; put them by and leave them for a day or two in this state, then add the rest of the water and filter the solution. The hæmatein will be separated and left behind in the filter; and a crystal of thymol may be added to preserve the solution from moulding. For chromic hardened tissues, dilute 8 drops of the fluid with 120 of water, and add one drop of a one-tenth per cent. solution of bichromate of potash just before using the solution. Wash the stained tissues as usual in water, and mount in glycerine, Farrant's solution, or dammar. In the former they keep best, in the last they are apt to fade, unless the sections be thoroughly freed from water by being immersed in absolute alcohol, before being brought into contact with oil of cloves. If any moisture be left behind, the preparations will be sure to spoil.

A modified Farrant's solution may be prepared as follows:—Take of gum arabic 5 parts; water, 5 parts; when the gum is fairly dissolved add 10 parts of a five per cent. solution of carbolic acid.

*Hardening, Preserving, and Section-cutting.*—Whatever be the hardening or softening fluid employed (for this is necessary when bone is the structure about to be examined), its bulk should be large in proportion to the size; half a pint of fluid for a piece of about one cubic inch. The strength of the fluid must be made to suit the tissue about to be acted upon, and the fluid should be changed frequently, even though it

be alcohol that is employed. It is better that any and every solution should be *too weak* than too strong; for in the latter case the tissue is liable to become friable and break down under the cutting knife or razor, and the sections will not take the stain evenly. To recapitulate and enforce one or two points of importance, note that the most useful strength for chromic acid is a  $\frac{1}{2}$  or  $\frac{1}{4}$  per cent. solution; for the bichromate of potash or ammonia  $1\frac{1}{2}$  or 2 per cent. solution. When either of the latter solutions are used the material must be removed to an alcoholic solution in a week, or ten days at most, or it will become very brittle. Alcohol is one of the best fluids for those to use who have not much time to devote to the subject; tissues hardened in alcohol afford, as a rule, the best staining results. The price of alcohol is much against its use, but it may be used weak at first, and gradually increased in strength until the material is found hard enough to cut with a knife. For cutting sections by hand the best substance for embedding is a mixture of equal parts of olive oil and white wax; or Cacao butter, or even soap dissolved in alcohol (*Micros. Journal*, vol. ii. p. 940, 1879); while in section-cutting machines with hollow cylinders, either the pith of elder, carrot, or some other soft substance may be employed. If a razor is used, its surface must be kept moist with water when the freezing process is adopted, or with spirit when the hardening process without freezing is used. By the freezing method we are enabled to cut and finish off specimens sooner and more expeditiously than by any other process. The material about to be frozen must be removed from the hardening fluid and well washed in clean water before it is transferred to the machine. Zeiss's microtome, with its surface of glass, a practical and useful cutting and freezing machine, can be obtained at a moderate price, of Baker, Holborn.

Swift's freezing microtome has the advantage of preserving the preparation for some hours unchanged in the frozen state. The method of using it is as follows:—Remove the lid of the box and fill the cham-

ber with equal parts of pulverized ice and salt, care being taken not to allow the mixture to touch the under side of the cover, which, when replaced, must be firmly secured by the clamp screw. The substance to be cut must be placed on the surface of the central circular brass piece (there are three additional ones supplied with the instrument) and surrounded with a little common gum water, which readily congeals, and, as shown in the



FIG. 143k.—Swift's Microtome and Section-cutting Machine.

woodcut, holds the specimen firmly in position, until solidified and frozen. The edge of the razor or knife must be raised by the three screws supporting the frame to the required height for cutting sections. After the first cut, each end of the razor must be again presented to the surface of the specimen, when either end of the blade must be adjusted by one of the back screws until its entire length is level. By turning the large screw in the frame it can also be lowered for each

successive section required. One entire revolution of it produces a section  $\frac{1}{100}$  of an inch in thickness, the screw-head being divided into sixths; thus one division gives a section of  $\frac{1}{600}$  of an inch, but even thinner sections can be cut by turning the screw. Substances that have been previously prepared in spirit or chromic acid should be steeped in syrup for 24 hours, otherwise they will not readily congeal. It is advisable to cover the apparatus with baize, to facilitate the freezing process. The brass cup (shown in the engraving) is used for holding substances embedded in cocoa-butter, or paraffin; it also serves for securing hard wood, &c., when cements or sealing-wax are used.

*Vegetable Tissues.*—Sections of wood and vegetable tissues are susceptible of very fine double and even triple staining dyes; the best are atlas-scarlet, soluble blue, iodine, and malachite-green. Mr. Richardson secured success by steeping sections in spirits of wine for about a fortnight, and when not required for immediate investigation, storing them away in Price's glycerine for at least a couple of months. This renders them less liable to fold or break than when the staining is done immediately after the sections are cut. His method may be gathered from the following directions for preparing and staining sections of palm stem. After the sections are cut they should be bottled up in a tolerably dark solution of atlas-scarlet and spirit of wine. Leave them in this solution, corked up tightly until they become of a uniform scarlet tint. Like sections of animal tissues, however, they may remain in the solution for many weeks without risk of spoiling or counteracting the energy of the green dyes. It is on the whole better to complete the process when the sections seem to be of a deep scarlet colour. Remove them and wash them well in filtered water, repeatedly change the water until it ceases to be in the slightest degree coloured by the sections. Then transfer them to a white porcelain water, containing a solution of spirit of wine, coloured bluish-green by adding a couple of drops of an aqueous saturated solution of the green dyes; a drop of each will be found sufficient. When

the sections appear sufficiently coloured a dark blue, transfer them once more to a saucer of water to which a drop of an aqueous saturated solution of arsenious acid, or of oxalic acid (in the proportion of one grain of oxalic acid to the ounce of water) or glacial acetic acid has been added. Wash by rotating the saucer, then pour off the water and place the sections in a stoppered bottle containing absolute alcohol; which should likewise contain a drop of either of the before-mentioned acids. When all the water has been abstracted from the sections by the alcohol (which will be in about ten minutes) clear with oil of cloves, they are then quite ready for mounting in Klein's or dammar solution. Clematis and other open sections take a very fine treble stain by this method. Buckthorn and sycamore seem to have a great affinity for the green stains, two minutes in staining fluids being usually sufficient to colour the walls of the central cells green and their contents of a light scarlet. The staining of thin sections of potato are equally effective, the starch granules being green, the loculi scarlet, the depth of colour depending upon the length of exposure to the atlas-scarlet, and mixed green dyes; always allowing the malachite to be in excess.<sup>1</sup>

For double-stained vegetable tissues Mr. Barrett prefers some of the cheaper dyes. The sections must be first immersed in an aqueous one per cent. solution of Crawshaw's aniline blue; then removed into a strong acetic acid solution, which fixes the colour in certain tissues, and removes it from others, while it prepares the unstained portion for the reception of another colouring material. It must again be removed into a weak solution of magenta (Judson's dye), acidulated with acetic acid: then washed and mounted in glycerine jelly. By this process sections of burdock are stained, the pith, very pale magenta colour; cellular tissue, deep magenta; spiral vessels of medullary sheath, deep blue; pitted vessels, blue; cambium, deep blue; liber cells, dark magenta; lactiferous vessels, deep blue; cuticle, parenchyma, pale blue; epidermis, deep

(1) *Transactions of the Royal Microscopical Soc.*, page 870, 1861.



blue; hairs, pale magenta. It is almost needless to add that both time and patience are required to attain perfection in double staining.

Those, however, who, from want of time, cannot follow out the details of the several processes should pay a visit to the laboratory of the Messrs. Cole.<sup>1</sup> There they will find a large and choice selection of specimens of animal and vegetable tissues, and which, for perfection in staining, cutting and mounting, cannot be surpassed.

The staining of vegetable tissues will give increased interest to the study of botanical histology; the student in this way will obtain an insight into structure such as can be secured by no other means.

The staining fluids most successfully employed by Mr. Gilbert<sup>2</sup> for staining sections of woods and plants blue and red by the aniline dyes are prepared as follows:—

Magenta crystals	•	•	gr. $\frac{1}{4}$ in	}	Red.	
Alcohol	•	•	loz.			
Then Nicholson's soluble					}	Blue.
pure blue	•	•	gr. $\frac{1}{6}$ in			
Alcohol	•	•	1 oz., to			
which has been added acid nitric $\frac{1}{4}$ drops						

Both solutions should be filtered.

For use take 2 parts of the blue and add it to 7 parts of the magenta, and thoroughly mix.

Place the section in the mixture for about a minute, then remove it to absolute alcohol, from that to oil of cloves or benzole, and finally mount in balsam and benzole.

To fix the magenta it is necessary to pass the sections through benzole.

As a preparation for staining, all tissues should be bleached. This is effected in the case of soft vegetable stems in alcohol; the use of which, although

(1) Arthur Cole and Son, 53, Oxford Gardens, Notting Hill, W., are engaged in the publication of "Studies in Microscopical Science," that is, prepared specimens of typical objects beautifully stained, and drawings of the same, with directions for staining and preparing sections for the microscope. I commend these Studies to the notice of students and teachers.

(2) *Journal of the Quekett Microscopical Club.*

it discharges the natural colour, considerably abridges the process. It has a further advantage, as the cell-contents, starch, chlorophyll granules, &c., are preserved intact, and the nucleus, when it exists, is rendered more palpable by staining.

When the stem is hard and brown, a solution of chloride of lime should be used. A quarter of an ounce of chloride dissolved in a pint of water, well shaken and stood by to settle down, then pour off the clear fluid for use. For hard tissues this solution answers well, but it is not suitable for leaves, as they require not only bleaching, but the cell-contents should be dissolved out to render them transparent. A solution of chlorinated soda answers well for both stems and leaves. It is prepared as follows:—

To one pint of water add two ounces of fresh chloride of lime, shake or stir it well two or three times, then allow it to stand till the lime has settled. Prepare meanwhile a saturated solution of carbonate of soda—common washing soda. Now pour off the clear supernatant fluid from the chloride of lime, and add to it, by degrees, the soda solution, when a precipitate of carbonate of lime will be thrown down; continue to add the soda solution till no further precipitate is formed. Filter the solution, and keep it in a well-stoppered bottle in the dark, otherwise it speedily spoils.

Sections bleached in chlorinated soda must, when white enough, be washed in distilled water and allowed to remain in it for twenty-four hours, changing the water four or five times, and adding a few drops of nitric acid, or at the rate of eight or ten drops to the half-pint, to the water employed before the final washing takes place. From water transfer them to alcohol, in which they must remain for an hour or more.

Sections may be stained in two colours, either by alternate or single immersions.

The first process is as follows:—Transfer the section from alcohol to magenta dye for about twenty minutes, then remove and soak in alcohol till the colour is removed from the parenchyma; next place it about a

For staining by a single immersion, add twelve drops of the blue dye to seven of the magenta, and thoroughly mix. Into this purple stain place the sections for about a minute, then remove them to alcohol; shake well for a few seconds, and proceed as by the former method. The magenta dye stains the woody fibre and vascular tissue; the blue the parenchyma, cambium layer, and medullary rays; while the pith and bark remain neutral, or partake of both.

In deciding upon which colour should be first employed, this will depend upon the particular structure it is wished to bring out more forcibly than another. To show the structure of the lamina use the blue stain, because it displays the cell-walls far more distinctly than magenta. There is some difficulty in fixing magenta, unless it is passed through benzole and not oil of cloves; benzole may, however, produce an injurious effect upon the tissue.

In using blue dye, no fixed time can be laid down for immersion, this so much depending upon the density or permeability of the tissue. Dr. Beatty recommends that two solutions should be prepared—a quarter and a half-grain solution, and that the leaf should be transferred to the stronger if the staining is not completed in the weaker in half an hour. There is, however, one objection to this, that far too much colour may be taken up in parts, and giving the sections a very mottled appearance. Experience proves that far better results are usually obtained by the use of weaker dyes, although a longer time may be required.

As a general rule, sections should be left in the dye till equally stained throughout, then remove them into alcohol, brush the surfaces well with a camel-hair pencil, and transfer them to absolute alcohol for a few minutes, thence into oil of cloves till quite clear, and

finally into clean oil of cloves, where they must remain ten or fifteen minutes before mounting in balsam and benzole. Preparations stained blue may be left in oil of cloves for a week or more without doing them any injury.

The staining process has greatly facilitated the study of the minuter forms of life. For staining Bacilli employ the aniline reds as follows:—Fuchsia in crystals, one centigram; alcohol, from twenty to twenty-five drops; distilled water, fifteen cubic centimetres: mix. The colour stain taken by the bacilli is less intense than that taken by the micrococci, and this serves to distinguish the one from the other. The minute size of the bacilli renders their life history and study of their growth under artificial cultivation a work of great difficulty. Considerable importance, however, attaches to these organisms obtained by cultivation, from the fact that the resulting forms can be compared with those found in connection with disease. Blood corpuscles are better studied under osmic acid staining fluid, and which shows that most of the white corpuscle may be divided into two or more kinds and forms. One set is stained black by osmic acid, and another, which contains granulous matter not fatty, is stained red by an eosine solution. The best mode of showing the three forms of corpuscles is to fix the blood in the network of the smaller blood vessels; for instance, in the choroid coat of the eye, by cutting the eye of the frog into two parts, subjecting the section to the vapour of osmic acid for twelve hours, then wash the segment in distilled water, and detach the capillary layer from the retina, spread it out on a glass slide and stain it with hæmatoxylate of eosine. The corpuscles will by this process be seen to be of three kinds—the ordinary, granular, and fatty. Care must be taken, as the vapour of osmic acid is of a corrosive nature.

M. Brandt finds hæmatoxylin and Bismarck-brown suitable colours for staining living unicellular organisms. For amœbæ and similar delicate bodies a dilute solution of hæmatoxylin must be allowed to act for only a short time, not more than an hour, when

they must be transferred to pure water. The nuclei will be seen stained pale violet; although at first no visible change is produced in the contractile vacuole, later on it assumes a yellowish tint, and finally becomes brown. Double staining may likewise be effected by first using Bismarck-brown for an hour, and then hæmatoxylin for a shorter time; the protoplasm alone remains uncoloured: the difference in colour showing which of the granules are fatty and which are nuclein. The strength of the Bismarck-brown stain should not exceed one in 3,000 or 5,000. A solution of safranin, one of the red aniline dyes, one or two grains to the ounce of water, is an excellent stain and test for amyloid, starchy matters in unicellular plants. The starch is stained of a fine orange colour, and other portions of a rose colour.

For bleaching sections before staining Mr. Marsh resorts to the direct action of *free chlorine*, generated in a pair of Woolf-bottles.

Fill one of the bottles about two-thirds full of filtered water, and into this place the sections to be bleached. Into the other bottle put a sufficient quantity of crystals of chlorate of potash to slightly cover the bottom, and pour upon them a drachm or two of strong hydrochloric acid. Connect the bottles by the glass tubes, and the yellow vapour of chlorine will be observed to pass into the water contained in the first bottle, and effectually and safely bleach the sections. The time required for bleaching will vary with the nature of the sections operated upon. Decoloration having been effected, the sections must be removed and thoroughly washed to eliminate all trace of chlorine before employing a staining agent.

*Cementing.*—The following cements are recommended by Mr. Groves for mounting stained preparations:—

*Cements.*—For balsam or glycerine jelly mounts almost any varnish will do, but for fluids, glycerine, &c., it is necessary to have one tough and which will prevent leakage. The following will be found most efficient:—

1. Mastic and Bismuth.—Dissolve gum mastic in chloroform, and thicken with nitrate of bismuth.

The solution of mastic should be nearly saturated.

2. Oxide of Zinc, Dammar, and Drying Oil. Rub up well-ground oxide of zinc, 2oz., with drying oil, to the consistence of thick paint. Then add an equal quantity of gum dammar, previously dissolved in benzoline, and of the thickness of syrup. Strain through close-meshed muslin. Keep in well-corked bottle, and, if necessary, thin with benzoline.

3. Kitton's Cement is made of white lead and red lead in powder and litharge powder in equal parts. Grind together with a little turpentine, until thoroughly incorporated, and then mix with gold size. The mixture should be thin enough to use with a brush; in using one coat should be allowed to dry before applying another; no more cement should be mixed with the gold size than is required for immediate use, as it sets quickly, and becomes unworkable.

Certain precautions are necessary to be observed in using varnishing fluid or glycerine preparations:—

1. Use no more glycerine or fluid than is just necessary to fill up the space beneath the cover.

2. If the medium should escape beyond the cover-glass, soak it up with a piece of blotting-paper, and be careful not to press the cover, or the cement will run into the cell.

Of preservative mounting media, the most useful are balsam, glycerine, and glycerine jelly.

Canada balsam should be exposed to heat until it becomes quite brittle when allowed to cool, then it should be dissolved in benzole till as thin as glycerine, and should always be used cold.

*Glycerine.*—Specimens which have been hardened in chromic acid or bichromates may be mounted in pure glycerine alone, but if they have been hardened in spirit, glycerine and carbolic acid, in the proportion of glycerine fifteen parts to carbolic acid one part, is better, as it is less refractive, and prevents the sections becoming granular. For carmine stained preparations it is well to add a trace of acetic acid to the glycerine (2m., 1oz.). Glycerine jelly is a good medium, as it offers the advantages of glycerine with-

out the chance of leaking, but it is rather difficult to prepare, and, therefore, had better be bought.

A jelly composed of glycerine and gelatine equal parts is very useful; the glycerine should be warmed, and the gelatine (Nelson's) be allowed to dissolve in it.

Acetate of potash in a saturated solution is used for some preparations, but is liable to leak.

*Injecting Small Animal Bodies.*— For making injections it is essential to have a proper syringe. One of brass is the best, and of such a size that the top of the thumb may cover the button at the top of the piston-rod when drawn out, while the body is supported between the two fingers. Fig. 143l represents the syringe. *a* is the body, with a screw at the top for the purpose

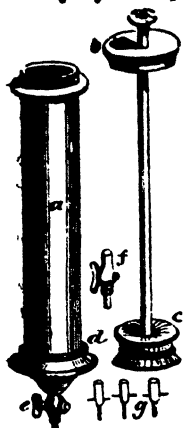

FIG. 143l.—Injecting Syringe.

of firmly screwing down the cover *b* after the piston *e*

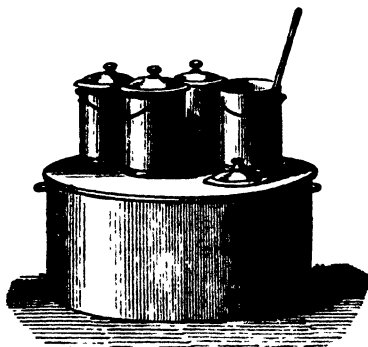

FIG. 143m.—Melting Vessel.

is replaced; *e* is a stop-cock, to the end of which either of the smaller pipes *g* can be fixed. The transverse

wires are for securing them tightly with thread to the vessels, into which they may be inserted. In addition to the syringe, two or three tinned vessels, to contain size, injecting fluid, and hot water, are necessary.

The size must be kept hot by the aid of a water bath; if a naked fire be used, there is danger of burning it. A convenient form of apparatus for melting the size, and afterwards keeping it at a proper temperature, is shown in fig. 143*m*.

A pair of strong forceps, for seizing the vessel, and a small needle, fig. 143*n*, is also necessary for passing the thread round the vessel into which the injecting pipe has been inserted, completes the list of apparatus. To prepare the material for opaque injections: Take of the finest and most transparent glue one pound, break it into small pieces, put it into an earthen pot, and pour on it three pints of cold water; let it stand twenty-four hours, stirring it now and then with a

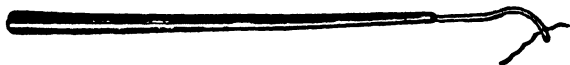

FIG 143*n*.—Artery Needle.

stick; set it over a slow fire for half an hour, or until all the pieces are perfectly dissolved; skim off the froth from the surface, and strain through a flannel for use. Isinglass and cuttings of parchment make an excellent size, and are preferable for particular injections. If gelatine be employed an ounce to a pint of water will be sufficiently strong, but in very hot weather it is necessary to add a little more gelatine. It must be first soaked in part of the cold water until it swells up and becomes soft, when the rest of the water, made hot, is to be added. The size thus prepared may be mixed with finely levigated vermilion, chrome-yellow, blue smalts, or flake white.

To prepare the subject, the principal points to be aimed at are, to dissolve the fluids, empty the vessels of them, relax the solids, and prevent the injection from coagulating too soon. For this purpose it is necessary to place the animal, or part to be injected, in



warm water, as hot as the operator's hand will bear. This should be kept at nearly the same temperature for some time by occasionally adding hot water. The length of time required is in proportion to the size of the part and the amount of its rigidity.

*Cold Injection-mass.*—A. Wikoziemski describes a modification of Panseh's method. Thirty parts by weight of flour, and one of vermilion, are mixed while dry, and then added to fifteen parts by weight of glycerine, and subjected to a continuous stirring until of a homogeneous viscous consistency; then two parts of carbolic acid (dissolved in a little spirit) are added to it, and finally thirty to forty parts of water. This injection-mass is specially adapted for subjects already injected with carbolic acid (in the proportion of one and a half part by weight each of carbolic acid, spirit, and glycerine, to twenty of water): twenty-four hours are allowed to elapse between the two injections.

*Of Injecting Different Systems of Vessels with Different Colours.*—It is often desirable to inject different systems of vessels distributed to a part with different colours, in order to ascertain the arrangement of each set of vessels and their relation to each other. A portion of the gall-bladder in which the veins have been injected with white lead, and the arteries with vermilion, forms a beautiful preparation. Each artery, even to its smallest branches, is seen to be accompanied by two small veins, one lying on either side of it. In this injection of the liver, four sets of tubes have been injected as follows:—The artery with vermilion, the portal vein with white lead, the duct with Prussian blue, and the hepatic vein with lake. There are many opaque colouring matters which may be employed for double injections.

The structure of the kidney may be demonstrated as follows:—Inject into the jugular vein of an animal, as soon as killed, say of a rabbit, a sufficient quantity of a one per cent. solution of the yellow prussiate of potash, and immediately afterwards inject through the renal artery a sufficient quantity of a weak solution of perchloride of iron, to distend the capillaries of the kidney.

After the second injection has been made, pieces of kidney which have become of a bluish colour are cut off with a razor, and steeped in a one per cent. of osmic acid, in which the pieces must be left to harden from twelve to twenty-four hours. They should be small enough to allow the osmic acid to penetrate freely. After they are removed from the acid, they must be thrown into distilled water for half an hour, and finally kept for examination in alcohol. This method imparts a bluish tint, with a tinge of violet, to the protoplasm and nucleus, whilst the cells of the straight tubules receive no coloration.

*Injecting the Lower Animals.*—The vessels of fishes are exceedingly tender, and require great caution in filling them. It is often difficult or quite impossible to tie the pipe in the vessel of a fish, and it will generally be found a much easier process to cut off the tail of the fish, and put the pipe into the divided vessel which lies immediately beneath the spinal column. In this simple manner beautiful injections of fish may be made.

*Mollusca.*—(Slug, snail, oyster, &c.) The tenuity of the vessels of the mollusc often renders it impossible to tie the pipe in the usual manner. The capillaries are, however, usually very large, so that the injection runs very readily. In different parts of the bodies of these animals are numerous lacunæ or spaces, which communicate directly with the vessels. Now, if an opening be made through the integument of the muscular foot of the animal, a pipe may be inserted, and thus the vessels may be injected from these lacunæ with comparative facility.

*Insects.*—Injections of insects may be made by forcing the injection into the general abdominal cavity, when it passes into the dorsal vessel and is afterwards distributed to the system. The superfluous injection is then washed away, and such parts of the body as may be required, removed for examination.

*Injection of Invertebrate Animals.*—G. Joseph uses filtered white of egg, diluted with 1 to 5 per cent. of carmine solution, for cold injections. This coagulates

when immersed in dilute nitric, chromic or osmic acids, but remains transparent, and is sufficiently indifferent to reagents. A mass of similar properties is made of glue liquid when cold, coloured with the violet extract of logwood reduced with alum. Injection is effected in the case of worms (leech and earth-worm) by way of the ventral or dorsal vessel, with large Crustaceans by the heart or the ventral vessel which lies in the sternal canal. In many cases, especially when lacunar spaces have to be filled, useful preparations are obtained by natural injection (auto-injection, or autoplerosis). Natural injection of Medusæ is effected without injuring the vessels; in the case of Crustaceans, Insects, and Mollusca, through a slit with an opening at the side remote from it. Medusæ are laid in a glass vessel, with the bell downwards, and a bell-jar ending in a narrow tube above is placed over it and made air-tight; after the Medusa is covered with the injection-mass, the air in the glass is exhausted, and as the sea-water runs out by slits in the lower side of the annular canal, the coloured fluid runs in. In the case of leeches and large species of earthworms, the natural injection is made from the ventral sinus. In all cases a glass tube is used, with a finely drawn-out point. The injection is complete when the injection issues from the counter-opening. Animals to be injected alive are kept quiet by cold (upon ice). Besides the animals mentioned, large caterpillars, beetles, Libellulidæ, larvæ, locusts, &c., all serve as objects for injection; the glass cannula being introduced into the posterior end of the dorsal vessel, and the counter-opening made in the ventral vessel, and *vice versâ*.

*Staining Living Protoplasm with Bismarck Brown.*—L. F. Henneguy having treated *Paramæcium aurelia* with an aqueous solution of aniline brown (known as "Bismarck Brown"), found that they assumed an intense yellow-brown colour. The colour first appears in the vacuoles of the protoplasm, and then in the protoplasm itself, the nucleus generally remaining colourless, and thus becoming more visible than in the

normal state. Infusoria thus coloured were kept for nearly fifteen days. If a yellow-tinted *Paramœcium* is wounded or compressed so as to cause a small quantity of the protoplasm to exude, it is seen that it is really the protoplasmic substance which is coloured. All Infusoria may be equally stained with Bismarck brown, but no other aniline colours employed exhibit the same property—they only stain the Infusoria after death, and some of them are in fact poisonous. As it is generally admitted that living protoplasm does not absorb colouring matters, and that Infusoria are essentially composed of protoplasm, an attempt has been made to ascertain whether protoplasm in general, of animal or vegetable origin, behaved in the same way in the presence of aniline brown. A tolerably strong dose of Bismarck brown was injected under the skin of the back of several frogs. After some hours the tissues were uniformly tinted a deep yellow; the muscular substance especially had a very marked yellow tint. The frogs did not appear in the least incommoded. Small fry of trout placed in a solution stained rapidly and continued to swim about. Finally, a guinea-pig, under whose skin some powder of Bismarck brown had been introduced, soon presented a yellow staining of the buccal and anal mucous membranes and of the skin. Seeds of cress sown on cotton soaked with a concentrated solution of the Bismarck brown sprouted, and the young plants were strongly stained brown; but on crushing the tissues and examining them under the microscope, it was ascertained that the protoplasm of the cells was very feebly coloured; the vessels, on the contrary, showed a very deep brown staining up to their termination in the leaves. The mycelium of a mould which had been developed in a solution of Bismarck brown, was clearly stained after having been washed in water, whilst it is known that the mycelium, which frequently forms in coloured solutions, picrocarmine, hæmatoxylin, &c., remains perfectly colourless. Other aniline colours injected under the skin of frogs stained the fundamental substance of the connective tissue as deeply as did the Bismarck brown;

but the cells of the muscular substance remained perfectly colourless. The author concludes, therefore, that Bismarck brown possesses the property of colouring living protoplasm both in plants and animals.

Mr. Collins has introduced a very complete *Mounting-Case*, which will prove useful to microscopists, especially so to those who devote a good deal of attention to the preparation of specimens. A place is here found for everything: the little box contains:—Shadbolt's turntable, brass table, spirit-lamp, pipettes, spring clips, wooden clips, tweezers, tin cells, balsam, marine glue, asphalt, turps, gold size, thin glass covers, glass slips, and five extra bottles. The price of this neat and convenient case is 30s. Another box, more particularly adapted for anatomical purposes, includes a neat injecting apparatus.

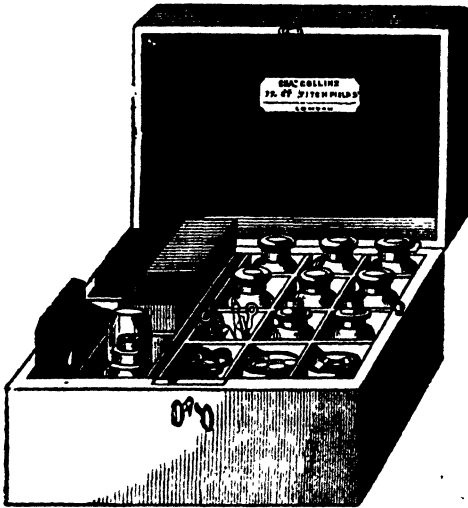
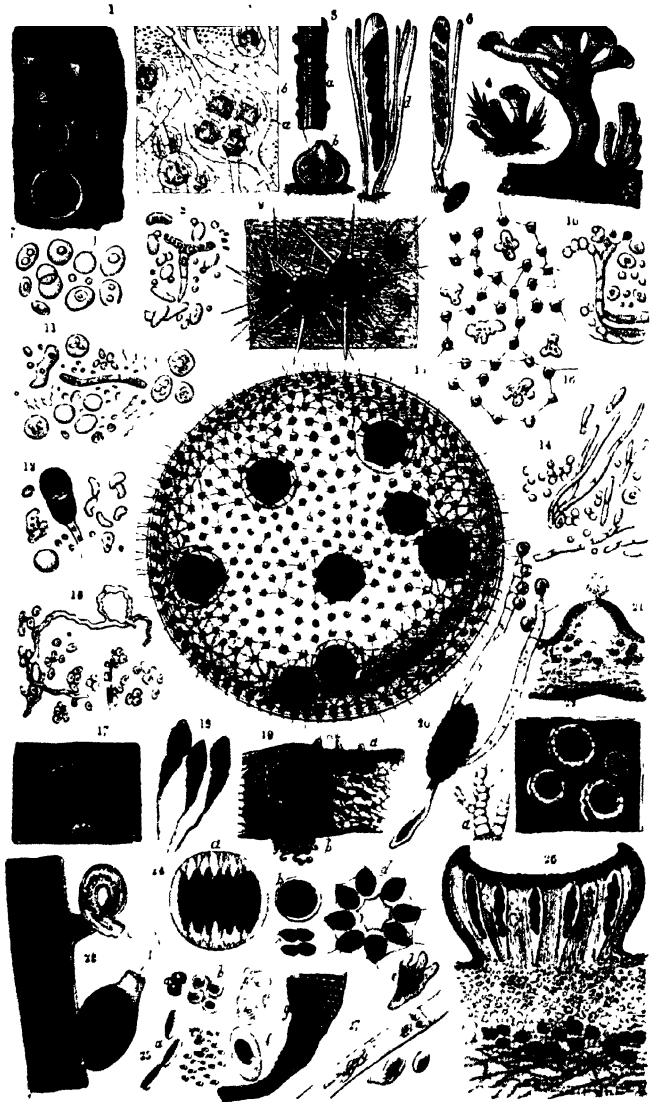

Fig. 1430 — Collins' Mounting Cabinet.



FUNGI, ALGAE, LICHENS, ETC.



## PART II

THE VEGETABLE KINGDOM—VITAL CHARACTERISTICS OF CELLS—THE PROTOCOCCUS PLUVIALIS—OSCILLATORIA—FUNGI—ALGÆ—DESMIDACEÆ—MOSESSES—FERNS—STRUCTURE OF PLANTS—STARCH—ADULTERATION OF ARTICLES USED FOR FOOD—PREPARATION OF VEGETABLE STRUCTURES ETC.



SINCE the introduction of the achromatic microscope, we have obtained nearly the whole of the valuable information we possess of the minute structure of plants. Indeed in no department of nature has microscopic investigation been more fertile of results than in that of the vegetable kingdom. The humblest tribes of plants have had for microscopists an attraction,—unequaled by that of any other department of nature,—from the time of our countryman Robert Brown, down to the present day. Although Brown had observed and recorded certain facts in the physiology of vegetable life, it was Professor Schleiden's labours that brought to light the great truth,

*“that the life-history of the individual cell is the first important and indispensable basis whereon to found a true physiology of the life-history of plants, as well as that of the higher orders of creation.”*



Mirbel had shown that all the different forms of vegetable tissue are developed from cells which enter into the formation of the embryo plant. Schleiden followed Mirbel in tracing out the development of the tissues of the fully formed plant from the nucleated cells composing the embryo; and he also studied the mode of formation of the nucleated cell itself. On this point Schleiden came to the conclusion that the nucleus is the germ of the plant-cell, hence he named it the "cytoblast." Müller subsequently contended that the spinal chord is composed of cells, resembling vegetable cells; Schwann discovered a nucleus in these cells, and observed that the various forms of cells in animal structures is similar in every respect to those of plants. From his investigations he was led to the philosophical generalization, that the tissues of the animal body and those of plants were formed from cells. The various tissues, although formed from cells in different stages of their development, and not necessarily the formative element of all cells in their fully formed stage, for cells, when fully formed, in some cases do not undergo further development; for example, in the parenchyma of glands when they break up, and are resolved into the secretive matter.

The prevailing opinion now is—and of which neither Schleiden nor Schwann appear to have had a true notion—that nuclei and cells are propagated by the subdivision of pre-existing nuclei and cells. As to the particular endowments and potentialities of the different kinds of cells whereby each is developed and converted into its own special tissue, and indifferently into any kind of tissue, I must refrain from discussing, as it would lead me into a region of speculation.

"If nature," writes Humboldt, "had endowed us with microscopic powers of sight, and if the integuments of plants were transparent, the vegetable kingdom would by no means present that aspect of immobility and repose under which it appears to our senses." And so with regard to the instruments of motion in the higher classes of creation, the muscles of animals very soon disappear as we descend in the

scale to the simplest forms of life; nevertheless, we cannot deny animality to those minute creatures—as the Amœba—in which we are quite unable to distinguish either muscle, or any other distinct organ. Hence there is danger of believing that to be simple which in reality only seems to be so.

Plants and animals, if seen at the earliest stage of existence, present themselves to our eyes as an aggregation of transparent cells. Everything prior to the appearance of the cell may, in the actual state of our microscopic knowledge, be considered as not fully and certainly demonstrated; and therefore it is incumbent upon us to take our starting-point from the simple cell, which is the same, in respect to its principal characters, in animals and vegetables. The external coating of a cell is nearly or quite solid and transparent, and with no indication of structure; while in its interior is found a liquid or solid substance, with a nucleus either adhering to its wall or within its cavity. A nucleolus can sometimes be demonstrated within the nucleus; and (a state common to all living cells) an incessant mutual interchange of materials is going on between the fluid contents and matter external to the cell, by a process termed osmose, or *diffusion*, which causes a perpetual variation in its relative condition. Chemical reagents give a manifestly different result in the animal and vegetable cell, hence we may conclude that there is an important difference in their chemical composition. The vegetable cell has an extremely fine delicate membrane lining the inner wall, to perceive which we must have recourse to reagents, and then we find the apparently simple cell-wall made up of two layers, each differing in composition and properties. The inner layer has received the name of *primordial utricle*, and its composition has been shown to be *albuminous*; agreeing in this respect with the *formative substance* of animal tissues. The external layer is regarded as the cell-wall, although it takes no part, essentially, in the formation of the cell; it is composed of *cellulin*, a material allied to the cellulose of vegetable tissues. The contents are more or less coloured: the internal colouring substance is termed *endochrome*; when green it is called *chlorophyll*.

The successive changes in the cell contents furnish other very important characteristics, such as the disappearance and re-absorption of the nucleus; this occurs in every cell at some period of its existence; in the cells of the higher plants, the inner membrane, or primordial utricle, entirely disappears. The Algæ, and some few unicellular plants, form an exception to the rule. In the animal, the enlargement of the cell-wall takes place in a uniform manner, whereas in the plant this is effected by a deposition of successive layers on its inner surface, in the shape of continuous rings, spiral bands, or other intermediate forms. Then the wall not only increases in size, but appears to possess a power of separating and appropriating certain substances, as lime, silica, lignine, &c., which form the so-called cuticle. In animals as well as in plants, new cells are formed within the old cells; but in the former, this process of a new formation begins in the extracellular fluid, while in the latter it is mostly endogenous. Multiplication of vegetable cells is effected by three different modes: 1st, Many nuclei appear in the maternal cell floating together with granular matter; around each collects a minute vesicle, this gradually increasing fills the maternal cell, which is eventually absorbed. 2d, The internal substance of the cell divides into two or more portions, each being furnished with a nucleus. 3d, In the third mode of multiplication, the wall itself of the maternal cell becomes gradually constricted, and divides into two portions.\*

\* "In most cells, especially when young, a minute, rounded, colourless body may be seen, either in the middle or on one side, called the *nucleus*. This is very distinct in a cell of the pulp of an apple: and within this nucleus is often to be seen another smaller body, frequently appearing as a mere dot, called the *nucleolus*.

"The nucleus is imbedded in a soft substance, which fills up the entire cell; this is the protoplasm (*protos*, first, *plasma*, formative substance). As it is very transparent, it is readily overlooked; but it may usually be shown distinctly by adding a little glycerine to the edge of the cover with a glass rod, when it contracts and separates from the cell-walls. The protoplasm in some cells is semi-solid, and of uniform consistence, while in others it is liquid in the centre, the outer portion being somewhat firmer, and immediately in contact with the cell-wall. In the latter case it forms an inner cell to the cell-wall, and is called the *primordial utricle*. The terms 'protoplasm' and 'primordial utricle' are however used by some authors synonymously.

"The protoplasm is the essential portion of the cell, and it forms or secretes the cell-wall upon its outer surface in the process of formation of the cell, considered as a whole. It is also of different chemical composition, from the cell wall being allied in this respect to animal matter."—*Griffiths*.

Taking for our examination the more simple organisms among vegetables, we shall find numbers which present, in their earliest as well as in their permanent state, the cell in its simplest condition, and its reproduction a bare repetition of the same thing. *Unicellular* plants, then, in the strictest sense, are represented only by those in which the whole cycle of life is completely shut up in the one cell; the first reconstruction or division being at once the commencement of a new cycle, in which, consequently, the whole vegetative life is run through in the same cell where the propagation also appears.

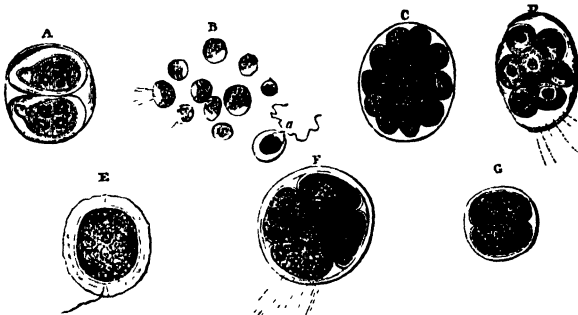

Fig. 144.—Cell Development. (*Protococcus pluviialis*.)

*Protococcus pluviialis*, Kützing. *Hæmatococcus pluviialis*, Flotow. *Chlamidococcus versatilis*, A. Braun. *Chlamidococcus pluviialis* Flotow and Braun.

- a, division of a simple cell into two, each primordial vesicle having developed a cellulose envelope around itself; b, Zoospores, after their escape from the cells; c, division of an encysted cell into segments. d, division of another cell, with vibratile filaments projecting from cell-wall; e, an encysted cell; f, division of an encysted cell into four, with vibratile filaments projecting; g, division of a young cell into two.

The most widely distributed of these single-cell plants is the *Palmoglaea macrococca*, of Kützing, which spreads itself as a green slime over damp stones, walls, &c. If a small portion be scraped off and placed on a slip of glass, and examined with a half or quarter-inch power, it will be seen to consist of a number of ovoid cells, having a transparent structureless envelope, nearly filled by a granular matter of a greenish colour. At certain periods this mass divides into two parts, and ultimately the cell becomes two. Sometimes the cells are united end to end, just as we see

Unicellular plants occur in the series of *Fungi* and *Algae*, which have many and very varied correspondences in morphological respects. The unicellular *Algae*—that is to say, *Algae*, the contents of which, containing already organized particles, are inclosed in a single, semifluid envelope, and this again in a cell-membrane, often consisting of several layers of different kinds; and many, moreover, possess the power of dividing into several secondary cells, for the most part equivalent to the primary cell. To this species of *unicellular* plant belongs *Protococcus pluviialis*. That this is the case is clearly seen in the still form of this plant, which is most distinctly characterised by its cell-membrane, a more or less thick though always colourless envelope. It never, however, secretes true thickening layers on the surface. Although this cell-membrane exhibits all the optical characters of one composed of cellulose, it is impossible to demonstrate the presence of that principle by means of iodine and sulphuric acid; it is not coloured by those reagents even after the contents of the cell have been expressed.

The contents vary much in consistence, colour, solid and fluid constituents; the red and green portions of which appear to be of equal physiological importance. The green colour is removed by ether, on the evaporation of which solvent there remain green as well as colourless drops. Dilute sulphuric acid at first renders the colour paler; but its prolonged action produces a bright green hue, which gradually becomes more and more intense, and often almost a blue-green. Hydrochloric acid has a similar effect; a tinge of brown is produced by nitric acid. Carbonate of potash scarcely affects the green colour; it is gradually but totally destroyed by caustic potash, the contents at the same time swelling and becoming transparent.

The change of colour from green to red in *Euglena*

appears to be a process very nearly allied to that which takes place in *Protococcus*, if it be not identical with it. The red substance of *Prot. pluvialis* is not always of an oily aspect; it only becomes so in more advanced age. And according to Cohn's researches, this oily material is much more generally distributed than has been supposed, among the lower Algæ; occurring in many true brown spores, such as of *Ædognium*, *Spirogyra*, *Vaucheria*, &c.

When still or motile cells of *Protococcus* are brought in contact with a very weak solution of iodine, they become internally, in most parts, of an intense violet or blue colour. With respect to the solid constituents of the *Protococcus* cell contents, they may be distinguished into chlorophyll vesicles, colourless or green particles, amylaceous granules, and nucleus. The motile form of *Protococcus* consists, as it were, of two cells, one within the other, both of which, however, differ essentially from the common vegetable cell: the external having a true cell-membrane and fluid contents; the other, or internal one, with denser, muco-gelatinous coloured contents, but without a true cell-wall. Cohn called the external transparent vesicle the "enveloping" cell," and the internal coloured one the "primordial cell." The term "primordial sac, or utricle," can only be applied to its peripheral layer, and not to that together with the contents.

The form of *Protococcus* (fig. 144) presents a perfect analogy between the primordial cell and the nucleus of the common plant-cell. The filaments which proceed from the central mass to the peripheric cell-wall, are tubular, giving passage to the red molecules from the central mass. These filaments, however, which proceed from the outer wall of the primordial cell towards the inner surface of the enveloping cell, correspond morphologically to the so-termed mucous filaments by which the cytoblasts are commonly retained in the centre of their cells. That they also correspond chemically with these, is proved by the fact that they are rendered more distinct by iodine, and that they can be made to retract by means of reagents; and in fact they exhibit, in the course of development, peculiarities which characterise them as consisting of protoplasm.

The existence of delicate threads passing from the central mass to the enveloping cells, and the appearance occasionally of little particles having molecular motion, serve to show that the contents of the enveloping cell are less of a gelatinous consistence, than of a fluid nature. And the continuity of the primordial cell-wall with the filaments proves it is surrounded only with a layer of protoplasm, and is not inclosed in a dense membrane of cellulose. The most distinctive characteristic of the primordial cell, and what appears to constitute its most essential importance in the life of the cell in general, but particularly in that of the zoospore, consists in its being the contractile element of the vegetable organism—that is to say, that from an intrinsic activity it possesses the faculty of altering its figure, without any corresponding change in volume.

The *Protococcus pluvialis* has true motile organs, namely, two long vibratile flagella arising from the primordial cell (fig. 144, B, a), which, passing through two openings in the enveloping cell, move about in the water. These organs, during the life of the cell, move so rapidly, that it is then difficult to perceive them; they are recognized by the currents produced in the water; as death approaches motion slackens and they become evident enough. They are also rendered very distinct by iodine. They are always protruded about the extreme point of the conical elongation, at the anterior end of the primordial cell, and in such a manner as to appear to be mere continuations of its substance. Since these processes consist of protoplasm, it is evident that the flagella must be regarded as composed of the same substance. They resemble, in some respects, the so-called proboscis of certain Infusoria, such as *Euglena* and *Monads*, and do not differ very materially from the non-vibratile, retractile filaments of *Acineta* and *Actinophrya*.

It is only that portion of the vibratile filaments beyond the enveloping cell that exhibits any motion, the portion within the outer cell being always motionless, and in that part of their course the filaments appear to be surrounded with a sheath. This seems to be the case, not only from the greater thickness at that part, but also from the cir-

circumstance that when, passing from the cell form into the still condition, the flagella disappear, the V-shaped, or forked internal portions remain visible. And it is then, also, that the openings through the enveloping cell-wall become, for the first time, visible.

Perhaps the most remarkable of all the numerous aspects presented by *Protococcus pluvialis*, is the form of naked zoospores named by Flotow *Hæmatococcus porphyrocephalus*. These are extraordinarily minute globules, consisting of a green, red, and colourless substance in unequal proportions. The colourless protoplasm in them, as in all primordial cells, constitutes the outermost delicate boundary; the red substance is for the most part collected towards the anterior end in minute spherules; the granular green substance occupies more the under part, while the middle is usually colourless.

Propagation depends upon a division of the cell contents, particularly of the colourless or coloured protoplasm, or of the primordial sac. This body, without any demonstrable influence of a nucleus, is capable of subdivision into a determinate number of portions. Each of these acquires a globular figure, and in the next place surrounds itself with an envelope of protoplasm, and then represents a visible organism, which after the reabsorption of the parent cell-membrane, is capable of existence as an independent reproductive individual. Besides these, which are the most usual modes of propagation—viz. that of the *still*-cells into two, and of the motile into four, secondary cells—there are a number of others which may be considered as irregular, and in which forms are produced which do not re-enter the usual cycle until they have gone through a series of generations. Sometimes, under certain circumstances, the cell-contents of the still form separate into eight or more portions, which become naked zoospores of small size (fig. 144 B.) It is not quite clear what becomes of this form of motile zoospores, but there seems reason for believing that they occasionally develop an enveloping cyst, and thus become encysted zoospores, and at other times secrete a cellulose tissue, and become *still*-cells; but most of them probably perish without any further change. They would thus



correspond with the smaller motile spores observed by Thuret and A. Braun in other Algæ (the Fucoid, &c.), associated with the larger germinating spores, themselves deprived of the germinative faculty.

It appears that both longitudinal and transverse division of the primordial cell may take place; but that the vibratile filaments of the parent cell retain almost to the last moment their function and their motion after the primordial cell inclosed by it has long been detached as a whole, and become transformed into the independent secondary cells (fig. 144, G).

The most striking of the vital phenomena presented by this organism is that of periodicity. Certain forms—for instance, encysted zoospores, of a certain colour, appear in a given infusion, at first exclusively, then they gradually diminish, become more and more rare, and finally disappear altogether. After some time their number again increases, and reaches as before to an incredible extent; and this proceeding may be repeated several times. Thus, a glass which at one time presented only still forms, contained at another nothing but motile ones. The same thing may be observed with respect to segmentation. If a number of motile cells be transferred from a larger glass into a small vessel, it will be found, after the lapse of a few hours, that most of them have subsided to the bottom, and in the course of the day they will all be observed to be on the point of subdivision. On the following morning the provisional generation will have become free; on the next, the bottom of the vessel will be found covered with a new generation of self-dividing cells, which again proceed to the formation of a new generation, and so on. This regularity, however, is not always observed. The influence of every change in the external conditions of life upon propagation is very remarkable. It is only necessary to pour water from a smaller into a larger and shallower vessel, or one of a different kind, to at once induce the commencement of segmentation in numerous cells. The same thing occurs in other Algæ; thus the *Vaucheria* almost always develop zoospores, at whatever time of year they may be brought from their natural habitat into a room. Light is con-

ducive to the manifestation of vital action in the motile zoospores, and they always seek it, collecting themselves at the surface of the water, and at the edge of the vessel.

But in the act of propagation, on the contrary, and when about to pass into the still condition, the motile *Protococcus* cell seems to shun the light; at all events it then seeks the bottom of the vessel, or that part of the drop of water in which it may be placed, furthest from the light. Too strong sunlight, as when it is concentrated by a lens, at once kills the zoospores. A temperature of undue elevation is injurious to the development of the more vigorous vital activity, that is to say, for the formation of the zoospores; whilst a more moderate warmth, particularly that of the vernal sun, is singularly favourable to it. Frost destroys the motile, but not the still zoospores.\*

*Stephanosphaera pluvialis* is another variety of fresh-water algæ, first observed by Cohn. It consists of a hyaline globe, containing eight green primordial cells, arranged in a circle (see Plate 1, No. 24 d). The globe rotates, somewhat in the same manner as the volvox, by the aid of projecting flagella, two of which are seen to proceed from each cell and pierce the transparent envelope. Every cell divides first into two, then four, and lastly eight young cells, each of which divides into a great number of microgonidia, and are seen to have a motion within the globe, and ultimately escape from it. Under certain circumstances each of the eight cells is observed to move about in the interior of the mother-cell; eventually they escape, lose their flagella, form a thicker membrane as at *b*, for a time become motionless, and sink to the bottom of the vessel. If the vessel be permitted to become thoroughly dry, and again water is poured into it, motile *Stephanosphaera* reappear: from which circumstances it is probable that the green globes are the resting spores of the plant. When in its condition of greatest activity its division into eight is perfected during the night, and early in the morning the young family escapes from the cell, soon to pass through similar changes. It is calculated that in

\* On the "Natural History of *Protococcus pluvialis*," by F. Cohn, translated by G. Buxk, F.R.S. for the Ray Society

eight days, under favourable circumstances, 16,777,216 families may be formed from one resting-cell of *Stephanosphæra*. In certain of the cells, and at particular periods, the remarkable amaboid bodies (Plate 1, No. 24 c), have been noticed. There is a marked difference between *Stephanosphæra* and *Chlamydococcus*, "for, while in the latter the individual portions of a primordial cell separate entirely from one another, each developing its own enveloping membrane, and ultimately escaping as a unicellular individual; in the former, on the other hand, the eight portions remain for a time united as a family."\*

The simplest forms of vegetable life are met with in the Confervoids, which are as interesting as they are instructive to the microscopist. The confervæ consist of unbranched filamentous delicate cylindrical cells, placed end to end; their reproductive process is carried on by zoospores produced from the cell contents. The fresh-water genera are principally of a yellowish green colour; sometimes presenting a striated appearance, which has given rise to a supposition that confervoid filaments are spiral. They are indeed plentifully distributed both in fresh and salt-water.

*Oscillatoriaceæ*.—The study of the structure of the *Oscillatoria* is particularly interesting, from the fact that we may not unreasonably expect to find in it a key to the motive power from which they received their generic name, and which now, for more than a century, has formed an object of curiosity and interest to the microscopist, without having received anything like a satisfactory explanation.

The following different tissues are observable in the true *Oscillatoria*:—1, An outer inclosing sheath; 2, A special cell-membrane, with its contents; and 3, The axis, or pith, of the filament.

The filaments of certain species are inclosed in sheaths or continuous tubes, never showing any cross-markings corresponding to the striæ of the filament; they are clearly composed of a kind of cellulose, although they remain unaffected by iodine. In other species, these tubes are

\* See an interesting paper by F. Currey, F.R.S. *Journal of Microscopical Science*, vol. vi. 1858, p. 181; also by Mr. Wm. Archer, vol. v. 1855, p. 116.

absent, or have not yet been observed; when present, they will be found projecting on one or both sides of

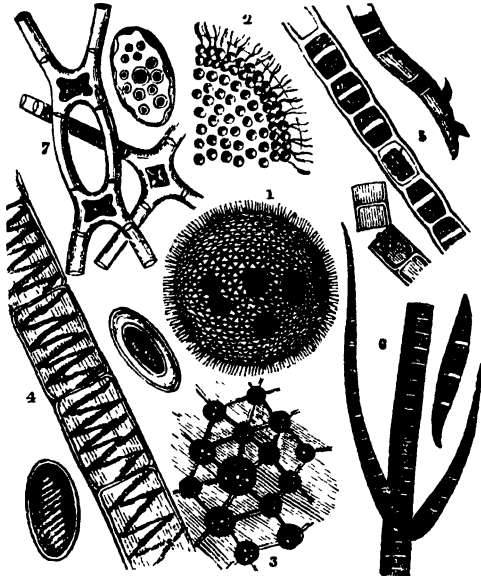

Fig 145—*Conservee*.

1, *Volvox globator*. 2, A section of volvox, showing the flagellated margin of the cell. 3, A portion more highly magnified, to show the young volvocina, with their nuclei and thread-like attachments. 4, *Spirogyra*, near which are spores in different stages of development. 5, *Conservea floccosa*. 6, *Stigeoclonium protensum*, jointed filaments and single zoospores. 7, *Staurocarpus gracilis*, conjugating filaments and spores.

the filament, being somewhat longer than the latter. Filaments inclosed in sheaths never, or but slightly, exhibit their peculiar motion, although they may be seen sliding in them, backwards and forwards, or leaving them altogether.

The filaments themselves have been supposed to consist wholly of protoplasm; this view, however, is scarcely correct, since the protoplasm is enclosed in a cell-membrane. The cellulose *always* shows cross-markings corresponding to the striæ when such are observable

in the filament, and which divide it into distinct joints or cells.

The presence of this cell-membrane may be best demonstrated by breaking up the filaments, either by moving the thin glass cover, or by cutting through a mass of them in all directions with a fine dissecting knife. On now

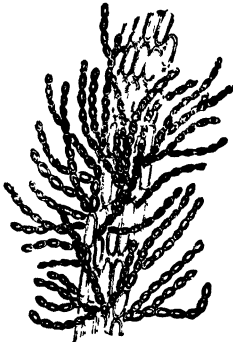

Fig. 146 — *Mesoglia vermicularis*, composed of strings of cells cohering end to end.

examining the slide, in most instances many detached empty pieces of this cell-membrane, with its striae, will be found, as well as filaments partly deprived of the protoplasm, showing in these places the empty, striated cellulose coat. On the application of iodine all these appearances become unmistakably evident; the greater portions of the filament turning brown or red, while the empty cells, with their striae, remain either unaffected, or at most present a slight yellowish tint, as is frequently the case with cellulose when old.

With regard to the contents of the cell, the protoplasm (or endochrome) is coloured in the *Oscillatoria*, and is deposited within it in the form of circular bands or rings around the axis of the cylindrical filament; iodine stains them brown or red, and syrup and dilute sulphuric acid produce a beautiful rose colour. As to their mode of propagation, nothing positive is known. If kept for some time they gradually lose their green colour—those exposed to the sun, much sooner than those less exposed; a stratum eventually becoming brown, sinks to the bottom of the vessel, and presents a granular layer, embodying great numbers of filaments in all stages of decay.\*

The movements of the *Oscillatoria* are indeed very singular, so much so that it is in vain to attempt to explain them as altogether dependent on physical causes, and equally so to show that they are due to a sarcode or animal

\* Dr. F. d'Alquen, "On the Structure of the *Oscillatoria*," *Journal of Microscopical Science*, vol. iv. p. 245. 1856.

*membrana*. Their motion is not less lively than that of the *Bacteria*, which Dujardin and Ehrenberg placed among infusional animalcules. To observe the movements of the filaments, the very uppermost surface ought to be brought into focus, leaving the margins rather undefined, bearing in mind that the filament is not a flat but a cylindrical body. Certainly, with regard to the movement, or the mechanism by which it is effected, nothing positive is known.

The *Bacillaria paradoxa* is by far the most interesting specimen of the genus; the movements of which are very remarkable, and so little understood that it is rightly called *paradoxical*.

The Marine Confervoid Algæ present a general appearance which might at first sight be mistaken for plants very much higher in the scale of organization. In the Ulvaceæ, the frond has no longer the form of a filament, but assumes that of a membranous expansion of the cell. These cells, in which zoospores are found, have an increased quantity of green protoplasm accumulated towards one point of the cell-wall; and the zoospores are observed to converge with their apices towards the same point. In some genera, which seem to be closely related in form and structure to the *Bryopsidææ*, we notice this important difference, that the zoospores are developed in an organ specially destined to this purpose, which presents peculiarities of form, distinguishing it from every other part of the branching tubular frond. In the genus *Derbesia*, distinct spore cases are seen, a young branch of which, when destined to become a sporecase, instead of elongating indefinitely, begins, after having arrived at a certain length, to swell out into an ovoid vesicle, in the cavity of which a rapid accumulation of protoplasm takes place. This is then separated from the rest of the plant, and becomes an opaque mass, surrounded by a distinct membrane. After a time a



Fig 147. — *Sphacelaria cirrhosa*, with spores borne at the sides of the branchlets.

division of the mass takes place, and a number of pyriform zoospores, each of which is furnished with a crown of ciliæ, are set free.

In many families of the olive-coloured Algæ, reproduction by zoospores is the general rule; they differ, however, in the arrangement of their flagella. These organs, always two in number, are usually of unequal length, and emanate not from the beak, but from a reddish-coloured point in its neighbourhood. The shortest is directed backwards, and seems to serve during the motion of the spore as a rudder. The longest, directed forwards, is closely applied to the colourless beak. *Ectocarpus* is one of the simplest forms of olive-coloured Algæ, consisting of branching filaments, the extremity of any of which is liable to become converted into a sporangium, by the absorption of the septa of the terminal cells. The zoospores are arranged in regular horizontal layers. In many genera a peculiarity exists, the signification of which is not yet completely understood—namely, that of a double fructification. The ovoidal sporangia contain numerous zoospores. In the genus *Cutleria* (fig. 150), there is seen another feature of interest: the appearance of two kinds of organs, which seem to be opposed to each other as regards their reproductive functions. The sporangia not only differ from those of other genera, but the frond consists of olive-coloured irregularly-divided flabelli, on each side of which tufts (*sori*) consisting of the reproductive organs, intermixed with hair-like bodies, are scattered. The zoospores are divided by transverse partitions into four cavities, each of which is again bisected by a longitudinal median septum. When first thrown off they are in appearance so much like the spores of *Puccinia*, that they may be mistaken for them; they are, however, about three times larger than those of the other olive-coloured algæ.

The fruit of most olive-green Sea-weeds is enclosed in spherical cavities under the epidermis of the frond, termed conceptacles, and may be either male or female. The zoids are bottle-shaped, each possessing a pair of cilia; the transparent vesicle in which they are contained is itself inclosed in a second of similar form, and we have no certain evidence of the function performed by the

**antheridia.** In monœcious and dicecious Fuci, the female conceptacles are distinguished from the male by their olive colour. The spores are developed in each in the interior of a perispore, which is borne on a pedicle emanating from the inner wall of the conceptacle. They rupture the perispore at the apex ; at first the spore appears simple, but soon after a series of changes take

place, consisting in a splitting of the endochrome into six or eight masses, which become spheroidal sporules. A budding-out occurs in a few hours' time, and ultimately elongates into a cylindrical tube. The *Vaucheriæ* present a double mode of reproduction, and their fronds consist of branched tubes, much resembling in general character that of the *Bryopsidæ*, from which

indeed they differ only in respect of the arrangement of their contents, chlorophyll. In that most remarkable plant *Saprolegnia ferox*, which is structurally so closely allied to *Vaucheriæ*, though separated from them by the absence of green colouring matter, we find a corresponding analogy in the processes of its development. In the process of the formation of its zoospores, we have an intermediate step between that of the Algæ and a class of plants usually placed among Fungi. Cohn has shown us that *Pilobolus* is structurally more closely allied to the former class than to that of the latter. *Pilobolus* has a somewhat remarkable ephemeral existence ; the spore germinates about mid-day, the plant grows till evening, re-opens during the night, and in the morning the spore-case bursts and the whole disappears, leaving behind scarcely a trace of its former existence.

Red Sea-weeds, *Floridææ*, present great varieties of structure, although comparatively little is known of their re-

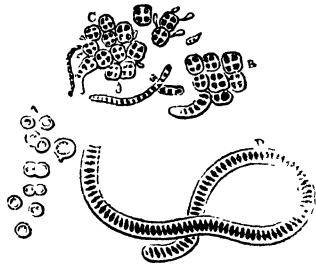

Fig. 148.—Development of *Ulva*.

A, isolated cells of spores B and C clustering of the same. D, cells in the filamentous stage.



productive processes ; it will, however, be sufficient for our purpose to notice the three leading forms. The first form, to which the term polyspore has been applied, is that of a gelatinous or membranous pericarp or conceptacle, in which an indefinite number of sporidia are contained. This organ may be either at the summit or base of a branch, or it may be concealed in or below the cortical layer of the stem. In some cases a number of sporidium-bearing filaments emanate from a kind of membrane at the base of a spheroidal cellular perisporangium, by the rupture of which the sporidia formed from the endochrome of the filaments make their escape. Other changes have been observed ; however, they all agree in one particular, namely,—that the sporidium is developed in the interior of a cell, the wall of which forms its perispore, and the internal protoplasmic membrane endochrome, the sporidium itself, for the escape of which the perispore ruptures at its apex.

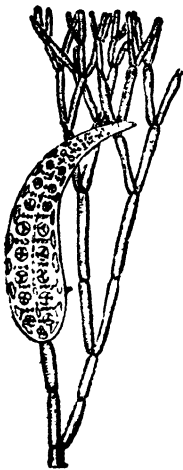

Fig. 149.—*Dasya Kutschingiana*, with seed vessel and two rows of tetraspores. Magnified 50 diameters.

The second form is more simple, and consists of a globular or ovoid cell, containing a central granular mass, which ultimately divides into four quadrate-shaped spores, which when at maturity escape by rupture of the cell-wall. This organ, called a tetraspore, takes its origin in the cortical layer. The tetraspores are arranged either in an isolated manner along the branches, or in numbers together ; in some instances the branches which contain them are so modified in form that they look like special organs, and have been called stichidia ; as, for example, in *Dasya* (fig. 149).

Of the third kind of reproductive organ a difference of opinion exists as to the signification of their antheridia ; although always produced in precisely the same situations as the tetraspores and polyspores, they are "agglomerations of little colourless cells, either

united in a bunch as in *Griffithsia*, or enclosed in a transparent cylinder, as in *Polysiphonia*, or covering a kind of expanded disc of peculiar form, as in *Laurencia*." According to competent observers, these cellules contain spermatozoids. Nägeli describes the spermatozoid as a spiral fibre, which, as it escapes, lengthens itself in the form of a screw. Thuret does not coincide in this view; on the contrary, he says that the contents are granular, and offer no trace of a spiral filament, but are expelled from the cells by a slow motion. The antheridia appear in their most simple form in *Callithamnion*, being reduced to a mass of cells composed of numerous little bunches which are sessile on the bifurcations of the terminal branches. Are not these spiral filaments closely allied to *Oscillatoriaceæ*? The spores are simpler structures than the tetraspores, and mostly occupy

a more important position. They are not scattered through the frond, but grouped in definite masses, and generally enclosed in a special capsule or conceptacle, which may be mistaken for a tetraspore case. The simplest form of the spore fruit consists of spherical masses of spores attached to the wall of the frond, or imbedded in its substance, without a proper conceptacle; such a fruit is called a *favellidium*, and occurs in *Halymentia*; the same name is applied to the fruits of similar structures not perfectly immersed, as

those of *Gigartina*, *Gelidium*, &c., where they form tubercular swellings on the lobes. In some, the tubercles present a pore at the summit, through which the spores find

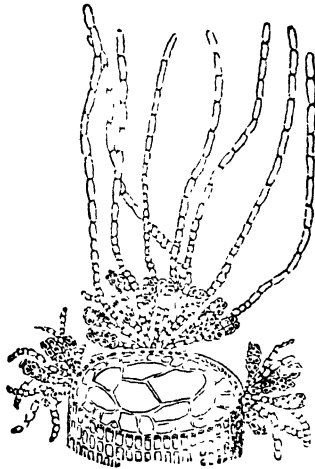

Fig 150 — *Cutleria dichotoma* Section of a lucinia of a frond, showing the stalked eight chambered oosporangia growing on tufts with intercalated filaments Magnified 50 diameters.

exit, when such a fruit is wholly external, as in *Ceramium* (see Plate II. Nos. 27 and 37) and *Callithamnion*, it is called a *favella*. The characteristic of *Delesseria*, No. 39, the coccidium, either occurs on lateral branches, or is sessile on the face of the frond, and consists of a case of angular spores attached to a central wall. The ceramidium is the most complete form of the conceptacular fruit: this is enclosed in an ovate case, with an apical spore, containing a tuft of pear-shaped spores arising from the base of the cavity.

The general external appearance of the Red Sea-weeds is very varied. They are exquisite objects for the Microscope; I have figured several interesting varieties in Plate II., each showing peculiarities of fructification. Their beautiful leaf-like fronds are either simple, lobed, or curiously pinnate or feathered. The Floridæ of warmer climates exhibit most elegantly formed reticulated fronds, as may be seen on reference to the late Dr. Harvey's last great work, "*Phycologia Australica*."

In the plant which results from the germination of the aggregate zoospores of *Vaucheria*, a genus of Siphonaceæ (Plate I. fig. 23), Kaisten has observed that on those filaments which come in contact with the atmosphere, are formed organs of a peculiar structure, which have the appearance of nipple or egg-shaped buddings-out of the cell-wall, distributed in pairs along the whole course of the older filaments; one elongates and curves round to meet its fellow, which is seen to swell out into a globular form; finally conjugation takes place, preceded, however, by the conversion of the green contents of the tubular organ into oil globules. If the filaments be gathered at a favourable period, and cultivated in a vessel of water well exposed to the light, the blind ends, or ramifications of the filaments, are found densely filled with green contents, appearing to be almost black; if these ends be watched early in the morning, a remarkable series of changes is seen to occur in them when about to produce gonidia, and, ultimately, they escape in a peculiar way from the filament. The admirable essays of Unger, Nageli, and Pringsheim on the process of their reproduction may be consulted with advantage.

DESmidiACEE, DIATOMACEE, ALGEE.

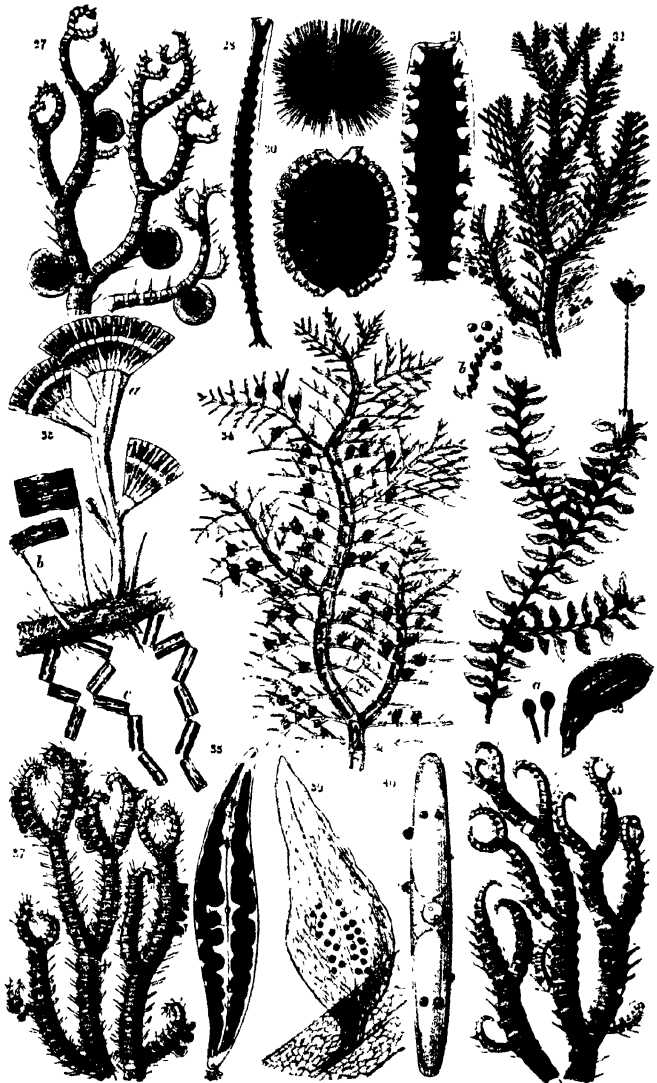

Tuffen West del.

PLATE II.

Edmund Evans



A fresh-water alga of singular beauty and interest to the microscopist is the *Volvox globator*. This little cell so well known to the older observers as the globe-animalcule, or revolving-cell, is represented in fig. 145, Nos. 1, 2, 3, and Plate I. No. 15. These revolving globular bodies can be kept a long time alive if exposed in a glass bottle to a rain-drip from a roof. In this way they maintain their activity and produce antheridia, which are distinguishable by their orange colour.

Leeuwenh ock first perceived the motion of what he termed *globes*, "not more than the 30th of an inch in

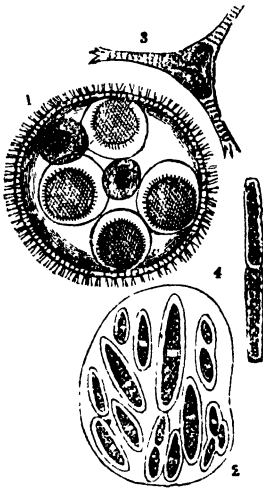

Fig. 151.

1 *Volvox*, just before the young burst forth, showing the vesicle which encloses each. 2, Parent cell of *Closterium* 3, *Doecidium clavatum* 4, *Staurastrum gracilis*.

diameter, rolling through water; and judged them to be animated." These *globes* are studded with innumerable minute green spots, each of which is seen to be a perfect cell, about the 3,500th part of an inch in size, with a nucleus and two flagella attached. The whole bound together by threads forming a beautiful net-work. Within the globe busy active nature is at work carefully providing a continuance of the species; and from six to twenty little bright-green spheres have been found enclosed in the larger transparent case. As each little cell arrives at maturity, the parent cell enlarges, and ultimately bursts asunder, launching forth its offspring to seek an independent existence. Both older and younger spheres possess openings through which the water freely flows, affording food and air to the wonderfully constructed little being.

Dr. Carpenter believes, "The *Volvocineae*, whose vegetable nature has been made known to us by observation of cer-

tain stages in the history of their lives, are but the *motile forms* (*Zoospores*) of some other plants, whose relation to them is at present unknown." Professor Williamson, having carefully examined the *Volvox globator*, says:— "That the increase of its internal cells is carried on in a manner precisely analogous to that of the algae; that between the outer integument and the primordial cell-wall of each cell, a hyaline membrane is secreted, causing the outer integument to expand; and as the primordial cell-wall is attached to it at various points, it causes the internal colouring-matter, or endochrome, to assume a stellate form (see Plate I. No. 15), the points of one cell being in contact with those of the neighbouring cell, these points forming at a subsequent period the lines of communication between the green spots generally seen within the full-grown *Volvox*." Flagella can be distinctly seen on the outer edge of the adult *Volvox*; by compressing and rupturing one they may even be counted. Professor Busk has been able to satisfy himself, by the addition of the chemical test *iodine*, of the presence of a very minute quantity of starch in the interior of the *Volvox*, which he considers as conclusive of their vegetable character. A singular provision is made in the structure of the gemmules, consisting of a slender elastic filament, by which each is attached to the parent cell-wall: at times it appears to thrust itself out, as if in search of food; it is then seen quickly to recover its former nestling-place by contracting the tether. It is impossible not to recognize the great similarity between the structure of *Volvox*, and that of the motile cell of *Protococcus pluvialis*. The influence of re-agents will sometimes cause the connecting processes of the young cells as in *Protococcus*, to be drawn back into the central mass, and the connecting threads are sometimes seen as double lines, which seem like tubular prolongations of a consistent membrane. At other times they appear to be connected by star-like prolongations to the parent cell, Plate I. No. 15, presenting an almost identical appearance with *Pediastrum pertusum*. Mr. Busk says that the body designated by Ehrenberg *Sphærosira volvox* is an ordinary *volvox* in a different phase of development; its only marked feature of dissimilarity being that a large propor-

tion of the green cells, instead of being single, are very commonly double or quadruple; and the groups of flagellated cells thus produced, form by their aggregation discoid bodies, each furnished with a single cilium. These clusters separate themselves from the primary sphere, and swim forth freely from under the forms which have been designated *Uvella* and *Syncrypta* by Ehrenberg. According to Mr. Carter, however, *Sphærosira* is the male or spermatic form of *Volvox globator*. Dr. Braxton Hicks believes that he has seen the young volvox pass into an amœboid state; he observes:—"Towards the end of autumn the endochrome mass of the volvox increases to nearly double its ordinary size, but instead of undergoing the usual subdivision, so as to produce a macro-gonidium, it loses its colour and regularity of form, and becomes an irregular mass of colourless protoplasm, containing a number of brownish granules." (Plate I. No. 16.)

The final change and ultimate destination of these curious amœboid bodies have not as yet been made out; but from Dr. Hick's previous observation, made on similar bodies developed from the protoplasmic contents of the cells of the roots of mosses, "which in the course of two hours become changed into ciliated bodies," he thinks it very probable that this is designedly the way in which these fragile structures are enabled to retain life, and to resist all the varied external conditions, such as damp, dryness, and rapid alternations of heat and cold.<sup>1</sup>

(1) We have had volvox under the microscope for several months, towards the end of summer and throughout the autumn, and made more than a hundred examinations, without having once seen the remarkable change described by Dr. Hicks in the *Quarterly Jour. Micros. Science*, vol. viii p. 96, 1862. Nevertheless, as Mr. Archer observes:—"If this reasoning be correct, then contractility, amœboid contractility—for I can find no more comprehensive and expressive single adjective—must be accepted as an inherent quality or characteristic, occasionally more or less vividly evinced, of the vegetable cell-contents, and this in common with the animal, in other words, that the nature of the protoplasm in each is similar, as has indeed, as is well known, been urged before on grounds not so strong; thus reserving Siebold's doctrine, that this very contractility formed the strongest distinction between animals and plants, as he assumed it to be present in the former and absent in the latter of the two kingdoms of the organic world. Therefore, an organism whose known structural affinities, and whose mode of growth and of ultimate fructification point it out as truly a plant, but of which, however, certain cells may for a time assume a contractile, even a locomotive, quasi-rhizopodous state, must not by any means on this latter account alone be assumed as even temporarily belonging to the animal kingdom, or as tending towards a mutation of its vegetable nature. and from this it of course follows that an organism whose structural affinities and reproduction are unknown, but which may possibly present an active-



*Desmidiaceæ*.—A remarkably beautiful family of coniferoid algae, the most distinctive characteristics of the species being their bilateral symmetry. Each frustule is, however, a perfect unicellular plant, with a homogeneous structureless membrane, enclosing a cellular skeleton filled with chlorophyll. Four modes of reproduction have been observed in the desmids, and many points still remain to be cleared up. Braun remarks of the products of conjugation, "that they do not pass, like the swarming-cells of the *Palmellaceæ* and the reproductive cells of the *Diatomaceæ*, directly and by uninterrupted growth into the primary generation of the new vegetative series, but persist for a long time in a condition of rest, during which, excepting as regards imperceptible internal processes, they remain wholly unchanged. To distinguish these from the *germ-cell* (gonidia) I shall call them *seed-cells* (spores). Certain early conditions observed in *Closterium* and *Euastrum*, namely, families of unusually small individuals, enclosed in transparent, colourless vesicles, render it even probable that in certain genera of this family a number of individuals are produced from one spore, by a formation of transitory generations occurring already within the spore." <sup>1</sup>

contractile, even locomotive power, need not on this latter account be assumed as therefore necessarily an animal. In the former category fall the *Volvoenaceæ* and *Rhizidium*; in the latter category *Euglena* and its allies, the so-called *Astasian Infusoria*, suggest themselves; and these must of course wait until their reproduction and history are better known before we can feel satisfied as to their true position; yet it seems highly probable that these will presently, if they do not even now, take their place amongst admitted plants.

"Several writers have, indeed, from time to time, put forward the (now, I think, generally accepted) view that the protoplasm of the vegetable and the sarcode of the animal cell are identical in nature; and, in seeking for analogies as regards contractility in the vegetable protoplasm as compared with the animal, and as demonstrative thereof, special attention has been directed to several of the now familiar phenomena displayed by certain vegetable cells. Such are the vibratory movements of cilia, and drawing in of these, the circulatory movements of the cell contents, as in the hairs of the *Tradescantia*, &c., the contractile vacuole in *Gonium*, *Volvox*, &c., and so forth. But while these are, I think, unquestionably to a considerable, but more limited extent, manifestations of the same phenomenon, it seems to me that none of these cases present so exact an analogy, strongly as they may indicate it, with the rhizopodous contractility as do the amoeboid bodies of *Stephanosphaera*, of *Volvox*, of the *Moss-radicles*, and of *Rhizidium*. The amoeboid bodies of *Stephanosphaera* seem to display this rhizopodous contractility in greatly the most marked or exaggerated degree, as their vigorous and energetic power of locomotion indicate: in them, and indeed in those of *Volvox*, the *Moss*, and *Rhizidium*, the pseudopodal processes and their mode of protrusion and withdrawal, the flow of the granules, and the locomotion of the whole body, were in all respects analogous to the similar phenomena evinced by a true amoeba."—Wm. Archer, *Quarterly Journal Micros. Science*, vol. v. p. 185.

(1) "The Phenomenon of Rejuvenescence in Nature."

Reproduction both by conjugation and subdivision variously modified, is common to all the families of Desmidiaceæ; and in the Zygnemaceæ, which have a close relation to them, the phenomena of conjugation are very well known. In *Staurocarpus* we have those remarkable quadrate spores formed in the cross branch, produced by conjugation. In *Spirogyra* the union of two cells belonging to the opposite filaments takes place by the expansion of one side of each, so as to form a papilla or short rounded-off tube (see fig. 145). The ends of the two projections then come into contact, become slightly flattened, then pressed together, and finally united. The double wall formed by their union dissolves, or is broken through, so that a free passage is established between the two cells. Upon this, the whole of the chlorophyll, previously arranged round the inside of each of the cells, becomes a confused mass, which soon forms itself either in the cavity of one of them, or in the connecting canal, into a globular or oval spore invested with the colourless cellulose membrane shown in one of our drawings of *Penium* (Fig. 155). In *Closterium* conjugation takes place in a somewhat similar manner, represented at No. 25, although it is quite clear that if the formation of germs by conjugation were the only provision for the reproduction of a species, all must disappear, inasmuch as the conjugation and consequent destruction of a pair of *Closteria* for the formation of one new plant will ultimately destroy the species.<sup>1</sup> Another mode, however, that of subdivision, appears to be designed as an effectual safeguard against such a possible extinction. Mr. Lobb has observed this process take place in *Micrasterius denticulata* (Plate II. fig. 30), in the course of three hours and a half. The small hyaline hemisphere, put forth in the first instance from each frustule, enlarges with the flowing in of the endochrome; it then undergoes progressive subdivision at its edges, first into three lobes, then into five, then into seven, then into thirteen, and finally at the time of its separation, acquires the characteristic notched outline of its type, being only distinguishable from the older half by its smaller size.<sup>2</sup>

(1) In certain species of *Closterium* the act of conjugation gives origin to two sporangia.

(2) E. G. Lobb, *Trans. Microsc. Soc. N. S.* vol. i., 1861.

*Desmidiaceæ*.—The once disputed question relating to the vegetable nature of these cells received much valuable elucidation from Mr. Ralfs, who gave to the world the

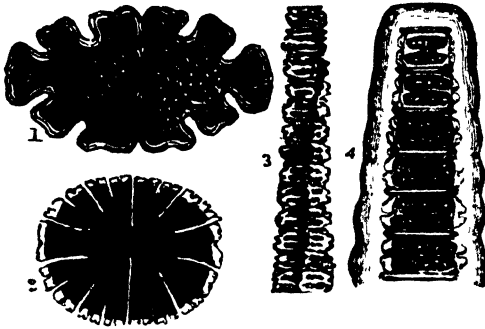

FIG. 152.

1, *Euzostrom oblongum*. 2, *Microterias rotata*. 3, *Desmidium quadrangulatum*.  
4, *Didymoprium Grævillii*.

results of his laborious researches in his excellent work on *The British Desmidiææ*, published in 1848; and the conclusions arrived at by this painstaking author have been generally accepted by men of science. The interest which has so long attached to this topic will warrant us in devoting some space to its consideration; and we avail ourselves for that purpose of Mr. Ralfs' labours, with a recommendation to those of our readers who would wish to familiarise themselves more completely with this peculiar species, to consult the pages of the book above referred to.

*Desmidiaceæ* are grass-green in colour, surrounded by a transparent structureless membrane, a few only having their integuments coloured; they are all inhabitants of fresh water. Their most obvious peculiarities are the beauty and variety of their forms and their external markings and appendages; but their most distinctive character is their evident division into two or more segments. Each cell or joint in the *Desmidiaceæ* generally consist of two symmetrical valves or segments; and the suture or line of junction is in general well marked. The multiplication of the cells by repeated transverse division is full of interest,

both on account of the remarkable manner in which it takes place, and because it unfolds the nature of the process in other families, and furnishes a valuable addition to our knowledge of their structure and physiology.

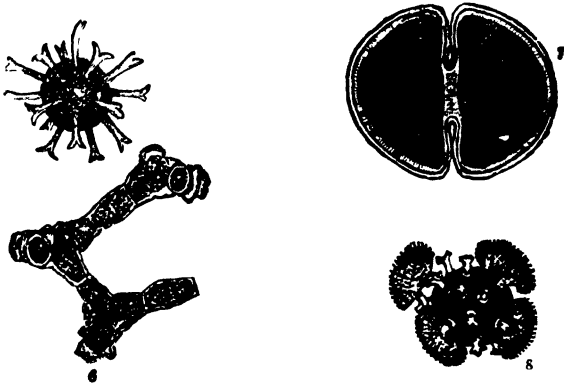

5, *Microsterias*, sporangium of. 6, *Dalymoprium Borreri*. 7, *Cosmarium*  
8, *Staurasterium hirsutum*.

The compressed and deeply-constricted cells of *Euastrium* offer most favourable opportunities for ascertaining the manner of their division : for although the frond is really a single cell, yet this cell in all its stages appears like two, the segments being always distinct, even from the commencement. As the connecting portion is so small, and necessarily produces the new segments, which cannot arise from a broader base than its opening, these are at first very minute ; though they rapidly increase in size. The segments are separated by the elongation of the connecting tube, which is converted into two roundish hyaline lobules. These lobules increase in size, acquire colour, and gradually put on the appearance of the old portions. Of course, as they increase, the original segments are pushed further asunder, and at length are disconnected, each taking with it a new segment to supply the place of that from which it has separated.

It is curious to trace the progressive development of the new portions. At first they are devoid of colour, and

have much the appearance of condensed gelatine ; but as they increase in size, the internal fluid acquires a green tint, which is at first very faint, but soon becomes darker ;

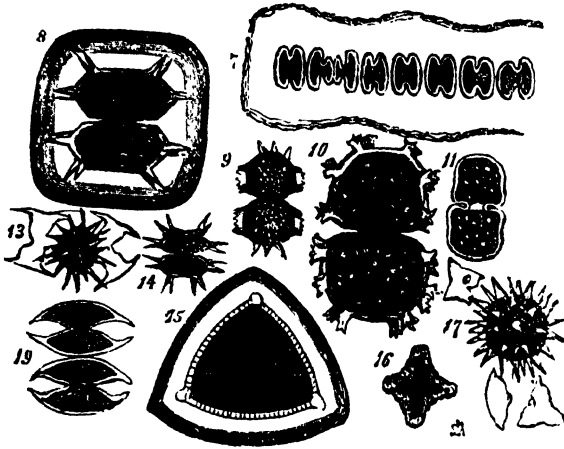

Fig 154.

7, *Sphaerocosma vertebretum* 8, 9, *Xanthidium* 10, *X. armatum* 11, *Cosmarium crenatum*. 13, 17, Sporangia of *Cosmarium* 14, *X. fasciculatum* 19, *Arthrodesmus convergens*. 15, *Staurastrum tumidum*. 16, *Staurastrum dilatatum*.

at length it assumes a granular state. At the same time the new segments increase in size, and obtain their normal figure ; the covering in some species shows the presence of puncta or granules. In *Xanthidium* and *Staurastrum* the spines and processes make their appearance last, beginning as mere tubercles, and then lengthening until they attain their perfect form and size, armed with setae ; but complete separation frequently occurs before the whole process is completed. This singular process is repeated again and again, so that the older segments are united successively, as it were, with many generations. When the cells approach maturity, molecular movements may be at times noticed in their contents, precisely similar to what has been described by Agardh and others as occurring in *Confervæ*. This movement has been aptly termed a **swarming**. All the *Desmidiaceæ* are semi-gelatinous. In some the mucus is condensed into a distinct and well-defined

hyaline sheath or covering, as in *Didymoprium Grevillii* and *Staurastrum tumidum*; in others it is more attenuated, and the fact that it forms a covering is discerned

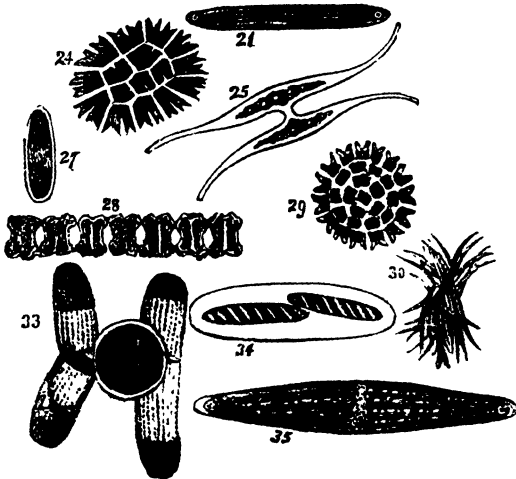

Fig. 155.

21, *Penium* 21, *Pedastrum biradiatum* 25, *Closterium*, showing conjugation or self-division 27, *Penium Jenneri*. 28, *Aplogonium desmidium* 29, *Pedastrum pectum* 30, *Anistrodesmus falcatus* 33, Conjugation of *Penium major lacum* 34 *Sprotæmia*. 35, *Closterium*

only by its preventing the contact of the coloured cells. In general its quantity is merely sufficient to hold the fronds together in a kind of filmy cloud, which is dispersed by the slightest touch. When they are left exposed by the evaporation of the water, this mucus becomes denser, and is apparently secreted in larger quantities, to protect them from the effects of drought. Meyen states, "that the large and small granules contain starch, and were sometimes even entirely composed of it;" and "in the month of May he observed many specimens of *Closterium* in which the whole interior was granulated; these grains gave with iodine the beautiful blue colour, indicative of the presence of starch."<sup>1</sup>

(1) The test for starch can be easily applied, and so remove any doubt that may exist. It is only necessary to bear in mind that unless granular matter

“Did we trust solely to the eye, we should indeed be very liable to pronounce these variable and beautiful forms as belonging to animals rather than vegetables. All favours this supposition. Their symmetrical division into parts; the exquisite disc-form, finely cut and toothed *Micrasterias*; the lobed *Euastrum*; the *Cosmarium*, glittering as it were with gems; the *Xanthidium*, armed with spines; the scimitar-shaped *Closterium*, embellished with striæ; the *Desmidium*, resembling a tape-worm; and the strangely insect-like *Staurastrum*, sometimes furnished with arms, as if for the purpose of seizing its prey;—all these characteristics appear to a superficial observer to belong rather to the lowest forms of animal, than vegetable life.” Another indication Dr. Bailey adduced, by rendering apparent their power of motion; taking a portion of mud covered with *Closteria*, and placing it in water exposed to light; after a time, it will be seen that if the *Closteria* are buried in the mud, they work their way to the surface, and cover it with a green stratum: this is no doubt owing to the stimulus light exerts upon all matter, although at first appearing very like a voluntary effort. Another is afforded by their retiring beneath the surface when the pools dry up. Mr. Ralfs states that he has taken advantage of this circumstance to obtain specimens less mingled with foreign matter than they would otherwise have been.

During the summer of 1854 the Rev. Lord S. G. Osborne drew my attention to the economy of an interesting specimen of this family, the *Closterium Lunula*; after many careful investigations he came to the conclusion that the membrane of the endochrome, both on its inner and outer surface, is ciliated.

In the *Closterium Lunula*, we have ascertained that the best view of its circulation is obtained by the use of strong daylight, or sunlight transmitted through coloured glass, or such a combination of tinted glass as that

be seen in the interior of the cell, starch cannot be present. A small quantity of diluted tincture of iodine may be applied, removing the free iodine by the aid of heat, occasionally adding a little water to facilitate its removal. This also will assist in the removal of the brownish stain which at first obscures the characteristic purple tint; and then, by applying the highest power of the microscope, the peculiar colour of the purple iodide of starch will in general be perceived.

proposed by Mr. Rainey, and adapted to a 1-4th achromatic condenser; with which must be used a 1-8th object-glass. The Gillett's condenser, or parabolic reflector, will do equally well if used with a 1-8th objective. In diagram A, fig. 156, a specimen of the *C. Lunula*, as seen

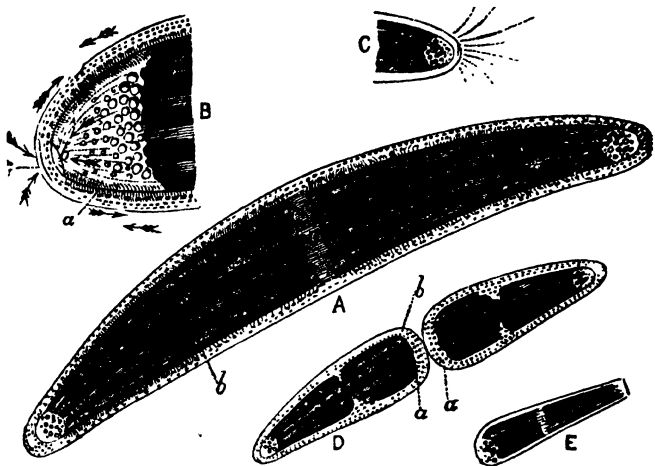

Fig. 156—*Closteria Lunula*.

with the above arrangement of microscopic power, and a deep eye-piece, the cilia are in full action along the edge of the membrane which encloses the endochrome; and also, but not so distinctly, along the inside of the edges of the frond itself. Their action is precisely the same as that in the branchiæ of the mussel: there is the same wavy motion; and as the water dries up between the glasses in which the specimen is enclosed, the circulation becomes fainter, and the cilia are seen with more distinctness.

In diagram A, a line is drawn at *b* to a small oval mark; these exist at intervals, and more or less in number over the surface of the endochrome itself, beneath the membrane which invests it. These seem to be attached by small pedicles, and are usually seen in motion on the spot to which they are thus fastened; from time to time they



break away, and are carried by the circulation of the fluid, which works all over the endochrome, to the chambers at the extremities; there they join a crowd of similar bodies, each in action within those chambers, when the specimen is a healthy one.

The circulation, when made out over the centre of the frond, for instance at *a*, is in appearance of a wholly different nature from that seen at the edges. In the latter, the matter circulated is in globules, passing each other, in distinct lines, in opposite directions; in the circulation as seen at *a*, the streams are broad, tortuous, of far greater body, and passing with much less rapidity. To see the centre circulation, use a Gillett's illuminator and the 1-8th power; work the fine adjustment so as to bring the centre of the frond into focus, then almost lose it by raising the objective; after this, with great care, work the milled head till the dark body of the endochrome is made out; a hair's-breadth more adjustment gives this circulation with the utmost distinctness, if it is a good specimen. It will be clearly seen, by the same means, at all the points where the spaces are put: and from them may be traced, with care, down to both extremities.

The endochrome itself is evidently so constructed as to admit of contraction and expansion in every direction. At times the edges are in semi-lunar curves, leaving uninterrupted clear spaces visible between the green matter and the investing membrane; at other times, the endochrome is seen with a straight margin, but so contracted as to leave a well-defined transparent space along its whole edge, between itself and the exterior case. It is interesting to keep changing the focus, that at one moment we may see the globular circulation between the outer and inner case, and again the mere sluggish movement between the inner case and the endochrome.

At *B* is given an enlarged sketch of one extremity of a *C. Lunula*. The arrows within the chamber pointing to *A*, denote the direction of a very strong current of fluid, which can be detected, and occasionally traced, most distinctly; it is acted upon by cilia at the edges of the chamber, but its chief force appears to come from some impulse given from the very centre of the endochrome.

The fluid is here acting in positive jets, that is, with an almost arterial action; and according to the strength with which it is acting at the time, the loose floating bodies are propelled to a greater or less distance from the end of the endochrome; the fluid thus impelled from a centre, and kept in activity by the lateral flagella, causes strong eddies, which give a twisting motion to the free bodies. The line—*a*, in this diagram, denotes the outline of the membrane which encloses the endochrome; on both sides of this flagella can be seen. The circulation exterior to it passes and repasses it in opposite directions, in three or four distinct courses of globules; these, when they arrive at —*c*, seem to encounter the fluid jetted through an aperture at the apex of the chamber; which disperses them so much, that they appear to be driven, for the most part, back again on the precise course by which they had arrived. Some, however, do enter the chamber; occasionally, but very rarely, one of the loose bodies may be seen to escape from within, and get into the outer current, it is then carried about until it becomes adherent to the side of the frond.

With regard to the propagation of the *C. Lunula*, we have never seen anything like conjugation; but we have repeatedly seen what the reverend gentleman has so well described—*increase by self-division.*

Observe the diagram D; but for the moment suppose the two halves of the frond, represented as separate, to just overlap each other. Having watched for some time, the one half may be seen to remain passive; the other has a motion from side to side, as if moving on an axis at the point of juncture: the separation then becomes more and more evident, the motion more active, until at last with a jerk one segment leaves the other, and they are seen as drawn. It will be observed, that in each segment the endochrome has already a *waist*; but there is only one chamber, which is the one belonging to the one extremity of the original entire frond. The globular circulation, for some hours previous to subdivision, and for some few hours afterwards, runs quite round the obtuse end of the endochrome — *a*, by almost imperceptible degrees; from the end of the endochrome symptoms of

an elongation of the membranous sac appear, giving a semi-lunar sort of chamber; this, as the endochrome elongates, becomes more defined, until it has the form and outline of the chamber at the perfect extremity. The obtuse end — *b* of the frond is at the same time elongating and contracting; these processes go on; in about five hours from the division of the one segment from the other, the appearance of each half is that of a nearly perfect specimen, the chamber at the new end is complete, the globular circulation exterior to it becomes affected by the circulation from within the said chamber; and, in a few hours more, some of the free bodies descend, become exposed to, and tossed about in the eddies of the chamber, and the frond, under a 1-6th power, shows itself in all its beautiful construction. E is a diagram of one end of a *C. didymotocum*, in which the same process was noticed.

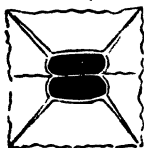

Fig. 157.

The *Euastrum Didelta* is well worthy of attention, as well as many other species, the *Xanthidium Penium*, *Docidium*, &c.

The *Arthrodesmus Incus* has a very beautiful hyaline membrane stretching from point to point, cut at the edges, something like the *Micrasterias*. This is

represented at fig. 157.

*The Mode of Finding and Taking Desmidiaceæ.*—As the difficulty of obtaining specimens is very great, it will materially assist the efforts of the microscopist to know the method adopted by Mr. Ralfs, Mr. Jenner, and Mr. Thwaites. “In the water the filamentous species resemble the *Zygnemata*; but their green colour is generally paler and more opaque. When they are much diffused in the water, take a piece of linen, about the size of a pocket handkerchief, lay it on the ground in the form of a bag, and then, by the aid of a tin box, scoop up the water and strain it through the bag, repeating the process as often as may be required. The larger species, *Euastrum*, *Micrasterias*, *Clostrium*, &c., are generally situated at the bottom of the pool, either spread out as a thin gelatinous stratum or collected into finger-like tufts. If the finger be gently passed beneath them, they will rise to the surface in little masses, and with care may be removed and

strained through the linen as above described. At first nothing appears on the linen except a mere stain or a little dirt; but by repeated fillings-up and strainings a considerable quantity will be obtained. If not very gelatinous, the water passes freely through the linen, from which the specimen can be scraped with a knife, and transferred to a smaller piece; but in many species the fluid at length does not admit of being strained off without the employment of such force as would cause the fronds also to pass through, and in this case it should be poured into bottles until they are quite full. But many species of *Staurastrum*, *Pediastrum*, &c., usually form a greenish or dirty cloud upon the stems and leaves of the filiform aquatic plants; and to collect them requires more care than is necessary in the former instances. In this state the slightest touch will break up the whole mass, and disperse it through the water: for securing them, let the hand be passed very gently into the water and beneath the cloud, the palm upwards and the fingers apart, so that the leaves or stem of the inverted plant may lie between them, and as near the palm as possible; then close the fingers, and keeping the hand in the same position, but concave, draw it cautiously towards the surface; when, if the plant has been allowed to slip easily and equably through the fingers, the *Desmidiaceæ*, in this way brushed off, will be found lying in the palm. The greatest difficulty is in withdrawing the hand from the surface of the water, and probably but little will be retained at first; practice, however, will soon render the operation easy and successful. The contents of the hand should be at once transferred either to a bottle, or, in case much water has been taken up, into the box, which must be close at hand; and when this is full, it can be emptied on the linen as before. But in this case the linen should be pressed gently, and a portion only of the water expelled, the remainder being poured into the bottle, and the process repeated as often as necessary."

When carried home, the bottles will apparently contain only foul water; if they remain undisturbed for a few hours, the *Desmidiaceæ* will sink to the bottom, and most of the water may then be poured off. If a little filtered rain-water be added occasionally, to replace what has been

drawn off, and the bottle exposed to the light of the sun, the *Desmidiaceæ* will survive for a long time.

*Fungi*.—This interesting class of cellular flowerless plants are chiefly microscopic, many requiring a high magnifying power to determine their peculiarities of structure. They abound in damp places, among decaying and decayed vegetable and animal matters, everywhere, and in almost every place. The structure of all Fungi exhibits a well defined separation into two parts, a mycelium (thallus) jointed and branched, forming a kind of cottony filamentous mass, and a reproductive spore or fruit, which, although exceedingly minute, differs somewhat in appearance under the microscope. The "spawn" used for planting mushroom beds is composed of mycelium, and may be readily obtained for examination (fig. 188, No. 19). The dust-like powder of any of the moulds or mildew when sprinkled on a slip of glass and kept under a bell glass over water, will soon throw out filaments and spores in all directions.

De Bary's observations show that resting-spores are not peculiar to the algæ; for he found them in two genera of fungi, and Tulasne ascertained their production in *Peronospora*, many of which are parasitic, as *P. parasitica*, a species found on the cabbage and turnip leaf, as well as on the shepherd's-purse, *Capsella bursapastoris*. For the growth of *P. infestans*, the potato mould, the exclusion of light seems to be needful, and it is easy to conceive how the spores, washed down to the tuber during heavy rains, throw out germinating threads, which easily penetrate the thick cuticle of the potato, and quickly produce a murrain.

The Rev. M. J. Berkeley, the English authority on Fungi, says:—"The genus *Cystopus* comprises those parasitic fungi amongst the Uredines which are remarkable for their white spores. Till the resting-spores of the different species were ascertained, it was almost impossible to find good distinctive characters: one species at least, *Cystopus candidus*, is to be found everywhere on the common shepherd's-purse, and often accompanied by *Peronospora parasitica*. It is also frequent on the cruciferæ: the acrospores, or gonidia, which spring from the swollen threads of the mycelium, form necklaces, as in oidium, the joints

of which give rise to zoospores, as first observed by Prevost, in 1807. Like those of *Peronospora*, they move about in water by means of two lash-like appendages, and there germinate. When resting on the leaves of a plant, they make their way by means of a germinating thread into its subjacent tissues, and throw out little suckers. The branched mycelium gives off sporangia and antheridia, exactly as in *Peronospora*; when ripe, the sporangia are strongly warted. They fall, doubtless, with the leaves to the ground, where they remain till a fitting season arrives for their development. The provision made for the rapid development of these parasites and for the preservation of their species is truly marvellous, and sufficiently accounts for the difficulty of extermination and their apparently sudden dispersion, especially in wet weather."

De Bary's observations on the germination of *Uromyces appendiculatus* are interesting, inasmuch as they show that the sporidia produce a mycelium, from which springs in succession—1st, spermogonia; 2dly, peridia, producing chains of orange-coloured fruit, or, in other words, an *Æcidium*; and 3dly, the original fruit of *Uromyces*, accompanied by the more simple fruit commonly called *uredo*, and now called *uredo*-stylospores. The germination of the fruit produced by the peridia, as well as that of the *uredo*-stylospores, produces, according to De Bary, 1st, *Uredo*-stylospores, and 2d, the original *Uromyces*-spores. Thus we see the *Uromyces*-spores passing through the generations of promycelium, sporidia, and mycelium—the latter producing successively the two different products, spermogonia and *æcidia*, and ultimately the original fruit of *Uromyces*, accompanied by the *Uredo*. The spermatia, or contents of the spermogonia, never germinate; but we find the fruit of the *æcidia*, and also of the *Uredo*, reproducing first the *Uredo* itself, and subsequently the original fruit of *Uromyces*. Other interesting points, noticed by the same author, are, "that not only has each species a liking for certain special nutrient plants, but that in certain *Uredines* with multiple fruit and alternate generations each sort of reproductive organ buries its germ in a different nutrient plant; and that the vegetation of the parasite is the cause of the disease."

De Bary has also carried out a series of experiments which go far to satisfy him that the sporidia of *Puccinia graminis* germinate on the leaves of *Berberis*, and that the *Æcidium* of the *Berberis* (Plate I. No. 22) is a stage in the cycle of development of *Puccinia*. Thus, whilst in most *Uredines* the entire development is carried out upon one and the same nutrient plant, the alternate generations in *Puccinia graminis* require a change of host. This is a state of things well understood now in the animal kingdom in the Tæniæ and Trematoda, but *Puccinia graminis* is, we believe, the first of the parasitic fungi in which it has been particularly ascertained. Another point of interest is a confirmation of the supposed injurious effect of the proximity of *Berberis* to corn, which has been denied. De Bary further shows that *Mucor mucedo* (the common mould) has three, if not four, different forms of fruit; and that the mould called *Thamnidium* by Link, or *Ascophora elegans* by Corda, and the mould described by Berkeley as *Botrytis Jonesii*, and made into a new genus by Fresenius, under the name of *Chaetocladium*, are only varieties of the fruit of *Mucor mucedo*. Also that yeast, *Achyla*, *Saprolegnia*, and *Entomophthora* or *Empusa*, are identically the same as *Mucor mucedo*, consequently that a large reduction is needed in the genera of the mucorini.

The main interest, however, of De Bary's paper on the fructification of the Ascomycetes, consists in observations on *Erysiphe Cichoracearum*, &c., in which the author traces the origin of the perithecium, from its earliest state up to the formation of the single ascus and spores. He notices two cells as being always present and visible from the earliest period, one of which he conjectures may be the female, and the other the antheridium or male organ. He says that the cell, by the division of which the ascus and its coating are formed, only develops itself when it has been in contact with the antheridium; and he considers it very probable that impregnation is effected by such contact, and that the perithecium of *Erysiphe* (excepting the outer wall) is the product of such impregnation.

De Bary's paper on parasitic fungi was, it appears, undertaken with a view to contribute to the solution of

the question as to their origin; and he concludes that endophytes are not produced from the metamorphosed substance of diseased plants, but that they originate from germs which penetrate healthy plants and develop a mycelium. In the course of his investigations he notices the occurrence in the genus *Cystopus* of organs similar to those long since discovered by Tulasne in *Peronospora*, which have been called *Oogonia*. He observes that ramifications perform the functions of antheridia, or male organs; and he proceeds to describe the production by the oospores (or impregnated contents of the oogonia) of active zoospores, similar to those produced by the ordinary spores of *Cystopus*. Dr. De Bary states that these zoospores, after remaining active for three or four hours, lose their cilia and power of motion, assume a cellulose covering, and germinate. He adds that the germ-filaments enter readily by the stomates and leaves of the nutrient plant, but that those filaments only become developed which enter the stomates of cotyledons. In *Peronospora* the development of the antheridia, oogonia, and oospores is said by De Bary to be the same as in *Cystopus*; and he gives particulars of the mode of germination of the conidia, and remarks on the growth of the parasite, which may be profitably studied in the paper itself.

Parasitic fungi, vegetable blights as they are commonly called, have of late years become objects of earnest attention, on account both of the enormous damage done to our growing crops, and also of the many curious facts in their history which have been brought to light. Corn-blights consist chiefly of mildew, *Puccinia*, smut, bunt, rust, or red-robin, *Uredo*. *Oidium* is a common mildew; *Botrytis* another; *Aecidium* forms a kind of rust infecting pear-trees, the peridia of which form a very pretty object for the microscope. (Plate I. No. 22, *Aecidium Berberidis*.) In the full-grown condition they appear as little cups filled with reddish-brown powder (spores), and may be detected in their earliest stages by the deformities they produce in the structure of the plants infested, or by pale or reddish spots on the green surface, arising from the presence of the fungus beneath. They are common on the coltsfoot, the barberry, gooseberry, buckthorn, nettle, &c. Plate I. No. 19,



represents a vertical section of a leaf of black-currant, infested with *Ecidium grossulariæ*; its spermogonia are seen on the surface, and the perithecia below. The family *Sphæriacei* (No. 3, Plate I.), common enough on most herbaceous stems, first seem to be little black spots, *a*; when examined more closely are found to resemble little brownish bottles, *b*, filled with rows of spores. Other instructive specimens are—

*Cystopus candidus* (Uredo olim), Crucifer White-rust; conidia equal, globose; membrane equal, ochraceous; oospores sub-globose, epispore yellowish-brown, with irregular obtuse warts; warts solid. On shepherd's purse, cabbage, and other Cruciferæ: receptacle consisting of thick branched threads; conidia concatenate, at length separating; oospores deeply seated on the mycelium.—*Phyllactinia guttata* (Olim Erysiphe). Plate I. No. 9. Hazel Blight; amphigenous; mycelium web-like, often evanescent; conceptacles large, scattered, hemispherical, at length depressed; appendages hyaline, rigid, simple; sporangia 4-20, containing 2-4 spores. On leaves of hawthorn, hazel, ash, elm, &c.—*Aragma* (Phragmidium) *bulbosum*. Plate I. No. 20. Bramble Brand; hypogynous, with a dull red stain on the upper surface; spores in large tufts, 4-septate, terminal joint apiculate; peduncles incrassated, and bulbous at the base.—*Puccinia variabilis*, Variable Brand; sori amphigenous, minute, roundish, surrounded by the ruptured epidermis, nearly black; spores variable, obtuse, cells often subdivided; peduncle very short. On leaves of dandelion.—*Puccinia buri*, Box Brand. Plate I. No. 17. Sori sub-rotund, convex, and scattered; spores brown, oblong, rather strongly constricted, lower cell slightly attenuated; peduncle very long. On both surfaces of box leaves: spores uniseptate, supported on a distinct peduncle. Plate I. No. 18.—*Trichobasis* (Uredo olim) *senecionis*, Groundsel-rust; spots obliterated; sori solitary or regularly crowded; sub-rotund and oval, on the under surface, surrounded by the ruptured epidermis; spores sub-globose, orange. On various species of groundsel: spores free; attached at first to a short peduncle, which at length falls away.

It appears that at particular periods of the year the

atmosphere is, so to speak, more fully charged with the various spores of fungi than it is at others. The spores of the moulds *aspergillus*, *penicillium*, and *puccinia* are perhaps the most widely distributed bodies, and towards the end of the hot weather, or about autumn time, they are very abundant. Among those who have taken them at this period of the year, we must ever associate the name of the Rev. Lord Godolphin Osborne, who first experimented in this direction during the cholera visitation of 1854. He exposed prepared slips of glass, slightly moistened with glycerine, over cesspools, gully-holes, &c., near the dwellings of those where the disease appeared, and caught what he termed *aërozoa*—chiefly minute germs and spores of fungi. A drawing made from one of these glasses (Plate I. No. 13), exhibits spores almost identical with those found on the human skin, and elsewhere.

From the year 1854 to the present time we have amused ourselves by catching these floating atoms, and, so far as we can judge, they are found everywhere, and in and on every conceivable thing, if we only look close enough for them. Even the open mouth is an excellent trap; of this there is ample evidence, since we find on the delicate membrane lining the mouth of the sucking, crying infant, and on the diphtheritic sore throat of the adult, the destructive plant *Oidium albicans*. The human or animal stomach is invaded, and in a certain deranged condition we find the *Sarcina ventriculi*, with its remarkable-looking quaternate spores, its torulae, &c., seriously interfering with the functions of this organ.<sup>1</sup> *Torula diabetica* is another of these destructive products found in the human bladder.

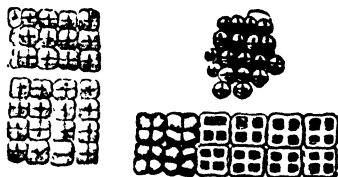

Fig. 153.—*Sarcina ventriculi*.

(1) What part do the fungi, or bacteria, play in the production of that fearful scourge of the human race, cancer? is a question not unfrequently asked since

It is now more than a quarter of a century since Professor Owen first pointed out the vegetable nature of a diseased growth found in the lungs of a Flamingo he was dissecting. Soon after, Bassi discovered the vegetable character of a disease which caused great devastation among silkworms; and, about the same time, Schönlein, of Berlin, was led to the detection of certain cryptogamic vegetable formations in connexion with skin diseases.

The Favus fungus is perhaps best known from its having been the first to attract the attention of Schönlein. It is commonly called *cupped ringworm*, or honeycomb scall, but it is very rarely seen in this metropolis. The crust is of a dingy yellow colour, and almost entirely composed of the *Achorion*, mixed with epithelial scales and broken hairs. When the fungus once establishes itself, so fearful are its ravages, that in a very short space of time the whole of the cutaneous surface, with the exception of the palms of the hands and soles of the feet, becomes covered with it. As the spores penetrate the hair-follicles they destroy the sheaths of the hairs, which shrivel up and lose their colouring matter, and then break off, leaving the surface bald.

Upon comparing the fermentation of the achorion fungus with that of good healthy yeast, it will be seen to be almost identical. In the first place, it is as actively

in the first edition of this book (1854) I expressed a belief in "*the origin of cancer.*" Subsequent examinations of diseased structure more or less tend to confirm this view; it appears that in this disease we have superadded to a fungoid growth "*degraded germinal matter*"—which, by its entrance into the circulation, produces a ferment and blood poisoning. The circular animal cell degenerates, is converted into the ovoid or elongated vegetable cell, and ultimately the structure, or some organ it may be, is changed into that remarkable-looking *caudate body*, the typical cancer cell. This in some respects bears the most perfect resemblance to certain spores of fungi, and to the yeast torule. As might be expected, its form is modified and its character more or less changed by the peculiar kind of nourishment and condensed tissue in which it is deposited and grows; its powers of growth are, so to speak, perverted and degraded, and then, as we see in other instances, it soon obtains a power of indefinite multiplication, and destroys, not only the vitality of the organ, but the individual. M. Davaine believes he has traced splenic disease in sheep to the entrance into the blood of *bacterium-like bodies*, and fungi; a zymotic disease is caused by the ferment, and by the rapid growth of the fungi the life of the animal is quickly sacrificed to the destroyer.

To mount specimens of fungi, separate them, and add a drop or two of spirit: when this has evaporated, add a drop of glycerine solution, or balsam dissolved in chloroform, and put on a glass cover. If the balsam renders the asci too transparent, use gelatine. no cells are required.

carried on by the former as by the latter. There is, however, just a slight difference in the size of the spores or cells (Plate I. Nos. 7, 8, 11), those from yeast being the larger and more clearly spherical, with a greater number of reproductive spores,—that is, cells with a single, clear, nucleated cell in their interior,—while others are filled with a darker granular matter, having only a slight tendency to coalesce or become filamentous; those from achorion are for the most part ovoid, and very prone to coalesce and produce elongated cells or torulæ. With reference to the slight difference in size, we must look upon this as a matter of very little importance; for to the presence of light in the one case, and its almost total exclusion in the other, this difference, no doubt, is almost entirely due. It would be more trustworthy if comparisons of this kind could be made at the same stage of development; for be it remembered that yeast obtained from a brewery is in a more favourable state, inasmuch as it is stopped at a certain stage of growth or development, and then set to begin its fermentation over again in fresh supplies of a new pabulum, which give increased health and vigour to the plant; while, on the other hand, the achorion, or Favus fungus, is obtained and used in an exhausted state from an already ill-nourished or starved-out soil. Neither can we attach much importance to differences in size and form of the spores, for even this occurs in yeast ferment; and although the ovoid is most frequently seen in achorion, it is equally common to yeast when exhausted. This is strikingly exhibited in Plate I. No. 8, a drawing made from a drop of exhausted yeast taken from porter; here we have oval and elongated cells with torulæ. To ensure success in these and similar experiments, the fungus or yeast should be left floating on the surface of liquids; the process is either carried on very slowly, or is entirely arrested by *submersion*.

Turpin and others, in their experiments on yeast, noticed that the cells become oval and bud out in about an hour after being added to the wort (fig. 159); but this change depends as much upon temperature and density of the solution as upon the quality of the yeast. It is a well-ascertained fact that when yeast is added to distillery wash, which is

worked at a higher temperature than brewers' wort, fermentation commences earlier, and the yeast-cell grows to a much larger size. It is, indeed, forced in this way much as a plant in a hothouse is, and then obtains to greater perfection in a shorter time. It will, however, be seen that it sooner becomes exhausted; and now, if we take a portion of this yeast and add it to barley wort, and at the same time keep it in a temperature of from 60° to 65° Fabr., it ferments languidly, and small yeast-cells are the product. If the yeast is allowed to stand in a warm place for a few days, it partially recovers its activity, but never quite. With such a yeast there is always a good deal of *torulæ* mixed up with the degenerated cells, and sometimes a filamentous mass, which falls to the bottom of the vessel; from this stage it readily passes to that of *must* and *mildew*, and then becomes a wasteful feeder or destroyer.

With yeast already in a state of exhaustion, we have seen a crop of fungus produced in the head of a strumous boy, seven years of age, who was much out of health, and had suffered from eczema of the eyelids, with impetigo. On placing portions of the broken hairs on a glass slip, and moistening with a drop of liquor potassæ, spores and *torulæ* were seen in abundance; represented in Plate I. No. 14.

In another experiment we took portions of penicillium and aspergillus moulds, and added these to sweetwort, and stood them by in a warm room. On the second day afterwards in one of the solutions, and the third in the other, fermentation had fairly set in; the surface of the solution was covered with a film, which proved to be well-developed ovoid spores, filled with smaller granular spores (*conidia*): Plate I. No. 8. On the sixth day the cells changed in form and were more spherical. Again removing these to another supply of fresh wort, the results obtained were quite characteristic of exhausted yeast ferment.

Extreme simplicity of structure characterises all moulds or mildews. Their reproductive organs are somewhat more complex, and both in penicillium and aspergillus the mycelium terminates in a club-shaped head, bearing upon

it smaller filaments with small bead-like bodies upon the apex, piled one upon the other, or, more properly speaking, *strung* together; these, again, are surmounted by larger spores of a discoid shape filled with granular matter, and others which are quite empty. Those of the aspergillus are apparently without granular matter or nuclei, and are more highly refractive. The puccinia are club-shaped, the very rapid growth of the spores and spawn of which appears to exert a specific and peculiarly exhaustive action over the tissues of the plant on which it feeds. Plate I. No. 12, represents a portion of the mould taken from a saccharine solution.

The yeast plant, in its most perfect condition, is chiefly made up of globular vesicles, measuring, when fully grown, about the  $\frac{1}{100}$ th of an inch in diameter. The older cells are filled with granular or nucleated matter; the nucleus rapidly increases, and nearly fills up the parent cell, which then becomes ovoid, and ultimately the young cell buds out and is separated from the parent. Some-

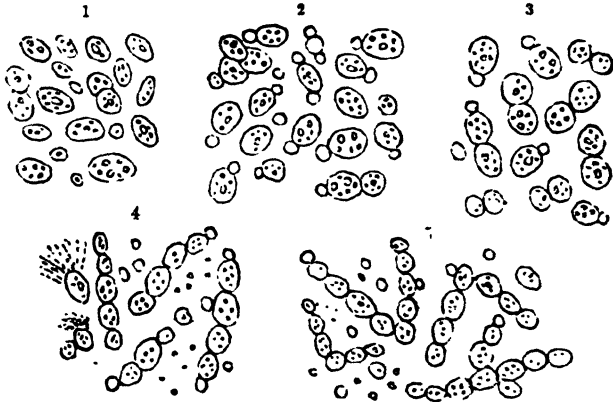

Fig. 159 --A diagrammatic representation of the development of the Yeast Plant.

No. 1, Fresh Yeast; No. 2, one hour after adding it to wort; No. 3, three hours; No. 4, eight hours; No. 5, third day, after which jointed filaments are produced.

times other and smaller cells are formed within the young one before it leaves the parent globule. This process goes

can most rapidly until the supply of food becomes exhausted; the vesicles, it would appear, derive their nourishment by the process of osmose, sucking in, as it were, certain portions of the organic fluid and chemically decomposing it, appropriating a part of its nitrogen and throwing off the carbonic acid. If, however, it be placed

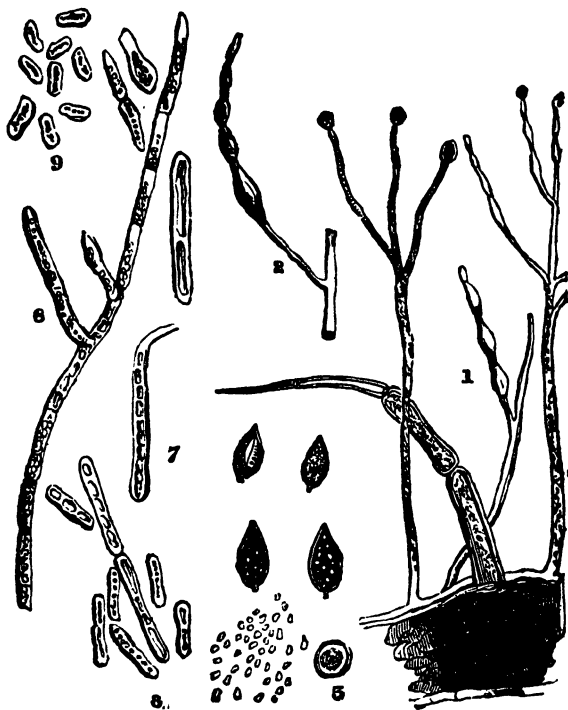

Fig. 160.—Fungoid growths.

- 1, Section from a Tomato, showing sporangia growing from cuticle. 2, A portion of same, detached, to show the mode of budding out from the upper part of a branch. 3, Vertical and lateral views of spores with oospores turned out. 4, 5, 6, 7, and 8, Different stages of growth of *Mycoderma cerevisiae*. 9, *Torula diabetica*.

in any adverse condition, it becomes surrounded by layers of condensed material, resulting from the death of the

germinal matter ; ultimately a mere trace of life remains, which, taking the form of an impalpable powder, is free to be driven hither and thither with every breath of air.

From these facts we may conclude that it matters little whether we take yeast, achorion, or penicillium spores ; the resultant is the same, and depends much more on the food or nourishment supplied, whether the pabulum contains more or less of a saccharine, albuminous, or nitrogenous material, lactic acid, &c., together with light and temperature ; whether we have a mould (green or blue), an achorion, or yeast fungus produced. Diversity of form in the cells, as well as quality and quantity of their material contents, are certainly due to, and in a manner regulated and controlled by that beautiful law of *diffusion*, which admits, separates, sifts, and refines the coarser from

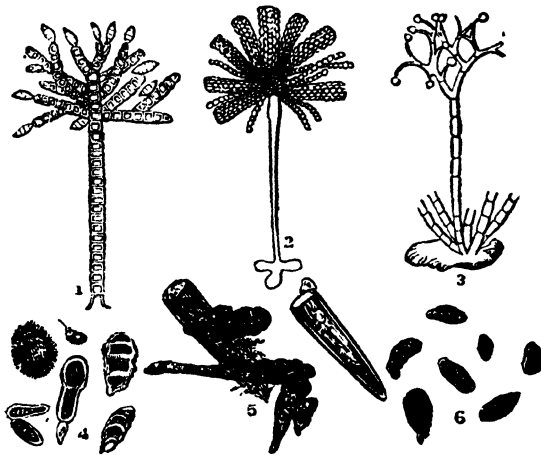

Fig. 161 — *Fungi*. (Magnified 200 diameters.)

- 1, *Bruchycladium penicillatum*, growing on the stem of a plant. 2, *Aspergillus glaucus*, growing on cheese, &c. 3, *Botrytis* ; the common form of mould on decaying vegetable substances. 4, *Sphaeria*, fungi caught over a sewer (foul air). 5, Fungi growing on a pumpkin. 6, Fungi caught in the air at the time of the cholera visitation, 1854.

the finer, the lighter from the denser particles, through the porous structure of the cell-wall.



We cannot conclude this brief notice of the fungi without adding a few words upon that curious group of subterranean plants, which instead of producing their spores at the summit of a basidium, or extremity of a simple filament, produces them in the interior of a vesicle or pouch, called a theca or ascus. Of this species the best known example is the truffle (*Tuber cibarium*).

It is, perhaps, not very generally known that the curiously formed, irregular mass, so much esteemed for its delicious taste, and sought after as a luxury, the truffle, is in truth a species of mushroom; more properly speaking, a subterranean puff-ball, or fungus. Its existence, entirely removed from the action of light, is an anomaly even among plants of the fungus kind; for light, although not in a large degree necessary to the fungus, is almost always indispensable to its full development. It would, therefore, be most difficult to discover, if it were not for a peculiar and penetrating odour, which dogs are taught to recognise; and by the aid of these useful animals its presence is detected hidden beneath the soil.

Tulasne and others have pointed out that these fungi present two essentially different types. In the one, *Hymenogastreae*, the internal fleshy mass presents a number of irregular cavities, lined by a membrane analogous to that which clothes the gills of the Agaric, and the superficial cells produce at their free extremities three or four spores, or seeds, which become detached, and eventually fill up the cavities. The other type, *Elaphomyces*, *Tuberaceae*, comprising those of the truffle kind, and as may be surmised by the scientific name assigned to them—*Tuber cibarium*,—are plants characterised from the underground root presenting a fleshy mass, the outer surface of which constitutes the common envelope, *peridium*, while the numerous narrow sinuous cavities are lined and in part filled up by filamentous tissue, mingled with cells of a peculiar form, and terminating in spores.

A section from the fleshy-looking mass cut very thin (Plate I. No. 2), and viewed under a power of 250 diameters, is found to be chiefly composed of cellular substance, the interspaces of which are filled up by jointed filaments, homologous to the mycelium or spawn

of other fungi,—in the mushroom, as an example, it is the mushroom spawn,—while the veins, the reproductive parts, contain in their cellular tissue minute ovoid capsules, with two or more globular yellowish seeds; this curious structure having all the parts of nutrition and reproduction enclosed internally, instead of externally, as in other fungi.

Truffles are produced in this way: the mycelium quickly decays and allows the fungoid body to grow on in an isolated condition. About September the ground becomes covered with numerous white cylindrical articulated filaments, not visible singly to the unassisted eye, but by their immense numbers and rapid growth readily seen, and found traversing the soil in every direction. These white flaxen threads are continuous with other flocculent filaments of the same nature. In the young truffles the external layer is gradually consolidated, and in a short time the destruction of the flocculent filaments are complete and lost in the young plant, which is soon isolated in the soil, and then the outer or cortical coat hardens, and ultimately has the appearance of a small nut. Thus, like other fungi, truffles are reproduced by spores, which give origin to filamentous mycelium and seed-vessels, the source of numerous offspring. Groups of spores are pretty objects; their stellate appearance reminds one of the Xanthidiæ; the mass of the full-grown plant at particular seasons is almost wholly made up of these bodies, which are of a yellowish-brown colour.

In these plants we have a double system of laminated filaments; one set arising from the cortical tissue absorbing the surrounding moisture and serving to transmit this to the cells in which the spores are formed, being therefore the organs of nutrition; the others white and opaque, terminating externally also, but conveying air to all parts of the body, and bringing the whole into contact with sporigenous cells.

The spores are developed freely in the vesicular cells destined to produce them. They are limited in number in each vesicle; less than two is never seen in one vesicle; the hexagonal basket-work arrangement of each seed appears to close with a lid, and ten or twelve short spines project out from every point.

Beneath the external dark-coloured reticulated membrane is a second integument, smooth and transparent, easily separated by maceration, although it resists the action of chemical agents, and is not coloured by iodine. The simple cavity of the internal spore is filled with minute granular particles and fatty globules, suspended in a fluid probably albuminous, as well as the various chemical salts found by Riègel, and upon which its peculiar flavour depends.

“Two new British fungi” are figured and described by the Rev. M. J. Berkeley, in vol. xxv. p. 431, Linnean Soc. Trans. *Peziza pygmaea*, Plate I. No. 4, is a remarkably interesting specimen of a genus which presents much variety in form. The description given of it is, “that it is about  $\frac{1}{4}$  inch high, the stem often splitting or branching out into several divisions, each of which is terminated by a minute cup, giving the plant the appearance of a *Ditiola*, or a *Tympanis*. Each cup produces other smaller cups on its surface; the branched and young cups resemble the genus *Solenia*: in a specimen found at Wimbledon, the mass of secondary cups gave the plant almost the appearance of a small *Gyromitra*.” The proliferous form is shown at Plate I. No. 5. The colour of the mature plant is a bright apricot, whitish and tormentose at the base of the stem. Found in swampy places, rotten gorse, &c. at Ascot, Wimbledon, &c. *Peziza* belongs to the Ascomycetous fungi; the genus contains numerous species, and many of them are brightly coloured, as in the very pretty *P. bicolor*, Plate I. No. 1. Tulasne says that some of them have a secondary fructification, consisting of stylospores. They are mostly found growing on trunks of trees, dead wood, &c.

We now pass to the examination of *Lichens*; in these plants, as in the Fungi, the germination of the spore consists in the emission of a hollow filament from some part of its surface. This filament, which is simply an extension of the spore-membrane, branches repeatedly, and spreads over the surface on which the spore has been sown; at the same time it divides by numerous septa which occur at irregular intervals. By the intertwining of the resurgent ramifications, a stroma is formed, to which

the term hypothallus is applied, and which constitutes the vegetative system of the future lichen. So far the development is the same as that of the fungi; but at a longer or shorter period after the formation of the hypothallus, we may observe upon its surface a whitish layer of spheroidal cellules, intimately united with each other as well as with the filaments from which they take their origin. This layer is the groundwork for a second formation of globular cells, and these are only to be distinguished from the first by the chlorophyll which they contain. They are called gonidia, and are peculiar to Lichens. Such is the formation of the most simply organized of the class, as the *Verrucariæ*, the receptacles (apothecia) of which closely resemble those of a *Sphaeria*, and are found upon the surface of the hypothallus. In the more complicated foliaceous Lichens, as *Parmelia*, the mature thallus is made up of two kinds of tissues, the medullary and corticated. The cortical portion forms the layers, an interior and superior, and consists of thick-walled cells, closely adherent to each other; from the surface of the inferior layer are given off numerous root-like appendages, on either side of which, or rather embedded in its cortical substance, are the gonidia, which form a green tissue. Of the spore-like organs, spermatia and stylospores, there are three varieties, to which the terms apothecia, spermogonia, and pyenides have been applied. The most common form of the apothecium is that of the disc, which may be plane, convex, or cup-shaped. This form is that which characterises the *Gymnocarpous* Lichens. In the *Angiocarpeæ* the organ is closed upwards, its superior surface becoming internal, so as to form a conceptacle like that of the *Pyrenomycetes*; the form, however, of which is subject to much variation.

The reproductive organs of Lichens, as in Fungi, are of five kinds.—1, Sporules, which are formed by the construction and subsequent separation of the extremity of a simple cylindrical filament; 2, Spermatia with their supporting pedicles; 3, Stylospores with their styles; 4, Thecæ or asci; 5, Basidia with their basidiospores. As regards the complexity of their form and structure they may be taken in the order in which they are here placed;

but, of the last-mentioned, it should be stated that they are almost solely found in Fungi, which have really no other reproductive organ. The spores present many points of difference, both in number and character, in different genera and species, and for this reason are most interesting microscopic objects. We would direct the reader's attention to an interesting and valuable paper, from the pen of Dr. Lauder Lindsay, in the *Linnean Soc. Trans.*, vol. **xxv.** p. 493, "On the Lichens of New Zealand" (the country *par excellence* of certain Lichens). The paper is very beautifully illustrated, showing chiefly the minute or microscopic anatomy of the reproductive organs of the species examined, and more especially the character of their spores.

A vertical section of *Parmelia stellata* is given in Plate I. No. 26: it belongs to an extensive genus of Gymnocarpous open-fruited Lichens, found growing upon trees, palings, stones, walls, &c. The emission of the ripe spores of the Lichens is a curious process, and not unlike that which is seen to take place in some of the Fungi, as in *Pezizæ*, *Sphaeriæ*, &c. If a portion of the thallus be moistened and placed in a common phial, with the apothecia turned toward one side, in a few hours the opposite surface of the glass will be found covered with patches of spores, easily perceptible by their colour; or if placed on a moistened surface, and one of the usual glass slips laid over it, the latter will be covered in a short time. As to the powers of dissemination of these lowly organized plants, Dr. Hicks's observations lead to the conclusion that the gonidia of Lichens have greater powers in this direction than has been generally supposed. He found by placing a clean sheet of glass in the open air during a fall of snow, and receiving the melting water in a tube or bottle, that he obtained large quantities of what has been looked upon as a "unicellular plant, commonly called '*Chlorococcus*,' the cells of which may remain in a dormant condition for a long time during cold weather, but upon the return of warmth and moisture they begin to increase by a process of subdivision, into two, four or eight portions, which soon assume a rounded form and burst the parent cell-wall open; these secondary cells

soon begin to divide and subdivide again, and this process may go on without much variation even for years. The phenomena described may also be watched by taking a portion of the bark of a tree on which the *Chlorococcus* has been deposited, and placing it under a glass to keep it in a moderately moist atmosphere; the only difference being a change in colour, which is caused by the growth of the fibres, as may be seen on microscopical examination. And this," Dr. Hicks says, "is an instructive point, because it will be found that the colour varies notably according to the Lichen prevalent in its neighbourhood."<sup>1</sup> He thinks there can be no doubt that what has been called *Chlorococcus*, is nothing more than the gonidia of some Lichen; and that under suitable conditions, chiefly drought and warmth, the gonidium often throws out from its external envelope, a small fibre, which, adhering and branching, ultimately encases it and forms a "soridium." 'The soridia also remain dormant for a very long time, and do not develop into thalli unless in a favourable situation; in some cases it may be for years. It will be easily perceived that the soridium contains all the elements of a thallus in miniature; in fact, a thallus does frequently arise from one alone, yet, generally, the fibres of neighbouring soridia interlace, and thus a thallus is matured more rapidly. This is one of the causes of the variation of appearance, so common in many species of Lichens, and is more readily seen towards the centre of the parent thallus. When the gonidia remain attached to the parent thallus, the circumstances are, of course, generally very favourable, and then they develop into secondary thalli, attached more or less to the older one, which, in many instances, decays beneath them. This process being continued year after year, gives an apparent thickness and spongy appearance to the Lichen, and is the principal cause of the various modifications in the external aspect of the Lichens which caused them formerly to be misclassified."<sup>2</sup>

(1) "For instance, where the yellow *Parmelia* is found, the *Chlorococcus* will assume a yellow tinge in its soridial stage. Viewed by transmitted light, they are also opaque balls, with irregular outline."

(2) "Contributions to the Knowledge of the Development of the Gonidia of Lichens." By J. Braxton Hicks, M.D. &c., *Quarterly Journal of Microscopical Science*, vol. vii. 860, p. 230.

The little group of *Hepaticæ* or Liverworts, which is intermediate between Lichens and Mosses, presents numerous objects of interest for the microscopist. These plants are produced by dust-like grains called *spores*, and minute cellular nodules called *gemmae* or buds. The *gemmae* of *Marchantia polymorpha* are produced in elegant membranous cups, with a toothed margin growing on the upper surface of the frond, especially in very damp court yards between the stones, or near running water, where its lobed fronds are found covering extensive surfaces of moist soil. At the period of fructification, these fronds send up stalks, which carry at their summit round shield-like or radiating discs. Besides which, it generally bears upon its surface a number of little open basket-shaped "conceptacles" which are borne upon the surface of the frond, as in fig. 162, and may be found

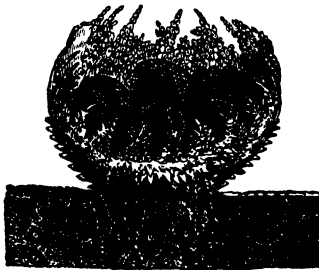

Fig. 162.—Gemmiparous Conceptacle of *Marchantia polymorpha*, expanding and rising from the surface of a frond.

in all stages of development. When mature it contains a number of little green round or oblong discs, each composed of two or more layers of cells; the wall is surmounted by a glistening fringe of teeth, whose edges are themselves regularly fringed with minute outgrowths. The cup seems to be formed by a development of the superior epidermis, which is raised up and finally bursts and spreads out, laying bare the seeds. The development of this structure presents much analogy to that of the sori of Ferns.

*Muscicææ*, Mosses, are an interesting form of vegetable life, Linnæus called them *servi*,—servants, or workmen,—as they seem to labour to produce vegetation in newly-formed countries, where soil is not yet formed. They also fill and consolidate bogs, and form rich mould for the growth of larger plants, which they protect from the

winter's cold. The common, or Wall Screw-moss, fig. 163, growing almost every where on old walls and other brick-work, if examined closely, will be found to have springing from its base numerous very slender stems, each

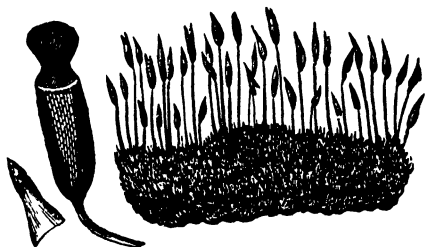

Fig. 163.—Screw Moss.

of which terminates in a dark brown case, which encloses its fruit. If a patch of the moss is gathered when in this state, and the green part of the base is put into water, the threads of the fringe will uncoil and disentangle themselves in a most curious and beautiful manner; from this circumstance the plant takes its popular name of Screw-moss. The leaf usually consists of either a single or a double layer of cells, having flattened sides, by which they adhere one to another. The leaf-cells of the *Sphagnum* bog-moss, fig. 179, exhibit a very curious departure from the ordinary type; for instead of being small and polygonal, they are large and elongated, and contain spiral fibres loosely coiled in their interior. Mr. Huxley pointed out, that the young leaf does not differ from the older, and that both are evolved by a gradual process of "differentiation." Mosses, like liverworts, possess both antheridia and pistillida, which are engaged in the process of fructification. The fertilized cell becomes gradually developed into a conical body elevated

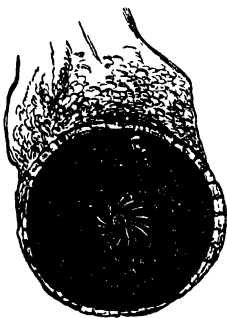

Fig. 164.—Mouth of Capsule of *Funaria*, showing Peristome.



upon a foot stalk; and this at length tears across the walls of the flask-shaped body, carrying the higher part upwards as a *calyptra* or hood upon its summit, while the lower part remains to form a kind of collar round the base. These spore-capsules are closed on their summit by *opercula* or lids, and their mouths when laid open are surrounded by a beautiful toothed fringe, termed the *peristome*. This fringe is shown in fig. 164 in centre of capsule of *Funaria*, with its peristome *in situ*. The fringes of teeth are variously constructed,

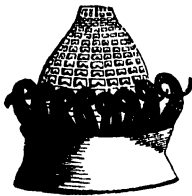

Fig. 165 — Double Peristome of *Neckera Antipyretica*.

and are of great service in discriminating the *genera*. In *Neckera anti-pyretica*, fig. 165, the peristome is double, the inner being composed of teeth united by cross bars, forming a very pretty trellis. The seed spores are contained in the upper part of the capsule, where they are clustered round a central pillar, which is termed the *columella*; and at the time of maturity, the interior of the capsule is almost entirely occupied by spores.

It may here be mentioned, that all mosses and lichens are more easily detached from the rocks and walls on which they grow in frosty weather than at any other



Fig. 166. — Scale-Moss.

period, and consequently they are best studied in winter. One of the commonest, Scale-moss, fig. 166 (*Jungermannia bidentata*), grows in patches, in moist, shady situations, near the roots of trees: see Plate II. Nos. 35 and 36. The seed-vessels are little oval bodies, which if gathered when unexpanded, and brought into a warm room, burst under the eye with violence the moment a drop of water is applied to them, the valves of the vessel taking the shape of a cross, and the seeds distending in a cloud of brown dust. If this dust be examined with the

microscope, a number of curious little chains, looking something like the spring of a watch, will be found among it, their use being to scatter the seeds ; and if the seed-vessel be examined while in the act of bursting, these little springs will be found twisting and writhing about like a nest of serpents. The undulating Hair-moss (*Polytrichum undulatum*), fig. 167, is found on moist shady banks, and in woods and thickets. The seed-vessel has a curious shaggy cap ; but in its construction it is very similar to that of the Screw-moss, except that the fringe around its opening is not twisted.

*Equisetaceæ*.—The history of the development of the Equisetaceæ (horse-tails) corresponds in some respects with that of Ferns. The spore-case of this solitary genus is a most interesting object under the microscope ; they have apparently only one coat, for the outer coat splits up into four thread-like processes (*elaters*), clubbed at their free ends.

While the spore remains on the sporange, these fibres are rolled round the spore, as seen in fig. 170, G ; but by gently shaking the fruit spike, the spores are discharged, the coiled fibres immediately unroll, as at F, their elasticity causing them to spring about in a most curious manner. In a few minutes this motion apparently ceases, but if breathed upon they again unroll and dart about with wonderful elasticity.

*Ferns*.— In the Ferns we have an intermediate state, somewhat between mosses and flowering plants ; this would not apply to the reproductive apparatus, which is formed upon the same type as that of Mosses ; and, furthermore, it is to be observed, that Ferns do not form

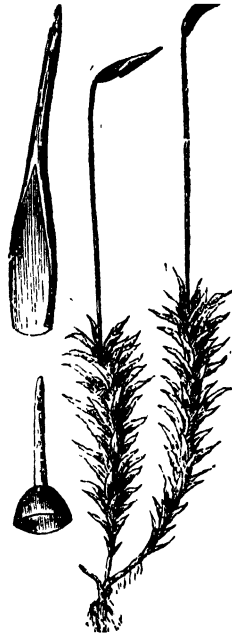

Fig. 167.—Hair-Moss in Fruit.

buds like other plants, but that their leaves, or fronds as they are properly called, when they first appear, are rolled up in a circinate form, and gradually unfold, as in fig. 168.



Fig 168 — Male Fern. A portion of leaf with sori.

Ferns have no visible flowers; and their seeds are produced in clusters, called *sori*, on the backs of the leaves. Each sorus contains numerous thecæ, and each theca encloses almost innumerable sporanges, with spores or seeds. There are numerous kinds of ferns, all remarkable for some interesting peculiarity; but it is their spores which are chiefly sought for by the microscopist.

The first account of the true mode of development of Ferns from their spores was published in 1844, by Nægeli, in a memoir entitled *Moving Spiral Filaments (spermatie filaments) in Ferns*, wherein he announced the existence of the bodies now called *antheridia*; but, mistaking the *archegonia* for modified forms of the *antheridia*, he was led away from a minute investigation of them. If he had followed the development of the *prothallia* further, he would have detected the relations of the nascent embryo, which would probably have put him on the right track. As it was, the remarkable discovery of the moving spiral filaments occupied all his attention, and caused him to fall

into an error in certain important respects; for example, he has represented what is undoubtedly an *archegonium* filled with cellules, *sperm-cells*, which, he states, "emerged from it as from the *antheridia*." This description is not quite correct.

The reproduction of ferns had, until within the last few years, been a vexed question among botanists. The riddle was at length solved by the labours of Count Suminski, who discovered that it is in the structures developed from the spores in germination that the pistillidia and antheridia of ferns are to be sought. The nature of the phenomena by which the propagation of ferns is effected, is as follows. In all the different species of ferns, the spores are contained in brown dots, on lines collected on the under surfaces, or along the edges of the fronds. Each of the spore-cases is surrounded by an elastic ring, which when the time arrives for the spores to be set free, makes an effort to straighten itself, and in so doing causes the spore-case to which it is attached to split open, and the spore dust to be dispersed. Very soon after these spores have begun to germinate, a flat plate-like expansion, somewhat resembling a heart in form, shows itself. This expansion gradually thickens, the tube from which it had sprung withering away. So far, observes Mr. Henfrey, there is nothing very remarkable in the development of these plants from their spores, but the succeeding phenomena are exceedingly curious. The main particulars are thus described by him:

"At an early period of the expanding growth of the leaf-like product of the spore, termed the prothallium or germ-frond, a number of little cellular bodies are found projecting from the lower surface, which, if placed in water when ripe, burst and discharge a quantity of microscopic filaments, curled like a corkscrew, and furnished with vibrating hair-like appendages, by the motion of



Fig. 169.—Sorus of *Deparia prolifera*.

which they are rapidly propelled through the water. The cellular bodies from which these are discharged are termed the antheridia of the ferns, and are in their physiological nature the representatives of the pollen of the flowering plants. At a somewhat later period other cellular bodies of larger size and more complex structure are found in small numbers about the central part of the lower surface of the prothallium on the thickened portion, situated between the notch and the part where the radical filaments arise. These, the pistillidia or archegonia of the ferns, are analogous to the ovules or nascent seeds of flowering plants, and contain, like them, a germinal vesicle, which becomes fertilized through the agency of the spiral filaments mentioned above, and is then gradually developed into an embryo plant possessing a terminal bud. This bud begins at once to unfold and push out leaves with a circinate vernation, which are of a very simple form at first, and rise up to view beneath the prothallium, coming out at the notch; single fibrous roots are at the same time sent down into the earth, the delicate expanded prothallium withers away, and the foundation of the perfect fern plant is laid. As the bud unfolds new leaves, the root stock gradually acquires size and strength, and the leaves become larger and more developed; but it is a long time before they assume the complete form characteristic of the species."

These observations on Ferns have acquired vastly-increased interest from the subsequent investigations of Hoffmeister, Mettenius, and Suminski, on the allied Cryptogams, and, above all, from Hoffmeister's observations on the processes occurring in the impregnation of the Conifers. Not only have these investigations given us a satisfactory interpretation of the *archegonia* and *antheridia* of the Mosses and Liverworts, but they have made known and co-ordinated the existence of analogous phenomena in the *Equisetaceæ*, *Lycopodiaceæ*, and *Rhizocarpeæ*, and shown, moreover, that the bodies described by Mr. Brown in the Conifers, under the name of "corpuscles," are analogous to the *archegonia* of the Cryptogams; so that a link is hereby formed between these groups and the higher flowering plants.

The fruits, or *sori*, of Ferns afford a very beautiful variety of objects for the microscopist, and they possess an advantage in requiring little or no preparation—nothing more being necessary than that of taking a portion of a frond, place it on a glass-slip under the microscope, and throwing a condensed light upon it by the aid of the side reflector. Even germination may be watched by simply employing gentle heat and moisture. Take, as Hoffmeister directs, a frond of a Fern whose fructification is mature, lay it upon a piece of glass covered with fine paper, and place the spore-bearing surface downwards upon this; in the course of a day or two this paper will be found to be covered with a fine brownish dust, which consists of the liberated spores. These must be carefully collected, and spread out upon the surface of a smooth fragment of porous sandstone, and then placed in a saucer, the bottom of which is before covered with water; a glass tumbler being inverted over it to ensure the requisite supply of moisture, and prevent rapid evaporation. Some of the prothallia soon germinate; if the cup be kept only slightly moist for some time, and then suddenly watered, a large number of antheridia and archegonia quickly open, and in a few hours the surface of the larger prothallia will be covered with moving antherozoids. If sections of these be made, that is, the canals laid open, with a power of 200 or 300 diameters we may occasionally see antherozoids in motion.

CHARACEÆ.—*Chara vulgaris* is the plant in which the important fact of vegetable circulation was discovered; Fig. 170, No. 1, is a portion of the plant of the natural size. Every knot or joint may produce roots; but it is somewhat remarkable, that they always proceed from the upper surface of the knot, and then turn downwards; so that it is not peculiar that the first roots also should rise upwards with the plant, come out of the base of the branch, and then turn downwards.

Mr. Varley noticed:—"The ripe globules spontaneously open; the filaments expand and separate into clusters." "These tube-like filaments are divided into numerous compartments, in which are produced the most extraordinary objects ever observed of vegetable origin, Fig. 170 A. At first they are seen agitating and moving in their

cells, where they are coiled up in their confined spaces, every cell holding one. They gradually escape from their

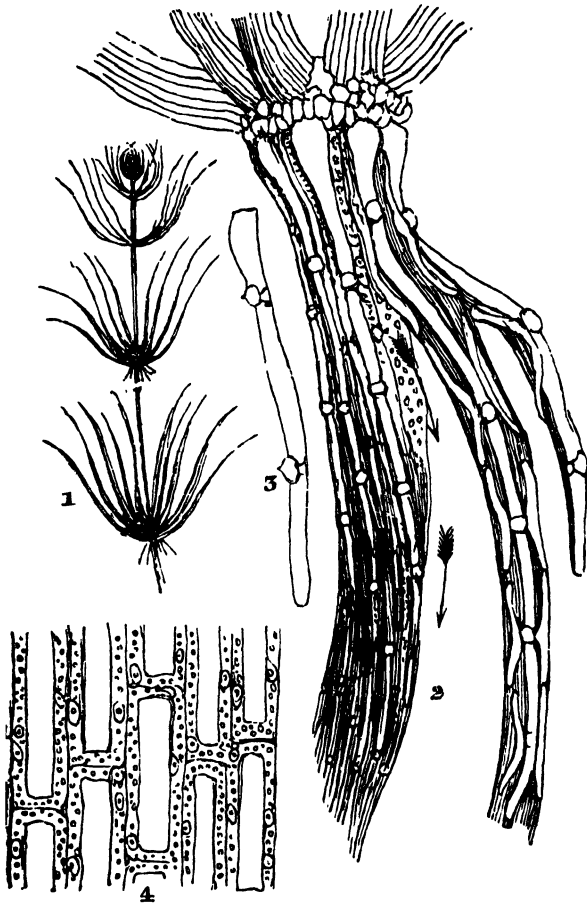

Fig. 170.

1 Branch of *Chara vulgaris*. 2, Magnified view: the arrows indicate the course taken by the granules in the tubes. 3, A limb of ditto, with buds at joints. 4, Portion of a leaf of *Vallneria spiralis*, with cells and granules.

cells, and the whole field soon appears filled with life. They are generally spirals of two or three coils, and never become straight, though their agitated motion alters their shape in some degree. At their foremost end is a filament so fine as only to be seen by its motion, which is very rapid and vibratory, running along it in waves: and of a globule be forcibly opened before it is ripe, the filaments will give little or no indication of life."

They swim about freely for a time, but gradually getting slower and slower; in about an hour they become quite motionless. Unger described these moving filaments in *Sphagnum* (bog-moss) as *Infusoria*, under the name of

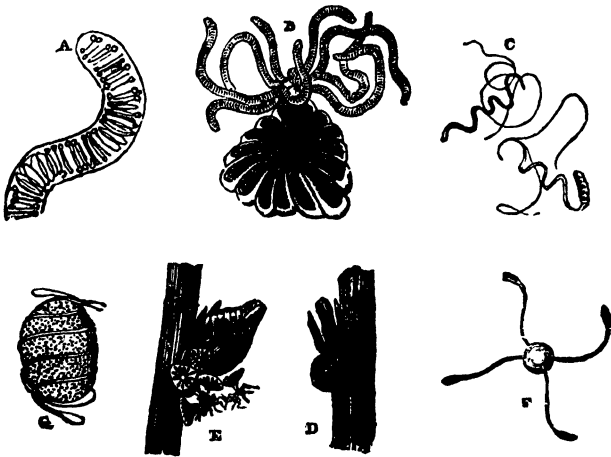

Fig. 171.—*Antheridia of Chara fragilis, &c.*

A, Portion of filament dividing into *Phytozoa*, "antheroids." B, A valve, with its group of antheridial filaments, composed of a series of cells, within each of which an *antherozoid* is formed. C, The escape of the mature *antherozoids* is shown. D, *Antheridium*, or globule, developed at the base of nucule. E, *Nucule* enlarged, and globule laid open by the separation of its valves. F, Spores and elaters of *Equisetum*. G, Spores surrounded by elaters of *Equisetum*.

*Spirillum*; and consequently they have been the cause of much controversy. Schleiden, very properly denying their animal nature, says:—"They are nothing more than fibre



in an early stage of development." The Characeæ are all aquatic plants of filamentous structure. Some authors have divided the species into two genera, *Nitella* (simple tubes) and *Chara* (cortical tubes). The circulation in the ordinary tubes or cells consists in the movement of the gelatinous protoplasmic sac, seen, as one mass, slowly passing up one side, across the ends, and down the opposite side, not perpendicularly, but in an oblique or spiral course, as indicated in the figure. The *Characeæ* multiply by gemmæ, produced at the articulations of their stems.

Mr. H. J. Carter, in a paper of great interest, published January, 1857, on the "Development of the Root-cell and its Nucleus, in *Chara Verticillata*," describes a structureless cell-wall, and a protoplasm composed of many organs. "This," he says, "is surrounded by a cell, the 'protoplasmic sac,' which is divided into a fixed and rotatory portion; these again respectively enclose the nucleus 'granules,' and axial fluid; while small portions of irregular shaped granular bodies are common to both. If we take the simple root-cell about the eighteenth hour after germination, when it will be about half-an-inch long, and 1-600th of an inch broad, and place it in water between two slips of glass for microscopic observation, under a magnifying power of about four hundred diameters, we shall find, if the circulation be active and the cell-wall strong and healthy, that the nucleus, which is globular, gradually becomes somewhat flattened, having several hyaline vacuoles of different sizes; the change goes on gradually until it appears of more elongated form, growing fainter on its outline, and then entirely disappears, leaving a white space corresponding to its capsule or cell-wall, with a faint remnant of some structure on the centre. Subsequently, this space becomes filled up with the fixed protoplasm, and after an hour or two the nucleus reappears a little behind its former situation, but now reduced in size, and with its nucleolus double, instead of single as before; each nucleolus being about one-fourth part as large as the old nucleolus, and hardly perceptible. Meanwhile a faint septum is seen obliquely extending across the fixed protoplasm, a little beyond the nucleus;

and if iodine be applied at this time, the division is seen to be confined to the protoplasm, as the latter, from contraction, withdraws itself from each side of the line where the septum appeared, and leaves a free space which is bounded laterally by an uninterrupted continuation of the protoplasmic sac. In this way changes go on until its shape is altered and it becomes converted into a bunch of rootlets. Thus the new cells are never entirely without a nucleus, which would appear to exert some influence upon their development, for as soon as the only two new cells which the root-cell gives off are formed, the old nucleus becomes effete.

“Now as to the office of the nucleus, nothing more is revealed to us in the development of the roots of *Chara*, than that, so long as new cells are to be budded forth, the nucleus continues in active operation, but when this ceases it becomes effete; while the rotation of the protoplasm and subsequent enlargement of the cell, &c., which are much better exemplified in the plant-stem than in the root-cell, go on after the nucleus ceases to exist. Hence the development of the root-cells of *Chara* affords us nothing positive respecting the functions of this organ; and therefore, if we wish to assign to it any uses in particular, they must be derived from analogy with some organism in which there is a similar nucleus whose office is known. If for this purpose we may be allowed to compare the nucleus of *Chara* with that of the rhizopodous cell, which inhabits its protoplasm, we shall find the two identical in elementary composition; that is, both consist at first of a ‘nuclear utricle,’ respectively enclosing a structureless homogeneous nucleolus; the latter, too, in both, is endowed with a low degree of movement.

“After this, however, the nucleolus of the *Rhizopod* cell becomes granular and opaque; and when, under circumstances favourable for propagation, a new cell-wall is formed around the nuclear utricle,—or this may be an enlargement of the nuclear utricle itself,—I do not know which; the granular substance of the nucleolus becomes circumscribed, and shows that it is surrounded by a spherical, capsular cell; the granules enlarge, separate, pass

through the spherical capsule into the cavity of the nuclear utricle; a mass of protoplasm makes its appearance, and this divides up into monads, or, as I first called them, 'gonidia.'<sup>1</sup>

"The movement of the rotating protoplasm in the *Characeæ* is also very slow; for, when it is viewed in the long internodes of *Nitella* with a very low power, or even with the naked eye, it seems hardly to move faster than the foot of a *Gasteropod*; still there is no positive evidence that it moves round the cell after the manner of the latter, although it would appear to possess the power of movement *per se*. Hence the question remains undecided, viz. whether it moves round the cell by itself, or by the aid of cilia disposed on the inner surface of the protoplasmic sac, in like manner to those which appear to exist in the abdominal cavity of *Vaginicola crystallina*, and which have been seen in *Closterium lunula*."<sup>2</sup>

The stems and arms of *Chara* are tubular, and entirely covered with smaller tubes, the circulation can mostly be observed in these, as shown at Fig. 170. Any ordinary cutting to obtain sections would squeeze the tube flat, and spoil it and the lining; it is, therefore, better to avoid this, by laying the *Chara* on smooth wood, just covered with water; then, with a sharp knife, make suddenly a number of quick cuts across it, and so obtain the various sections required. Wet a slip of glass, and turn the wood over so as just to touch the water, and the sections will fall from the wood on to the glass, ready for the microscope.

"The *Chara* tribe is most abundant in still waters or ponds that never become quite dry; if found in running water, it is mostly met with out of the current, in holes or side bays, where the stream has little effect, and never on any prominence exposed to the current. If the *Chara* could bear a current, its fruit would mostly be carried on and be deposited in whorls; but it sends out from its various joints very long roots into the water, and these would by agitation be destroyed, and then the plant

(1) *Ann. and Mag. Nat. Hist.* vol. xvii. 1856.

(2) In Plate I. No. 27, is represented the Moss *gonida*, assuming the amoeboid form as described by Dr. Hicks in the *Linnean Trans.* 1862.

decays; for although it may grow long before roots are formed, yet when they are produced their destruction involves the death of the plant. In order, therefore, to preserve *Chara*, every care must be taken to imitate the stillness of the water by never shaking or suddenly turning the vessel. It is also important that the *Chara* should be disturbed as little as possible; and if requisite, it must be done in the most gentle manner, as, for instance, in cutting off a specimen, or causing it to descend in order to keep the summit of the plant below the surface of the water.

Similar care is requisite for *Vallisneria*; but the warmest and most equal temperature is better suited to this plant. It should be planted in the middle of the jar in about two inches deep of mould, which has been closely pressed; over this place two or three handfuls of leaves, then gently fill the jar with water. When the water requires to be changed, a small portion is sufficient to change at a time. It appears to thrive in proportion to the frequency of the changing of the water, taking care that the water added rather increases the temperature than lowers it.

The natural habitat of the *Frog-bit*, another water-plant of great interest, is on the surface of ponds and ditches; in the autumn its seeds fall, and become buried in the mud at the bottom during the winter; in the spring these plants rise to the surface, produce flowers, and grow to their full size during summer. *Chara* may be found in many places around London, the Isle of Dogs, and in ditches near the Thames bank.

*Anacharis alsinastrum*.—This remarkable plant is so unlike any other water-plant, that it may be at once recognised by its leaves growing *in threes* round a slender stringy stem. The watermen on the river have already named it "Water-thyme," from a faint general resemblance which it bears to that plant. In 1851 the *Anacharis* was noticed by Mr. Marshall and others in the river at Ely, but not in great quantities. Next year it had increased so much, that the river might be said to be full of it.

The colour of the plant is deep green; the leaves are

nearly half an inch long, by an eighth wide, egg-shaped at the point, and beset with minute teeth, which cause them to cling. The stems are very brittle, so that whenever the plant is disturbed, fragments are broken off. Its powers of increase are prodigious, as every fragment is capable of becoming an independent plant, producing roots and stems, and extending itself indefinitely in every direction. Most of our water-plants require, in order to their increase, to be rooted in the bottom or sides of the river or drain in which they are found; but this is independent altogether of that condition, and actually grows as it travels slowly down the stream after being cut. The specific gravity of it is so nearly that of water, that it is more disposed to sink than float. A small branch of the plant is represented, with a Hydra attached to it, in a subsequent chapter.

Mr. Lawson pointed out the particular cells in which the current or circulation will be most readily seen—viz. the elongated cells around the margin of the leaf and those of the midrib. On examining the leaf with polarised light, these cells, and these alone, are found to contain a large proportion of silica, and present a very interesting appearance. A bright band of light encircles the leaf, and traverses its centre. In fact, the leaf is set, as it were, in a framework of silica. By boiling the leaf for a short time in equal parts of nitric acid and water, a portion of the vegetable tissue is destroyed, and the silica rendered more distinct, without changing the form of the leaf.<sup>1</sup>

It is necessary to make a thin section or strip from the leaf of *Vallisneria*, for the purpose of exhibiting the circulation in the cells, as shown in fig. 170, No. 4. Among the cells granules, a few of a more transparent character than the rest, may be seen, having a nucleolus within.

The phenomenon of cell rotation is seen in other plants besides those growing in water. The leaf of the common plantain or dock, *Plantago*, furnishes a good example; the movement being seen both in the cells of the plant, and hairs of the cuticle torn from the midribs. The Spiderwort will be noticed further on.

(1) See also a paper in Vol. IV. *Microscopical Journal of Science*, on the Circulation in the Leaf of *Anacharis*, by Mr F H. Welcham

*Structure of Plants.*—The development of cells in plants takes place in all cases in essentially the same way, but the form of the result is subject to a number of important modifications. Most elementary works on Botany enter so fully into this interesting question, that it is quite unnecessary to do more than refer very briefly to the more important structural peculiarities of plants. *Cell-division*, as we have seen, is the universal formative process by which vegetative growth is effected, and *free-cell-formation* occurs only in the production of cells connected with reproduction. In the lower classes of plants, especially in aquatic genera, we can observe the process of cell-division in all its details; but in the higher, knowledge of this kind is only accessible by dissection.

As long as the cell retains its primordial utricle, it is capable of producing new cells, and organized forms of assimilated matter, like starch, chlorophyll, &c. in its contents. This is the case in all nascent tissues, but it ceases to be so at various periods in different parts of the vegetable organization. In all woody tissues, in all pitted and spiral-fibrous cells it disappears early; the secondary deposits of the ligneous character being formed apparently from the watery cell-sap. In herbaceous organs, such as leaves, in the cells of the cellular plants generally, the primordial utricle remains. "This explains why the power to form adventitious buds exists not only in the cambrium layer of the higher plants, but, under certain conditions, even in the leaves, and why *germination* or propagation by little cellular bulbels, or isolated cells detached from the vegetative organs, is so common among the cellular plants, and in the Mosses and Liverworts, where parenchymatous tissues so greatly predominate."—(Henfrey.)

The *tissues* of plants, properly so called, consist of collections of cells of uniform character, permanently combined together by more or less complete union of their outer surfaces. Tissues are of many kinds, according to the form of the cells, the character of the cell-membrane, and the manner in which the cells are connected together. The milk-vessels found in connexion with certain cells appear to be formed out of the intercellular passages, and not by

fusion of cells ; hence they do not constitute a true cellular tissue.

*Vascular tissue* is formed by the fusion of perpendicular rows of cells ; by the absorption of their contiguous walls they become converted into continuous tubes of more or less considerable length. Then we have a combination of tissues destined for particular purposes in the economy of the plant, divided into three primary systems—the *Cellular*, the *Fibro-vascular*, and *Cortical*. The 1st, Cellular, forms the great mass of the living structure of plants ; and it is in this system that the vital processes of vegetation are chiefly carried on. The 2d, Fibro-vascular, forms all the woody structures, which in all cases are composed of a quantity of conjoined portions of cellular and vascular tissue arranged in a peculiar manner ; differing in their modes of growth in different classes of plants, and which in consequence present considerable differences in the structure of their mature stems. The 3d, Cortical, also termed the *epidermal*, exists in the form of a simple flat layer of cells united firmly together by their sides, and forming a continuous coat over the surface of a plant. Such a layer clothes all the organs of plants above the Mosses, and, as stems grow older, the epidermal layer gives place to the bark or rind. *Stomata* are orifices between the meeting angles of the epidermal cells ; most abundant usually on the lower surface of leaves, often wanting on the upper surface. On the leaves of aquatic plants they are only found on the upper surface, and are absent where the leaf touches the water.

Hairs and scales of all kind depend on the development of the epidermal cells. Simple hairs are merely single epidermal cells produced in a tubular filament, and when cell-multiplication occurs in them they present a number of joints ; see hairs of nettle, fig. 188, No. 2. Thorns, such as those of the rose, are aborted branches, in which the cells become thickened by woody secondary deposits. In leathery or hard leaves, and in the thick tough leaves of succulent plants, such as the aloes, the secondary layers acquire great thickness. The aerial roots of the Orchidaceæ exhibit a curious structure, the growing extremities being clothed by a whitish cellular tissue composed of several

layers of cells with a delicate spiral fibrous deposit on their walls. This layer forms a kind of coat over the real epidermis of the root, and is known by the name of the *Velamen radicum*. The young shoots of Dicotyledonous trees and shrubs are clothed with epidermis-like herbaceous plants; but, before the close of the past season of growth, in most cases the green colour gives place to brown, which is owing to the formation of a layer of cork from the outer layers of cortical parenchyma. Cork is composed of tubular thin-walled cells containing only air; and sometimes these intercellular passages occupy a considerable space, and communicate in all directions, forming a system of *air-spaces* in the tissue. In addition there is the *secretory* system, consisting of *glands*, simple and compound, *milk-vessels*, and canals filled with resins, oils, &c.

Much of the physiological history of plant life has yet to be made out: the mode in which the circulation and the formation of wood are carried on is by no means a settled question. Mr. Herbert Spencer observes:<sup>1</sup>—"That the supposition that certain vessels and strings of partially united cells, lined with spiral, annular, reticulated, or other frameworks, are carriers of the plant juices, is objected to on the ground that they often contain air; as the pressure of air arrests the movements of blood through arteries and veins, its presence on the ducts of stems and petioles is assumed to unfit them as channels for sap. On the other hand, that these structures have a respiratory office, as some have thought, is certainly not more tenable, since the presence of air in them negatives the belief that their function is to distribute liquid. The presence of liquid in them equally negatives the belief that their function is to distribute air. Nor can any better defence be made for the hypothesis which I find propounded, that these parts serve 'to give strength to the parenchyma.' In the absence of any feasible alternative, the hypothesis that these vessels are distributors of sap claims reconsideration." To obtain data for an opinion on this vexed question, Mr. Spencer instituted a series of experiments on the absorption of dyes by plants. His first experiments were failures, and it was only

(1) *Linnean Soc. Trans.* vol. xxv. page 405.



after trying experiments with leaves of different ages and different characters, and with undeveloped axes, as well as with axes of special kinds, that it became manifest that the appearances presented by ordinary stems, when thus tested, are in a great degree misleading. "If an adult shoot of a tree or shrub be cut off, and have its lower end placed in an alumed decoction of logwood, or a dilute solution of magenta,<sup>1</sup> the dye will, in the course of a few hours, ascend to a distance, varying according to the rate of evaporation from the leaves. On making longitudinal sections of the part traversed by it, the dye is found to have penetrated extensive tracts of the woody tissue; and, on making transverse sections, the openings of the ducts appear as empty spaces in the midst of a deeply-coloured prosenchyma. It would thus seem that the liquid is carried up the denser parts of the vascular bundles, neglecting the cambium layer, the central pith, and the spiral vessels of the medullary sheath." This, however, is found to be only partially true. "There are indications that while the layer of pitted cells next the cambium has served as a channel for part of the liquid, the rest has ascended the pitted ducts, and oozed out of these into the prosenchyma around. This is seen, if, instead of allowing the dye time for oozing through the prosenchyma, the end of the shoot be just dipped into the dye and taken out again, we find that, although it has become diffused to some distance round the ducts, it has left tracts of wood between the ducts mentioned. Again, if we use one dye after another, a shoot that has absorbed magenta for an hour and then placed for five minutes in the logwood decoction, transverse sections taken at a short distance from the end of the shoot, show the mouths of the ducts surrounded by dark stains in the midst of the much wider red stains. The behaviour of these corresponds perfectly with the expectation that a liquid will ascend capillary tubes in preference to simple cellular tissue, or tissue not differentiated into continuous

(1) "These two dyes have affinities for different components of the tissues, and may be advantageously used in different cases. Magenta is rapidly taken up by wood-matter and secondary deposits, while logwood colours the cell-membranes, and takes but reluctantly to the substances seized by magenta. By trying both of them on the same structure, we may guard ourselves against any error arising from relative combination."

canals. Experiments with leaves bring out parallel facts; and this, then, is confirmed, that in ordinary stems the staining of the wood by an ascending coloured liquid is due, not to the passage of the coloured liquid up the sub-

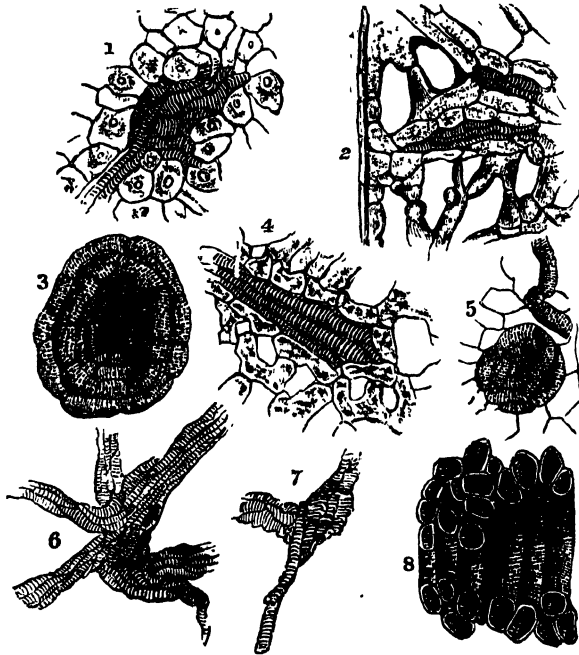

Fig 172.—Termination of Vascular System (after Spencer).

1. Absorbent organ from the leaf of *Euphorbia nerifolia*. The cluster of fibrous cells forming one of the terminations of the vascular system is here embedded in a solid parenchyma.

2. A structure of analogous kind from the leaf of *Ficus elastica*. Here the expanded terminations of the vessels are embedded in the network parenchyma, the cells of which unite to form envelopes for them.

3. End view of an absorbent organ from the root of a turnip. It is taken from the outermost layer of vessels. Its funnel-shaped interior is drawn as it presents itself when looked at from the outside of this layer, its narrow end being directed towards the centre of the turnip.

4. Shows on a larger scale one of these absorbents from the leaf of *Panas Lessoni*. In this figure is clearly seen the way in which the cells of the network parenchyma unite into a closely-fitting case for the spiral cells.

5. A less-developed absorbent, showing its approximate connexion with a duct. In their simplest forms, these structures consist of only two fenestrated cells, with their ends bent round so as to meet. Such types occur in the cen-

tral mass of the turnip, where the vascular system is relatively imperfect. Besides the comparatively regular forms of these absorbents, there are forms composed of amorphous masses of fenestrated cells. It should be added that both the regular and irregular kinds are very variable in their numbers: in some turnips they are abundant, and in others scarcely to be found. Possibly their presence depends on the age of the turnip

6. Represents a much more massive absorbent from the same leaf, the surrounding tissues being omitted.

7 Similarly represents, without its sheath, an absorbent from the leaf of *Clusia fava*.

8 A longitudinal section through the axis of another such organ, showing its annuli of reticulated cells when cut through. The cellular tissue which fills the interior is supposed to be removed.

stance of the wood, but to the permeability of its ducts and such of its pitted cells as are united into regular canals; and the facts showing this at the same time indicate with tolerable clearness the process by which wood is formed, for what in these cases is seen to take place with dye may be fairly presumed to take place with sap."

Taking it, then, as a fact that the vessels and ducts are the channels through which the sap is distributed, the varying permeability of their walls, and consequent formation of wood, is due to the exposure of the plant to intermittent mechanical strains, actual or potential, or both, in this way. "If a trunk, a bough, shoot, or a petule is bent by a gust of wind, the substance of its convex side is subject to longitudinal tension, the substance of its concave side being at the same time compressed. This is the primary mechanical effect. The secondary is when the tissues of the convex side are stretched, they also produce lateral compression of them. In short, that "the formation of wood is due to intermittent transverse strains, such as are produced in the aerial parts of upright plants by the action of the wind." Thus the subject is most ingeniously worked out, and the results of many very interesting and instructive experiments are recorded by the author of the paper.

"In the course of experiments on the absorption of dyes by leaves, it happened that, in making sections parallel to the plane of a leaf, with the view of separating its middle layer, containing the vessels, I came upon some structures that were new to me. These structures, where they are present, form the terminations of the vascular system. They are masses of irregular and imperfectly united fibrous cells, such as those out of which vessels

are developed ; and they are sometimes slender, sometimes bulky—usually, however, being more or less club-shaped. In transverse sections of leaves, their distinctive characters are not shown ; they are taken for the smaller veins. It is only by carefully slicing away the surface of a leaf, until we come down to that part which contains them, that we get any idea of their nature. Fig. 172, No. 1, represents a specimen taken from a leaf of *Euphorbia nerifolia*. Occupying one of the interspaces of the ultimate venous network, it consists of a spirally-lined duct or set of ducts, which connects with the neighbouring vein a cluster of half-reticulated, half-scalariform cells. These cells have projections, many of them tapering, which insert themselves into the adjacent intercellular spaces, thus producing an extensive surface of contact between the organ and the embedding tissues. A further trait is, that the ensheathing prosenchyma is either but little developed or wholly absent ; and consequently this expanded vascular structure, especially at its end, comes immediately in contact with the tissues concerned in assimilation. The leaf of *Euphorbia nerifolia* is a very fleshy one ; and in it these organs are distributed through a compact, though watery, cellular mass. But in any leaf, of the ordinary type, which possesses them, they lie in the network of parenchyma, composing its lower layer ; and wherever they occur in this layer its cells unite to enclose them. This arrangement is shown in No. 2, representing a sample from the Caoutchouc-leaf as seen with the upper part of its envelope removed ; and it is shown still more clearly in a sample from the leaf of *Panax Lessonii*, No. 4. Nos. 6 and 7 represent, without their sheaths, other such organs from the leaves of *Panax Lessonii* and *Clusia flava*. Some relation seems to exist between their forms and the thicknesses of the layers in which they lie. Certain very thick leaves, such as those of *Clusia flava*, have them less abundantly distributed than is usual, but more massive. When the parenchyma is developed not to so great an extreme, though still largely, as in the leaves of Holly, *Aucuba*, *Camellia*, they are not so bulky ; and in thinner leaves, like those of Privet, Elder, &c. they become longer and less conspicuously club-shaped.

“Some adaptations to their respective positions seem implied by these modifications; and we may naturally expect that in many thin leaves these free ends, becoming still narrower, lose the distinctive and suggestive characters possessed by those shown in the drawings. Relations of this kind are not regular, however. In various other genera, members of which I have examined, as *Rhus*, *Viburnum*, *Griselinia*, *Brexia*, *Botryodendron*, *Pereskia*, the variations in the bulk and form of these structures are not directly determined by the spaces which the leaves allow; obviously there are other modifying causes. It should be added that while these expanded free extremities graduate into tapering free extremities, not differing from ordinary vessels, they also pass insensibly into the ordinary inosculation. Occasionally, along with numerous free endings, there occur loops; and from such loops there are transitions to the ultimate meshes of the veins.

“These organs are by no means common to all leaves. In many that afford ample spaces for them they are not to be found. So far as I have observed, they are absent from the thick leaves of plants which form very little wood. In *Sempervivum*, in *Echeveria*, in *Bryophyllum* they do not appear to exist; and I have been unable to discern them in *Kalanchoë rotundifolia*, in *Kleinia ante-euphorbium*, and *fcoides*, in the several species of *Crassula*, and in other succulent plants. It may be added that they are not absolutely confined to leaves, but occur in stems that have assumed the functions of leaves. At least I have found, in the green parenchyma of *Opuntia*, organs that are analogous, though much more rudely and irregularly formed. In other parts, too, that have usurped the leaf-function, they occur, as in the phyllodes of the Australian acacias. These have them abundantly developed; and it is interesting to observe that here, where the two vertically-placed surfaces of the flattened-out petiole are equally adapted to the assimilative function, there exist two layers of these expanded vascular terminations, one applied to the inner surface of each layer of parenchyma.

“Considering the structures and positions of these organs, as well as the natures of the plants possessing them, may we not form a shrewd suspicion respecting their function?

Is it not probable that they facilitate absorption of the juices carried back from the leaf for the nutrition of the stem and roots? They are admirably adapted for performing this office. Their component fibrous cells, having angles insinuated between the cells of the parenchyma, are shaped just as they should be for taking up its contents, and the absence of sheathing tissue between them and the parenchyma facilitates the passage of the elaborated liquids. Moreover, there is the fact that they are allied to organs which obviously have absorbent functions. I am indebted to Dr. Hooker for pointing out the figures of two such organs in the *Icones Anatomicæ* of Link. One of them is from the end of a dicotyledonous root-fibre, and the other is from the prothallus of a young fern. In each case a cluster of fibrous cells, seated at a place from which liquid was to be drawn, is connected by vessels with the parts to which liquid has been carried. I have met with another such organ, more elaborately constructed, evidently adapted to the same office, in the common turnip-root. As shown by the end view and longitudinal section in Nos. 3, 5, and 8, this organ consists of rings of fenestrated cells, arranged with varying degrees of regularity into a funnel, ordinarily having its apex directed towards the central mass of the turnip, with which it has, in some cases at least, a traceable connexion by a canal. Presenting as it does an external porous surface terminating one of the branches of the vascular system, each of these organs is well fitted for taking up with rapidity the nutriment laid by in the turnip-root, and used by the plant when it sends up its flower-stalk. The cotyledons of young beans furnish other examples of such structures, exactly in the places where, if they be absorbents, we may expect to find them. Amid the branchings and inosculation of the vascular layer running through the mass of nutriment deposited in each cotyledon, there are found conspicuous free terminations that are club-shaped, and which prove to be composed, like those in leaves, of irregularly-formed and clustered fibrous cells, some of them diverging from the plane of the vascular layer, dipping down into the mass of starch and albumen which the young plant has to utilize, and which these structures can have no other function but to take up."

To return to cell-development ; we found the cell changing in its outward form, the transparent membranous cell wall becoming thickened, and spontaneous fissure taking place; and thus is formed a series of connected cells variously modified and arranged, according to the conditions under which they are developed and the functions which they are destined to exercise. The typical form, as we have

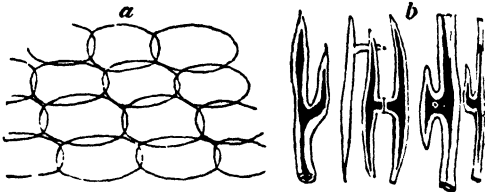

Fig. 173.—a, elementary cells ; b, branched cellular tissue.

before observed, of the vegetable cell is spheroidal ; but when developed under pressure within walls, or denser

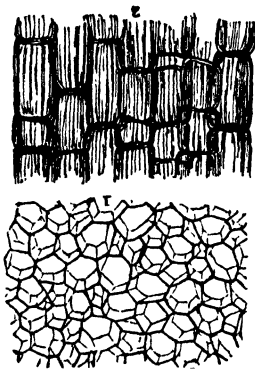

Fig. 174.

1, A transverse section of stem of

2, A vertical section of elongated cell.

tissues, it takes other shapes ; as the *oblong, lobed, square, prismatical, cylindrical, fusiform, muriform, stellate, filamentous, &c.* : and is then termed *Parenchyma*, and the cells woven together are called cellular tissue. In pulpy fruits the cells may be easily separated one from the other : a thin transverse section of a strawberry is represented at fig. 188, No. 15 : within the cells are smaller cells, commonly known as the pulp. Fig. 173, a, is the elementary form of oval cells or vesicles, passing on to the formation of branched cellular tissue, b. Remarkable speci-

mens of the filamentous tissue may be seen in fig. 188, No. 19, the circular elongated cells from the *Mushroom* ; only another and more closely connected growth of mucedinous fungi, commonly called mushroom spawn.

Fig. 175, in the stellate tissue cut from the stem of a *rush*, we have the formative network dividing into ducts for the purpose of giving strength and lightness to the stem of the plant. These ducts may undergo other transformations; the cell itself become gradually changed into a spiral continuous tube or duct, as seen in fig. 198;

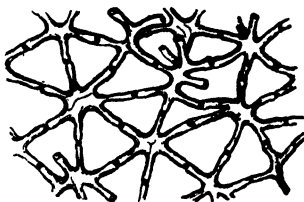

Fig. 175.—Stellate tissue, from stem of a *Rush*.

these are sometimes formed by the breaking down of the partitions; in the centre of which we may have a compound spiral duct, resembling portions of tracheæ from the silkworm.

Another important change occurs in the original cell,—it is that of its conversion into *woody fibre*. Common woody fibre (*Pleurenchyma*) has its sides free from definite markings. In the *coniferous* plants, the tubes are furnished with circular discs; these discs are thought to be contrivances to enable the tubules of the woody tissues to discharge their contents from one to the other, or into the cellular spaces. Plants having aromatic secretions are furnished with glands; these form a series of interesting objects, and such as the sage-leaf should be mounted as opaque specimens. A large central gland is seen in a section of a leaf from *Ficus elastica*, India-rubber-tree, fig. 177, No. 2. Professor Quekett observes, "The nature of the pores, or discs, in *conifers*, has long been a subject for controversy; it is now certain that the bordered pores are not peculiar to one fibre, but are formed between two contiguous to each other, and always exist in greatest numbers on those sides of the woody fibres parallel to the medullary rays. They are hollow; their shape biconvex; and in their centre is



Fig. 176.—A section of stem of *Clematis*, with pores, highly magnified, to show the line which passes round them.

cellular spaces. Plants having aromatic secretions are furnished with glands; these form a series of interesting objects, and such as the sage-leaf should be mounted as opaque specimens. A large central gland is seen in a section of a leaf from *Ficus elastica*, India-rubber-tree, fig. 177, No. 2. Professor Quekett observes, "The nature of the pores, or discs, in *conifers*, has long been a subject for controversy; it is now certain that the bordered pores are not peculiar to one fibre, but are formed between two contiguous to each other, and always exist in greatest numbers on those sides of the woody fibres parallel to the medullary rays. They are hollow; their shape biconvex; and in their centre is



a small circular or oval spot, fig. 176: the latter may occur singly, or be crossed by another at right angles,

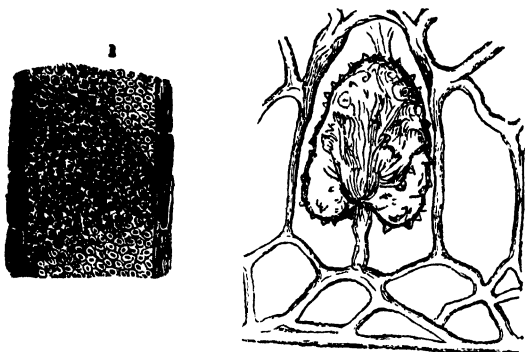

Fig. 177.

1, Vertical section of root of Alder, with outer wall. 2, A vertical section of a leaf of the India-rubber tree, exhibiting a central gland.

which gives the appearance of a cross, as in fig. 204, Nos. 3, 4, a vertical section of fossil wood, remarkable for having three or four rows of woody tissue occupied by large pores without central markings."

We now pass to the *milk*, *lactiferous* ducts or tissue,—

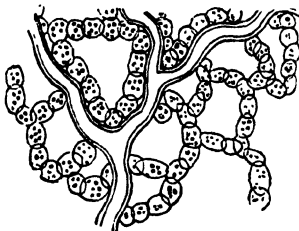

Fig. 178. — *Lactiferous tissue.*

the *proper vessels* of the old writers. These ducts convey a peculiar fluid, sometimes called *latex*, usually turbid, and coloured red, white, or yellow; often, however, colourless. It is supposed they carry latex to all the newly-formed organs, which are nourished by it. The fluid becomes

darker after being mounted for specimens to be viewed under the microscope. This tissue is remarkable from its resemblance to the earliest aggregation of cells, the *yeast-plant*, and therefore has some claim to being considered the *stage* of development preceding that of the reticu-

lated ducts seen in fig. 178. In a section from the India-rubber-tree, fig. 177, No. 2, a network of these lac-tiferous tubes will be found filled with a brownish or

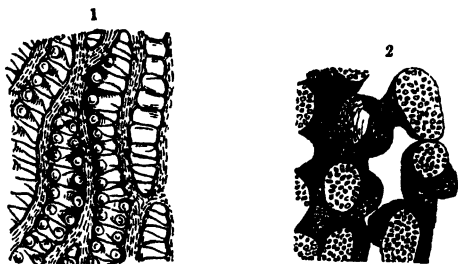

Fig. 179.

1, A portion of the leaf of *Sphagnum*, showing ducts, vascular tissue, and spirae fibre in the interior of its cells. 2, Porous cells, from the testa of Gour seed, communicating with each other, and resembling ducts.

granular matter; that in fig. 178 is an enlarged view of this tissue from the wood of an exogen, taken near the root.

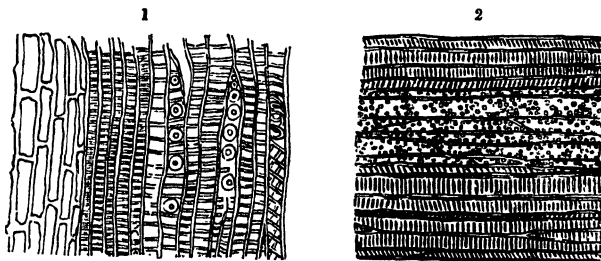

Fig. 180.

1, Reticulated ducts.

2, A vertical section of Fern-root.

In many plants external to the cuticle, there exists a very delicate transparent pellicle, without any decided traces of organisation, though occasionally somewhat granular in appearance, and marked by lines that seem to be impressions of the junction of the cells in contact with each other. In nearly all plants, the cuticle is perforated

by minute openings termed *Stomata*, which are bordered by cells of a peculiar form, distinct from those of the cuticle. In *Iris germanica*, fig. 181, each surface has nearly 12,000

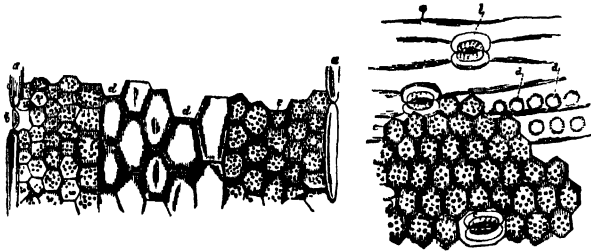

1.

Fig. 181.

2.

4. Portion of a vertical section of the Leaf of the *Iris*: *a, a*, elongated cells of the *epidermis*; *b*, *stomata* cut through longitudinally; *c, c*, cells of the *parenchyma*; *d, d*, colourless tissue of the interior of the leaf. 2. Portion of leaf of *Iris germanica*, torn from its surface; *a*, elongated cells of the cuticle; *b*, cells of the *stomata*, *c*, cells of the *parenchyma*: *d*, impressions on the epidermic cells; *e*, lacunæ in the *parenchyma*.

stomata in every square inch; and in *Yucca* each surface has about 40,000.

The structure of the leaf of the common *Iris* shows a central portion, formed by thick-walled colourless tissue, very different from ordinary leaf-cells or from woody fibre.

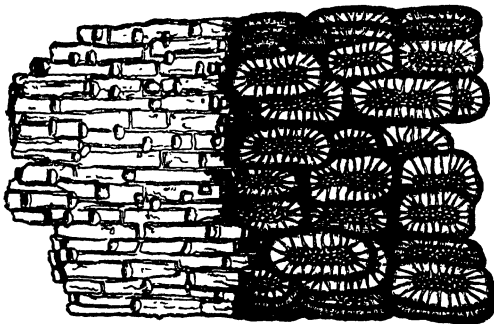

fig. 182.—A portion of the epidermis of the Sugar-cane, showing the two kinds of cells of which it is composed. (Magnified 200 diameters.)

Various-cut sections of leaves should be made, and slices taken parallel to the surfaces at different distances, for the purpose of microscopic examination.

Among the cell-contents of some plants, are beautiful crystals called *Raphides*: the term is derived from *ραφίς*, a needle, from the resemblance of the crystal to a needle. They are composed of the phosphate and oxalate of lime; there is a difference of opinion as to their use in the economy of the plant.

Mr. Gulliver has insisted upon the value of *Raphides* as characteristic points in many families of plants.

He observes that doubts as to the value of raphides as natural characters and as to their importance in the vegetable economy at all will be entertained by those who do not clearly distinguish between raphides and sphaeraphides. Schleiden asserts that the "needle-formed crystals, in bundles of from twenty to thirty in a cell, are present in almost all plants," and "that inorganic crystals are rarely met with in cells in a full state of vitality."

He further states that so really practical is the presence or absence of raphides, that by noticing them he has been able to pick out pots of seedling *Onagraceæ*, which had been accidentally mixed with pots of other seedlings of the same age, and at that period of growth when no botanical character before in use would have been so readily sufficient for the diagnosis.

If we examine a portion of the layers of an onion, fig. 133, No. 1, or a thin section of the stem or root of the garden rhubarb, fig. 183, No. 4, we shall find many cells in which, either bundles of needle-shaped crystals, or masses of a stellate form occur, not strictly raphides.

Raphides were first noticed by Malpighi in *Opuntia*. and subsequently described by Jurine and Raspail. According to the latter observer, the needle-shape or acicular are composed of phosphate, and the stellate of oxalate of lime. There are others having lime as a basis, in combination with tartaric, malic, or citric acid. These are easily destroyed by acetic acid, and are also very soluble in many of the fluids employed in the conservation of objects; some of them are as large as the 1-40th of an inch, others are as small as the 1-1000th. They occur in all

parts of the plant; in the stem, bark, leaves, stipules, petals, fruit, root, and even in the pollen, with some exceptions. They are always situated in the interior of cells, and not, as stated by Raspail and others, in the



Fig 183.

- 1, A section from the outer layer of the bulb of an Onion, showing crystals of carbonate of lime 2, Cells of the Pear, showing Sclerogen, or gritty tissue. 3, Cells of garden Rhubarb, filled with raphides. 4, Cells from same, filled with starch-grains.

intercellular passages.<sup>1</sup> Some of the containing cells become much elongated; but still the cell-wall can be readily traced. In some species of Aloe, as, for instance, *Aloe verrucosa*, with the naked eye we are able to discern small silky filaments: when magnified, they are found to be bundles of the acicular form of raphides, which no doubt act the part of a stay or prop to the internal soft pulp.

In portions of the cuticle of the medicinal squill—*Scilla maritima*—several large cells may be observed, full of bundles of needle-shaped crystal. These cells, however, do not lie in the same plane as the smaller ones belonging to the cuticle. In the cuticle of an onion every cell is occupied either by an octahedral or a prismatic crystal of oxalate of lime: in some specimens the octahedral form predominates; but in others from the same plant the

(1) "As an exception, many years ago they were discovered in the interior of the spiral vessels in the stem of the grape-vine; but with some botanists this would not be considered as an exceptional case, the vessels being regarded as elongated cells."—*Quckett*.

crystals will be principally prismatic, and are arranged as if they were beginning to assume a stellate form. Some plants, as many of the *cactus* tribe, are made up almost entirely of raphides. In some instances every cell of the cuticle contains a stellate mass of crystals; in others the whole interior is full of them, rendering the plant so exceedingly brittle, that the least touch will occasion a fracture; so much so, that some specimens of *Cactus senilis*, said to be a thousand years old, which were sent a few years since to Kew from South America, were obliged to be packed in cotton, with all the care of the most delicate jewelry, to preserve them during transport.

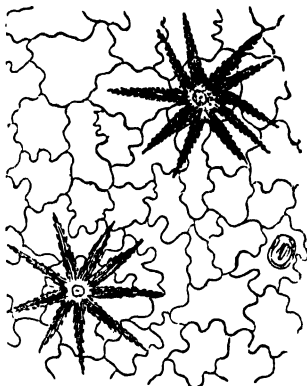

Fig. 184.—Siliceous cuticle from under surface of leaf of *Deutzia scabra*.

Raphides, of peculiar figure, are common in the bark of many trees. In the Hicory (*Carya alba*) may be observed masses of flattened prisms having both extremities pointed. In vertical sections from the stem of *Elæagnus angustifolia*, numerous raphides of large size are embedded in the pith. Raphides are also found in the bark of the apple-tree, and in the testa of the seeds of the elm; every cell contains two or more very minute crystals.

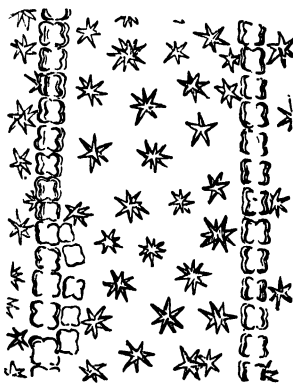

Fig. 185.—Siliceous cuticle of Grass (*Pharus cristatus*).

In figs. 184 and 185 we have other representations of the crystalline structure

of plants, in sections taken from grass, and the leaf of *Deutzia scabra*. This insoluble material is called silica, and is abundantly distributed throughout certain orders of plants, leaving a skeleton after the soft vegetable matters have been destroyed: masses of it, having the appearance of irregularly-formed blackened glass, will always be found after the burning of hay or straw; which is caused by the fusion of the silica contained in the cuticle combining with the potash in the vegetable tissue, thus forming a silicate of potash (glass). To display this siliceous structure, it is necessary to cut very thin slices from the cuticle, and mount them in fluid or Canada balsam.

In the *Grammaceæ*, especially the canes; in the *Equisetum hyemale*, or Dutch rush; in the husk of the rice, wheat, and other grains,—

silica is abundantly found. In the *Pharus cristatus*, an exotic grass, fig. 185, we have beautifully-arranged masses of silica with raphides. The leaves of *Deutzia*, fig. 184 are remarkable for their stellate hairs developed from the cuticle, of both their upper and under surfaces; forming most interesting and attractive objects when examined under the microscope with polarised light. See Plate VIII. No. 173.

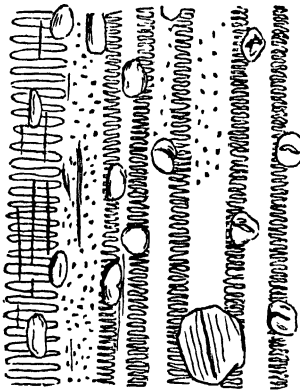

Fig. 186.—Portion of the husk of Wheat, showing siliceous crystals.

Silica is found in all *Rubiaceæ*; both in the stem

and leaves, and if present in sufficient thickness, depolarises light. This is especially the case in the prickles, which all these plants have on the margin of the leaves and the angles of the stem. One of the order *Compositæ*, a plant popularly known as the "sneezewort," (*Archillæ ptarmica*) has a large amount of silica in the hairs found on the double serratures of its leaves; commonly said to be the

cause of its errhine properties when powdered and used as snuff. It is in the underlying or true epidermis, that the silica occurs. This membrane is permeable by fluids, not by means of pores, but by endosmotic force.

The most generally-distributed and conspicuous of the cell-contents is *Starch*; at the same time it is one of great value and interest, performing a similar office in the economy of plants as that of fat in animals. It occurs in all plants at some period of their existence, and is the chief and great mark of distinction between the vegetable and animal kingdoms. Its presence is detected by testing with a solution of iodine, which changes it to a characteristic blue or violet colour.<sup>1</sup> Being insoluble in cold water, it can be readily washed away and separated from other matters contained

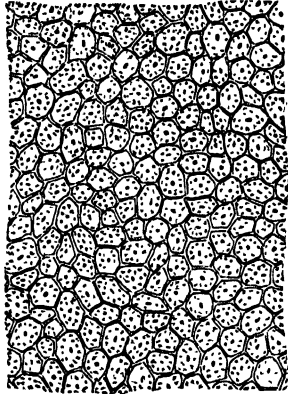

Fig. 187.—Section of a *Cane*; with cell-walls of silica, and internal pores filled with granular matter.

in the cellular parts of full-grown plants. It is often found in small granular masses in the interior of cells, shown in fig. 183 from the garden-rhubarb. Starch-grains are variable in size: the *tous-les-mois*, fig. 188, No. 5, are very large; in the *potato*, No. 14, they are smaller; and in *rice*, No. 6, they are very small indeed. Nearly all present the appearance of concentric irregular circles; and most of the granules have a circular spot, termed the *hilum*, around which a large number of curved lines arrange themselves: better seen under polarised light. Plate VIII. No. 167.

Leeuwenhök, to whom we are indebted for the earliest notice of starch-granules, enters with considerable minuteness into a description of those of several plants—such as wheat, barley, rye, oats, peas, beans, kidney-beans, buckwheat, maize, and rice; and very carefully describes experiments made by him in order to investigate the structure of starch-granules. Dr. Reissek regards the

(1) This is not a test for starch when combined with albuminous matters.



granule as a perfect cell, from the phenomena presented during its decay or dissolution, when left for some time in water. Schleiden and others, after examining its expansion and alteration under the influence of heat and of sulphuric acid, considered it to be a solid homogeneous structure.

Professor Busk agrees with M. Martin in believing the primary form of the starch-granule to be "a spherical or ovate vesicle, the appearance of which under the microscope, when submitted to the action of strong sulphuric acid, conveys the idea of an unfolding of plaits or rugæ, which have, as it were, been tucked in towards the centre of the starch-grain."<sup>1</sup> The mode of applying the concentrated sulphuric acid is thus described by Mr. Busk:—"A small quantity of the starch to be examined is placed upon a slip of glass, and covered with five or six drops of water, in which it is well stirred about; then with the point of a slender glass-rod the smallest possible quantity of solution of iodine is applied, which requires to be quickly and well mixed with the starch and water; as much of the latter as will must be allowed to drain off, leaving the moistened starch behind, or a portion of it may be removed by an inclination of the glass, before it is covered with a piece of thin glass. The object must be placed on the field of the microscope, and the  $\frac{1}{4}$ -inch object-glass brought to a focus close to the upper edge of the thin glass. With a slender glass-rod a small drop of *strong* sulphuric acid must be carefully placed immediately upon, or rather above the edge of the cover, great care being necessary to prevent its running over. The acid quickly insinuates itself between the glasses, and its course may be traced by the rapid change in the appearance of the starch-granules as it comes in contact with them. The course of the acid is to be followed by moving the object gently upwards; and when, from its diffusion, the re-agent begins to act slowly, the peculiar changes in the starch-granules can be more readily witnessed. In pressing or moving the glasses, the starch disc becomes torn, and is then distinctly seen, especially in those coloured blue, to

(1) Professor G. Busk, F.R.S., on the Structure of the Starch-granule; *Quarterly Journal of Microscopical Science*, April, 1853.

consist of two layers, an upper and a lower one; and the collapsed vesicular bodies of an extremely fine but strong and elastic membrane." Mr. Busk believes the hilum to be a central opening into the interior of the ovate vesicle.

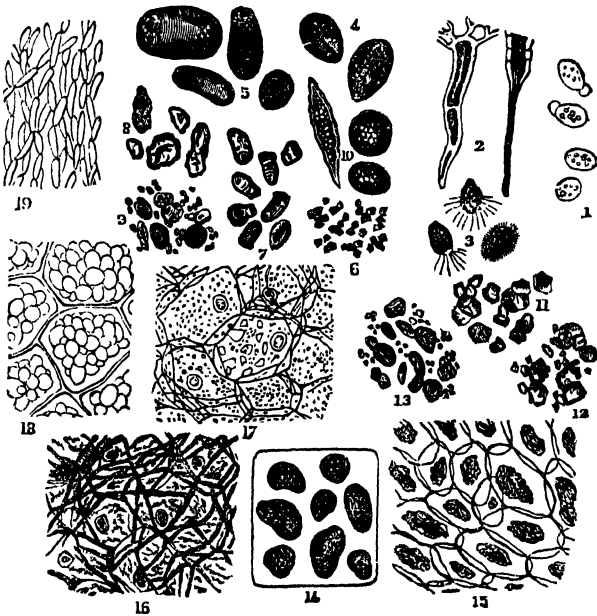

Fig. 188.

1, Nucleated Cells. 2, Stinging-nettle Hairs, *Urtica Dioica*. 3, Ciliated spores of *Conferva*. 4, Starch grains, broken by the application of heat. 5, Starch from *Tous-les-mois*. 6, Starch from Rice. 7, Starch from Sago. 8, Isolation Sago-starch. 9, Wheat-starch. 10, Rhubarb-starch, in isolated cells. 11, Maize-starch. 12, Oat-starch. 13, Barley-starch. 14, Potato-starch. 15, Section of Strawberry, cells ovoid, containing granular matter. 16, Section of Potato, with starch destroyed by fungoid disease. 17, Potato, with nearly all starch-grains absent. 18, Section of Potato, cells filled with healthy starch (These starches are grouped for comparison.) 19, Mushroom spawm, elongated cells.

Nitric acid communicates to wheat-starch a fine orange-yellow colour; and recently-prepared tincture of guaiacum gives a blue colour to the starch of good wheat-flour.

Pure wheat-flour is almost entirely dissolved in a strong solution of potash, containing twelve per cent. of the alkali; but mineral substances used for the purpose of adulteration remain undissolved.

Wheat-flour is frequently adulterated with various substances; and in the detection of these adulterations, the microscope, together with a slight knowledge of the action of chemical re-agents, lends important assistance. It enables us to judge of the size, shape, and markings on the starch grains, and thereby to distinguish the granules of



Fig 126.—Wheat-Flour Starch-granules, with a small portion of its cellulose. (Magnified 420 diameters.)

one meal from that of another. In some cases the microscopic examination is aided by an application of a solution of potash. Thus we may readily detect the mixture of wheat-flour with either potato-starch, meal of the pea or bean, by the addition of a little water to a small quantity of the flour, then, by adding a few drops of a solution of potash (made of the strength one part *liquid potash* to three parts of water), the granules of the potato-

**starch** will immediately swell up, and acquire three or four times their natural size ; while those of the wheat-starch are scarcely affected by it ; if adulterated with pea or bean meal, the hexagonal tissue of the seed is at the same time rendered very obvious under the microscope. Polarised light will be of use as an additional aid ; wheat-starch presents a faint black cross proceeding from the central hilum, whereas the starch of the oat shows nothing of the kind.



Fig. 190 — *Potato Starch-granules, sold under the name of British Arrow-root, used to adulterate flour and bread. (Magnified 240 diameters.)*

The diseases of wheat and corn are readily detected under the microscope ; some of which will be seen to be produced by a parasitic fungus, and by an animalcule represented in another place : all are more or less dangerous when mixed with articles of food.

*Adulteration of bread with boiled and mashed potatoes,* next to that by alum, is, perhaps, the one which is most commonly resorted to. The great objection to the use of potatoes in bread, is, that they are made to take the place

of an article very much more nutritious. This adulteration can be instantly detected by means of the microscope. The cells which contain the starch-corpuscles are, in the potato, very large, fig. 190; in the raw potato they are adherent to each other, and form a reticulated structure, in the meshes of which the well-defined starch-granules are clearly seen; in the boiled potato, however, the cells separate readily from each other, each forming a distinct article: the starch-corpuscles are less distinct and of an altered form.

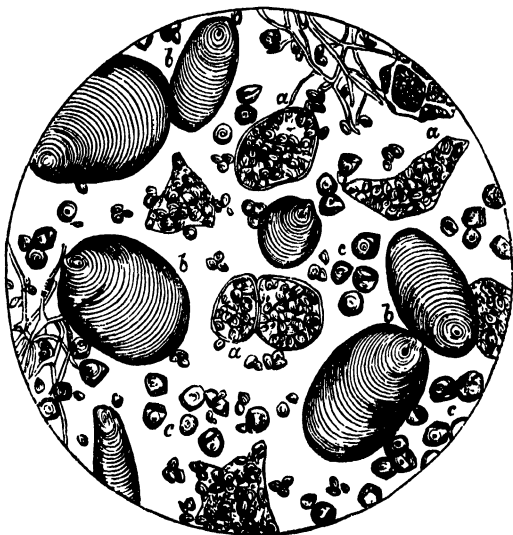

Fig. 191.—Adulterated Cocoa, sold under the name of Homœopathic Cocoa.  
(After Hassall.)

*a a a*, granules and cells of cocoa; *b b b*, granules of Canna-starch, or *Telus iso-mois*; *c*, granules of Tapioca-starch.

*Adulteration with alum and "stuff."*—This adulteration is practised with a twofold object: first to render flour of a bad colour and inferior quality white and equal, in appearance only, to flour of superior quality; and secondly to enable the flour to retain a larger proportion of water,

by which the loaf is made to weigh heavier. By dissolving out the alum in water and then re-crystallising it under the microscope, this adulteration is readily detected.

Before leaving the subject of starch, allusion may be made to the prevalent and destructive epidemic amongst potatoes, which is a disease of the tuber, not of the haulm or leaves. "Examined in an early stage, such potatoes are found to be composed of cells of the usual size; but they contain little or no starch: this will be seen upon reference to Nos. 16 and 17, fig. 188. Hence it may be



Fig. 192.—Structure and Character of genuine Ground Coffee. (After Hassall.)

inferred, that the natural nutriment of the plant being deficient, the haulm dies, the cells of the tuber soon turn black and decompose; and fungi developed as in most other decaying vegetable substances.

"This will undoubtedly explain the most prominent symptom of the potato-disease, the tendency to decomposition; and is a point in which the microscope confirms the result of chemical experiment: for it has been found

that the diseased potatoes contain a larger proportion of water than those that are healthy. A want of organizing power is evidently the cause of this deficiency of starch; but we fear the microscope will never tell us in what the want of this organising force consists." <sup>1</sup>

The adulteration of articles of food and drink has long been a matter of uneasy interest, and of strong, though vague, misgiving. Accum's *Death in the Pot*, between thirty and forty years ago, awoke attention to the subject; which has since been more or less accurately explored by



Fig. 193.—Sample of Coffee, adulterated with both Chicory and Roasted Wheat. (After Hassall.)

s s s, small fragments of coffee; b b b, portions of chicory; c c c starch-granules of wheat.

Mitchell, Normandy, Chevalier, Jules Garnier, and Harel; and has at length derived a singularly lucid exposition from Dr. Hassall's researches, whose report of these inquiries fills between 600 and 700 closely printed pages

(1) Professor Quekett's *Histology of Vegetables*. We would refer the reader to a curious work on *Fungi*, by Arimini, an Italian botanist. 1759.

of a large octavo, replete with details of the fraudulent contaminations commonly practised by the people's purveyors, at the people's expense of health and pocket.<sup>1</sup>

"In nearly all articles," said Dr. Hassall, before a committee appointed by the House of Commons to inquire into these adulterations, "whether food, drink, or drugs, my opinion is that adulteration prevails. And many of the substances employed in the adulterating process were not only injurious to health, but even poisonous." The microscope was the effective instrument in the work of



Fig. 104.—Tea adulterated with foreign leaves. (After Hassall.)

*a*, upper surface of leaf; *b*, lower surface, showing cells; *c*, chlorophyll cells; *d*, elongated cells found on the upper surface of the leaf in the course of the veins; *e*, spiral vessel; *f*, cell of turmeric; *g*, fragment of Prussian blue; *h* particles of white powder, probably China clay.

detection. Less than five years ago, it would, we are told, have been impossible to detect the presence of chicory in coffee: in fact, the opinion of three distinguished chemists was actually quoted in the House of Commons to that effect;

(1) *Food and its Adulterations*; comprising the Reports of the Analytical Sanitary Commission of the *Lancet*, for the years 1851 to 1854 inclusive. By Arthur Hill Hassall, M.D.



whereas by the use of the microscope the differences of structure in these two substances, as in many other cases, can be promptly discerned. Out of thirty-four samples of coffee purchased, chicory was discovered in thirty-one; chicory itself being also adulterated with all manner of compounds. There is no falling back either upon tea or chocolate; for these seem rather worse used than coffee. Tea is adulterated, not only here, but still more in China; while as to chocolate, the processes employed in corrupting the manufacture are described as "diabolical." "It is

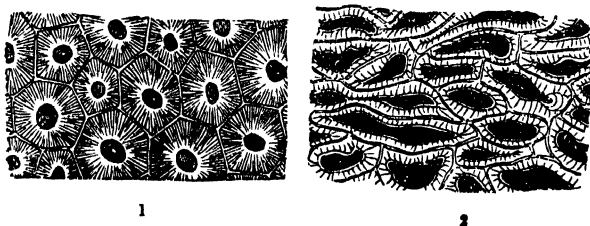

Fig. 195.

1, Radiating cells from the outer shell of the Ivory Nut. 2, Section of a Nut, showing cells with small radiating pores.

often mixed with brick-dust to the amount of ten per cent., ochre twelve per cent., and peroxide of iron twenty-two per cent., and animal fats of the worst description. In this country, cocoa is sold under the names of flake, rock, granulated, soluble, dietetic, homœopathic cocoa, &c., fig. 191. Such names are evidently employed to disguise the fact that they are compounded of sugar, starch, and other substances.

To return to the subject more immediately before us—

Some of the plants belonging to the Orchideæ—*Comelineæ*—particularly *Tradescantia virginica* (Spiderwort), portions of the epidermis, and the jointed hairs of the filament, form interesting microscopic objects. The surface of the latter is marked with extremely fine longitudinal parallel equidistant lines or striæ, whose intervals are equal, from about  $\frac{1}{15000}$  to  $\frac{1}{20000}$  of an inch. It might therefore in some cases be used as a micrometer or test object. The nucleus of the joint or cell is very distinct as well as regular in form; and by gentle pressure

is easily separated entire from the joint. It then appears to be exactly round, nearly lenticular, and its granular matter is either held together by a coagulated pulp not visibly granular, or, which may be considered equally probable, by an enveloping membrane. The analogy of this nucleus to that existing in the various stages of development of the cells in which the grains of pollen are formed in the same species, is sufficiently obvious.

In the joint of the same, when immersed in water, being at the same time freed from air, and consequently made more transparent, a circulation of very minute granular matter is visible. This requires at least a  $\frac{1}{4}$  power to show it well. The motion of the granular fluid is seldom in one uniform circle, but in several apparently independent currents: and these again, though often exactly longitudinal, and consequently in the direction of the striæ of the membrane, are not unfrequently observed forming various angles with these striæ. The smallest of the currents appear to consist of a single series of granules. The course of these currents seems often in some degree affected by the nucleus, towards or from which many of them occasionally tend or appear to proceed. They can hardly, however, be said to be impeded by the nucleus, for they are occasionally observed passing between its surface and that of the cell; a proof that this body does not adhere to both sides of the cavity, and also that the number and various directions of the currents cannot be owing to partial obstructions arising from the unequal compression of the cell.

*Flower-buds.*—“In the very early stage of the flower-bud, while the anthera are yet colourless, their loculi are filled with minute lenticular grains, having a transparent flat limb, with a slightly convex and minutely granular semi-opaque disc. This disc is the nucleus of the cell, which probably loses its membrane or limb, and, gradually enlarging, forms in the next stage a grain also lenticular, and which is marked either with only one transparent line dividing it into two equal parts, or with two lines crossing at right angles, and dividing it into four equal parts. In each of the quadratures a small nucleus is visible; and, even where one transparent line is only dis-

tinguishable, two nuclei may frequently be found in each semicircular division. These nuclei may be readily extracted from the containing grain by pressure, and after separation retain their original form. In the next stage, the greater number of grains consist of the semicircular divisions, naturally separated, but now containing only one nucleus, which has gradually increased in size. In the succeeding stage the grain apparently consists of the nucleus of the former stage, but considerably enlarged, and having an oval form, and a somewhat granular surface. This oval grain, continuing to increase in size, and in the thickening of its membrane, acquires a pale yellow colour; and is now the perfect grain pollen."

In the whole tribe of Orchideæ an abundance of raphides may be found in almost every part of the cellular tissue. The crystals are usually cylindrical in form, and so arranged as to disguise their true character, often causing them to be overlooked: by making use of a dark-ground illuminator, or polarised light, this is not likely to occur. The cause of the disease known as "spot" in Orchids, of which several kinds have been noticed by cultivators, has been traced by Mr. Berkeley, in one instance, to the occurrence of a minute parasitic fungus, belonging to the genus *Leptothyrium*. A description of the disease, with illustrations, giving the general appearance of the diseased leaves, and a magnified figure of the parasite, appears in the 1st part of the new series of the *Journal of the Horticultural Society*.

*The Colouring matter of Flowers.*—M. F. Hildebrands, having carefully investigated the colouring matters of flowers, has arrived at the following conclusion respecting them, and their distribution in the tissue of the several organs.

1. That the colour of flowers is in constant connexion with the cell contents, never with the walls of cells.

2. Blue, violet, rose, and (if there be no yellow in the flower) *deep red* are due, with little exception, to a cell-fluid of corresponding colour.

3. Yellow, orange, and green, are usually associated with solid, granular, or vesicular substances in the cells.

4. Brown or gray, and in many cases bright red and orange (apparently uniform to the naked eye), are found to be compounded of other colours, as *yellow, green, or orange with violet, or green and red*; bright red and orange in like manner of blue-red with yellow or orange.

5. Black, excepting in the bean, is due to a very deeply-coloured cell-fluid.

6. All the cells of an organ are rarely uniformly coloured.

7. The colour usually resides in one or in a few of the outer layers of cells.

8. The coloured cells are but exceptionally covered by a layer of uncoloured ones.

9. Combinations of colour are occasioned by diversely-coloured matters in the same or in adjacent cells.

The Woody tissue of plants is not without its interest, it consists of elongated transparent tubes of considerable strength: some are almost entirely made up of this tissue. It is by far the most useful, and supplies material for our linen, cordage, paper, and many other important articles in every branch of art. This tissue, remarkable for its toughness, is termed *fibre*, the outer membrane of which is usually structureless.

In *Flax* and *Hemp*, in which the fibres are of great length, there are traces of transverse markings, and tubercles at short intervals. In the rough condition, in which it is imported into this country, the fibres have been separated, to a certain extent, by a process termed *hackling*. It is once more subjected to a repetition of hackling, maceration, and bleaching, before it can be reduced to the

white silky condition required by the spinner and weaver, when it has the appearance of structureless tubes, fig. 197 B. *China-grass*, New Zealand flax, and some other plants, produce a similar material, but are not so strong, in conse-



Fig. 196.

A, Fibres of Silk. B, Fibres of Cotton.

quence of the outer membrane containing more *lignine*. It is important to the manufacturer that he should be able to determine the true character of some of the textures of articles of clothing, and this he may readily do with the microscope. In linen we find each component thread made up of the longitudinal, rounded, unmarked fibres of flax; but if cotton has been mixed, we recognise a flattened, more or less twisted band, as in fig. 196 *b*, having a very striking



Fig. 197.

A, Wool of Sheep. B, Filaments of Flax.

resemblance to hair, which, in reality, it is; since, in the condition of elongated cells, it lines the inner surface of the pod. These, again, should be contrasted with the filaments of *silk*, fig. 196 *A*, and also of *wool*, fig. 197 *A*. The latter may be at once recognised by the zigzag transverse markings on its fibres. The surface of wool is covered with these furrowed and twisted fine cross lines, of which there are from 2,000 to 4,000 in an inch. On this structure depends its *felting* property. In judging of fleeces, attention should be paid to the fineness and elasti-

city of the fibre,—the furrowed and scaly surface, as shown by the microscope,—the quantity of fibre in a given surface, the purity of the fleece, upon which depend the success of the scouring and subsequent operations.

In the mummy-cloths of the Egyptians, flax only was used, whereas the Peruvians used cotton alone. By recent improvements introduced into the manufacturing processes, flax has been reduced to the fineness and texture of silk, and made to resemble other materials.

Silk is secreted from a pair of long tubes ending in a pore of the under-lip of the silkworm. Each thread is made of two filaments coming from these, and they are glued together by a secretion from a small gland near. The quality of the silk depends on the character and difference of the two secretions.

All woody fibre is made up of elongated cells, generally

more or less pointed at both extremities, and having their walls strengthened by internal deposits. Occasionally, however, the fibre is short, as in the Clematis, Elder, &c.; it is marked with pores or dots, from a deficiency of the internal deposits at these points.

*Vascular tissue* consists of cells, more or less elongated, joined end to end, or overlapping each other, in which either a spiral fibre, or a modification of the same, has been deposited; hence, if the spiral be perfect, it is called a *true spiral vessel*; if interrupted, or the fibre breaks up into rings, it is termed *annular*: if the rings are connected together by branching fibres, so that a network is produced, the vessel is called *reticulated*; if the vertical fibres are short, and equidistant, the vessel is said to be

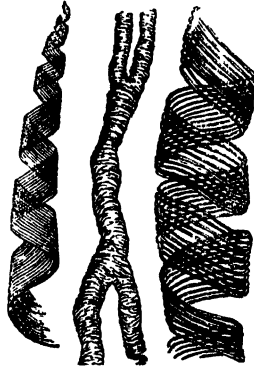

Fig. 198.—Simple and compound spiral vessels.

*scalariform*, from its resemblance to a ladder. Spiral vessels have been also termed *tracheæ*, from their resemblance to the air-tubes of insects, as in fig. 198.

Under this head other membranaceous tubes are included, in which the arrangement of the fibre has been considerably modified in its deposition. Elongated tubes or ducts, with porous walls, come under the head of vascular tissue; they somewhat differ from the spiral varieties, inasmuch as they cannot be unrolled without breaking. It is a curious fact, that mostly the spiral coils from right to left; and it has been suggested that the direction of the fibre may determine that in which the plant coils round an upright pole. The Hop has *left-handed spirals*, and is a left-handed climber, which would therefore appear to support this theory. The nature of the fibre, and the development of the tissue, have been frequently the subject of dispute between botanists.

The late Mr. Edwin Quekett gave much attention to this

subject; and published an excellent paper in the *Microscopical Society's Transactions*, 1840; the results of his observations on the development of vascular tissue.

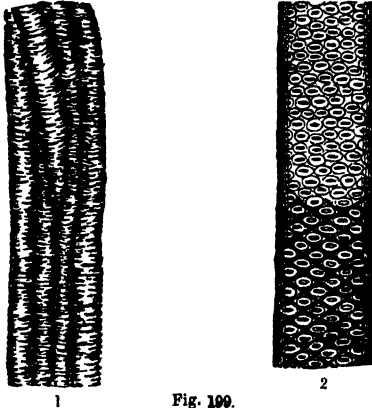

Fig. 190.

1, Interior cast of the siliceous portion of spiral tubes of the *Opuntia*. 2, Vertical section of Elm, showing spiral fibre.

In order to watch the development of the membranous tubes of plants, no better example can be chosen than the

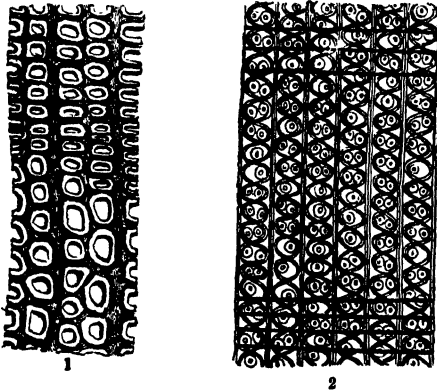

Fig. 200.

1, A transverse section of *Taxus baccata* (Yew), showing the woody fibre.  
2, Vertical section of the Yew, exhibiting pores and spiral fibres.

young flower-stalk of the long-leek (*Allium porrum*), in the state in which this vegetable is usually sent to market; it is then most frequently found to be about an inch or

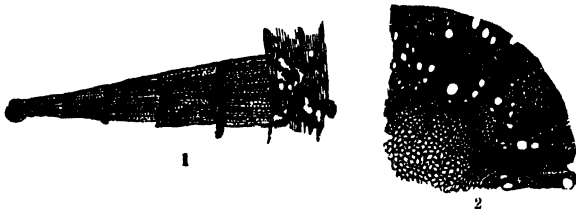

Fig. 201.

- 1, Portion of transverse section of stem of Cedar, showing pith, wood, and bark.
- 2, Portion of transverse section of stem of Clematis, showing medullary rays.

more in length, and from a quarter to half an inch in diameter. This membrane occurs very low down amidst the sheathing bases of the leaves; and from having to lengthen to two or three feet, and containing large vessels, it forms a very fit subject for ascertaining the early appearances of the vascular tissue.

To examine the development of vessels, it is necessary to be very careful in making dissections of the recent plant; and it will be found useful to macerate the specimen for a time in boiling water, which will render the tissues more easily separable. When the examination is directed in search of the larger vessels, it will be found that at this early stage they present merely the form of very elongated cells, arranged in distinct lines; amongst which some vessels, especially the annular, will be found matured even before the cytoblasts have disappeared from the cells of the surrounding tissue.

As development proceeds, the vessels rapidly increase in length, till they arrive at perfection. No increase in diameter is perceptible after their first formation. At this period, in the living plant the young vessels appear full of fluid, which is apparently, as remarked by Schleiden, of a thick character, and which he has designated vegetable jelly; by boiling which, or by the addition of alcohol, the contents, or at least the albuminous portion, become coagulated. From this circumstance, every cell appears



to enclose another in a shrivelled condition; this state is sometimes so far extended, that a thick granular cord is all that can be seen of the contents.

The period of growth at which the laying down of fibre commences, determines the distance between the several coils; for instance, when it is first formed, the coils are quite close, scarcely any perceptible trace of membrane existing between them. In the annular vessel, the development of the cell and the adherence of the granules to each other are conducted in the same manner; the deposit showing a tendency towards the spiral direction, by the presence of a spire connecting two rings, or by a ring being developed in the middle of a spiral fibre. The annular vessel is the first observed in the youngest parts of plants, and when found alone indicates a low degree of organisation; as shown by its occurrence in *Sphagnum*, *Equisetum*, and *Lycopodium*, which plants, in the ascending scale of vegetation, are almost the first that possess vascular tissue.

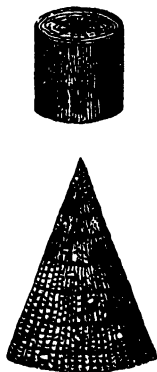

Fig. 302.—A section from the stem of a coniferous plant, with a transverse cutting magnified, to show the zones of annual growth, annual rings.

It will be found that spiral fibre occurring with rings marks a higher step in the scale of organising power; the true spiral more so; and the reticulated and dotted mark the highest; this being the order in which these several vessels are placed in herbaceous exogens proceeding from within outwards, the differences of structure of the several vessels being indices of the vital energy of the plant at the several periods of its development. In those vessels in which the annular or spiral character of the fibre is departed from, some curious modifications of the above process are to be observed, as in the reticulated vessels met with in the common balsam (*Balsamina hortensis*). The primary formation of fibre in these vessels is marked by the tendency of the granules to take a spiral course, when it happens that some one of the granules becomes

enlarged by the deposition of new matter around it. This becomes a point originating another fibre or branch, which becomes developed by the successive attraction of granules into bead-like strings, taking a contrary direction to the original fibre, forming a cross-bar, or ramifying, thereby causing the appearance by which the vessel is recognised.

In the exogenic vessel, the development of fibre proceeds in the same manner as in the last example; but the vessels will be seen to be dotted with a central mark, usually of a red colour, which, when viewed under high power, may be thought to resemble a minute garnet set in the centre of each dot. This red colour is owing to the dot being somewhat hollowed or cupped, and the centre only thin membrane. These vessels are best seen in the young shoots of the Willow. In the endogenic vessel the connecting branches are given off beneath each other, so that the dots, which are rounded, are arranged in longitudinal rows; but in the acrogenic, or scalariform, in which the vessels are generally angular, and present distinct facets, the branches come off in the same line, corresponding generally to the angles of the vessel; the spaces left between are linear instead of round.

Mr. E. Quekett affirms, in opposition to the views entertained by Mirbel, Richard, and Bischoff, "that the dots left in these several vessels are not holes, neither do they consist of broken-up fibre, but are the membranous tubes, unsupported by internal deposit; and on account of the extreme tenuity of the tissue, and the minute space between the fibres, the light in its transmission becomes decomposed, and appears of a greenish-red hue. The structure of the dot is best seen by examining the broken edge of any such vessels, when it will be found that the fracture has been caused by the vessel giving way from one dot to another, so that the torn edge of the membrane can be observed in each dot."

#### PREPARATION OF VEGETABLE TISSUES.

The proper mode of preparing and preserving vegetable tissues is a matter of some importance to the microscopist; we therefore propose to add a few general directions for the student's guidance.

Vegetable tissues are best prepared for the microscope by making thin sections, either by maceration, by tearing between the thumb and the blade of a knife, or by dissection.

The spiral and other vessels of plants require to be dissected out under a simple magnifying-glass. Take, for instance, a piece of asparagus, and separate with the needle-points the vessels, which require to be finished under a magnifying-glass, in a single drop of distilled water. When properly done, keep in spirits of wine and water until mounted.

Vascular tissue requires both maceration and dissection for its separation. The cuticle or external covering of plants is an interesting structure; but the beauty of all vegetable tissues is greatly enhanced by staining as directed in a previous chapter.

Cellular tissue may be studied in fine sections from the pith of elder, pulp of peach, pear, &c. The petals of flowers are mostly composed of cellular tissue; their brilliant colouring arises from the action of light upon the fluid contents of the cells. In the petal of the *anagallis*, or scarlet chickweed, the spiral vessels diverging from the base, and the singular cellules which fringe the edge, are interesting objects; the petal of the geranium being one of the most beautiful for microscopic examination. The usual way of preparing it is by immersing the leaf in sulphuric ether for a few seconds, allowing the fluid to evaporate, and then mounting it dry. Dr. Inman of Liverpool suggests the following method: "First peel off the epidermis from the petal, which may be done by making an incision through it at the end of the leaf, and then tear it forwards by the forceps. This is then arranged on a slip of glass, and allowed to dry; when dry, it adheres to the glass. Place on it a little Canada balsam diluted with turpentine, and boil it for an instant over the spirit-lamp; this blisters it but does not remove the colour; then cover it with a thin slip of glass, to preserve it. Many cells will be found showing the mamilla very distinctly, and the hairs surrounding its base, each being slightly curved and pointed towards the apex of the mamilla. It is these hairs and the mamilla which give the velvety appearance to the petal."

Fibro-cellular tissue is found readily in *Sphagnum* or

bog-moss, and in the elegant creeper *Cobæa scandens*. In some orchidaceous plants the leaves are almost entirely composed of it. A modification of this form of tissue is found in the testa of some seeds, as in those of *Salvia*, *Collomia grandiflora*, &c.

The curious and interesting sporules of ferns, when ripe, burst, and are dispersed to a distance; so that they should be gathered before they come to maturity, and mounted as opaque objects. The development of ferns may be observed by placing the seeds in moistened flannel, and keeping them at a warm temperature. At first a single cellule is produced, then a second; after this the first divides into two, and then others follow; by which a lateral increase takes place.

The pollen-grains of most flowers are very interesting objects; the darker kinds show best when mounted in dark cells, and viewed as opaque objects; the more trans-

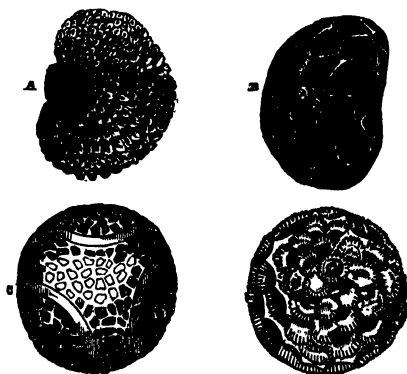

Fig. 203.—Pollen grains and seeds.

a, Seed of Clove-pink. b, Poppy seed. c, Pollen of Passion flower (*Passiflora carulea*). d, Pollen of *Cobæa scandens*.

parent should be mounted in fluid, to show internal structure. The prettiest and most delicate forms are found in *Amarantaceæ*, *Cucurbitaceæ*, *Malvaceæ*, and *Passifloreæ*; others are furnished from the *Convolvulus*, *Geranium*, *Campanula*, *Hollyhock*, and some other plants. Remarkable forms of pollen-grains are shown in fig. 203.

Many of the smaller kinds of seeds will reward the microscopist; use only a low power; that of *Caryophyllum* (clove-pink), is regularly covered with curiously-jagged divisions; every one of which has a small bright, black hemispherical knob in its middle, represented in fig. 160, A.

The seeds of the carrot are remarkably formed, having some resemblance to a star-fish, with its long radiating processes. The seeds of *umbelliferous* plants have peculiar receptacles for essential oil, in their coats, termed *vittæ*; various points of interest may be noted as occurring in the *testæ*, envelopes of seeds, such as the fibre-cells of *Cobæa*, and the stellate cells of the *Star-anise*.

All plants are provided with hairs; and a few, like insects, with hairs of a defensive character. Those in the *Urtica dioica*, commonly called the *Stinging-nettle*, are elongated hairs, developed from the cuticle, usually of a conical figure, and containing an irritating fluid; in some of them a circulation is visible: when examined under the microscope, with a power of 100 diameters, they present the appearance seen at fig. 188, No. 2. At No. 3, same figure, are represented a few interesting ciliated spores from *Confervæ*.

The circulation of the fluid-contents of vegetable cells may be examined at the same time with the Chlorophyll globules, by selecting for the purpose the transparent water-plants *Chara*, *Nitella*, *Anacharis*, and *Vallisneria*, or the hairs of *Groundsel* and *Tradescantia*. The circulation of the sap in plants growing in water is termed by botanists *Cyclosis*.

*Fossil plants*.—We detect in some of the primordial fossils a noticeable likeness to families familiar to the modern algæologist. The cord-like plant, *Chorda filium*, known as 'dead men's ropes,' from its proving fatal at times to the too adventurous swimmer who gets entangled in its thick wreaths, had a Lower Silurian representative, known to the palæontologist as the *Palæochorda*, or ancient chorda, which existed, apparently, in two species,—a larger and a smaller. The still better known *Chondrus crispus*, the Irish moss, or Carrageen moss, has, likewise,

its apparent, though more distant representative, in *Chondritis*, a Lower Silurian alga, of which there seems to exist at least three species. The fucoids, or kelp-weeds, appear to have also their representatives in such plants as *Fucoides gracilis*, of the Lower Silurians of the Malverns; in short, the *Thallogens* of the first ages of vegetable life, seem to have resembled, in the group, and in at least their more prominent features, the *Algæ* of the existing time. And with the first indications of land we pass direct from the *Thallogens* to the *Acrogens*,—from the sea-weeds to the fern-allies. The *Lycopodiaceæ*, or club-mosses, bear in the axils of their leaves minute circular cases, which form the receptacles of their spore-like seeds. And when, high in the Upper Silurian system, and just when preparing to quit it for the Lower Old Red Sandstone, we detect our earliest terrestrial organisms, we find that they are composed exclusively of those little spore-receptacles.

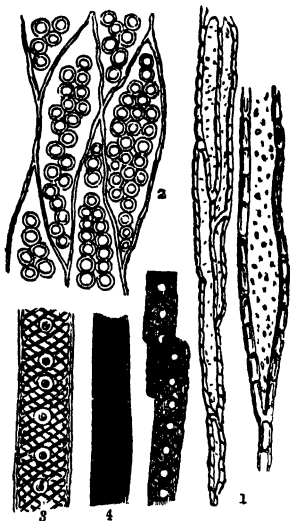

Fig. 204.

1, Woody fibre from the root of the Elder, exhibiting small pores. 2, Woody fibre of fossil wood, showing large pores. 3, Woody fibre of fossil wood, bordered with pores and spirals. 4, Fossil wood taken from coal.

“The existing plants whence we derive our analogies in dealing with the vegetation of this early period, contribute but little, if at all, to the support of animal life. The ferns and their allies remain untouched by the grazing animals. Our native club-mosses, though once used in medicine, are positively deleterious; horsetails (*Equisetaceæ*), though harmless, so abound in silex, which wrap them round with a cuticle of stone, that they are rarely cropped by cattle; while the thickets of fern which cover our hill and dell, and seem so temptingly rich and green

in their season, scarce support the existence of a single creature, and remain untouched, in stem and leaf, from their first appearance in spring, until they droop and wither under the frosts of early winter.

“It is not until we enter into the earlier Tertiaries that we succeed in detecting a true dicotyledonous tree; on such an amount of observation is this order determined, that when Dr. John Wilson, the Parsee Missionary, submitted to me specimens of fossil woods which he had picked up in the Egyptian Desert, in order that, if possible, I might determine their age, I told him that if they exhibited the coniferous structure, they might belong to any geologic period from the times of the Lower Old Red Sandstone downwards; but if they manifested in their tissue the dicotyledonous character, they could not be older than the times of the Tertiary. On submitting them in thin slices to the microscope, they were found to exhibit the peculiar dicotyledonous structure as strongly as the oak or chestnut. And Lieutenant Newbold’s researches in the deposit in which they occur has since demonstrated, on stratigraphical evidence, that it belongs to the comparatively modern formations of the Tertiary.

“The flora of the coal measures was the richest and most luxuriant, in at least individual productions, with which the fossil botanist has formed any acquaintance. Never before or since did our planet bear so rank a vegetation as that of which the numerous coal seams and inflammable shales of the carboniferous period form but a portion of the remains,—the portion spared, in the first instance, by dissipation and decay, and in the second by the denuding agencies. Almost all our coal,—the stored-up fuel of a world,—forms but a comparatively small part of the produce of this wonderful flora. Yet, with all this singularly profuse vegetation of the coal measures, it was a flora unfitted, apparently, for the support of either graminiverous bird or herbivorous quadruped. Nor does the flora of the Oolite seem to have been in the least suited for the purposes of the shepherd or herdsman. Not until we enter on the Tertiary periods do we find floras amid which man might have profitably laboured: nay, there are whole orders and families of plants, of the very first importance to man,

which do not appear until late in even the Tertiary ages. The true grasses scarce appear in the fossil state at all. For the first time, amid the remains of a flora that seems to have had its few flowers,—the Oolitic ages,—do we detect, in a few broken fragments of the wings of butterflies, decided traces of the flower-sucking insects. Not, however, until we enter into the great Tertiary division do these become numerous. The first bee makes its appearance in the amber of the Eocene, locked up hermetically in its gem-like tomb,—an embalmed corpse in a crystal coffin,—along with fragments of flower-bearing herbs and trees. Her tomb remains to testify to the gradual fitting up of our earth as a place of habitation for a creature destined to seek delight for the mind and eye, as certainly as for the proper senses, and in especial marks the introduction of the stately forest trees, and the arrival of the delicious flowers.”<sup>1</sup>

“ Sweet flowers ! what living eye hath viewed  
 Their myriads ? endlessly renewed ;  
 Where'er strikes the sun's glad ray,  
 Where'er the subtle waters stray,  
 Wherever sportive zephyrs bend  
 Their course, or genial showers descend ”

(1) Hugh Miller's *Testimony of the Rocks*.





## CHAPTER II.

### DIVISION OF ANIMAL KINGDOM.

PROTOZOA—GREGARINÆ—RHIZOPODA—POLYCYSTINA—DIATOMACEÆ—FOSSIL  
INFUSORIA, SPONGIDÆ, HYDROZOA, VORTICELLÆ,  
ACTINOZOA, ROTIFERÆ, POLYZOA. &c.



SINCE our very limited space forbade more than a cursory glance at the many and varied points of beauty and arrangement displayed in every part of the vegetable kingdom; so in the present division is it necessary to be equally brief in noticing the wonders displayed by the help of the microscope, in the world of animal life. In the course of remarks made upon the early condition of vegetable life, we drew attention to the difficulties presented in all attempts to mark out the boundary line between vegetables and animals, and to define where the one ends, and the other begins.

Upon reviewing the different characters by which it has been attempted to distinguish the special subjects of the botanist and zoologist, we find that animals and plants are not two natural divisions, but are specialised members of one and the same group of organised beings. When a certain number of characters concur in the same organism, its title to be regarded as a "plant," or an "animal," may be readily recognised; but there are very numerous living beings, especially those that retain the

form of nucleated cells, which manifest the common organic characters, but are without the true distinctive superadditions of either kingdom.

The animal kingdom is conveniently arranged under the following primary groups, sub-kingdoms, or departments:—PROTOZOA, CŒLENTERATA, ANNULOSA, MOLLUSCA, and VERTEBRATA. These are again divided into classes, classes into orders, orders into families, families into genera, and genera into species. In the first-named department, the Protozoa, is included a vast number of creatures of the simplest organisation, classified as follows:—1. Gregarinidæ, 2. Rhizopoda, 3. Polycystina, 4. Thalassicollidæ, 5. Spongidæ, 6. Infusoria. It is not unusual to place Rhizopoda and its typical form, Amœba, in the front rank; and as the presence of a mouth characterises the Infusoria, the remaining part of the Protozoa are frequently designated by a collective name, *Astomata*.

The first-named, *Gregarinidæ*, form a group of the very simplest structural character, and any one of them, setting minor modifications aside, may be said to consist of a sac, composed of a more or less structureless membrane, containing a soft semi-fluid substance, in the midst of which is a circular vacuole or vesicle, having in its centre a more solid particle or nucleus. Professor Huxley appends to this description the obvious, but highly important reflection, that its statements are all true concerning the ova of any of the animals much higher in the scale.<sup>1</sup> The *Gregarinidæ* inhabit the bodies of other animals, and they multiply by becoming encysted, and dividing into a multitude of minute objects, called *pseudo-navicellæ*, from their resemblance in shape to the ship-like diatoms (*naviculæ*). When a young pseudo-navicella escapes, it behaves somewhat like an amœba, and, if it chance to get swallowed by an appropriate host, it grows into the parent form. The whole life-history of these creatures is not known, as they have not been traced into the exhibition of sexual properties; and it is therefore possible that their position in the scale may not be exactly defined.

In the course of the numerous investigations made of the flesh of animals dying during the year 1866 from the cattle-plague, it was noticed that large quantities of peculiar bodies infested the muscular structures, more especially

(1) Huxley's "Lectures on the Elements of Comparative Anatomy"

that of the heart, and it was supposed that these had some share in the production of the disease; but upon making further investigations this has been found not to be so, and since the same bodies are known to be generally distributed throughout the ultimate fibres of animals dying from other diseases, the only interest that can attach to the discovery is, that it promises to add some valuable facts to our knowledge of the remarkable group of Protozoa, the *Gregarinæ*. The Gregarines observed in the flesh of oxen, and described by Dr. Beale, have elongated spindle-shaped sacs, containing granular reniform bodies arranged horizontally, and apparently capable of multiplying by division. The investing sac is covered with minute, motionless, hair-like bodies. No nucleus is present in the sac; but the reniform granular masses are stated by Dr. Cobbold to possess nucleoli. The structure thus presented is not far removed from that of many *Gregarinæ*, particularly of the larger individuals occurring in the earthworm, though the hair-like processes sometimes observable on these are considered as extraneous by Dr. Leiberkühn. The compacted reniform masses may be considered as the results of a process of segmentation, similar to that by which the pseudonaviculæ are formed. The bodies thus described are by no means peculiar to diseased cattle; they are met with in the healthy muscles of the ox, sheep, pig, deer, rat, mouse, mole, and perhaps other animals. *Gregarinæ*, in various stages, are represented in Plate III. figs. 53, 54, 55, and 56. Miescher, in 1843, described such bodies, taken from the muscles of a mouse, and a very good account of them, obtained from the muscles of a pig, is given by Mr. Rainey, in the "Philosophical Transactions," for 1857, though he erroneously regarded them as the young stage of cestoid entozoa. They have been described under a variety of titles, such as worm-nodules, egg-sacs, eggs of the fluke, young measles, "*corpuscles produced by muscular degeneration*," &c. When considered in connexion with the minute cysts described by Gabler, Virchow, and Dressler, from the human liver, they have an especial interest; and the observations of Lindemann on the psorospermial sacs obtained from the hair of a peasant at

Nischney-Novgorod, and in the kidneys of a patient who died from Bright's disease, bear very strongly on the nature of these bodies. The people of Novgorod are believed to get these parasites from washing in water in which *Gregarinæ* abound.<sup>1</sup> The most interesting inquiry which is placed before us by these various facts is whether, as Professor Leuckart has observed, "the psorospermæ" (and we may add the "spurious entozoa" of cattle, and even many so-called *Gregarinæ*) are to be considered as the result of a special animal development, or whether they are the final products of pathological metamorphosis.

It appears, from the reseaches of M. Claparède and others, that some of the unilocular forms do present very curious, elongated, and active forms, which, from their movements and general appearance, might be mistaken for nematodes. Dr. Joseph Leidy has, in the "Transactions of the Philadelphia Society, 1853," denied the fact that the *Gregarinæ* are unicellular animals, on the following grounds:—In the examinations of some new species of *Gregarinæ* which he has described, and also in the *G. Blotharum* of Siehold, he discovered that the membrane enclosing the granular mass of the posterior sac was double. He observes: "Within the parietal tunic of the posterior sac is a second membrane, which is transparent, colourless, and marked by a most beautiful set of exceedingly regular parallel longitudinal lines."

M. Leiberkühn contributed a very elaborate paper on the *Gregarina* of the earthworm. He does not express any very decided opinion upon the two questions which have been discussed by Leidy and Bruch, but devotes the principal part of his memoir to the development and reproduction of the *Gregarinæ*. With regard to the development of *Gregarinæ* into a filaria-like worm, which Bruch thought probable, M. Leiberkühn says but little, but, nevertheless, has proved beyond doubt that the nematodes

(1) Many vague and improbable statements appeared at one time on a supposed discovery of *Gregarinæ* in the human hair. Upon a more careful examination being made by competent persons, the foreign body proved to be a well-known vegetable fungus, often found associated with a disease, or dirty neglected state of the skin. It is very well known that *Gregarines* are never found on free or exposed surfaces.

of the earthworm are developed from eggs, whence they emerge, not as Gregarinæ, but as true nematodes. The transformation of two Gregarinæ, after a process of encystation, into navicula-like bodies, has been fully described by Bruch; but Leiberkühn has more carefully illustrated the changes that go on, and has endeavoured to trace the existence of the pseudo-naviculæ after they have been expelled from the cyst. In the perivisceral cavity of the earthworm he found large numbers of small corpuscles, exhibiting amœba-like movements, and likewise pseudo-naviculæ, containing granules, formed from encysted Gregarine. He imagines that these latter bodies burst, and that their contained granules develop into the amœbiform bodies which subsequently become Gregarinæ. M. Leiberkühn shortly afterwards published another paper, in which he adopts the same view, that the amœbiform corpuscles of the blood of fish are Gregarines. But few physiologists will feel disposed to agree with him, in considering these bodies as parasites.

Mr. E. Ray Lankester has contributed a valuable and exhaustive paper on this subject;<sup>1</sup> he observes: "I have made careful examination of more than a hundred worms, for the purpose of studying these questions, but have succeeded in arriving at no other conclusion than that certain forms of these may be the products of encysted Gregarinæ. The *G. Lumbrici* is one of those forms which are unilocular, and are met with most frequently among Annelids. It consists of a transparent contractile sac (which has not hitherto been demonstrated to be formed by more than a single membrane), enclosing the characteristic granules and vesicle. The vesicle is not always very distinct, and is sometimes altogether absent; occasionally it contains no granules, sometimes several, one of which is generally nucleated. In some of these cysts a number of nucleated cells may be seen, developing together from the enclosed Gregarina, which gradually become fused together and broken up, until the entire mass is converted into these nucleated bodies, which are then evident in different stages of development, assuming the form of a

(1) E. Ray Lankester, "On the Gregarinids found in the common Earth-worm."—*Microsc. Trans.* vol. iii. p. 88.

double cone, like that presented by some species of Diatomaceæ, whence their name pseudo-naviculæ. At length the cyst contains nothing but pseudo-naviculæ, sometimes enclosing granules, which gradually disappear, and finally the cyst bursts. Encystation seems to take place much more rarely among the bilocular forms of Gregarinæ than in the unilocular species found in the earthworm and other Annelids."

In the *Gregarinæ* the food is taken in indiscriminately at every point of the surface of the body by imbibition. The food most likely is in the fluid state. In *Spongilla* also, this is probably the case. But it is generally agreed that in *Amœba*, *Actinophrys*, and *agastric Infusoria*, only solid alimentary particles are taken as food. The simplest animal is indeed far more complex than is implied in the word *unicellular*, and it can be clearly proved that there are few points in common between a simple cell and a so-called unicellular protozoon. The system of contractile vesicles and dependent sinuses, so general in the least organized protozoon, is unknown in the history of cells. Fluid absorption by the surface is the normal method of feeding in these low types of animal life. This absorptive faculty is an inherent property of the substance of which they are composed. It attracts certain aliments, as gelatine attracts water. Tissue, distinguished by the same character, prevails throughout the entire class of the *Protozoa*. Although the *Gregarinæ* mostly inhabit the intestines of invertebrate animals, they are often found in the alimentary canal of the *Vertebrata*. In this class they appear to be represented, however, by very closely allied organisms, the *Psorospermicæ*. Müller gave this last-mentioned name to some very singular minute bodies he discovered within sacs upon the skin and gills, and in the internal organs, of many fishes. These animals are generally of a cylindrical or somewhat elliptical form, although sometimes a sort of head appears to be produced by the constriction of the anterior extremity of the body, and this head-like portion is occasionally furnished with a curious soft process and lobes. They are very sluggish in their movements, although a few possess true cilia. Their curious mode of development, with other points in the

history of these minute parasites, are well worthy of investigation.

The *Rhizopoda* appear as creatures of a low type of organization, and are considered, with the former, to hold a medium state between animals and vegetables. Almost all of them live in water; it would be a fruitless search to look for distinct internal organs, as the small bladder-looking spaces enclosed within their substance,—believed by Ehrenberg to be stomachs,—present only the appearance of transparent gelatinous cells, or rather moving spaces, within the sarcode envelope, and may be regarded as the earliest dawn of a circulatory system.

The term *Rhizopoda* is derived from the Greek, and

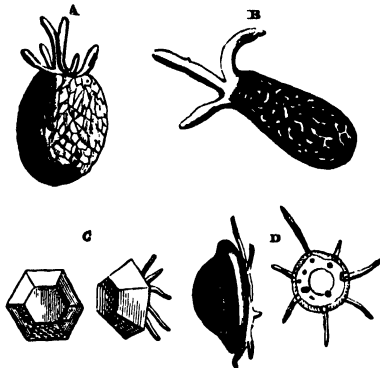

Fig. 205.—Simple Rhizopods.

A, *Difflugia proteiformis*. B, *Difflugia oblonga*. C, D, *Arcella acuminata* and *dentata*.

means “root-footed,”—the body is composed entirely of gelatinous matter, *sarcode*,—motion being effected by the extension of portions of the substance into processes, which, as in fig. 205, is seen to partake of various forms.

*Lotosa*.—In the deposit formed at the bottom of fresh-water ponds, we may often meet with a singular minute gelatinous body, which constantly changes its form even under our eyes; and moves about by means of finger-like processes, called *pseudopodia*, which it appears to have the power of shooting out from any part of its substance.

This shapeless mass is well known to microscopic observers under the name of the *Proteus* (*Amœba diffluens*, fig. 206), which, from the continual changes of shape it presents, is



Fig. 206.—*Amœba diffluens*, or *Proteus*, in different forms.

honoured with the name of a fabled god, who could be either animal, vegetable, or mineral in his nature. This curious animal presents us with the essential characters of the large class *Rhizopoda* in their simplest form. It appears to be of an exceedingly voracious disposition, seizing upon any minute aquatic animals or plants that may come in its way, and appropriating them to the nutrition of its own gelatinous body. The mode in which this tender and apparently helpless creature effects this object is very remarkable. The gelatinous matter of which it is composed is capable, as we have seen, of extension in every direction; accordingly, when the *Amœba* meets with anything that it regards as suitable for its support, the substance of the creature, as it were, grows round the object until it is completely enclosed within its body. The substances swallowed (if such a term be admissible) by this hungry mass of jelly are often so large, that the creature itself only seems to form a sort of gelatinous coat enclosing its prey.

Professor Ecker believes in an exact similarity of *contractile substance* between that of the lower animal forms, such as the *Rhizopoda*, and that observed in the *Hydra*. He says: "The properties of this substance, in its simplest form, are seen in the *Amœba*, the body of which, as is known, consists of a perfectly transparent albumen-like homogeneous substance, in which nothing but a few granules are imbedded, and which presents no trace of



further organization. This substance is in the highest degree extensible and contractile; and from the main mass are given out, now in one part and now in another, perfectly transparent rounded processes, which glide over the glass like oil, and are then again merged in a central mass. There is no external membrane. In the body of the *Amoeba* there occur, besides the granules, clear spaces with fluid contents, which are sometimes unchangeable in form, and sometimes exhibit rhythmical contractions."

Belonging to the family is the very curious *Acineta* of Ehrenberg, *Actinophrys sol*, "sun-animalcule." This creature consists of a jelly-like contractile substance, or *sarcodé*, with tentacular filaments radiating from the central mass, in such a manner as to have suggested the name for the species. It abounds in pools where *Desmidiaceæ* are found in many parts around London; they are ravenous feeders, not only upon the *Desmidiaceæ*, but also upon all kinds of minute spores and animalcules. (Plate III. fig. 66.) It was on examining some beautiful *Desmidiaceæ* that my attention was arrested by the curious appearance of two or three very small *Actinophrys* floating very lightly upon the surface of the water, in the form of a ball, with their delicate tentacular filaments perfectly erect all over their bodies; in fact, they seemed to be floating upon these delicate filaments.<sup>1</sup>

The most beautiful forms of the *Rhizopoda* are found among those possessing a calcareous covering, as the *Polythalamia*, *Rosalina*, *Faujasina*, &c.; their systematic arrangement is founded upon their shells, which exhibit a very great diversity in form. Out of these forms, it would appear that the labours of various naturalists in the last hundred years have made us acquainted with nearly 2,000 recent and fossil *Foraminifera*; and although the observations of Dr. Carpenter<sup>2</sup> tend to show the probability that very many of these supposed species are merely varieties, still the number is sufficiently great to prove the importance and interesting nature of the inquiry.

(1) Weston, *Journ. Micros. Science*, vol. iv. New series, p. 116; Claparede, *Ann. Nat. His.* Second series, vol. xv. p. 211.

(2) Carpenter's "Introduction to the Study of the Foraminifera," published by the Ray Soc. 1862

Dr. Schultze acknowledges the difficulties attending the study of the *Rhizopoda*, and insists, very properly, upon the necessity of viewing them in all positions, and under different modes of illumination and of preparation, in order to arrive at a due conception of their astonishing conformation. When the shells of *Foraminifera* are dissolved in dilute acid, an organic basis is always left after the removal of the calcareous matter, accurately retaining the form of the shell with all its openings and pores. The earthy constituent is mainly carbonate of lime; but Dr. Schultze has satisfied himself of the presence of a minute amount of phosphate of lime in the shells of recent *Orbiculina adunca* from the Antilles and of *Stomella strigilata* from the Adriatic.

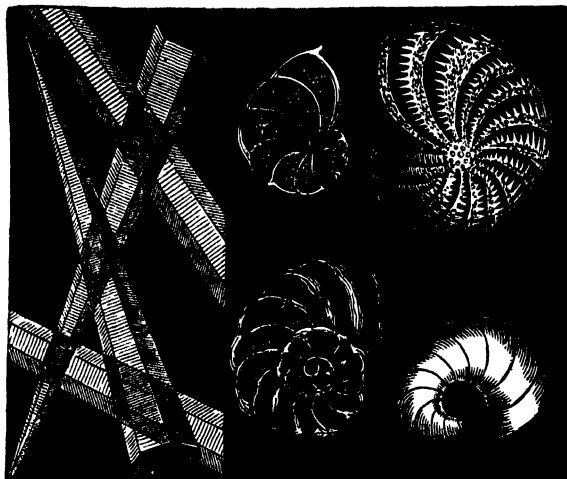

Fig. 297.

1, Separated prisms from outer layer of *Pisina* shell. 2, Skeletons of *Foraminifera* from limestone. 3, Recent shell of *Polystomella crispata*; viewed with dark-ground illuminator.

The solitary *Rhizopoda*, furnished with a horny shell or capsule, forming a case for the animal, is nearly the only representative of the *Arcellidæ*. In the *Arcella*, from which the family derives its name, the shell is somewhat of a bell-shape, with a very large round opening. In

*Englypha* it is of an oval or flask-like form, with the opening at the smaller end, and the shell appears as though formed of a sort of mosaic of small horny pieces. In *Diffugia*, Fig. 205, A B, the shell is often globular. Rhizopods which never develop more than one chamber or loculus are classed as *Monothalamia*.<sup>1</sup>

The *Polythalamia*, or Multilocular Rhizopods, in their earliest state, are unilocular; but, as the animal increases, successive chambers are added in a definite pattern for each family of the order. They all inhabit the sea, and frequently occur in such great numbers, that the fine calcareous sand which constitutes the sea-shore in many places consists almost entirely of their microscopic coats. At former periods of the earth's history, they existed in even greater profusion than at present; and their fragile shells form the principal constituent of several very important geological formations. Thus the chalk appears to consist almost entirely of the shells of these animals, either in a perfect state, or worn and broken by the action of the waves; they occur again in great quantities in the marly and sandy strata of the Tertiary epoch.

In the *Stichostegidæ* the chambers are placed end to end in a row, so as form a straight or but slightly curved shell. In the second family, the *Enallostegidæ*, the chambers are arranged alternately in two or three parallel lines; and as the construction of the shell is always commenced with a single small chamber, the whole necessarily acquires a more or less pyramidal form. The third family, the *Helicostegidæ*, presents us with some of the most beautiful forms that it is possible to meet with in shells. They commence by a small central chamber; and each of the subsequent chambers, which are arranged in a spiral form so as to give the entire shell much the aspect of a minute flattened snail, is larger than the one preceding it. It is in this family that we find the nearest approach, in external form, to the large chambered shells of the cephalopodous mollusca, of which the *Nautilus pompilius* is an example. The fourth family, the *Entomostegidæ*, stand in the same relation to the preceding as the *Enallostegidæ* to the

(1) *Diffugia* and *Anella* form a connecting link between the naked forms, *Amœba*, *Actinophrys*, &c. and the shell-bearing Rhizopods, *Lagena striata*, &c.

GREGARINIDA, POLYCISSINA, FORAMINIFERA, ROTIFERA, ETC.

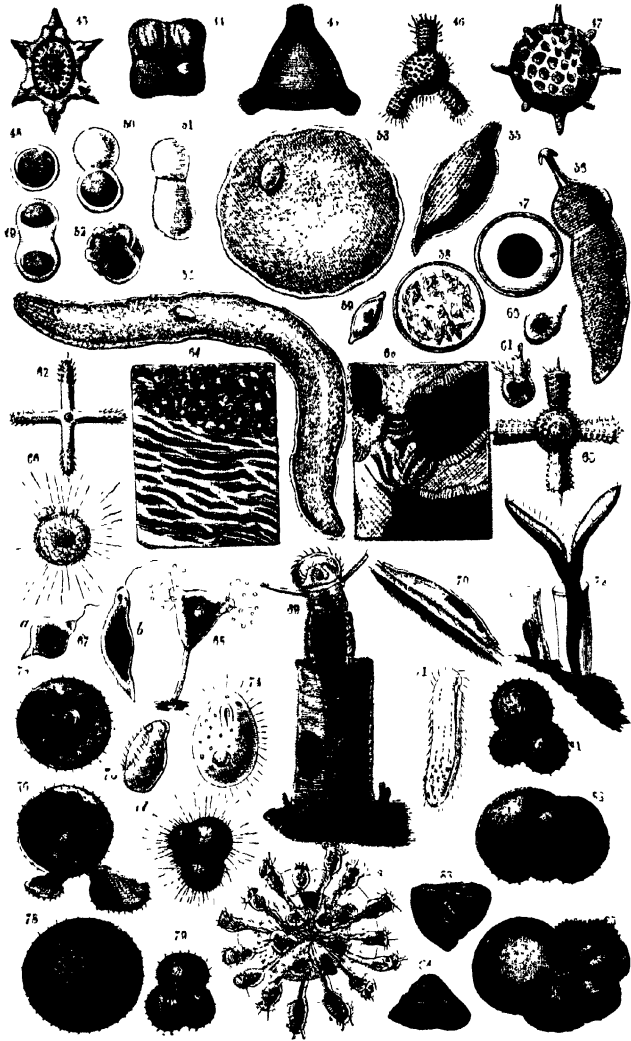

Tuffen West, del.

PLATE III.

Edmund E. ans



*Stichostegidæ*; that is to say, the chambers are also arranged in a spiral form, but in a double series. A fifth family includes those shells in which the chambers are arranged round a common perpendicular axis in such a manner that each chamber occupies the entire length of the shell. The orifices of the chambers are placed alternately at each end of the shell, and are furnished with a curious tooth-like process. The *Miliola* serve as an example of this family. Every handful of sea-sand, every shaking of a dried sponge, and the contents of the stomachs of most Lamellibranch molluscs, oyster and mussel, are pretty sure to exhibit a considerable admixture of these minute calcareous, or occasionally silicious, *Foraminifera*.

It is considered that the fossil shells, termed *Nummulites*, found in great quantities in the chalk and lower tertiary strata, are also to be regarded as members of this class; in a fossilized state, whole mountains consist almost entirely of their shells. The late Professor Quekett had an opportunity of examining a few living specimens, which, he says, "are composed of a sarcode element, built up into a series of chambers with calcareous material."

The great Pyramid of Egypt, covering eleven acres of ground, is based on blocks of limestone consisting of *Foraminifera*, *Nummulites*, or *stone coin*, and other fossil animalcules. *Nummulites* vary in size from a very minute object to that of a crown-piece, and many appear like a snake coiled up in a round form. A chain of mountains in the United States, 300 feet high, seems wholly formed of one kind of these fossil-shells. The crystalline marble of the Pyrenees, and the limestone ranges at the head of the Adriatic gulf, are composed of small *Nummulites*. Vast deposits of *Foraminifera* have been traced in Egypt and the Holy Land, on the shores of the Red Sea, Arabia, and Hindostan, and, in fact, may be said to spread over thousands of square miles from the Pyrenees to the Himalayas.

The fossilized *Foraminifera* in the Poorbandar limestone, although occasionally reaching the twenty-fifth, do not average more than the hundredth part of an inch in diameter; so that more than a million of them may be computed to exist in a cubic inch of the stone. They may

be separated into two divisions—those in which the cells are large, the regularity of their arrangement visible, and their bond of union consisting of a single constructed portion between each; and those in which the cells are minute, not averaging more than the 900th part of an inch in diameter, the regularity of their arrangement not distinctly seen, and their bond of union consisting of many thread-like filaments. To ascertain the mineral composition of the amber-coloured particles or casts, after having found that it was mostly carbonate of lime with which they were surrounded, they were placed for a few moments in the reducing flame of a blow-pipe, and it was observed that on subsequently exposing them to the influence of a magnet, they were all attracted by it. Hence, in a rough way, this rock may be said to be composed of carbonate of lime and oxide of iron.

By far the greater number of Foraminifera are marine. They are found in most seas, and in those of the tropics they increase both in size and variety, forming extensive deposits.

During the Canadian Geological Survey large masses of what appeared to be a fossil organism, the *Eozoon Canadense*, were discovered in rocks situated near the base of the Laurentian series of North America. Dr. Dawson, of Montreal, referred these remains to an animal of the foraminiferal type; and specimens were sent by Sir W. Logan to Dr. Carpenter, requesting him to subject them to a careful examination. As far back as 1858 Sir W. Logan had suspected the existence of organic remains in specimens from the Grand Calumet limestone, on the Ottawa river, but a microscopic examination of one of these specimens was not successful. Similar forms being seen by Sir William in blocks from the Grenville bed of the Laurentian limestone were in their turn tried, and ultimately revealed their true structure to Dr. Dawson and Dr. Sterry Hunt.

The masses of which these fossils consist are composed of layers of serpentine alternating with calc-spar. It was found by these observers that the calcareous layers represented the original shell; and the siliceous layers the flesh, or *sarcodæ*, of the once living creature. These

results were arrived at through comparison of the appearance presented by the *Eozoon* with the microscopic structure which Dr. Carpenter had previously shown to characterise certain members of the foraminifera. The *Eozoon* not only exceeded other known foraminifera in size, to an extent that might have easily led observers astray, but, from its apparently very irregular mode of growth, its general external form afforded no help in its identification, and it was only by careful examination of its minute structure that its true character could be ascertained. Dr. Carpenter says:—"The minute structure of *Eozoon* may be determined by the microscopic examination either of thin transparent sections, or of portions which have been subjected to the action of dilute acids, so as to remove the calcareous shell, leaving only the *internal casts*, or *models*, in silex, of the chambers and other cavities, originally occupied by the substance of one animal."

Dr. Carpenter found the preservation of minute structure so complete that he was able to detect "delicate pseudopodial threads, which were put forth through pores in the shell wall, of less than  $\frac{1}{10000}$ th of an inch in diameter" (see Plate III. figs. 64, 65); and in a paper read at the meeting of the Geological Society he stated that he had detected *Eozoon* in a specimen of opihalcite from Cesha Lipa in Bohemia, in a specimen of gneiss from near Moldau, and in a specimen of serpentine limestone sent to Sir C. Lyell by Dr. Gümbel, of Bavaria, all these being parts of the great formation of "fundamental" gneiss, which is considered by Sir Roderick Murchison as the equivalent of the Laurentian rocks of Canada. There can be little doubt that a rich field of research is now opened to those who will undertake the examination of rocks of various ages, which present the appearance of analogous structure; as it is, the microscope has been the means of demonstrating the existence of animal life at a very ancient geological date; and, in the words of Sir W. Logan, "we are carried back to a period so far remote that the appearance of the so-called *Primordial Fauna* may be considered a comparatively modern event."

Recent *Foraminifera* present symmetrical shells, of



minute size for the most part, and consisting, as we have already seen, either of one, two, or more connected chambers. A jelly-like mass, or "sarcode," occupies the chambers and their connecting passages; and, protruding itself both from the external aperture of

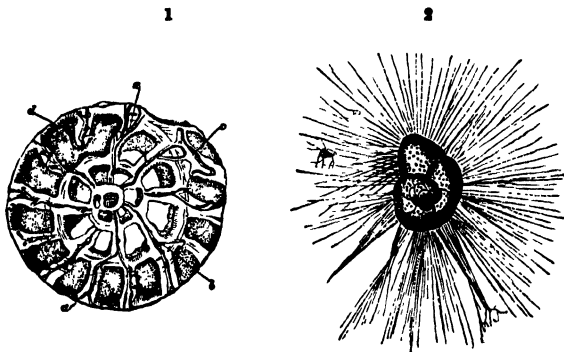

Fig. 208.

1, Section of *Faujasina*: a a, radiating interseptal canals; b, their intercal bifurcations; c, a transverse branch; d, tubular wall of the chambers. 2, *Rosalina ornata*, with its pseudopodia protruded.

the last chamber, and in many cases from the sometimes numerous perforations in the shell-walls, extends itself not only over the surface of the shell, but also into radiating contractile threads or *pseudopodia*, and into gemmule-like masses, which latter become coated over with calcareous matter, and thus form additional segments of the animal.<sup>1</sup>

"*Foraminifera*, indeed, are to be compared with the other lowest orders of animals and of plants in the study of their specific relations. In these several low forms of creatures we have comparatively few species, but extremely numerous individuals, with an enormous range of

(1) Among the more important works on *Foraminifera*, reference may be made to D'Orbigny's *Foraminifères fossiles du Bassin Tertiaire de Vienne* (Autriche); Schultze, *Ueber den Organismus der Polythalamien*, 1854; Carpenter's and Williamson's *Researches on the Foraminifera*, *Phil. Trans.* 1856. Also an excellent paper by Mr. W. E. Parker, in the *Annals of Natural History*, April, 1857. Specimens of *Foraminifera* may be obtained for examination from the shaking of dried Sponges; but if required alive they must be dredged for, or picked off the fronds of living seaweeds, over the surface of which they are seen to move by the aid of a lens.

variety. In the higher orders of plants and animals the specific forms are more definite, there being a more complex organization, harmonizing with the special habits of each creature ; and the individuals of each species are less

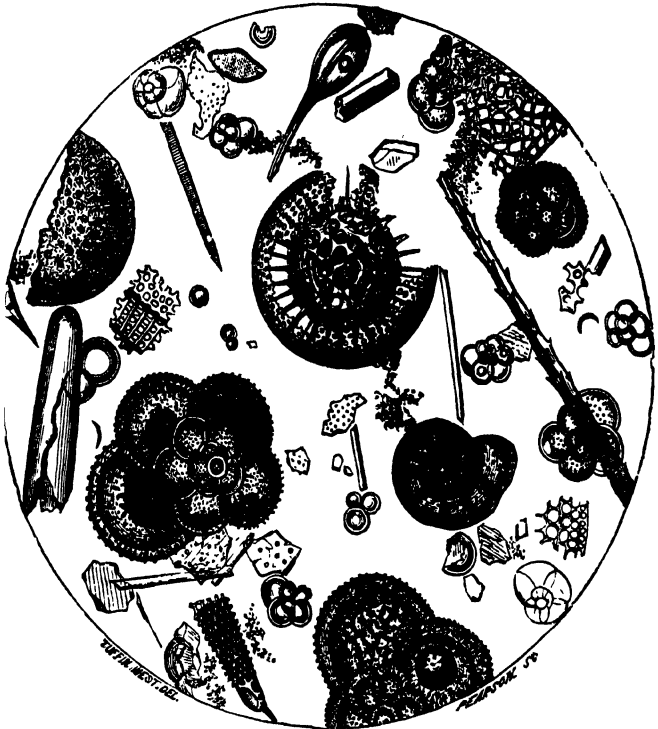

Fig. 209.—*Foraminifera* taken in Deep-sea Soundings. (Atlantic.)

numerous than is the case in the Protozoans and Proto-phytes."

These lowly organized *Foraminifera*, having great simplicity of structure, more easily adapt themselves to varying external conditions than the more complex and specialized higher animals.

THE MICROSCOPE.

In the deep-sea soundings, portions of many beautiful Diatoms, figured and described by Professor W. Smith, in gatherings from the Bay of Biscay, near Biarritz, are *Melosira cribrata*, marine, orbicular, cellulate,



Fig. 210.—Foraminifera taken in Deep-sea Soundings. (Atlantic)

cellules, all equal and hexagonal. He writes : "In December, 1853, I received isolated frustules of this species, collected on the coast of Normandy, under the above name, from M. de Brébisson ; and I have since detected the same in a gathering from the Black Sea. In no case have I seen the frustules in a recent state, and do not know

whether they ever form a lengthened filament. As this is the only circumstance that would justify their separation from *Coscinodiscus*, to which the separated valve would otherwise seem to belong (*Synop. British Diatomaceæ*, vol. i. p. 22), their position in *Melosira* must rest upon the authority of my accurate correspondent."

In figs. 209 and 210 are represented many of the beautiful forms brought up with soundings made in 1856, for the purpose of ascertaining the depth of the Atlantic, prior to the laying down of the electric telegraph wire from England to America; these specimens were taken from a depth of 2,070 fathoms.

Major S. R. J. Owen, while dredging the surface of mid-ocean—Indian and Atlantic oceans—found attached to his nets a few interesting forms of Rhizopods, belonging to the two genera *Globigerina* and *Pulvinulina*, which always make their appearance on the surface of the ocean after sunset.<sup>1</sup>

"Many of the forms," writes this observer, "have hitherto been claimed by the geologist, but I have found them enjoying life in this their true home, the siliceous shells filled with coloured sarcode, and sometimes this sarcode in a state of distension somewhat similar to that found projecting from the Foraminifera, but not in such slender threads. There are no objects in nature more brilliant in their colouring or more exquisitely delicate in their forms and structure. Some are of but one colour, crimson, yellow, or blue; sometimes two colours are found on the same individual, but always separate, and rarely if ever mixed to form green or purple. In a globular species, whose shell is made up of the most delicate fret-work, the brilliant colours of the sarcode shine through the little perforations very prettily. In two specimens of the triangular and square forms (Plate III. figs. 44, 45, and 46), the respective tints of yellow and crimson are vivid and delicately shaded. In one the pink lines are concentric; while another is of a stellate form (fig. 43), the points and uncoloured parts being bright clear crystal, while a beautiful crimson ring surrounds the central por-

(1) *Journ. Linn. Soc.* vol. viii. p. 202; vol. ix. p. 147, 1866, and 1867.

In the deep-sea soundings, portions of many beautiful Diatoms, figured and described by Professor W. Smith, in gatherings from the Bay of Biscay, near Biarritz, are *Melosira cribraea*, marine, orbicular, cellulate,



Fig. 210.—Foraminifera taken in Deep-sea Soundings. (Atlantic)

cellules, all equal and hexagonal. He writes: "In December, 1853, I received isolated frustules of this species, collected on the coast of Normandy, under the above name, from M. de Brébisson; and I have since detected the same in a gathering from the Black Sea. In no case have I seen the frustules in a recent state, and do not know

whether they ever form a lengthened filament. As this is the only circumstance that would justify their separation from *Coscinodiscus*, to which the separated valve would otherwise seem to belong (*Synop. British Diatomaceæ*, vol. i. p. 22), their position in *Melosira* must rest upon the authority of my accurate correspondent."

In figs. 209 and 210 are represented many of the beautiful forms brought up with soundings made in 1856, for the purpose of ascertaining the depth of the Atlantic, prior to the laying down of the electric telegraph wire from England to America; these specimens were taken from a depth of 2,070 fathoms.

Major S. R. J. Owen, while dredging the surface of mid-ocean—Indian and Atlantic oceans—found attached to his nets a few interesting forms of Rhizopods, belonging to the two genera *Globigerina* and *Pulvinulina*, which always make their appearance on the surface of the ocean after sunset.<sup>1</sup>

"Many of the forms," writes this observer, "have hitherto been claimed by the geologist, but I have found them enjoying life in this their true home, the siliceous shells filled with coloured sarcode, and sometimes this sarcode in a state of distension somewhat similar to that found projecting from the Foraminifera, but not in such slender threads. There are no objects in nature more brilliant in their colouring or more exquisitely delicate in their forms and structure. Some are of but one colour, crimson, yellow, or blue; sometimes two colours are found on the same individual, but always separate, and rarely if ever mixed to form green or purple. In a globular species, whose shell is made up of the most delicate fret-work, the brilliant colours of the sarcode shine through the little perforations very prettily. In two specimens of the triangular and square forms (Plate III. figs. 44, 45, and 46), the respective tints of yellow and crimson are vivid and delicately shaded. In one the pink lines are concentric; while another is of a stellate form (fig. 43), the points and uncoloured parts being bright clear crystal, while a beautiful crimson ring surrounds the central por-

(1) *Journ. Linn. Soc.* vol. viii. p. 202; vol. ix. p. 147, 1866, and 1867.

In the deep-sea soundings, portions of many beautiful Diatoms, figured and described by Professor W. Smith, in gatherings from the Bay of Biscay, near Biarritz, are *Melosira cribræa*, marine, orbicular, cellulate,

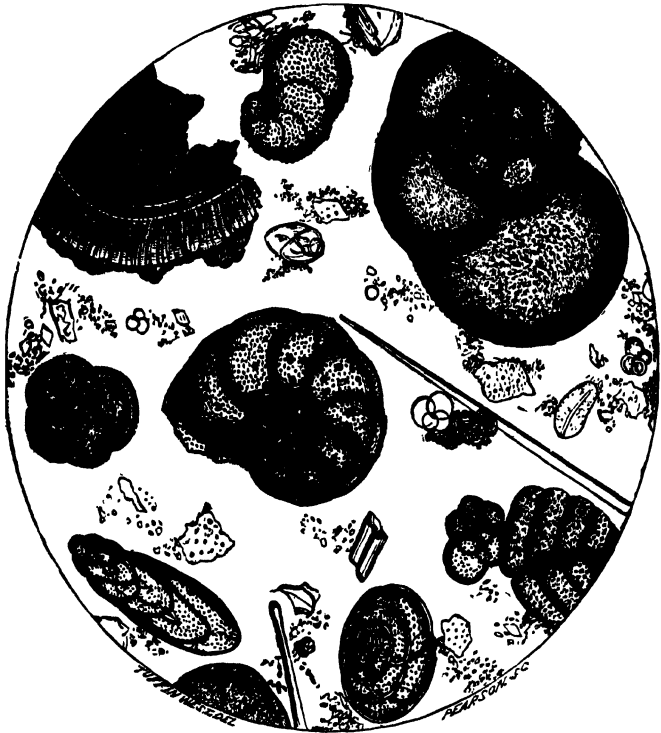

Fig. 210.—*Foraminifera* taken in Deep-sea Soundings. (Atlantic)

cellules, all equal and hexagonal. He writes : "In December, 1853, I received isolated frustules of this species, collected on the coast of Normandy, under the above name, from M. de Brébisson ; and I have since detected the same in a gathering from the Black Sea. In no case have I seen the frustules in a recent state, and do not know

whether they ever form a lengthened filament. As this is the only circumstance that would justify their separation from *Coscinodiscus*, to which the separated valve would otherwise seem to belong (*Synop. British Diatomaceæ*, vol. i. p. 22), their position in *Melosira* must rest upon the authority of my accurate correspondent."

In figs. 209 and 210 are represented many of the beautiful forms brought up with soundings made in 1856, for the purpose of ascertaining the depth of the Atlantic, prior to the laying down of the electric telegraph wire from England to America; these specimens were taken from a depth of 2,070 fathoms.

Major S. R. J. Owen, while dredging the surface of mid-ocean—Indian and Atlantic oceans—found attached to his nets a few interesting forms of Rhizopods, belonging to the two genera *Globigerina* and *Pulvinulina*, which always make their appearance on the surface of the ocean after sunset.<sup>1</sup>

"Many of the forms," writes this observer, "have hitherto been claimed by the geologist, but I have found them enjoying life in this their true home, the siliceous shells filled with coloured sarcode, and sometimes this sarcode in a state of distension somewhat similar to that found projecting from the Foraminifera, but not in such slender threads. There are no objects in nature more brilliant in their colouring or more exquisitely delicate in their forms and structure. Some are of but one colour, crimson, yellow, or blue; sometimes two colours are found on the same individual, but always separate, and rarely if ever mixed to form green or purple. In a globular species, whose shell is made up of the most delicate fret-work, the brilliant colours of the sarcode shine through the little perforations very prettily. In two specimens of the triangular and square forms (Plate III. figs. 44, 45, and 46), the respective tints of yellow and crimson are vivid and delicately shaded. In one the pink lines are concentric; while another is of a stellate form (fig. 43), the points and uncoloured parts being bright clear crystal, while a beautiful crimson ring surrounds the central por-

(1) *Journ. Linn. Soc.* vol. viii. p. 202; vol. ix. p. 147, 1866, and



tion. One globular species appears like a specimen of the Chinese ball-cutting—one sphere within another ; but it is of a marked and distinct kind.

“The shells of some of the globular forms of these Polycystina, whose conjugation I believe I have witnessed, are composed of a fine fretwork, with one or more large circular holes ; and I suspect the junction to take place by the union of two such apertures. That the figures of these shells become elongated, lose their globular form after death, and present a disturbed surface is seen in some of the figures represented near the bottom part of Plate III.” Major Owen proposes to make *Orbulina* a subgenus of *Globigerina*. The internal chambers of the former are in form remarkably like those of the latter, and like them also they present themselves with varying surfaces, some free from, while others are covered with, spines. Those without internal chambers have been known as *Orbulina universa*, fig. 78, Plate III. while figs. 75 and 76, although members of the same family, have been separated ; but he wishes to see all united under the name of “*Globigerina universa*.”

The minute siliceous shells of *Polycystina* present wonderful beauty and variety of form ; all are more or less perforated, and often prolonged into spines or other projections, through which the sarcode body extends itself into pseudopodial prolongations resembling those of Actinophrys. When seen besporting themselves in all their living splendour, their brilliancy of colouring, says Major Owen, “renders them objects of unusual attraction.” We have endeavoured to give some idea of the colour of the living forms in Plate III. Nos. 43 to 52. The same observer believes that they wish to avoid the light, “as they are rarely found on the surface of the sea in the day time ; it is after sunset, and during the first part of the night especially, that they make their appearance.”

The *Polycystina* appear to have most affinity with the *Foraminifera*. Thirty four genera and about two hundred and ninety species have been described. They are most abundant in the fossil state ; and are very plentiful in the rocks of Bermuda, in the tripoli of Richmond, Virginia, in the marls of Sicily, and other places. Their minute shells

form beautiful microscopic objects for the binocular ; they must be mounted dry, and viewed either with the dark ground illuminator, or by condensed light.

## SPONGIADÆ.—SPONGES.

The term *Porifera*, or *Canal-bearing Zoophyte*, was applied by Professor Grant to designate the remarkable class of organized beings known as sponges, which are met with in every sea, growing in great abundance on the surface of rocks.

Ellis, in the course of his investigations, was astounded by discovering that sponges possessed a system of pores and vessels, through which sea-water passed, with all the appearance of the regular circulation of fluids in animal bodies, and for the seeming purpose of conveying animalcules to the animals for food.

The description given of sponges by Dr. Johnston is, that they are "organized bodies growing in a variety of forms, permanently rooted, unmoving and irritable, fleshy, fibro-reticular, or irregularly cellular ; elastic and bibulous, composed of a fibro-corneous axis or skeleton, often interwoven with siliceous or calcareous spicula, and containing an organic gelatine in the interstices and interior canals ; and are reproduced by gelatinous granules called *gemmules*, which are generated in the interior, but in no special organ. All are aquatic, and with few exceptions marine."<sup>1</sup> Our author continues :—" Mr. John Hogg, in a letter to me dated June 25, states that the green colour of the fresh-water sponge (*Spongilla fluviatilis*) depends upon the action of light, as he has proved by experiments which showed that *pale*-coloured specimens became green when they were exposed for a few days to the light and full rays of the sun ; while, on the contrary, *green* specimens were blanched by being made to grow in darkness or shade."

The living sponge, when highly magnified, exhibits a reticulated structure, permeated by pores, which united into cells or tubes, ramify through the mass in every direction, and terminate in larger openings. In most

(1) See Dr. Johnston's *History of British Sponges*, and Mr. Bowerbank's revision of the class, in the publications of the Ray Society.

sponges the tissue is strengthened and supported by spines, *spicula*, of various forms; and which, in some species, are siliceous, and in others calcareous. The minute pores, through which the water is imbibed, have a fine transverse gelatinous network and projecting spicula, for the purpose of excluding large animals or noxious particles; water incessantly enters into these pores, traverses the cells or tubes, and is finally ejected from the larger

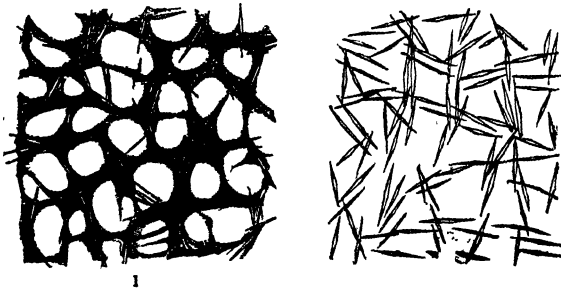

Fig. 211.

1, A portion of Sponge, *Halichondria simulans*, showing siliceous spicula imbedded in the sarcodine matrix. 2, Spicula divested of its matrix.

vents. But the pores of the sponge have not the power of contracting and expanding, as Ellis supposed; the water is attracted to these openings by the action of instruments of a very extraordinary nature (cilia), by which currents are produced in the fluid, and propelled in the direction required by the economy of the animal.

Mr. Bowerbank, in a paper on the "Structure and Vitality of *Spongiadae*," states that sponges consist principally of *sarcodine*, strengthened sometimes by a siliceous or calcareous skeleton, having remarkable reparative and digestive powers, and consequently a most tenacious vitality; so much so, that having cut a living sponge into three segments, and reversed the position of the centre piece, after the lapse of a moderate interval, a complete junction of the parts became effected, so as to render the previous separation indistinguishable.

Professor Grant's careful and laborious researches, have finally classed sponges in the animal series of the creation.

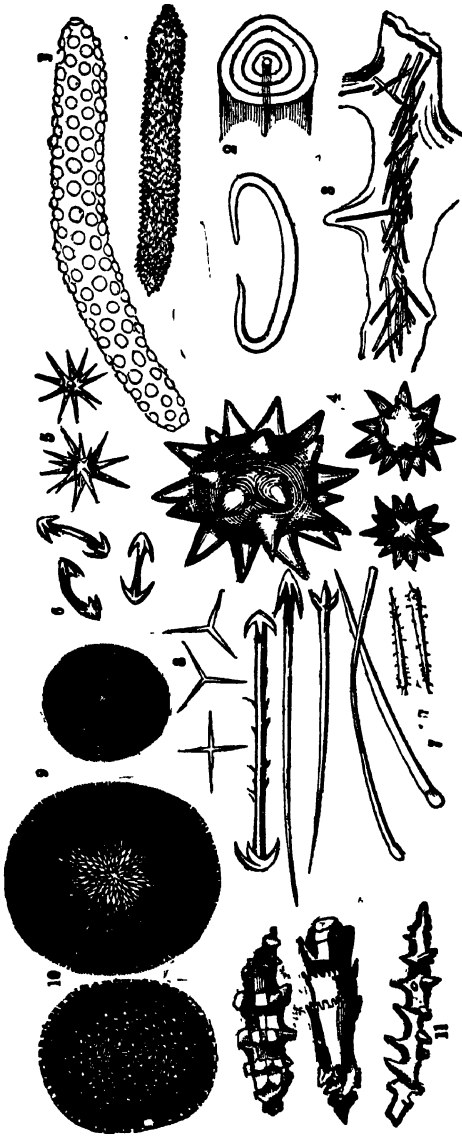

Fig. 312.

1, Skeleton of sponges of the acerate form, covered with rows of spines. 2, Horizontal section, showing rings of growth. 3, A portion of horny fibre, enclosing a bundle of spicula of the genus *Ferrogia*. 4, Sphero-stellate spicula of *Trichya*. 5, Sphero-stellate spicula of *Trichya*, highly magnified. 6, Tricuspid asciculate spicula. 7, Acuate-biclavate, double recurvo-ternate, expando-ternate, detirradiate spicula. 8, Triradiate spicula from a *Granisia*. 9, Gemmules of *Geodia*. 10, Gemmules of *Geodia*, in an advanced stage of growth. 11, Clavate spicula, covered with short spines.

He ascertained that the water was perpetually sucked into the substance of the sponge, through the minute pores that cover its surface, and again expelled through the larger orifices. His own account is so very interesting, that we cannot resist giving, in his own words, the results arrived at in these investigations:—"Having placed a portion of live sponge (*Spongia coalita*, fig. 1, No. 213) in a watch-

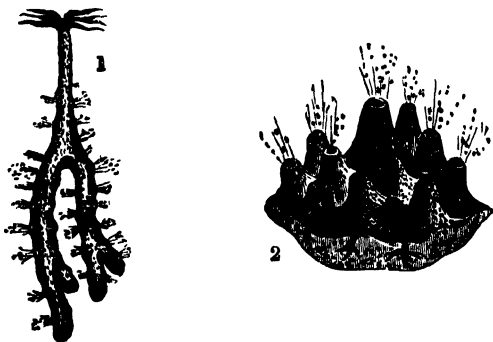

Fig 213.

1. *Spongia coalita*. 2. *Spongia panicea*.

glass with some sea-water, I beheld for the first time the splendid spectacle of this living fountain, better represented in No. 2, vomiting forth from a circular cavity an impetuous torrent of liquid matter, and hurling along in rapid succession opaque masses, which it strewed everywhere around. The beauty and novelty of such a scene in the animal kingdom long arrested my attention; but after twenty-five minutes of constant observation, I was obliged to withdraw my eye from fatigue, without having seen the torrent for one instant change its direction, or diminish the rapidity of its course. In observing another species (*Spongia panicea*), I placed two entire portions of this together in a glass of sea-water, with their orifices opposite to each other at the distance of two inches; they appeared to the naked eye like two living batteries, and soon covered each other with the materials they ejected. I placed one of them in a shallow vessel, and just covered

its surface and highest orifice with water. On strewing some powdered chalk on the surface of the water, the currents were visible to a great distance; and on placing some pieces of cork or of dry paper over the apertures, I could perceive them moving, by the force of the currents, at the distance of ten feet from the table on which the specimen rested."

Dr. N. Lieberkühn, in his valuable contributions to the *History of the Development of the Spongillæ*, observes that with regard to the skeleton of *S. fluviatilis*, the spicules are not united at the base by a siliceous material, as stated by Meyen, but by a substance destructible by heat. The spicules are usually arranged in aggregate bundles, which meet point to point at an obtuse angle, and project slightly above the surface of the sponge. Minute portions of the gelatinous substance exhibit under the microscope *amœba-like* movements, respecting which it is unknown whether they are vital phenomena, as supposed by Dujardin, or referable to a process of decomposition.<sup>1</sup>

The living *spongillæ* are often seated, not immediately upon the wood, stone, &c. upon which they may be growing, but separated from it by a peculiar dark-brown substance often several inches thick. This mass is composed chiefly of the remains of the dead sponge, empty gemmule-cases with their amphidiscs, various forms of siliceous spicules, &c.; and occasionally there may be

(1) The motile phenomena hitherto observed in sponges are connected with larger or smaller portions of the external integument, and of the exhalant tubules, or with isolated cells. When the exhalant tubules of *Spongilla* contract, their walls become shortened and thickened, and the previously smooth surface uneven, from the presence of the spherical contracted cells, whose outlines at the same time are rendered very distinct, whilst they were before invisible, or at most here and there perceptible. Other motile phenomena are witnessed when a *Spongilla* with external membrane and exhalant canals is reproduced from a cut-off portion. The fragment thus cut off may be so thin as to consist of only a single layer of reticular parenchymatous fibres. The interstitial rounded, oval, or irregular spaces, under these circumstances, become for the most part closed, owing to the gradual increase in breadth of the trabeculae, or cavities may be left when their membranes are stretched over them only from the upper and under sides of the trabeculae, which enclose a space between them, and may become portions of the outer membrane with exhalant canals. It cannot be determined with certainty to what extent this change of form is connected with any multiplication of cells. Lastly, movements in the individual cells have been noticed, the globular cells becoming stellate, and the stellate ones globular in turn, but without any locomotion. This phenomenon occurs, not only in the cells of the uninjured substance, but also in those which have been detached.—N. Lieberkühn, "On the Motile Phenomena in Sponges," *Microsc. Journ.* vol. iv. 1864, p. 189, and *Journ. Microsc. Science*, vol. v. 1867, p. 112, "On the Development of the Spongillæ."

attaining more than two inches in thickness. From the other sponges it is distinguished by the *smooth* spicula which surround its seed-like bodies, and the matted structure.

*Spongilla alba*.—Its texture is coarse and open; structure reticulated. The investing membrane abounds in minute spicula; has seed-like spheroidal bodies about 1.30th of an inch in diameter, with rough points externally. The large spicula are slightly curved, smooth, pointed at each end, about 1.54th of an inch in length; the small spicula are slightly curved, thickly spiniferous, or pointed at both ends; the former, pertaining to the seed-like bodies, are about 1.200th of an inch in length; the latter pertaining to the investing membrane, are more slender, and a little less in length; these last numerous small spiniferous spicula when dry present a white-lace appearance, from which Mr. Carter gives them the name of *alba*.

*Spongilla meyeri* is massive, having large lobes, mammillary eminences, or pyramidal, compressed, obtuse, or sharp-pointed projections, of an inch or more in height; also low wavy ridges. Its seed-like bodies are spheroidal, about 1.47th of an inch in diameter, studded with little toothed discs.

Mr. Carter enters very minutely into the structure of "fresh-water sponge, which"—he believes—"is composed of a fleshy mass, supported on a fibrous, reticulated, horny skeleton. The fleshy mass containing a great number of seed-like bodies in all stages of development, and the horny skeleton permeated throughout with siliceous spicula. When the fleshy mass is examined by the aid of the microscope, it is found to be composed of a number of cells, imbedded in and held together by an intercellular substance.

"In the development of the sponge-cell of *Spongilla*, a set of large granules make their appearance at a very early period, and increase in number and size until they form a remarkable feature. At this time they are about 1-10,000th of an inch in diameter, of an elliptical shape, and of a light amber colour by transmitted light; they are the colour bearing granules or cells, and give the

colour of chlorophyll to this organism when it becomes green. The transparent intercellular substance of *Spongilla* has a polymorphism equally great with the fully developed cells. This, however, can only be satisfactorily seen when the new sponge is growing out from the seed-like body, at which time it spreads itself over the glass in a transparent film, charged with contracting vesicles of different sizes, and in various degrees of dilatation and contraction. How this substance is produced so early, it is difficult to conceive, since it seems to come into existence independently of the development of the sponge-ovules, which are seen imbedded in it, and there undergoing their transformation into sponge-cells. The spicula, too, are developed synchronously with the advancing transparent border, from little glairy globules about the size of the largest ovules, which send out a linear process on each side, and thus gradually grow into their ultimate forms. The only way of accounting for the early appearance of this intercellular-substance is to consider that it is a development from some remnants of the original protoplasm; and perhaps possesses also the power of producing new sponge-cells, as we see the protoplasm in *Vorticella* and the roots of *Chara* producing new buds, independently of the cell-nucleus.

“The cells of the investing membrane are characterised by their uniformly granular composition and colourless appearance. They are nucleated, possess the contracting vesicle singly or in plurality, and are spread over the membrane in such numbers, that it seems to be almost entirely composed of them; while they are of such extreme thinness, and drawn out into such long digitated forms, that they present a foliated arrangement, not unlike a compressed layer of multifidous leaves, ever moving and changing their shapes. The apertures are circular or elliptical holes in the investing membrane in the cells. Through these apertures the particles of food are admitted into the cavity of the investing membrane. The *Parenchyma* consists of a mass of gelatinous substance, in which are embedded the smooth spicules and ovi-bearing cells, and through which pass the afferent and efferent canals. The ovi-bearing cells do not burst and allow their con-



tents to become indiscriminately scattered through the gelatinous mass in which they are imbedded, but each becomes developed separately in the following way:—the ovules and granules of the ovi-bearing cells subside into a granular mass by the former losing their defined shape and passing into small mono-ciliated and unciliated sponge cells; this mass then becomes spread over the interior surface of the ovi-bearing cell, leaving a cavity in the centre, into which the cilia of the monociliated sponge-cells dip and keep up an undulating motion; meanwhile, an aperture becomes developed in one part of the cell which communicates with the adjoining afferent canal, and thus the ovi-bearing cell passes into an ampullaceous spherical sac. The cilia may now be seen undulating in the interior; and if the *Spongilla* be fed with carmine, this colouring matter will not only be observed to be entirely confined to the ampullaceous sacs, but when the *Spongilla* is torn to pieces and placed under a microscope, particles of the carmine will be found in the interior of the mono-ciliated and unciliated sponge cells, proving that of such cells the ampullaceous sac is partly composed. This sac then must be regarded as the animal of *Spongilla*, as much as the Polype-cell is regarded as the animal of the *Polype*, and the whole mass of *Spongilla* as analogous to a *Polypidom*.

“The united efforts of all the ciliated sponge-cells in the ampullaceous sac are quite sufficient to produce a considerable current, and thus catch the particles of food as they pass through the afferent canals. Thus we find *Spongilla* composed of a number of stomachal sacs imbedded in a gelatinous substance permeated with spicules for its support, and an apparatus for bringing them food, as well as one for conveying away the refuse, while the nourishment abstracted by the process of digestion common to Rhizopodous cells (e. g. *Amæba*), no doubt passes through the intercellular gelatinous substance into the general development of the mass; and if right in comparing the ampullaceous sacs to the stomachal cavities of the simplest polypes, are we not further justified in drawing a resemblance between the ciliated sponge-cells and those which line the stomach of *Cordylophora*, of *Otostoma*, and many

of Ehrenberg's *Allotreta*, together with those in the stomach of the *Rotifera* and *Planaria*?

"The 'swarm-spore,' described by M. N. Lieberkühn, appears to be a ciliated form of the seed-like body, and the same as the 'gemmule' described by Grant; but this I have not yet been able to see. The formation of the seed-like body, however, now that we know the structure of the ampullaceous sacs, seems very intelligible, for we have only to conceive an enlargement of the small sponge-cells lining the interior, with the addition of ovules to them respectively, and the spicule-bearing sponge-cells of the cortical substance supplying the spicular crust to the exterior, to have a globular capsule thus composed, with a hilum precisely like the seed-like body—a conjecture which seems to derive support from the fact, that in some instances, when *Spongilla* is beginning to experience the want of nourishment, these sacs, small as they are, assume a defined, rigid, spherical form, from their pellicle becoming hardened and encrusted with extremely minute spicules."<sup>1</sup>

*Clionæ*.—Not the least wonderful circumstance connected with the history of sponges, is the power possessed by certain species of boring into substances, the hardness of which might be considered as a sufficient protection against such apparently contemptible foes. Shells (both living and dead), coral, and even solid rocks, are attacked by these humble destroyers, gradually broken up, and, no doubt, finally reduced to such a state as to render substances which would otherwise remain dead and useless in the economy of nature available for the supply of the necessities of other living creatures.

These boring sponges constitute the genus *Cliona* of Dr. Grant. They are branched in their form, or consist of lobes united by delicate stems; they all bury themselves in shells or other calcareous objects, preserving their communication with the water by means of perforations in the outer wall of the shell. The mechanism by which a creature of so low a type of organisation contrives to produce such remarkable effects is still doubtful, from the great difficulties which lie in the way of coming to any satis-

(1) *Ann. of Nat. Hist.*, July, 1867.

factory conclusions upon the habits of an animal that works so completely in the dark as the *Cliona celata*—it will probably long remain so. Mr. Hancock, to whom we are indebted for a valuable memoir upon the boring sponges, published in the *Annals and Magazine of Natural History*, attributes their excavating power to the presence of a multitude of minute siliceous crystalline particles adhering to the surface of the sponge; these he supposes to be set in motion by some means analogous to ciliary action. In whatever way this action may be produced, however, there can be no doubt that these sponges are constantly and silently effecting the disintegration of submarine calcareous bodies—the shelly coverings, it may be, of animals far higher in organisation than they; nay, in many instances they prove themselves formidable enemies even to living mollusca, by boring completely through the shell. In this case the animal whose domicile is so unceremoniously invaded, has no alternative but to raise a wall of new shelly matter between himself and his unwelcome guest; and in this manner generally succeeds at last in barring him out.

*Skeletons of Sponges.*—The skeletons of sponges, which give shape and substance to the mass of sarcode that constitutes the living animal, is best made out by cutting thin slices of sponge submitted to firm compression, and viewing these slices mounted upon a dark ground, or backed up with black paper.

The skeletons of sponges are composed principally of two materials, the one animal, the other mineral; the first of a fibrous horny nature, the second either siliceous or calcareous. The fibrous portion consist of a network of smooth, and more or less cylindrical, threads of a light-yellow colour, and, with few exceptions, always solid; they frequently anastomose, and vary considerably in size; when developed to a great extent, needle-shaped siliceous bodies termed *spicula* (*little spines*) are formed in their interior; in a few cases only one of these spicula is met with, but most commonly they occur in bundles. In some sponges, as those belonging to the genus *Halichondria*, the same horny kind of material is present in greater or less abundance; but its fibrous structure has become obscure:

the fibres, however, in these cases are represented by siliceous needle-shaped spicula, and the horny matter serves the important office of binding them firmly together, as

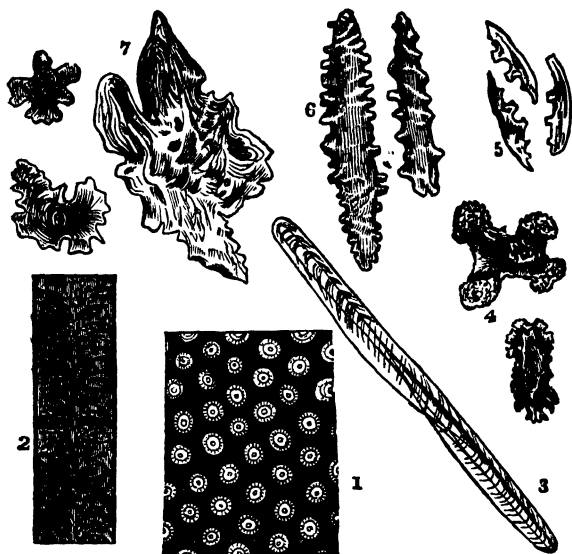

Fig. 215.

1. Transverse section of a branch of *Myriapora*. 2. A section of the stem of *Virgularia mirabilis*. 3. A spiculum from the outer surface of a Sea-pen. 4. Spicula from crust of *Isis hippuris*. 5. Spicula from *Gorgonia elongata*. 6. Spicula from *Acyonium*. 7. Spicula from *Gorgonia umbraculum*.

shown in fig. 213, No. 1. There are, however, some remarkable exceptions to this rule, one, *Dictyochalix pumiocus*, described by Mr. S. Stutchbury, in which the fibrous skeleton is composed of threads of silex quite as transparent as glass; another, the *Hyalonema*, Glass-rope.

The mineral portion, as before stated, consists of spicula composed either of silica or carbonate of lime; the first kind is the most common and likewise most variable in shape, and presents every gradation in form, from the acute or needle-shaped to that of a star. The calcareous spicula, on the contrary, are more simple in their form,

being principally acicular, but not unfrequently branched or even tri- or quad-radiate; the two kinds, the siliceous and calcareous, according to Dr. Johnston, not having hitherto been detected co-existent in any native sponges.

The spicula exhibit a more or less distinct trace of a central cavity or canal, the extremities of which are closed, or hermetically sealed; in their natural situation they are invested by an animal membrane, *sarcode*, which is not confined to their external surface; but in many of the large kinds, as pointed out by Mr. Bowerbank, its presence may be detected in their central cavity, by exposing them for a short time to a red heat, when the animal matter will become carbonised, and appear as a black line in their interior.

Many authors have described the spicula as being crystalline, and of an angular figure, and have considered them analogous to the *raphides* in plants; but it requires no great magnifying power to prove that they are always round, and, according to their size, are made up of one or more concentric layers, as shown in fig. 212, No. 2. The spicula occupy certain definite situations in sponges; some are peculiar to the crust, others to the sarcode, others to the margins of the large canals, others to the fibrous network of the skeleton, and others belong exclusively to the gemmules. Thus, for instance, in *Pachymatisma Johnstonia*, according to Mr. Bowerbank, the spicules of the crust are simple, minute, and fusiform, having their surfaces irregularly tuberculated, and their terminations very obtuse; whilst those of the sarcode are of a stellate form, the rays varying in number from three to ten or twelve.

Silica, however, may be found in one or more species of sponge of the genus *Dysidea*, not only in the form of spicula, but as grains of sand of irregular shape and size, evidently of extraneous origin, but so firmly surrounded by horny matter as to form, with a few short and slightly-curved spicula, the fibrous skeleton of the animal. In these sponges the spicula are of large size, and are disposed in lines parallel with the masses of sand.

Most of the sponges of the earlier geological periods had

tubular fibres ; but in all existing species, with one or two exceptions, they are solid. These tubular fibres are very commonly filled with portions of iron, which accounts for the colour of many of the remains in flint.

The *Moss-agates*, found among the pebbles at Brighton and elsewhere, are flints containing the fossilised remains of sponges. The coloured fibres seen in the *Green-jaspers* of the East are of the same character. There is reason to believe that most flints were originally sponges ; those from chalk even retain their original form. Recent sponges from the Sussex coast present forms precisely similar to some chalk flints, but it is from sections made sufficiently thin to be transparent, for examination under the microscope, that we learn their true nature and origin.

Every horny sponge, whilst living, is invested with a coating of jelly-like substance, which can only be preserved by placing the sponge in spirit and water immediately after its removal from its place of growth. Spicula are not exclusively confined to the body of sponges, but occasionally form the skeleton of the gemmules, and are situated either on the external or internal surface of these bodies. A good example of the former kind occurs in the common fresh-water sponge (*Spongilla fluviatilis*), represented in fig. 216, No. 1, and No. 3. The spicula are very minute in size, and are disposed in lines radiating from the centre to the circumference, the markings on the outer surface of the gemmules being the ends of spicula. In all the young gemmules the spicula project from the outer margin as so many spines ; but in process of growth the spines become more and more blunt, until at last they appear as so many angular tubercles. Turkey sponge (*Spongia officinalis*) is brought from the Mediterranean, has a horny network skeleton rather fine in the fibres, solid, small in size, and light in colour. In some larger specimens there is a single large fibre, or a bundle of smaller ones. In *Halichondria simulans* the skeleton is a framework of siliceous needle-shaped spicula, arranged in bundles kept together by a thick coat of horny matter. Other species of *Halichondria* have siliceous spicula pointed at both extremities—acerate (fig. 212, No. 2) ;

while the spicula of some are round at one end, and pointed at the other—acute; some have spicula round at one end, the former being dilated into a knob—spinulate.

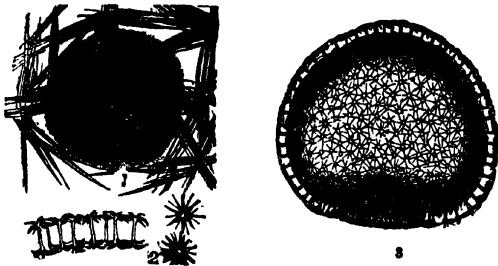

Fig. 216.

1. Gemmule of *Spongilla fluviatilis*, enclosed in spicula. 2. Birotulate spicula, from *Fluviatilis*. 3. Gemmules of *Spongilla fluviatilis*, after having been immersed in acid, to show coating of birotulate spicula.

Among the genus *Grantia*, *Geodia*, and *Levant* sponge, are found spicula of a large size, radiating in three directions—triradiate. In the *Levant* specimen, a central communicating cavity can be distinctly seen. Some *Smyrna* sponges, and species of *Geodia*, have four rays—quadriradiate. Some spicula in *P. Johnstonia* and *Geodia* have as many as ten rays—multiradiate. In some species of *Tethya* and *Geodia* the spicula consist of a central spherical body, from which short conical spines proceed—stellate spicula. (Fig. 212, Nos. 4 and 5.) Spicula having both extremities bent alike—bicurvate—have been obtained from *Trieste* sponge. Some *South Sea* sponges have spicula twice bent, and have extremities like the flukes of an anchor—bicurvate anchorate; sometimes the flukes have three pointed ends. (Fig. 212, No. 6.) The gemmules in fresh-water sponges are generally found in the oldest portions near the base, and each one is protected by a framework of bundles of acerate spicula of the flesh, as shown in fig. 212, No. 9; but in many marine species, *Geodia* and *Pachymatisma*, they are principally confined to the crust. In the fresh-water sponges, the amount of animal matter in the gemmules is considerable; but in

*Pachymatisma*, *Geodia*, and many other marine species, a very small quantity only is ever to be found, the substance of each gemmule being almost entirely composed of minute siliceous spicula; if they be viewed when taken fresh from the sponge, and also after removing the animal matter by boiling in acid, a slight increase in transparency is the only perceptible difference of appearance noticed.

HYALONEMA, "GLASS-ROPE" SPONGE.—A bundle of from 200 to 300 threads of transparent silica, glistening with a satiny lustre like the most brilliant spun glass; each thread is about eighteen inches long, in the middle the thickness of a knitting needle, and gradually tapering towards either end to a fine point; the whole bundle coiled like a strand of rope into a lengthened spiral, the threads of the middle and lower portions remaining compactly coiled by a permanent twist of the individual threads; the upper portions of the coil frayed out, so that the glassy threads stand separate from each other. The spicules on the outside of the coil stretch its entire length, each taking about two and a half turns of the spiral. One of these long needles is about one-third of a line in diameter in the centre, gradually tapering towards either end. The spirally twisted portion of the needle occupies rather more than the middle half of its entire length. In the lower portion of the coil, which is embedded in the sponge, the spicule becomes straight, and tapers down to an extreme tenuity, ultimately becoming so fine that it is scarcely possible to trace it to its termination.

"Many spicules of the awl-shaped and simple cross types, especially short spicules, are met with within the siliceous coil to its very centre, and, in cases where the coil has been brought home without the sponge, such needles can be shaken out from the interstices of the threads. The spicules of *Hyalonema* are marked in their character, and all the forms are found in all specimens of the sponge imbedding the characteristic bundle of enormous spicules; so that there can be no reasonable doubt of the specific identity of the sponge in all cases.

"Within the round apertures on the surface of the



sponge there is usually a brownish orange-coloured membrane, which Schultze found presented the marked characters of a minute parasitic polyp, probably alcyonarian, which inhabited the oscula and their passages during the life of the sponge.

“The glassy wisp of *Hyalonema* is certainly very remarkable, but it is not entirely without analogy. *Hyalonema* seems to represent the extreme form of a little group of sponges, including, with probably a few other forms, *Euplectella* (*Alcyonellum*) *speciosa* (Quoi and Gaimard), and *E. cucumer* (Owen). The last-named is an oval sponge with siliceous spicules, in form and character somewhat like the spicules of *Hyalonema*. From one end of the sponge a tuft of long siliceous threads, resembling in structure those of the Japan sponge, twine round a stone or other foreign body. Dr. Bowerbank isolated one of the spines of *Euplectella*, three inches long.” See *Intellectual Observer*, March, 1867.

#### INFUSORIA.

The term *Infusoria* is applied to a certain class of animals because they were first discovered in water where vegetable matter was decomposing, the infusion was considered necessary for their production. Now, however, it is an established fact, that they are in a healthier state of existence when taken from pure streams and clear ponds than from putrid and stagnant waters. A little bundle of hay, or sage leaves, left for about ten days in a mug containing some pure rain-water, caught before entering a butt, produces the common wheel-animalcules, which are found adhering to the sides of the mug near to the surface of the water. The only use of the vegetable matter seems to be to facilitate in some way the development of the ova of animalcules which find their way into the water. It was at one time thought an indispensable condition that air be admitted to the infusion: but even this element is not absolutely needed in the case of infusorial life; and the appearance of living organisms at all under the circumstances, has been regarded as important evidence in favour of the doctrine of *spontaneous generation*.

The astronomer turns his telescope from the earth, and ranges over the vast vault of heaven, to detect and delineate the beautiful objects of his pursuit. The naturalist turns his microscope to the earth, and in a drop of water finds a wondrous world of animated beings, more numerous than the stars of the milky way; and these he classifies into genera and families, and catalogues in his history of the invisible world.

The *Infusoria* are a mighty family, as they frequently, in countless myriads, cover leagues of the ocean, and give to it a beautiful tinge from their vivid hue. They are discovered in all climes, have been found alive sixty feet below the surface of the earth, and in the mud brought up from a depth of sixteen hundred feet of the ocean. They exist at the poles and the equator, in the fluids of the animal body, and plants, and in the most powerful acids. A brotherhood will be found in a little transparent shell, to which a drop of water is a world; and within these are sometimes other communities, performing all the functions granted them by their Creator, and eagerly pursuing the chase of others less than themselves.

The forms of the *Infusoria* are endless; some changing their shape at pleasure, others resembling globes, eels, trumpets, serpents, boats, stars, pitchers, wheels, flasks, cups, funnels, fans, and fruits.

The multiplication of the species is effected in some by spontaneous division or fission, in others by gemmation or budding, as well as a true sexual process. The first step in the process by which infusorial animals are eliminated, is the formation of globular corpuscles or cells, which, by their aggregation in some cases, and individual evolutions in others, give birth to organisms which subsequently appear.

The *Infusoria* have no night in their existence; they issue into life in a state of activity, and continue the duration of their being in one ceaseless state of motion; their term is short, they have no time for rest and therefore have but one day, which ends only with their death and decomposition. Nevertheless, they appear to love that which promotes life,—the light of heaven; while others, born in the bowels of the earth, never having par-

taken of that blessing, like the ignorant among mankind, find their own contracted round of unenlightened joys, perform their mechanical duties, and expire hidden and, but for the microscope, remained unknown.

On examining the structure of infusorial animalcules, many are seen to have a soft yielding covering, so elastic as to stretch when food or other circumstances render it necessary, returning again to its previous condition as the cause of distension ceases ; these are designated *illoricated*, which signifies shell-less. Others are termed *loricated*, from being covered with a shell, which is beautifully transparent, and flexible like horn. When the delicate and soft substance in which the functions of life perform their allotted duties perishes, the coat that protected it from injury during its hours of existence remains as a token of the past labours of nature ; this covering consists mostly of siliceous material or of lime united with oxide of iron, destructible in some instances either by chemical agents or by fire.

Some of these minute beings have apportioned to them *setæ*, or bristles ; these stiff hairs, attached to the surface of their bodies, do not rotate, but are movable, and appear to be a means for the support of their bodies, as aids in climbing over obstacles that present themselves, or as *feelers*. Others are possessed of *unci*, or hooks, projecting from the under part of the body, which are capable of motion ; and by their means the little animal can attach itself to anything that lies in its way. Some, again, have *styles*, which are a kind of thick bristle, jointed at the base, possessing a movement, but not rotary ; they are in the shape of a cone, large at their base, and delicate at their summit. Many, also, can extend and withdraw their bodies at pleasure, in a similar manner to the snail or leech.

One of the most interesting and important organs possessed by infusorial animalcules is scientifically known by the term *cilium*, which is the Latin word for eyelash, the plural being *cilia*. Its appearance is that of a minute delicate hair.

The cilium is not only useful in the act of progression, but also as an assistance in procuring food ; the two duties

being performed at the same time, the motion of the organs that propels it forward causing a current to set towards the mouth, which carries with it the prey on which the animal feeds. From the cilia being found in the gills of the young tadpole, the oyster, and mussel, it would appear that they are serviceable as organs of respiration, by imbibing oxygen, and emitting the carbonic acid generated in the blood during its circulation through the body; they are also believed to be the medium of taste and touch. It is not only at the mouth, but over the whole body that cilia are discovered; and it is now satisfactorily shown that cilia exist also in the internal organs of man and other vertebrated animals; and are agents by which many of the most important functions of the animal economy are performed. They vary in size from the 1000th to the 10,000th of an inch in length. These minute organs would often be invisible, were it not from the water being coloured when placed under a microscope; then the little currents made by the action of the cilia are easily perceived; and when the water is evaporated, the delicate tracing of their formation may be observed on the glass. They are differently placed, and vary in quantity in the numerous species of *Infusoria*. In some they are in rows the whole length of the body, in others on the base; many have them over the whole of the body; sometimes they fringe the mouth, form bands around projections on the body; and many have but two projecting from the mouth, as long as the body of the creature. Ehrenberg says they are fixed at their base by the bulb moving in a socket, in a similar manner to a man's outstretched arm; and by their moving round in a circle, they form a cone, of which the apex is the bulb. Poison, galvanism applied to the animal, even death, will not immediately stop the motion of the cilia; they continue moving some hours afterwards, even longer than nervous or muscular action can be sustained, until the fluids dry up, and they stiffen.

Very little is known of the muscular attachment of cilia in *Infusoria*; but the motive power must be derived from muscular structure in all. Now in the wheel-animalcules the cilia are in circular rows; and each revolves around

its bulb, giving a singular appearance, seeming to move together like a wheel upon its axle, whence their name *Rotifer*; in a few of these muscles can be traced. The cilia must not be mistaken by the young microscopist for the stiff hairs and bristles found on some, and serving, as before stated, for the purpose of locomotion in crawling or climbing.

If the roof of the mouth of a living frog be scraped with the end of a scalpel, and the detached mucous membrane placed on a glass slide, and examined with a power of 300 diameters, the ciliated epithelium-cells will be well seen. When a number of these are collected together, the movement is effected with apparent regularity; but in detached scales it is often so violent, that the scale itself is whirled about in a similar manner to an animalcule provided with a locomotive apparatus of the same description, and has frequently been mistaken for such. The animals commonly employed for the examination of the cilia are the oyster and the mussel; but the latter are generally preferred.

To exhibit the movement to the best advantage, the following method must be adopted:—open carefully the shells of one of those molluscs, spilling as little as possible of the contained fluid; then with a pair of fine scissors remove a portion of one of the gills (*branchiæ*); lay this on a slide, or the tablet of an animalcule cage, and add to it a drop or two of the fluid from the shell; by means of the needle-points separate the filaments one from the other, cover it lightly with a thin piece of glass, and it is ready for examination. The cilia may then be seen in several rows beating and lashing the water, and producing an infinity of currents in it. If fresh water instead of that from the shell be added, the movement will speedily stop; hence the necessity of the caution of preserving the liquid contained in the shell. To observe the action of any one of the cilia, and its form and structure, some hours should be allowed to elapse after the preparation of the filaments as above given, their movements then will have become sluggish. If a power of 400 diameters be used, and that part of the cilia attached to the epithelium scale carefully watched, each one will be found to revolve a

quarter of a circle, whereby a "feathering movement" is effected, and a current in one direction constantly produced. In the higher animals, the action of the cilia can only be observed a very short time after death. In a polypus of the nose, when situated at the upper and back part of the Schneiderian membrane, the cilia may be beautifully seen in rapid action some few hours after its removal; but in the respiratory and other tracts, where ciliated epithelium is found, it would be almost impossible ever to see it in action, unless the body were opened immediately after death. In some animals it may be seen in the interior of the kidney, as first made known by Professor Bowman in the expanding extremity of the small tube surrounding the network of blood-vessels forming the so-called Malpighian body. In order to exhibit the ciliary action, the kidney should have a very thin slice cut from it; and this is to be moistened with the serum of the blood of the same animal. The vascular and secreting portions of the organ may then be seen with a power of 250 diameters, and also the cilia in the expanded extremity of each tube, as it passes over to surround the vessels; the epithelium of the tubes themselves is of the spheroidal or glandular character.

The infusorial and invisible atoms of life have various periods allotted to them for the enjoyments of existence; some accomplish their destiny in a few hours, others in a few weeks. The watchful devotee in this branch of science has traced an animalcule through a course of existence extending to the old age of twenty-three days. The vital spark flies instantaneously in general; but in those of a higher organisation there is a spasmodic convulsion, as if the delicate and intricate machinery rendered life so exquisite, that the parting with the "heavenly flame" was reluctant and painful. The most surprising circumstance attendant on the nature of some of the *Infusoria* is that of apparent death. When the water or mud in which they have sported in the fulness of buoyant health becomes dried up, they lie an inanimate speck of matter; but after months, nay, years, a drop of water being applied, their bodies will be resuscitated, and in a short time their frames become active with life. Leeuwenhoek kept some in a hard and dry condition,

and restored them to life after a sleep of more than twenty-one months. Professor Owen saw an animalcule that had been entombed in a grave of dry sand four years reborn to all the activity of life. Spallanzani tried the experiment of alternate life and death, and accomplished it in some instances on the same object *fifteen* times, after which nature was exhausted, and refused further aid in this miraculous care of those minute objects of her wonderful works.

Naturalists consider the phosphoric light of the marine animalcule to be the effect of vital action. The sparks are intermittent like the fire-fly, and measure from the 12,000th to the 100th of an inch in size. Captain Scoresby found that the broad expanse of waters at Greenland was nearly all discoloured by animalcules, and computed that of some species one hundred and fifty millions would find ample room in a tumbler of water. The phosphorescence of the sea is eloquently portrayed by Darwin, in his *Voyage of the Beagle*. Mr. Gosse thus describes the luminous appearances presented by a closer inspection of these minute animalcules: "Some weeks afterwards I had an opportunity of becoming acquainted with the minute animals, to which a great portion of the luminousness of the sea is attributed. One of my large glass vases of sea-water I had observed to become suddenly at night, when tapped with the finger, studded with minute but brilliant sparks at various points on the surface of the water. I set the jar in the window, and was not long in discovering, without the aid of a lens, a goodly number of the tiny jelly-like globules of *Noctiluca miliaris* swimming about in various directions. They swam with an even gliding motion, much resembling that of the *Volvox globator* of our fresh-water pools. They congregated in little groups, and a shake of the vessel sent them darting down from the surface. It was not easy to keep them in view when seen, owing rather to their extreme delicacy and colourless transparency than to their minuteness. They were, in fact, distinctly appreciable by the naked eye, measuring from 1-50th to 1-30th of an inch in diameter." *Noctiluca miliaris* belongs to the highest class of the *Protozoa*, and with a power of about 200 diameters they are seen

of various forms and stages of growth, represented in fig. 217.<sup>1</sup>

Ehrenberg included in his family of Infusoria, Rhizopoda, Unicellular, and other Algæ, embryonic forms, and Rotifers. Most naturalists, however, now admit that the

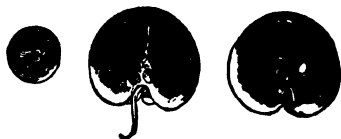

Fig. 217.—*Noctiluca miliaris*.

organization of the Rotiferæ is of a far higher nature than had been suspected by Ehrenberg; and some assert that their proper place in the classification of animals is the annulose sub-kingdom; the true nature of many of the Infusoria is still a disputed question. In outward form they may be said to vary almost indefinitely; but anatomically their bodies should be regarded as consisting of three distinct structures. The cuticle or integument ("pellicula" of Carter), on which are borne the cilia and other locomotive apparatus; the cortical layer or parenchyma of the body ("diaphane" of Carter); and the chyme mass, occupying the abdominal cavity, or interior of the body (sarcode or "abdominal mucus" of Carter), within which the particles of food rotate. The term "ventral" is usually applied to that side of the body on which the mouth is placed.

In the well-known *Paramecium* we have the true and most widely distributed type of the Infusoria. The general structural character of this minute animal is common to the species; indeed, its structural features may be accepted as a fair definition of the whole group. The *Paramecium* is surrounded on its external covering by cilia, which are constantly in action, and enable it to move about in its watery element in a most remarkably active manner. At one point the body appears to be slightly

(1) See Gosse's *Naturalist's Rambles*: Huxley, *Micro. Journal*, 1855



constricted, and here is a slit seen which opens into a little funnel-shaped cavity, leading to the gullet and stomach. The outer or cortical layer is composed of a denser material, which indicates a differentiation into cellular layers, while the internal substance is evidently composed of sarcode which exhibits, at two points in particular, the power of contracting and dilating : a process available both for the expulsion of digested food, and for aëration of the circulatory system. The whole systemic arrangement should be regarded as the very simplest form of respiratory and secretory mechanism. The several circular transparent bodies seen in the interior of these animals led Ehrenberg to denominate the group "*Polygastrica*" (many stomached). The remarkable powers of multiplication by fission and germination, as well as by a true sexual process, which these creatures exhibit, have attracted the attention of all observers ; within the last few years, Müller, Balbiani, Stein, and others, have shown that the sexual organs of such animals as *Paramæcium* are those bodies which have hitherto been simply regarded as the "nucleus," and "nucleolus ;" and ultimately it was seen that the Infusoria have a life history as wonderful as that of the higher classes of animals. Although Ehrenberg was the first to call attention to the importance of the "nucleus" in the reproductive process, it is to the observations of Balbiani that we are indebted for an explanation of its importance in the generative function : his investigations also derive additional interest from the very complete manner in which they have been carried out. As an instance, he states that in his examinations of *Paramæcium aureliæ*, he could not look upon them as conclusive until he had succeeded in extracting uninjured some of the eggs from the parent body, and had subjected them to the action of the surrounding water, when he saw each egg resolve itself into two portions, the smaller being enclosed within the larger ; then by employing re-agents, acetic acid and iodine, he produced the changes more rapidly ; and in this way again and again obtained abundant proofs of the truth of each observation. So much then for Dr. Balbiani's researches on the phenomena of reproduction among the Infusoria, which have added much valuable

information to our former meagre knowledge of these interesting forms of organic life.

Some Infusoria undergo a process of encystation before reproduction by fission; that is, they become coated with a secretion of gelatinous matter, which gradually hardens so as to enclose the body in a "cyst." According to Stein, the process of encystation is sometimes followed by a remarkable succession of phenomena, such as have been observed to occur in the case of *Vorticella microstoma*. An old *Vorticella* loses or retracts its cilia, becomes encysted, and finally drops off its stalk. The cyst may either burst and discharge its contents, or become wholly changed into an *Acineta*-form body. The latter may subsequently develop a foot-stalk, assume the appearance of a *Podophyra*, or even that of the *Acineta tuberosa*, Plate III. No. 68. In either case, the band-like nucleus becomes transformed into a peculiar ovate body, somewhat like Nos. 71 or 73, the narrow end of which is provided with a circlet of vibratile cilia, and a mouth leading into an internal cavity, with a contractile vesicle in its interior. Relations, somewhat similar to those which connect *Vorticella* and *Acineta*, have been stated to exist between other families, as *Aspidisca* or *Trichoda*, and *Oxytricha*, Plate III. No. 71.

**BACTERIA.**—The remarkable complex bodies bacteria or bacilli, are amongst the most minute forms of organic life with which the microscope has to deal. It has been conclusively shown that bacteria are productive of various kinds of ferments and diseases in the animal body. They require for their development a free supply of oxygen, and they thrive best in albuminoid fluids. Whether decomposition of albuminoid matters is directly occasioned by their life processes, or whether they generate a ferment which induces fermentation, is not positively known. It is quite clear however, from the investigations of Pasteur, Cohn,

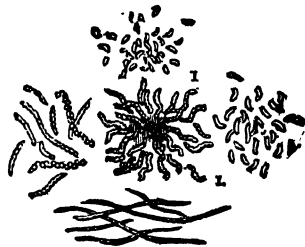

FIG. 218.—Bacteria of various forms.

Tyndall, and others, that bacteria are present in certain ferments, whether of a putrid, lactic, acid, fatty, or viscous nature. The consequence is that they have a high amount of interest for the medical profession, the microscopist, and the sanatarian.

Bacteria can be at any time readily developed by infusing a small piece of fresh beef in water, or by adding the fibrine of blood of an animal to water, and letting the solutions stand by in a warm place for about four-and-twenty hours. Certain forms of bacteria exhibit greater signs of vitality in dark moist places, and they are almost invariably found in all river-waters polluted by sewage, and in waters in any way contaminated by animal refuse.

Monads vary in colour, some are red, green, or yellow, others nearly colourless. In shape they are round or oval (5 and 6, fig. 226), are very active, and are furnished with one or more flagella.

VIBRIO.—*Vibriones*.—In this family Ehrenberg oddly enough includes eels in paste and vinegar.

*Vibrio spirilla*, *Trembling animalcules*, are now classed among bacteria, and are claimed by the botanist; when exerting the powers of locomotion they take a spiral form, like the threads of a fine screw, and by undulations wind themselves through the water with rapidity. They are almost invariably found in decaying acetous and putrefying organic matters. When treated with iodine and sulphuric acid, their jointed structure becomes visible to the highest powers of the microscope.

ASTASIAÆ.—*Astasia*, signifying without a station, in contradistinction to those living in groups, is the term given to a kind of crimson-coloured animalcule, the 350th of an inch in length, that exist in enormous numbers, and give the waters in which they live the appearance of their bodies. Ehrenberg described several varieties of them.

EUGLENA.—The *Euglenæ* of Dajardin in some respects correspond with the *Astasiæ* of Ehrenberg; while other observers refer *Euglenæ* to the vegetable and *Astasiæ* to the animal kingdom. The euglena, like bacteria, are

found in sewage water, they are free, and furnished with flagellæ; ova are perceptible in *Astasia hæmatodes*, and probably exist in other species. From their varying colour, their apparent changes of form, and the rapidity of their motions, they are most interesting objects under the microscope. The immense number in which these Infusoria are sometimes developed in a few days, and the blood-red colour they impart, have frequently been the cause of alarm and anxiety to persons residing in the vicinity of ponds which have become coloured by their swarming. Ehrenberg describes a species of Euglena, *E. sanguinea*, and he conjectures that the miracle in Egypt, recorded by Moses, of turning the water into blood, might have been effected by the agency of these creatures. Very lately, Mr. Sheppard<sup>1</sup> met with another specimen, probably belonging to this family, adhering to the submerged stones in a clear spring, between Ashford and Maidstone. His specimens were taken home in a piece of glazed paper, and upon opening them he found the paper "stained with hues of red, blue, and purple;" and the whole "resembling clots of red jelly, or recently coagulated blood." Upon placing a small quantity on a glass slide for viewing under the Microscope, "the colour appeared to be opaque-red, looking like a small quantity of vermilion mixed with the water; but when held up to the light the red disappeared, and a pale transparent blue took its place."

Believing this colour to depend upon the presence of albumen mixed with the animal organisms, Mr. Sheppard placed a small quantity of the jelly-like substance in contact with some white of egg diluted with water; and "soon the whole became converted into magenta dye," the solution exhibiting the same colouring properties, namely, that of reflecting from its surface all the red and yellow rays, and transmitting the blue and violet." Mr. Browning, upon submitting specimens to the micro-spectroscope, found that it gave a very marked band in the red-ray. The whole spectrum is, indeed, very remarkable, and, writes

(1) "An example of the production of a coloured fluid possessing remarkable qualities by the action of monads (or some other microscopic organism) upon organised substances." By J. B. Sheppard, M.R.C.S. — *Trans. Micros. Soc.* July, 1867, p. 64.

Mr. Sorby, "it is the only blue solution in class C (of which blood is the type) that gives this particular spectrum." The fluid emits a most pungent and disagreeable odour when the bottle in which it is kept is uncorked.

The common form of the *Euglenæ* is represented in Plate III. No. 67, *a* contracted, *b* elongated. *Oxytricha* are larger and the body more elongated; their movements are more impulsive, alternately creeping, running, and climbing. In all the species digestive vacuoles are evident; and they multiply by self-division, as well as ova. Ehrenberg counted ten cilia anteriorly, and four or five setæ posteriorly. The species is found both in fresh and brackish water. Plate III. No. 70, represents a side view of *O. gibba*, No. 71, *O. Pellionella*. In the genus *Glaucoma*, Nos. 73 and 74, Ehrenberg saw "indications of an alimentary canal." Dujardin places *Glaucoma* among *Paramæcia*; the body is oval and covered with cilia; mouth large, with vibratory valves; increase takes place by self-division. A re-examination of all the enumerated species of Infusoria is quite necessary before we can come to any safe conclusion as to their true affinities, especially as many appear to be only larval forms of life.

"The question of how far individuals belonging to the same species may vary is one more intimately connected with that department of Zoology which treats of the distribution of animals than their development. For it can be readily shown that animals are capable of becoming modified to an indefinite extent by the physical conditions under which they are placed, and, indeed, that one species may be, so to speak, made to pass into that of another; so that many of the apparently dissimilar animal forms found on the earth may be more correctly viewed as varieties of the same species, the differences between them being due to the external agencies to which each has respectively been subjected."

The remarkable manner in which the Infusoria make their appearance in fluids, and the seeming inexplicable phases in their existence, led some early observers to start a "spontaneous generation" theory of life; but the researches of M. Pasteur and others have completely exploded this view of the formation of living organisms. The order

in which these minute creatures appear in vegetable infusions has been made the subject of careful inquiry. Mr. Samuelson, whose researches on this point were carried on in conjunction with Dr. Balbiani of Paris, and confirmed by him, he found when a carefully prepared infusion of vegetable matter in distilled water is exposed to the air, the *Protozoa* which first appear in it are *Amœbæ*: these in a few days disappear, and are succeeded by ciliated infusoria, such as *Kolpoda*, *Cyclidium glaucoma*, and sometimes *Vorticella*, and these in their turn by what we have looked upon as higher forms, *Oxytrichum*, *Euplotes*, *Kerona*, &c. Mr. Samuelson thinks that *Monads* are but the larval condition of the ciliated infusoria, and he noticed the constant occurrence of *Monads* belonging to the species *Circomonas fusiformis*, or *acuminata* of Dujardin, &c., in pure distilled water after a certain exposure to the air, and this without the previous admixture of vegetable matter of any kind in the water. The same results were obtained upon shaking rags, from various and distant parts of the world, over the distilled water; in all cases in about three weeks he invariably obtained forms of ciliated infusoria. The fusiform body of the *Circomonas* bears a long whip-like cilium at its anterior end, and a short seta at its caudal extremity: this finally drops off, and when exposed to excessive heat and light, it is transformed into an Amœbiform animal.

Mr. Samuelson's results do not very materially differ from my own, save in one or two particulars. The succession of generations do not take quite the same course, and the animal and vegetable bodies generally appear simultaneously, or so soon after each other that it is at times difficult to decide the priority of appearance; but our experiments have been chiefly confined to collections of rain and distilled water, *without* the addition of vegetable matter of any kind. I am, however, of his opinion as to the very extensive distribution of these infusorial germs, and their great tenacity of life. With regard to the supposed purity of rain-water, at no time can it be taken without the numerous matters floating in the air being brought down with it; and, consequently, within a few hours after it is caught, *Protococcus pluvialis*, *Amœba*, and *Circomonas* may always be found in vast numbers. It is somewhat

remarkable that the purest snow-water, caught in a clear glass vessel, and allowed to remain well corked, will, in the course of two or three weeks, be found to contain *Amœba* and *Circomonas*, but it rarely presents other forms of animal life; the vegetable matter then completes its growth very slowly, gradually passes to *Confervæ*, and for a time no other change is seen to take place; so that it is painfully apparent that the atmosphere in which we live and move and have our being is something more than a mixture of gases, as apparently determined by chemical analysis.

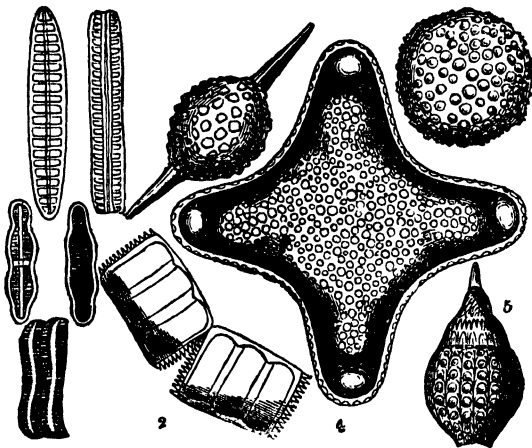

Fig. 219.

1, *Achnanthisdium coarctatum*. 2, *A. lineare*. 3, *Tryblionella gracillia*. 4, *Amphitetras antediluviana*. 5, 6, and 7, *Orthostira spinosa*. Front view, with globular and oval forms. (Fossil Infusoria from Springfield, Barbadoes.)

Ehrenberg's "*Polygastric Infusoria*" have indeed undergone a complete revision: some have been degraded to the vegetable kingdom, as the *Desmidiaceæ*, *Volvocineæ*, &c., whilst others have been advanced a step higher in the animal series; none having received so much attention from microscopists, or excited so much controversy, as the *Desmidiaceæ* and *Diatomaceæ*. The first of these we have already disposed of in our remarks on the vegetable kingdom, where we must be content to leave them for the present;

not so the *Diatomaceæ*, which offer many interesting natural characteristics of sufficient importance to warrant our keeping them in the animal division. They are most striking objects under the microscope, from the very peculiar beauty and variety of their forms, and from their bilateral symmetry, external markings, and indestructible siliceous skeletons; so that we believe they would be more correctly placed in a median, or *Molluscan sub-kingdom*. Appearing everywhere with the first-born of life, and wherever matter is found in a condition fit for their development and nourishment, these marvellous indestructible creatures have been preserved and brought down to us, in forms unchanged, from the remotest periods of our globe's history; and supplying, as they do to the microscopist, some of the most valuable test-objects,—the *Gyrosigma*, *Grammatophora*, *Fragilaria*, *Ripidophora*, *Pleurosigma angulatum*, with many others,—it cannot be a matter of surprise that considerable attention should have been directed to them, and an earnest inquiry instituted into their nature and structure.

“Comparing,” says Kützing, “the arguments which seem to indicate the vegetable nature of *Diatomaceæ* with those which favour their animal nature, we are of necessity led to the latter opinion. If we suppose them to be plants, we must admit every frustule, every *Navicula* to be a cell. We must suppose this cell with walls penetrated by silica, developed within another cell of a different nature, at least in every case where there is a distinct peduncle, or investing tube. In this siliceous wall we must recognise a complication certainly unequalled in the vegetable kingdom. It would still remain to be proved that the eminently nitrogenous internal substance corresponded with the generic substance, and that the oil globules could take the place of starch. The multiplication would be a simple cellular reduplication; but it would remain to be proved that it takes place, as in other vegetable cells, either by the formation of two distinct primitive utricles, or by the introflexion or constriction of the wall itself. Finally, there would still remain unexplained the external motions and the internal changes; and we must prove the accumulated observations on the



exterior organs of motion to be false, by a clearer line of argument than has hitherto been adopted by those who are opposed to this view. But again, admitting their animal nature, much would remain to be investigated, both in their organic structure and their vital functions; excepting this, so far as we know, we have only one difficulty to overcome, that of the probably ternary non-azotised composition of the external gelatinous substance of the peduncles and investing tubes. But as the presence of nitrogen is not a positive character of *animal nature*,

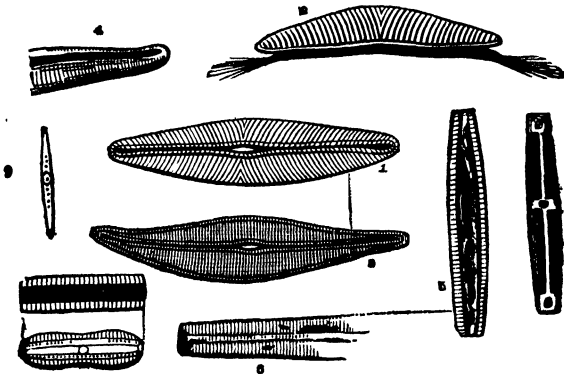

Fig. 220.

1, *Cymbella Ehrenbergii*. 2, Side view of the same, showing an arrangement of the sarcodes and pseudopodia. 3, *Pleurosigma lanceolatum*. 4, Lateral view of a portion of the same. 5, 6, and 7, *Pinnularia*. 8, *Diatoma vulgare*. 9, *Nitzschia varvula*.

so the absence of it is not a proof of *vegetable*. And, in order that the objection should really have some weight, it would be well to demonstrate that this substance is isomeric with starch. For then, supposing all the arguments in favour of the animal nature of *Diatomaceæ* were proved by new and more circumstantial observations, this peculiarity, if it deserve the name of objection, might still be regarded as an important discovery. We should then have in the animal, as well as in the vegetable kingdom, a ternary substance similar to that forming the bases of the vegetable tissue."

*Diatomaceæ*, brittleworts, siliceous *Bacillaria*, are organisms composed of two symmetrical plates or valves, narrow or wand-like, navicular—as a miniature boat or “little ship;” hence their name, *Navicula*. A rectangular or prismatic figure is, however, the typical form of this family, and the angles of junction of the valves are as a rule, acute. Deeply notched frustules, such as we see in the Desmids, *Micrasterias denticulata*, *Docidium pristidæ*, Plate II. Nos. 30 and 31, do not occur, and the production of spines and tubercles is rare among the Diatoms. Each individual Diatom is enclosed by a soft organic matter (sarcode); the internal portion is yellowish or orange-brown in colour. In the discoid forms two portions are commonly distinguishable, viz. the disc and margin—or rim, and these present different markings, with an occasional central prominence, called an *umbo* or boss. Great variety of outline may prevail in a genus, so much so, that no accurate definition can be safely laid down: thus in the genera *Navicula*, *Pinnularia*, the frustules are in one aspect boat-shaped, and in another oblong with truncated ends, prismatic. Mr. Brightwell thus describes and explains the transitions of form produced by a change in position of the frustules of the genus *Triceratium*.<sup>1</sup> “The normal view of the frustule may be represented by a vertical section of a triangular prism. If the frustule be placed upon one of its flat sides, we look down upon its ridge and obtain a front view of its two other sloping sides. If it be placed upon one of its ridges, we have a front view of one of its flat sides, generally broader than long, and of its smooth or transparent suture or connecting membrane. If the frustule be progressing towards self-division, it is then often considerably longer than broad, and when nearly matured for separation, presents the appearance of a double frustule.” So with re-

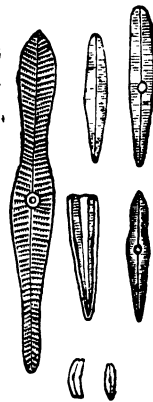

Fig. 221.—*Gomphonema elongatum* and *capitatum*.

1) *Journ. Microsc. Soc.* vol. I. p. 248.

ward to the beautiful *Surirella constricta*, the side view is no longer bacillar, but the breadth of the valve is very considerable, and when about to undergo subdivision it becomes square-shaped. The distinctive character, however, of this genus, in addition to the presence of canaliculi, is derived from the longitudinal line down the centre of each valve, and the prolongation of the margins into "alaë." The sudden change in appearance presented to the eye as the frustule is seen to roll over, is very remarkable. As a rule, therefore, we must examine all specimens in every aspect, to accomplish which very shallow cells should be selected, say of 1-100th of an inch deep, and covered with glass 1-250th of an inch thick. A good penetrating objective must be used, and careful illumination obtained. The examination of living specimens should be conducted during very bright weather, the mirror directed towards a white cloud, or even sunlight: with coloured glasses to protect the eyes from injury. The Diatomaceæ are perhaps more widely distributed than any other class of infusorial life; they inhabit fresh, salt, and brackish water; many grow attached to other bodies by a stalk (Plate II. No. 33), *Licmophora* and *Achnanthes*; while others, as the *Pleurosigma*, No. 40, swim about perfectly free in the water.

There are a considerable number of Diatomaceæ which, while in the young state, are enclosed in a muco-gelatinous sheath; while others are attached by a stipes or stalk to Algæ. Ehrenberg recognised a tribe of compound Diatoms, with a double lorica, and introduced them into his great family of *Bacillaria*, under the name of *Lacernata* or *Navicula*. Siliceous enters largely into the composition of their valves, but, being in combination with organic substances, it does not depolarize light. In several genera siliceous is very deficient, and the wall of the frustule of great delicacy. Mr. Brightwell, speaking of the lorica or siliceous covering of the *Triceratium*, states "that the valves are resolvable into several distinct layers of siliceous, dividing like thin divisions of talc, and frequently of such exquisite delicacy as to be difficult of detection." Nägeli speaks of a mucilaginous pellicle on the inside of the organic layer as a sort of third tunic; and, as Meneghini

truly observes, "An organic membrane ought to exist, for the silica could not become solid except by crystallizing or depositing itself on some pre-existing substance." The surface of the frustules is generally very beautifully sculptured, and the markings assume the appearance of dots (*puncta*), stripes (*striæ*), ribs (*costæ*), pinnules (*pinnæ*), of furrows and fine lines; longitudinal, transverse, and radiating bands; canals or canaliculi; and of cells or areolæ; whilst all present striking varieties and modifications in their form, character, and degree of development. Again, the fine lines or *striæ* of many frustules are resolvable into rows of minute dots, such as occur in *Pleurosigma*, &c.

The nature of the markings on the Diatom valves is one of considerable interest, and has excited much attention, and attempts have been made to produce them artificially. On the addition of sulphuric acid to a mixture of powdered fluor spar and sand, an immediate evolution of fluoride of silicon takes place, as is shown by the white fumes. This whiteness is due to the presence of minute particles of silex arising out of the decomposition of the fluoride by the moisture contained in the atmosphere; and if a solid body be exposed to these vapours, a portion of the silex will be deposited on it, in the form of a fine white powder, con-

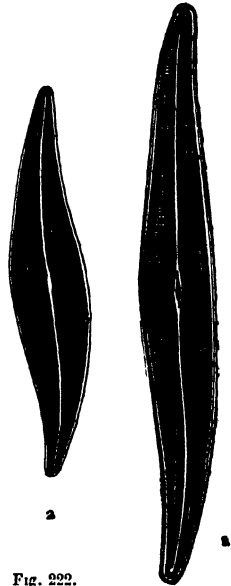

Fig. 222.

1, *Pleurosigma attenuatum*. 2, *Pleurosigma angulatum*, magnified 250 diameters. 3, *Pleurosigma Spencerii*, imperfectly shown.

sisting of thin walled vesicles filled with air. If some of the deposit be crushed between two pieces of glass, and examined with a power of about 300 diameters, a marking will be perceived on the outer or convex surface of many of these vesicles, similar to that of many Diatomaceæ, such as *Pleurosigma*, *Coscinodiscus*, &c. Rounded elevations, more or less hexagonal at the base, and more or less regularly arranged, cover the surface of the siliceous pellicle, and not unfrequently this kind of marking is so regular as to give the fragments exactly the appearance of portions of diatomaceous valves.

This remarkable circumstance attracted the attention of Professor Max Schultze, who devoted a great deal of time to the investigation of the subject, and has recorded in a voluminous paper<sup>1</sup> the results of his observations. He says, "The appearances presented under the microscope by the siliceous pellicles were such as to suggest that they were due possibly to crystallisation. The minute elevations on the surface, when viewed on the side, often appear sharply acuminate, so as readily to convey the impression that they are formed by minute crystals of siliceous acid; and this impression is strengthened at first sight by their sharply defined hexagonal basis, when viewed vertically. The circumstance, again, that these elevations are sometimes rounded at the summit and circular at the base, might be attributed to the accidental interference of free hydrofluosilicic acid, &c. But experiments to eliminate the action of this agent showed that it had nothing to do with the variety of appearance in the elevations.

"Most of the species of the diatomaceæ are characterised by the presence on their outer surface of certain differences of relief, referable either to elevations or to depressions disposed in rows. The opinions of microscopists with respect to the nature of this marking are divided. Whilst in the larger forms, and those distinguished by their coarser dots, the appearance is manifestly due to the existence of thinner spots in the valve, we can not so easily explain the cause of the striation or punctation in *Pleurosigma angulatum* and similar finely-marked forms.

(1) "Verhandl. d. Natur Hist. Vereins der Preussisch. Rheinland, u. Westphal." *Jahr xx*, p. 1. *Microsc. Jour. Science*, vol. iii. p. 120.



The accompanying illustration is drawn from a photograph of *Frustulia Saxonica*,—one of the most difficult of the "Probe Platte," Möller's balsam-mounted diatoms, resolved by a Tolles'  $\frac{1}{10}$  duplex front immersion objective. The longitudinal lines as well as the transverse are well seen over the greater part of the frustule. The measurement of the transverse lines given by Mr. Wells, is 88,001 inch. Professor Morley puts them at 81.5 to 82,001 inch. The midrib and margin of the diatom are quite thick, and, consequently, when very oblique light is used, they produce diffraction phenomena, and which, in some instances, obliterate the whole of the markings. The frustule, however, in this instance is mounted in balsam, and the lines are therefore fainter than they would be if mounted dry. The kind of illumination employed by the photographer was Wenham's reflex illuminator. The beaded appearance of the surface is much better seen in the photograph than in the woodcut.<sup>1</sup>

*Movements of Diatoms.*—The researches of Professor Max Schultze, of Bonn, published 1865, appear to throw some light on the vexed question of the movements of the

*Frustulia Saxonica* ( $\times 1,800$  diameters) from Möller's balsamed Probe-Platte. From a photograph

(1) *The English Mechanic*, July 23, 1860.

by Mr. S. Wells, of Boston, U.S.A.

*Diatomaceæ*. This author is of opinion that a sarcode substance envelopes the external surface of the diatom, and its movement is due to this agent exclusively. He prefers the *P. angulatum*, Plate II. No. 38, for examination to the larger *P. balticum*, because the transverse markings on its frustule do not impede to so great an extent the observation of what is going on within. When you have a living specimen of *P. angulatum* under the microscope, it always has its broad side turned to view, with one long curved "raphe" uppermost, and the other in contact with the glass on which it is placed; at the central part is seen the thickened "umbilicus," Plate 2, No. 40. Within the siliceous frustule is the yellow colouring matter, or "endochrome," which fills the cavity more or less completely, and is arranged in two longitudinal masses, to the right and left of the raphe. In the broader part of the frustule these bands of endochrome describe one or two complicated windings. It is only possible in those specimens in which the bands are narrow properly to trace their foldings, and ascertain that only two exist, since an examination of frustules richer in endochrome has led to the impression that there are three or four of these bands. "The next objects which strike the eye on examining a living *Pleurosigma* are highly refractive oil-globules. These are four in number; one pair near either end of the the Diatom. They are not, however, all in the same place, one globule of each pair being nearer the observer than the other; their relative position is best seen when a view of the narrow side of the frustule can be obtained, so that one raphe is to the left and the other to the right. The blue-black colour, which is assumed by these globules after the Diatom has been treated with hyperosmic acid, demonstrates that they consist of oleaginous matter. The middle of the cavity of the frustule is occupied by a colourless finely granular mass, whose position in the body is not so clearly seen in the flat view as in the side view. Besides the central mass, the conical cavities at either end of the siliceous shell are seen to be filled with a similar granular substance, and two linear extensions from each of the three masses are developed, closely underlying that part of the shell which is beneath the raphæ; so that

in the side view they appear attached to the right and left edges of the interior of the frustule. This colourless granular substance carries in its centre, near the middle part of the Diatom, an imperfectly developed nucleus which it is not very easy to see, but may be easily demonstrated by the application of acid. The colourless substance is what, in other Diatoms, Schultze shows to be Protoplasm, or vegetable sarcode, and which contains numerous small refractive particles; on adding a drop of a one per cent. solution of osmic acid these became blue-black, and proved to be fat. It is, however, exceedingly difficult to determine the exact limitations of the protoplasm, on account of the highly refractive character of the siliceous skeleton, and the obstruction presented by the endochrome.

After a short distance, the protoplasm reappears, and is contracted into a considerable mass within the conical terminations of the frustule. Schultze observed in this part of the protoplasm a rapid molecular movement such as is known to occur in the *Closterium*, and further, a current of the granules of the protoplasm along the raphe. *Pleurosigma angulatum* "crawls," as do all Diatoms possessing a raphe, along this line of suture. To crawl along, it must have a fixed support. He believes free swimming movements are never to be observed in this or in any other Diatom. Accordingly, Schultze invariably found that the raphe is in contact with either the glass slip or the glass cover, between which the Diatom is placed, or is in apposition with some foreign body of considerable size. Schultze repeated the experiments of Siebold, and observed, as he and also Wenham had done long before, that particles of foreign matter stick to the raphe as though it were covered with some glutinous material, and are carried slowly along by the action of a current. This he observed in many Diatomaceæ, and found invariably that foreign particles adhered only to the raphe, or what corresponded to it. "There is obviously," says Schultze, "but one explanation; it is clear that there must be a band of protoplasm lying along the raphe, which causes the particles of colouring matter to adhere, and gives rise to a gliding movement. For there is but one phe-



nomenon which can be compared with the gliding motion of foreign bodies on the Diatomaceæ, and that is, the taking up and casting off of particles, by the pseudopodia of the rhizopod, as observed, for instance, on placing a living *Gromia* or *Miliolina* in still water along with powdered carmine. The nature of the adhesion and of the motion is in both cases the same in all respects. And since, with Diatoms as unicellular organisms, protoplasm forms the principal part of the cell body (in many cases two distinctly moving protoplasms), everything suggests that the external movements are referable to the movements of this protoplasm." It is quite evident to those who have studied the movements of the Diatoms that they are surrounded by a sarcode structure far more delicate in its character than that of the *Amœba*. Six years before Schultze's observations were published, the fact appeared in a third edition of this work, page 307; therein it is stated that "The act of progression rather favours the notion of contractile tentacular filaments,—*pseudopodia*,—as the organs of locomotion and prehension. The hyaline or sarcode covering is of so transparent a nature that as yet no microscopic power has enabled us to assign its precise boundary and attachments.<sup>1</sup> Some observers would deny a membranaceous (hyaline) covering of any kind to Diatoms, which we have certainly seen." Professor Smith, of America, has satisfactorily traced a sarcode covering in *Pinnularia*. The defining power, penetration of the objective, and mode of illumination, is everything in such investigations.

It was in 1841 Messrs. Harrison and Sollitt, of Hull, discovered the beautiful longitudinal and transverse *strice* (groovings) on the *Pleurosigma hippocampus*. A curved graceful line runs down the shell, in the centre of which is an expanded oval opening. Near to the central opening

(1) Referring to the strength and vigour of the movements of the *Diatomaceæ*, Dr. Donkin (*Quart. Jour. Mic. Sci.* vol. VI. new series, p. 26), observed a species *Bacillaria cursoria*, discovered by himself, push away "*A. arenaria*, a species at least six times their own size;" and Mr. Barkas states that he has seen them "push away particles of foreign matter, and that with the greatest apparent ease, at least one hundred times larger than all the frustules combined; and what is more remarkable still, is that they not only push the accumulated particles away when they are in their direct line of motion, but, if they merely touch them in passing, they drag them after them as though they were literally held by some magnetic attraction, or strong cement."

the dots elongate crossways, presenting the appearance of small short bands. The *Pleurosigma angulatum* (fig. 223), was first discovered in the Humber; the lines upon its surface resemble the most elegant tracery, which are resolvable into raised minute dots. The markings are seen to be longitudinal, transverse, and oblique.

In the vicinity of Hull many very interesting varieties of *Diatomaceæ* have been found, the beauty of the varied forms of which are such as to delight the microscopist;

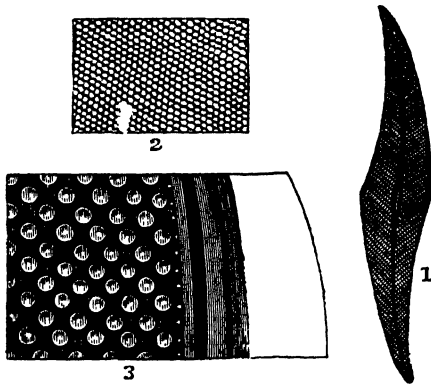

Fig. 223.

1, *Pleurosigma angulatum* 2, Portion of the same, magnified 1200 diameters.  
3, Portion of *P. formosum*, magnified 5500 diameters.

at the same time some of them are highly useful, as forming that class of *test objects* which are best calculated above all others for determining the excellence and powers of object-glasses. It has been shown by Mr. Sollitt that the markings on some of the shells are so fine as to range between the 30,000th and 130,000th of an inch; the *Pleurosigma strigilis* having the strongest markings, and the *Pleurosigma acus* the finest.

As to the value of the *Diatomaceæ* as test-objects, it is generally admitted, and since Mr. J. D. Sollitt first proposed the use of their shells for this purpose, we append his measurements of the lines:—

*Amphipleura Pellucida*, or *Acus*, 180,000 in the inch, cross lines.  
" *Sigmoidea*, 70,000 in the inch.  
*Navicula Rhomboidea*, 111,000 in the inch, cross lines

<i>Pleuronigma Fasciola</i> , fine shell, 86,000 in the inch, cross lines.
"    strong shell, 64,000 in the inch, cross lines.
" <i>Strigosum</i> , 72,000 in the inch, diagonal lines.
" <i>Angulatum</i> , 51,000 in the inch, diagonal lines.
" <i>Quadratum</i> , 50,000 in the inch, diagonal lines.
" <i>Spencerii</i> , 50,000 in the inch, cross lines.
" <i>Attenuatum</i> , 42,000 in the inch, cross lines.
" <i>Balticum</i> , 40,000 in the inch, cross lines.
" <i>Formosum</i> , 32,000 in the inch, diagonal lines.
" <i>Strigilla</i> , 30,000 in the inch, cross lines.

Mr. Norman, of Hull, has favoured us with the following :—

#### HINTS FOR COLLECTING DIATOMACEÆ.

These minute forms are found in all waters, but the most interesting species are those found in salt water, especially shallow lagoons, salt water marshes, estuaries of rivers, pools left by the tide, &c.

Their presence in any quantity is always shown by the colour they impart to the aquatic plants and sea-weeds they are found attached to, and if found on the mud, which is very frequently the case, they impart to it also a yellowish brown colour approaching to black brown, if in great numbers. This brownish pellicle, if carefully removed with a spoon (without disturbing the mud) will be found very pure. Capital gatherings of *Diatomaceæ* might be obtained by carefully scraping the brown coloured layer from mooring posts, and piles of wharfs and jetties.

In clear running ditches the plants and stones have often long streamers of yellowish brown slimy matter attached to them, which is generally entirely *Diatomaceous*.

When found in large quantities on the mud the layer is often covered with bead-like bubbles of oxygen. This often detaches them from the bottom and buoys them to the surface, where they form a dense brown scum, which is blown to leeward in large quantities, and presents the general appearance of dark-coloured yeast. In this form it may be collected in abundance, often quite free from particles of sand and other impurities. Good and rare species have been obtained from the stomachs of oysters, scallops, and other shell-fish inhabiting deep water. The sea-cucumbers (*Holothuridæ*) found so frequently in southern latitudes contain many species. These animals

might be simply dried and preserved just as found, and the contents of the stomach afterwards obtained by dissection.

Noctiluca, which are the cause of phosphorescence in the sea, are Diatom feeders, and might be caught in large quantities in a fine gauze towing-net, and preserved. The Ascidians found attached to oyster shells and stones from deep water have yielded excellent gatherings. The Salpæ often noticed in warm latitudes floating on the surface of the sea, and assuming chain and other like forms, should be bottled up for examination. These Salpæ are well known Diatom feeders. Deep-sea soundings ought to be preserved, especially from great depths, and are often exclusively Diatomaceous. Sea-weed from rocks ought to be preserved, especially the smaller species, and if covered with a brown furriness, so much the better. Very rare species have been found in immense quantities in the ARCTIC and ANTARCTIC regions, by melting the "pancake ice," often found discoloured by these minute beings. The sea is often observed to be covered by brownish patches. The discoloured water (or "spawn" as it is called) should be collected, filtered through cotton wool, and the brown residue preserved. When a fine impalpable dust is observed to be falling at sea, it ought to be collected from the folded sails and other places where it lodges. This may yield Diatomaceæ, which from the method of collecting would be highly interesting to examine. The roots of the various species of Mangrove (*Rhizophora*), which form impenetrable barriers along the salt water rivers and estuaries in the tropical parts of Africa, Australia, the Eastern Archipelago, &c., are found frequently covered with a brown mucous slime very rich in Diatomaceæ. When the Diatomaceæ are collected from any of the above-mentioned sources, they may be at once transferred to small bottles, or the deposit may be partially dried and wrapped up in pieces of paper or tinfoil. When placed in bottles, a few drops of spirits added will keep them nice and sweet. In all cases it is essential to keep the gatherings separate and distinct, and that the locality whence obtained be written on each package.

The collector will probably find that, notwithstanding

every care, his specimens are mixed with much foreign matter, in the form of minute particles of mud or sand, which impair their value, and interfere with observation, especially with the higher powers of his instrument. These substances the student may remove in various ways: by repeated washings in pure water, and at the same time, profiting by the various specific gravities of the *Diatoms* and the intermixed substances, to secure their separation; but, more particularly, by availing himself of the tendency which the *Diatomaceæ* generally have to make their way towards the light. This affords an easy mode of separating and procuring them in a tolerably clean state; all that is necessary being to place the gathering which contains them in a shallow vessel, and leave them undisturbed for a sufficient length of time in the sunlight, and then carefully remove them from the surface of the mud or water. The simplest method of preserving the specimens, and the one most generally useful to the scientific observer, is simply to dry them upon small portions of talc, which can at any time be placed under the microscope, and examined without further preparation; and this mode possesses one great advantage,—that is, that the specimens can be submitted without further preparation to a heat sufficient to remove all the cell-contents and softer parts, leaving the siliceous epiderm in a transparent state.

ON CLEANING DIATOMACEOUS DEPOSITS.—“The first point to be ascertained is the nature of the material which binds the mass together. In the generality of deposits, this seems to be aluminous or earthy matter, often mixed with some siliceous material which renders the action of acids of little avail. When the bulk of the deposit is clayey matter, the best plan is to place the lumps broken quite small into a vessel and pour on a few ounces of hot water, rendered thoroughly alkaline with common washing soda. This plan frequently answers, causing the lumps to swell, gradually separating into layers, and finally falling asunder into a pulpy mass. The strong soda ley must now be removed by repeated washing, and afterwards boiling in a flask with pure nitric acid; the whole must afterwards be transferred to a large stoppered vessel and

violently shaken, in order to break up the minute fragments of dirt, and set free the siliceous Diatoms. After shaking, allow the vessel to stand for half an hour or more according to the size and density of the valves: the Diatoms having subdivided, the dirty water is drawn off by a syphon, and fresh water added, and the shaking repeated. The whole secret depends upon getting rid of the impurities by this violent shaking and washing; when quite free from all impurities the material may be transferred to a test tube, washed in distilled water, and finally mounted."<sup>1</sup>

*Fossil Infusoria.*—Startling and almost incredible as the assertion may appear to some, it is none the less a fact, established beyond all question by the aid of the microscope, that some of our most gigantic mountain-ranges, such as the mighty Andes, towering into space 25,250 feet above the level of the sea, their base occupying so vast an area of land; as also our massive limestone rocks, the sand that covers our boundless deserts, and the soil of many of our wide-extended plains; are principally composed of portions of invisible animalcules. And, as Dr. Buckland truly observes: "The remains of such minute animals have added much more to the mass of materials which compose the exterior crust of the globe than the bones of elephants, hippopotami, and whales."

The stratum of slate, fourteen feet thick, found at Bilin, in Austria, was the first that was discovered to consist almost entirely of minute flinty shells. A cubic inch does not weigh quite half an ounce; and in this bulk it is estimated there are not less than forty thousand millions of individual organic remains! This slate, as well as the Tripoli, found in Africa, is ground to a powder, and sold for polishing. The similarity of the formation of each is proved by the microscope; and their properties being the same, in commerce they both pass under the name of Tripoli: one merchant alone in Berlin disposes annually of many hundred tons weight. The thickness of a single shell is about the sixth of a human hair, and its weight the hun-

(1) G. Norman, Esq. *Micros. Journ.* vol. iv. p. 238 For other methods of cleaning and preparing Diatoms, see Smith's *Synopsis of the British Diatomaceæ*; also *Quar. Journ. Micros. Science*, vol. vii. p. 167, and vol. i. N. S. 1863, p. 143.

dred-and-eighty-seven-millionth part of a grain. The well-known Turkey stone, so much used for the purpose of sharpening razors and tools; the Rotten-stone of commerce, a polishing material; and the pavement of the quadrangle of the Royal Exchange, are all composed of infusorial remains.

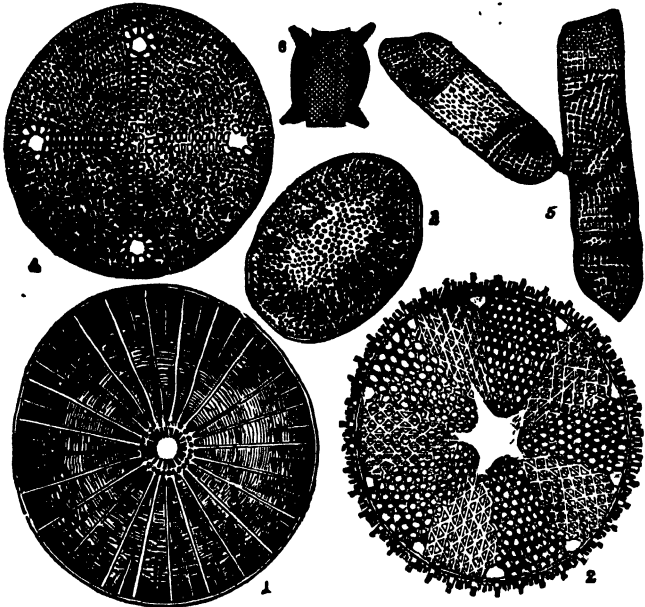

Fig. 224.

1, Shell of *Arachnoidiscus*. 2, *Actinocyclus* (Bermuda). 3, *Cocconeis* (Algoa Bay)  
4, *Coscinodiscus* (Bermuda.) 5, *Isthmia enervis*. 6, *Zygoceros rhombus*.

The *bergh-mehl*, mountain-meal, in Norway and Lapland, has been found thirty feet in thickness; in Saxony, twenty-eight feet thick; and it has also been discovered in Tuscany, Bohemia, Africa, Asia, the South Sea Islands, and South America; of this, almost the entire mass is composed of flinty skeletons of *Diatomaceæ*. That in Tuscany and Bohemia resembles pure magnesia, and consists entirely of a shell called *campilodiscus*, about the 200th of an inch in size.

Darwin, writing of Patagonia, says: "Here along the coast, for hundreds of miles, we have our great tertiary formation, including many tertiary shells, all apparently extinct. The most common shell is a massive gigantic oyster, sometimes a foot or more in diameter. The beds composing this formation are covered by others of a peculiar soft white stone, including much gypsum, and resembling chalk; but really of the nature of pumicestone. It is highly remarkable, from its being composed, to at least one-tenth of its bulk, of *Infusoria*; and Professor Ehrenberg has already recognized in it thirty marine forms. This bed, which extends for five hundred miles along the coast, and probably runs to a considerably greater distance, is more than eight hundred feet in thickness at Port St. Julian." Ehrenberg discovered in the rock of the volcanic island of Ascension many siliceous shells of fresh-water *Infusoria*; and the same indefatigable investigator found that the immense oceans of sandy deserts in Africa were in great part composed of the shells of animalcules. The mighty Deltas, and other deposits of rivers, are also found to be filled with the remains of this vast family of minute organization. At Richmond in Virginia, United States, there is a flinty marl many miles in extent, and from twelve to twenty-five feet in thickness, almost wholly composed of the shells of marine animalcules; for in the slightest particles of it they are discoverable. On these myriads of skeletons are built the towns of Richmond and Petersburg. The species in these earths are chiefly *Naviculæ*; but the most attractive, from the beauty of its form, is the *Coscinodiscus*, or sieve-like disc, found alike near Cuxhaven, at the mouth of the Elbe, in the Baltic, near Wismar, in the guano, and the stomachs of our oysters, scallops and other shell-fish. Another large deposit is found at Andover, Connecticut; and Ehrenberg states "that similar beds occur by the river Amazon, and in great extent from Virginia to Labrador." The chalk and flints of our sea-coasts are found to be principally shells and animal remains. Ehrenberg computes, that in a cubic inch of chalk there are the remains of a million distinct organic beings. The Paris basin, one hundred and eighty miles long, and averaging ninety in



breadth, abounds in *Infusoria* and other siliceous remains. Ehrenberg, on examining the immense deposit of mud at the harbour of Wismar, Mecklenburg-Schwerin, found one-tenth to consist of the shells of *Infusoria*; giving a mass of animal remains amounting to 22,885 cubic feet in bulk, and weighing forty tons, as the quantity annually deposited there. How vast, how utterly incomprehensible, then, must be the number of once living beings, whose remains have in the lapse of time accumulated! In the frigid regions of the North Pole no less than sixty-eight species of the fossil *Infusoria* have been found. The guano of the island of Ichaboe abounds with fossil *Infusoria*, which must have first entered the stomachs of fish, then those of the sea-fowl, and became ultimately deposited on the islands, incrustating its surface; whence they are transported, after the lapse of centuries, to aid the fruition of the earth, for the benefit of the present race of civilized man. The hazy and injurious atmosphere met with off Cape Verd Islands, and hundreds of miles distant from the coast of Africa, is caused entirely by a brown dust, which upon being examined microscopically by Ehrenberg, was found chiefly to consist of the flinty shells of *Infusoria*, and the siliceous tissue of plants: of these *Infusoria*, sixty-four proved to belong to fresh-water species, and two were denizens of the ocean. From the direction of the periodical winds, this dust is reasonably supposed to be the finer portions of the sands of the desert of the interior of Africa.

The deposit of the beneficent Nile, that fertilises so large a tract of country, has undergone the keen scientific scrutiny of Ehrenberg; and he found the nutritive principle to consist of fossil *Infusoria*. So profusely were they diffused, that he could not detect the smallest particle of the deposit that did not contain the remains of one or more of the extensive but diminutive family that once revelled in all the enjoyment of animal existence. It is very remarkable that at Holderness, in digging out a submerged forest on the coast, numbers of fresh-water fossil *Diatomaceæ* have been discovered, although the sea flows over the place at every tide.

*Mod: of Preparing Fossil Infusoria.*—Before entering

on further details of the fossil *Infusoria*, we would first state how they may be prepared for microscopic examination. A great many of the infusorial earths may be mounted as objects without any previous washing or preparation; some, such as chalk, however, must be repeatedly washed, to deprive the *Infusoria* of all impurities; whilst others, by far the most numerous class, require either to be digested for a long time, or even boiled in strong nitric or hydro-chloric acid, for the same purpose. Place a small portion of the earth to be prepared in a test-tube, or other convenient vessel, capable of bearing the heat of a lamp; then pour upon it enough diluted hydro-chloric acid to about half fill the tube. Brisk effervescence will now take place, which may be assisted by the application of a small amount of heat, either from a sand-bath or from a lamp: as soon as the action of the acid has ceased, another supply may be added, and the same continued until no further effect is produced. Strong nitric acid should now be substituted for the hydro-chloric, when a further effervescence will take place, which may be greatly aided by heat; after two or three fresh supplies of this acid, distilled water may be employed to neutralise all the remains of the acid in the tube; and this repeated until the water comes away perfectly clear, and without any trace of acidity. The residuum of the earth, which consists of silica, will contain all the infusorial forms; and some of this may be taken up by a dipping-tube, laid on a slide, and examined in the usual manner. Should perfect specimens of the *Coscinodiscus*, *Gallionella*, or *Navicula* be present, they may be mounted in Canada balsam; if not, the slide may be wiped clean, and another portion of the sediment taken, and dealt with in the same way, which, if good, after being dried, may be mounted in Canada balsam.

Dr. Redfern adopts an excellent mode of isolating *Naviculae* and other test-objects. He says: "Having found the methods ordinarily employed very tedious, and frequently destructive of the specimens, I adopted the following plan. Select a fine hair which has been split at its free extremity into from three to five or six parts, and having fixed it in a common needle-holder by passing it

through a slit in a piece of cork, use it as a forceps under a two-thirds of an inch objective, with an erecting eyepiece. When the split extremity of the hair touches the glass-slide, its parts separate from each other to an amount proportionate to the pressure, and on being brought up to the object, are easily made to seize it, when it can be transferred as a single specimen to another slide without injury. The object is most easily seized when pushed to the edge of the fluid on the slide. Hairs split at the extremity may always be found in a shaving-brush which has been in use for some time. Those should be selected which have thin split portions so closely in contact that they appear single until touched at their ends. I have also found entire hairs very useful, when set in needle-holders, in a similar manner; any amount of flexibility being given to them by regulating the length of the part of the hair in use." Professor Smith, of Kenyon, U.S. contrived a very ingenious "Mechanical finger" for picking up and arranging diatoms and other minute objects.

Professor J. W. Bailey, of New York, has enriched the Museum of the College of Surgeons with several valuable specimens of the skeletons of *Infusoria*; among them is a fresh-water *Bacillaria*, named *Meridion circulare*, which Professor Quekett, in the *Historical Catalogue*, describes as "consisting of a series of wedge-shaped bivalve siliceous loricae, arranged in spiral coils; when perfect, and in certain positions, they resemble circles; each lorica is articulated by two lateral surfaces." It is asserted that they creep about when free from the stalk-plate. (Fig. 225, No. 16.) *Cocconema lanceolata* have two lanceolate flinty cases that taper towards their ends, one of which is attached to a little foot. Each lorica has a line marked in its centre, and transverse rows of dots on both sides: Ehrenberg says there are twenty-six rows in the one-hundredth of a line. (Fig. 225, No. 14.) *Achnanthes Longipes* have at the margins two coarse convex pieces roughly dotted, and two inner pieces firmly grooved; the inside seems filled with green matter. At one corner they are affixed to a jointed pedicle, which in many specimens contains green granules. In a specimen of a fossil *Eunotia*, found in some Bermuda earth, the flinty case is in four parts; it is of a half

lanceolate shape, and a little indented on both margins ; two of them have curved rows of dots, and the other two are partly grooved with finer rows. Ehrenberg says they have four openings, all on one side (fig. 225, No. 13).

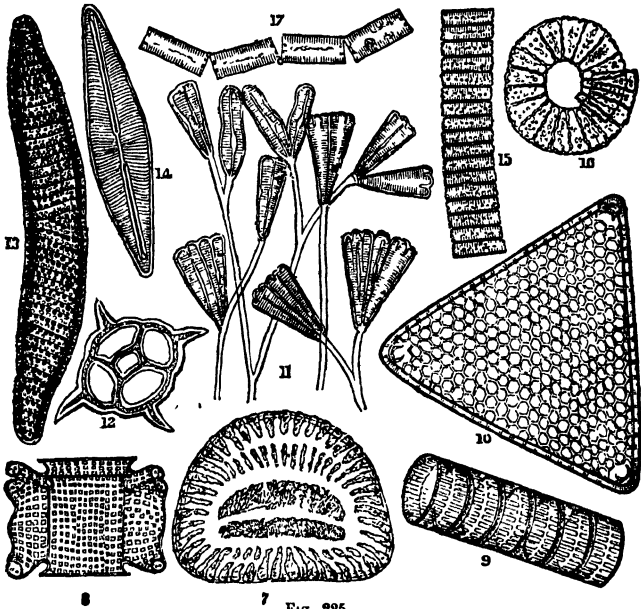

7 Fig. 225.

7, *Campilodiscus clypeus*. 8, *Biddulphia*. 9, *Gulionella sulcata*. 10, *Triceratium*, found in Thames mud. 11, *Gomphonema geminatum*, with their stalk like attachments. 12, *Dictyocha fibula*. 13, *Eunotia*. 14, *Cocconema*. 15, *Fragilaria pectinalis*. 16, *Meridion circulare*. 17, *Diatoma focculatorum*.

presenting a row of dots varying very much in number ; minute striæ in some cases extend from each dot towards the middle of the lorica ; and on the circumference there are two of these dots. The spirals and the individual lorica are very fragile, and therefore easily separated from each other. Of a glistening whiteness is the ribbon-like flinty case of *Fragilaria pectinalis*, which consists of many bivalve segments : on the articulating surface there are small grooves, represented in fig. 225, No. 15. A sin-

gular class of objects are *Diatoma flocculosum*, being rather oblong-looking, and joined to each other at opposite corners: they are sometimes grooved on each side. (Fig. 225, No. 17.) The "Swollen Eunotia" is generally about from the 11th to the 200th of an inch in length: a groove, widest in the centre, and tapering off to the ends, passes along its centre on both sides; it has curved lines proceeding from it. So wonderfully close are these lines or ribs, that as many as eight of them have been counted in the space of the 1200th of an inch. They are usually found when alive adhering to a branch of some weed that forms the green coating over stagnant waters. They propagate by self-division; a slight line running down the centre marks where the separation will occur, on each becoming perfectly developed as a distinct creature; and thus they grow and separate, filling the earth with their flinty shells.

*Gallionella sulcata* is found in many parts of North America; it somewhat resembles the cylindrical box for spices, which was at one time so common among good housewives; scientifically, it is described as consisting of chains of cylindrical bivalve loriceæ, having their outer surfaces marked or furrowed with longitudinal striæ; short joints may occasionally be seen, having their ends uppermost, the depth of the furrows being shown on the margin; within the margin is a thin transparent rim having radiating striæ. Sometimes as many as forty will be found joined together. (Fig. 225, No. 9.) The *Gallionella* received its designation from a celebrated French naturalist named Gaillon, it is often termed the *Box-chain Animalcule*, and when the flinty case is seen lying on its face, it much resembles a coin. These living *infusoria* are found in almost all waters, and are stated to be so rapid in their growth, that one hundred and forty millions will by self-division be produced in twenty-four hours. A species named the *Striped Gallionella* was discovered by Dr. Mantell near London; the same species is also found in the ocean. Sometimes the chains are three inches long; their size is from the 14th to the 400th part of an inch.

Professor Quekett, in the catalogue already referred to, describes an "earth from Bohemia, particularly rich in

fossil specimens of *Navicula viridis*, which consists of four prismatic loriceæ, two ventral and two lateral; the former having round, the latter truncate extremities; and both provided with two rows of transverse markings and dots, longer and more marked on the ventral than on the lateral surfaces. The specimens having their ventral surfaces uppermost, exhibit a longitudinal marking in the centre with a slight dilatation or knob at each extremity; this marking is interrupted in the middle of the lorica, and a diamond-shaped spot is left; if one of the lateral loriceæ be examined, two of the same spots will be seen, one on each side; they are of triangular figure, and appear to be thicker parts of the shell, described as holes by Ehrenberg." Four smaller triangular spots may be observed in the same lorica, one being situated at each corner; these also have been considered as openings by Ehrenberg: their length varies considerably; some exceed the 100th, whilst others are even smaller than the 1000th of an inch. *Isthmia ener-vis* (fig. 224, No. 5) is usually found attached to sea-weed; it is in three parts; and of a trapezoid shape, the centre part appears like a band passing over, and is bounded by broad straight lines: its outer surface is covered with a network of rounded reticulations, arranged in parallel lines. Among the most remarkable is *Amphitetras antediluviana*; this is of a cubical or box-like figure, and consists of three portions, the one in the centre being in the form of a band, as shown at fig. 225, No. 8, and the two lateral ones having four slightly projecting angles, with an opening into each. When viewed in detached pieces, the central one is like a box, and the two lateral portions resemble the cover and bottom. The former may be readily known, as consisting merely of a square frame-work with striated sides; but both the latter are marked with radiating reticulations. When recent, they are found in zigzag chains, from their cohering only by alternate angles. In some instances, as in *Biddulphia*, and *Isthmia*, two young specimens may be found within an old one. *Cocconeis* is marked with eight or ten lines proceeding from the inner margin to the centre; between which are dotted furrows, with the earlier spot in the centre of each. (Fig. 224, No. 3.)

*Ampilodiscus clypeus* is oval, and curved in opposite

ways at the long and short diameters. On the margin there are two series of dots, sometimes joined; and on the oval centre there are also dots about the margin, while the middle is nearly plain. (Fig. 225, No. 7.) *Actinocyclus* has a round bivalve flinty case, with numerous cells formed by radiating partitions; very often every alternate cell only is on the same plane. The specimen in the Museum of the College of Surgeons is exquisite in its markings; it was found in some Bermuda earth, and has a beautifully-raised margin, and a five-rayed star in the centre; the number of cells is ten, five being on one plane and five on another. One set has the usual hexagonal reticulations crossed with diagonal lines, the other has the same lines, with a much smaller series of triangular reticulations, so disposed that they appear to form with each other parts of very small circles. One valve from this specimen is represented in fig. 224, No. 2.

As well as the beautiful shell of the *Coscinodiscus*, found both in a fossil and recent state, there is one of exquisite elegance and richness, of the genus *Arachnoidiscus*, so named from the resemblance of the markings of the shell to the slender fibres of a spider's web. (Fig. 224, No. 1.) This is found in the guano of Ichaboe, and also in earth from the United States, as well as among sea-weed from Japan, and the Cape of Good Hope. Mr. Shadbolt believes: "These shells are not, strictly speaking, bivalves, although capable of being separated into two corresponding portions; but are more properly *multivalves*, each shell consisting of *two* discoid portions, and *two* annular valves exactly similar respectively to one another." (See *Microscopical Society's Transactions*, for an excellent paper on these shells by Mr. Shadbolt.)

Artists who design for art-manufacturers might derive many useful hints from the revelations of the microscope, as evidenced in the arrangement of the shell last noticed, and in that of the genus *Coscinodiscus*; a very handsome object, the shells of which are marked with a network of cells in a hexagonal form, arranged in radiating lines or circles, and varying from 1-200th to 1-800th of an inch in diameter. A specimen found in Bermuda earth has on one of its valves two parallel rows of oval cells that form a kind of cross;

which gradually enlarge from the centre to the margin ; the angles of the cross are filled up with hexagonal cells as previously noticed. (Fig. 224, No. 4.)

The unskilled manipulator may for some time endeavour to adjust a slide, having a piece of glass exposed not larger in size than a pea, on which he is informed an invisible object worthy his attention is fixed, before he is rewarded by a sight of *Triceratium favus*, extracted from the mud of the too-muddy Thames. The hexagonal markings, cells. are beautiful, and at each corner there is a curved projecting horn or foot. (Fig. 225, No. 10.) In Bermuda earth there is a small species found, which has its three margins curved ; and also a curious species, which resembles the triradiate spiculum of a sponge.

It is remarkable how, in these minute and obscure organisms, we find ourselves met by the same difficulties concerning any positive laws governing the formation of generic types, as in larger and more complex forms of animal and vegetable life. It appears as if we could carry our real knowledge little beyond that of species ; and when we attempt to define kinds and groups, we are encountered on every side by forms, which set at nought our definitions.

Man even uses infusorial remains as food ; for the *bergmehl*, or *mountain-meal* found in Swedish Lapland, and which, in periods of scarcity, the poor are driven to mix with their flour, is principally composed of the flinty shells of the *Gallionella sulcata*, *Navicula viridis*, and *Gomphonema geminatum*. Dr. Trail, on analysing it, found it to consist of 22 per cent of organic matter, 72 of silica, 5.85 of alumina, and 0.15 of oxide of iron. This would seem to be the same substance described by M. Laribe the missionary, and put to a similar use in China : "This earth," he says, "is only used in seasons of extreme dearth."

**XANTHIDIA.**—In conjunction with the skeletons of the former species it will be as well to offer a few remarks upon animals long classed with *Infusoria*, and but rarely found except in the fossil state. There is every reason to believe that the *Xanthidia*, double-bar animalcules, are sporangia of *Desmidiaceæ*. In proof of this it can be shown that



their skeletons are composed of a horny substance, and not of silica, as was once supposed.

The name *Xanthidia* is derived from a Greek word signifying *yellow*, that being their prevailing hue. They are found plenteously in a fossil state, imbedded in flint, as many as twenty being detected in a piece the twelfth of an inch in diameter; in fact, it is rare to find a gun-flint without them. When living they may be described as having a round transparent shell, from which proceed spikes varying in size and shape. One kind, found by Dr. Bailey in the United States, was of an oval form, the 288th of an inch in length; and another species circular, found by the late Dr. Mantell, at Clapham: both were of a beautiful green colour. Specimens of *Branched Xanthidium*, found in flint by Dr. Mantell, were from the 300th to the 500th of an inch in diameter. Mr. Rulfs says: "That the orbicular spinous bodies so frequent in flint, are fossil sporangia of *Desmidiaceæ*, cannot, I think, be doubted, when they are compared with figures of the more recent forms. Indeed, the late Dr. G. Mantell, who, in his *Medals of Creation*, without any misgiving, had adopted Ehrenberg's ideas concerning them, changed his opinion; and in his last work regards them as having been reproductive bodies, although he is still uncertain whether they are of vegetable origin."

The fossil forms vary as much as recent *Sporangia*, in being smooth, bristly, or furnished with spines, some are simple, and others branched at the extremity. Sometimes, a membrane may be traced, even more distinctly than in recent specimens, either covering the spines, or entangled with them. Writers have described the fossil forms as having been siliceous in the living state; but Mr. Williamson informs us that he possesses specimens which exhibit bent spines and torn margins; and this wholly contradicts the idea that they were siliceous before they were embedded in the flint. In the present state of our knowledge, it would be somewhat premature to identify the fossil with recent species; it is better, therefore, at least for the present, to retain the names bestowed on the former by those observers who have described them.

Near to Sydden Spoint, and the Round Down Cliff, on the Dover beach, Mr. H. Deane cut out a piece of pyrites with the adherent chalk, which, on examination, "exposed to view bodies similar to, if not identical with, *Xanthidia* in flints; he clearly recognised *X. spinosum*, *ramosum*, *tubiferum*, *simplex*, *tubiferum recurvum*, *malleoferum*, and *pyxidiculum*, together with casts of *Polythalamia*, and other bodies frequently found in flints. In shape they are somewhat flattened spheres, the greater part of them having a remarkable resemblance to gemmules of sponge, with a circular opening in the centre of one of the flattened sides. The arms or spines of all appear to be perfectly closed at the ends, even including those which have been considered in the flint, specimens decidedly tubiferous; showing that if the arms are tubes, they could afford no egress to a ciliated apparatus similar to those existing among Zoophytes. On submitting them to pressure in water between two pieces of glass, they were torn asunder laterally, like a horny or tough cartilaginous substance; and the arms in immediate contact with the glass were bent. Some specimens, put up after several weeks' maceration in water, were so flaccid, that, as the water in which they were suspended evaporated away, the spines or arms fell inclined to the glass. These circumstances alone seem clearly to disprove the idea of their being purely siliceous. The casts of the *Polythalamia*, portions of minute crustaceans, &c. appeared also to be, like the *Xanthidia*, some modification of organic matter; and in the case of the *Polythalamia*, the bodies are so perfectly preserved, that in some the lining membranes of the shells are readily distinguishable."

Mr. Wilkinson, who examined recent *Xanthidia* found in the Thames mud, and slime, on piles and stones at Greenhithe, said that, in his opinion, they are not siliceous, but of a horny nature, similar to the wiry sponges, which Mr. Bowerbank describes as being very difficult to destroy without the action of fire. He also met with a peculiarity in a *X. spinosum*, which he has never seen in any other species; it was in a piece of a gun-flint. There appeared, as it were, a groove or division round the circumference, similar to that formed by two cups when placed

on each other, so as to make their rims or upper edges meet.

The other fossil *Infusoria*, found most abundantly in the chalk and flint of England, are the *Rotalia*, or *wheel-shaped*, and the *Textularia* or *woven-work* animalcules; the latter having the appearance of a cluster of eggs in a pyramidal form, the largest being at the base, and lessening towards the apex.

We must here bring to a close this short notice of some of the marvellous creations in the invisible world, every glimpse inspiring awe, from the immensity, variety, beauty, and minuteness of its organised habitants. Immensity, in its common impression on the mind, hardly conveys the idea of the myriads upon myriads of *Infusoria* that have lived and died to produce the tripoli, the opal, the flints, the bog-iron, the ochres, and limestones of the world.

Professor Owen beautifully explains the uses of this vast amount of animalcule life:—"Consider their incredible numbers, their universal distribution, their insatiable voracity; and that it is the particles of decaying vegetable and animal bodies which they are appointed to devour and assimilate. Surely we must, in some degree, be indebted to these ever-active, invisible scavengers, for the salubrity of the atmosphere and the purity of water. Nor is this all; they perform a still more important office in preventing the gradual diminution of the present amount of organised matter upon the earth. For when this matter is dissolved or suspended in water, in that state of comminution and decay which immediately precedes its final decomposition into the elementary gases, and its consequent return from the organic to the inorganic world, these wakeful members of nature's invisible police are everywhere ready to arrest the fugitive organised particles, and turn them back into the ascending stream of animal life. Having converted the dead and decomposing particles into their own living tissues, they themselves become the food of larger *Infusoria*, and of numerous other small animals, which in their turn are devoured by larger animals; and thus a food, fit for the nourishment of the highest organised beings, is brought back, by a short route, from the extremity of the realms of organised matter.

These invisible animalcules may be compared, in the great organic world, to the minute capillaries in the microcosm of the animal body ; receiving organic matter in its state of minutest subdivision, and when in full career to escape from the organic system, turning it back, by a new route, towards the central and highest point of that system."

Such, then, seem to be some of the purposes for which are created the wonderful invisible myriads of infusorial animalcules. In the words of Holy Writ : " All these things live and remain for ever for all uses ; and they are all obedient. All things are double one against another ; and He hath made nothing imperfect. One thing establisheth the good of another ; and who shall be filled with beholding His glory ? "

VORTICELLIDÆ.—We now come to a family, which includes some of the most beautiful of living infusorial animalcules, and in which we meet with phenomena more curious than any yet witnessed, and perhaps as wonderful as any that will be presented to our notice, in the natural history of the higher classes of animals. The family of *Vorticellidæ*, *bell-animalcules*, are characterised by the possession of a fringe of rather long cilia, surrounding the anterior extremity, which can be exerted and drawn in at the pleasure of the creatures. Some are furnished with a horny case for the protection of their delicate bodies, whilst others are quite naked.

The genus *Vorticella*, from which the name given to the family is derived, consists of little creatures placed at the top of a long flexible stalk, the other extremity of which is attached to some object, such as the stem or leaves of an aquatic plant. This stem, slender as it is, is nevertheless a hollow tube, through the entire length of which runs a muscular thread of still more minute diameter. When in activity, and secure from danger, the little *Vorticella* stretches its stalk to the utmost, whilst its fringe of cilia is constantly drawing to its mouth any luckless animalcule that may come within the influence of the vortex it creates ; but at the least alarm the cilia vanish, and the stalk, with the rapidity of lightning, draws itself up into a little spiral coil. But the *Vorticella* is not wholly condemned to pass a sort of vegetable existence,

rooted, as it were, to a single spot by its slender stalk ; its Creator has foreseen the probable arrival of a period in its existence when the power of locomotion would become



1, 2, 3, *Hydra* in various stages of development. 4, A group of *Stentor poly-morphus*, many-shaped *Stentor*. 5, *Englena*. 6, *Monads*.

necessary, and this necessity is provided for in a manner calculated to excite our highest admiration. At the lower extremity of the body of the animal, at the point of its junction with the stalk, a new fringe of cilia is developed ; and when this is fully formed, the *Vorticella* quits its stalk, and casts itself freely upon its world of waters. The development of this locomotive fringe of cilia, and the subsequent acquisition of the power of swimming by the *Vorticella*, is generally connected with the propagation of the species, which, in this and some of the allied genera, presents a series of most curious and complicated phenomena.

The *Vorticella* possess means of propagation which is denied to other *Infusoria*, with the exception of a few, although we meet with the same in other forms of animal life. The mode of reproduction referred to is called *gemination*; it consists in the production of a sort of bud, which gradually acquires the form and structure of the perfect animal. In the *Vorticellæ*, these buds, when mature, quit the parent stem after developing a circlet of cilia at the lower extremity, and fix themselves in a new habitation in exactly the same manner as those individuals produced by the fissuration of the bell.

At an earlier or later period of their existence, the *Vorticellæ* withdraw the discs surrounded by cilia which forms the anterior portion of their bodies, and contracting themselves into a ball, secrete a gelatinous covering, which gradually solidifies, and forms a sort of capsule, within which the animal is completely inclosed. By this process the little animal is said to become *encysted*; and at this point of its history it is seen to be more complicated. Sometimes its further progress commences by the breaking up of the nucleus into a number of minute ovoids, which swim about in the thin gelatinous mass into which the substance of a parent has become dissolved. The body of the parent animal, inclosed within the cyst, now becomes apparently divided into separate little sacs or bags, some of which gradually acquire a considerable increase in size, and at length break through the walls of the cyst. After a time one of these projections of the internal substance bursts at the apex; and through the opening thus formed the gelatinous contents of the cyst, enclosed embryos, are suddenly shot out into the water, there to become diffused, giving rise to new generations. From the name *Acineta* given to them by Ehrenberg, who described them as a new genus, they are denominated *Acineta-forms*.

But the final object of this singular metamorphosis still remains to be described. The nucleus, which at the change of the encysted animalcule into the *Acineta-form* was still distinctly observable, becomes entirely and altogether converted into an active young *Vorticella*, acquiring an ovate form, with a circlet of cilia round its narrower

extremity, and presenting at the opposite end a **distinct** mouth. Within this young animal, whilst still inclosed in the body of its parent, we see a distinct nucleus, and the usual contractile space of the full-grown creature. When mature, the offspring tears its way through the membranes inclosing the *Acineta*, which, however, immediately close again. The latter continues protruding and retracting its filaments, and soon produces in its interior a new nucleus, which in its turn becomes metamorphosed into a young *Vorticella*.

The same faculty of enclosing themselves in a cyst is said to be made use of by the *Vorticella*, as a means of self-preservation if the water in which they have been living dries up. When the animal is thus encased, the mud at the bottom of the pool may be baked quite hard in the sun without doing it the least injury; and in this state the creatures are often taken up by the wind with the dust which it raises from the surface of the parched ground, and borne along to great distances, so as to cause their appearance in most unexpected



Fig. 227.

*Vorticella microstoma.*

localities (they are frequently found in roof gutters), where the first shower of rain calls them back to active life.

*Conochilus vorticella*,<sup>1</sup> belonging to the family *Æcistina*, Plate III. No. 80, is one of the most remarkable and interesting Rotifers met with. It is found in compound groups of a whitish globular form in shallow ponds about London. On Hampstead Heath a good supply is often obtained throughout the summer months. The group consists of from twenty to thirty, or more, animals, of about twice the size of the full-grown volvox, and, like the latter, can be readily seen actively rolling about when the collecting-bottle is held up to the light. The colony is attached to a centre disc, resembling a wheel with its naves and spokes. The foot-stalk is three or four times the length of the body, and has a somewhat spiral form, which it contracts at pleasure, drawing the body down in an instant close to the axis, although it does not appear to

(1) Commonly called *volvox*, but this is an error, as it clearly does not belong to the *Volvocina*.

have the power of retracting itself perfectly within the hyaline membrane. The hyaline membrane is at certain periods of the year so very translucent that it cannot be made out; later in the season it is found studded with parasitic desmids, when its gelatinous form is readily seen. The body is ovoid or cup-shaped, and the mouth is surrounded by long cilia, which are always in rapid motion. When the animal becomes alarmed it instantly retracts, and then has the appearance of a small round ball. On the frontal plane four thickish conical erect papillæ are placed, each furnished with one or more spines or setæ; very near their base, rather behind, and between the division of the ciliary band, are the very minute visual organs. The jaws, it is said, are furnished with teeth, but these we have not been able to make out, chiefly owing to their disposition to break up in a short time after being placed in confinement. The stomach is oval, and two ovoid bodies are observed near the termination of the œsophagus; below these the ova-sack encloses a single ovum of a dark colour. The ovum is surrounded by spinous processes, or cilia, and when first thrown off it lodges for a time in the hyaline membrane; but, when set free, moves slowly about. A few minutes after being placed in the glass-cell the colony become uneasy, break themselves off one after the other, and swim away to die. They were formerly classed among *Volvocinæ*, but bear no resemblance to them, except in their roll through the water; and are more properly placed among the Rotifers.

*Acineta tuberosa*, Plate III. No. 68.—The researches of Stein are said to prove that the several members of this family are simply a developmental phase of *Vorticellina*; this view, however, is controverted by Lachmann, Claparède, and others who have witnessed the reproduction of *Acinetæ* from parent forms. *A. tuberosa* has a triangular-shaped body and three obtuse tubercles or horns, each furnished with tentacula. Many other forms of this genus are well known; but, notwithstanding the diversity in construction, Stein declares their tubular ramified processes to be morphologically and physiologically identical with ordinary tentacula. *Vaginicola crystallina* he puts forward as one of the best illustrations to be obtained of



the conversion of an encysted *Vorticellina* into an *Acineta*. He also considers *Actinophrys Sol* and *Podophrya fixa* (Ehr.) to be the acinetiform representatives of *Vorticella microstoma*.

Stentors, *Trichodina*, and a few others are included by some authors in the *Vorticellina*. *Stentors* (fig. 226, No. 4) are exclusively found in fresh water, between or upon water plants in still running waters. Some are colourless, others green, black, or clear blue. "It is," says M. Dujardin, "in the Stentors where we can view the several supposed internal organs isolately, and that new observations will make known their real nature."

*Rotiferæ* comprise animals which were placed by Ehrenberg in nine genera; named *Ptygura*, *Æcistes*, *Conochilus*, *Megalotiocha*, *Lacinularia*, *Tubicolaria*, *Limnias*, *Melicerta*, and *Cephalosiphon*. As, however, each of these genera contain but a single species, Mr. Gosse proposes to reduce the nine to two; thus, *Ptygura*, *Æcistes*, *Tubicolaria*, *Limnias*, *Melicerta*, and *Cephalosiphon*, as they seem to be only so many species of one genus, might constitute one, and *Megalotrocha*, *Lacinularia*, and *Conochilus*, another. Mr. Gosse also wishes to construct a family to be called *Melicertodæ*; in this he would include two genera, *Melicerta* and *Megalotrocha*, degrading some of the present genera to form species of *Melicerta*, and others, to constitute three species of *Megalotrocha*. Each group will be readily distinguished—the former by the circumstance that the individuals are solitary; in the latter they are, in adult life, aggregated in a common envelope—spherical masses, composed of many animals radiating from a central point. These compound masses are either free or fixed. In the genus *Melicerta*, or tube-dwellers proper, the front or upper part of the body is capable of being turned in upon itself, concealed with purse-like folds, and of being expanded, at the will of the animal, into a disc form, which is usually much wider than the diameter of the body; this again is either flat or in the form of a shallow funnel. Its outline will form either a simple circle, as in *M. ptygura* and *M. æcistes*, two circles united at one point, as in *Limnias* (Plate III. No. 72), or four sinuous lobes, more or less developed, as in *M. cephalosiphon*, *M. tubicolaria*, and

*M. rinjera*, in each of which there is, according to Professor Huxley, a double edge to the disc, of which the subordinate one is placed on the under-side, and a little within the line of the principle one. The former is fringed with minute cilia, whose vibratile waves form well-marked movements, which run evenly along the margin. The eggs are usually laid within the case.

To the genus *Melicerta* Mr. H. Davis<sup>1</sup> adds one, if not two, new species, which he has named, provisionally, *M. longicornis* and *M. intermedias*. The two peculiarities of these new forms are the remarkable length of the antennæ, and the construction of tube-dwellings for the purpose of concealing themselves and their eggs. (Plate III. No. 69.) *Æcistes longicornis*: each animal lives in a separate semi-transparent cylindrical sheath (*urceolus*), into which it entirely withdraws on the approach of danger. The foot-stalk is long, and firmly attached to the bottom of the tube. Two or three ova are concealed in the lower part of the urceolus. The trochal disc is large, and completely surrounded by a ciliary wreath. The antennæ, two, are very long, well placed below the disc, and terminating in a small brush of setæ. The tube, Mr. Davis believes, is built up in the same way as that of *Melicerta*.

In the "Intellectual Observer," a tubicolus *Rotifer* was described; it was discovered on a stem of *Anacharis*, and exhibits an affinity with *Æcistes*, *Limnias*, and *Melicerta*, but differs in some particulars, especially in the antennæ. It was named by Mr. Gosse *Cephalosiphon*, and is remarkable for its single siphon of an extraordinary length. Like *Melicerta* and *Limnias*, it has no visible structure below the disc, whereas in *Æcistes* the contrary holds good.

"The animal inhabits a case slightly trumpet-shaped, generally of greater length and slenderness compared with those of its allies, standing erect on the pond-weed. It is irregular and floccose in outline, very opaque, and of a deep umber brown by transmitted light, but of a much lighter hue by reflected light. It is composed, doubtless, of an excretion from the skin as the foundation layer,

(1) "On two new species of the genus *Æcistes*," by Henry Davis, F.R.M.S. *Proc. Soc. Trans.* April 1867.

thickened and rendered opaque by the addition of the dark material, which I conjecture to be the faecal pellets successively discharged in process of growth. Contrary to the rule in the allied genera, the petaloid disc is made to open by the bending forward of the head towards the ventral aspect, and its widest margin is the dorsal one. Immediately behind the disc are two minute lateral horn-like points, which project from the head, and curve towards each other. These are sometimes visible both in a frontal and a lateral view, and with the disc closed or open; but at other times the closest scrutiny fails in discerning them. Behind these, in the median line, there is an organ which is never concealed: it is the single siphon, which stands up perpendicularly from the occiput to a great height (being almost half as long as the body, exclusive of the foot), and generally arches over the front, but is capable of vigorous and sudden movements to and fro, and from side to side. It is evidently tubular throughout; either a simple tube with thick walls, or else, if the walls are thin, furnished with a slender piston which runs through its length.

“The *Cephalosiphon* is very lively and active in its motions. It is very ready to protrude from its case, and not at all prone to retire upon ordinary alarms, such as a jar upon the instrument, that would send the *Floscularia* or the *Stephanoceros* into its retreat in an instant. It is very curious to see it protruding: the long antenna is first thrust out, and jerked to and fro as a feeler, exploring the surrounding water for safety. The entire height of an average specimen, in its ordinary state of extension, is 1-33d of an inch; of which the foot is 1-50th, the body 1-200th, and the antennæ 1-400th of an inch.

The rotating or wheel-animalcules occupy the most conspicuous place among infusorial animals. They require water for their development, although they are indwellers occasionally of the cells of mosses and damp weeds. They do not possess many stomachs, but one, and generally have teeth and jaws to supply its wants. They can elongate and contract their bodies, and some species have their extremity prolonged to a tail, or rather a foot, or a forked process, by means of which they

fix themselves to extraneous substances; while the cilia is in rapid motion, this prevents the anterior portion of the body being drawn in by the force of the rotatory

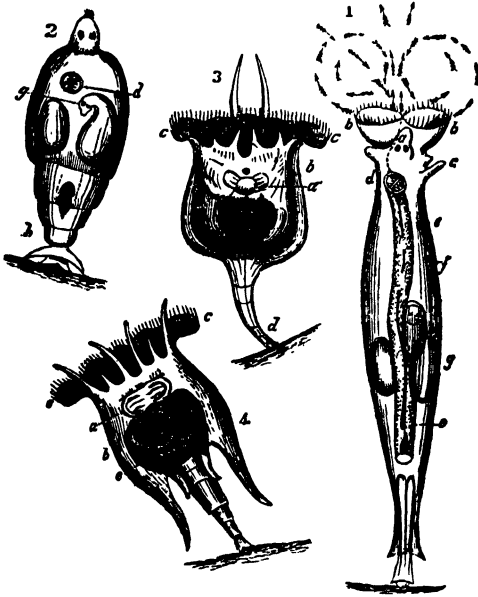

Fig. 228.

1, The common Wheel-Animalcule, *Rottifer vulgaris*, with its cilia or rotators, *b*, protruded; *c*, its horn; *d*, œsophagus; *e*, gut; *f*, outer case; *g*, eggs. 2, The same in a contracted state, and at rest: at *g* is seen the development of the young. 3, Pitcher-shaped *Brachionus*: *a*, its jaws, *b*, shell; *c*, cilia, or rotators; *d*, tail. 4, Baker's *Brachionus*: *a*, the jaws and teeth; *b*, the shell; *c*, the cilia; *e*, the stomach.

action. They multiply by eggs; a few have been seen to bring forth their young alive. In the atmosphere the eggs have been discovered whirling along by the force of the wind to some resting-place, where, when circumstances admit, they spring into active life, and fulfil their appointed destiny. The eggs are of an oval form, and some ten, twenty, or thirty may be seen in an animal, of a brown colour, others are of a delicate pink and deep golden yellow. In those of a light colour, the young are sometimes

seen with their cilia in active vibration. Ehrenberg accurately described the upper part of a common wheel-animalcule, with the cilia, jaws, teeth, eyes, &c., as seen under a magnifying power of 200 diameters, and represented in fig. 228, No. 1. The small arrows indicate the direction of the currents produced by the cilia *b*, turning on their base. At the will of the animal a change is made in the direction in which the wheels appear to revolve, these it has the power of withdrawing, with the quickness of thought; a cluster of hairs appears at the extremity, that do not revolve, and certainly differ from the cilia: as they are usually protruded when the creature is moving from place to place, their function has been imagined to be that of feelers.

The red spots, very generally believed to be the eyes of the *Rotiferæ*, are mostly of a bright red colour; and the number and arrangement of these organs vary. In some species there have been discovered as many as eight, often placed on either side of the head, in a row, circle, or cluster, and in some they take a triangular shape. The *Rotiferæ* delight in the sunshine; and when the bright luminary is hidden behind clouds, the animals sink to the bottom of the water, and there remain. When the water of their haunts is becoming much evaporated, they rise to the top, and give a bright-red tint to it; but when caught and placed in a jar, their beautiful colour fades in a few days. Locomotion is performed by swimming, the rotatory action of the crowns of cilia impelling it forward; in other instances it bends its body, then moves its tail up towards the head, with the two processes that serve as feet near the tail; it then jerks its head to a further distance, again draws up its tail, and so proceeds on its journey. Another peculiarity is that of drawing in the head and tail until nearly globular, and remaining in this condition fixed by the sucker; at other times they become a complete ball, and are rolled about by every agitation of the water.

The body of the wheel-animalcule is of a whitish colour; its form is indicated in the engraving. The tube for respiration appears to allow of water passing to the inside. On the food being drawn by the currents to the cup part

of the wheels, it passes through a funnel as it were to the mouth, which is situated rather lower down, and where the food is crushed by teeth placed on the plates of the jaw, with a hammer-like action; from this point it passes through the alimentary canal for the sustenance of the animal.

BRACHIONÆA.—Ehrenberg's genus *Brachionus*, "Spine-bearing animalcules," belonging to the *Rotiferæ*, are truly interesting, from their very perfect and complex organisation. Some are entirely enclosed in a horny covering, others only partially covered. Their structure, so beautiful and symmetrical, has always made them favourites with those who delight in microscopical studies.—*Brachionus striatus*, "Striped shell animalcule" (No. 3, fig. 228), of an elegant, jug-like form, has the transparent coat or carapace, striated and scalloped out at the upper part; through which the citron-coloured inhabitant protrudes itself. Two hornlike processes are appended to its under-side. As occasions require, it sinks firmly and securely within its crystal home, which is sufficiently transparent to permit a view of its organisation. Its progress is effected by means of ciliary processes.

—*Brachionus Pala*, or *Anura Cervicornis*, "Bent horn animalcule," is possessed of double rotatory organs, and four long processes, which project above the external coat. It measures the 90th part of an inch.—*Brachionus Ovalis*, "Egg-shaped brachionus," is remarkable for the strength of its transparent coat, which is beyond that of other horny creatures. Its projecting tail, as well as head, is at pleasure withdrawn into its very strong case.—*Brachionus Dentatus*, "Toothed brachionus." This active,

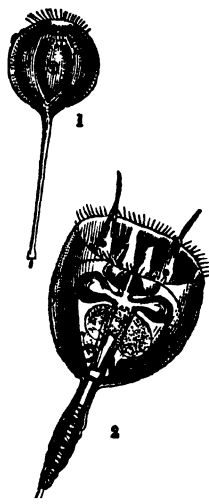

Fig. 229.

1, *Brachionus Ovalis*, closed.  
2, Cilia displayed.

bright pink-eyed little creature, the 90th part of an inch in size, is apparently enclosed in a two-valved shell, having

each end indented so as to form two pair of teeth. Mr Pritchard says:—"In addition to the rotatory organs for supplying it with food, I have observed it attached to a stem of *confervæ*, and abrading it with its teeth fixed in the bulbous œsophagus, which, during the operation, oscillates quickly; the rotatory cilia at the same time move rapidly, which makes it highly probable that they perform some office connected with the organs of respiration, as their motion seems altogether unnecessary while the creature is feeding in this manner."—*Brachionus Bakeri*, "Baker's brachionus," (fig. 228, No. 4), is a curious and beautifully-formed animal. At the points of a half-circle are situated the rotatory organs and cilia, between which rise some long spines, each side of the shell proceeding to a point in the lower part, while a square seems taken out of its body, forming thus two spines; from the central part of the body projects a long tail. The eggs are sometimes attached to these spines, and in other instances are seen in the ovisac.

*Notommata Aurita*, the "Eared notommata."—The anatomy of this animal, a genus of *Rotiferæ*, family *Hydatinææ*, has been most lucidly explained and illustrated by Mr. P. H. Gosse, in the *Microscopical Society's Transactions*.

Mr. Gosse states, that his specimens were found in a jar of water obtained in the autumn from a pond near Walthamstow, the jar having stood in his study-window through the winter; and from a swarm in the succeeding February he selected one the 70th of an inch in length when extended, but its contractions and elongations rendered its size variable.

"Its form, viewed dorsally, is somewhat cylindrical, but it frequently becomes pyriform by the repletion of the abdominal viscera. Viewed laterally, the back is arched gibbous posteriorly, with the head somewhat obliquely truncate, the belly nearly straight. The posterior extremity is produced into a retractile foot, terminating in two pointed toes; this, both in function and structure, is certainly analogous to a limb, and must not be mistaken for the tail, which is a minute projection higher up the body. When not swimming or rotating, the head assumes a rounded outline, displaying through the transparent

integument an oval mark on each side, within which a tremulous motion is perceived; but at the pleasure of the animal a semi-globular lobe is suddenly projected from each of these spots by evolution of the integument. These projections have suggested the trivial name of *aurita*. Each lobe is crowned with a wheel of cilia, the rapid rotation of whose waves forms the principal source of swift progression in swimming. The protrusions of these lobes are evidently eversion of the skin, ordinarily concealed in two lateral cavities. They may be protruded by pressure, and are then seen to be covered with long but firm and close-set cilia, which are bent backward, and move more languidly, as death approaches. The whole front is also fringed with short vibratile cilia, which extend all along the face, as far as the constriction of the neck. The whole body is clear and nearly colourless; but its transparency is much hindered by the net-work of dim lines and corrugations that are everywhere seen, particularly all about the head."

Mr. Gosse, throwing a little carmine into the water, saw the jaws working slightly, the points opening a little way, and then closing; the rods of the hammers were drawn towards the bottom for opening, and upwards for closing. A little mass of pigment was soon accumulated beneath the tips of the jaws, which spread itself over a rounded surface, but did not pass farther; nor did an atom at this time go into the stomach.

After entering into further minute details of the little animal, he observes: "They possess organs that many others do not, and want some that others possess. They prove that the minuteness of the animals of this class does not prevent them from having an organisation most elaborate and complex, and therefore it justifies the belief that the *Rotiferæ* should occupy a place in the scale of animal life much higher than that which has been commonly assigned to them."

Like most of the class, this *Notommata* is predatory. Mr. Gosse once saw one eagerly nibbling at the contracted body of a sluggish *Rotifer vulgaris*; the mouth was drawn obliquely forward, and the jaws were protruded to the food, so as to touch it. It did not appear, however, to do the



rotifer much damage. It appeared chiefly to feed on monads.

**FLOSCULARIÆÆ.**—*The Stephanoceros*, “Crowned animalcule.” This beautiful little creature is about the 36th of an inch in length; and is enclosed in a transparent cylindrical flexible case, over which it protrudes five long arms in a graceful manner, which, touching at their points, give a form from which it derives its name. These arms are furnished with several rows of short cilia, and retain the prey brought within their grasp until it can be swallowed. The case is attached to the animal on the part we may term the shoulders; so that when it shrinks down in its transparent home, the case is drawn inwards. To the bottom of its home it is secured by an elongation of the body; and this part, as well as the body, contracts instantly on the approach of danger, the arms coming close together are also withdrawn. Its mouth differs a little from the common wheel-animalcule; it has two distinct sets of teeth, with which it tears and crushes its food. The eggs of the *Stephanoceros*, after leaving the animal's body, remain in their crystal-like shell until hatched; and Dr. Mantell from close observation found, that about eighty hours elapsed before their organs were all developed and fitted for use.

*Limnias Ceratophylli*, “Water-nymph,” is of this family, being about the 20th of an inch in size, and is enclosed in a white transparent cylindrical case, one-half the length of the animal; which, being glutinous, becomes of a brownish colour, from the adhesion of extraneous matter. Its rotatory apparatus is divided into two lobes, possessing vibrating cilia, as well as a singular projecting angular chin. In the rows of little eggs in the body of the parent, may clearly be distinguished most of the young organs in a state of activity. From its fondness for *hornwort*, it is often called by the name of that plant. (Plate III. No. 72.)

*Floscularia Ornata*, “Elegant floscularia,” is a beautiful type of the family, and has its rotatory organs divided into several parts; when it contracts itself into a small compass, its transparent covering becomes wrinkled. This creature is an interesting object, as its internal structure can be seen through the translucent sheath that constitutes

its dwelling. The little beings are very rapacious, although but the 108th part of an inch in size. *Floscularia Proboscidea*, "Horned floscularia," has six lobes, fringed with cilia shorter than in the preceding species. Its name is derived from a peculiar kind of horn or proboscis, also having cilia placed in the centre of the lobes. The eggs cast off by the parent enclosed in a sheath, are very pretty objects for microscopic observation. In fact, the tinted case, the light ethereal frame of the tiny animal, the variously coloured food, &c., in the stomach, combine in rendering it singularly interesting.

*Melicerta Ringens*, "Beaded melicerta."—Of all the *Melicerta* the "*Horney floscularia*" is the most beautiful. Its crystalline body is first enclosed in a pellucid covering, wider at the top than the bottom, of a dark yellow or reddish-brown colour, which gradually becomes encrusted with zones of a variety of shapes, glued together by some peculiar exudation that hardens in water: it is these little pellets, appearing as rows of beads, give the name to the animal. Mr. Gosse furnishes an excellent account of the "architectural instincts of *Melicerta ringens*," which is not only truly surprising, but full of interest. He writes:—"This is an animalcule so minute as to be with difficulty appreciable by the naked eye, inhabiting a tube composed of pellets, which it forms and lays one by one. It is a mason who not only builds up his mansion brick by brick, but makes his bricks as he goes on, from substances which he collects around him, shaping them in a mould which he carries upon his body.

"The animal, as it slowly protrudes itself from its ingeniously-formed mansion, appears a complicated mass of transparent flesh, involved in many folds, displaying at one side a pair of hooked spines, and at the other two slender, short blunt processes projecting horizontally. As it exposes itself more and more, suddenly two large rounded discs are expanded, around which, at the same instant, a wreath of cilia is seen performing its surprising motions. Often the animal contents itself with this degree of exposure; but sometimes it protrudes farther, and displays two other smaller leaflets opposite to the former, but in the same plane, margined with cilia in like manner. The

appearance is not unlike that of a flower of four unequal petals; from which circumstance Linnæus gave it the name *ringens*, by which it is still known."

Below the large petals on the ventral aspect, and just above the level of the projecting respiratory tubes, is a small circular disc or aperture, within the margin of which a rapid rotation goes on. This little organ, which seems to have hitherto escaped observation, Mr. Gosse can compare to nothing so well as to one of those little circular ventilators which we sometimes see in one of the upper panes of a kitchen-window, running round and round, for the cure of smoky chimneys. The gizzard, or muscular bulb of the gullet, is always very distinct, and its structure is readily demonstrated. It consists of two sub-hemispherical portions, or jaws, each of which is crossed by three developed teeth, which are succeeded by three or four parallel lines, as if new teeth might grow from thence. The teeth are straight, slender, swelling towards their extremity, and pointed. These armed hemispheres work on each other, and on a V-shaped or tabuliform apparatus beneath, common to most of the Rotifers, but in this genus very small.

The pellets composing the case are very regular in form and position: in a fine specimen, about the 1-28th of an inch in length when fully expanded, of which the tube was the 1-36th of an inch, Mr. Gosse counted about fifteen longitudinal rows of pellets at one view, which might give about thirty-two or thirty-four rows in all.

In November, 1850, Mr. Gosse found a fine specimen attached to a submerged moss from a pond at Hackney; this he saw engaged in building its case, and at the same time discovered the use of the curious little rotatory organ on the neck. When fully expanded, the head is bent back at nearly a right angle to the body, so that the disc is placed nearly perpendicularly, instead of horizontally; the larger petals, which are the frontal ones, being above the smaller pair. Now, below the large petals (that is, on the ventral side) there is a projecting angular chin, which is ciliated; and immediately below this is the little organ in question. It appears to form a small hemispherical cup, and is capable of some degree of projection, as if on a short

pedicle. On mixing carmine with the water, the course of the ciliary current is readily traced, and forms a fine spectacle. The particles are hurled round the margin of the disc, until they pass off in front through the great sinus, between the larger petals. If the pigment be abundant, the cloudy torrent for the most part rushes off, and prevents our seeing what takes place; but if the atoms be few, we see them swiftly glide along the facial surface, following the irregularities of outline with beautiful precision, dash round the projecting chin like a fleet of boats doubling a bold headland, and lodge themselves, one after another, in the little cup-like receptacle beneath. Mr. Gosse, believing that the pellets of the case might be prepared in the cup-like receptacle, watched the animal, and presently had the satisfaction of seeing it bend its head forward, as anticipated, and after a second or two raise it again; the little cup having in the meantime lost its contents. It immediately began to fill again; and when it was full, and the contents were consolidated by rotation, aided probably by the admixture of a salivary secretion, it was again bent down to the margin of the case, and emptied of its pellet. This process he saw repeated many times in succession, until a goodly array of dark-red pellets were laid upon the yellowish-brown ones, but very irregularly. After a certain number were deposited in one part, the animal would suddenly turn itself round in its case, and deposit some in another part. It took from two and a half to three and a half minutes to make and deposit a pellet.

*Melicerta* may be found in clear ponds, mill-ponds, and other places through which a current of water gently flows. If a portion of water-weed be brought home and placed in a small glass zoophyte-trough, and carefully examined with a magnifying power of about fifty diameters, a few delicate looking projections of a reddish brown colour will probably be seen adhering to the plant; these are the tubular cases of *melicerta*, which, after a short period of rest, will throw out little animals of one-twelfth of an inch in length.<sup>1</sup>

(1) For further information, see Gosse, *Trans. Micros. Soc.* vol. iii. 1852, p. 58; Slack's *Marvels of Pond Life*, 1861; and Pritchard's *History of Infusoria*, 4th Edition, 1861.

**POLYPIFERA.**—The chief characteristic of this vast race of animals is, that their mouths are surrounded by radiating tentacula, arranged somewhat like the ray of a flower; and hence the term Zoophyte. So plant-like, indeed, are their forms, that the early observers regarded them as vegetating stones, and invented many theories to explain their growth.

They belong to a sub-kingdom termed *Cœlenterata*, now divided and subdivided by Professor Huxley into the following:—

Septa, &c., × 5 or 6.                      Septa, &c., × 4.

*Simple soft-bodied.*

1. ACTINIDÆ.                                      1. BEROIDÆ.  
*Actinea, Minyas.*                              *Cydippe, Cestum.*

*Compound—Skeleton spicular.*

2. ZOANTHIDÆ.                                      2. ALCYONIDÆ.  
*Zoanthus.*                                      *Alcyonium.*

*Compound—Skeleton sclerobasic.*

3. ANTIPATHIDÆ.                                      3. GORGOONIDÆ.  
*Antipathes.*                                      *Gorgonia, Isis,*  
*Corallium.*

*Compound and Simple—Skeleton thecal—continucua.*

4. PERFORATA.                                      4. TUBIPORIDÆ.  
*Porites, Madrepora.*                              *Tubipora.*

5. TABULATA.                                      5. RUGOSA.  
*Millepora, Seriatopora.*                              *Stauria, Cyathanonia.*  
*Cyathophyllum.*

6. APOROSA.  
*Cyathina, Oculina.*  
*Astræa, Fungia.*



Fig. 230 — Asteroid Zoophytes

Opposed to all our common ideas of animal life is this singular portion of creation. If we cut a limb off a tree, or sever that of an animal, these parts will wither and decompose, by passing into other forms of matter. Cut a tree across its middle, and its natural symmetry is irreparably disfigured; slit it down its centre, and it is destroyed: all animals so treated suffer instant death, with the exception of the polype tribe; for they will put forth new limbs, form a new head or tail, and if slit, become two separate perfect creatures.

The seas which wash our shores swarm with beautiful forms of minute Polypes, having nearly the same organisation as the *Hydra*, but which are protected by an external horny integument. This peculiar covering sends forth shoots or buds, which are developed into new polypes, thus producing a compound animal; but the exercise of this gemmiparous faculty is prevented by a horny defence from effecting any other change than that of adding to the general size, and to the number of tentacles, prehensile fingers, and digestive sacs; yet the pattern according to which new polypes, and branches of polypes, are developed, is fixed and determinate in each species, and there consequently results a particular form of the whole compound animal, by which the species can be readily recognized.

*Cordylophora*, a fresh water group of zoophytes, has been made the subject of an admirable memoir by Professor Allman. (See *Phil. Trans.* 1853, "On the Anatomy and Physiology of *Cordylophora*.") In the interesting and pretty group, *Corynidæ*, the tentacles are not arranged in a single transverse series, as in *Hydra*, but are usually scattered more or less irregularly over the surface of the polype while in *Tubularia* there are two transverse rows of tentacles, an upper shorter, and a lower longer. The reproductive organs, which in *Hydra* are extremely simple, attain, in many of the *Corynidæ* and *Tubulariadae*, to the condition of zooids, sometimes becoming detached, and swimming about freely before discharging their products. These free zooids have always the form of a bell or disc, from whose centre a pyriform or oval body—either a closed sac or an open-mouthed polype—is suspended; and they have been regarded as distinct animals, and grouped together with other forms of *Hydrozoa*, under the head of *Medusæ*. The bell possesses considerable contractility, and at each contraction the water which fills its cavity is forced out, and the bell itself is thereby propelled in the opposite direction. In *Tubularia* a more completely medusiform body is developed, but is never detached.

In the *Sertulariadae*, the numerous digestive zooids, or polypes, developed from the original germ, remain always attached; but their most remarkable feature is the posses-

sion of a "cell," surrounding the base of each polype, and usually capable of receiving it when retracted. The development of this cell at once distinguishes it from the not altogether dissimilar group, the *Diphydæ* and *Physophoridæ*. In some *Sertulariadae* (*Sertularia dynamena*), the margins of the cells are converted into membranous valves; and in the genus *Plumularia*, we find special organs of offence.

The *Diphydæ* are among the most remarkable and beautiful inhabitants of the ocean, to whose warmer regions, they, like the *Physophoridæ*, are principally confined. They are free swimmers in the adult state, and probably, at all times of their existence; but while actively locomotive by means of the contractions of the natatorial organs with which they are provided, they possess no special supporting apparatus, or "float," such as that developed in the *Physophoridæ*. The tentacle of the *Diphydæ* is a long filiform process of the peduncle, capable of great elongation and contraction; the terminal filament of which is closely beset with minute thread-cells, so that the whole must constitute a very efficient weapon of offence. Three genera of the *Physophoridæ* are particularly worthy of notice: the *Physalia*, whose air-vesicle may attain the length of eight or nine inches, while its formidable tentacles hang down for as many feet, inflicting instantaneous death upon the smaller animals, and giving rise to no small amount of pain and irritation, even in man; and the *Verella* and *Porpita*, in which the texture of the air-vesicle is so exceedingly firm, as to give it the appearance of an internal shell, while its cavity is subdivided into numerous chambers. Originally, however, the "shell" of the *Verella* is a perfectly simple air-vesicle, like that of any other *Physophorid*. In the very peculiar genus *Lucernaria*,—lovely "Lamp-polype," with little knobbed tentacles—we have a *Hydrozoon*, in which the polype occupies the centre of an expanded disc, the two presenting essentially the same structure and relations as in the Medusiform zooids of other divisions. In fact, a *Lucernaria* is in all essential respects comparable to an *Aurelia*, or other *Medusa* fixed by the middle of the upper surface of its disc.

Mr. Huxley prefers the term *Lucernariadae* to that of

*Medusæ*; and he does so "from the fact that the *Medusida* of authors consists of two groups, the *Naked-eyed* (*Gymnophthalmata*) and the *Covered-eyed* (*Steggnophthalmata*). Some of which, the *Aurelia*, is but a derivative zooid form of an animal, essentially resembling *Lucernaria*; while so far as regards the *Naked-eyed Medusæ*, we have no evidence that any genus except *Æginopsis*, is other than the reproductive zooid of one of the *Hydridæ* or *Sertulariadæ*. It seems better, therefore, to avoid the term *Medusæ*, as the denomination of an ascertained group, reserving it merely to denote the medusiform creatures of whose origin we are ignorant, but whose structure entitles them to a provisional place among the *Lucernariadæ*. As our knowledge increases, we shall be able to arrange those *Medusæ* which are the zooids of *Hydridæ*, *Sertulariadæ*, *Diphydæ*, or *Physophoridæ*, under their respective groups, while the rest will form the sub-sections of the *Lucernariadæ*; the first consisting of such forms as *Aurelia* and *Rhizostoma*, zooids developed by fission from fixed *Lucernariadæ*; the second consisting of such forms as *Æginopsis*, free *Lucernariadæ*, developed at once from the ovum, without any fixed state."

The *Actinozoa* are those *Cœlenterata* in which the stomach is a sac suspended within and entirely distinct from the body, from whose parietes it is separated by a portion of the general cavity of the body, which may receive the special denomination of "perivisceral cavity." The stomach communicates freely by an inferior aperture with the general cavity. A rough conception of the relations between the *Actinozoa* and the *Hydrozoa* may be obtained by supposing the walls of the natatorial disc of a *Lucernaria* to become united with those of its central polype; it would then become, to all intents and purposes, an *Actinozoon*. As the *Hydra* is the type of the *Hydrozoa*, so the "Sea-anemone" (*Actinia*) is considered to be the type of the *Actinozoa*. As in the *Hydrozoa*, the body of the *Actinia* is essentially composed of two layers, a superficial layer, composed of polygonal cells, frequently detached and renewed again, beneath which lies a granular layer; whilst in the deep dermal layer two sets of muscular fibres are found,—a superficial circular, and a deep



longitudinal set : both are flattened, and exhibit no transverse striation. In some *Actiniæ*, such as *A. mesembryanthemum*, bright blue sacs are placed at the edges of the oral



Fig 281.—*Hydra*, with tentacles displayed and magnified, adhering to a stalk of *Anacharis alsinastrum*.

disc, while in *A. gemmacea*, *A. sessilis*, &c. clear spots are scattered over the integument, which have been regarded as apertures or tubercles ; M. Hollard, however, states, that these are imperforate *Ampullæ*, possessing a kind of bilabiate mouth, surrounded by a sphincter-like arrangement of muscular fibres. Any foreign body introduced into these ampullæ is seized and forcibly held ; or if the finger be placed within reach, it gives the sensation of a very fine rasp passing over it. The margins of the radiate tentacles of the young animal are surrounded by cilia ; the gastric epithelium is likewise ciliated, and doubtless secretes a powerfully solvent fluid. The majority of the *Actiniæ* are oviparous, the young being developed from ova within, and evacuated by the mouth : they are also capable of multiplication by budding, and occasionally by fission while their power of restoring themselves after muti

lation appears to be as great as that possessed by the *Hydra*.<sup>1</sup>

The great majority of the *Actinozoa* exhibit a structure closely corresponding with that of the *Actinimæ*; but from the manner in which they grow up into compound masses of associated Zooids, produced by gemmation or by fission, they stand in nearly the same relation to *Actinia*, as the compound *Hydrozoa* to *Hydra*.

Sir John Dayell believes that *Actinimæ* conquer their prey by mere strength; this is doubtless the case, as from experience we find nothing like a stinging property belonging to the tentacles; nor are there any poison vesicles attached thereunto. The tentacles appear to be armed with rows of spines, which give a clinging and slight rasping sensation when the finger is thrust against them; and by the same means they are able to obtain a firm hold of any smaller animal that falls within their reach. Animals with a hard case or shell seem to escape from their clutches without having sustained the smallest injury. The same remarks apply to the *Hydra*; they have neither the power to sting or benumb their prey, as asserted by many authorities. It has been said that certain minute organs found in polypes, and variously styled *thread capsules*, *filiferous capsules*, or *urticating cells*, are stinging organs. This thread Agassiz likens to a lasso thrown by the polype to secure its prey. Mr. Lewes writes:—"On a survey of the places where these 'urticating cells' are present, I stumbled upon an unlucky fact, and one likely to excite our suspicion. They are present in a few jelly-fish which urticate, in *Actinimæ* which urticate, and in all polypes, which, if they do not urticate,

(1) The Author's aquarium affords at this time (1856) a curious illustration of increase both by budding and fissuration, in a beautiful *A. dianthus*. In the first case an offset was seen to protrude; it resembled a small bud near the foot; this increased until it attained to a perfect animal of a considerable size, when it became detached. In another, the animal, after having remained for several weeks firmly adherent to the side of the glass, with a part of its disc out of the water, by a great effort tore itself away, leaving six small pieces behind, attached to the glass. For some days these pieces served only to mark so many spots, but in about a week rudimentary tentacles were observed to be sprouting out from each piece, which went on rapidly increasing, and ultimately six perfect animals resulted therefrom. The repair of the marginal portion of the disc of the parent animal was completed in a few days, and it suffered no injury whatever from its self-mutilation. This furnishes a proof, if one were wanting, of the hydroid character of this class of animals.

are popularly supposed to do so, and at any rate possess some peculiar power of adhesion. In all these cases, organ and function may be said to go together; but the cells are also present in the majority of jelly-fish which do *not* urticate, in *Æolids* which do *not* urticate, and in *Planariæ* which do *not* urticate. Here, then, we have the organ without any corresponding function; urticating cells, but no urtication. It thus appears that animals having the cells, have none of the power attributed to the cells; and that even in those animals which have the power, it is only present in the tentacles, where the cells are much less abundant than in parts not manifesting the power; the conclusion, therefore, presses on us, that the power does not depend upon these cells. When at rest, and in an ordinary natural state, the animal is never seen to dart out these threads, nor upon capturing his prey; it is only when some force is used to dislodge him from some spot to which he has securely attached himself, that he presses or squeezes out these threads; more for the purpose of compressing himself into a closer and smaller mass, to add to the difficulty of detaching him.

*Actiniae* do not effect their preparation of nutriment by *chemical* means; that is, they do not, in the strict sense of the term, *digest*, but simply derive nourishment by mechanical pressure, exerted upon any particle of food that they may draw into their stomachs. This has been proved by experiments made after the manner of Reaumur. A small piece of meat having been put into a quill, and allowed to remain in the stomach of the *Actinia* sufficiently long, and then withdrawn, *no solvent* fluid is found to have acted upon it. When placed under the microscope the muscle fibres are not at all disintegrated, and the striæ are as perfect as before the experiment, with the exception of a pulpiness and loss of colour, as in any ordinary mechanical maceration.

“Light has been thrown upon the reproductive system of the *Actiniae* by M. Jules Haime, in the *Annales des Sciences Naturelles*, 1854, 4<sup>10me</sup> série, tom. i.; which contains accurate and detailed descriptions and plates of the disposition of ova and spermatozoa in the *Actiniae*. To find the ovaries it is only necessary to take a live animal,

and with a rapid, but not deep incision, lay open the envelope from the outside; a series of convoluted bands will bulge through the opening, but if these are quickly brushed aside, certain lobular or grape-like masses will be perceived, darker in colour, and almost entirely hidden by these bands, but growing from the wall of the envelope. They do not appear to have a fixed locality, as they may be found near the base, about the centre, or close to the disc; it is, therefore, sometimes necessary to make three or four incisions before detecting them; once seen, they will be easily distinguished from the convoluted bands, although very difficult to remove them without removing some of the bands."

The manner in which the aggregation of zooids, constituting a compound coral, is developed from the primarily solitary Actinozoic embryo, exercises an all-important influence upon the form of the *Corallum*. Sometimes, as in most *Turbinoidæ*, neither gemmation nor fission ever take place. In the *Oculinidæ*, gemmation alone occurs, and in these and other *Actinozoa*, the development of buds takes place either from the base or from the sides of a corallite, or from the cœnosarc. Certain of the extinct *Rugosa*, however, exhibit *calicular* gemmation, the buds being developed from the oral disc or cup, which can hardly have retained any active vitality. The massive coralla of some *Cyathophyllidæ*, thus standing like inverted pyramids, all the buds supported upon the narrow surface of the primary zooid, have a very singular and striking aspect. The *Beroidæ* appear at first to differ very widely from the type of structure which prevails among the other *Actinozoa*, but a close examination of any of their forms suffices to demonstrate the justice of the conclusion advocated by Frey and Leuckart, as to their essential identity with *Actinia*. The *Cydippe*, which abounds upon our own coasts, affords, from its small size and extreme transparency, an excellent subject for the student of *Beroidæ*. It is impossible here to enter into the varieties of form presented by the *Beroidæ*, and which chiefly arise from the development of lateral lobes, a process which is carried to so great a length in *Cestum* that the body becomes ribbon-like. The *Beroidæ* and the *Actinidæ*

inhabit the shallower and even deeper parts of all seas; *Alcyonidæ* and *Gorgonidæ* are found at considerable depths; *Corallium* and *Gorgonia* abound both in cold and warm latitudes. The *Perforata* and *Tabulata* almost exclusively haunt the shallower parts of warm seas, but the *Turbinolidæ* extend into very cold regions. The whole group of the *Rugosa* is now extinct, only one genus, *Holocystis*, having survived even the palæozoic period. Not only heat, but light, and probably rapid and effectual aëration, are essential conditions for the activity of the reef-building *Actinozoa*. Different species of corals exhibit great differences as to the rapidity of growth, and the depth at which they flourish best; and no one must be taken as evidence for another in these respects. Certain species of *Perforata*, *Madreporidæ*, and *Poritidæ*, appear to be at once the fastest growers, and those which delight in the shallowest waters. The *Astræidæ* among the *Aporosa*, and *Seriatopora* among the *Tabulata*, live at greater depths, and are probably slower of increase. The most careful accounts of the structure of corals extant, are from the pens of M. M. Milne Edwards and Haime, published at various times in the *Annales des Sciences Naturelles*, in the *Mémoires du Museum*, and in the publications of the Palæontographical Society; and by Mr. Darwin, whose beautiful work on *Coral Reefs* will amply repay perusal.

With these brief introductory observations, the principal part of which have been derived from Professor Huxley's lectures, we proceed to direct the reader's attention to some of the more interesting generic forms.

**HYDRA, FRESH-WATER POLYPE.**—In polyopes of this family the body generally consists of a homogeneous aggregation of vesicular granules, held together by a sort of glairy intercellular substance, and capable of great extension and contraction; so that the creature can at pleasure assume a great variety of forms, extending its body and tentacles until the latter become so fine as to be almost invisible, and again retracting itself until it acquires the appearance of a small gelatinous mass. The tentacles which surround the anterior extremity are irregular in number; they are capable of extension to a very great

length when seeking for prey ; and on coming in contact with any object floating through the water, they immediately twine round it, and convey it to the mouth. In some genera the tentacles appear to be tubular, the internal cavity being continuous with that of the stomach. The mouth is situated in the centre of the circle of tentacles, and leads directly into a simple digestive cavity.

*Hydræ* are found in ponds and rivulets, adhering to the leaves of aquatic plants, or twigs and sticks that have fallen into the water. When stretched out, they resemble pieces of hair, from a quarter to three-quarters of an inch in length. Some are of a light-green colour, and others brown or yellow ; that is, the five varieties found in England. It received its name from its several long arms being supposed to resemble the fifty-headed water-serpent called *Hydra*, which was destroyed by Hercules in the lake of Lerna, as we are informed in fabulous history. Leeuwenhoek, in 1703, first drew attention to the *Hydra* ; and in 1739, M. Trembley from the Hague, more accurately described its habits.

Polypes are not vegetarians ; M. Trembley fed *Hydræ* on minced fish, beef, mutton, and veal ; they are voracious and active in seizing worms and larvæ much larger than themselves, which they devour with avidity. They carefully and adroitly bring their food towards their mouth ; and when near, pounce upon it with eagerness. To make up for the want of teeth, the mouth enlarges to receive the food brought to it by the arms that have twined around the sacrifice. The red worm that tinges the mud of the Thames appears to be the dainty dish they like best to have set before them. Dr. Mantell saw the *lasso* of a polype thrown over two worms at the same time ; yet they could not escape, and lost all power of motion.

Dr. Johnston states : " Sometimes it happens that two polypes will seize upon the same worm, when a struggle for the prey ensues, in which the strongest gains, of course, the victory ; or each polype begins quietly to swallow his portion, and continues to gulp down his half, until the mouths of the pair near, and come at length into actual contact. The rest that now ensues, appears to prove that they are sensible of their untoward position, from which

they are frequently liberated by the opportune break of the worm, when each obtains his share; but should the prey prove too tough, woe to the unready! the more resolute dilates the mouth to the requisite extent, and deliberately swallows his opponent; sometimes partially, so as, however, to compel the discharge of the bait; while at other times the entire polype is engulfed! But a polype is no fitting food for a polype, and his capacity of endurance saves him from this living tomb; for, after a time, when the worm is sucked out of him, the sufferer is disgorged with no other loss than his dinner."

The organ of prehension, which is called the *hasta*, consists of a sac opening at the surface of the tentacle, within which, at the lower portion, is placed a saucer-shaped vesicle, supporting a minute ovate body, which again bears a sharp calcareous piece called the *sagitta*, arrow. This can be pushed out at the pleasure of the animal, serving to roughen the surface of the tentacle, and afford a much firmer hold of its living prey. The polype increases rapidly: a portion of the body swells, a young one puts forth its head from the part, its arms begin to grow, it then is industrious in catching food; its body, communicating with that of its parent and participating in the fears and actions of its progenitor, is finally cast off to wander the world of waters. Sometimes, ere yet free from parental attachment, it has two generations on its own body. Four or five offspring are thus produced weekly. But the most extraordinary circumstance in respect to this creature is thus described by M. Trembley: "If one of them be cut in two, the fore part, which contains the head and mouth and arms, lengthens itself, creeps, and eats on the same day. The tail part forms a head and mouth at the wounded end, and shoots forth arms more or less speedily, as the heat is favourable. If the polype be cut the long way through the head, stomach, and body, each part is half a pipe, with half a head, half a mouth, and some of the arms at one of its ends. The edges of these half pipes gradually round themselves and unite, beginning at the tail end; and the half mouth and half stomach of each becomes complete. A polype has been cut lengthways at seven in the morning, and in eight hours afterwards

each part has devoured a worm as long as itself." Still more wonderful is the fact, that if turned inside out, the parts at once accommodate themselves to their new condition, and carry on all their functions as before the accident. Indeed, this animal seems so peculiarly endowed with the germs of vitality in every part of its body, that it may be cut into ten pieces, and everyone will become a new, perfect, living animal. This seems bordering on the vegetable kingdom, in which it is common to propagate by means of slips from the mature shrub.

The best known of the British species are *Hydra vulgaris*, Common polype, *H. viridis*, Green polype, *H. Fusca*, Brown polype, *H. verrucosa*, and *H. lutea*.

Every reflecting person who reads even the slight sketch we have given of this polype must be struck with astonishment at a creature so primitive in structure, possessing the actions, sensations, and powers of higher organised beings. The stomach is but one simple structureless membrane or cell, the external surface-cells forming a kind of double skin, the inside a mere wall of cells running crosswise, possessed of a velvet-like surface, and red or brown coloured grains held together by a glutinous substance. This singular formation, with some of the functions of animal life, has led to many learned surmises and discussions tending to the most important results in the science of physiology.

**TUBULARIADÆ.**—The *Tubular* or *Vaginated Polypes* are of an arborescent appearance; the animals live near the ends of branches, and are found attached to stones, seaweeds, and shells.<sup>1</sup> The *Tubularia indivisa*, "Individed tubes," are found on shells, with a living head resembling a fine scarlet cluster of blossoms. Ellis says, "they seem part of an oat-straw with the joints cut off." At the summit protrudes the scarlet-coloured polypes, well furnished with tentacula, and connected with a pinkish fluid that fills the tubes. It was in these that Dr. Roget discovered the singular peculiarity of a circulation, similar to that seen in many plants. He says, "In a specimen of the *Tubu-*

(1) These are grouped with *Hydracida*, and at the head of the family stand Van Beneden's *Hydractinia*; and Guertner's *Coryme*.



*laria indivisa*, when magnified one hundred times, a current of particles was seen within the tubular stem of the polype, strikingly resembling, in steadiness and continuity of its stream, the vegetable circulation in the *chara*. Its general course was parallel to the slightly spiral lines of irregular spots on the surface of the tube, ascending on the one side, and descending on the other; each of the opposite currents occupying one-half of the circumference of the cylindric cavity. At the knots, or contracted parts of the tube, slight eddies were noticed in the currents; and at each end of the tube the particles were seen to turn round, and pass over to the other side.

“The particles carried by it present an analogy to those of the blood in the higher animals of one side, and of the sap of vegetables on the other. Some of them appear to be derived from the digested food, and others from the melting down of parts absorbed; but it would be highly interesting to ascertain distinctly how they are produced, and what is the office they perform, as well as the true character of their remarkable activity and seemingly spontaneous motions; for the hypothesis of their individual vitality is too startling to be adopted without good evidence.”

Respecting the singular property of the head dropping off, *Tubularia indivisa*, Sir J. G. Dalyell observes, “The head is deciduous, falling in general soon after recovery from the sea. It is regenerated at intervals of from ten days to several weeks, but with the number of external organs successively diminishing, though the stem is always elongated. It seems to rise within this tubular stem from below, and to be dependent on the presence of the internal tenacious matter with which the tube is occupied. A head springs from the remaining stem, cut off very near the root; and a redundancy of heads may be obtained from artificial sections. Thus, twenty-two heads were produced through the course of 150 days from three sections of a single stem.”

Included in this family are the *T. ramous*, *T. ramea*, the branched pipe-coralline, with its dark brown stem terminating in clusters of red and yellow polyps; and the

*Hermia Glandulosa* of Dr. Johnston, who says—"I found the name in Shakspeare :

' What wicked and dissembling glass of mine,  
Made me compare with Hermia's spherish eyne?'"

The fancy that the glands which surround the heads were the guardians of the animal, its "spherish eyne," suggested the name here adopted.

These polypes are adherent by a tubular fibre, and creep along the surface of the object on which they grow; they are seldom an inch in height, irregularly branched; the stem filiform, tubular, horny, sub-pellucid, wrinkled, and sometimes ringed at intervals, especially at the origin of the branches, each of which is terminated with an oval or club-shaped head of a reddish colour, and armed with short scattered tentacula, tipped with a globular apex. The ends of the branches are not perforated, but completely covered with a continuation of the horny sheath of the stem. The animal can bend its armed hands at will, or give to any separate tentaculum a distinct motion and direction; but all its movements are very slow.

The beautiful little *Coryne stauridia*, "Slender coryne,"

(fig. 232, No. 1), is thus described by Mr. Gosse: "It was found by me adhering to the footstalk of a *Rhodymenia*, about which it creeps in the form of a white thread; by placing both beneath the microscope, this thread appeared cylindrical and tubular, perfectly transparent, without wrinkles, but permeated by a central core, apparently cellular in texture, and hollow; within which a rather slow

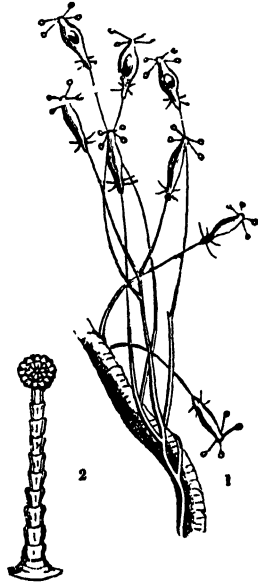

Fig. 232.

1, *Coryne stauridia*, Slender  
Coryne. 2, A tubercle detached,  
and magnified 200 diameters.

circulation of globules, few in number, and remote, is perceived. It sends off numerous branches; the terminal head of which is oblong, cylindrical, rounded at the end. At the extreme point are fixed four tentacula of the usual form, long, slender, and furnished with globular heads; one of which is shown at No. 2, detached, and more highly magnified. It is much infested with parasites: a vorticella grows on it, and a sort of vibrio; the latter in immense numbers, forming aggregated clusters here and there; the individuals adhering to each other, and projecting in bristling points in every direction. These animalcules vary in length; some being as long as 1-80th of an inch, with a diameter of 1-7000th of an inch. They are straight, equal in thickness throughout, and marked with distinct transverse lines; they bend themselves about with considerable activity, and frequently adhere to the polype by one extremity, while the remainder projects freely."

Some of this family attain a considerable size; the *Corymorpha nutans*, one of the most beautiful of the group, attains a length of four inches and a half. Of the beauty of its appearance, Forbes, who discovered it in the British seas, speaks in the following terms: "When placed in a vessel of sea-water, it presented the appearance of a beautiful flower. Its head gracefully nodded (whence the appropriate specific appellation given it by Sars), bending the upper part of its stem. It waved its long tentacula to and fro at pleasure, but seemed to have no power of contracting them. It could not be regarded as by any means an apathetic animal, and its beauty excited the admiration of all who saw it." The general colour of the creature is a delicate pink, with longitudinal lines of brownish or red dots. The tentacles are very numerous and long, and of a white colour; and the ovaries, which are situated immediately above the circle of tentacles, are orange. Most of the *Tubulariadae* inhabit the sea; one species, the *Cordylophora lacustris*, is found in the dock of the Grand Canal, Dublin, in water which is perfectly fresh.

**SERTULARIADÆ.**—This interesting and beautiful family of polypes derive their name from their *plant*-like appearance, and are readily attainable on our own sea-shores.

Linuæus made a large genus of them; but Lamarck considerably reduced his classification. There are seventeen British species, which Dr. Fleming proposes to divide in two groups, with stems simple or compound.

The tentacles of *Sertularia* are abundantly supplied with cilia; the cells are pitcher-shaped, arranged alternately, or in pairs obliquely, not exactly opposite, on the stem and branches of the polyidom, which is horny. Lamouroux classed with this family *Thoa*; of which there have been several kinds found in Great Britain. The name is supposed to be derived from the Greek word for *sharp*; but we think, with Dr. Johnston, that it more probably is a mis-spelling of *Thoe*, one of the Nereids, nymphs of the sea. They are generally of a brown and yellow colour, branched, and from an inch and a half to six inches in height.

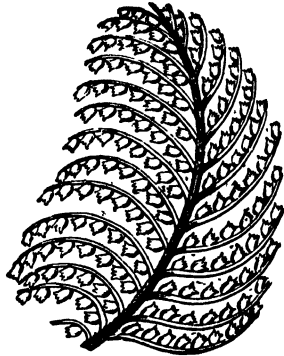

Fig. 233.—Sickle-Coralline. *Sertularia Polypidom* of.

*Sertularia pumila*.—This is parasitic, and spreads its brown-coloured shoots over various fuci and sea-shells; but rarely attains more than half an inch in height. Stewart says:—"This species, and probably many others, in some particular states of the atmosphere, emits a phosphorescent light in the dark. If a leaf of the *fucus serratus*, with *Sertularia* upon it, receives a smart stroke in the dark, the whole is most beautifully illuminated, every denticle seeming to be on fire."

On the south-eastern coast of England the most common kind found is the *Sertularia setacea*, or *operculata*, Seahair-Coralline: it reaches from six inches and upwards in height, and grows in tufts, like bunches of hair. The stem and branches seem composed of separate pieces, fitting accurately into each other, and terminate in a star-like head, from which radiate the tentacles. Mr. Lister was observing a living specimen, when a little

globular animalcule swam rapidly by one of the expanded polypes; the latter immediately contracted, seized the globule, and brought it to the mouth or central opening by its tentacula; these gradually opened again, with



— 234.

1, *Plumularia pinnata*, Feather polype.

2, *Doris tuberculata*, Sea slug.

the exception of one, which remained folded, with its extremity on the animalcule. The mouth instantly seemed filled with cilia, which, closing over the prey, was carried slowly down its stomach; here it was imperfectly seen, and soon disappeared.

Appertaining to this family are Dr. Fleming's *Thuiarea*, so named by him from their resemblance to a cedar-tree; some kinds look more like a knobbed thornstick with a bottle-clearer at the top; others resemble a fir-tree. *Antennularia* are so called from their resemblance to a lobster's antenna. They are plentiful on the north-eastern coast of England and the coast of Ireland, brown in colour, and covered with hair-like little branches; and as the hairy process is continued up its jointed stem, it is sometimes denominated *Sea-beard*. Dr. Hassall's *Coppinia* is another very interesting species.

The *Plumularia*, so named from their shoots and offsets being plumose, are an extensive and beautiful family. Professor Grant thus describes the *Plumularia falcata*: "The Sickle Coralline is common in the deeper parts of the Frith of Forth; its vesicles are very numerous, and its ova are in full maturity at the beginning of May. The ova are large, of a light-brown colour, semi-opaque, spherical, composed of minute transparent granules,

ciliated on the surface, and distinctly irritable. There are only two ova in each vesicle; so that they do not require any external capsules, like those of the *Campanularia*, to allow them sufficient space to come to maturity. On placing an entire vesicle, with its two ova, under the microscope, we perceive through the transparent sides the cilia vibrating on the surface of the contained ova, and the currents produced in the fluid within by their motion. When we open the vesicles with two needles, in a drop of sea-water, the ova glide to and fro through the water, at first slowly, but afterwards more quickly, and their cilia propel them with the same part always forward. They are highly irritable, and frequently contract their bodies so as to exhibit those singular changes of form spoken of by Cavolini. These contractions are particularly observed when they come in contact with a hair, a filament of conferva, a grain of sand, or any minute object; and they are likewise frequent and remarkable at the time when the ovum is busied in attaching its body permanently to the surface of the glass. After fixing themselves, they become flat and circular, and the more opaque parts of the ova assume a radiated appearance; so that they now appear, even to the naked eye, like so many minute grey-coloured stars, having the interstices between the rays filled with a colourless transparent matter, which seems to harden into horn. The grey matter swells in the centre, where the rays meet, and rises perpendicularly upwards surrounded by the transparent horny matter, so as to form the trunk of the future zoophyte. The rays first formed are obviously the fleshy central substance of the roots; and the portion of that substance which grows perpendicularly upwards, forms the fleshy central part of the stem. As early as I could observe the stem, it was open at the top; and when it bifurcated to form two branches, both were open at their extremities; but the fleshy central matter had nowhere developed itself as yet into the form of a polype. Polypes, therefore, are not the first formed of this zoophyte, but appear long after the formation of the root and stem, as the leaves and flowers of a plant."

Attached to fucus and shells in abundance on the southern coast of England, may be found the *Plumularia cristata*. It

is affixed by a horny, branching, interlacing, tubular fibre to the object on which it grows. At different parts there are plumose shoots, usually about an inch in height. The cells are of a yellow colour, set in the stalk, of a bell-shape, and are compared to the flower of the lily of the valley; the rim is cut into eight equal teeth; the polype minute and delicate, tentacles ten and annulate, with a mouth infundibuliform in shape.

"Each plume," says Mr. Lister, in reference to a specimen of this species, "might comprise from 400 to 500 polypes;" "and a specimen," writes Dr. Johnston, "of no unusual size, before me, has twelve plumes, with certainly not fewer cells on each than the larger number mentioned: thus giving 6000 polypes as the tenantry of a single poly-pidom! Now, many such specimens, all united too by a common fibre, and all the offshoots of one common parent, are often located on one sea-weed, the site then of a population which nor London nor Pekin can rival."

*Plumularia pinnata*, "Feather polyp," (represented magnified in fig. 234, No. 1,) is as remarkable for the elegance of its form, as its likeness to the feather of a pen. It serves not among the denizens of the deep the same purpose as its earthly prototype; nature writes her works in hieroglyphics formed by the objects themselves. It is plumous, and the cells in a close row, cup-like, and supported on the under side by a lengthened spinous process.

An interest pervades the valuable work of Dr. Johnston, arising from the circumstance that the plates and woodcuts which adorn the volume are, with few exceptions, engraved from drawings made for it by Mrs. Johnston, who also engraved several of them; and the Doctor states, he could not have undertaken the history without such assistance. From this devotion too, and understanding of the subject, it was natural, when an opportunity presented itself, to write in the catalogue of Zoophytes a lasting memorial of his "colleague:" and thus is written the graceful compliment of the beautiful *Plumularia Catharina*: "Catharine's Feather," whose stem is plumous, pinnæ opposite, bent inwards; cells distant, campanulate, with an even margin; vesicles scattered, pear-shaped, smooth.

Found in old shells, corallines, &c., in deep water; in Frith of Forth and in Berwick Bay, by Dr. Coldstream.

The sub-families, *Campanularia* and *Laomedea*, are also frequently found on our shores; they possess a simple circle of oilia on their feelers or arms, with pitcher-shaped cells on stalks that branch, twist, or climb on an axis.

*Campanularia volubilis*, "Twining polype," is the commonest of the family: it is parasitical, and infests the antennæ of crabs; its stem is filiform, and at the end of its slender branches are situated the cells containing the polypes. The polype itself is slender when protruded, somewhat like *Plumularia pinnata*, and becomes dilated at the base into a sort of foot which spreads over the diaphragm; widening again at the top, where it fills the mouth of the cell, and gives origin to about twenty slender tentacula, set in two or three series. From the central space, which is surrounded by tentacles, a large fleshy mouth protrudes, somewhat funnel-shaped, with lips, endowed with the power of protrusion and contraction; these appear to be very sensitive. Mr. Gosse found the species in great abundance round Small-mouth Caves.

The *Campanularia gelatinosa* and its beautiful bell-shaped cells, out of which the animals protrude, giving the semblance of a green flower on a delicate pink stalk. It is indeed an interesting object, and currents may be seen in its tubes. Dr. Johnston says, "On Saturday, May 29th, 1837, a specimen of *Campanularia gelatinosa* was procured from the shore; and after having ascertained that the polypes were active and entire, it was placed in a saucer of sea-water. Here it remained undisturbed until Monday afternoon, when all the polypes had disappeared. Some cells were empty, or nearly so; others were half-filled with the wasted body of the polype, which had lost, however, every vestige of their tentacula. The water had become putrid, and the specimen was therefore removed to another vessel with pure water, and again set aside. On examining it on the Thursday, June 1st; the cells were evidently filling again, although no tentacula were visibly protruded; but on the afternoon of Friday, June 2d, every cell had its polype, complete, and



displayed in the greatest perfection. Had these singular facts been known to Linnæus, how eagerly and effectively would he have impressed them into the support of his favourite theory! Like the flowers of the field, the heads, or 'flores,' of these polypidoms expand their petaloid arms, which after a time fall, like blighted blossoms off a tree; they do become 'old in their youth,' and, rendered hebetous and unfit for duty or ornament by age or accident, the common trunk throws them off, and supplies its wants by ever-young and vigorous growths. The phenomena are of those which justly challenge admiration, and excuse a sober scepticism, so alien are they to all we are accustomed to observe in more familiar organisms. Faithful observation renders the fact undeniable; but besides that, a reflection on the history of the *Hydra* might almost have led us to anticipate such events in the life of these Zoophytes. 'Verily, for mine own part,' observes Baker, 'the more I look into Nature's works, the sooner am I induced to believe of her even those things that seem incredible.'"

**ACTINIADÆ.**—All persons accustomed to wander by the sea-shore must have admired the livid green, dark little jelly-masses adhering to the rocks,—called *Actinia*, from a Greek word signifying a ray,—and left in some little pool by the ebbing tide, living as they do principally within high and low water mark, and expanding their broad surfaces and fringing feelers to the finger of inquisitive youth, so often thrust into the centre, to feel the effect of the suction and rasping, as the poor animal draws itself up in the form of a little fleshy hillock.

Some few years ago it might have been necessary to explain what we meant by an *Actinia*, or "Sea-anemone." thanks to the universal distribution of *aquaria*, this beautiful class of animals is no longer unfamiliar to the world. Nevertheless, much as people read, and hear, and write, and observe in the matter, we do not hesitate to say that the natural arrangement of these animals is as little known in the world of naturalists, as their very existence was a short time ago to the world at large. A familiar instance of this position may be given in a few words. Dr. Johnston (*Hist. Brit. Zooph.*) describes three distinct

*Actinia*, under the names of *A. troglodytes* (the Cave-dweller), *A. viduata*, and *A. Anguicomma* (the Snaky-locked). Mr. Gosse, in his *Devonshire Coast*, makes *A. viduata* synonymous with *A. anguicomma*; and gives a drawing and a description of an anemone which he calls *anguicomma*, and which closely resembles undoubted specimens of Johnston's *A. troglodytes*. Many objections might be taken to Mr. Gosse's description of *species*, which he makes out from the number of their tentacles, although found in company with each other, and, as he justly remarks, are of "the same size and form."

Of the voracity of the *actinia* many remarkable statements have been made known; it may nevertheless be kept in the *aquarium* for many months, if supplied with

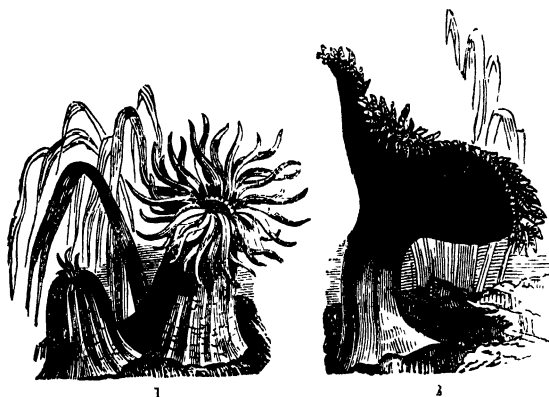

Fig. 235.

1, *Actinia rubra* Sea marigold, near which is one shown retracted. 2, *Actinia bellis*, Daisy sea-anemone (side view).

water containing particles of organic matter. Although the several structures of *actinia* admit of being resolved into two foundation membranes, an ectoderm and an endoderm, yet each of these, more especially the former, manifests a tendency to differentiate into secondary layers, so that several apparently distinct tissues are recognisable in the body of the fully-formed animal. Both membranes have their free surfaces more or less covered with cilia

displayed; any margin of the disc is furnished with a series of white, the right blue specks, which some observers believe to be rudimentary organs of vision; but they are rather to be regarded as sac-shaped prolongations of the outer layer. A transverse section of the body of the *actinia* exhibits two concentric tubes, the outer being constituted by the body-wall, and the inner by the digestive sac. The wide space which intervenes between these tubes is divided by a number of radiating partitions, or "mesenteries," arriving at definite intervals from the inner surface of the body wall. To the face of the mesenteries are attached the reproductive organs, which occur as

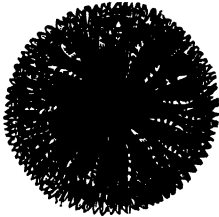

Fig. 236 — *Actinia bellis*, seen from above with its crown of tentacles fully expanded.

thickened bands of a reddish tint, at certain periods filled with ova. The animal has the power of effecting considerable alterations of form, as well as of locomotion; although if well supplied with food it attaches itself so firmly as not to be removed without laceration of its base.

Allied to the family *Actiniæ* are those laminated, inverted pyramidal looking bodies, *Fungia*, commonly called "Sea-mushrooms," often found in great variety. The colour of the polypidom is white, of a flattened round shape, made up of thin plates or scales, embedded in a translucent jelly-like substance, and within which is a large polype; the foot-stalk, by means of which the animal is attached to the rock whereon it lives, is of a calcareous nature. Ellis says: "The more elevated folds or plaits have borders like the denticulated edge of needlework-lace. These are covered with innumerable oblong vesicles, formed of a gelatinous substance, which appear alive under water, and may be observed to move like an insect. I have observed these radiating folds of the animal, which secrete the lamellæ, and which shrink between them when the animal contracts itself on being disturbed. They are constantly moving in tremulous undulations; but the vesicles appeared to me to be air-

vessels placed along the edges of the folds, and the vesicles disappeared when the animal was touched."

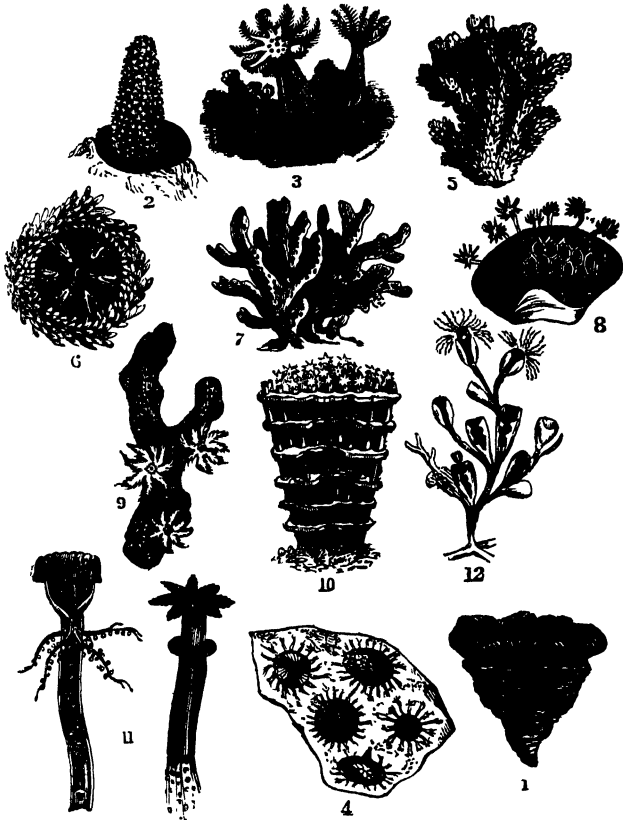

Fig. 237.—Actinosea.

1, *Fungia agariciformis*. 2, *Alcyonium*, *Cydonium Mulleri*. 3, *Cydonium*, polypes protruding and tentacles expanded, others closed. 4, *Zoantharia*, viewed from above. 5, *Madrepore Abrotanotæ*. 6, *Madrepore*, cell slightly magnified, showing internal structure. 7, *Corallidæ*; Coral. 8, Coral, polypes protruding from the cells. 9, *Gorgonia nobilis*, polypes expanded. 10, *Tubipora musica*. 11, a tube of same, with polype expanded, and one cut longitudinally to show internal structure. 12, *Sertularia*, polypes protruded; and others withdrawn into polyridoma.

**MADREPORIDÆ.** — *Madrepores*, *Mother-pores*, "tree corals," differ from other corals in not having a small skeleton, but one inducted by numbers of small cells for the residence of the living animal : these are very visible in the *Madrepore muricata*, when the polype is dead and decomposed ; but most distinct in the *Oculina ramea*, as they are situated at the apparently broken stumps that branch from the trunk of the skeleton (fig. 237, No. 5). Every branch is seen to be covered with multitudes of small pits or dots, scarcely visible to the unassisted vision ; but, when viewed under the microscope, are found to be cells of the most beautiful construction, remarkable alike for their mathematical regularity and the exquisite fineness of the materials employed in their composition. A magnified drawing of a cell is given at No. 6. The living polypes are exquisite objects for a low power ; their varying colours adding to the richness of the hues covering the bed of the ocean.

**ASTEROIDÆ.**—A group of Zoophytes received the name of *Asteroida* from the polypes presenting the form of a star. The fleshy mass is supported by hard calcareous spicula ; some having thick branching processes, performing the part of the skeleton in the human frame. This central internal support is usually denominated the axis. The fleshy mass, or covering, is possessed of sensation, and is ramified by vascular tubes and canals for the sustenance of the animal, and carrying on its vital functions. Included in this genera are *Gorgoniadæ*, *Pennatulidæ*, *Alcyonidæ*, *Isidæ*, and *Tubiporidæ*.

The term coral, or *corallum*, is restricted to the hard structures deposited in the tissues or by the tissues of the *Actinozoa*. The whole of this class, however, which are thought to possess a framework called a "coral," are not coralligenous. The *Ctenophora*, and several species, as the soft-bodied non-adherent *Zoantharia*, deposit no corallum. There are two kinds of such structure, one called the "sclerobasic" corallum, a true tegumentary excretion, formed by the successive growths from the outer surface of the ocderon ; and another, the "sclerodermic" corallum, deposited within the tissues of the animal. Two principal modifications of form distinguish the sclerobasis : in

some it constitutes a free axis, virgate or primately divided and varying in thickness; in others it is attached, simple or branched, and plant-like, as in *Gorgonidæ*, from which circumstance the name of "Sea-shrubs" has been applied to them. In the *Gorgonia* we have, in addition to the basal corallum, a deposition of tissue secretions, sclerodermic spicules appear within the substance of the investing membrane, and when the animal is dried, and the soft parts washed away, a thin layer of calcareous spicules is seen adhering to the horny sclerobasis. M. Valenciennes made out five kinds of spicules, or sclerites, which he severally designates capitate, fusiform, mass'ive, stellate, and squamous. These spicules form interesting objects for the microscope, mounted dry or in balsam. "The parts of a typical corallite are these: first, an outer wall, or 'theca,' somewhat cylindrical in form, terminating distally in a cup-like excavation, or 'calice,' and having its central axis traversed by a columella. The space between this and the theca is divided into loculi, or chambers, by a number of radiating vertical partitions, the septa. These do not, in certain instances, quite reach the columella, but are broken up into upright pillars or pali, arranged in one, two, or more circular rows termed 'coronets;' all of which are best brought into view by transverse section." Longitudinal division of a corallite shows certain modifications and changes in the partitions, or dissepiments; and the septa are seen to be covered with "styliform or echinulate processes," which meet to form "synapticulæ or transverse props, extending across the loculi like the bars of a grate." Nevertheless, there is no difficulty in recognising the close resemblance that such an organism presents to the typical *Actinia*, and they have accordingly been classed with the *Actinozoa*.

The *Gorgonidæ* are permanently fixed, as are many other corallitic actinozoa, and multiply by continuous gemmation. As to their muscular system, most of them appear to be well endowed in this particular. *Pernatulidæ* possess so much muscular contractibility, that Mr. Darwin relates, that on the south coast of America he observed "a Sea-pen which, on being touched, forcibly drew back into the sand some inches of its compound, polypi-covered

mass." The muscular fibre, however, is wanting in those distinct transverse striæ, so fully developed in the muscle of the higher orders of animals.

The ova of the compound Actiniæ are of a rounded form, often brilliantly coloured, and their embryos, by a series of gradual changes, finally assume the appearance and condition of the parent. Milne Edwards, to whom we are indebted for most of our knowledge of the reproductive processes of actinozoa, insists on the necessity of distinguishing between that of gemmation and fission, the polype-bud at first being no more than a protuberance from the parent "enclosing a cæcal diverticulum of the somatic cavity." Both simple and composite *Fungidæ* occur, and multiply by lateral gemmation.

The *Gorgonidæ* differ from all other Alcyonaria in having an erect branching cænosarc so firmly rooted that they are reputed to rival oaks in size; but it is doubtful whether they ever attain to a height of more than five or six feet.

*Pennatulidæ*. — This family derives its name from *penna*, a quill, and the spicula closely resemble a pen, one of which is represented in fig. 239, No. 1. The polypes are fleshy white, provided with eight rather long retractile tentacula, beautifully ciliated on the inner aspect with two series of short processes, and strengthened moreover with crystalline spicula, there being a row of these up the stalk: the series of smaller processes are ciliated. The mouth, in the centre of the tentacula, is somewhat angular, and bounded by a white ligament, a process from which encircles the base of each tentaculum, and thus seems to issue from an aperture. The ova lie between the membraneous part of the pinnæ; they are globular, of a yellowish colour, and by a little pressure can be made to pass through the mouth.

Dr. Grant writes: "A more singular and beautiful spectacle could scarcely be conceived than that of a deep purple *Pennatula phosphorea*, with all its delicate transparent polypes expanded and emitting their usual brilliant phosphorescent light, sailing through the still and dark abyss, by the regular and synchronous pulsations of the minute fringed arms of the polypes." The power of

locomotion is doubted by other writers, and the pale blue light is said only to be emitted when under the influence of some degree of irritation.

*Alcyonaria*.—Actinozoa, in which each polype is furnished with eight primately fringed tentacles. Corallum sclerobasic or spicular.

*Alcyonium digitatum*, "Fingered Alcyonium" (Fig. 237, No. 2).—The French call it *Main de Mer*, "sea-hand," the Germans *Diebshand*, "thief's hand." Sometimes they are very small; but when larger are named by the fishermen *Cows'-paps*, and *Dead Men's Hands*. The mass, at first repulsive, when placed in sea-water gradually expands into delicately pellucid polypes, with crowns of beautiful tentacula. The cells occupied by the polypes are placed at the terminations of canals which run through the polypidom, and which, by their union with each other, serve to maintain a communication between the individual polypes constituting the mass. The rest of the polypidom is made up of a transparent gelatinous substance, containing calcareous spicula, and pervaded by numerous small fibres, which form a sort of irregular network. *Alcyonidæ* are always attached to submarine bodies. The species already mentioned is exceedingly common round our coasts; so much so that, as Dr. Johnston says, "scarce a shell or stone can be dredged from the deep that does not serve as a support to one or more specimens."

The ova, as Professor Grant remarks, placed under the microscope, and viewed by transmitted light, appear as opaque spheres surrounded by a thin transparent margin, which increase in thickness as the ova begin to grow, and such of the ova as lie in contact unite and grow as one ovum. A rapid current in the water immediately around each ovum, drawing along with it all the loose particles and floating animalcules, is distinctly seen moving with an equal velocity as in other ciliated ova; and a zone of very minute vibrating cilia is quite perceptible, surrounding the transparent margin of all the ova.

TUBIPORIDÆ.—To this family belongs the handsome *Tubipora musica*, "Organ-pipe Coral" (fig. 237, No. 10), the polypidom of which is composed of parallel tubes, united by



lateral plates, or transverse partitions, placed at regular distances; in this manner large masses, consisting of a congeries of pipes or tubes, are formed. When the animals are alive, each tube contains a polype of a beautiful bright-green colour, and the upper part of the surface is covered with a gelatinous mass, formed by a confluence of the polypes. This species occurs in great abundance on the coasts of New South Wales, of the Red Sea, and of the Molucca Islands, varying in colour from a bright red to a deep orange. It grows in large hemispherical masses, from one to two feet in circumstance, which first appear as small specks adhering to a shell or rock; as they increase, the tubes resemble a group of diverging rays, and at length other tubes are produced on the transverse plates, thus filling up the intervals, and constituting one uniform tubular mass; the surface being covered with a green fleshy substance beset with stellate polypes.

Dr. Dana, who devoted much time to the examination of the corals of the Pacific, thus writes of their diversities of form and character:—"Trees of coral are well known; and, although not emulating in size the oaks of our forests—for they do not exceed six or eight feet in height—they are gracefully branched, and the whole surface blooms with coral polypes in place of leaves and flowers. Shrubbery, turfts of rushes, beds of pinks, and feathery mosses, are most exactly imitated. Many species spread out in broad leaves or folia, and resemble some large-leaved plant just unfolding; when alive, the surface of each leaf is covered with polype flowers. The cactus, the lichen, clinging to the rock, and the fungus in all its varieties, have their numerous representatives. Besides these forms imitating vegetation, there are gracefully-modelled vases, some of which are three or four feet in diameter, made up of a network of branches and branchlets and sprigs of flowers. There are also solid coral hemispheres like domes among the vases and shrubbery, occasionally ten or even twenty feet in diameter, whose symmetrical surface is gorgeously decked with polype-stars of purple and emerald green."

Nothing can be more impressive than the manner in which these diminutive creatures carry out their stupendous undertakings, which we denominate instinct, intelli

gence, or design. Commencing betimes from a depth of a thousand or fifteen hundred feet, they work upwards in a perpendicular direction ; and on arriving at the surface form a crescent, presenting the back of the arch in that direction from which the storms and winds generally proceed : by which means the wall protects the busy millions at work beneath and within. These breakwaters will resist more powerful seas than if formed of granite ; rising as they do in a mighty expanse of water, exposed to the utmost powers of the heavy and tumultuous billows that eternally lash against them.

As we glance at the map of the world, and think of the profusion of fragrant vegetation and delicious food almost spontaneously produced on the lovely sunny islands of the broad Pacific, how startling does it seem, when we are told that these islands, bearing on their bosoms gardens of Eden, are entirely formed by the slow-growing corals, which, rising up in beautiful and delicate forms, displace the mighty ocean, defy its gigantic strength, and display a shelly bosom to the expanse of day ! The vegetation of the sea, cast on its surface, undergoes a chemical change ; the deposit from rains aids in filling up the little gaping catacomb, the fowls of the air and the ocean find a resting place, and assist in clothing the rocks ; mosses carpet the surface, seed brought by birds, plants carried by the oceanic currents, animalcules floating in the atmosphere, live, propagate, and die, and are succeeded, by the assistance their remains bestow, by more advanced vegetable and animal life ; and thus generation after generation exist and perish, until at length the coral island becomes a paradise filled with the choicest exotics, the most beautiful birds and delicious fruits, among which man may indolently revel to the utmost desire of his heart.

ACALEPHÆ. — In great variety of form and colour, swimming freely about the waters of the ocean, are found in abundance the beautiful *Acalephæ*. Some of them have a remarkable stinging property, from which circumstance they derive their name of *Sea-nettles* ; others, from their gelatinous nature, are known as *Sea-jelly*, or *Jelly-fish*.

These interesting animals were first arranged in three

orders : *A. stabiles* (fixed), *A. liberæ* (free), and *A. hydrostaticæ* (hydrostatic). Cuvier classed them in two orders : *A. simplices* and *A. hydrostaticæ*. They are now, however, divided differently, and arranged in groups according to the peculiar mode by which they effect their locomotion. A very interesting point of connexion between this class and the preceding is the interchange of form. Some of the *Zoophyta*, as the *Tubulariadae* and the *Campanulariadae*, give birth to a progeny which are in every respect *Naked-eyed Medusæ* ; while, on the other hand, the young of the *Medusæ* are in their earlier stages stationary



Fig 238 — Jelly-fish.

The *Medusæ* spread on the surface of the water a beautiful jelly-like mass, in form resembling an umbrella ; and by a continual contraction and opening out of this, they swim freely about (Plate IX. *c, d, e, h*). They are all more or less phosphorescent. The *Beroe*, one of the family *Ctenophora*, propel themselves with active ciliated arms. The *Physalidæ* have an organ common to fishes,—swimming bladders,—by filling or emptying which they rise or sink, and move along in their watery home.

The Medusoid family, *Lucernaridæ*, has, from a mistaken view of its organization, been referred to the class Actinozoa : Milne-Edwards has, however, placed it in a sub-class, under the name of Podactinaria. In the *Lucernaridæ* the body is cup-shaped, about an inch in height, terminating in a short foot-stalk. Round the distal margin of the cup arise a number of short tentacles, which are disposed in eight or nine tufts ; in *Carduella* they form one continuous series. Their free extremities appear sucker-like, and the whole organism is semi-transparent, of a gelatinous consistence, and variously coloured. The cup, viewed from above, presents in its centre a four-lobed mouth, which is seen to form the free extremity of a distinct polypite, occupying the axis of the entire hydrosoma. Its gastric region exhibits a number of tubular filaments, arranged in vertical rows dipping into

the digestive cavity. The space between the polypite-wall and the inner surface of the cup is equally divided. A circular sinus has its course beneath the insertion of the tentacles. By means of a band of muscular fibres which transverse its margin, and another set which radiate towards the polypite, the distal extremity of the cup can be folded or drawn inwards. It has been observed to detach itself, and swim in an inverted position by the slowly repeated movements of its cup-like umbrella, thus resembling *Pelagia*, a more active and permanently free member of the same order.

Three families of the beautiful Lucernaridæ, all of which are at once distinguishable by their umbrella, may be defined as follows:—

Family 1, Lucernaridæ. Reproductive elements developed in the primitive hydrosoma, without the intervention of free zoöids. Umbrella with short marginal tentacles and a proximal hydrorhiza. Polypite single.

Family 2, Pelagidæ. Reproductive elements developed in a free umbrella, which either constitutes the primitive hydrosoma, or is produced by fission from an attached Lucernaroid. Umbrella with marginal tentacles. Polypite single.

Family 3, Rhizostomidæ. Reproductive elements developed in free zoöids produced by fission from attached Lucernaroids. Umbrella without marginal tentacles. Polypites numerous, modified, forming with the genitalia a dendriform mass depending from the umbrella.

For a further description of this interesting species see Professor Müller's paper, *Journal of Microscopical Science*, vol. iii. p. 265; or, Professor Greene's *Manual of the Coelenterata*.

The flat circular horny disc forming the skeleton of *Propita gigantea*, to the naked eye exhibits both radiating and concentric markings; and, when examined with a power of 40 diameters, its upper surface is found to be furrowed, and two rows of small projecting spines occur upon the ridges between the furrows, the ridges being the radiating fibres above noticed. The under-surface, or that to which the greater portion of the soft parts of the animal are attached, is more deeply furrowed; and plicæ or folds of the mantle fit accurately into the furrows, from

which they can easily be removed by the application of a gentle force. The concentric markings have in all cases small scalloped edges; they occur at certain regular intervals, and are so many indications of the lines of growth. In the centre there is a circular depression; and between its circumference and that of the first concentric marking there are eight flattened radii. If the under-surface be examined with a power of 100 linear, the ridges will all be found to have small jointed tubular processes like hairs projecting from them. In no part of this horny tissue is there a trace of a cellular or a reticular structure.

Wonderfully beautiful as are these creatures in form and colour, the amount of solid matter contained in their tissues is incredibly small. The greater part of their substance appears to consist of a fluid, differing little, if at all, from the sea-water in which the animal swims; and when this is drained away, so extreme is the tenuity of the membranes which contained it, that the dried residue of a jelly-fish, weighing two pounds, which was examined by Professor Owen, weighed only thirty grains. The transparency of the tissues render the whole of the *Acalephæ* delightful objects for the microscope.<sup>1</sup>

The *Echinodermata* belong to the division *Annuloidea*, the most familiar of examples of which are star-fishes and sea-urchins. The labours of that distinguished comparative anatomist and physiologist of Berlin, Johannes Müller, have made us better acquainted with the structure and development of these remarkable animals than with those of most classes of the animal kingdom. The series of feet which protrude along certain fixed lines from the body of an *Echinoderm* have received the name of "ambulacra;" and hence, says Mr. Huxley, "we may distinguish their system of vessels as the ambulacral vascular system. The existence of an ambulacral vascular system has as yet been demonstrated only in the following orders:—*Echinidea*, *Ophiuridea*, *Crinoidea*, *Asteridea*, and *Holothuridea*, with which the fossil *Cystidea* and *Blastoidea* are inseparably connected. I therefore limit the *Echinodermata* to the

(1) See an excellent paper in the *Transactions of the Microscopical Society*, On the Anatomy of Two Species of Naked-eyed Medusæ, by G. Busk, Esq.; also Professor Forbes' works on this family.

very natural group formed by these orders. A more or less complete calcareous skeleton is always developed within the *Echinoderms*, resembling that of the *Actinozoa*, not only in this respect, but also in consisting of detached spicula. In this form the skeleton remains in the *Holothuridea*, but in the other *Echinoderms*, the spicula coalesce into networks, which may become consolidated into dense plates by additional deposits. It is by the different shape and arrangement of these plates that the diversity exhibited by the skeletons of different *Echinodermata* is produced."

*Asteridea*.—Star-fishes have been divided according to the mode of locomotion into Spinigrades, moving by means of spines; Cirrhigrades, by suckers; and Pinnigrades, by fins or pinnæ. Of the last-named division we have only one British genus, *Comatula*. At the very extremity of each ray is an organ like an eye, having spinous appendages, which are termed the eyelids. It is doubtful, however, whether these parts have really any visual endowment; no proof of their possessing the faculty of sight has ever been advanced, and, from what we know of the nature of this sense generally in the lowest forms of animal life, we should be disposed to consider that the organs in question must serve some other as yet unknown purpose.

The species *Ophiura* and *Ophiocoma*, Plate IV. Nos. 88 and 91, may be easily recognised by the great length and tenuity of their rays, and their excessive fragility. The whole surface, both of disc and rays, is covered by scales, which are so closely approximated as to give an almost perfectly smooth surface. These scales are arranged in definite and often in very beautiful patterns, and in some species the primary scales are edged or encircled by series of circular bosses or tubercles, giving a reticulated appearance to the disc and rays. *Ophiocoma rosula* has its spines tipped with curious anchor-shaped processes, which are supposed to facilitate the motion of the creature. In *Ophiura* they are very short, and not apparent without careful inspection; while in *Ophiocoma* they are so long as to give quite a bristly, sinous appearance to the animal, being sometimes, in fact, very much longer than the

breadth of the rays. A striking species is the *Palmipes membranaceus*, the "Bird's-foot Sea-star," which is almost as thin as parchment, and might, as Professor Forbes says, be readily mistaken for the torn-off skin of some bulkier species. Its surface is covered with a number of raised tubercles, and very closely-set fasciculi of short and sharp spines. *Asterias aurantiaca* and *Luidia fragilissima* present a surface-structure very different from any of the species previously noticed, their tuberculated epidermis being so closely set with upright spines as to be almost wholly invisible. These spines are arranged in a radiated or rosette-shaped manner, and have a roughened surface. A portion of the ray of *Luidia* forms a microscopic object of exquisite beauty. A single spine is given in Plate IV. No. 89.

The cirrigrade star-fishes are furnished with certain curious appendages, the use of which is at present very imperfectly understood. These are the "*pedicellariæ*" and "*madreporiform tubercle*." The latter is a rounded, cushion-like eminence of considerable size, situated on the disc, mostly very much out of the centre. It is irregularly fissured in a radiate manner, and is not at all unlike the animal from which it derives its name. Various conjectures have been made as to the use of this tubercle. Forbes looks upon it as being merely the analogue of the stalk which exists in the young condition of the crinoid star-fishes. The *pedicellariæ* (Plate IV. Nos. 93 and 94) are pincer-like organs irregularly scattered over the surface of the animal, and which have distinct characters in the different species. They were supposed to be parasitic creatures, but are now generally admitted to be true epidermic appendages. They are in a constantly active motion during the life of the star-fish, and grasp firmly anything which is brought between their blades. Their nearest analogues are the birds'-head processes which occur in certain zoophytes. The *Pedicellariæ* of *Echinus* are partially covered with ciliated epithelium: they are also placed upon a stalk, the lower portion of which encloses a calcareous nucleus, whilst the other portions are soft, and spirally retractile.

The Feather-star (*Comatula rosacea*) is perhaps the most

interesting of the British star-fishes, and quite unique in the gracefulness of its form and the exquisite beauty of its colouring; its life-history is not only remarkable, but it possesses the additional interest of being the only living representative in our seas of the group of organisms so familiar to us in the fossil state as *Encrinites*. The delicate structure of this species renders it impossible to exhibit it satisfactorily in a dry or mounted state. The central cup-shaped body gives off five rays, which divide so near the base as to appear like ten. These are furnished throughout their length with membranaceous pinnæ. *Tubularia Dumortierii*, Plate IV. No. 92, appears rather to belong to *Comatula* than *Tubularia*. A description of this interesting polype will be found in Johnston's *Brit. Zoophytes*, p. 53.

The late Sir Wyville Thompson, in a paper on "Sea-Lilies" (*Intellectual Observer*, August, 1864, says:— "*Comatula rosacea*, the most common British species, is found abundantly in Lamlash Bay, in Arran and Strangford Loughs, in Dulkey Sound, in Kirkwall Bay, and generally distributed in deep water all round the British and Irish coasts. In general structure it resembles very closely the head of *Neocrinus decorus*; it has, however, no stem, but in the position of the stem, and forming the base of the cup, there is a hemispherical plate covered with rows of cirrhi, exactly like the stem-cirrhi on the stalked forms. When at rest it holds on to a stone or weed, and spreads out its beautiful feathery crimson arms, like the petals of a flower. At other times it swims rapidly through the water by graceful impulses of its arms. In spring, the hundreds of ovaries dotted over its pinnules are turgid with eggs, and if at this time it is captured, and placed with some sea-weed in a tank, bunches of bright orange-coloured eggs hang in clusters around, giving the delicate pinnatic arms the appearance of the fronds of some wonderfully graceful fern in rich fructification.

"The phases passed through by the young before they come to resemble their parents in form and mode of life are of extraordinary beauty, and most instructive in determining the true zoological relation which the free crinoids bear to their fixed ancestors. At first a minute, almost



invisible, pale yellow germ escapes from the egg; this, if placed under the microscope the first day after its birth, has a very definite form, but not the least like a star-fish. Four bands of long vibratile cilia guard the body at different points, and by their motion the little animal whirls about in the water. About the end of the second day two rows of five each of delicate calcareous trellised plates may be seen, making a kind of five-sided basket. A dark mass now collects within the trellised basket, and the rings are united together by little bundles of rods, till they form what looks like a joined pillar supporting the basket. Gradually the plates enlarge and distort the outer wall; and the stem-like series of joints lengthen, stretching out the narrow end with it. The old mouth disappears, the gelatinous wall settles round the little living skeleton, a round sucker appears, and the animal fixes itself upright to a sea-weed or a stone at the bottom of the tank. Five leaf-like valves, each supported by one of the upper tier of plates, now open on the top of the wider extremity, and the little creature looks when these valves are open much like a microscopic wine-glass, and when closed like a tulip bud."

*Echinidæ*.<sup>1</sup>—Sea-urchins are found in abundance upon our sea-shores, lurking among the rocks, where they entrap their prey. Their spines and suckers are used as feet, or as a mode of progression, even to the climbing of rocks, in order to feed upon corallines and zoophytes: they march along with ease where apparently no footing could be found, or dig holes with their spines to bury themselves in the sand, to escape pursuers, or hide from observation. The

(1) Description of Plate 9 :—

ASTEROIDÆ.

- a, *Astrophyton scutatum*.  
n, *Ophiocoma rosula*.

NUDEBRANCHIATA GASTROPODA.

- b, *Doris pinnatifida*—back and side view.

ACALYPHÆ.

- c, *Equorea Forbesina*.  
d, *Medusa Bud*.  
e, *Thaumantias corynetes*.  
k, *Cydippe pylæus*.

ECHINOIDÆ.

- f, *Echinus* (A Young Sea-urchin).  
g, *Echinus sphaera*.

TUNICATA.

- i, *Ascidia*.  
k, *Botryllus violaceus*, on a *Fucus*.

CRUSTACEA.

- l, *Corystes cossivelaninus*.  
m, *Eurynome aspera*.  
o, *Pagurus Prideauxii*.  
p, *Ebalia Permannii*.



PLATE IX. *Asteroidea, Echinidea, Crustacea, &c.*



*Echinodermata*,<sup>1</sup> *sea-urchins*, or sea-eggs, derive their name from these curious spinous processes.

In most *Echinidea* all the feet are expanded into sucker discs, at their extremities, and are here strengthened by a calcareous plate or plates; but in the *Echino-cidaris* and some others, the feet of the oral portion of the ambulacra only have this structure, while those of the apical portion are pectinated, flattened, and gill-like. Müller distinguishes four kinds of feet in the *Spatangoidea*,—simple locomotive feet, without any sucking disc; locomotive feet, provided with terminal suckers, and containing a skeleton; tactile feet, whose expanded extremity is papillose; and gill-like feet, triangular, flattened, with more or less pectinated lamellæ

In the *Clypeastrodea* the petaloid portions of the ambulacra possess branchial feet, interspersed with delicate locomotive sucker feet, provided with a calcareous skeleton. In the *Ophiuridea* and *Crinoidea* the feet are tentaculiform; and there are no vesicles at the bases of the feet, while in the *Asteridea* they are well developed, but simpler than those of the *Echinidea*. The madreporic canal is, in the *Asteridea*, strengthened by a remarkable calcareous framework, which has given rise to the notion that it is filled with sand, and to the name "sand-canal," which has been applied to it. The canal terminates in the madreporic tubercle, which is always placed interradially on the antambulacral surface of the star-fish.

In some, *Holothuridea*, the feet are scattered over the whole ambulacral region, as well in the inter-ambulacra as in the ambulacra. In others, *Psolus*, the feet are developed only from three of the five ambulacra; while in the *Synapta* and *Chirodatæ* there is only a circlet around the mouth.

Many star-fishes, and *Synapta* among the *Holothuridea*, have the curious habit of breaking themselves up into fragments when taken; Müller has pointed out the very curious fact, that in *Synapta*, at any rate, this act may be prevented by cutting through the oral nervous circle. The nervous circle in the *Echinus* surrounds the œsophagus near the mouth, and is enclosed by the alveoli, between which the

(1) Derived from *echinos*, a spine, and *derma*, skin.

ambulacral nerves pass to reach it. In the *Asteridea*, the circle lies at the extreme limit of the soft membrane, which surrounds the mouth, and may be readily exposed by cutting away the hard inter-ambulacral oral lips. In the *Holothuridea* it lies immediately beneath the perisoma of the oral disc. The only known organs of sense in the *Echinodermata* are the pigmented "eye-spots," developed in connexion with the ends of the ambulacral nerves, and on the oral nervous circle in many *Holothuridea*.

The great majority of the *Echinodermata* commence their existence as free-swimming larvæ covered with cilia, but a great difference exists in their further course, according as they belong to the *Asteridea*, the *Holothuridea*, and the *Crinoidea* on the one hand, or to the *Echinidea* and *Ophiuridea* on the other. Of the development of the *Crinoidea* we know very little, beyond the observations of Mr. Thompson, that the larva of the *Comatula* is provided with several transverse bands of cilia, almost like that of a *Holothuria*, and that the development of the *Echinoderm* commences while the larva is still free. At a later period, the young *Comatula* is seated upon a long, jointed stem, so as to resemble a *Pentacrinus*; and it becomes detached from this stem, in assuming its adult condition.

Mr. Huxley, after mature examination of this class of animals, says, "he can see no reason for retaining them amongst the *Radiata* of Cuvier, but, on the other hand, thinks them properly placed among the *Annuloida*."

The skeleton of the Echinoderms generally consists of an assemblage of plates, or joints, of calcareous matter. The minute structure of which presents a reticulated character, and the solid parts are usually composed of a series of super-imposed laminæ or scales. The openings, or areolæ, in one layer being always placed over the solid cell-walls of the layer beneath it, the spines are situated on the external surface of the shell; they are generally of a conical figure, and are articulated with the tubercles by a ball-and-socket joint. When a thin transverse section of one of these spines is examined with the naked eye, it appears to be made up of a series of concentric layers, varying considerably in number; not, however, with the size of the spine, but with the distance from the base at which

the section was made: when a section taken from the middle of the spine is examined with a power of fifty diameters, it will be seen that the centre is occupied by a reticulated structure; around the margin of this may be observed a series of small structureless spots, arranged at equal distances apart (Fig. 240, No. 1): these are the ribs or pillars, and indicate the external surface of the first layer deposited; passing towards the margin, other rows of larger pillars may be seen, giving it a beautiful indented appearance; all the other parts of the section are occupied by the usual reticulated tissue. In the greater number of spines the sections of the pillars present no structure, in others they exhibit a series of concentric rings of successive growth, which strongly remind us of the medullary rays of plants; occasionally they are traversed by reticulated structures, as represented in Fig. 246, No. 1. When a vertical section of a spine is examined, it is found to be composed of cones placed one over the other, the outer margin of each

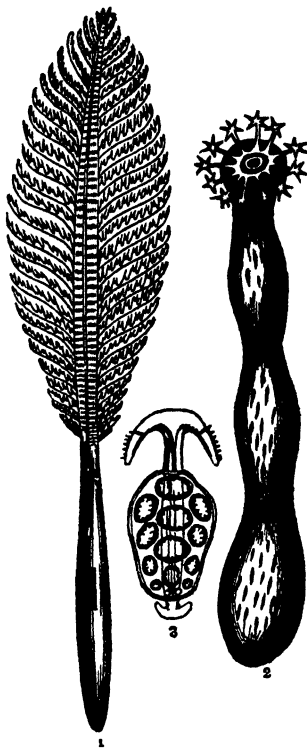

Fig 239

1, Polypidom of *Pennatula phosphorea*. 2, *Synapta Chirodota*. 3, Anchor-shaped spiculum and plate from skin of *Synapta*

cone being formed by the series of pillars. In the genus *Echinus* the number of cones is considerable, while in that of *Cularis* there are seldom more than one or two; so that

from these species transverse sections may be made, having no concentric rings, and in which only the external row of pillars can be seen.

“The skeleton of the *Echinodermata* contains very little organic matter. When it is submitted to the action of very *dilute acid*, to dissolve out the calcareous matter, the residuum is very small in amount. When obtained, it is found to possess the reticular structure of the calcareous shell (Fig. 240, No. 1); the meshes or areolæ being bounded

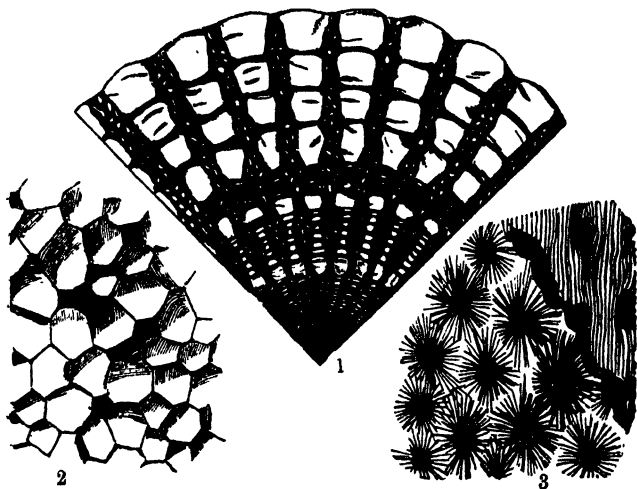

Fig. 240.

1, Section of spine of *Echinus*, exhibiting reticulated structure, the calcareous portion having been dissolved out by acid. 2, Transverse section of shell of the *Pinna ingens*. 3, Horizontal section of shell of *Terebratulata rubicunda*, showing its radiating perforations.

by a substance in which a fibrous appearance, intermingled with granules, may be discerned under a sufficiently high magnifying power, as originally pointed out by Professor Valentine. This tissue bears a close resemblance to the areolar tissue of higher animals; and the shell may probably be considered as formed, not by the consolidation of the cells of the epidermis, as in the *Mollusca*, but by the calcification of the fibro-areolar tissue of the true skin.

This calcification of areolar or simply fibrous tissue, by the deposit of mineral substance, not in the meshes of areolæ, but in intimate union with the organic basis, is a condition of much interest to the physiologist; for it presents us with an example, even in this low grade of the animal kingdom, of a process which seems to have an important share in the formation and growth of bone, namely, in the progressive calcification of the fibrous tissue of the periosteum membrane covering the bone."<sup>1</sup>

From their peculiarity of structure they may be said to be almost imperishable. Their shells exist abundantly in all our chalky cliffs, innumerable specimens of which may be obtained, exhibiting the same wondrous forms and characters as those which now frequent our shores.

The *Crinoidea*, "Sea-lilies,"—so called from the resemblance which many of them present to the lily,—were exceedingly abundant in former ages of the world; and their remains often form the great bulk of large masses of rock, fig. 241. These animals were all supported upon a long stalk, at the extremity of which they floated in the waters of those ancient seas, spreading their long arms in every direction in search of the small animals which constituted their food. Each of the arms, again, was feathered with a double series of similarly jointed appendages; so that the number of separate calcareous pieces forming the skeleton of one of these animals was most enormous. It has been calculated that one species, the *Pentacrinus briareus*, must have been composed of at least 150,000 joints; and "as each joint," according to Dr. Carpenter, "was furnished with at least two bundles of muscular fibre,—one for its contraction, the other for its extension,—we have 300,000 such in the body of a single *Pentacrinus*—an amount of muscular apparatus far exceeding any that has been elsewhere observed in the animal creation." A furrow runs along the inside of the arms, which is covered with a continuation of the skin of the disc; and from this the ambulacra are protruded, as in other *Echinodermata*.

In the family of *Ophuridea*, so called from the resemblance of their arms to a serpent's tail, (Gr. *ophis*, a snake,

(1) Dr. Carpenter, *Cyclopædia of Anatomy and Physiology*.



*oura*, a tail); the body forms a roundish or somewhat pentagonal disc, furnished with five long simple arms, which have no furrow for the protrusion of the ambulacra.

*Ophiuridea* are exceedingly plentiful in all our seas, and their remains occur in all the more recent marine strata of the earth's crust. They are more commonly called *Sand Stars*, or *Brittle Stars*.

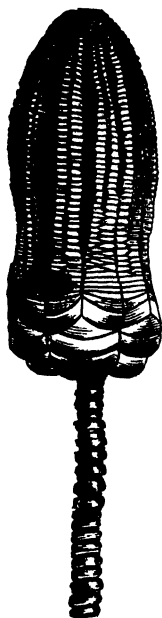

Fig. 241.—*Encrinurus*,  
Sea-holy.

“However much the faunas of the various geologic periods may have differed from each other, or from the fauna which now exists, in their aspect and character, they were all, if I may so speak, equally underlaid by the great leading ideas which still constitute the master types of animal life. And these leading ideas are four in number. First, there is the *star-like* type of life,—life embodied in a form that, as in the corals, the sea anemones, the sea urchins, and the star fishes, radiates outwards from a centre; second, there is the *articulated* type of life,—life embodied in a form composed, as in the worms, crustaceans, and insects, of a series of rings united by their edges, but more or less moveable on each other; third, there is the *bilateral* or *molluscan* type of life, there is a duality of corresponding parts, ranged, as in the cuttle fishes, the claws, and the snails, on the sides of a central axis or plane; and fourth there is the *vertebrate* type of life—life embodied in a form in which an internal skeleton is built up into two cavities placed the one over the other, the upper for the reception of the nervous centres, central and spinal,—the lower for the lodgment of the respiratory, circulatory, and digestive organs. Such have been the four central ideas of the faunas of every succeeding generation, except perhaps the earliest of all, that of the Lower Silurian System, in which, so far as is yet known, only three of the number existed,—the radiated, articulated, and molluscan ideas or types.

That Omnipotent Creator, infinite in His resources—who, in at least the details of His workings, seems never yet to have repeated Himself, but, as Lyell well expresses it, breaks, when the parents of a species have been moulded, the dye in which they were cast,—manifests Himself, in these four great ideas, as the unchanging and unchangeable

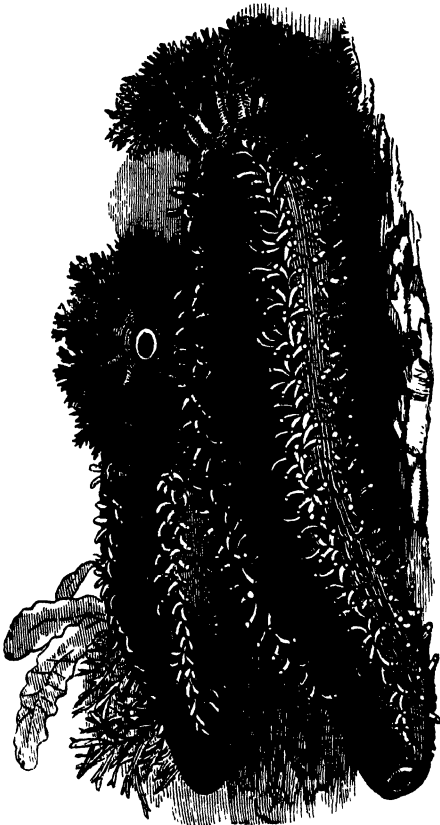

Fig 242.—*Holothuridea*, Sea-cucumbers.

One. They serve to bind together the present with the past, and determine the unity of the authorship of a wonder-

fully complicated design, executed on a groundwork broad as time, and whose scope and bearing are deep as eternity." <sup>1</sup>

The *Synaptidæ* are characterised by a total absence of ambulacra, the motions of the animals being assisted by peculiar anchor-like processes which project from the skin, and roughen the surface of the animal. The spiculum represented in fig. 239 is serrated on the convex edge, and, Dr. Herepath says, apparently belongs to *S. Galliermi*, but that the drawing of the animal near it is singularly inaccurate, although taken from Professor Forbes' work; and that the oral tentacles are imaginary developments of *S. digitata*. See Herepath, "On the Genus *Synapta*," *Quar. Journ. Micros. Science*, 1865, p. 1. The spicules are beautiful objects for polarised light. (Plate IV. No. 87, shows a side view of one set in the skin.)

*Holothuridea*, "Sea-cucumbers." — In this family the body acquires a slug-like form. The radiate structure is in fact scarcely recognisable in these animals, except in the arrangement of the tentacles which surround the mouth. The body is always more or less elongated, with the mouth at one end and the anal opening at the other; the calcareous deposit in the skin is reduced to scattered granules; and in one family the ambulacra are entirely wanting.

The integument consists of a number of minute reticulated plates, set closely on the substance of the skin. The forms of the plates are various, as well as the spicula set in them. The Australian seas furnish many varieties: Plate VIII. Nos. 171 and 172, are representations of plates and spicula under polarised light. Objects of this class are also well suited for black-ground illumination.

The structure of the spines and other solid parts of the skeleton of *Echinodermata* can only be displayed by making thin sections, in the way described for cutting bone, at page 209. Their peculiar texture requires that certain precautions should be taken to prevent the section from breaking whilst being reduced to a desirable thinness, and to prevent the interspaces of the network from being clogged by the particles abraded in the reducing

process. In mounting the specimens, liquid balsam must be employed, and only a very gentle heat should be applied; and if, after it has been mounted, the section should be found too thick, it will be easy to remove the glass cover and reduce it further, care being taken to harden the balsam, as directed in preparing bone sections.

#### PRESERVATION OF THE POLYPIDOMS OF ZOOPHYTES.

The following excellent and simple plan for preserving zoophytes as fluid preparations, so as to retain the polypes and their tentacular arms *in situ*, was adopted by the late Dr. Golding Bird. For this purpose a lively specimen should be chosen, and then plunged into cold pure water;<sup>1</sup> the polypes are killed almost immediately, and their tentacles often do not retract: proper-sized specimens should then be selected, and preserved in weak alcohol. Little phials about two inches long should be procured, made from thin flat glass tubes, so as to be half an inch wide, and about a quarter of an inch, or even less, from back to front. The specimens should be fixed to a thin platinum wire, and then placed in one of these phials (previously filled with weak spirits), so as to reach half-way down. When several are thus arranged, they should be put on a glass cylinder, and removed to the air-pump. On pumping out the air, a copious ebullition of bubbles will take place; and many of the tentacles previously concealed will emerge from their cells. After being left in vacuo for a few hours, the bottles should be filled up, closely corked, and tied over, like anatomical preparations in general. For all examinations with a one or two-inch object-glass, these bottles are most excellent, and afford cheap and useful substitutes for the more expensive and difficultly-managed cells. In this manner, specimens of the genera *Membraniporæ*, *Alcyonidæ*, and *Crisiadaæ*, &c., exhibit their structure most beautifully.

A few dozen of these little bottles hardly occupy any room, and would form a useful accompaniment to the microscopist by the sea-side. Any one visiting the caverns

(1) A small quantity of gin thrown into distilled water answers the purpose better than pure water, and specimens may be put up in the same. The animals are nearly always preserved in their polypidoms by using this fluid to kill them.

in St. Catherine's Island at Tenby, might reap a harvest which would afford amusement and instruction for many weeks. These caverns are so rich in zoophytes and sponges, that they are literally roofed with the *Laomedea Grantia*, and their allies; whilst the elegant *Tubularia* afford an ornament to the shallow pools on the floor; and the walls are wreathed with the pink, yellow, green, and purple *Actinia*.

When these objects are examined by polarised light most interesting results are produced. For this purpose let a piece of selenite be placed on the stage of the microscope, and the polarising prisms arranged so that the ray transmitted is absorbed by the analyser. If a specimen of *Sertularia operculata* be placed on the selenite stage, and examined with a two-inch object-glass, the central stem is shown to be a continuous tube, assuming a pink tint throughout its whole extent. The cells appear violet in colour; their pointed orifices are seen much more distinctly than when viewed with common light. The vesicles are paler than the rest of the object; and their lids, which so remarkably resemble the operculum of the theca of moss, are beautifully distinct, being of an orange-yellowish colour. This zoophyte is often covered with minute bivalve shells, distinguished by the naked eye from the vesicles only by their circular form; and these, when present, add much to the beauty of the specimen, presenting a striated structure, and becoming illuminated with most beautiful colours.



ECHINODERMATA, HYDROZOA, POLYZOA, HELMINTHOIDA.

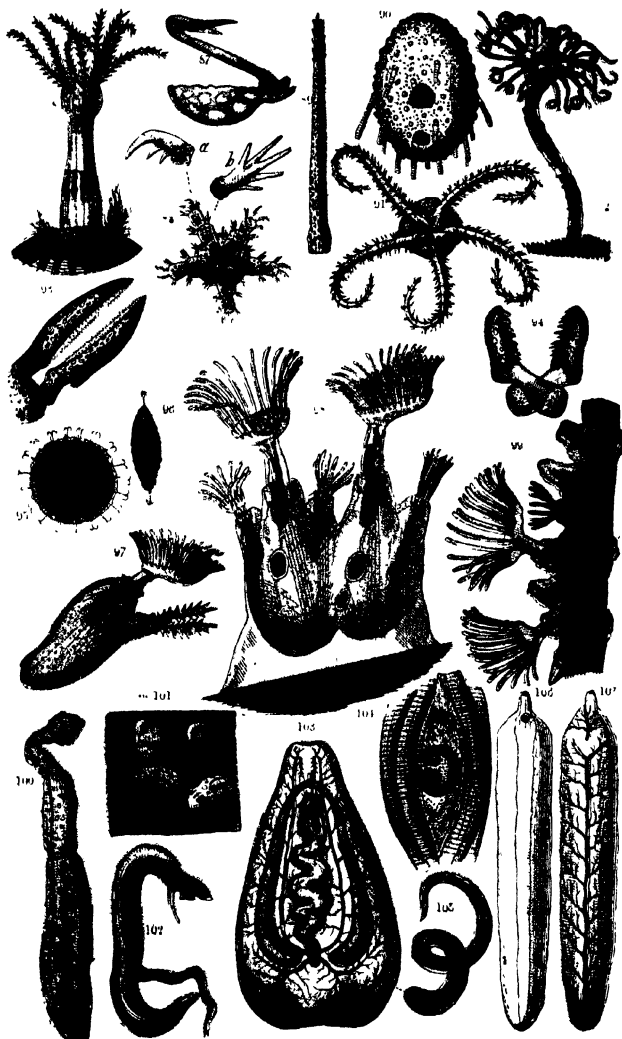

Tuffen West, del.

PLATE IV

Edmond Evans.

## CHAPTER III.

POLYZOA — MOLLUSCA — GASTEROPODA — BRACHIOPODA — CONCHIFERA —  
CEPHALOPODA — PTEROPODA — TUNICATA — CRUSTACEA — ENTOMOSTRACA —  
ANNULOSA — CIRRIPEDA — ENTOZOA — ANNELIDA.

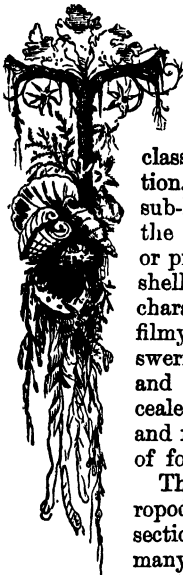

THE term *Mollusc*, derived from *mollis*, soft, is one which at once indicates a chief structural characteristic of the class of animals about to occupy our attention. The body of most of the molluscous sub-kingdom is soft and fleshy; and all except the *Tunicata* and a few *Pteropoda* are covered or protected by a hard calcareous shell. The shell is of two kinds; first of an epidermal character, being formed upon the surface of a filmy cloak-like organ called a mantle, answering to the true skin of other animals; and next of a dermal character, being concealed within the substance of the mantle, and frequently moulded into a great diversity of forms, and coloured with various tints.

The molluscs belonging to the class *Gastropoda* have become a large and important section of the animal series, presenting very many objects of great interest for the microscopist. Of the large family of molluscs, the only species which have any resemblance in structure to the *Polyzoa*, the *Brachiopoda*, now form a portion of the molluscous division. The resemblance is chiefly confined to their internal conformation.



The Polyzoa were placed by Dr. Johnston under the head *Ascidiodida*; in the generality of works they are named *Bryozoa*, and the individual, *Bryozoon*; derived



Fig. 243. — Bryozoon *Bowerbankia*, "Bowerbank Bryozoon," showing its internal structure; another animal withdrawn into its cell.

from the Greek words βρύον, sea-moss; ζῷον, animal. (Fig. 243.) The Polyzoa are all compound associated animals, whence their name; but when a polyzoon egg is hatched, as in the case of *Plumatella*, it commences life as an isolated being, and by subsequent growth, resembling budding, multiplies into a colony. All are most bountifully supplied with cilia, and the play of these is most energetic, for the purpose of securing an abundant supply of food, and apparently without exertion on the part of the creature itself. From this most marked characteristic, Dr. Farre was induced to give them the name of *Ciliobrachiata*. But it has at length been determined to transfer the *Polyzoa*, *Flustra*, *Lepralia*, *Anguinaria spatulata*, &c. to the sub-molluscan kingdom<sup>1</sup>

*Polyzoa* are generally found living together in great numbers, resembling in this respect some of the *Actinozoa*, and are protected by membranaceous coverings or polypidomæ. Protrusion and retraction are performed by two sets of muscles, one acting on the body of the animal, the other

(1) Mr. Gosse, in his *Manual of Marine Zoology*, adopts the idea, now pretty general, that the *Polyzoa* belong to the Molluscan division, in spite of their external resemblances to Polypes, and he places them among Molluscs. In this, perhaps, he has thought more of systematic views on classification than of the student's convenience. It seems to us quite clear that, without adopting De Blainville's principle of classifying animals according to their envelope as the best principle of scientific classification, we should adopt it in works of reference like the present, since the external characters are necessarily those most immediately recognised by the student; and in the case of the *Polyzoa*, they are so remarkably similar in external characteristics to the hydroid polypes, that they were always classed with them, until the profounder investigations of Van Beneden, Allman, and others, revealed the resemblances between the internal characteristics of the *Polyzoa* and those of Molluscs.

upon its cell. The oral extremity is surrounded by a circle of long tubular tentacles covered with cilia ; at each of these feelers or arms there is an aperture, the one at the base communicating with a canal that passes round the edge of the oral aperture or mouth. The food passes down a long gullet, that contracts during the process of swallowing. At the end of this is an orifice that opens into what appears to be a gizzard, having two bodies opposite to each other, with a rough surface, as if for the comminution of food, moved by muscular fibres. Those of the species without this gizzard have a digestive stomach that secretes a coloured fluid. From the upper part of the stomach near the entrance from the gizzard arises an intestine, having a narrow opening surrounded by cilia that proceeds upwards, ending in an orifice near to the tentacles, from which the refuse food is ejected.

Their cells are of various shapes, and from one, a family of millions come, budding forth from its sides ; and though the living matter disappears, the catacombs exist for the foundation of their families, branching out and enduring for ages.

*Bryozoon Bowerbankia* received its name from Dr. Arthur Farre, in honour of the well-known microscopist, Mr. Bowerbank. A magnified representation of the animal is seen in fig. 243. "When fully expanded, it is about one-twelfth of an inch in length. In its retracted state, it is completely enclosed in a delicate horny cell, sufficiently transparent to admit of the whole structure of the contained animal being seen through its walls. The cells are connected together by a cylindrical creeping stem, upon which they are thickly set, sessile, ascending from its sides and upper surface. The animal, when completely expanded, is seen to possess ten arms of about one-third the length of the whole body ; each arm being thickly ciliated on either side, and armed at the back by about a dozen fine hair-like processes, which project at nearly right angles from the tentacles, remaining motionless, while the cilia are in constant and active vibration."

*Notamia, Back-cell*, so named from the cells being exactly opposite, and united back to back with a thick partition, and having a joint above and below each vair. In some

species of the *Flustra* the interior of the cell is protected by a lid which bears some appearance to the head and beak of a bird, and hence it is termed the *bird's-head* process. This has been made the subject of investigation by many naturalists. George Busk, Esq., F.R.S.,<sup>1</sup> contributed to the *Transactions of the Microscopical Society*, 1849, an admirable paper on the *Notamia bursaria*, "Shepherd's-purse Coralline," (represented in fig. 244, Nos. 1 and 3), which adds to our knowledge of this curious process. He says: "This most beautiful pearl-

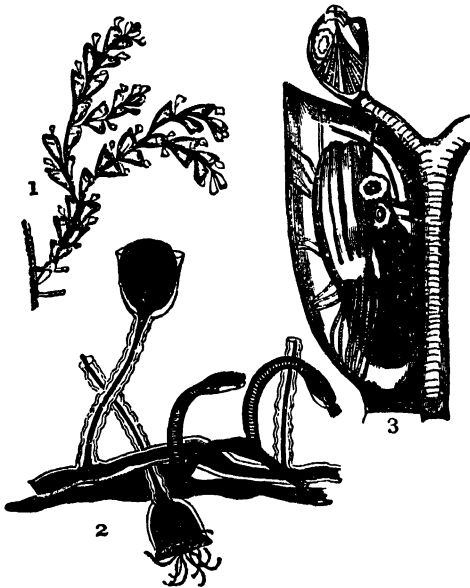

Fig. 244.

1, *Notamia bursaria*, Shepherd's-purse Coralline. 2, *Anguinaria spatulata*, Snake Coralline, growing with the *Campanularia integra*. 3, The Shepherd's purse Animalcule withdrawn into its cup, and the internal organism shown greatly magnified.

coloured coralline adheres by small tubes to fuci, from whence it changes into flat cells; each single cell, like

(1) Mr. Busk has added to the description here given of this bird's-head process in the *Quarterly Journal of Microscopical Science*, for January 1854.

the bracket of a shelf, broad at top and narrow at the bottom : these are placed back to back in pairs, one above another, on an extremely slender tube that seems to run through the middle of the branches of the whole coralline. The cells are open at top. Some of them have black spots in them ; and from the top of many of them a figure seems to issue out like a short tobacco-pipe, the small end of which seems to be inserted in the tube that passes through the middle of the whole. The cells in pairs are thought by some to have the appearance of the small pods of the plant "Shepherd's Purse," by others the shape of the seed-vessel of the *Veronica*, Speedwell.

"The polypidom of this bryozoon, like those of most of its congeners, may be said to consist of a radical portion, by which it is affixed to the objects upon which it grows, and of a celliferous portion or branches, upon which the polypes themselves are lodged. The radical portion in the present species consists of a central discoid body of a nearly circular form, and of branches radiating from the periphery of the disc, which thence exhibits something of the aspect of the body of an *ophiura*. The radical tubes or branches springing from the margin of the disc are usually five or six in number, and they are given off at pretty regular distances apart ; but besides these radical tubes, one or more celliferous branches are not unfrequently seen to arise immediately from the upper surface of the discoid portion.

"The central disc, and the radical tubes arising from it, exhibit a similar structure, and are formed of a thick, firm, apparently horny envelope, containing a coarse granular matter, of a yellowish-white colour, and which in some portions of the tubes assumes the form of distinct irregularly-globular masses, of nearly uniform size. The central disc is subdivided into distinct compartments by septa of considerable thickness, and each radiating branch arises from one of these distinct compartments ; so that there appears to be no communication between one radical branch and another. The radical branches give off at irregular distances secondary branches, which ultimately become celliferous. Each of these secondary branches, however, arises from a distinct compartment, as it were, of

the tube from which it springs. This compartment is formed, like those of the central disc, by a thick septum, which shuts off the origin of the secondary branch from the main cavity of the primary one."

The larger, or polypiferous cells, Mr. Busk proposes to term *cells*, and the smaller tobacco-pipe-shaped organs *cups*; the latter being usually above the former throughout the polypidom, "excepting immediately below each fork, where the cup is invariably absent above one of the cells of the pair from between which the fork springs. The polype-cells are several times larger than the cups, and their walls are much thinner; in fact, sufficiently transparent to allow of the contents of the cell being pretty well seen, without any preparation, even during the life of the animal. In shape they are inversely conical, and the outer and upper angle is usually produced into a prominent, sharp point. From the internal and upper angle arises the tubular prolongation going to form the next cell or cup, as the case may be, in succession. They are entirely closed at the top, contrary to what is stated by previous observers; and, as has been shown, there is no connexion whatever between the cell and the cup placed *immediately* above and behind it. The aperture of the cell is on the anterior face, and towards the upper margin; it is of a crescentic form, and placed obliquely, as it were, across the upper and internal angle of the cell, with the convexity of the curve directed upwards and inwards. The lips of the aperture are strengthened by thin bands of horny material; and, under favourable circumstances, indications of short muscular fibres, for the purpose of opening or closing the aperture, may be seen."

The shell, which Mr. Busk believes to be entire at the bottom, though closed only by a very delicate membrane, contains an ascidoid polype of the usual typical form of that class. "It has ten tentacles, and no gizzard. Two sets of muscular fibres at least may be distinguished as appertaining to the polype. The most important of these are the retractor muscles, which, arising from the bottom of the cell, in the form of long, somewhat flattened, transversely striped, isolated fibres, about the one ten-thousandth of an inch in width, are inserted, some of them

at the base of the tentacles, and others lower down the body of the polype."

When we consider the minuteness of the delicate little sprig which is the natural size of this polype, we cannot but wonder at the triumphs of the microscope in giving such precise details as Mr. Busk relates of the *Notamia bursaria*. Its beautiful and perfect organisation, the careful provision for the safety and engagements of this minute being, make us awe-stricken at the power of Divine intelligence.

The *Halodactylus*, better known as *Alcyonidium*, is remarkable among the marine forms of Polyzoa, for the large size of its tentacular crowns; these when expanded are distinctly visible to the unassisted eye, and present a spectacle of great beauty when viewed with the binocular microscope. Its polyzoary has a spongy aspect very much resembling that of the Alcyonian zoophyte: when however the animals are expanded, they are at once seen to be widely different, as the plumose turfts which then issue from the surface of *Halodactylus* give it the appearance of a beautiful downy film. The opacity of its polyzoary renders it unsuited for the examination of anything more than the tentacular crown.

*Lepralia*, "Sea-scurf,"—from the Greek for marine leprosy,—is the name given to this family of the *Celleporidæ* by Dr. Johnston.

*Lepralia nitida*, found attached to shells, is thus described: "Crust spreading circularly, closely adherent, rather thin, greyish white, calcareous; cells contiguous, in radiating rows, large, subalternate, ovate, ventricose, silvery, the walls fissured with six or seven cross slits which are on the mesial line; aperture subquadrangular, depressed, terminal; anterior to it there is often found a globular, pearly, smooth, oviferous operculum, with a round even aperture. The remarkable structure of the cells renders this one of the most interesting species under the microscope. There is sometimes an appearance of a spine on each side of the lower angle of the mouth, which is merely the commencement of the walls of the next cell."

*L. coccinea*, *L. variolosa*, *L. ciliata*, *L. trispinosa*, and *L. immersa*, are the other British species.

The family *Cellularia*, little-cells, have a curious and wonderful provision of nature for their protection, an operculum, a lid or cover over the apertures of each cell. *Cellularia ciliata* is parasitical, branching, calcareous, white and tufted ; grows about half an inch in height, and the oblique aperture is armed on the outer edge with four or five long hollow spines. The operculum is pearly, and near the base there is that singular appendage, described as the *bird's-head* process. Its beauty and transparency render it a favourite object with microscopists.

The *Cellularia* (now *Bugula*) *avicularia* are very accurately described by Mr. Gosse, from his own observations upon specimens secured on the Devonshire coast, during a residence there. He says : " Well does it deserve the name of *Bird's-head Coralline*, given to it by the illustrious Ellis ; for it presents those curious appendages that resemble vultures' heads in great perfection. All my specimens were most thickly studded with them ; not a cell without its bird's head, and all see-sawing, and snapping, and opening their jaws with the most amusing activity ; and what was marvellous, equally so in one specimen from whose cells all the polypes had died away, as in those in which they were still protruding their lovely bells of tentacles. The stem ascends perpendicularly from a slender base, which is attached to the rock, or to the cells of a *Lepralia* growing from the rock. The central part of the spine is most expanded, the diminution above and below being pretty regular ; during life, the usual colour is a pale buff, but the cells become nearly white in death. When examined microscopically it is, however, that the curious organisation of this zoophyte is discovered, especially when in full health and vigour, with all the beautiful polypes protruded and expanded to the utmost, on the watch for prey. It seems to me as poor a thing to strain one's eyes at a microscope over a dead and dry polypidom, as it does to examine a shrivelled and blackened flower out of a herbarium ; though I know well that both are often indispensable for the making out of technical characters. But if you want to get an insight into the structure and functions of these minute animals, or if you would be charmed with the perception of beauty, or delighted with new

and singular adaptations of means to an end,—or if you desire to see vitality under its most unusual, and yet most interesting phases,—or if you would have emotions of adoring wonder excited, and the tribute of praise elicited to that mighty Creator who made all things for His own glory,—then take such a zoophyte as this, fresh from the clear tide-pool, take him without inflicting injury; there fore detach with care a minute portion of the surface-rock, and drop your prisoner, with every organ in full activity, into a narrow glass cell with parallel sides, filled with clear sea-water, and put the whole on the stage of the microscope, with a power of not more than 100 linear, at least, for the first examination. I greatly mistake if you will not confess that the intellectual treat obtained is well worth—ay, ten times more than worth—all your trouble.”

CRISIADÆ, signifying a *separation*; applied to a parasitical family. *Crisia cornuta*, “Goat’s-horn Coralline” of Ellis, having cells linked in a single series; the same remark applies to *C. chelata*, “Bull’s-horn Coralline;” the latter look like a number of *woes* fitting close to the angle, joined by the toe-part to the heel of others. Ellis says: “This beautiful coralline is one of the smallest we meet with. It rises from tubuli growing upon fuci, and passes from thence into sickle-shaped branches, consisting of single rows of cells, looking when magnified like bull’s horns inverted, each one arising out of the top of the other. The upper branches take their rise from the fore-part of the entrance of a cell, where we may observe a stiff, short hair, which seems to be the beginning of a branch. The opening of each cell, which is in the front of its upper part, is surrounded by a thin circular rim; and the substance of the cells appears to consist of a fine transparent shell or coral-like substance.”

*Crisia eburnea*, “Tufted-ivory Coralline,” attains the height of an inch, and displays its beautiful white, bushy tufts, with often a dash of light-red intermingled. Its cells are loosely aggregated and cylindrical, with bent tubular orifices free; while the *Crisia aculeata* have cells closely aggregated, cylindrical, nearly straight, with long slender spines springing from the margin of every cell, giving it a delicate and pretty appearance.

ÆUCRATIADÆ.—We select from this family a specimen of



great interest, the *Anguinaria*,—from the Latin *anguis*, a snake. This, and also *Notamia*, belong to the class *Polysoa*. An account of the *Anguinaria spatulata*, "Snake-head Coralline," appeared in the *Transactions of the Microscopical Society*, by Mr. Busk, who corrects the errors of other observers. The polype is parasitical upon fuci, and is not unfrequently associated with other kinds on the same plants, as in fig. 244, No. 2, on *Campanularia*. The *A. spatulata* "as a whole, consists, like all its congeners, of two distinct portions, one usually termed the radical, and another which constitutes the proper polype cells. In the present instance, the arrangement of these parts is in some respects very peculiar and curious; but it will be found upon strict examination to accord accurately with the universal type."

"In the radical tubes, and on the dorsal or upper surface of the dilated extremity of the polype-cell, represented at No. 2, this earthy matter is deposited in the form of minute angular or rounded particles, presenting faint traces of a linear arrangement; but in the main body of the polype-cell, or the upright portion, the calcareous material is arranged in beautifully regular rings, giving that part of the zoophyte a peculiarly elegant appearance under the microscope. This calcareous ingredient is sufficiently abundant to render the contents of the radical tubes and polype-cells indistinct; and to obtain a satisfactory view of these parts it is necessary to remove the earthy matter by some weak acid. When this is done, it will be found that the contents of the radical portion are coarsely granular, and the wall rather thicker than those of the proper polype-cell. The latter contains an ascidian polype, which has about twelve tentacles, and no gizzard." The polype, as far as Mr. Busk has observed, is always lodged in the upright portion of the cell; but the long retractor muscular fibres arise near the commencement of the horizontal portion of the cell, from its upper wall, and nearly at one point.

The expanded portion of the cell, besides the special muscles of the aperture, contains other muscular fibres, in all respects resembling those described by Dr. Farre, as conducting to the extrusion of the polype in *Bowerbankia*,

and which are also very distinct in the *Notamia*; but which, in the present instance, would seem to have for their chief function the drawing-up or corrugation of the membranous portion of the polype-cell. These muscular fibres have a distinct central nucleus or thicker portion, as is the case in the analogous muscles in some other polypes.

ESCHARIDÆ.—This interesting family justly deserves the great attention many naturalists have bestowed upon it. Linnæus named it *Flustra*, from the Saxon word *flustran*, to weave; it is commonly called a *Seamat*, and resembles fine network spread over stones, rocks, shells, and marine plants. This network, when submitted to the powers of the microscope, is found to be a cluster of cells, in each of which dwells an animal, that protrudes its feelers when searching for food, and sinks into its little home when tired, or alarmed by approaching danger.

Dr. Grant estimates that a single *Flustra* has as many as four hundred millions of cilia on these restless tentacles. The tentacula vary from ten to twelve; the general organization consists of a gullet, a gizzard, a stomach, and intestines, the body itself being quite transparent. When collected together in clusters they take the form of a delicate minute tree, having cells in all parts, and of various colours. Lamouroux says: "When the animal has acquired its full growth, it protrudes from the opening of its cell a small globular body, which it fixes near the aperture, and as it increases in size, soon assumes the form of a new cell; it is yet closed, but through the transparent membrane that covers its surface the motions of a polype may be detected; the habitation at length bursts, and the tentacles protrude; eddies are produced in the water, and conduct to the polype the atoms necessary for its subsistence. The aperture of the cells is formed by a semicircular lid, convex externally and concave internally, which folds down when



FIG. 245.—*Eschara cervicornis*, Sea-moss polype: the animal is represented out of its polypidom.

the polype is about to advance from the cell. The opening of this lid in the *F. truncata*, where it is very long, appears through the microscope like the opening of a snake's jaws; and the organs by which this motion is effected are not perceptible. The lids of the cells open and shut in the *Flustræ* without the slightest perceptible synchronous motion of the polypes."

In the formation of their stony skeletons, the animals appear to take a most insignificant part; they are principally secreted by the integuments or membranes with which they are invested, in like manner as the bones and nails in man are secreted by tissues designed for that purpose, and acting slowly and imperceptibly. From an analysis of the stony corals, it appears that their composition is very analogous to that of shells. The porcellaneous shells, as the cowry, are composed of animal gluten and carbonate of lime, and resemble, in their mode of formation, the enamel of the teeth; whereas the pearly shells, as the oyster, are formed of carbonate of lime and a gelatinous or cartilaginous substance, the earthy matter being secreted and deposited in the interstices of a cellular tissue, as in bones. In like manner, some corals yield gelatine upon the removal of the lime, while others afford a substance in every respect resembling the membranous structure obtained by an analysis of the nacreous (pearly) shells. A recent elaborate analysis of between thirty and forty species of corals, by an eminent American chemist (Mr. B. Silliman), has shown, contrary to expectation, that they contain a much larger proportion of fluorine than of phosphoric acid.

*Flustra foliacea*, the broad-leaved Horn-wrack of Ellis, is about four inches high, and of a brown colour. The cells are small, in alternating rows; and sometimes covered by a lid opening downwards. Hook says: "For curiosity and beauty, I have not, among all the plants or vegetables I have yet observed, seen any one comparable to this sea-weed." *Flustra truncata* is abundant in deep water, and grows to a height of about four inches; it is of a delicate yellow colour, and bushy. This is the narrow-leaved Horn-wrack of Ellis; for it must not be forgotten that the older writers regarded the whole genera as *plants*.

*Flustra chartacea*.—Ellis states: "The cells of this sea mat are of an oblong square figure, swelling out a little in the middle of each side. The openings of the cells are defended by a helmet-like figure; from hence the polype-shaped suckers extend themselves. This sea-mat is of a slender and delicate texture, like a semi-transparent paper, of a very light straw-colour. It was first found on the coast of Sussex, adhering to a shell. I have since met, on the same coast, about Hastings, in the year 1765, with several specimens whose tops are digitated, and others that were very irregularly divided."

The *Flustra carbacea* grow out in a leaf-like manner, gradually widening to the end: they are found on shells of a yellowish-brown colour; on one of the sides the cells are both large and smooth. The animals have about twenty-two arms or feelers, which, says Dr. Grant, after a most careful examination of these polypes, "are nearly a third of the length of the body; and there appear to be about fifty cilia on each side of a tentacle, making 2200 cilia on each polype. In this species there are more than eighteen cells in a square line, or 1800 in a square inch of surface; and the branches of an ordinary specimen present about ten square inches of surface; so that a common specimen of the *F. carbacea* presents more than 18,000 polypes, 396,000 tentacles, and 39,600,000 cilia.

"They are very irritable, and frequently observed to contract the circular margin of their broad extremity, and to stop suddenly in their course when swimming; they swim with a gentle gliding motion, often appear stationary, revolving rapidly round their long axis, with their broad end uppermost, and they bound straight forward, or in circles, without any other apparent object than to keep themselves afloat till they find themselves in a favourable situation for fixing and assuming the perfect state. The transformation of the ova, from that moving, irritable, free condition of animalcules, to that of the fixed and almost inert zoophytes, exhibits a new metamorphosis in the animal kingdom not less remarkable than that of many reptiles from their first aquatic condition, or that of insects from their larva state."

*Flustra avicularis*.—This is another of the little beauties

of the deep, found usually on old shells, an inch in height, spreading itself fan-like, and of an ashy colour, deeply divided in a dichotomous manner into narrow, thin, plane segments, truncate at the end, formed of four or five series of oblong cells, capped with a hollow, globose, pearly, operculum seated between the spines, of which there is one on either side of the circular aperture. The opercula are so numerous, that they give to the upper surface the appearance of being thickly strewn with orient pearls; the under-surface is even and longitudinally striated, the number of striæ corresponding to the number of rows in which the cells are disposed. Dr. Johnston describes, amongst many other British species, *F. membranacea*, "a gauze-like incrustation on the frond of the sea-weed, spreading irregularly to the extent of several square inches."

Dr. Perceval Wright discovered on the western coast of Ireland a new genus of *Alcyonidæ*, which he named after the well-known naturalist Mr. Harte, *Hartea elegans*, Plate IV. No. 86. This polype is solitary, the body cylindrical, and fixed by its base to the rock; it has eight ciliated tentacles, which are knobbed at their base and most freely displayed. It is a very beautiful polyzoon of a clear white colour, and when fully expanded stands three-quarters of an inch high.<sup>1</sup>

The fresh-water Polyzoa are peculiarly interesting objects for microscopic observation, from the very beautiful manner in which they display their ciliated tentacula, set upon a crescentic, horseshoe-shaped "lophopore." The arrangement of the latter appendage has been the cause of separating the fresh-water Polyzoa, from their marine allies, into a sub-class; the former being named *Hippocrepa* (horseshoe-like), and the latter *Infundibulata* (funnel-like).<sup>2</sup> The most striking form among the *Hippocrepa* is the *Cristatella Mucedo*—a wandering Polyzoon, capable of moving freely through the water. It may be met with during a great part of the summer in our ponds and streams, amidst the stems and leaves of aquatic plants (Plate IV.

(1) On a new genus of *Alcyonidæ*. By Dr. E. Perceval Wright. *Microsc. Journ. Science*, vol. v. p. 218. 1865.

(2) The reader is referred to a valuable treatise on the structure and classification of this group by Professor Allman, *Monograph of the British Fresh-water Polyzoa*, published by the Ray Society 1857.

**No. 97).** It is always regarded as one of the most exquisite specimens of the class Polyzoa; should there be any difficulty in finding the animal itself, the eggs, met with late in the summer or autumn, should be carefully stored in an aquarium without fish. The eggs or "statoblasts," No. 95, are small, dark, circular bodies, about the size of a pin's head, surrounded by a series of minute hooked spines; the animal conceals them among tangled masses of decayed grasses and confervæ. Polyzoa are known to live upon Desmids and Algæ; and to keep them alive the tank must be freely supplied with such kinds of food. *Cristatella Mucedo* is rarely found in the same spot a second day, it wanders about apparently in search of food; it is, therefore, provided with a contractile disc or foot, and by means of this it creeps about not far from the surface of the water, for it delights to display its beautiful crests of tentacula (about eight in number), in the broad light of day or sunlight; in this respect *Cristatella* also differs from most Polyzoa. Below the external margin is a series of tubular chambers visible through the translucent membrane; and the cœnœcium or common dermal system is of a light yellow colour, often concealing several dark, brownish-looking eggs.

*Lophopus crystallinus* is a finer Polyzoon than the former, and displays beautiful plumes of transparent tentacles arranged in a double horseshoe-shaped series. They at times abound in slow running streams, adhering to the stems of water-plants. When first removed from the water they resemble masses of the ova of one of the water snails, and have often been mistaken for them. On putting one of those jelly-like masses into a glass trough with some of the clear water from the stream, delicate tubes will be cautiously protruded, and then the beautiful fringes of cilia are soon brought into play. The organization of *L. Crystallinus* is simple, although it is provided with organs of digestion, circulation, respiration, and generation. A nervous<sup>1</sup> and muscular system are also tolerably well

(1) It has been demonstrated by Fritz Müller that the Polyzoa possess a nervous system:—"The nervous system of each branch consisting of—1st, a considerable sized ganglion situated at its origin; 2d, of a nervous trunk running the entire length of the branch, at the upper part of which it subdivides into branches, going to the ganglia of the internodes arising at this part; and 3d, of

developed. It increases both by budding and by ova, both of which conditions are shown in Plate IV. No. 98. The ova are generally seen enclosed in the transparent case of the parent. In *Lophopus* and most other fresh-water genera, such as *Cristatella*, *Plumatella*, and *Alcyonella*, the neural margin of the lophopore is extended into two triangular arms, giving it the appearance of a deep crescent.

*Alcyonella* is a genus of fresh-water polyzoa, found usually about the autumnal period of the year in the several Docks at the East end of London, adhering to floating pieces of timber. It assumes the form of an irregular sponge-like mass, with an aggregation of membranaceous tube-like openings covering the surface. From these openings, the polypes are seen to project, the mouths of which are encircled with a single series of filiform ciliated tentacles, which keep the surrounding water in active motion. The polypidom seen in water has the appearance of a blackish-green sponge.

Trembley gave an interesting account of the family of *Alcyonella*; and Mr. J. Newton Tomkins favours us with the following observations on the development of the *Alcyonella stagnorum* (*fluviatella*):—

“The ova now under examination ( $\frac{1}{2}$ -inch obj. A. eye-piece—100 lin. diam., Wollaston’s condenser), are the products of some healthy specimens of *Alcyonella stagnorum* given me by Mr. Lloyd, and sketched in full activity in September 1856. Soon after this period their movements decreased in energy, numerous ova were detached, which floated to the surface of the water of the jar in which they were confined, and in the course of a very few weeks no trace remained of the parent animals, except a spongy mass of an almost gelatinous character, which still exists, though devoid of definite form, and appears composed of a mass of broken and disorganized cells.

“In November, with a view of preserving the water in a normal condition, I introduced a sprig of *Anacharis*

a rich nervous plexus resting on the trunk, and connecting the ganglia just mentioned, as well as the basal ganglia of the individual polypides.” For further account, see paper in the *Micros. Journ.* vol. 1. New Series. p. 330.

*Alsinastrum*, and finding it grew freely, but soon covered with a filamentous confervoid growth, threw in two small water-snails, which are there still. About January last, the ova, which till then had floated on the surface of the water, began to sink and attach themselves to the leaves of the *Anacharis* and elsewhere. Latterly, they have all subsided to the bottom of the jar, where they lie in company with a quantity of decayed vegetable matter, spawn of the *Limnæus*, &c. They are of a light-brown colour, ovoid in shape, longest diameter  $\cdot 0089$ , shortest diameter  $\cdot 0172$ . The outer rim seems built up of cells of oblong shape, but necessarily ill-defined, owing to their being observed by light transmitted through two surfaces; the inner or central portion also cellular, but from the convexity of the object, more easy to determine as to its true nature, formed of larger hexagonal-shaped cells. Seen by higher power ( $\frac{1}{4}$ -in. obj. A. eye-piece—220 lin. diam.), these central cells, besides being unmistakably hexagonal in form, have each a distinct dark nucleus in the centre: this, however, may be an optical fallacy, due to their peculiar position on a curved surface. No movement yet visible, April 25, 1857."

*Plumatella Repens*, Plate IV. No. 99, so named from its feather-like crown of tentacles, is a well-known fresh-water Polyzoan, found in ponds and rivulets attached to aquatic plants, generally choosing the under-surface for the purpose of avoiding the strong light. It is a very elegant variety, rather timid, withdrawing on the least disturbance of the water, and not again venturing to display its beautiful plume until all is once more perfectly quiet. Professor Allman says of it:—"Except in the condition of the dermal system the structure of *Plumatella* differs in no essential point from that of *Alcyonella*. This system, however, in the coalescence of the tubes into a common mass in *Alcyonella*, while they remain totally distinct in *Plumatella*, presents us with a difference of sufficient importance to justify the placing the two forms in separate generic groups. The number of known species are twelve, of which nine are British. The cænæcium consists of a linear-branched series of tubular cells of membrano-corneous consistence, which is terminated by the orifice



destined for the egress of the polypides. The tentacula are about sixty in number, long, and ciliated on either side. The statoblasts are ovoid, of a dark-brown colour without marginal spines, and contained within the poly-

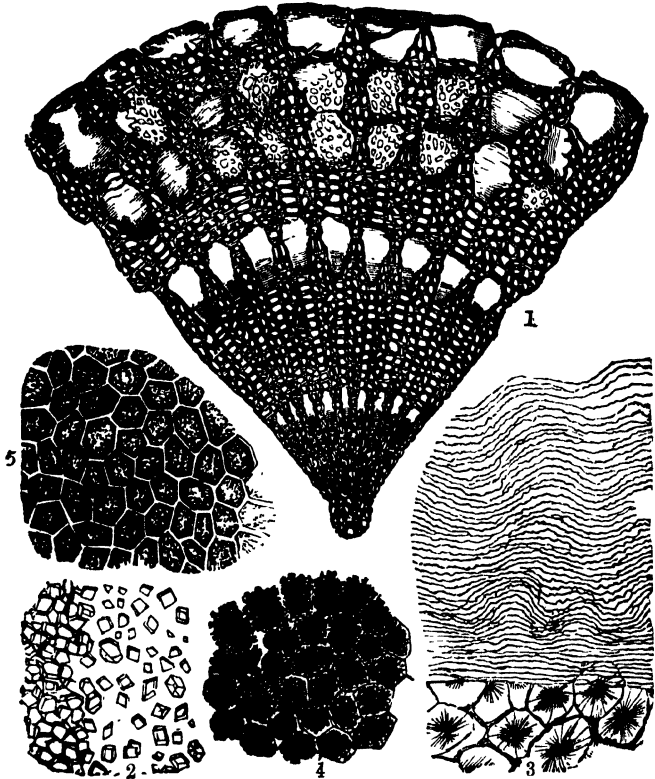

Fig. 247.

1, Portion of a transverse section of the spine of an *Echinus*. 2, Crystals of carbonate of Lime, from the surface of shell of Oyster. 3, Horizontal section of shell of *Haliotis splendens*, with stellate pigment in the interior. 4, Portion of shell of a Crab, showing granules beneath the articular layer. 5, Another portion of the same shell, showing its hexagonal structure.

pidom, through the transparent walls of which they can be readily seen. It occurs in greatest perfection during the

summer and towards autumn, often obtaining to a considerable size." Most of the species may be found in the ponds around London, and few objects are capable of affording greater pleasure than these Polyzoa when examined in a living state under a moderate power, and with a dark-ground illuminator. The withdrawal of the Polyzoa from the Radiate sub-kingdom, and their location among Mollusca, was a step in the right direction; while the important division of the molluscan sub-kingdom by Milne-Edwards into primary sections of the *Mollusca* and *Molluscoidea*, the latter including the Tunicata and the Polyzoa, is all that can be desired in the systematic location of the Polyzoa.

*Shell of Mollusca.*—The simplest form of shell occurs in the rudimentary oval plate of the common Slug, *Limax rufus*; it is imbedded in the shield situated at the back and near the head of the animal.

When a molluscous or conchiferous shell is composed of a single piece, it is then termed *univalve*; when of two pieces, *bivalve*. The bivalve *Mollusca* exhibit no trace of any distinct head; whilst in the univalve this part of the body is well-marked, and usually furnished with special organs of sense (tentacles, eyes, nerves, &c.).

The older naturalists recognised a group of multi-valve shells, or shells composed of several valves, the majority of which belonged to the Cirrhopod order of *Crustacea*, and were regarded as *Mollusca* by earlier observers. The *Pholades*, however, which in other respects are true bivalve *Mollusca*, are furnished with a pair of accessory plates in the neighbourhood of the hinge; whilst the *Chitons*, a small but singular group of Molluscs nearly allied to the univalve limpets have an oval shell composed of eight movable plates, which gives them a great resemblance to enormous woodlice; and they have been regarded as forming a sort of transition towards the articulated division. Those *Mollusca* not furnished with a shell, or having only a small calcareous plate en-



Fig. 248.—*Aplysia*, sea-hare.

closed within the mantle, are called Nudibranchiata; an example of this family is seen in fig. 248, *Aplysia*; but it is remarkable that most of them are provided with a small shell when they first quit the egg. In the shell-bearing or *Testaceous Mollusca*, this embryonic shell, which often differs greatly in shape and texture from the shell of the mature animal, is, however, a commencement of the latter; additions being constantly made to the free edge by the secretion of calcareous matter at the margin of the mantle. The delicate membranaceous part of the mantle, which lines the internal portion of the shell inhabited by the animal, has also the power of secreting a thin layer of shelly matter upon its inner surface. This is frequently of a pearly lustre; and in many bivalves a new layer of this substance is deposited at the time when the size of the shell is increased by additions to its margins,—for it must be observed that the formation of new shell is not constantly going on, but appears to be subject to periodical interruptions, as indicated by lines on the surface of the shell; which are called lines of growth. In many cases, the margin of the mantle, instead of being even, presents lobes of tubercles; these produce corresponding irregularities,—ribs, tubercles, or spines,—on the surface of the shell.

Dr. Bowerbank says, “Shell is developed from cells that in process of growth have become hardened by the deposition of calcareous matter in the interior.” This *earthy* matter consists principally of carbonate of lime, deposited in a crystalline state; and in certain shells, as in that of the common Oyster (fig. 247, No. 2), from the animal-cell not having sufficiently controlled the mode of deposition of the earth particles, they have assumed the form of perfect rhomboidal crystals.

The shell of the genus *Pinna*, “Wing-shells,” is composed of a series of hexagonal cells filled with transparent calcareous matter, seen in fig. 240, No. 2, the outer layer of which can be split up into prisms, like so many basaltic columns; as at No. 1.

Organs of sense are possessed by some of this class in an advanced state of development. In the Scallop (*Pecten*), for example, eyes occur in great numbers, placed among

the tentacles on the borders of the mantle. In other genera, the eyes are differently placed, in *Pinna* on the fore part of the mantle, and around the siphon-orifices in *Pholas* and *Solen*. In the Cockle (*Cardium*) the short siphons are surrounded with an extraordinary number of tentacles, capable of protrusion, each of which bears a pretty little eye; these are beautiful objects under the microscope. Cockles are able to perform vigorous leaps by means of a well developed foot, which they possess; in other species the foot is grooved; and being associated with a gland which has the power of secreting a glutinous substance, the latter is drawn out into slender threads, with a sucker-like or flattened extremity, by which they attach themselves to rocks. The grooved foot is then withdrawn, and the thread hardens into an elastic sort of cord, called a *byssus*. It is by an aggregation of these threads that the common Mussel moors itself securely. The hinge of the shell is formed of variously shaped dentations; those under the beak are called *cardinal* teeth; those on either side are *lateral* teeth.

The *Pholadidæ* are a series of animals remarkable for their destructive *boring* propensities. The *Teredo*, ship-worm, is well known for the damage it does to the bottoms of ships, especially in the tropical seas. Others of this family give a preference to sandstone, and even the most compact marble has been found bored through by them.

Mr. J. Robertson says:—"Having, while residing here (Brighton), opportunities of studying the *Pholas dactylus*, I have endeavoured during the last six months to discover how this mollusc makes its hole or crypt in the chalk,—by a chemical solvent? by absorption? by ciliary currents? or by rotatory motions? My observations, dissections, and experiments set at rest controversy in my mind. Between twenty and thirty of these creatures have been at work in lumps of chalk in sea water in a finger glass and a pan, at my window, for the last three months. The *Pholas dactylus* makes its hole by grating the chalk with its rasp-like valves, licking it up when pulverized with its foot, forcing it up through its principal or branchial siphon, and squirting it out in oblong nodules. The crypt protects the

*Pholas* from *Confervee*, which, when they get at it, grow not merely outside, but even within the lips of the valves, preventing the action of the siphons. In the foot there is a gelatinous spring, or style, which when taken out has great elasticity, and which seems the mainspring of the motion of the *Pholas dactylus*."

*Tunicata*.—The most remarkable group of animals belonging to this order are the *Ascidians*. The cell of the Polyzoon is represented in the *Ascidian* by a *test* or *tunic*—from which they derive their name—of a membranous or cartilaginous consistence, and often including calcareous spicules,—having two orifices, within which is another envelope, distinguished as the *mantle*. Few microscopic spectacles are more interesting than the sight of the circulation along this network of muslin-like fabric, and that of the ciliary movement by which the circulating fluid is kept moving. In the transparent species, such as *Clavelina* and *Perophora*, this movement is seen to great advantage. The animals are found very commonly adhering to the broad fronds of *fuci*, or on pieces of shell, near low water-mark. They thrive in tanks, and multiply both by fissuration and budding. Two species are figured in Plate IX. *i* and *k*, *Botryllus violaceus* belonging to the family *Didemnians*, the zooids of which are often arranged in the beautiful stellate clusters seen in the plate.<sup>1</sup>

*Pteropoda*.—The most prominent character of this class is the possession of two broad muscular fins, one on either side of the neck, somewhat resembling the expanded wings of a butterfly, whence Cuvier gave them the name of *Pteropoda*, "wing-footed." In *Clio*, the anatomy of which has been carefully investigated, there is a very curious apparatus developed for seizing its prey. On each side of the mouth are three fleshy warts, covered with minute red specks. Under the microscope, these specks, numbering about three thousand on each tentacle, are seen to be transparent cylinders, each containing in its cavity twenty stalked discs, and forming so many adhesive suckers.

(1) For information respecting the Compound Ascidians, see the admirable monograph of Milne-Edwards, Art. *Tunicata* in the *Cyclop. Anatomy and Physiology*, Huxley in *Phil. Trans.* for 1851, or *Journ. Microsc. Soc.* vol. iv. 1856 • also Prof. Allman, same journal, vol. vii. 1859.

The Oyster is the type of the tribe *Ostracea*, all of which are *Acephalus*, that is, animals without a distinct head. The gills, or breathing apparatus, form what is commonly called the beard of the oyster. The creature is attached by strong muscles to its shell. The mouth of the oyster is a mere opening in the body, without jaws or teeth; its food consists of nourishing substances suspended in the water, and which are drawn into the shell when it is open by means of cilia. Oysters attach one of their valves to rocky ground, or some fixed substance, by a mucilaginous liquid, which soon becomes as hard as the shell itself. They spawn some time in May; and their growth is so rapid, that in three days after the deposition of the spawn, the shell of the young oyster is nearly a quarter of an inch broad; in three months it is larger than a shilling. The spawn is a very interesting object for microscopic examination, especially with polarised light. The young fry is represented in fig. 254; some with cilia protruded.

In the stomach of the Oyster, and in the alimentary canal, myriads of living *Paramacium* and other Infusoria are found swimming in great activity; swarms of a conglomerate and ciliated living organism, somewhat resembling the *Volvox globator*, and so extremely delicate in their structure that they require a good objective to define them.

Pearls are usually met with in the *Meleagrina Margaritifera*, "Pearl Oyster," which, however, does not belong to the family *Ostracea*. They are likewise found in the Mussel known as *Mya Margaritifera*, and an inferior kind in many Mussels of the rivers of Great Britain; and, at one time, the pearl-fishery of Ireland was justly celebrated. Naturalists somewhat differ in their opinions as to the mode in which pearls are formed. Some think that they are produced by particles of sand getting into the stomach; the animal, to prevent the roughness of these particles from injuring its delicate structure, covers them over with a secretion from a gland, and, by continual additions, they gradually increase in size. Mussels, in which artificial pearls were said to have been formed by the Chinese, have frequently found their way to this country.

It is now, however, very generally admitted to be a diseased condition. Pearls are matured on a nucleus, consisting of the same matter as that from which the new layers of shell proceed at the edge of the Mussel or Oyster. The finest kinds are formed in the body of the animal, or originate in the pearly-looking part of the shell. It is from the size, roundness, and brilliancy of pearls that their value is estimated.

The microscope discloses a difference in the structure of pearls: those having a prismatic cellular structure have a brown horny nucleus, surrounded by small imperfectly-

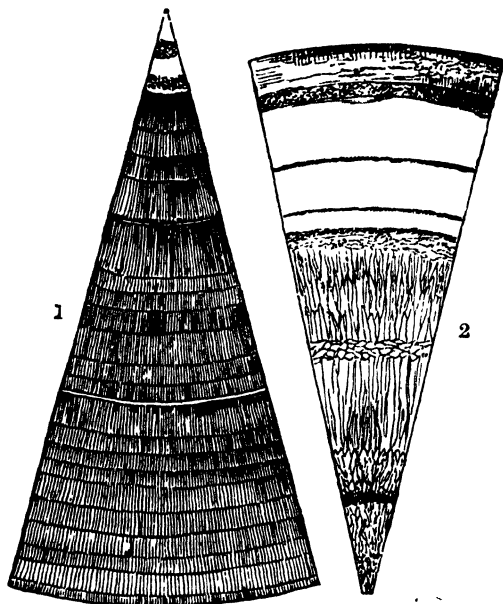

Fig. 249.

- 1, A transverse section of a Pearl from Oyster, showing its prismatic structure.  
 2, A transverse section of another Pearl, showing its central cellular structure, with outside rings of true pearly matter. (Magnified 50 diameters.)

formed prismatic cells; there is also a ring of horny matter, followed by other prisms, and so on, as represented

in fig. 249; and all transverse sections of pearls from Oysters show the same successive rings of growth or deposit.

In a segment of a transverse section of a small purple pearl from a species of *Mytilus* (fig. 250), all trace of prismatic structure has disappeared, and only a series of fine curved or radiating lines is seen. This pearl consists of a beautiful purple-coloured series of concentric laminae; many of which have a series of concentric zones, and are of a yellow tint. The most beautiful sections for microscopic examination are obtained from Scotch pearls.

*Brachiopoda*, "Lamp-shells," or, as the name literally

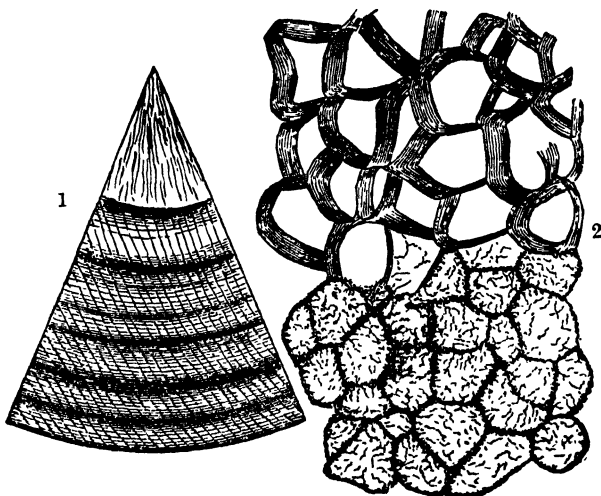

Fig. 250.

1, A transverse section of a small Pearl from a species of *Mytilus* 2, Horizontal section of same Pearl magnified 250 diameters, to show prismatic structure and transverse striae.

signifies, *arm-footed*, is intended to express a most remarkable characteristic of these animals, the presence of a pair of arms, often of great length, rolled up in a spiral form, and believed by Cuvier to replace the foot in other bivalves. Professor Owen has shown that these organs are tubes closed at each end, and contain a fluid, which by



the contraction of the circular muscular fibres of which the walls of the tube are composed, is propelled from the base to the extremity, thereby unrolling, as he believes, the spiral coils. One side of each arm is fringed with a vast number of long filaments: these are ciliated. The shell is opened by a peculiar process, which has given to the *Terebratula* the name of Coach-spring Shell. In the shell there are minute openings surrounded by a series of radiating lines: these at first appear like dark oval spots; but in a vertical section they are seen to be perforations or tubes running obliquely from the inner to the outer surface of the shell, and having a series of radiating lines on the edge, as in fig. 240, No. 3. The outer layer has been removed, to show a radiating structure around the perforations. Dr. Carpenter fully describes *Terebratula* in the *Philosophical Magazine*, 1854.

Not less curious than beautiful is the internal layer of many kinds of bivalves, which present an iridescent lustre, the whole surface being varied with a series of grooved lines running nearly parallel to each other. The well-known gorgeously coloured univalve, the Ear-shell, *Haliotus splendens*, has been ascertained to consist of numerous plates, resembling tortoise-shell, forming a series of hexagonal cells, in the centre of which the stellate pigment is deposited (fig. 246, No. 3), alternating with thin layers of pearl, or *nacre*; and this exhibits, when highly magnified, a series of irregular undulating folds, represented in the upper portion of the section. The iridescent lines are often extremely pleasing; and if a piece be submitted to the action of diluted hydrochloric acid, until the calcareous portion of the nacreous layers are dissolved out, the plates of animal matter fall apart, each one carrying with it the membranous residuum of the layer of nacre that belonged to its inner surface. But the nacre and membrane covering some of these horny plates remain undisturbed; and their folded or plaited surfaces, although divested of calcareous matter, exhibit iridescent hues of the most gorgeous description. If the membrane be spread out with a needle, and the plates unfolded to a considerable extent, the iridescence is no longer seen; a fact which clearly demonstrates that the beautiful colours

presented by the nacreous portions of shells, commonly called mother-of-pearl, are produced solely by the disposition of single membranous layers in folds or plaits, lying more or less obliquely to the general surface.

In the *Chitonidæ*, Coat of mail Shells, the shell consists of eight transverse plates, imbedded in the mantle; in the Limpets, the ordinary form is that of a cone. The arrangement of the teeth is somewhat remarkable.

The majority of *Gasteropoda* are furnished with a shell, denominated *spirivalve*. The cause of this spiral arrangement is said to be owing to the shape of the body of the animal inhabiting the shell, which, as it grows, enlarges its shell principally in one direction; thus, of course, making it form a spire, modified in shape according to the degree in which each successive turn surpasses in bulk that which preceded it. It would rather appear that this is principally owing to the ciliary motion imparted to the early stage of the embryo; the first deposit of calcareous matter forming the *axis*, the tube continues to rotate upon its axial pillar or *columella*, as it is called; and by reason of some other peculiar vital tendency, the shell is gradually deposited in a series of cells; thus enlarging its conical form, and winding obliquely from right to left. Every turn around the axis is termed a *whorl*; and when the columella is hollow, it is said to be *umbilicated*. In the spirivalve-shelled *Gasteropoda*, we find a difference in structure between that part of the mantle which envelops the viscera, and which is always concealed within the cavity of the shell, and the portion placed around its aperture.

The mouths of most *Gasteropoda* consist of a strong muscular cavity, and a crescentic-shaped tooth-bearing membrane, armed with sharp points, and separated by semi-circular cutting spaces, admirably adapted for the division of the food upon which they feed. Most of them are beautiful objects for the microscope.

Professor Huxley very properly objects to the use of the commonly accepted term *tongue* for the tooth-bearing membrane of the mollusca, and more appropriately designates it "the odontophore."

"The *odontophore* consists essentially of a cartilaginous

strap, which bears a long series of transversely-disposed teeth. The ends of the strap are connected with muscles attached to the upper and lower surface of the hinder extremities of the cartilaginous cushions ; and these muscles, by their alternate contractions, cause the toothed strap to work backwards and forwards over the end of the pulley formed by its anterior end. The strap consequently acts

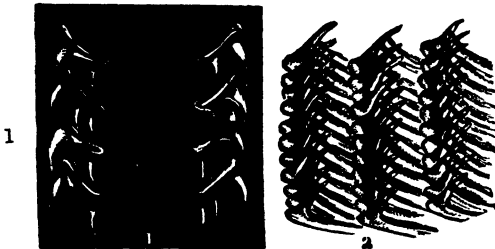

Fig. 251.

1, Palate of *Buccinum undatum*, common Whelk, seen under polarised light.  
2, Palate of *Doris tuberculata*, Sea- slug.

after the fashion of a chain-saw (rather of a rasp,) upon any substance to which it is applied, and the resulting wear and tear of its anterior teeth are made good by the incessant development of new teeth in the secreting sac in which the hinder end of the strap is lodged. Besides the chain-saw-like motion of the strap, the odontophore may be capable of a licking or scraping action as a whole."<sup>1</sup>

In the constant growth of the band we observe the development of new teeth. In some the teeth on the extreme part of the band differ much, both in size and form, from those in the median line : so much, that if at any time one portion be separated from the other and then examined, it might be supposed to belong to another species.

Since the investigations of Professor Loven, of Stockholm, into the lingual dentition of the glossophorous Mollusca, various observers have studied the subject with great advantage to our knowledge of the affinities of those animals. Although the patterns or types of the lingual membranes are, on the whole, remarkably constant, yet

(1) *Elements of Comparative Anatomy*, p. 36.

TONGUES, ETC., OF GASTEROPODS.

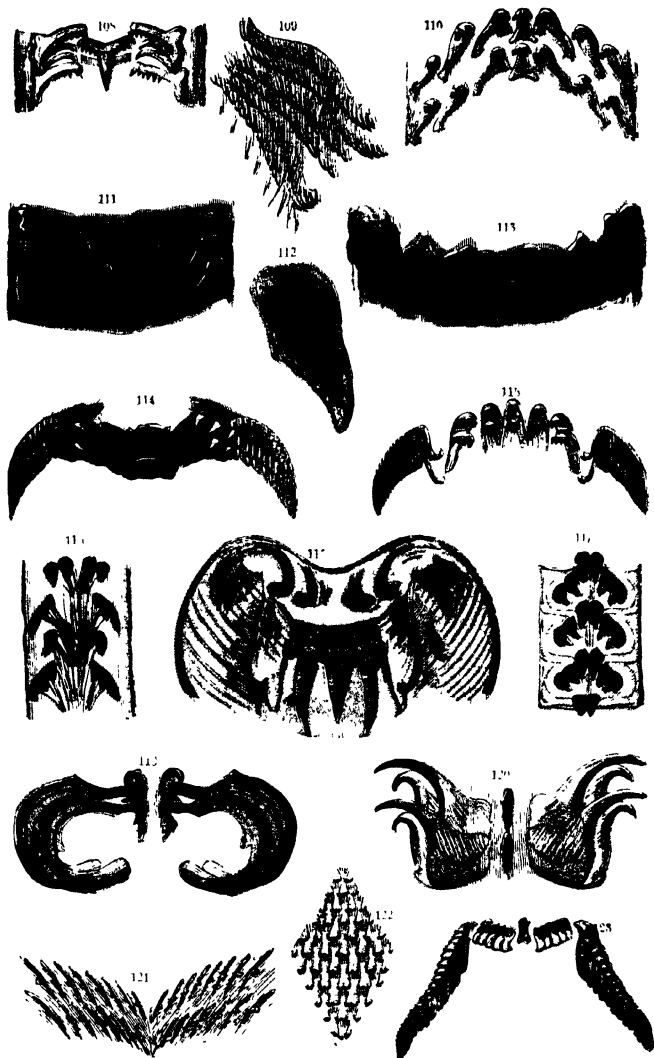

Tuffen West, del

W F Maples, ad nat del.

Esham Evans



their systematic value is not uniform ; and therefore the attempts to remodel the arrangement of the Gasteropoda by their peculiarities of dentition have not become so complete a success as was at first expected. Some, however, hold a different opinion ; and Dr. J. E. Gray writes : —“ One result of the study of these papers (Loven's, *On the Tongues of Mollusca*) and the examination of the tongues of several molluscs has been to establish more firmly the theory which I have long entertained, that no species of gasteropodous molluscous animal can be properly placed in the system unless we are enabled to examine the animal, the shell, the operculum, and the structure of its tongue ; and as none of these parts but the shell can be examined in the fossil species, their position in the various genera must be always attended with more or less uncertainty.”<sup>1</sup>

Dr. Troschel has laboured much in this field of investigation, and in his valuable work on the subject attempts a classification of the principal types by their lingual dentition. The union under one formula of so many creatures widely differing in anatomy, habits, and shell structure, clearly indicates that, if the lingual ribbon contains generic characters, they have not yet been ascertained. At the same time, it does present differences which may offer collateral evidence in cases otherwise difficult of discrimination. It does not help us to separate carnivorous from phytophagous animals ; but it seems possible to make use of it as a mark between species ; for, in all, there is a distinct difference between the tongues even of the most closely allied. Thus, amongst other changes, it has been found necessary to remove the *Proserpinadæ* from the neighbourhood of the *Cyclophoridæ*, to which they were formerly supposed to be nearly related, and to place them in a more natural position near the *Neritidæ*. That these investigations are of value is also shown by the light which has been shed on the true position of *Aporrhais*, supposed by so great a naturalist as Forbes to be akin to the *Cerithiidæ*, but which is shown by its dentition to belong to the *Strombidæ*.<sup>2</sup>

(1) *Annals of Nat. Hist.* Ser. ii. vol. x. p. 413.

(2) See a paper on the subject in the *Trans. Linn. Soc.* 1867.

The relations of the freshwater operculata are as varied as those of the land. *Ampullaria* seems to find its nearest marine relative in *Natica*, an opinion which seems confirmed by the form of the shell. A West Indian species found on the trees of the forests of those islands, and placed by Lamarch in the *Helicina*, would rather appear to belong to *Neritina*. The several peculiarities of their teeth, especially that of *H. nemoralis*, with its numerous uncini, its sub-opaque trapezoid laterals, which seem heretofore to have been overlooked, confirm the belief in its close relationship to *Neritina*. The horny mandibles of the Mollusca may be deserving of some attention with a view to the elucidation of their affinities. In *Cyclotus translucidus* the mandible is divided into two portions by a median articulation, and it is covered with fine denticulations in regular rows, somewhat like that of *Velutina*, Plate V. No. 109. In most of the inoperculata, the mandible is horse-shoe-shaped, and striate or corrugate. In *Ampullaria*, the same organ is beak-shaped, like the upper mandible of *Octopus* or *Loligo*.

"The lingual band, we should premise, has been, for convenience of description, divided into longitudinal areas, which are crossed by many rows of teeth. There are five, distinguishable by the different characters of the teeth they bear; but the characteristics are not always present. The teeth are consequently named *median*, *lateral*, and *uncini*, although the latter are not necessarily more hooked than the others. The areas bearing the *uncini* have been called *pleuræ*. Since each row is a repetition of all the rest, the system of teeth admits of easy representation by a numerical formula, in which, when the *uncini* are very numerous, they are indicated by the sign  $\infty$  (infinity), and the others by the proper figure. Thus,  $\infty \cdot 5 \cdot 1 \cdot 5 \cdot \infty$ , which represents the system in the genus *Trochus*, signifies that each row consists of one median, flanked on both sides by five lateral teeth, and these again by a large number of *uncini*. When only three areas are found, the outer ones are to be considered as the *pleuræ*, inasmuch as there is frequently a manifest division in the membrane between them and the lateral areas."

Most of the Cephalopod molluscs are provided with

strong, well developed teeth ; they are all animal feeders. Loven describes those of the cuttle-fish (*Sepia officinalis*, Plate V. No. 111), as like *Pteropoda*, formula of teeth, 3 · 1 · 3. The *Sepia* is also furnished with a retractile proboscis, and a prehensile spiny collar, apparently for the purpose of holding its prey while the teeth are employed in drilling or abrading it. In the Squid (*Loligo*, No. 113), the medians, broad at the base, approach the tricuspid form with a prolonged acute central cusp ; while the *uncini* are much prolonged and slightly curved. The lingual band increases in breadth towards the hinder part, in some instances to twice the diameter of the anterior. The band, when mounted dry, forms a fine object for the black-ground illuminator, or side reflector. The lingual band of *Octopus tuberculatus* differs slightly with *Sepia*.

The *Nudibranchiata* have become more attractive since the publication of the valuable and beautifully-illustrated monograph of Messrs. Alder and Hancock. The nudibranchs are without a shelly covering, slug-like in their appearance, and most voracious feeders, greedily devouring zoophytes, sponges, &c. (Plate IX. b.) They possess the remarkable property of restoring lost parts ; their powers of endurance are great, so that they may be kept alive for some time in a small glass jar of sea-water. While keeping a specimen of the *Piplida* in confinement, the Rev. Mr. Lowe noticed on several occasions a display of a brilliant phosphorescence. Many of the genus *Dorididæ* and *Eolidida* are infested with parasitic Entomostraca, which either live freely on the surface, under the skin, or adhere to the branchiæ of the animals. *Oncidoris bilamellata* (the Sea-lemon) belongs to the *Dorididæ* ; its mouth is provided with a narrow band of strong hooked teeth (Plate V. No. 120), which in some species are serrated ; all are provided with mandibles, consisting of two horny plates uniting near the fore part. The median row of teeth are small and inconspicuous ; the band is represented by the formula 2 · 1 · 2. A portion of the mandible of *Aplysia hybridæ* (the Sea-hare) is shown in Plate V. No. 112.

*Patella radiata* (the Rock-limpet).—The band of this mollusc, No. 116, may be readily distinguished from the common limpet of our coasts ; the remarkably long ribbo-



like membrane, which lies folded up in the abdominal cavity, is furnished with numerous rows of strong, nearly opaque, dark brown tricuspid teeth. The teeth of *Alcmœa* (No. 117) are differently arranged; their formula is  $3 \cdot 1 \cdot 3$ . *Chitonidæ* are said to be near relatives of the *Patellidæ*; the mouths of all are furnished with mandibles.

*Testacella maugœi*, belonging to the Pulmonifera, is slug-like in its appearance, and, curiously enough, is subterranean in its habits, chiefly feeding on earth-worms. During winter and in dry weather it forms a kind of cocoon, and thus completely encloses itself in an opaque white mantle, which effectually protects it from atmospheric influences. Its lingual membrane is large, and covered with about fifty rows of divergent teeth, which gradually diminish in size towards the median row; each tooth is barbed and pointed, broader towards the base, and furnished with an articulating nipple set in the basement membrane. A few rows are represented slightly magnified, Plate V. No. 121. Their formula is  $0 \ 0 \cdot 1 \ 0 \cdot 0$ .

*Cymba olla* (the Boat-shell) belongs to the species Velutinidæ, formula,  $0 \cdot 1 \cdot 0$ , or  $1 \cdot 1 \cdot 1$ . The lingual band, No. 118, is narrow and ribbon-like in its appearance, with numerous trident-shaped teeth set on a strong muscular membrane. The end of the strap and its connexion with the muscles at the hinder extremity of the cartilaginous cushion is shown in the drawing. The blueish appearance seen in the Plate is due to a selenite film and polarised light. *Scapander lignarius* (the Boatman shell).—The band (Plate V. No. 119), is narrow, but the teeth are bold and of extraordinary size; their formula is  $1 \cdot 0 \cdot 1$ . This mollusc is said to be without eyes. *Pleurobranchus plunula* belongs to the same family; its teeth are simple, recurved, and convex, and arranged in numerous divergent rows; the medians of which are largest. The mandible (Plate V. No. 122), presents an exceedingly pretty tessellated appearance, and the numerous divergent rows have tricuspid denticulations. *Velutina lævigata* (the Velvety shell), formula  $3 \cdot 1 \cdot 3$ .—The teeth (Plate V. No. 108) are small and fine; medians recurved, with a series of delicate denticulations on either side of the central cusp, which is much prolonged: 1st laterals, denticulate, with

outer cusp prolonged; 2d and 3d laterals, simple curved or hooked-shaped. The mandible, No. 109, divided in the centre, forms two plates of divergent denticulations.

*Haliotis tuberculatus* (the Ear-shell), is a well-known beautiful shell much used for ornamental purposes. The lingual band, Plate V. No. 114, is well developed. The medians are flattened out, recurved obtuse teeth; 1st laterals, trapezoidal or beam-like; uncini numerous, about sixty, denticulate, the few first pairs are prolonged into strong pointed cusps. *Turbo marmoratus* (the Top-shell). After the outer layer of shell is removed, it presents a delicate pearly appearance. The lingual band, No. 123, closely resembles *Trochus*; it is long and narrow, the median teeth are broadest, with five recurved laterals, and numerous rows of uncini, slender and hooked. A single row only is represented in the plate. *Cyclotus translucidus*, a family of operculate land-shells, belongs to the *Cyclostomatidæ*. The teeth shown at No. 110, formula  $3 \cdot 1 \cdot 3$ , are arranged in slightly divergent rows on a narrow band; they are more or less subquadrate, recurved, with their central cusps prolonged. *Cistula catenata*, one of the family *Cyclophoridæ*; its band, No. 115, formula  $2 \cdot 1 \cdot 2$ , shows teeth resembling those of *Littorina*, and should certainly be separated from *Cyclophoridæ*. It would also seem that the teeth of *Cyclostomatidæ* point to a near alliance with the *Trochidæ*; but this question can only be determined by an examination of several species, when it may, perhaps, be decided to give them rank as a sub-order. They are numerous enough; the West Indian islands alone furnish us with 200 species.

Professor William Thompson, in his paper "On the Dentition of British Pulmonifera," *Ann. Nat. His.* vol. vii. 1851, pointed out that the length of the lingual band, and number of rows of teeth borne on it, vary greatly in different species. The rows, however, being closely set are usually very numerous; but it is among the *Pulmonifera* we meet with the most astonishing instances of large numbers of teeth. *Limax maximus* possesses 26,800, distributed through 180 rows of 160 each; the individual teeth measuring only one 10,000th of an inch.

*Helix pomatia* has 21,000, and its comparatively dwarfed congener, *H. obvoluta*, no less than 15,000. When it is remembered that these estimates refer to series of forms, curiously carved and sculptured, the total area sustaining them not measuring in most of the molluscs half an inch in length, we must be filled with admiration at the marvellous creative power bestowed upon the organization of these lowly-creeping creatures.

*The Preparation of Teeth of Mollusca.*—The method of preparing the lingual membranes of Mollusca is as follows:—Under a dissecting microscope and a large bull's-eye condenser cut open and expose to view the floor of the mouth; pin back the cut edges throughout its length, and work out the dental band with knife and forceps. The band being detached place it in a watch-glass, and boil over a spirit lamp in caustic potash solution. Having by this process freed the tongue from its integuments, remove it, wash it well, and place it for a short time in a dilute acid solution, acetic or hydrochloric. Wash it well in water, float it upon a slide; and with a fine sable brush lay it open flat, and remove whatever dirt or fibre may adhere to it. Lastly, place it in weak spirit and water, and there let it remain for a few days before mounting. It is better to mount specimens in glycerine, Rimmington's glycerine-jelly, or Goadby's solution. Canada balsam renders them so very pellucid that the finer teeth are completely lost.

*Thread-cells.*—These curious appendages, so commonly met with in the Actinozoa, and in the tentacles surrounding the mouth of the Medusæ, are also seen in some species of Mollusca.

These prehensile threads, now generally termed "urticating organs," were discovered in 1835, in the Hydra, by Corda and by Ehrenberg. About the same time they were found by R. Wagner in the Actiniæ, who at first regarded them as zoosperms. Subsequently, however, he recognised their identity with similar organs in the Medusæ, and gave them the name of urticating organs. Since then numerous observations have shown that these organs exist in the entire class of polypes; in that of the Hydra, Medusæ, as well as in the Synaptæ, many Turbellariæ,

some Annelids, and lastly among the Mollusca, the Eolidæ in particular.

Max Schultze has divided these organs into two categories; one including those of a rod-like form, or the bacillar, which are found pretty generally in the Turbellariæ; and the other containing the urticating capsules armed with a long filament. But the researches of other observers, including Dr. Bergh, have shown that this distinction is unimportant.

Dr. Bergh has devoted much attention to the urticating filaments or *cnida* of the Mollusca, which are far less well known than those of the Cæloenterata. The existence of sacs with *cnida*—that is to say, the existence of true urticating batteries—is then at the present day a well-established fact as regards the typical forms of the Eolidæ, *i.e.* in the genera *Eolidida*, *Montagna*, *Facelina*.

In every case the urticating batteries are planted at the extremities of the papillæ above the hepatic lobe. The sac opens to the exterior by a minute pore situated at the summit. Its walls are muscular, a circular layer of fibres being the most considerable element. The interior is filled with urticating cells, together with cysts full of closely-packed filaments and free filaments. The genus *Pleurophyllidium*, according to Dr. Bergh, is the only mollusc besides the Eolidæ in which *cnida* are met with, and it is to be remarked that in their anatomical conformation these animals appear to approach very closely to the Eolidæ.

The use of these *cnida* is still involved in doubt. Mr. Lewes, however, has shown that they do not serve to paralyse the animals upon which Actiniæ feed.

*Ova of Mollusca.*—It is interesting to watch the development of the spawn of the *Mollusca* under a low magnifying power. The ova of the *Limnæus* is usually found adhering to the surfaces of stones, pieces of weed, or other matters in the water; they are always contained in a long ribbon-like delicate ova-sac of a curious and beautiful form. The mass of eggs deposited by the *Doris* resembles a frill of lace of great beauty. In *Aplysia* the spawn resembles long strings of vermicelli, of varying tints through-

(1) *On Urticating Filaments in the Mollusca*, by Dr. Bergh. *Journ. Microsc. Sci.* vol. ii. p. 274. 1862.

out the different parts of the thread. The *Limnæus stagnalis* deposits small sacs, containing from fifty to sixty

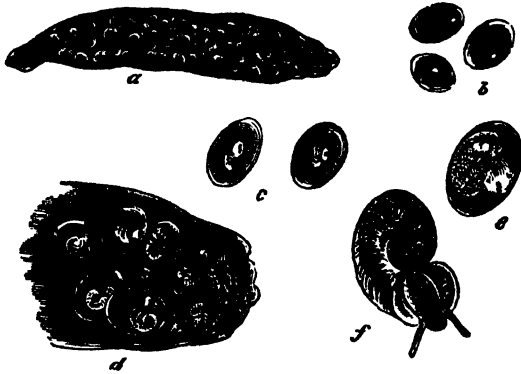

Fig. 252.—*Limnæa stagnalis*.

ova; one of which is represented at *a*, fig. 252. When examined soon after they are deposited, the vesicles appear to be filled with a perfectly clear fluid; at the end of twenty-four hours a very minute yellow spot, the nucleus, or germ, may be seen near the side of the cell-wall. In about forty-eight hours afterwards, this small germ has a smaller central spot rather deeper in colour, which is the nucleolus. On the fourth day the nucleus has changed its position, and is enlarged to double the size: a magnified view is given at *b*; upon viewing it more closely, a transverse fissure or depression is seen; this on the eighth day most distinctly divides the small mass into the shell and soft part of the future animal, *c*. It is then detached from the side of the cell, and moves with a rotatory motion around the cell-interior; the direction of this motion is from the right to the left, and is always increased when the sunlight falls upon it. The increase is gradual up to the sixteenth day, when the spiral axis can now be made out as at *d*; it presents a striking difference in appearance to the soft parts. On the eighteenth day, these changes are more distinctly visible, and the ova crowd down to the mouth of the ova-sac; by using a higher magnifying power, a minute black speck, the future eye, is seen protruded

with the tentacles, at *e*. Upon closely observing it, a fringe of cilia is noticed in motion near the edge of the shell. It is now apparent that the rotatory motion first observed must have been in a great measure due to this; and the current kept up in the fluid contents of the cell by the ciliary fringes. For days after the young animal has escaped from the egg, this ciliary motion is carried on, not alone by the fringe surrounding the mouth, but by cilia entirely surrounding the tentacles themselves,



Fig. 253.—*Limnaea stagnalis*.

which whips up the supply of nourishment, and at the same time the proper aeration of the blood is effected. Whilst in the ova, it probably is by this motion that the cell-contents are converted into tissues and shell. From the twenty-sixth to the twenty-eighth day, it appears actively engaged near the side of the egg, using all its force to break through the cell-wall, which at length it succeeds in doing; leaving the shell in the ova-sac, and immediately attaching itself to the side of the glass-vase, to recommence its ciliary play, and appears in the advanced stage represented at *f*. It is still some months before it grows to the perfect form represented at fig. 253, where the animal is drawn with its sucker-like foot adhering closely to the side of the glass-vase. One of these snails may deposit from two to three of these ova-sacs a week; producing, in the course of six weeks or two months, from 900 to 1,000 young, thus supplying food for fish.

The shell itself is deposited in minute cells, which take up a circular position around the axis; on its under-surface a hyaline membrane is secreted. The integument expands, and at various points an internal colouring-matter or pigment is deposited. The increase of the membrane goes on until the expanded foot is formed, the outer edge of which is rounded off and turned over by condensed tissue in the form of a twisted wire; this encloses a net-work of small vessels filled with a fluid in constant and rapid motion. The course of the blood or fluid, as it passes

from the heart, may be traced through the larger branches to the respiratory organs, consisting of branchial-fringes placed above the mouth; the blood may also be seen returning through other vessels. The heart, a strong muscular apparatus, is *pear-shaped*, and enclosed within a pericardium or enveloping membrane, which is extremely thin and pellucid. Affixed to the sides of the heart are muscular bands of considerable strength, the action of which appears very like the alternate *to-and-fro* motion occasioned by drawing out bands of India-rubber, and which, although so minute, must be analogous to the muscular cords of the mammal heart; it beats or contracts at the rate of about sixty times a minute; and is placed rather far back in the body, towards the axis of the shell. The nervous system is made up of ganglia, or nervous centres, and distributed throughout the various portions of the body.

The singular arrangement of the eye cannot be omitted; it appears at an early stage of life to be within the tentacle, and consequently capable of being retracted into it. In the adult animal, the eye is situated at the base of the tentacle; and although it can be protruded at pleasure for a short distance, it seems to depend much upon the tentacle for protection as a coverlid—it invariably draws down the tentacle over the eye when that organ needs protection. The eye itself is pyriform, somewhat resembling the round figure of the human eye-ball, with its optic-nerve attached. In colour it is very dark, having a central pupillary-opening for the admission of light. The tentacle, which is cylindrical in the young animal, becomes flat and triangular in shape in the adult. The young animal is for some time without teeth; consequently, it does not very early betake itself to a vegetable sustenance: in place of teeth it has two rows of cilia, as before stated, which drop off when the teeth are fully formed. The lingual band bearing the teeth, or the “tongue,” as it is termed, consists of several rows of cutting spines, pointed with silica.

It is a fact of some interest, physiologically, to know that if the young animal is kept in fresh water alone, without vegetable matter of any kind, it retains its cilia, but arrest of development follows, and it acquires no gastric teeth, and never attains perfection in form or size.

If, at the same time, it is confined within a narrow cell, or space, it grows only to such a size as will enable it to move about freely; thus it is made to adapt itself to the necessities of a restricted state of existence. Some young animals in a narrow glass-cell, at the end of six months, were alive and well, and the cilia retained around the tentacles in constant activity; whilst other animals of the same brood and age, placed in a situation favourable to growth, attained their full size, and produced young, which grew in three weeks to the size of their elder relations.

Should any injury occur to the shell, or a portion of it become broken off, the calcareous deposit is quickly resumed, in order to replace the lost part; the cells being apparently only half the size of those originally deposited. This may be thought to afford some proof of the statement made by Sir. Jas. Paget,—“that, as a rule, the reparative power in each perfect species, whether it be higher or lower in the scale, is in an inverse proportion to the amount of change through which it has passed in its development from the embryonic to the perfect state. And the deduction to be made from them is, that the powers for development from the embryo are identical with those exercised for the restoration from injuries; in other words, that the powers are the same by which perfection is first achieved, and by which, when lost, it is recovered. Indeed, it would almost seem as if the species that have the least means of escape or defence from mutilation were those on which the most ample power of repair has been bestowed,—an admirable instance, if it be only generally true, of the beneficence that has prepared for the welfare of even the least of the living world, with as much care as if they were the sole objects of the Divine regard.”

The primordial cell-wall of the cell does not appear to enter into the formative process of the embryo—the cell-contents alone nourishing the vital blastema of the nucleus. A gradual cycle of progressive development once set up, goes on, until the animal is sufficiently matured to break through the cell-wall and escape from the ova-sac. At the same time, it may be inferred, that all this is in some measure aided by the process of endosmose; and that cer-



tain gases or fluids are drawn into the interior, and thus aid in the supply of nourishment for the growth of the animal. The cell-wall appears to bear the same relation to the future perfect animal that the egg-shell of the chick does to it; it is, in fact, but an external covering to a certain amount of gaseous and fluid matter, used for placing the germ of life in a more favourable state for development, assisted, as it is, by an increase of temperature, usually the resultant of a chemical action, set up or once begun in an *organism* and a *medium*. "The ovum destined to become a new creature originates from a cell, enclosing gemmules, from which its tissues are formed, and nutriment is assimilated, and which eventually enables the animal to successively renew its organs, through a series of metamorphoses that give it permanent conditions, not only different, but even directly contrary to those which it had primitively."

*Cephalopoda*.—Molluscous animals without a foot, or a distinct head, and covered with fleshy arms, bearing sucker-like discs. The Cuttles and Squids form the principal groups of this class, only a few species of which are found on our shores. These molluscs are the nearest approach of all invertebrate animals to the vertebrate forms; and their organs of sense appear to be highly developed.<sup>1</sup> Cuttle-fish bone, cut in thin sections, or broken into small fragments, are interesting microscopic objects: the peculiarities of structure are best seen when small pieces are detached with a sharp knife. In the living state these creatures have the power of suddenly changing the colour of their skins.

*Structure of Shell*.—We may exhibit the structure of shell by using an acid solvent in the following manner. If a sufficient quantity of hydrochloric acid, considerably diluted with water (say one part acid to twenty-four of water), be poured upon a shell contained in a glass vessel, it will soon exhibit a soft floating substance, consisting of innumerable membranes, which retain the figure of the shell, and afford a beautiful and popular object for the

(1) In the *Cephalopoda* we have the first indication of a true internal skeleton, in the form of a broad flattened cartilage which protects the central (optic) ganglia of the nervous system.

microscope. In analysing shells of a finer texture than such as are generally submitted to the test of experiment, the greatest circumspection is necessary. So much so, that M. Herissant, whose attention was particularly devoted to the subject, after placing a porcelain shell in spirits of wine, added, from day to day, for the space of two months, a single drop of spirits of nitre, lest the air, generated or let loose by the action of the hydrochloric acid on the earthy substance, should tear the net-work of the fine membranaceous structure. This gradual operation was attended with complete success, and a delicate and beautifully reticulated film, resembling a spider's web in texture, rewarded the patience of the operator; the organization of which film, from its extreme fineness, he was not, however, able to delineate. In shells of peculiar delicacy, even five or six months are sometimes necessary for their complete development; but in others of a coarser texture the process is soon completed. Sections of shells are usually mounted in Canada balsam, or in shallow cells with glycerine.

Mr. George Rainey pointed out the remarkable fact that many of the appearances presented by the shell or hard structures of animals, and which had been usually referred to cell-development, are really produced by the physical laws which govern the aggregation of certain crystallizable salts when exposed to the action of vegetable and animal substances in a state of solution. Mr. Rainey gives a process for obtaining artificially a crystalline substance which closely resembles shell in its chemical structure.

“The chemical substances to be employed in the production of the artificial calculi are, a soluble compound of lime, and carbonate of potash or soda, dissolved in separate portions of water; and some viscid vegetable or animal substance, such as gum or albumen, mixed with each of these solutions. The mechanical conditions required to act in conjunction with the chemical means are, the presence of such a quantity of the viscid material in each solution as will be sufficient to make the two solutions, when mixed together, of about the same density as that of the nascent carbonate of lime, and a state of perfect rest of the fluid in which the decomposition is going on, so that the newly-formed compound may be interfered with

as little as possible in its subsidence to the sides and bottom of the vessel. This will require two or three weeks, or longer, according to the size and completeness of the calculi. But I have not found that they increase at all after six weeks."

Mr. Rainey shows<sup>1</sup> the analogy or identity of his artificially formed crystals with those found in natural products both in animals and vegetables, chiefly confining himself to the structure and formation of shells and bone, pigmental and other cells, and the structure and development of the crystalline lenses, which he contends are all formed upon precisely the same physical principles as the artificial crystals. Take, for instance, the calculi found in the body: these cannot be distinguished from the crystals of artificially formed carbonate of lime. Again, the shell of the crustaceans; the resemblance between these and the artificial products is, in some respects, more complete than in that of calculi. All the appearances in shells can be best observed by merely cleaning them in water, and examining them in glycerine, grinding being unnecessary and injurious. Polarised light is indispensable; as in the young hermit-crab, at the part where the calcareous and membranous portions of the shell are continuous, the circular forms of globular carbonate are so delicate that no evidence whatever of its presence can be detected under powerful lenses, and with the best illumination, until polarised light is brought to bear upon the specimen. To obtain the most satisfactory results in the investigation of the process of calcification of animal tissues, it is indispensably necessary that the parts examined should be in the earliest stages of the process, and before the calcifying membrane is entirely covered with the globular coalescing deposit. The usual plan of examining shells in thin vertical sections is entirely useless, unless it be simply to see the number and arrangement of their layers; the part of the section in such specimens, in which the calcifying process ought to be best seen, being entirely ground off. This part, being the softest, can only be preserved in the process of grinding by extreme care, and by keep-

(1) G. Rainey, "*On the Mode of Formation of Shells, Bones, &c. by a process of Molecular Coalescence.*" 1858.

ing the lower edge of the section always thicker than the upper.

Dr. Carpenter describes the shell of the Crab and Lobster as being composed of three layers, viz. the epidermis or cuticle, the rete-mucosum or pigment, and the corium. The epidermis is of a horny nature, being generally more or less brown in colour, and under the highest magnifying powers presenting no trace of structure (fig. 247, No. 2); it invests all the outer parts of the shell, and has in many instances large cylindrical or feather-like hairs developed from certain portions of its surface. The rete-mucosum, or pigment cells, consist of either a series of hexagonal cells, forming a distinct stratum, or of pigmental matter diffused throughout a certain thickness of the calcareous layer. (Fig. 247, No. 5.) In the Crab and Lobster it is very thin, but in the Crayfish it occupies in some parts more than one-third of the entire thickness of the shell; when examined by the microscope, this portion appears to be composed of a large number of very thin laminae, which are indicated by fine lines taking the same direction on the surface of the shell, the number of lines being the greatest in the oldest specimens; these layers, even in the Crayfish, are covered by a thin stratum of very minute hexagonal cells, without any trace of cell matter in their interior. The corium is the thickest layer of the three, being the one on which the strength of the shell depends, in consequence of the calcareous material deposited in it. (Fig. 247, No. 4.) When a vertical section of the shell of the Crab is examined, it is found to be traversed by parallel tubes, resembling those in the *dentine* of the human tooth; these tubes extend from the inner to the outer surface of the shell, and are occasionally covered by wavy lines, probably those of growth, shown in a portion of No. 3, fig. 247. If a horizontal section of the same shell be made, so that the tubes be divided at right angles to their length, the surface will clearly exhibit their open ends, surrounded by calcareous matter. In Shrimps and very small Crabs, the deposition of the calcareous matter takes place in concentric rings like those of agate; and occasionally small centres of ossification, somewhat like *Pinna*, with radiating striae, are met with in the Shrimp. If the calcareous

portion of the shell be steeped in hydrochloric acid, a distinct animal structure or basis is left behind, and the characters of the part will be very accurately preserved. The calcareous matter, like that of bone, generally presents a more or less granular appearance, as at No. 4, and so angular in figure as to resemble certain forms of rhomboidal crystals: No. 2 is a section from the outer brown shell of the Oyster. The beauty of all such structures is much increased if viewed with polarised light on the selenite stage.<sup>1</sup>

*Crustacea*.—The skeletons of *Crustacea* are external to the soft parts; in a great number of species the shell is thin and membranous, in others it is of a horny material, thickened with calcareous matter, having a distinct series of pigment cells of a stellate figure, all supplying beautiful objects for microscopic examination and polarised light. The *Astacus*, Crayfish, may be taken as the type of that large and important group of *Crustacea* to which the term *Podophthalma*, Stalk-eyed, is applied.<sup>2</sup>

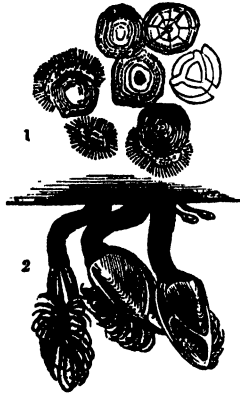

Fig. 254.

1, Young fry of the Oyster, a portion of them with cilia protruded 2, Body and cirri of Barnacles.

*Cirrhopoda* or *Cirripedia*, when mature, attach themselves to rocks and other objects. The Barnacle (fig. 254) and Acorn-shell are the best known examples of this order; they generally select floating objects to dwell upon; and bottoms of ships have been covered by them to such an extent as even to impede their progress through the water. The soft bodies of these animals are enclosed in a case composed of five calcareous plates; from this circumstance they were grouped with the *multivalve shells* of the older concholo-

(1) See Prof. Huxley's article on the "Tegumentary Organs," *Cyclop. Anat. and Physio.* vol. v. p. 487.

(2) Some valuable information will be found on the minute structure of shells in Prof. Williamson's paper, "On some Histological Features in the Shells of the Crustacea," *Journ. Micros. Scien.* vol. viii. p. 35, 1860.

**gists.** Their limbs are converted into tufts of jointed cirri, and protrude through an opening in the mantle which lines the interior of the shell. The cirri, twelve in number, are covered with cilia, which, when the animal is alive, are in continual motion. The intestinal canal is complete, and the nervous system exhibits the usual series of ganglia, characteristic of the articulate type. The head is marked only by the position of the mouth, and is armed with a pair of jaws, if we may so term the shells.

*Balanidæ*, "Sea-acorns," a sessile species, whose curious little habitations may constantly be met with upon the rocks of the sea-shore, and not unfrequently upon many species of marine shells. The shell forms a short tube, and is usually composed of six segments securely united together. The lower part of the tube is firmly fixed to the object on which the *Balanus* has taken up its abode; whilst the superior orifice is closed by a movable roof, composed of from two to four valves, between which the little tenant of this curious domicile protrudes his delicate cirri in search of nourishment. In the young state the *Balanidæ* freely swim about, and somewhat resemble the following group, *Entomostraca*.

*Entomostraca*, or Water-fleas, undergo a series of remarkable changes from the moment of their escape from the egg to the attainment of their fully matured form. And it is of the highest interest to remark that, in obedience to a law which, if not universal, is at any rate widely prevalent in the animal kingdom, these temporary or larval forms are themselves closely analogous to the *perfect* forms of groups still lower in the scale of existence, so that many of them in their early forms were formerly, before their life-history was known, either classed as distinct species, or placed in a position very far from that which they are now seen to occupy. The embryo of the Shore-crab (*Carcinus maenas*) before, and for a short time after, its liberation from the ovum, presents both in size and general outline a strong resemblance to *Entomostraca*. In this transition stage it was assigned to a distinct genus under the name of *Zoea*; and having undergone a still further transformation was called *Megalopa*. In this latter stage it

puts on somewhat the appearance of the Lobster crab (*Galathea*), and after another step attains its true crab form, being the highest development of which it is capable. These changes are not produced gradually, but by a succession of "moult," the animal becoming at times sluggish, casting its hard covering, and reappearing in a new guise. The after growth of a crustacean is carried on by the system of moulting; the hard calcareous case of the animal preventing its growth in any other mode. And as in the higher orders of Crustacea, so also amongst the *Entomostraca*, transformations of this kind constantly take place. *Cyclops quadricornis*, when first born, is totally unlike its parents, being of an ovoid shape, having only two short antennæ and two pairs of feet; in three moults the animal reaches its perfect form, with its two pairs of antennæ, five pairs of feet, and body divided into several distinct rings or segments.

The animals comprising the order *Ostracoda* are generally

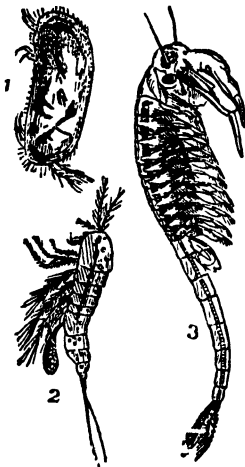

Fig. 255.

1, *Cypris*. 2, *Polyphemus*, *Cyclops*.  
3, *Branchiopus stagnalis*.

a shell, of which the genus *Cypris* (fig. 255) is an example :

of very minute size; the body, which strongly resembles that of the *Copepoda*, is always enclosed in a little bivalve shell, the feet and antennæ being protruded between the lower edges of the valves. These little shells so closely resemble those of minute bivalve *Mollusca*, that those of some of the larger species have actually been described by conchologists as the covering of animals belonging to that class. The antennæ are often curiously branched; and the hinder extremity is usually prolonged into a sort of tail, which is seen in constant action when the animal is in motion. In *Cypridina*, the body is entirely enclosed by

and in *Daphnia*, "Water-fleas," the head is protruded beyond the shell. In *Polyphemidæ* the head is large, and almost entirely occupied by an enormous eye, giving the creatures a most singular appearance; the *Monoculus* is a well-known example of this group. Another family, not provided with a shell or carapace, called *Branchiopoda*, from the name of the typical genus, *Branchiopus stagnalis* (fig. 255), is often found after heavy rains in cart-ruts and other small pools.

*Daphnia pulex* is found commonly in fresh water, and is scarcely inferior to its marine relative, *Talitrus locusta*, in agility. The *Corophium longicorne*, remarkable for its long antennæ, is not less so for its singular habits. It is found at Rochelle, where it burrows in the sand, and wages constant war with all other marine creatures of moderate size that come in its way.

Dr. Baird has followed up the successive generations in *Daphnia pulex*; so far as the *fourth* change in the *Daphnia* born from the ordinary ova, and so far as the *third* in those born from the ephippial eggs. These ephippia, or "winter eggs," require a few words of explanation. They are, in fact, eggs covered with envelopes of more than usual hardness and thickness, being enabled to withstand an excess of cold, which would surely prove fatal to the parent. This observer found, upon examining ponds which had been filled up again by the rain after remaining two months dry, numerous specimens of the *Cyclops quadricornis* in all stages of growth. Dr. Baird, in his "Natural History of British Entomostraca," 1850, tells us that they have many enemies.

"The larva of the *Corethra plumicornis*, known to microscopical observers as the *skeleton larva*, is exceedingly rapacious of the *Daphnia*. Pritchard tells us they are the choice food of a species of *Nais*; and Dr. Parnell states that the Lochlevin trout owes its superior sweetness and richness of flavour to its food, which consists of small shell-fish and Entomostraca." These animals abound both in fresh and salt water. *Artemiæ* are formed exclusively in salt water, in salt marshes, and in water highly charged with salt. "Myriads of these Entomostraca are to be found in the salterns at Lymington, in the open tanks or reservoirs where the brine



is deposited previous to boiling. A pint of the fluid contains about a quarter of a pound of salt, and this concentrated solution destroys most other marine animals." During the fine days in summer *Artemiæ* may be observed in immense numbers near the surface of the water, and, as they are frequently of a lively red colour, the water appears tinged with the same hue.<sup>1</sup> There is nothing more elegant than the form of this little animal. Its movements are peculiar. It swims almost always on its back, and by means of its tail it runs in all directions, its feet being in constant motion. They are both oviparous and ovoviviparous, according to the season of the year. At certain periods they only lay eggs, while during the hot summer months they produce their young alive. In about fifteen days the eggs are expelled in numbers varying from 50 to 150. As is the case with many of the Entomostraca, the young present a very different appearance from the adult animals; and they are so exactly like the young of *Chirocephalus*, that with difficulty they can be distinguished the one from the other. The ova of other species are furnished with thick capsules, and imbedded in a dark opaque substance, presenting a minutely cellular appearance, and occupying the interspace between the body of the animal and the back of the shell. This is called the ephippium.<sup>2</sup> The shell is often beautifully transparent, sometimes spotted with pigment: it consists of a substance known as chitine, impregnated with a variable amount of carbonate of lime, which produces a copious effervescence on the addition of a small quantity of acid, and when boiled it turns red, like the lobster. Their shells vary in structure. Sometimes they consist of two valves united at the back, and resembling

(1) It is a curious fact that salt-water when highly concentrated frequently assumes a red colour, and that this should have been attributed to the presence of the *Artemia salina*, as in the case of fresh-water noticed elsewhere found coloured red by a species of *Paramœcium*. The cause of this red colour, which was well known to take place in the salt marshes and reservoirs of salt-water at Montpellier, was made the subject of a very grave discussion in France. Some maintained that the colour was caused by the presence of *Artemiæ*, while others declared that it arose from vegetable matter, either *Hematococcus* or *Protooccus*. M. Joly, came to the conclusion, after many careful examinations, that the red colour depends upon the presence of myriads of monads, and that the *Artemiæ* living upon these partook of the same red hue, and thus the water appeared to be of the same colour.

(2) See paper on "Reproduction in *Daphnia*," by Sir John Lubbock, *Philos. Trans.* 1857, p. 79.

the bivalve shell of a mussel ; others are simply folded at the back, so as to appear like a bivalve, but are really not so ; or they consist of a number of rings or segments. The body of the Cypris presents a reticulated appearance, resembling that of cell structure. All the Entomostraca are best preserved in a solution of chloride of calcium.

**ANNULOSA.**—*Articulata*. The animals composing the sub-kingdom *Articulata* are characterised by having the body enclosed in a tunic, or integument, consisting of a series of rings, segments, or joints, “articulated” together by a flexible membrane.

The *Annulosa* are divided, by Professor Huxley, into two principal groups, the *Arthropoda* and the *Annuloida*. The *Arthropoda*, comprising *Insecta*, *Myriapoda*, *Crustacea*, and *Arachnida*, possess a definitely segmented body ; the segments being provided with appendages, the anterior of which are so modified as to subserve the functions of sensation and manducation. They have almost always a heart, communicating with the general cavity of the body, for propelling the true corpusculated blood which that cavity contains. The nervous system consists of a longer or a shorter chain of ganglia.

Nothing can be more variable than the characters of the body, the appendages, and the nervous system among the rest of the *Annulosa*, which are included under the *Annuloida* ; nevertheless, there are two features in which they all agree ; firstly, they possess a remarkable system of vessels, either ciliated, or deprived of cilia, and containing a fluid very different from the true blood which fills the general cavity of the body or perivisceral space ; secondly, in no annuloid animal has any true heart been hitherto discovered. Contractile vessels belonging to the system just referred to abound, but no organ comparable in structure to the heart of other animals has yet been found in any of the *Annuloida*.

The *Annuloida*, as thus defined and limited, fall into two parallel series ; in one of which, for the most part, dicecious forms predominate, as the *Annelida*, while of the latter, the *Trematoda* may be regarded as the typical example ; on the other hand, the *Echinodermata* and

*Rotifera*, the *Taniadæ* and the *Nematoidea*, may be considered as the most aberrant groups of their respective series.

Under the head *Annelida*, Mr. Huxley includes the errant and tubicular Annelids of Cuvier, and the *Gephyrea* of De Quatrefages; he thinks that the *Terricola*—the Earthworms and Naidæ—should be separated from the *Scoledæ* of Milne Edwards, and brought into the same group. So far as external structure is concerned, the genus *Polynœ* is, perhaps, the best fitted to serve as the type to which other *Annelida* may be referred: the commonest form of the genus being the *P. squamata*.<sup>1</sup> The best developed branchiæ among the Annelids are possessed by the *Amphinomidæ*, the *Ennicidæ*, the *Terebellidæ*, and the *Serpulidæ*. The branchiæ in the three former families are ciliated, branched plumes or tufts attached to the dorsal surface of more or fewer of the segments. In the last they are exclusively attached to the anterior segments of the body, and present the form of two large plumes, each consisting of a principal stem, with many lateral branches; this stem is itself supported on a kind of cartilaginous skeleton.

The teeth in a great number of the *Annelida* are very curious and distinctive. In the *Polynœ* there are four, planted in the muscular wall of the proboscis. In the *Nereis* there are two powerful teeth working horizontally, besides minute accessory denticles. In *Syllis* there is a circle of sharp teeth, surrounding a triangular median tooth. In *Glycera* there are a pair of teeth; but the most complex arrangement of teeth is that presented by the *Ennicidæ*. The tubicular Annelids possess neither proboscis nor teeth.

Many Annelids pass through a larval condition, in which the body exhibits mere indications of segments, and the appendages are entirely absent; locomotive function being performed by a circlet of cilia, disposed around the anterior part of the body. There is a large group of very remarkable organisms, observes Mr. Huxley, the minute "wheel animalcules," *Rotifera*, whose whole

(1) Consult a valuable paper on this genus in Müller's Archiv. 1857. Also Huxley's "Elements of Comparative Anatomy."

organization demonstrates, not merely their annulose nature, but their position among the *Annuloidea*, and which exhibit precisely the same indistinct segmentation, the same general absence of appendages, and whose means of locomotion are in like manner confined to one or two ciliated circllets at the anterior part of the body. The connexion between the *Annelidu* and the *Rotifera* is further illustrated by such remarkable forms as the *Polyophthalmus* of De Quatrefages, a true Annelid, which, nevertheless, possesses on each side of the head a ciliated lobe, capable of being voluntarily protruded and retracted, and presenting a close resemblance to the trochal disc of a Rotifer. *Hydatina senta* has been so well and accurately described by Dr. Cohn,<sup>1</sup> and others, that it may be taken as the typical form of the *Rotifera*. The trochal disc in the species, undergoes great changes of form. In *Hydatina*, it is circular, and its margin is skirted by two distinct continuous bands of cilia, the one immediately in front of, the other behind the mouth. In *Brachionus* the ciliated circllet fringing the edges of the trochal disc is horseshoe-shaped, but the circllet is produced into three lobes or processes, which stand out perpendicularly to the surface of the trochal disc. In *Stephanoceros* it fringes the edges of a number of tentaculiform processes, into which the trochal disc is produced, so as to give the whole animal somewhat the appearance of a Polyzoon.

The *Turbellaria*, a group of serpent-like worms, for the most part the inhabitants of fresh and salt waters, a few only being found in damp situations on land, are characterised by the ciliation of the entire surface of the body. In their internal organisation they approximate in many respects to the *Trematoda*, while in others they exhibit a certain affinity with the other great group of parasitic *Annuloidea*, the *Nematoidea*. *Polycelis lævigatus*, one of the *Dendrocela* so well described by De Quatrefages in his Monograph on the Marine *Planariæ*, may be most advantageously selected as a type of the group. The *Nemertidæ* have engaged the attention of the same learned authority, the ova of which undergo a remarkable kind of

(1) *Ueber die Fortfawung der Raderthiere*, Von Dr. F. Cohn, in Breslau, 1855.

metamorphosis. The embryo has at first a ciliated non-contractile, oval body, exhibiting no structure but a semilunar superficial cleft, provided with raised edges. After a time, a small actively-contractile, vermiform creature, resembling the parent, escapes from the interior of the larval form, which it leaves behind like a cast skin. The semilunar cleft becomes the mouth of the imago, and is only part of the larva carried away. The *Gordiacei*<sup>1</sup> best enable us to connect the *Turbellaria* with the very puzzling group *Nematoidea*, and the structure of several species belonging to the two genera which compose the group *Mermis* and *Gordius*, have recently been made the subject of two elaborate monographs by Meissner.<sup>2</sup>

The *Gordiacei* are excessively elongated, thread-like worms, plentiful enough in Thames mud, and, as Von Siebold discovered, partake both of the free habit of the *Nemertidæ*, and of the parasitic nature of the *Nematoidea*. The young *Mermis*, for instance, is parasitic upon insects, inhabiting the perivisceral cavity of the larva or of the imago.

The *Nemertidæ* seem to differ from their close allies the *Turbellaria*, in possessing a vascular system distinct from and added to the water-vessels. In the *Hirudinidæ*, Leeches and Earthworms, a system of vessels homologous with the pseud-hæmal system exists, and, in addition a series of more or less coiled tubules lie in the perivisceral cavity, and open, by pores, on the ventral surface of the body. These organs have been regarded sometimes as secretory, sometimes as respiratory apparatus; but all that we know about them in reality is that they are tubular, and are more or less richly ciliated within, and that, in some cases (*Nais*, *Lumbricus*), they present at their internal extremities a ciliated aperture, whereby they freely communicate with the perivisceral cavity.

There remains, however, yet another system of vessels in the *Annuloida*—the ambulacral vessels of the *Echino-dermata*. These are frequently termed "water-vessels," and, indeed, if we regard the structure with reference to

(1) Huxley, *General Natural History*.

(2) *Beitrag zur Anatomie und Physiologie von Mermis Albicans*, v. *Zeitschrift für Wiss., Zoologie*, Bd. v. 1854; and *Beitrag zur Anat. & Physiol. des Gordiacen*, *Ibid.* Bd. viii 1855.

their peculiar functions, they singularly resemble true water-vessels; they open by an external pore, and are ciliated internally; they unite around the gullet, as do the water-vessels in some *Trematoda*, and are eventually shut off from such communication; the ambulacral vessels of the *Holothuridæ* undergo precisely this change, and thus they facilitate our comprehension of a transition from the water-vessels of the *Trematoda* to the pseud-hæmal vessels of the *Annelida*. We may take it as an established fact that, whatever the functions of this varied vascular system and its contents in different classes of the *Annuloida*, they have nothing to do with the blood or true blood vessels. The latter are entirely absent in all the *Annuloida* at present known, the blood (improperly called "chyle-aqueous fluid") being simply contained in the perivisceral cavity and its processes. The development of the *Nematoidea* appears to take place without metamorphosis; the embryo assuming within the egg a form nearly resembling that of the adult. Encysted asexual nematoid worms are frequently found in various parts of the body of fishes; and the remarkable *Trichina spiralis* is the asexual state of a nematoid worm, encysted within the substance of the muscles of man. Zooid development is only known to occur in one nematoid, the *Filaria Medinensis*, Guinea-worm. Mr. Busk's careful observations have long since placed this fact beyond a doubt.

The *Tæniadæ* and the *Acanthocephala*, like the *Trematoda*, entirely parasitic in their habits, differ from them in the total absence of mouth or digestive cavity. The *Tæniadæ*, Tapeworms, are ribbon-like creatures, usually divided throughout the greater part of their length into segments, whose usual habitation is the intestinal cavity of vertebrate animals; and apparently of a carnivorous vertebrate, in fact, though capable of existence elsewhere, it is there alone that they are able to attain their complete development. The anterior extremity of a tæmoid worm is usually called the head, and bears the organ by which the animal attaches itself to the mucous membrane of the creature which it infests. These organs are either suckers or hooks, or both conjoined. In *Tænia*, four suckers are combined with a circlet of hooks, disposed around a median

terminal prominence. The embryo passes through a similar course of development to the *Trematoda*; viz. four forms or changes: but the embryo itself is very peculiar, consisting of an oval non-ciliated mass, provided upon one face with six hooks, three upon each side of the middle line. The *Tæniadæ* are found in many other situations besides the alimentary canal: the eye, the brain, the muscular tissues, the liver, &c.; the following cystic worms are included in this genera, *Cysticercus Anthocephalus*, *Cœnurus*, and *T. Echinococcus*. Plate IV. No. 100, this figure shows an entire and full-grown *Tænia* with rostellum and suckers, and then three succeeding segments, the last of which contains the ova, &c. The water-vascular system is represented coloured with carmine. This parasite infests the human body more frequently than other varieties. This accurately-drawn figure is copied from Cobbold.

Von Siebold, Leuckart, and others, have shown, by many interesting experiments, such as feeding puppies with *Cysticercus pisiformis*, that in the course of a few weeks these *entozoa* are transformed into fully formed *Tænia serrata*, again, rabbits fed with the embryo of the *Tænia*, the embryo bore their way, by means of hooks, through the walls of the intestine, until they reach some blood-vessel: by the current of blood they are carried into the liver, and here Leuckart has traced their further development. The embryos grow to the 1-16th of an inch in length, and become elongated, so as almost to resemble an *Ascarid* in form; they then make their way to the surface of the liver, and pass out into the peritoneal cavity.

In like manner, *Cysticercus fasciolaris* is rapidly developed within the liver of white mice; *Cysticercus cellulosa* seen in the muscles of the pig fed with the *Tænia solium*, produces the diseased state of pork familiarly known as "*measly pork*." If a lamb is the subject of the feeding experiment with *Tænia serrata*, the final transformation will be very different; within a fortnight, symptoms of a disease known as "*staggers*" are manifested, and in the course of a few weeks, the *Cœnurus cerebralis* will be found transformed and developed within the brain. Von Siebold pointed out the bearing of this fact upon the important

practical problem of the prevention of "staggers." Others of the same family of parasites are quite as remarkable, in giving a preference to the alimentary canal of fishes. The *Echinorhynchus* is developed in the canal of the Flounder, *Triænochorus nodulus* in the liver of the Salmon, attaining a more perfect development in the alimentary canal of the Perch and Pike. Another, found in the Stickleback, becomes changed in the intestines of water birds, which devour these fish; and thus, by careful and repeated observations with the microscope, the connexion existing between the Cystic and Cestoid Entozoa have been most satisfactorily established.

The *Fluke* belongs to the order *Trematoda*, which signifies that they are internal parasites, suctorial worms, or helminths; they are all usually visible to the naked eye, although a few of the smallest scarcely exceed 1-100th of an inch in length; many are larger, and the species best known, *Fasciola hepatica*, attains to an inch or more in length. The *Fluke* shown in Plate IV. No. 103, is cone-shaped: it is the *Amphistome conicum* of Rudolphi. This parasite is common in oxen, sheep, and deer, and it has also been found in the Dorcas antelope. It almost invariably takes up its abode in the first stomach, or rumen, attaching itself to the walls of the interior.<sup>1</sup> In the full-grown state it never exceeds half an inch in length; in our plate it is represented magnified. On closer inspection it will be seen that the animal is furnished with two pores or suckers, one at either extremity of the body, the lower being by far the larger of the two. By means of the latter the Amphistome anchors itself to the papillated folds of the paunch, or first stomach, as this organ is improperly called.

In the figure the oral sucker at the anterior end, or head, leads into a narrow tube, forming the throat or cesophagus, and this speedily divides, or rather widens out, into a pair of capacious canals. These cavities are correctly regarded

(1) The larval condition of *Amphistoma* in all probability lives in or upon the body of snails. This we infer from the circumstance that the larvæ, *cercariæ*, of a closely allied species, the *Amphistoma subclavatum*, which is known to infest the alimentary canal of frogs and newts, have been also found on the surface of the body of the *Planorbis* by ourselves, whilst Van Beneden discovered the larvæ in a species of *Cyclas*. The *cercariæ*, larvæ, are taken, it is supposed, by the cattle while drinking. They then attach themselves to the walls of the stomach, where they soon complete their further stages of development.





formed digestive apparatus is accurately represented in Plate IV. Nos. 106 and 107, *Fasciola gigantea* of Cobbold, which should be contrasted with the somewhat similarly racemose character of the water-vascular system. Let it be expressly noted, however, that in the digestive system the majority of the tubes branch out in a direction obliquely downwards, whereas those of the vascular system slope obliquely upwards. A further comparison of the disposition of these two systems of structure, with the same systems figured and described as characteristic of the Amphistome, will at once serve to demonstrate the important differences which subsist between the several members of the two genera, if we turn to the consideration of the habits of *Fasciola hepatica*, which, in so far as they relate to the excitation of the liver disease in sheep, acquire the highest practical importance. Intelligent cattle-breeders, agriculturists, and veterinarians have all along observed that the *rot*, as this disease is commonly called, is particularly prevalent after long-continued wet weather, and more especially so if there have been a succession of wet seasons; and from this circumstance they have very naturally inferred that the humidity of the atmosphere, coupled with a moist condition of the soil, forms the sole cause of the malady. Coordinating with these facts, it has likewise been noticed that the flocks grazing in low pastures and marshy districts are much more liable to the invasion of this endemic disease than are those pasturing on higher and drier grounds; a noteworthy exception occurring in the case of those flocks feeding in the salt-water marshes of our eastern shores." <sup>1</sup> Plate IV. No. 106, *Fasciola gigantea*: the anterior surface is exposed to display oral and ventral suckers, and the lendriform digestive apparatus injected with ultramarine; No. 107, shows the dorsal aspect of the specimen and the multiracemose character of the water-vascular system, the vessels injected with vermilion.

One of the most remarkable of the *Trematode helminths* is *Bilharzia hæmatobra* of Cobbold; *Distomia hæmatobium* of some other authors. Plate IV. No. 102. This genus

(1) *Entozoa: An Introduction to the Study of Helminthology.* By T. Spencer Cobbold, M.D. F.R.S. 1896. P. 148.

of fluke, discovered by Dr. Bilharz in the human portal system of blood vessels, gives rise to a very serious state of disease among the people of Egypt. So common is the occurrence of this worm, that this physician expressed his belief that half the grown-up people are infested with it. Griesinger conjectures that the young of the parasite exists in the waters of the Nile, and in the fishes which abound therein. Dr. Cobbold thinks "it more probable that the larvæ, in the form of cercariæ, rediæ, and sporocysts, will be found in certain gasteropod mollusca proper to the locality." The anatomy of this fluke is fully described in Kuchenmeister's able work on Parasites, by Leuckart, and by Cobbold. The eggs and embryos of *Bilharzia* are peculiar in possessing the power of altering their forms in both stages of life; and it is more than probable that the embryo form has been mistaken for some extraordinary form of ciliated infusorial animalcule, their movements being most quick and lively. We cannot fail to notice the curious leech-like form of the male animal, and, remarkable enough, he is generally found carrying the female about. The whip-like appendage seen in the figure is a portion of the body of the female. The disease produced by them is said to be more virulent in the summer months, which is probably owing to the prevalence of the cercarian larvæ at the spring time of the year.

*Trichina spiralis*.—This, the smallest of the helminths, measures only the 1-20th of an inch. The female is a little larger; it was discovered by Professor Owen in a portion of the human muscle sent to him from St. Bartholemew's Hospital, 1834. The young animal presents the form of a spirally-coiled worm in the interior of a minute oval-shaped cyst (Plate IV. No. 104), a very small speck scarcely visible to the naked eye. In the muscle it resembles a little particle of millet seed, more or less calcareous in its composition. The history of the development of *Trichinæ* in the human muscle is briefly that in a few hours after the ingestion of diseased flesh, *Trichinæ*, disengaged from the muscle, are found free in the stomach: they pass thence into the duodenum, and afterwards advance still further into the small intestine, where they become developed. From the third or fourth day, ova or

spermatic cells are found. the sexes in the mean while becoming distinctly marked. Shortly afterwards the ova are impregnated, and young living entozoa are developed within the bodies of the female. The young have been noticed (by Virchow) under the form of minute *Filariae*, more especially in the serous cavities, in the mesenteric glands, &c. Continuing their migrations, they penetrate as far as the interior of the primitive muscular fasciculi, where they may be found as early even as three days after ingestion, in considerable numbers, and so far developed that the young entozoa have almost attained a size equal to that of the full-grown *Trichinæ*. They progressively advance into the interior of the muscular fasciculi, where they are often seen several in a file one after the other. Behind them the muscular tissue becomes atrophied, and around them an irritation is set up, and from the commencement of the third week they are found encysted. The sarcolemma is now thickened, and the contents of the muscular fibres exhibit indications of a more active cell-growth; the cyst is the product of a sort of inflammatory irritation.

Professor Virchow draws the following conclusions:—  
“1. The ingestion of pig’s-flesh, fresh or badly dressed, containing *Trichinæ*, is attended with the greatest danger, and may prove the proximate cause of death. 2. The *Trichinæ* maintain their living properties in decomposed flesh; they resist immersion in water for weeks together, and when encysted may, without injury to their vitality, be plunged in a sufficiently dilute solution of chromic acid for at least ten days. 3. On the contrary, they perish and are deprived of all noxious influence in ham which has been well smoked, kept a sufficient length of time, and then well boiled before it is consumed.”

The *Echinococcus* found in cysts, chiefly in the human liver, is represented in Plate IV. No. 101. A large collection was taken from the liver of a boy who died in Charing-cross Hospital from accidental rupture of the liver. The cysts containing these parasites are always situated in cavities in the interior of the body. These cavities may be situated in any part of the tissues or organs of the body, but are more frequently found in the solid

viscera, and especially in diseased livers. Fig. 256 represents the microscopical appearance of the contents of a cyst.

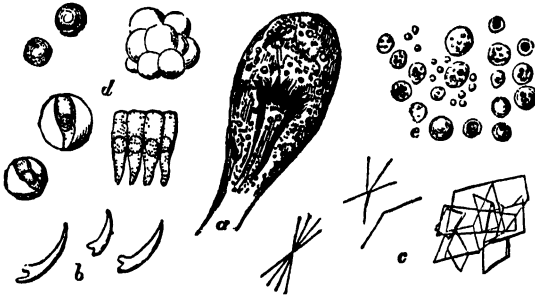

Fig. 256.—*Cystic Disease of Liver.* (Human).

*a*, Cyst with an *echinococcus* enclosed. *b*, Detached hooklets from the head of *Echinococcus*, magnified 250 diameters. *c*, Crystals found in the cyst, *cholesterine*. *d*, Cylindrical epithelium, some enclosed in structureless globules. *e*, *Puro-mucus*, and fat corpuscles.

Mr. Busk, who has examined several of these cysts, says:—"When a large hydatid cyst,—for instance, in the liver of the sheep,—very shortly after the death of the animal, is carefully opened by a very small puncture, so as to prevent at first the too rapid exit of the fluid, and consequent collapse of the sac, its internal surface will be found covered with minute granulations resembling grains of sand. These bodies are not equally distributed over the cyst, but are more thickly situated in some parts than in others. They are detached with the greatest facility, and on the slightest motion of the cyst, and are rarely found adherent after a few days' delay. When detached, they subside rapidly in the fluid, and consequently will then be usually found collected in the lowest part of the cyst, and frequently entangled in fragments of the inner thin membrane. When some of these granulations are placed between glass under the microscope, and viewed with a power of 250 diameters, upon pressure being employed it will be seen, after rupture of the delicate enveloping membrane, that the *Echinococci* composing the granulations are all attached to a common central mass by short pedicles; which, as well as the central mass, appear to be composed of a substance more coarsely granular by

far than that of which the laminae of the cyst are formed. This granular matter is prolonged beyond the mass of *Echinococci* into a short pedicle, common to the whole, and by which the granulation is attached to the interior of the hydatid cyst, as represented in No. 101. In specimens preserved in spirits, *Echinococci* of all imaginable forms and appearances are to be met with,—differences owing to decomposition or to mechanical injury; and in many cases no traces of them can be found except the hooklets or spines, which, like the fossil remains of animals in geology, remain as certain indications of their source, and not unfrequently afford the only proof we can obtain of the true nature of the hydatid."<sup>1</sup>

The *Echinorhynchi*, or *Acanthocephali*, constitute a group of entozoa, with respect to whose development and life-history we are indebted to Prof. Leuckart of Giessen. Most observers, and in particular Von Beneden and G. Wagner, have been disposed to assign to the *Echinorhynchi* a simple metamorphosis, hardly perhaps more remarkable than that which has been shown to take place in some other of the Nematode worms. The latter observer goes so far even as to believe that the organization of the perfect animal may be discerned in the embryo. Leuckart instituted, in 1861, a series of experiments with the ova of *Echinorhynchus Proteus*, which is found parasitic upon the *Gammarus Pulex*. The ova "of *E. Proteus* resemble in form and structure those of the allied species. They are of a fusiform shape, surrounded with two membranes, an *external*, of a more albuminous nature, and an *internal*, chitinous one. When the eggs have reached the intestine, the outer of these membranes is lost, being in fact digested; whilst the inner envelope remains until ruptured by the embryo."<sup>2</sup>

*Anguillulæ* are very small eel-like worms, of which one species,<sup>3</sup> *Anguillula fluviatilis*, is found in rain-water amongst *Confervæ* and *Desmidiaceæ*, in wet moss and moist earth, and sometimes in the alimentary canal of the

(1) *Microscopical Society's Transactions*. 1st Series.

(2) Prof. Leuckart "On *Echinorhynchus*." *Journ. Micro. Soc.* vol. iii. p. 57. 1863.

(3) For the fullest information of marine, land, and fresh-water species, consult Dr. Bastian's "Monograph on the Anguillulidæ." *Lin. Soc. Trans.* vol. xxv. p. 75. The "*Anguillula Aceti*."—*Popular Science Review*, January, 1863.

*Limneus*, the frog, fish, &c.; another species is met with in the ears of wheat affected with a blight termed the "cockle;" another, the *A. glutinis*, is found in sour paste; and another, *A. aceti*, in stale, bad vinegar. If grains of the affected wheat are soaked in water for an hour or two before they are cut open, the eels will be seen in a state of activity when placed under the microscope. The paste-eel makes its appearance spontaneously in the midst of paste that is turning sour; but the best means of securing a supply for any occasion, consists in allowing any portion of a mass of paste in which they show themselves, to dry up, and then lay it by for stock; if at any time a portion of this is introduced into a little fresh made paste, and the whole kept warm and moist for a few days, it will be found to swarm with these curious little worms. A small portion of paste spread over one face of a Coddington lens is a ready way of showing them.

*Planariæ*: a genus of the order *Turbellaria*. Some of the species are very common in pools, and resemble minute leeches; their motion is continuous and gliding, and they are always found crawling over the surfaces of aquatic plants and animals, both in fresh and salt water. The body has the flattened sole-like shape of the *Trematode Entozoa*; the mouth is surrounded by a circular sucker, this is applied to the surface of the plant from which the animal draws its nourishment. The mouth is also furnished with a long funnel-shaped proboscis, and this, even when detached from the body, continues to swallow anything presented to it.

"In imitation of the name bestowed on the trunk of the elephant, the extensile organ serving to imbibe the nutriment of many of the smaller animals is called a proboscis, whether it simply unfolds from the root, protrudes from a sheath, or unwinds from a regular series of volutions. But in none is the designation equally strict and appropriate as in the *Planariæ*. There it is absolutely the organ of the elephant in miniature, with this exception, that it is neither annulated nor composed of segments. It is of surprising length, being little, if any, shorter when fully extended than the whole animal. It seems of greater consistency, harder, and tougher than the rest of the body

so as to admit insertion into decaying vegetables, and when stretched to the utmost the root becomes an apex of the slenderest cone."<sup>1</sup>

*Planariæ* multiply by eggs, and by spontaneous fission, in a transverse direction, each segment becoming a perfect animal. Professor Agassiz believes that the infusorial animals, *Paramœcium* and *Kolpoda*, are nothing else than *Planarian larvæ*.

*Hirudinidæ*, the Leech tribe, are usually believed to form a link between the *Annelida* on the one hand, and the *Trematoda* on the other; but their affinities are closer connected with the latter than the former. Totally deprived of the characteristic setæ of the *Annelida*, and exhibiting no sectional divisions, they are provided with suckers so constantly possessed by the *Trematoda*, and present no small resemblance to them in their reproductive organs. On the other hand, in the arrangement of their nervous system and in their vascular system, the *Hirudinidæ* resemble the *Annelida*. The head in most of these animals is distinctly marked, and furnished with eyes, tentacles, mouth, and teeth, and in some instances with auditory vesicles, containing otolithes. The nervous system consists of a series of ganglia running along the ventral portion of the animal, and communicating with a central mass of brain.

The medicinal leech puts forth strong claims to our attention, on the ground of the services which it renders to mankind. The whole of the family live by sucking the blood of other animals; and, for this purpose, the mouth of the leech is furnished with an apparatus of horny teeth, by which they bite through the skin. In the common leech, three of these teeth exist, arranged in a triangular, or rather triradiate form, a structure which accounts for the peculiar appearance of leech-bites in the human skin. The most interesting part of the anatomy of the leech to microscopists is the structure of the mouth (fig. 257). "This piece of mechanism," says Professor Rymer Jones, "is a dilatable orifice, which would seem at first sight to be but a simple hole. It is not so; for we find that just

<sup>1</sup>) Sir John Dalyell's *Observations on some interesting Phenomena exhibited by several Species of Planariæ*. 1814.



within the margin of this hole three beautiful little semi-circular saws are situated, arranged so that their edges



Fig. 257.—Mouth of Leech.

meet in the centre. It is by means of these saws that the leech makes the incisions whence blood is to be procured, an operation which is performed in the following manner: No sooner is the sucker firmly fixed to the skin, than the mouth becomes slightly everted, and the edges of the saws are thus made to press upon the tense skin; a sawing movement being at the same time given to each, whereby it is made gradually to pierce the surface, and cut its way to the small blood-vessels beneath. Nothing could be more admirably adapted to secure the end in view than the shape of the wound thus inflicted, the lips of which must necessarily be drawn asunder by the very contractility of the skin itself; and that the enormous sacculated stomach, which fills nearly the whole body of the leech, was designed to contain its greedily devoured meal, there can be no reasonable question. The leech, in its native element, could hardly hope for a supply of hot blood as food; and, on the other hand, its habits are most abstemious, and it may be kept alive and healthy for years, with no other apparent nourishment than what is derived from pure water frequently changed; even when at large, minute aquatic insects and their larvæ form its usual diet."

In *Clepsinidæ*, the body is of a leech-like form, but very much narrowed in front, and the mouth is furnished with a protrusile proboscis. These animals live in fresh water, where they may often be seen creeping upon aquatic plants. They prey upon water-snails.

*Tubicola*.—The worms belonging to this series of branchiferous *Annelida* are all marine, and distinguished by their invariable habit of forming a tube or case, within which the soft parts of the animal can be entirely retracted. This tube is usually attached to stones or other submarine bodies. It is often composed of various

foreign materials, such as sand, small stones, and the *débris* of shells, lined internally with a smooth coating of hardened mucus ; in others it is of a leathery or horny consistency ; and in some it is composed, like the shells of *Mollusca*, of calcareous matter secreted by the animal. The *Tubicolæ* generally live in societies, winding their tubes into a mass which often attains a considerable size : a few are solitary in their habits. They retain their position in their habitations by means of appendages very similar to those of free worms, with tufts of bristles and spines ; the latter, in the tubicular *Annelids*, are usually hooked ; so that, by applying them to the walls of its domicile, the animal is enabled to oppose a considerable resistance to any effort to draw it out of its case. In the best known family of the order (*Sabellidæ*), the branchiæ are placed on the head, where they form a circle of plumes or a tuft of branched organs. The *Serpulæ* form irregularly twisted calcareous tubes, and often grow together in large masses, when they secure themselves to shells and similar objects ; other species, *Terebella*, which build their cases of sand and stones, appear to prefer a life of solitude. The curious little spiral shells seen upon the fronds of sea-weeds, are formed by an animal belonging to the family *Spirorbis*.

If the animals be placed in a vessel of sea-water, a very pleasing spectacle will soon be witnessed. The mouth of the tube is first seen to open, by the raising of an exquisitely-constructed door, and then the creature cautiously protrudes the anterior part of its body, spreading out at the same time two beautiful fan-like expansions, of a rich purple, or scarlet colour, which float elegantly in the surrounding water, and serve as branchial or breathing organs.

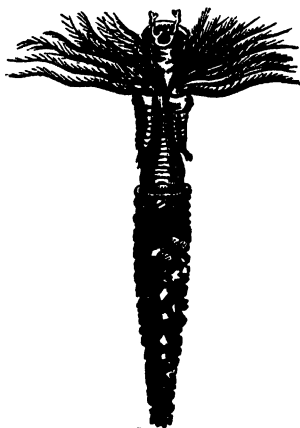

Fig. 256.—A *Serpula* protruded from the calcareous tube.

The *Serpula*, if withdrawn from its calcareous tube (fig. 260), is found to have the lower part of the body composed of a series of flattened rings, and entirely destitute of limbs or other appendages. Its food is brought to its mouth by currents created by the cilia on the branchial tufts.

Some of the Annelids are without tubes or cells of any sort, and simply bury their bodies in the sand about the tidal mark. The *Arenicola*, lob-worm, is a well-known specimen of the class; its body is so transparent that the circulating fluids can be distinctly seen under a moderate magnifying power. Two kinds of fluids flow through the vessels, one nearly colourless, the other red; the vessels through which the latter circulate are looked upon as blood-vessels. A few also have not only no tubes but are free and active swimmers. Drs. Carpenter and Claparède, during a sojourn at Lamlash Bay, Arran, met with an interesting member of this class of Annelids, the *Tomopteris onisciformis*. It possesses a remarkable pair of "frontal horns," projecting laterally from the most anterior part of head, as well as pair of greatly elongated appendages, designated by those observers as "the second antennæ," in contradistinction to another and a shorter pair of appendages situated just in advance of them, the first pair being characteristic of the larval, and the second of the adult state of the annelid.

"The head also bears on its dorsal surface a pair of *ciliated epaulettes*, which extend over the edges of the bilobed nervous ganglion. These, at a certain stage of development, are fringed with long cilia both at their margins and their base; but as the cilia are only occasionally to be seen in activity, they may escape the attention of the observer. Cilia are likewise distinguishable on certain parts of that innermost layer of the general integument which forms the external boundary of the perivisceral space, and by their agency a special movement is imparted to the corpuscles of the fluid contained in the cavity."

The development of the caudal prolongation is peculiar, and this as well as other points of interest are given in the *Lin. Soc. Trans.* vols. xxii. and xxiii. pp. 335

INSECTS' EGGS, ETC.

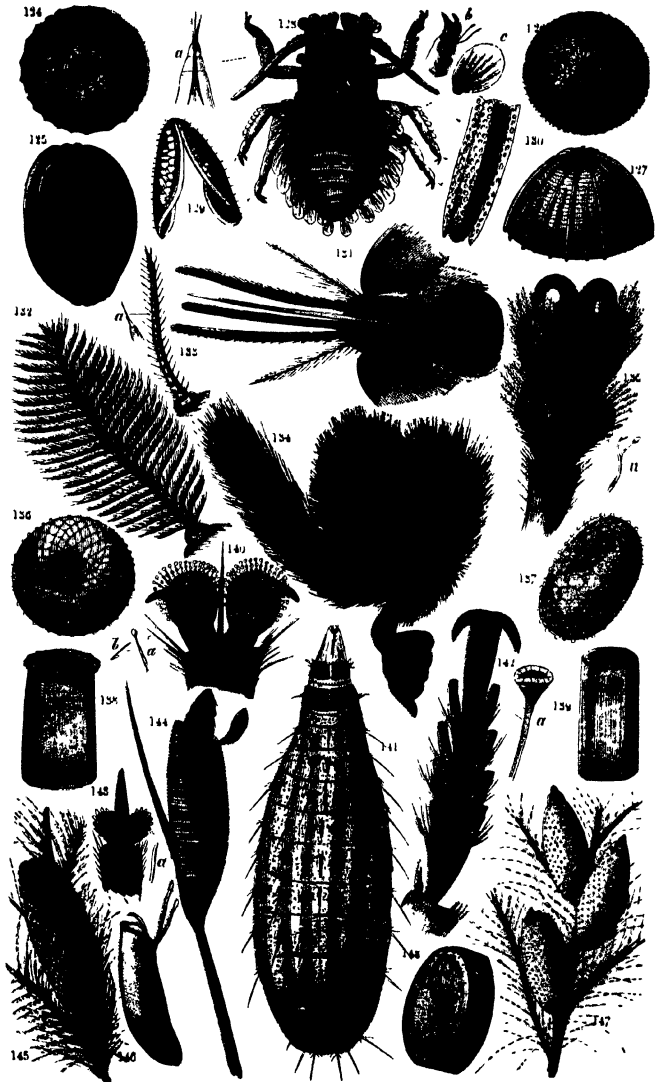

Tuffen West, del.

Edmund Evans



and 59. Dr. Carpenter believes that this creature 'is a degraded form of the annelidan type—its nearest affinities being (as already pointed out by Drs. Leuckart and Pagenstecher) the chætopod or setigerous Annelids. Every part of the characteristic organization of the type is here reduced to the extreme of simplicity. The alimentary canal passes in a straight line from one extremity of the body to the other, without either sacculations or glandular appendages. The nutritive fluid which transudes through its walls, and which finds its way into the perivisceral cavity, is distributed throughout the body solely by means of extensions of that cavity, through which it is propelled in part by the agency of cilia that clothe its walls. This fluid is obviously the homologue of the blood of higher animals, that we cannot but regard the existence of the type of structure before us (the wonderful transparency of the body not permitting the slightest doubt as to the absence of anything resembling a dorsal vessel) as affording a further confirmation of the view of the so-called circulating apparatus of the higher Annelida, which regards their perivisceral cavity and its extensions as representing the proper sanguiferous system, and which looks upon the system of vessels containing coloured fluid as a special arrangement having reference rather to the respiratory functions.<sup>1</sup> The extreme tenuity of the walls of the body and its appendages renders it unnecessary that any special provision should be made for the aeration of the nutritive fluid; and we accordingly find neither branchiæ nor any trace of what is commonly described as the sanguiferous system in Annelida. The centres of the nervous system would seem to consist solely of the cephalic ganglia—the absence of the ordinary longitudinal series being apparently related to the very incomplete segmentation of the body, and constituting a link of affinity to the Turbellarian Worms. The ocelli present a condition of extreme simplicity, yet the duplication of the corneale in each of them marks that tendency to repetition which so peculiarly distinguishes the Articulate type. It is, however, the extreme simplicity of its generative apparatus that con-

(1) See Prof. Huxley's Lectures in *Medical Times and Gazette*, July 12 and 26, 1846.

stitutes one of the chief points of interest in the organization of *Tomopteris*."

Not solely in this class, but in that of the Annelida generally, does much interest attach to the developmental period. Most of them come forth from the egg in a condition so closely resembling the ciliated gemmules of polypes, that competent observers have been known to mistake them for animals of a lower class; fortunately a few hours' careful watching is sufficient to dispel the illusory belief, and the embryonic globular shapeless mass is seen soon to change its form; segmentation takes place, and the various internal organs become more and more developed; eye spots appear, and the young animal assumes the likeness of its parent.

The *Actinotrocha*, even in the adult state, in many particulars resembles the "bipinnarian larva of the star-fish." Its long body is surmounted by a head, or mouth, around which is placed a number of ciliated ventacula: they are not only employed for feeding purposes, but also for enabling it to swim about; and in this particular, according to Dr. A. Schneider and other competent authorities, it is quite remarkable.<sup>1</sup> Dr. Carpenter tells us that he has captured these free-swimming Annelids among other marine animals by the careful use of the "stick-net."

.1) See *Ann. Nat. Hist.* vol. ix. 1862, p. 496.

## CHAPTER IV.

SUB-KINGDOM ARTICULATA.—INSECTA.—ARACHNIDA.

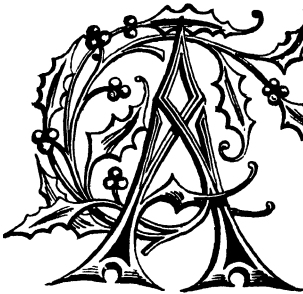

AMONG the numerous objects which engage the attention of the microscopist, the insect tribes in general are far from being the least interesting ; their curious and wonderful economy is a subject well deserving especial investigation. Earth, air, and water, teem with the various tribes of insects,

many of which are invisible to the unassisted eye, but presenting, when viewed with the microscope, the most beautiful mechanism in their frame-work, the most perfect regularity in their laws of being, and exhibiting the same wondrous adaptation of parts to the creature's wants, which, throughout creation, furnishes traces of the love and wisdom that so strongly mark the works of God.<sup>1</sup>

"I cannot," says the learned Swammerdam, "after an attentive examination of the nature and structure of both the least and largest of the great family of nature, but allow the less an equal, perhaps a superior degree of dignity. Whoever duly considers the conduct and instinct of the one with the manners and actions of the other, must acknowledge all are under the direction and control of a superior and supreme Intelligence ; which, as in the

(1) We commend to the reader the excellent *Introduction to Entomology*, by Kirby and Spence. Longmans. Art. "*Insecta*," *Cyclop. Ant. and Physia*.



largest it extends beyond the limits of our comprehension, escapes our researches in the smallest. If, while we dissect with care the larger animals, we are filled with wonder at the elegant disposition of their limbs, the inimitable order of their muscles, and the regular direction of their veins, arteries, and nerves, to what a height is our astonishment raised when we discover all these parts arranged in the least of them in the same regular manner! How is it possible but that we must stand amazed, when we reflect that those little animals, whose bodies are smaller than the point of the dissecting knife, have muscles, veins, arteries, and every other part common to large animals! Creatures so very diminutive that our hands are not delicate enough to manage, nor our eyes sufficiently acute to see them."

The Articulate sub-kingdom, *Insecta*, is divided and sub-divided into orders, families, genera, species, as for example :—

*Lepidoptera* ; typical form, Butterfly, Moth.

*Diptera* ;<sup>1</sup> typical form, Fly, Gnat, &c.

*Aptera* ; typical form, Flea, Louse, Springtail.

*Coleoptera* ; typical form, Beetle, Water Beetle, &c.

*Orthoptera* ; typical form, Locust, Grasshopper.

*Neuroptera* ; typical form, Dragon-fly, May-fly.

*Hymenoptera* ; typical form, Bee, Wasp, Ant.

*Homoptera* ; typical form, Plant-louse (*Aphis*), Lantern-fly.

*Hemiptera* ; typical form, Water-scorpion, Water-boatman.

*Arachnida* ; typical form, Spider, Scorpion, &c. The *Acarina* belong to this genus, family *Acarea*, well known as "Mites" and "Ticks."

Insects are characterised by a simple breathing apparatus ; by the division of the body into distinct regions or segments ; when three, the middle one, the thorax, bears three pairs of jointed legs, and usually two pairs of wings ; and by the possession of a single pair of jointed

(1) Comprised within the order Diptera, or two-winged flies, are several genera having no wings, the apterous and suctorial *Pulex*, and the apterous and pupiparous *Episoscidas*: among the latter, we have the winged *Hippoboscæ*, or horse fly, and some others.

**antennæ.** The metamorphoses which all undergo, before they arrive at the perfect state and are able to fulfil all the ends of their existence, are more curious and striking than in any other department of nature; and in the greater number of species the same individual differs so materially at the several periods of life, both in its internal and external conformation, in its habits, locality, and kind of food, that it becomes one of the most interesting investigations of the physiologist to ascertain the manner in which these changes are effected, to trace the successive steps by which that despised and almost unnoticed larva that but a few days before lay grovelling in the earth, with an internal organization fitted only for the reception and assimilation of the crudest vegetable matter, has had the whole of its external form so completely changed, as now to have become an object of admiration and delight, and able to "spurn the dull earth," and wing its way into the wide expanse of air, with internal parts adapted only for the reception of the purest and most concentrated aliment, which is now rendered absolutely necessary for its support, and the renovation increased energies demand.

The greater number of insects undergo a complete series of changes. They are for the most part oviparous, and their eggs assume a variety of forms, colour, &c. as will be seen in Plate VI. On first leaving the egg, they assume a more or less worm-like appearance, known as larva, maggot, or caterpillar. The next stage is that of the nymph, pupa, or chrysalis; this is succeeded by that of the perfect insect or imago. In some insects the changes are incomplete; the body, legs, and antennæ are nearly similar, but wings are wanting. In others the pupa continues active, is of a large size, and acquires rudimentary wings; and some are without material alteration of structure, the change consisting in what is termed "ædysis," a casting off, or moulting only.

The heads of insects present many points of interest; Plate VI. No. 134, shows the head of the Tortoise butterfly in profile, with large compound eye, palpi, and spiral tongue. No. 131 is a portion of the head with lancets, &c. of the *Glossina morsitans*, Tsetse-fly of Africa. In

the mouths and tongues of insects, the most admirable art and wisdom are displayed ; and their diversity of form is almost as great as the variety of species. The mouth is usually placed in the fore part of the head, extending somewhat downwards. Many have the mouth armed with strong jaws, or mandibles, provided with muscles of great



Fig. 250.—Under-surface of a Wasp's tongue, Feelers, &c. (Within the circle the same is seen life-size.)

power, with which they bruise and tear their food, answering to the teeth of the higher animals ; and in their various shapes and modifications serving as knives, scissors, augers, files, saws, trowels, pincers, or other tools, according to the requirements of each insect.

The tongue is generally a compact instrument, used principally to extract the juices on which the insect feeds, varying greatly in its length in the different species. It is capable of being extended or contracted at the insect's

pleasure; sometimes it is dexterously rolled up in a taper and spiral form, as in the Butterfly; tubular and fleshy, as in the Wasp. In fig. 259, the under lip of the Wasp is represented with its brush on either side; above which are two jointed feelers (*palpi labiales*), the use of which is probably for the purpose of making an examination of the food before it is

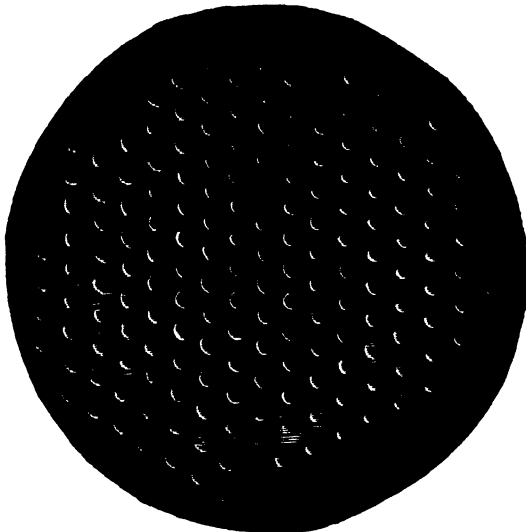

Fig 260 — *Eye of Fly (magnified 150 diameters.)*

taken into the mouth, or that of cleaning the tongue. Near these feelers the antennæ or horns are placed, as curious in form as they are delicate in structure. The antennæ of the male generally differ from those of the female: some writers believe these are organs of smell or hearing; others that they are solely intended to add to the perfection of touch or feeling, increasing their sensibility to the least motion or disturbance. Apart from their use, they are the most interesting and distinguishing characteristics of insects, and appear to be often employed for the purpose of examining every object they alight upon.

The structure of the eye is in all creatures a most admirable piece of mechanism, in none more so than in those of the insect tribe. The eyes differ in each species ; varying in number, situation, figure, simplicity of construction, and in colour. Fig. 260 represents a portion of the eye of the common Fly, drawn by the light of the sun upon a prepared photographic surface of wood ready for the engraver. Fig. 261 represents a side view of the eye when thrown down, showing

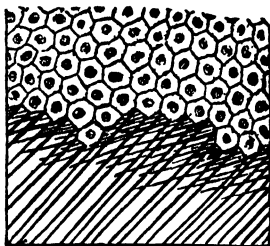

Fig 261.

the compound nature of the organ, with its series of cylindrical tubes ; better seen in fig. 262.

“ On examining the head of an insect, we find a couple of protuberances, more or less prominent, and situated symmetrically one on each side. Their outline at the base is for the most part oval, elliptical, circular, or truncated ; while their curved surfaces are spherical, spheroidal, or pyriform. These horny, round, and naked parts seem to be the corneæ of the eyes of insects ; at least, they are with propriety so termed, from the analogy they bear to those transparent tunics in the higher classes of animals. They differ, however, from these ; for, when viewed by the microscope, they display a large number of hexagonal facets, which constitute the medium for the admission of light to as many simple eyes. Under an ordinary lens, and by reflected light, the entire surface of one cornea presents a beautiful reticulation, like very fine wire gauze, with a minute papilla, or at least a slight elevation, in the centre of each mesh. These are resolved, however, by the aid of a compound microscope, and with a power of from 80 to 100 diameters, into an almost incredible number (when compared with the space they occupy) of minute, regular, geometrical hexagons, well defined, and capable of being computed with tolerable ease, their exceeding minuteness being taken into consideration. When viewed in this way, the entire surface bears a resemblance to that which might easily and artificially be produced by straining a

portion of Brussels lace with hexagonal meshes over a small hemisphere of ground glass. That this gives a tolerably fair idea of the intricate carving on the exterior may be further shown from the fact, that delicate and beautiful casts in collodion can be procured from the surface, by giving it three or four coats with a camel-hair pencil. When dry it peels off in thin flakes, upon which the impressions are left so distinct, that their hexagonal form can be discovered with a Coddington lens. This experiment will be found useful in examining the configuration of the facets of the hard and unyielding eyes of many of the *Coleoptera*, in which the reticulations become either distorted by corrugation, or broken by the pressure required to flatten them. It will be observed also, that by this method perfect casts can be obtained without any dissection whatever; and

that these *artificial exuviae*—for such they really are — become available for microscopic investigations, obviating the necessity for a more lengthened or laborious preparation. The dissection of the cornea of an insect's eye is by no means easy. I have used generally a small pair of scissors, with well - adjusted and

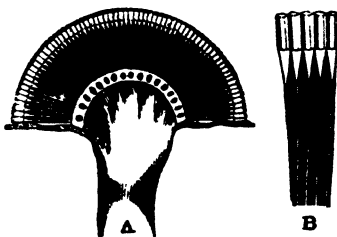

Fig. 262.

A, is a section of the eye of *Melolontha vulgaris*, Cockchafer. B, a portion more highly magnified, showing the facets of the cornea, and its transparent pyramids, surrounded with pigment. At A they meet, and form the optic nerve.

pointed extremities, and a camel-hair pencil, having a portion of the hairs cut off at the end, which is thereby flattened. The extremity of the cedar handle should be cut to a fine point, so that the brush may be the more easily revolved between the finger and thumb; and the coloured pigment on the interior may be scrubbed off by this simple process. A brush thus prepared, and slightly moistened, forms by far the best forceps for manipulating these objects preparatory to mounting; as, if only touched with any hard-pointed substance they will often spring from the table and be lost.

"Each hexagon forms the slightly horny case of an eye.<sup>1</sup> Their margins of separation are often thickly set with hair, as in the Bee; in other instances naked, as in the Dragon-fly, House-fly, &c. The number of these lenses has been calculated by various authors, and their multi-



Fig. 263 — Breathing - aperture, spiracle, of silkworm. (The circle incloses the object about the natural size.)

tude cannot fail to excite astonishment. Hooke counted 7,000 in the eye of a House-fly; Leeuwenhoek more than 12,000 in that of a Dragon-fly; and Geoffry cites a calculation, according to which there are 34,650 of such facets in the eye of a Butterfly."<sup>2</sup>

The trunk is situated between the head and the abdomen; the legs and wings are inserted into it. The thorax is the upper part of the trunk; the sides and back of which are usually armed with points or hairs. The abdomen forms the posterior part of the body, and is generally made up of rings or segments, by means of which the insect lengthens or shortens itself.

Running along the sides of the abdomen are the spiracles, or breathing apertures, fig. 263, communicating directly with the internal respiratory organs. Pure air being thus freely admitted to every part, and the circulating fluids

(1) "Each of the eyelets, or 'ocelli,' which aggregated constitute the compound eye of a Bee, is itself a perfect instrument of vision, consisting of two remarkably formed lenses, namely, an outer 'corneal' lens and an inner or 'conical' lens. The 'corneal' lens is a hexahedral or six-sided prism, and it is the assemblage of these prisms that forms what is called the 'cornea' of the compound eye. This 'cornea' may easily be peeled off, and if the whole or a portion be placed under the microscope, it will be seen that each corneal lens is not a simple lens but a double convex compound one, composed of two plano-convex lenses of different densities or refracting powers, joined together by their plane surfaces. The effect of this arrangement is, that if there should be any aberration of the rays of light during their passage through one portion of the lens, it is rectified in its transit through the other. It appears questionable whether the normal shape of these lenses is hexagonal, or whether this form is not rather a necessity of growth, &c., that is, that they are normally round, but assume the hexagonal shape during the process of development in consequence of their agglomeration." J. Samuelson and B. Hicks, "On the Eye of the Bee," *Journ. Micros. Soc.* vol. 1. p. 51

(2) "Remarks on the Cornea of the Eye in Insects," by John Gorham, *M.R.C.S. Journ. Micros. Science*, p. 76, 1853.

kept exposed to the vivifying influence of the atmosphere, the necessity for more complicated and cumbersome breathing organs is at once obviated ; and the whole body is at the same time rendered lighter. The spiracles are usually nine or ten in number, and consist of a horny ring, of an oval form. The air-tubes are exquisitely composed of two thin membranes, between which a delicate elastic thread or *spiral fibre*, is interposed, forming a cylindrical pipe, and keeping the tube always in a distended condition ; thus wonderfully preserving the sides from collapse or pressure in their passage through the air, which otherwise might occasion suffocation. Fig. 264 represents the beautiful mechanism of a portion of the tracheæ of *Hydropilus*, showing the peculiar arrangement of the spiral tubes, which give it elasticity and strength.

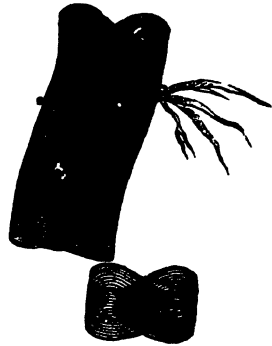

Fig. 264. — Magnified portions of the trachea of the *Hydropilus*, showing spiral tubes and their arrangement.

The legs of insects are extremely curious and interesting ; each leg consists of several horny cylinders, connected by joints and ligaments, inclosing within them sets of powerful muscles, whereby their movements are effected.

*Feet of Flies, &c.*—“The *tarsus*, or foot of the Fly, consists of a deeply bifid, membranous structure, *pulvillus* ; anterior to the attachment of this part to the fifth tarsal joint, or the upper surface, are seated two claws, or ‘tarsal ungues,’ which are freely movable in every direction. These ungues differ greatly in their outline, size, and relative development to the tarsi, and to the bodies of the insects possessing them, and in their covering ; most are naked over their entire surface, having however a hexagonal network at their bases, which indicates a rudimentary condition of minute scale-like hairs, such as are common on some part of the integument of all insects. Flexor and



extensor muscles are attached to both ungues and the flaps; the flaps, corrugated or arranged on the ridge and furrow plan, are in some cases perfectly smooth on their superior surface, in others this surface is covered with minute scale-like hairs. The thickness of the flaps on the Blow-fly does not exceed the 1-2000th of an inch at the margin; thence they increase in thickness towards the point of attachment. Projecting from their inferior surface are the organs which have been termed 'hairs,' 'hair-like appendages,' 'trumpet-shaped hairs,' &c. That

these are the immediate agents in holding is now admitted by most observers, and it will be convenient to term them "tenent" hairs, in allusion to their office. Plate VI. No. 140, the under surface of left forefoot of *Musca Vomitoria*, is shown with tenent-hairs; *a* and *b* are more magnified hairs, *a* from below, *b* from the side. No. 142 is the left forefoot of *Amara communis*, showing under surface and form of tenent appendages, one of which is seen

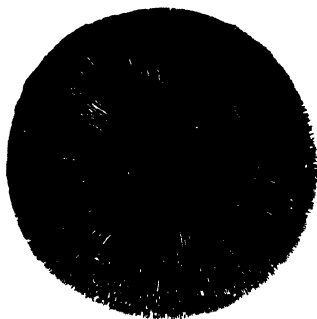

Fig 265.—Sucker on the leg of a Water-beetle. (The dot in circle shows the object natural size.)

more magnified at *a*. No. 143, under surface of left forefoot, *Ephydra riparia*. This fly is met with sometimes in immense numbers on the water in salt marshes; it has no power of climbing on glass, which is explained by the structure of the tenent-hairs: the central tactile organ is also very peculiar, the whole acting as a float, one to each foot, to enable the fly to rest on the surface of the water; *a* is one of the external hairs. No. 135, under surface of left forefoot of *Cassida viridis* (Tortoise-beetle), showing the bifurcate tenent appendages, one of which is given at *a* more magnified. These, in the ground-beetles, are met with only in the males, and are used for sexual purposes. The delicacy of the structure of these hairs in the fly, the

bend near their extremity, in each of which supervenes an elastic membranous expansion, and from which a very minute quantity of a clear, transparent fluid is emitted when the fly is actively moving, explains its capacity for clinging to polished surfaces. It simply remains to add that the tubular nature of the shaft of the tenent-hairs on the foot of this insect has been surmised, although its minute size and homogeneity hardly admits of actual confirmation. At the root of the pulvillus, or its under surface, is a process, which in some instances is short and thick, in others long and curved, and tapering to its extremity (*Scatophaga*), setose (*Empis*), plumose (*Hippoboscidae*), or, in the remarkable example (*Ephydra*), so closely resembling in its appearance the very rudimentary pulvillus with which it is associated. Just at the base of the fifth tarsal joint, on its under surface, there is present, in *Eristalis*, a pair of short, very slightly curved hairs, which point almost directly downwards. It became desirable to endeavour to ascertain how far the structure of these tenent-hairs agrees with that of true hairs, on which some valuable critical observations were made last year by Dr. Hicks.<sup>1</sup>

“Tenent-hairs are usually present in some modification or other, that it is really difficult to name a beetle which has not some form of them; the only one I yet know that seems to me really to possess nothing of the kind is a species of *Helops*, which lives on sandy heaths; I suppose the dense cushion of hairs on the tarsi here to be for the protection, simply, of the joints to which they are attached. I have detected them on the tarsal joints of species of *Ephydra*, and on the first basal tarsal joint of the Drone of the Hive-bee. A very rudimentary form of tenent-hairs is present on the under surface of some of the Tree-bugs (*Pentatomidae*), which have in addition a large, deeply-cleft organ at the extremity of the tarsus, which appears to be a true sucker.

“When walking on a rough surface, the foot represents that of a Coleopterous insect without any tenent appendages. The ungues are always attached to the last joint of

(1) See *Trans. Linn. Soc.* vol. xxiii. p. 148.

an insect's tarsus. They are *not* attached to the fifth tarsal joint of a Dipterous insect; neither are they attached to the fifth tarsal joint of a Hymenopterous insect, but to the terminal sucker, which again, in this great order, is a sixth tarsal joint, membranous, flexible, elastic in the highest degree, retractile to almost its fullest extent within the fifth tarsal joint—a joint modified to an extraordinary degree for special purposes.

“The *plantula* of *Lucanus*, with its pair of minute claws, at once occurred as a case strictly in point. The ungues are hairs modified for special purposes; and they have the structure of true hairs. The sustentacula of *Epeira*, the analogous structures on the entire under surface of the last tarsal joints in *Pholcus*, the condition of the parts in the hind limbs of *Notonecta*, in both its mature and earlier conditions, as well as in *Sarcoptes*, *Pesoptes*, and some other Acari, all contribute to the proof of this fact. The various orders of insects have, for the most part, each their own type of foot. Thus there is the Coleopterous type, the Hymenopterous type, the Dipterous type, the Homopterous type, &c.; and so very distinctive, that in critical instances they will sometimes serve at once to show to which order an insect should be referred. Thus, amongst all the Diptera, I have as yet met with but one subdivision which presents an exception to the structure described. This exception is furnished by the *Tipulidæ*, which have the Hymenopterous foot. With hardly an exception, then, I believe the form of foot described will be found universal amongst the Diptera, and will be found amongst the members of this order alone. It may be desirable to add a few words on the best plan of conducting observations on these parts. Their action should be studied in living insects under the influence of chloroform, careful notes taken of appearances, and accurate drawings made. It is of the greatest advantage to preserve carefully all the parts examined: for this purpose Deane's medium or glycerine jelly suits very well; some of the delicate preparations, however, can only be kept satisfactorily in a solution of chloride of zinc. The old plan of soaking in caustic potash, crushing, washing, putting into spirits of wine (or pressing and drying first), and then into turpen-

tine, and lastly into Canada balsam, is perfectly useless, except in rare instances where points connected with the structure of the integument have to be made out. Of course, the parts should be viewed from above, from below, and in profile, in order to gain exact ideas of their relations. The binocular microscope, however, promises to diminish vastly the difficulties which had until recently to be encountered, as by its use the parts may be clearly viewed just as they are, without preparation of any kind."<sup>1</sup>

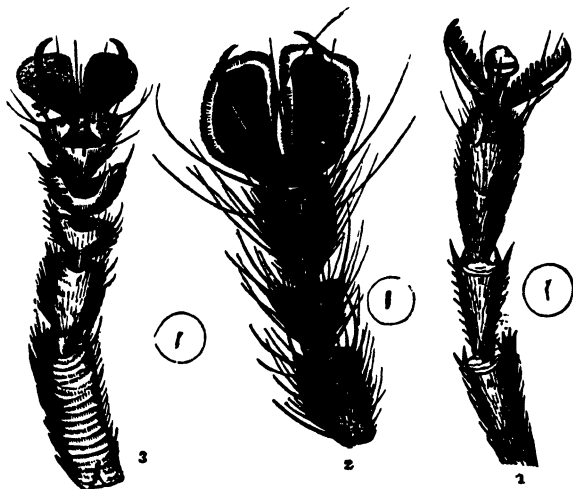

Fig 266.

1, Foot and leg of *Ophion*. 2, Foot and leg of Flesh-fly. 3, Foot and leg of Drone-fly. (The small circles inclose objects about natural size.)

Fig. 267 represents the tongue and piercing apparatus of the Drone-fly. This remarkable compound structure, together with the admirable form and exquisite beauty of the apparatus, must strike the mind with wonder and delight, and lead the observer to reflect on the weakness and impotence of all human mechanism, when compared with the skill and inimitable finish displayed in the object before us. The harder structures which surround it have

(1) Tuffan West, *Trans. Linn. Soc.* vol. xxiii. p 393.



Fig 267.—*Tongue and Piercing Apparatus of Drone-fly.*

been removed for the purpose of bringing the several parts into view, and which consist of two palpi, or feelers, covered with short hairs, and united to the head by a set of muscles; these feelers appear to be in frequent requisition for guarding the other organs from external injury. The two lancets seen above them are formed somewhat like a cutlass, or the dissecting knife of the anatomist, and are purposely intended for making a deep and sharp cut, also for cutting vertically with a sweeping stroke. The other and larger cutting instrument appears to be intended to enlarge the wound, if necessary; or it may be for the purpose of irritating and exciting the part around, thereby increasing the flow of blood to the part, being jagged or toothed at the extremity. The larger apparatus, with its three peculiar prongs, or teeth, is tubular, to permit of the blood passing through it and thence to the stomach; this is inclosed in a case which entirely covers it. The spongy tongue itself projects some distance beyond this apparatus, and is composed of a beautiful network of soft muscular spiral fibres, forming a series of absorbent tubes; and these are moved by powerful muscles and ligaments, the retractile character of which may be seen in the drawing of the proboscis of the Fly, fig. 268: by the aid of two hooklets placed in each side, he is enabled to draw in and dart out the tongue with wonderful rapidity. Another set of muscles is seen at the root of the whole apparatus.

“In the organization of the mouth of various insects we have a modification of form, to adapt them to a different mode of use; as in the *Muscidae*, or common House-flies. When the food is easily accessible, and almost entirely liquid, the parts of the mouth are soft and fleshy, and simply adapted to form a sucking tube, which in a state of rest is closely folded up in a deep fissure, on the under surface of the head. The proboscis at its base appears to be formed by the union of the *lacinia* above and the *labium* below, the latter forming the chief portion of the organ, which is tenanted by dilated muscular lips. In the *Tabanus* these are exceedingly large and broad, and are widely expanded, to encompass the wound made by the insect with its lancet-shaped mandibles in the skin of the animal it attacks. On their outer surface they are fleshy and

muscular, to fit them to be employed as prehensile organs; while on their inner they are more soft and delicate, but thickly covered with rows of very minute stiff hairs, directed a little backwards, and arranged closely together. There are very many rows of these hairs on each of the lips; and from their being arranged in a similar direction, they are easily employed by the insect in scraping or tearing delicate surfaces. It is by means of this curious structure that the busy House-fly often occasions much mischief to the covers of our books, by scraping off the white of egg and sugar varnish used to give them the polish, leaving traces of its depredations in the soiled and spotted appearance which it occasions on them. It is by means of these also that it teases us in the heat of summer, when it alights on the hand or face, to sip the perspiration as it exudes from and is condensed upon the skin. The fluid ascends the proboscis, partly by a sucking action, assisted by the muscles of the lips themselves, which are of a spiral form, arranged around a highly elastic, tendinous, and ligamentous structure, with other retractile additions for rapidity and facility of motion."<sup>1</sup>

The beautiful form of the spiral structure of the tongue should be viewed under a magnifying power of 250 diameters, or a quarter-inch object-glass.

These insects are of great service in the economy of nature, their province being the consumption of decaying animal matter, which is found about in quantities so small as to be imperceptible to most people, and is not removable by ordinary means, even in the best-kept apartments, during hot weather. It was asserted by Linnæus, that three flies would consume a dead horse as quickly as a lion. This was, of course, said with reference to the offspring of such three flies; and it is possible the assertion may be correct, since the young begin to eat as soon as they are born. A single Blow-fly has been known to produce twenty thousand living larvæ (one of which is represented in Plate VI. No. 141), and in twenty-four hours each has increased its own weight above two hundred times; in five days it attains to its full size. When the larvæ are of full size,

(1) Mr. G Newport, *Cyclopædia of Anatomy and Physiology*.

they change into the pupa state, and remain in that state a few days ; they then become flies, soon produce thou-

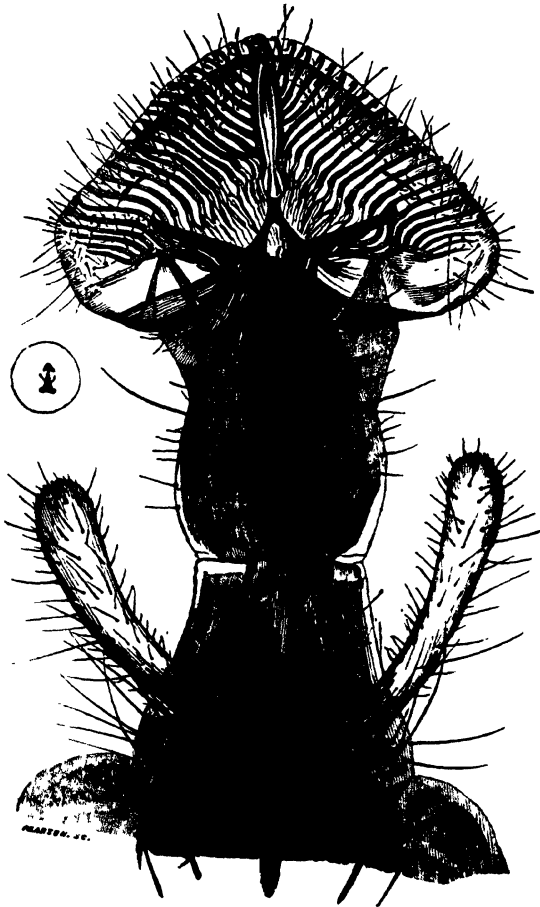

Fig. 368.—Proboscis of *House-fly*.—Drawn from a preparation by Topping. (The small circle incloses the same about natural size.)



sands of eggs, larvæ, and flies, and this is repeated again and again until the whole brood is destroyed by winter's cold.<sup>1</sup>

The "Tsetse" fly of tropical Africa (*Glossina morsitans*): the mouth, proboscis, and piercing apparatus of one, viewed from the under-side, is represented in Plate VI. No. 131. The biting apparatus consists of four parts, of which two are lateral setose palpi; if a horny case for the protection of the proboscis and its contained style can be so called. The palpi, although arising from two roots, when joined together, and accurately embracing the proboscis, as they will do when the fly is at rest, appear as one only; but when the insect is in the act of piercing or sucking, they divide, and are thrown directly upwards. The palpi are furnished on the outer, or convex sides, with long and sharply pointed, dark-brown setæ or hairs; while the inner or concave sides which are brought in contact with the proboscis are perfectly smooth and fleshy. Three circular openings seem to indicate the tubular character of what in the common fly is a fleshy, expanded, and highly-developed muscular proboscis: in the *Glossina* it is a straight, horny-looking, red-coloured bristle, the apex of which is slightly dilated and rounded, and apparently barbed, while it expands a little towards the base, and there dilates into a large-sized fleshy bag, or muscular sac, filled with a red-coloured fluid. The proboscis is grooved on the under-side for the purpose of receiving a slender glassy style, acutely pointed, and equal to it in length. The style, nicely adapted to the groove, and taking its rise from the poison gland, is the penetrating instrument. A series of long and thin muscular bands embrace this gland, and their tendinous insertions are so arranged as to bring considerable force to bear upon its contents. Physiological science has made us familiar with the fact, that

(1) Dead flies may be constantly observed, about autumn, surrounded by a sort of halo, which, upon examination, is found to consist of the spores of a fungus. The abdomen is much distended, and the rings composing it are separated from each other, the intervals being occupied by white prominent zones, constituted of a fungoid growth proceeding from the interior of the body. Further examination will show that the whole of the contents of the body of the fly have been consumed by the parasitic growth, and that nothing remains but an empty shell, lined with a thin felt-like layer composed of the interlaced mycelia of the innumerable fungi.—See Dr. F. Cohn's observations upon the parasite in vol. v. p. 154, *Journ. Microsc. Sci.* 1857.

all fluid poisons are enormously increased in their power for good or for evil, when injected beneath the skin ; this knowledge prepares us to understand how it is that a drop from the poison gland of that wonderful little fly is sufficiently potent and virulent to destroy a large animal in a few minutes. Dr. Livingstone tells us that on one occasion he lost forty-three oxen in as many minutes, "when not more than a score of the 'Tsetse' flies could be seen." The tongue is neither large nor well developed, but this is in a measure balanced by the mouth and lips ; the latter are muscular, and capable of affording great assistance while the fly is in the act of sucking the blood of its victim. The wings are long and powerful ; the legs strong and muscular ; the feet provided with the usual appendages, terminating in a pair of strong claws of a rather large size.

The wings of insects exhibit variety in form and structure, as well as beauty of colouring ; the art with which they are connected to the body, the curious manner in which some are folded up, the fine articulations provided for this purpose, with the various ramifications by which the nourishing fluids are circulated and the wings strengthened, all afford a fund of rational investigation highly entertaining, and exhibiting, when examined under the microscope, beautiful and wonderful design in their formation. Take the *Libellulidæ* (Dragon-flies) as an example, whose wings, with their horny framework, are as elegant, delicate, and as transparent as gauze ; often ornamented with coloured spots, which, at different inclinations of the sun's rays, show all the tints of the rainbow. One species (*Calepteryx virgo*) will be seen sailing for hours over a piece of water, all the while chasing, capturing, and devouring the numerous insects that cross its course ; at another time driving away competitors, or making its escape from an enemy, without ever seeming tired or inclined to alight.

In fine weather, female Dragon-flies are seen to deposit their eggs upon the water, making a strange noise, as though they were beating the water ; the cluster of eggs looks like a floating bunch of small grapes. The larvae, when hatched, live in the water ; and it is scarcely possible to fancy more strange-looking creatures. They are

short and comparatively thick, with movements heavy and clumsy, and after shedding their skins become pupæ : still continuing to live in the water. The pupæ differ from the larvæ principally in having four small scales on their sides ; these conceal their future wings. While the Dragon-fly continues in its aquatic state, both as larva and pupa, it devours all the insects it can entrap ; and as it only moves slowly, it is furnished with a very curious apparatus near its head, which it projects at pleasure, and uses as a trap. This apparatus consists of a pair of very large, jointed, movable jaws, which the insect keeps closely folded over its head, like a large mask, till it sees its prey ; when it does, it creeps softly along till it is sufficiently near ; it then darts out those long, arm-like jaws, and suddenly seizing its prey, conveys it to its mouth. When the Dragon-fly is about to emerge from its pupa-case, it places itself on the brink of the pond, or on the leaf of some water-plant sufficiently strong to bear its weight, and there divests itself of its pupa-case. When the perfect insect first appears, it has two very small wings ; these gradually increase, and in a short time two other wings appear. As soon as the wings are fully expanded, and have attained their beautiful gauze-like texture, the Dragon-fly begins to dart about, and then commences its work of destruction.

Equally rapid, exactly steered, and unwearied in its flight is the Gnat. The wings of a Gnat have been calculated, during its flight, to vibrate 3,000 times in a minute ; these wonderful wings are covered on surface and edge with a fine down or hair. The alternations of bright sunshine and rain, so commonly seen in March, are extremely favourable to the appearance of Gnats. The first that appear are called Winter Midges (*Trichocera hyemalis*). As the spring advances, these Midges are succeeded by others somewhat different ; and as the weather becomes warmer, the true Gnats appear. The sting of the Gnat (*Culex pipiens*) is well known ; although the insects themselves, so very rapid in their movements, are so much dreaded that very few people care to examine the delicacy and elegance of their forms. The sting is very curiously contrived (see fig. 269), and inclosed in a sheath, folds up

after one or more of the six lancets have pierced the flesh ; it will inflict a severe though minute wound, the pain of which is increased by an acrid liquid injected into it through a curiously-formed proboscis ; this latter is covered over with feathers or scales. A magnified view of one of these feathers is seen at No. 3. Another scale from a

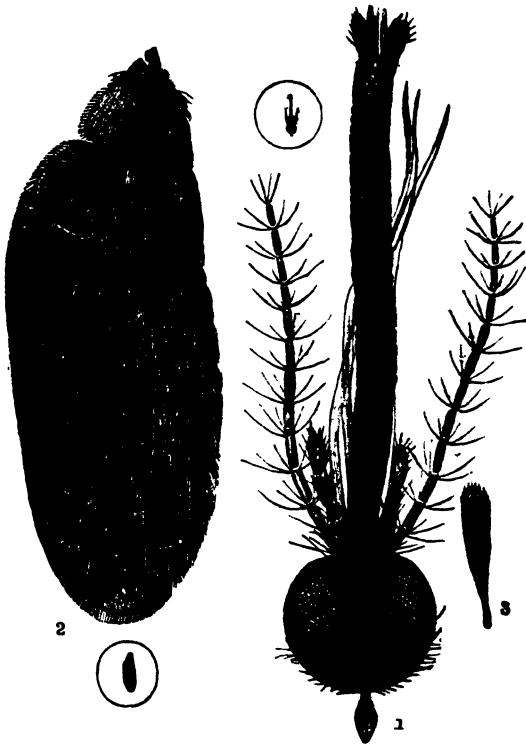

Fig. 209

1, Head of *Culex pipiens*, Female Gnat, detached from the body. 2, Wing. 3, A Scale from the Proboscis. 4, Proboscis and Lancets. The reticulation on each side of the head shows the space occupied by the eyes. The feather or scale from proboscis is magnified 250 diameters

Gnat's wing is magnified 350 diameters, fig. 273, No. 7. The proboscis is protected on either side by antennæ, or feelers.

The metamorphosis of the larva of *Corethra plumicornis*, one of the Gnat tribe, has been carefully investigated by Professor Rymer Jones, F.R.S.<sup>1</sup> This competent observer brings out many points of interest; one in particular deserves notice, namely, the use of the four remarkable-looking jet-black bodies situated in the body of the larva, two of which are placed in the thoracic region, and two near the centre of the posterior half of the body. These, which had hitherto puzzled all observers, were satisfactorily explained by the late Professor Jones, who had the good fortune to witness a metamorphosis. In form these bodies are more or less kidney-shaped, and to all appearance completely isolated in the body. Upon crushing the insect in the compressorium, they are seen to be filled with air, and it is by their aid the creature is enabled to rise and sink at pleasure. They are composed of a series of small vesicles, each of which has several coats: of these the outermost, when feebly magnified, seems of a uniform hue of black, but under a higher power is seen to be made up of many pigment cells, so as to give the organ a reticulated appearance; and it is only when this black pigment has been removed, together with a dull opaque membrane whereon the black patches rest, that the real air-sac is displayed. When thus denuded, the true walls of the air-sac appear to be composed of a dense membrane, possessing great refractive power, the effect of which upon transmitted light is extraordinary. When highly magnified, it is found to be entirely composed of numerous coils of a delicate fibre, similar to that which maintains the permeability of the tracheæ of ordinary insects, arranged in several superimposed layers, and having the appearance of being closed in on all sides. It is not until the larva thus constituted has arrived at its full size that the appearances described become complicated by intermixture with organs belonging to the pupa condition of the insect. At this period, however, the rudiments of

(1) See *Trans. Microsc. Soc.* Oct. 1867, "On the Structure and Metamorphosis of the larva of *Corethra plumicornis*."

future limbs begin to show themselves under the form of transparent vesicles, which, as they enlarge, crowd the thoracic region of the body. The change from the larva to the pupa condition involves phenomena of the most startling character. The air-sacs, situated both in the thoracic region and in the hinder portion, burst and unfold themselves into an elaborate tracheal system, and a pair of ear-shaped tubes, of which not the slightest trace could hitherto be discerned, make their appearance upon the dorsal aspect of the thorax; two long tracheæ seem to be thus simultaneously produced, occupying the two sides of the body, and constituting the main trunks, from which large branches are given off to supply, in front, the head, the eyes, and the nascent limbs; while posteriorly they spread over the now conspicuous ovaries, and terminate by ramifying largely through the thin lamellæ that constitute the caudal appendages. In individuals subjected to microscopic examination within a very brief period after their assumption of the pupa state, the places originally filled by the air-sacs of the larva are found to be occupied by the lateral remnants of their external coats, clearly indicated by ragged membranes, covered with patches of black pigment, in the immediate vicinity of which numerous air-bubbles are met with, extravasating, as it were, into the cellular tissue.

The family *Phryganeidæ*, the larvæ of which are aquatic, present almost as little resemblance to the imago as those of some metabolous insects. They are long, softish grubs, furnished with six feet, and with a horny head armed with jaws, generally fitted for biting vegetable matters, although some appear to be carnivorous. To protect their soft bodies, which constitute a very favourite food with fishes, the larvæ are always inclosed in cases formed of bits of straw and sticks, pebbles, and even small shells. The materials of these curious cases are united by means of fine silken threads, spun like those of the caterpillars of the *Lepidoptera*, from a spinnaret situated on the labium. In increasing the size of its case to suit its growth, the larva is said to add to the anterior part only, cutting off a portion of the opposite extremity. When in motion, the larva pushes its head and the three thoracic segments,

which are of a harder consistence than the rest of the body, out of its case ; and as the latter is but little, if at all, heavier than the water, the creature easily drags it along behind, thus keeping its abdomen always sheltered. It adheres stoutly to the inside of its dwelling by means of a pair of articulated caudal appendages, generally assisted by three tubercles on the first abdominal segment. Before changing to the pupa state, the larva fixes his case to some object in the water, and then closes up the two extremities with a silken grating, through which the water necessary for the respiration of the pupa readily passes. The pupa is furnished with a large pair of hooked jaws, by means of which, when about to assume the perfect state, it bites through the grating of its prison, and thus sets itself free in the water. In this form the pupæ of some species swim freely through the water by means of their long hind legs, or creep about plants with the other four ; frequently rising to the surface of the water, they there undergo their final change, using their deserted skin as a sort of raft, from which to rise into the air ; others climb to the surface of aquatic plants for the same purpose.

The perfect insect (*Phryganea grandis*) has four wings, with branched nervures, the anterior pair of which, clothed with hairs, are more frequently used than the posterior. The organs of the mouth, except the palpi, are rudimentary, and apparently quite unfit for use. The head is furnished with a pair of large eyes, and with three ocelli ; the antennæ are generally very long. Some species are so exactly like Moths, that they have often been supposed to belong to the Lepidopterous order ; in point of fact, these insects may be considered to form a connecting link between the *Neuroptera* and the *Lepidoptera*. The females have been seen to descend to the depth of a foot or more in the water, to deposit their eggs.

*Eggs of Insects*, Plate VI. No. 124, &c.—In form, colour, and variety of design, the eggs of insects are more surprisingly varied than those of the feathered tribes ; but as from their smallness they escape observation, our acquaintance with their structure and peculiarities is necessarily limited and imperfect. Although the eggs of the animal series differ much in their external characteristics,

they closely resemble each other while yet a part of the ovarian ova, and prior to their detachment from the ovary. At one period of their formation all eggs consist of three similar parts:—1st. The internal nucleated cell, or germinal vesicle, with its macula; 2d. The vitellus, or yolk-substance; and 3d. The vesicular envelope, or vitelline membrane. The germinal vesicle being the first produced may be regarded as the ovigerum; then comes the yolk-substance, which gradually envelopes it, or is deposited around it; and the vitelline membrane, the latest formed, incloses the whole. The chemical constituents of the egg contents are albumen, fatty matters, and a proportion of a substance precipitable by water. The production of the chorion, or shell membrane, does not take place till the ovum has attained nearly the full size, and it then appears to proceed, in part at least, from the consolidation over the whole surface of one or more layers of an albuminous fluid secreted from the wall of the oviduct. The observations of H. Meyer have shown that a part of the outer membrane is derived from a conversion into it of the inner cellular or epithelial lining membrane of the oviduct, at the place where it is in closest contact with the surface of the ovum. Dr. Allen Thompson therefore thinks that “many of the varieties in the appearance and structure of the external covering of eggs may probably depend on the different modes of development of these cells.”

The embryo cell is so directly connected with the germinal vesicle that at a certain period it disappears altogether, and is absorbed into the germinal yolk, or rather becomes the nucleus of the embryo, when a greater degree of compactness is observed in the yolk, and all that remains of the germinal vesicle is one or more highly refracting fat globules and albuminoid bodies. Towards the end of the period of incubation, the head of the young caterpillar, according to Meissner, lies towards the *dot* or opening in the lid, which he terms the *micropyle*,<sup>1</sup> from its resemblance to a small gate, or opening through which the worm emerges forth. From a number of careful observa-

(1) The term micropyle (a little gape) has heretofore only been used in its relation with the vegetable kingdom: it is used to denote the opening or foramen towards which the radicle is always pointed.



tions made on the silkworm, we have not been able to satisfy ourselves of the correctness of these particulars: in every case, indeed, the young worm makes its way out from a point generally below this spot. Leuckart, however, expresses his belief in this micropyle, and says, "It becomes at a later period converted into a funnel, which is connected directly with the mouth of the embryo, and serves to convey nourishment from without to it." We, on the contrary, look upon it as an involuted portion of membrane, indicating the spot where the formative process of the outer membrane terminated, or where at a still earlier stage, and while the ova was yet in the ova-sac, the spermatozoa passed in to fecundate the yolk mass.

The germinal vesicle is very large and well marked, while the egg is yet in the ova-sac of the insect. By preparing sections, after Dr. Hallifax's method,<sup>1</sup> we find that the germinal vesicle in the bee's egg is not situated immediately near or even below the so-called micropyle, but rather more to the side of the egg; just in the position which the head of the embryo is subsequently found to occupy when it arrives at maturity.

The egg membrane, or envelope, of all the *Lepidoptera*, is composed of three separate and distinct layers: an external slightly raised coat, tough and hard in its character, a middle one of united cells, and a fine transparent vitelline lining membrane, perfectly smooth and homogenous in structure, imparting solidity, and giving a fine iridescent hue to the surface, such as most of us admire in old glass exhumed from the ruins of Pompeii. The germinal vesicle is of a proportionately large size for the egg, and its macula is at first single, then multiple. In the silk-worm's egg the outer membrane is comprised of an inner reticulated membrane of non-nucleated cells, and in the outer layer the cells are arranged in an irregular circular form, also non-nucleated, with minute interstitial setæ or hairs projecting outward.

The outer surface of the egg-shell of *Coccus Persicæ* is

(1) Dr. Hallifax adopts the method of killing the insect with chloroform: he then immerses it in a bath of hot wax, in which it is allowed to remain until the wax becomes cold and hard; now with a sharp knife a section is easily made in the required direction without in the least disturbing any of the fragile parts, or internal organs.

covered by minute rings, of which the ends somewhat overlap. These rings are thought to be identical in their character with the whitish substance which exudes through pores on the under-side of the body; and it is more than probable that these layers of rings and their arrangement account for the beautiful prismatic hues which they present when viewed as opaque objects under the microscope, and by the aid of the side-condenser. This white substance, it should be observed, becomes a part of the intimate structure of the egg-shell, and is in nowise affected by either strong spirit or dilute acids. Sir John Lubbock<sup>1</sup> states that in the greenish eggs of *Phryganea*, "the colour is due to the yolk-globules themselves. In *Coccus*, however, this is not so; the yolk-globules are slightly yellow, and the green hue of the egg is owing to the green granules, which are only minute oil globules. When, however, the egg arrives at maturity, and the upper chamber has been removed by absorption, these green granules will be found to be replaced by dark-green globules, regular in size, and about 1-8000th of an inch in diameter, and which appear to be in no way the same in the yolk of *Phryganea* eggs." Another curious fact has been noticed, which partially bears on the question of colour: the production of parasitic bodies within the eggs of some insects. In the *Coccus*, for instance, parasitic cells of a green colour occur, "shaped like a string of sausages, in length about the 1-2000th of an inch by about the 1-7000th in breadth."

The eggs of Moths and Butterflies present many varying tints of colour; in speaking of this quality we do not restrict the term solely to those prismatic changes to which allusion is so often made, and which are liable to constant mutations according to the accident of the rays of light thrown upon them; but we more particularly refer to the several natural transitions of colour, the prevailing tints of which are yellow, white, grey, and a light-brown. In some eggs the yellow, white, and grey are delicately blended, and when viewed with a magnifying power of about fifty diameters, and by the aid of a side-reflector (parabolic-reflector), present many beautiful combinations. The most delicate opalescent or rather iridescent tints appear

(1) *Phil. Trans.* 1869, p. 341.

on others. of which the eggs of the feathered tribes furnish no example. The egg of the Mottled Umber Moth (*Erannis defoliaria*), Plate VI. No. 137, is in every particular very beautiful. It is ovoid, with regular hexagonal reticulations, and at each corner studded with a raised knob or button; the space within the hexagon is finely punctated, and the play of colours is exquisitely delicate. In this egg no micropyle can be seen. The egg of the Thorn Moth (*Ennomos erosaria*), Plate VI. No. 138, is of an elongated brick-looking form, one end of which is slightly tapered off, while the other in which the lid is placed is flattened and surrounded by a beautifully white-beaded border, having for its centre a slightly raised reticulated micropyle. The empty egg-shell gives a fine opalescent play of colours, while that containing the young worm appears of a brownish-yellow.

The egg of the Straw-belle Moth (*Aspilates gilvaria*), Plate VI. No. 139, is delicately tinted, somewhat long and narrow, with sides slightly flattened or rounded off, and irregularly serrated. The top is convex, and the base a little indented, in which are seen the lid and micropyle. The young worm, however, usually makes its way through the upper convex side: the indentation represented in the drawing shows the place of exit.

An example of those eggs possessing a good deal of natural colour is presented in that of the Common Puss Moth (*C. Vinula*), a large spheroidal-shaped egg, having, under the microscope, the appearance of a fine ripe orange; the micropyle exactly corresponds to the depression left in this fruit by the removal of the stalk; the surface is finely reticulated, and the natural colour a deep orange.

The egg of the Mottled Rustic Moth (*Caradina Morpheus*), No. 124, is subconical, and equally divided throughout by a series of ribs, which terminate in a well-marked geometrically-formed lid. The Tortoise-shell Butterfly (*Vanessa urtica*), No. 125, presents us with a delicate ovoid egg, divided into segments, the ribs of which turn in towards the micropyle. The Common Footman (*Lithosia campanula*), No. 126, produces a perfectly globular egg covered with fine reticulations, and of

a delicate buff colour. The egg of the Shark Moth (*Cucullia umbratica*), No. 127, is subconical in form, with ribs and cross-bars passing up from a flattened base to the summit, and turning over to form the lid. No. 136, the Egg of Blue Argus Butterfly (*Polyommatus Argus*). That of the Small Emerald Moth (*Jodis Vernaria*), No. 134, is an egg of singular form and beauty,—an oval, flattened on both sides, of silvery iridescence, and covered throughout with minute reticulations and dots. It is particularly translucent, so much so that the yellow-brown worm is readily seen curled up within. The lid or micropyle is not detected until the caterpillar eats its way out of the shell. It should be stated that the whole series of eggs in the plate are considerably over-coloured, and consequently lose much of their beautiful transparency. The eggs of Flies and Parasites also present much variety in form, colour, and construction. Many of their eggs are provided with a veritable lid, which opens up with a hinge-like articulation. The cover is shown in Plate VI. No. 144, Egg of Bot-fly, from which the larva is seen just escaping; No. 146, Egg of Scatophaga; No. 147, Egg of Parasite of Magpie.<sup>1</sup>

Moths and Butterflies supply the microscopist with some of the most beautiful objects for examination. What can be more wonderful in its adaptation than the antenna of the Moth, represented in fig. 271, No. 1, with a thin, finger-like extremity almost supplying the insect with a perfect and useful hand, moved throughout its extent by a muscular apparatus of the most exquisite construction! The tongue of Butterfly, No. 2, is evidently made for the purpose of dipping into the interior of flowers and extracting the juices; this is furnished with a spiral band of muscle: an enlarged view of a portion is given at No. 3. See also Plate VI. Nos. 132 and 133, Antennæ of Vapour Moth.

The inconceivably delicate structure of the maxillæ or tongues (for there are two) of the Butterfly, rolled up like the trunk of an elephant, and capable, like it, of every variety of movement, has been carefully examined and described by Mr. Newport. "Each maxilla is convex on

(1) A paper on the Eggs of Insects, giving many other forms will be found in the *Intellectual Observer*, Oct. 1867.

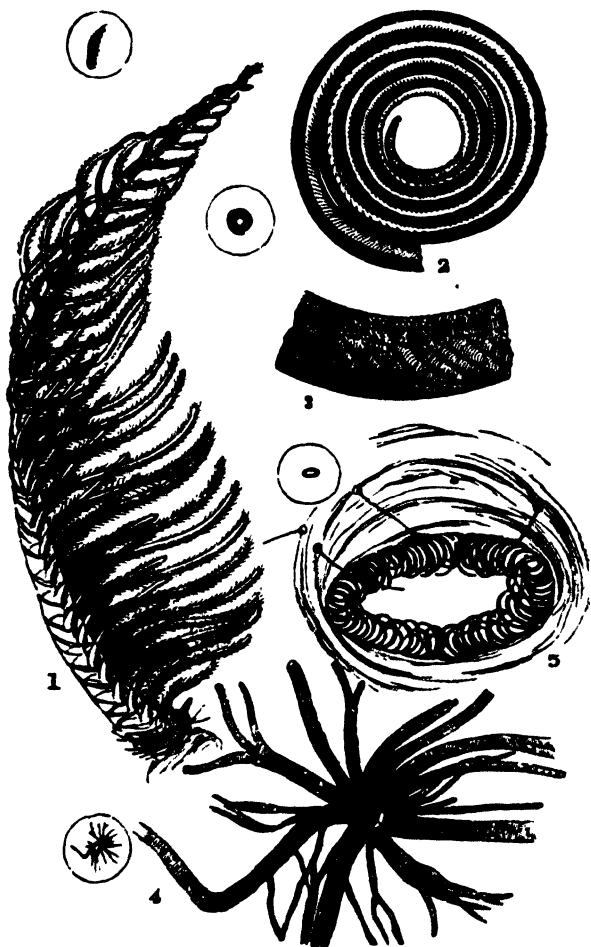

Fig. 271.

1, The *Antenna* of the Silkworm-moth. 2, Tongue of a Butterfly. 3, A portion of the Tongue highly magnified, showing its muscular fibre. 4, The *Tracheae* of Silkworm. 5, The *Foot* of Silkworm. (The small circles enclose each somewhat near its natural size).

its outer surface, but concave on its inner; so that when the two are approximated, they form a tube by their union, through which fluids may be drawn into the mouth. The inner or concave surface, which forms the tube, is lined with a very smooth membrane, and extends throughout the whole length of the organ; but that each maxilla is hollow in its interior, forming a tube 'in itself,' as is generally described, is a mistake; which has doubtless arisen from the existence of large tracheæ, or breathing-tubes, in the interior of each portion of the proboscis. In some species, the extremity of each maxilla is studded externally with a great number of minute papillæ, or fringes—as in the *Vanessa atalanta*—in which they are little elongated barrel-shaped bodies, terminated by smaller papillæ at their extremities." Mr. Newport supposes that the way in which the insect is enabled to pump up the fluid nourishment into its mouth is this: "On alighting on a flower, the insect makes a powerful expiratory effort, by which the air is expelled from the interior air-tubes, and from those with which they are connected in the head and body; and at the moment of applying its proboscis to the food, it makes an inspiratory effort, by which the central canal in the proboscis is dilated, and the food ascends it at the same instant to supply the vacuum produced; and thus it passes into the mouth and stomach: the constant ascent of the fluid being assisted by the action of the muscles of the proboscis, which continues during the whole time that the insect is feeding. By this combined agency of the acts of respiration and the muscles of the proboscis, we are also enabled to understand the manner in which the Humming-bird sphynx extracts in an instant the honey from a flower while hovering over it, without alighting; and which it certainly would be unable to do, were the ascent of the fluid entirely dependent upon the action of the muscles of the organ."<sup>1</sup>

The wings of Moths and Butterflies are covered with scales or feathers, carefully overlapping each other, as tiles are made to cover the tops of houses. The iridescent variety of colouring on their wings arises from a peculiar wavy arrangement of the scales. Figs. 272 and 273 are magni-

(1) *Cyclop. Anat. Physiol.*, article "Insecta."

fed representations of a few of them. No. 1 is a scale of the *Morpho menelaus*, taken from the side of the wing, of a

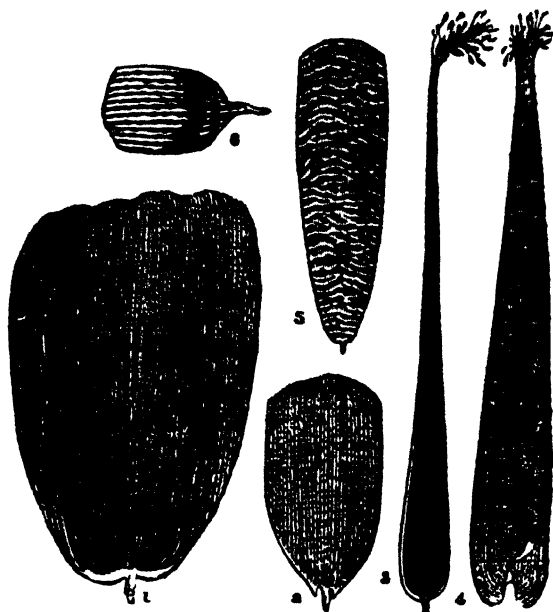

Fig. 272.—Scales from Butterflies' and Moths' wings (Magnified 200 diameters)

1, Scale of *Morpho Menelaus* 2, Large Scale of *Polyommatus Argiolus* azure blue. 3, *Hipparchia Janira Argiolus*. 4, *Pontia Brassica*. 5, *Podura Plumbea*. 6, Small Scale of Azure Blue.

pale-blue colour: it measures about 1-120th of an inch in length, and exhibits a series of longitudinal stripes or lines, between which are disposed cross-lines or striæ, giving it the appearance of brick-work. The microscope should be enabled to make out these markings with the spaces between them clear and distinct, as shown in fig. 273, No. 1a.

*Polyommatus argiolus*, Azure-blue, Nos. 2 and 6, are large and small scales taken from the under-side of the wing of this beautiful blue butterfly; the small scale is covered with a series of spots, and exhibits both longitu-

linal and transverse striæ, which should be clearly defined, and the spots separated: this is a good test of the defining power of a quarter-inch object-glass.

No. 3, *Hipparchia janira*, Common Meadow Brown Butterfly scale: on this we see a number of brown spots of irregular shape and longitudinal striæ.

No. 4, *Pontia brassica*, Cabbage-butterfly, affords an excellent criterion of the penetration and definition of a microscope: it is provided at its free extremity with a brush-like appendage. With a high power, the longitudinal markings appear like rows of little beads. Chevalier's test-object is the scale of the *Pontia brassica*, the granules of which must be rendered distinct. Mohl and Schacht use *Hipparchia janira* as a test for penetration, with a moderate angular aperture and oblique illumination. Amici's test-object is *Navicula Rhomboides*, the display of the lines forming the test; this is a very good test for angular aperture.

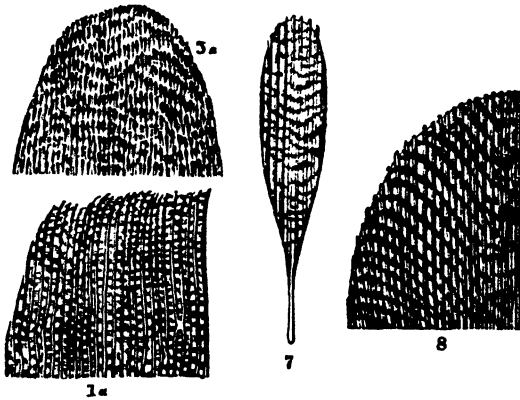

Fig. 273. — Portions of Scales, magnified 500 diameters.

1a, Portion of Scale of *Morpho Menelaus*. 5a, Portion of Large Scale of *Podura Plumbea*. 7, Scale from the Wing of Guat; its two layers are here represented. 8, Portion of a Large Scale of *Lepisma Saccharina*.

The *Tinea vestianella*, Clothes-moth, possesses very delicate and unique scales; two of these are imperfectly represented near the *Acarus* taken from one of these moths, at page 64L. The feathers from the under-side of the



wing are the best, requiring some management of illumination to bring out the lines sharp and clear.

The common Clothes-moth generally lays its eggs on the woollen or fur articles it is bent upon destroying; the larva begins to eat immediately it is hatched; then with the hairs or wool it first gnaws off, it forms a case or tube, under the protection of which it devours the substance of the article on which it fixes its abode. This tube is of parchment-like consistence, and quite white; is cylindrical in its shape, and furnished at both ends with a kind of flap, which the insect raises at pleasure, and crawls out; or it projects the front part of its body with its fore-feet through the opening, just enough to enable it to creep about without removing the rest of its body from the tube, which it draws after it. There are several kinds of Clothes-moths, the caterpillars of many bury themselves in the article on which they feed, instead of making the tube before-mentioned. The moths also differ very much in appearance; the commonest is of a light buff colour; one species, *Tinea tapetzella*, fig. 274, is nearly black, with the larger wings white tipped, or pale grey.



Fig. 274.—The Black Clothes moth.

The wavy appearance seen in the Gnat's scale (fig. 273) is most certainly an error of interpretation. For this reason I have had prepared a more highly magnified drawing of the body-scale of the Gnat. The scales of *Culex pipens* may very properly be divided into three if not four varieties. Those found on the proboscis, palpi, and legs, and which form a complete covering to these parts, are of a battledore shape; those on the nervures and marginal portions of the wings differ in form, whilst the intermediary portions of the wings and the under surface of the body have feathery tufts of a trumpet-shape. A slight variation is seen in some other scales, but each scale is inserted into the membrane by a pedicle or foot-stalk, terminating in short rootlets, shown in the wood-cut. These transverse markings of the scale, when seen slightly out of focus, give an ideal wavy appearance. It is not improbable that, on a more careful comparison of the scales of *Oulicida*, it will be found

that I have overlooked other characteristic variations: for, on cursorily going over the collection of Gnats in the British Museum, I came across a variety quite new to me. *Culex annulatus* offers a body colour variety. Alternate rings of dark and white coloured battledore scales cover the greater part of the body; and the thin fringe of hairs projecting out on either side are longer and more numerous than in *C. musquito*. The feathered antlers, pectinate-antennæ, of the male insect are very attractive objects under a moderate magnification, and these surmount a brilliant sparkling set of compound ocelli.

In the genus *Coccina* (*Dorthisia*), several species are found; the female—although apterous and active in all stages—is completely covered with a snowwhite secretion.

In another genus, the *Phytophthiria*, both sexes are indifferently wingless or furnished with four distinctly veined wings. The rostrum springing apparently from the breast; whilst the tarsi, two-jointed, are furnished with two claws. The most familiar species of this tribe are the *Aphides*, Plant-lice.

The Gnat-like midges, so very common in England, are also furnished with plumed antennæ, and are not unfrequently in consequence mistaken for *Culex pipens*. They belong, however, to *Tipulidæ*, and are quite destitute of scales, and their larvæ differ very materially.

The Maple-aphis, better known as the Leaf Insect (Plate VI. No. 128), averages about the one-fiftieth of an inch in length, and, although long sold and exhibited under the name of the "Leaf Insect," nothing was known of its origin and history, with the exception of

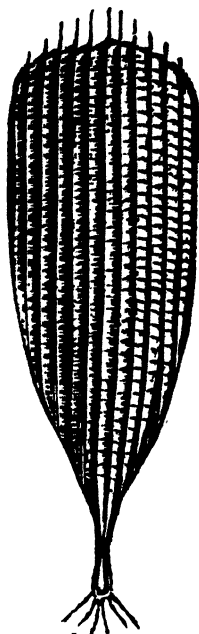

Body-scale of Gnat  
magnified 850 di-  
ameters.

what the Rev. J. Thornton stated in 1852, to whom we owe its discovery on the leaves of the maple; he, believing it to be a species of Aphides, called it *Phyllophorus testudinatus*. Subsequently it attracted the attention of the Dutch naturalist Van der Hoeven, who regarded it as the larval form of an undetermined species of Aphis, and named it *Periphyllus*. It has more recently engaged the attention of Dr. Ralbiani and M. Signoret, whose united investigations are given in the "Comptes Rendus" of June 17, 1867. They have positively ascertained that it is the larva of *Aphis aceris*; a brown species is also met with during a great part of the year upon the young shoots of the maple. At the same time a curious fact was made out, constituting a new and remarkable peculiarity in the development of this group of insects, already presenting so many curious phenomena in connexion with their reproduction. It really appears that the female produces two kinds of young—one normal, the other abnormal; the first are alone capable of continuing the course of their development, and capable of reproducing the species; whilst the latter retain their original form, which is never changed throughout their existence. They increase so little in size, that it appears almost doubtful whether they eat; the mouth is so very rudimentary that this surmise in some measure gains support from the circumstance; they undergo no change of skin, never acquire wings like the reproductive insect, and their antennæ always retain the five joints which are peculiar to all young Aphides before the first moult. Neither are they all of the same colour, some being of a bright green, as represented in our Plate, while others are of a darker, or brownish-green, colour. The brown-green embryos differ from the adult female only in those characters analogous to all other species; and that chiefly with regard to the hairs, which are long and simple. In the green embryos, in the place of hairs, the body is surrounded with scaly, transparent lamellæ, more or less oblong in shape, each of which is traversed by divergent ramifying nervures. These lamellæ not only occupy the body, but also the anterior part of the head, the first joint of the antennæ, and the outer edge of the tibiæ of the

two anterior pair of legs. The dorsal surface in these insects is covered with a mosaic of hexagonal plates, very closely resembling the plates of the carapace of the tortoise. In this particular our artist has certainly fallen into an error. Another peculiarity is that the body is much flattened out, and looks so much like a scale on the surface of the leaf, that it requires considerable practice, as well as quickness of sight, to detect the young *Maple-aphis*. One of the lamellæ is seen highly magnified at *c*, and a tenent-hair at *b*. The antennæ taper off towards the apex, are serrate on both edges, and terminate in fine setæ, one of which is shown at *a*. Below the insertions of the antennæ, brilliant scarlet-coloured compound eyes are placed, which receive their nervous supply from the central ganglion.

*Aphides* live upon plants, the juices of which they suck, and, when they occur in great numbers, cause considerable damage to vegetation; a fact well known to the gardener and farmer. Many plants are liable to be attacked by swarms of these insects, which cause the leaves to curl up: they grow sickly, and their produce is greatly reduced. One striking instance is presented in the devastation caused by the Hop-fly (*Aphis humuli*).

The *Aphrophora bifasciata*, common Frog-hopper, has the antennæ placed between the eyes, and the scutellum visible—that is to say, not covered by a process of the prothorax. The eyes, never more than two in number, are sometimes wanting. These little creatures are always furnished with long hind legs, which enable them to perform most extraordinary leaping feats. The best-known British species, because so very abundant in gardens, is the Cuckoo-spit, Froth-fly, fig. 275. The names Cuckoo-spit and Froth-fly both allude to the peculiar habit of the insect, while in the larva state, of enveloping itself in a kind of frothy secretion, somewhat resembling saliva; and this, indeed, was at one time sup-



Fig. 275.—*Aphrophora spumaria*,  
Cuckoo-spit.

*a*, The frothy substance. *b*, The pupa.

posed to be the saliva of the cuckoo, being found on the young shoots of plants just about the time the cuckoo is heard in the woods.

The *Hymenoptera* are distinguished from other insects with membranous wings by the presence of an ovipositor of peculiar construction at the extremity of the abdomen of the females, which serves for placing the eggs in the required position ; and in the males of some (Bees, Wasps, &c.) constitutes a most formidable offensive weapon. As the structure of this organ, which is rarely absent, is essentially the same throughout the order, the form of its component parts being merely modified to suit the exigencies of the different insects, a short description of its structure will not be considered out of place. The ovipositor, borer, or sting, generally consists of five pieces : a pair of horny supports (fig. 279) forming a sheath for the borer or ovipositor, being jointed at the point where they issue from the cavity of the last abdominal segment, and the last joint is usually as long as the borer itself. The latter consists of three bristles, of which the superior is grooved along its lower surface, for the reception of a pair of finer styles, and these are barbed at the point. The three pieces, when fitted together, form a narrow tube, through which the eggs pass to their destination, the poisonous fluid also, which renders the sting of the Bee so painful, is forced down the same into the wound. In the Saw-fly, a part of this organ remains rudimentary, in other respects it does not very much differ.

The larvæ of most *Hymenoptera* are footless grubs, furnished with a soft head, and exhibiting but little, if any, advance upon those of *Diptera* (Plate VI. No. 141). In the Saw-fly, however, the larva, instead of being, as above described, a mere footless maggot, presents the closest resemblance to the caterpillar of the *Lepidoptera* ; it is provided with a distinct head, with six thoracic legs, and in most cases, from twelve to sixteen pro-legs are appended to the abdominal segments.

The Saw-fly, fig. 276, most destructive to the goose-berry-bush, is remarkable for the way in which the female provides for the safety of her eggs. This fly has a flat yellow body, and four transparent wings, the outer two of

which have brown edges. The female lays her eggs on the under-side of the leaf, along the projecting veins; these are firmly attached, and cannot be removed without



Fig. 276.—The Caterpillar and Saw-fly of Gooseberry tree.

crushing. The instrument which the little insect uses for the purpose of cutting the leaf is the most remarkable piece of perfect mechanism imaginable; securely lodged,

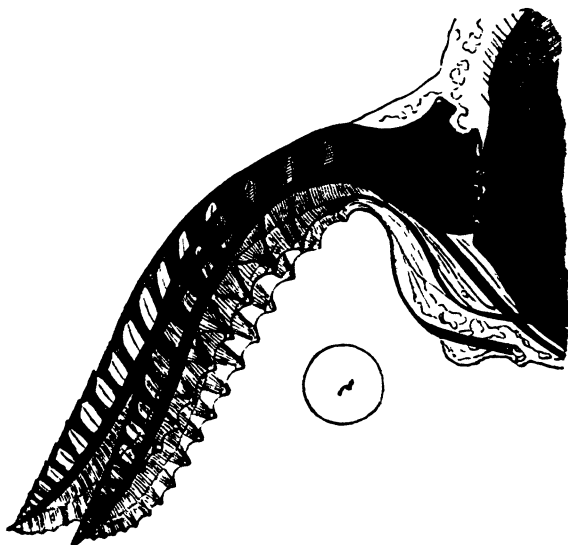

Fig. 277.—Saws of Saw-fly. (The small circle incloses the same nearly the natural size.)

when not in use, in a long narrow slit beneath the abdomen, and protected by two horny plates, which at first appear to consist of a single piece; but upon closer inspection

four plates are seen to enter into their construction; namely, two saws, placed side by side, as in fig. 277; and two supports, somewhat like the saws in shape. A deep groove runs along the thicker edge of the latter, which is so arranged that the saws glide backwards and forwards, without a possibility of running out of the groove. When the cut is made, the four are drawn together; and through a central canal, which is now formed by combining the whole, an egg is protruded into the fissure made by the saws in the leaf. The cutting edges of the saws are provided with about eighteen or twenty teeth: these have sharp points of extreme delicacy, and together make a serrated edge of the exact form given to the finest and best-made surgical saws. In the summer-time the proceedings of this little insect can be watched, and the method of using this curious instrument seen, by the aid of a hand magnifier; they are not easily alarmed when busy at their work.

Many other insects are provided with instruments for boring into the bark or solid wood itself. The *Cynip* bores a hole into the side of the oak-apple, for the purpose of depositing her egg. The larva when hatched finds a comfortable lodging, and a good supply of food; when full grown, it eats its way out of the nut, and, dropping to the ground, it assumes the form of the perfect fly. The most important of this family is the *Cynip gallæ tinctoriæ*, fig. 278, which is the cause of the gall-nut, a nut most extensively employed in the manufacture of ink and for dyeing purposes.



Fig 278.—Female *Eglantina Gall-fly* and larva.

Some of the Wasp tribe, so very peculiar in their habits, are active agents in the economy of nature. The solitary Mason-wasps curiously construct nests in the form of cells, for the purpose of carefully rearing their young. The social-wasps, like bees, live in communities, and have nearly the same divisions of labour and regulations for the good government of the colony. The structure and mechanical contrivance of the wasp's sting can only be seen under the microscope. The sting consists of

two *barbed darts*, which will penetrate the flesh deeply, and, from a peculiar arrangement of their serrated edges, their immediate withdrawal is prevented; by the great muscular effort required for this purpose, a small sac or



Fig. 279.

1, Sting of Wasp. 2, Sting of Bee. (The small circles show each nearly the full size.)



bag near the root is pressed upon, and its irritating contents squeezed out into the wound. After the fluid is injected, the wasp has the power of contracting the barbed points, and then it withdraws the sting from its victim. In fig. 279 the sting of the wasp is shown, with its attachments and muscular arrangement; and it will be seen that the sting is most wonderfully adapted to become an instrument of a very effective and dangerous character. The palpi near it are placed there for the purpose of cleaning or wiping it; at all events, this appears to be one of the uses they are put to.

The proboscis or trunk of the Honey-bee next demands attention; this is used, with its curious accessories, to collect the honey while roving about from flower to flower. The proboscis itself (fig. 280) is very curiously divided; the divisions are elegant and regular, beset with triangular hairs, which, being numerous, appear at first sight as a number of different articulations. The two outside lancets are spear-shaped, of a membranaceous or horny substance, set on one side with short hairs, and having their interior hollow; at the base of each is a hinge-articulation, which permits of considerable motion in several directions, and is evidently used by the busy insect for the purpose of opening the internal parts of flowers, and thus facilitating the introduction of its proboscis. The two shorter feelers are closely connected to the proboscis, and terminate in three-jointed articulations. Swammerdam thought these were used as fingers in assisting the removal of obstructions; but it is more probable that they are made use of by the insect for storing, and removing the bee-bread to and from the pocket-receptacles in the legs. The lower part of the proboscis is so formed that it can be considerably enlarged at its base, and thus made to contain a larger quantity of the collected juice of flowers; at the same time, it is in this cavity that the nectar is transformed into pure honey by some peculiar chemical process. The proboscis tapers off to a little nipple-like extremity, and at its base will be seen two shorter and stronger mandibles, which serve the little insects in the construction of their cells, and from between which is protruded a long and narrow tongue

or lance; the whole is most ingeniously connected to the head by a horny sheath, and a series of muscles and ligaments. The proboscis, being cylindrical, extracts the juice of the flower in a somewhat similar way to that of the butterfly; when loaded with honey, the insect's next

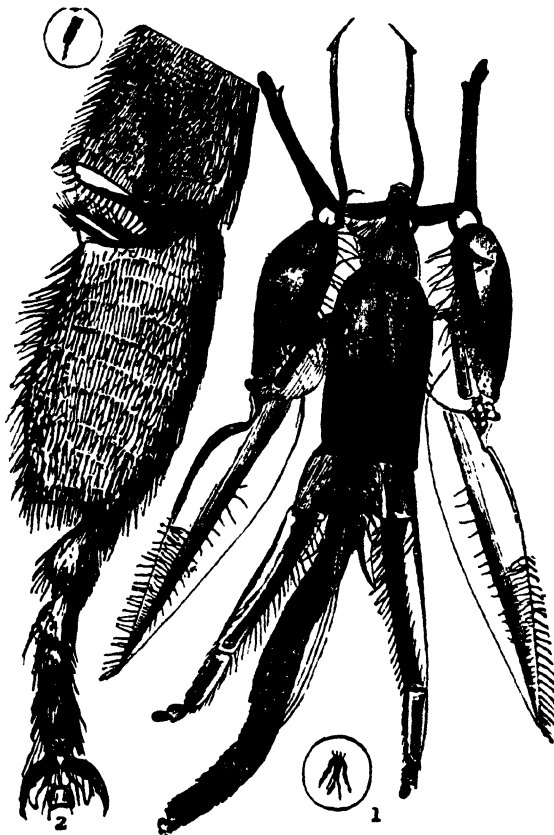

Fig. 280.

1, Honey-bee's tongue. 2, Leg, showing pocket for carrying the Bee bread.  
(The small circles show the objects about the natural size.)

care is to fill the very ingenious pockets situated in its hind legs (one of which is shown at No. 2) with bee-bread ; when these little pockets are filled with as much pollen as the bee can conveniently carry, it flies back to the hive with its valuable load, where it is speedily assisted to unload by its fellow-workers ; the pollen is at once kneaded and packed closely in the cells provided for its preservation. The quantity of this collected in one day by a single hive during favourable weather is said to be at least a pound ; this chiefly constitutes the food of the working-bees in the hive. The wax is another secretion exuding through the skin of the insect ; it is found in little pouches in the under-part of the body, but is not collected and brought home ready for use, as has been generally supposed. The waxen walls of the cells are, when completed, strengthened by a varnish, called *propolis*, collected from the buds of the poplar and other trees, and besmeared over by the aid of the wonderful apparatus represented in the engraving. If a bee is attentively observed as it settles down upon a flower, the activity and promptitude with which it uses the apparatus is truly surprising ; it lengthens the tongue, applies it to the bottom of the petals, then shortens it, bending and turning it in all possible directions, for the purpose of exploring the interior, and removing the pollen. In the words of Brook :—

“ The dainty suckle and the fragrant thyme,  
By chemical reduction they sublime ;  
Their sweets with bland tempering suction strain,  
And curious through their neat alembics drain ;  
Imbib'd reclus, the pure secretions glide,  
And vital warmth concocts th' ambrosial tide.”

The leading characteristic of the vast order *Coleoptera*, Beetles, consists in the leathery or horny texture of the anterior wings (*elytra*), which serve as sheaths for the posterior wings in repose, and generally meet in a straight line down the back.

The *elytra* present us with wing-cases of many *Curculios*, Diamond beetles, the most brilliant of opaque objects. Some are improved by being mounted in Canada balsam, whilst others are more or less injured by it : a trial of a small portion, by first touching it with turpentine, decides

this point. Oblique or side illumination shows the play of colours on the scale to the greatest advantage.

To the genus *Ptinus* belongs a small beetle known as the Death-watch, fig. 281. This and the species *Anobium* are found in our houses, doing much injury whilst in the larval state. The eggs are often deposited near some crack in a piece of furniture, or on the binding of an old book. As the larvæ are hatched, they begin to eat their way into any furniture on which they may have been deposited; and, having attained a sufficient depth, they undergo transformation, and return, by other passages, as perfect beetles. In furniture attacked by them, small round holes, about the size of the head of a pin, may be seen, and to these holes the term *worm-eaten* has been applied; and the noise, made by the insect striking its head against the wood, has given rise to the name of Death-watch. The larva is called a Book-worm when it attacks books; old books and those seldom used, are often found bored through by it. Kirby and Spence mention, that in one case twenty-seven folio volumes were eaten through, in a straight line, by this insect. The beetle is very small, and almost black. The head is particularly small; and from the prominence of the thorax, looks as if it were covered with a hood. The *Anobium puniceum*, fig. 282, attacks dried objects of natural history, and all kinds of bread and biscuits, particularly sailors' biscuits, in which maggots frequently abound. In collections of insects, it first consumes the interior; when the larva assails birds, it is generally the feet that it devours first; and in plants, the stem or woody part. The larva is a small white maggot, the body of which is wrinkled, and consists of several segments covered with fine hairs; its jaws are strong and horny, and of a dark brown. The body is white, and so transparent, that the internal organs of the insect can be seen



Fig. 281.

The Death-watch,  
*Atropus*, magnified.



Fig. 282.—*Anobium puniceum*, magnified.

through it. The beetle itself is of a reddish-brown colour, covered with fine hairs.

The Bacon-beetle (*Dermestes lardarius*) is another of the destructive beetle family. The larva of this beetle is

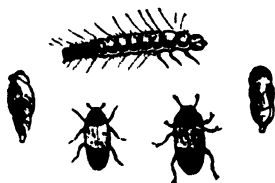

Fig. 283.—*Dermestes lardarius*.  
Larva, pupa, and imago.

particularly partial to the skin of any animal that may fall in its way; consequently it destroys stuffed animals and birds in collections of natural history, whenever it can gain access to them. It attacks hams and bacon for the skin's sake; and, being a very glutton, extends its ravages to the flesh.

This larva is long and slender, its body nearly round, and is divided into thirteen segments, of a blackish-brown in the middle, and white at the edge; the whole being furnished with bristle-shaped reddish-brown hairs.

The *Dermestidæ* belong to the family of Necrophagous beetles, six genera of which have been found in Great Britain. The *D. lardarius* is black about the head and tail, with an ash-grey band across the back, having three black spots on each wing-case. Sometimes this band takes a yellowish tinge, and then the hairs, which are here disposed in tufts, are likewise of a yellowish-grey colour. The beetle is most destructive in spring. The larvæ, like those of the clothes moths, are but seldom seen, being careful to conceal themselves in the bodies they attack, and their presence can only be guessed at by finding occasionally their cast-off skins, which they change several times during their larvæ state. Specimens of hair put up by the mounters and labelled "Hair of Dermestes," do not belong to the species at all. These hairs, long favourite objects with microscopists, and placed by them among test-objects, may, it is believed, be those found in tufts at the extremity of the body of *Anthrenus muscorum*. Westwood says that the larvæ of these beetles are furnished with tufts of hairs, which are "individually formed of a series of minute conical pieces placed in succession, the base being very slender, and the extremity a large oblong knot, placed on a slender footstalk." This

description comes very near to that of the hair in question. It is also suggested that the larvæ of another genus, that of *Tiresius serra*, furnish these hairs ; but, however that may be, it is quite clear that the hairs called "Dermestes" (fig. 307) are not obtained from the Bacon-beetle.

In the *Gyrinus*, Whirligig, we have a combination of contrivances to facilitate the creature's movements in the element in which it lives. The hind legs are converted into a pair of oars of remarkable efficiency, the point of

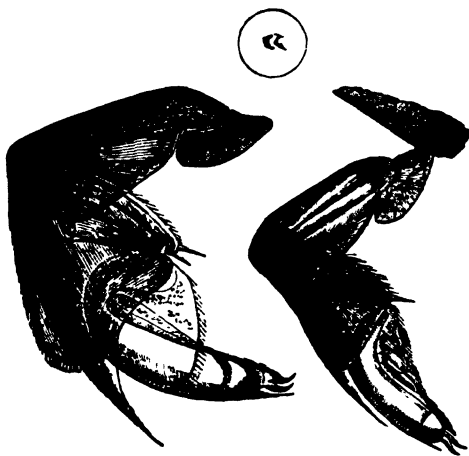

Fig. 284.

1, Leg of *Gyrinus*, Whirligig, with paddle expanded. 2, With paddle closed up.

their connexion with the body being adapted with great precision to ensure the most effectual application of the propelling power ; as it strikes out behind in the act of swimming, a membranous expansion of a portion of the legs enables the insect to move about with great rapidity ; upon the legs being drawn back again towards the body, the membrane closes up, and thus offers but a small resistance to the water (fig. 284). The eyes are not the least curious part of the merry little creature ; while one

portion of them, that fitted for seeing in the air, is fixed on the upper part of the head, the lower portion, for seeing under the water, is placed at the lowest part, a thin division separating the two.

Sir John Lubbock, writing of aquatic insects, says :<sup>1</sup> "Though most of the great orders are represented, no aquatic Hymenoptera or Orthoptera had till now (1864) been discovered. Great, therefore, was my astonishment, when I saw a small Hymenopterous insect, evidently quite at its ease, and actually *swimming* by means of its wings. At first I could hardly believe my sight ; but having found several specimens, and shown them to some of my friends, there can be no doubt about the fact. Moreover, the same insect was again observed, *within a week*, by another entomologist, Mr. Duckess, of Stepney. It is a curious coincidence that, after remaining so long unnoticed, this little insect should thus be found almost simultaneously by two independent observers. Mr Walker at first considered the insect to be *Polynema fuscipes*, but though allied to that species, it is not identical with it. So completely aquatic is it in its habits that it can remain immersed for at least twelve hours ; but it nevertheless requires to come to the surface at certain intervals to renew the air in its tracheæ. It is uncertain whether *P. notans* can also use its wings in flight. They are at any rate not easily incited to do so. It is a very minute species, and well fitted for microscopical observation, the female measuring 0.38 of an inch, and the male 0.42."

*Dytiscus marginalis*, derived from *dutes*, a diver. Larva narrow, body composed of twelve segments, including head, which is large and strong, bearing antennæ, and armed with two powerful jaws. Several varieties of this beetle are met with in fresh and still waters. The larvæ feed upon other aquatic larvæ, such as the Gnat, Dragon-fly, &c. The suckers on the legs, the feet, &c. are very interesting objects, and should be mounted for viewing both as transparent and opaque objects.

To the *Orthoptera* belong *Locustina*, *Gryllina*, and *Acheisina*, all herbivorous insects. The first is represented by our well-known Grasshopper (*Gryllus viridissimus*), the second,

the *Gryllina*, appear to frequent trees and shrubs more than the other tribes, the members of which generally keep among herbage; and, in accordance with this habit, many of the exotic species have wing-cases which present the most perfect resemblance to leaves both in colour and venation. Of the *Achetina*, the common Cricket (*Acheta domestica*), fig. 283, the noisy little denizen of the kitchen-earth, is the best example. These insects have the antennæ slender and tapering, and often considerably longer than the body. They agree with the *Gryllina* in the structure of their singing apparatus; but the wings, instead of being arranged in the form of a high-pitched roof, are laid flat upon the back. Some of them possess ocelli, whilst others are destitute of those organs. The wings are very long, and folded up in such a manner as to project beyond the wing-cases in the form of a pair of tapering tails; the abdomen is also furnished, in both sexes, with a pair of pilose, bristle-shaped, caudal appendages: in the female these form a long slender ovipositor, the two filaments being placed side by side, and somewhat thickened at the tip. The tarsi are three-jointed. The horny covering and muscular apparatus under the wing-cases of the Cricket are very curious, and will repay microscopic examination. The Cricket has two wings,



Fig. 283.—The Cricket.

covered by elytra or wing-cases of a dry membranous consistency, near the base of which is a horny ridge having transverse furrows, exactly resembling a rasp or file; this it rubs against its body with a very brisk motion, and produces the well-known merry chirp; the intensity of which is increased by a hollow space, called the tympanum, acting as a sounding-board. The gastric teeth are numerous.

In *Thysanura* there is a remarkable diversity of structure; they undergo no metamorphosis, and have no wings. This order contains two families, Spring-tails, *Poduridæ*, and *Lepismenæ*. In the former, the caudal appendage has the form of a forked tail (*Podura*, fig. 286), which is bent under the body when not in use; by its sudden extension the insect causes itself to spring to a very great



distance, in comparison with its size. The body is covered with numerous minute scales, mostly of a beautiful silvery or pearly lustre, and curiously striated.

*Podura plumbea*, Lead-colour Springtails, are generally found in damp places, leaping about like fleas. They



Fig 286.—*Podura plumbea* (In the small circle the insect appears life-size.)

prefer a moist atmosphere, some take to the surface of the water in secluded places; their food seems to be vegetable matter of any kind in a stage of decay; the little active creatures are seen to leap

about if a stone in a damp situation in the garden is turned up, or if a dark, damp corner of the cellar, about the beer-barrel, is searched; or if we peep among the roots of the ferns in the fern-case. Poduridæ, varying in form, colour, &c. are produced from eggs, undergo no metamorphosis, are not parasitic, have from twelve to sixteen simple eyes; are furnished with strong mandibles, and a broad, curious-looking snout, and a rather long body, terminating in a bifid tail, which by alternately expanding and contracting, enables them to leap great distances. The antennæ are very long, and covered with scales and fine hairs. To obtain the scales from the body without damage—which is certain to occur if the *Podura* is touched by the fingers—take a small test-tube and quickly place it over the insect, when it instantly springs up and clings to the side of the tube; insert a thin glass-cover beneath, and close up the open end. One drop of chloroform carefully administered instantly kills the insect; in a very short time this evaporates and leaves the tube quite dry. By gently shaking the tube a number of scales will drop off and adhere to the thin glass cover; remove this, and make it secure to the ordinary glass-slip.

Mr. R. Beck says, "that the best scales are obtained from insects found in comparatively dry places." Mr. S. J. McIntire, in an interesting paper on the *Podura*,<sup>1</sup> confirms this statement, but believes that the "test-scale" figured by Mr. Beck belongs to a distinct species. The

(1) *Science Gossip*, March, 1867.

markings on the scale are better seen when an achromatic condenser is employed with a good objective. Under a power of 500 diameters, the surface appears to be covered with extremely delicate longitudinal and wavy lines. The smaller scales are much more difficult to resolve than the larger, and these form a good test of the defining power of a 1-8th or 1-12th object-glass. No. 5 *a*, fig. 274, is a portion of a large scale. Fig. 273, No. 5, the longitudinal markings are shown under a lower power. "But the transverse striæ on the scale of the speckled Podura are rendered more distinct when the central rays are stopped out. Any error in the correction of the lenses, whether in the manufacture or in the adjustment of the thin covering glass, is immediately detected by the peculiar appearance which these markings present."

*Lepisma saccharina* has a spindle-shaped body covered with silvery scales, the sides of the abdomen being furnished with a series of appendages or false feet, with long-jointed bristle-like organs at their extremities. The head is concealed under a pro-thorax; the eyes are usually compound, and generally occupy the greater part of the head. The antennæ are very long, and composed of numerous joints; the maxillary palpi, which are from five to seven jointed, are very conspicuous. These insects are also inhabitants of moist places. The *Lepisma saccharina* is commonly found about houses, in sash-frames, old sugar-casks, &c.; from the latter circumstance it derives its name. The scales (fig. 273, No. 8) have long been favourite objects, and much used for testing the power of penetration and definition of object-glasses. The scales should be mounted under thin glass covers; oblique light shows some portions of the scale to advantage; other parts are rendered more distinct when the central rays of the achromatic condenser are stopped out.

The metamorphosis is complete in the *Suctoria*, or *Siphonaptera*, a wingless family—the larva, pupa, and imago of which are very distinct in their appearances—the well-known Flea is the best example of this small group. By many authors these insects have been arranged with the *Diptera*: this is most decidedly incorrect, since they differ in many particulars. The external covering of

the Flea (fig. 287) is a horny case, divided into distinct segments; those upon the thorax being always disunited. Although apterous, the Flea has the rudiments of four



Fig. 287

1 Female Flea. 2 Male Flea. (The small circles enclose fleas the actual or life size.)

wings, in the form of horny plates on both sides of the thoracic segments. Its mouth consists of a pair of sword-shaped mandibles, finely-serrated; these, with a sharp, penetrating needle-like organ, constitute the formidable weapons with which it pierces through the skin.

The neck is long, the body covered over with scales, the edges of which are set with short spikes or hairs; from its head project a pair of antennæ, feelers or horns, a proboscis, which forms a sheath to the pair of lance-shaped weapons. On each side of the head a large compound eye is placed. It has six many-jointed powerful legs, terminating in two-hooked claws; a pair of long hind legs are kept folded up when the insect is at rest, which in the act of jumping it suddenly straightens out, at the same time exhausting all its muscular force in the effort. The female Flea, fig. 287, lays a great number of eggs, sticking them together with a glutinous secretion; the Flea infesting the dog or cat glues its eggs fast to the roots of the hairs; in four days' time the eggs are hatched, and a small white larva or grub is seen crawling about, and feeding most actively. No. 4 (fig. 289) is a magnified view of one, covered with short hairs, doubtless for the purpose of preventing its dislodgment. After remaining in this state about nine or ten days, it assumes the pupa form; this it retains four days; and in nine days more it becomes a perfect Flea. The head of the Flea found in the cat (No. 3, fig. 289) somewhat differs in form from that of the species infesting the human being. Its jaws are furnished with more formidable-looking mandibles, and from between the first and second joints behind the head short strong spines project.

*Arachnida*.—The animals forming the class *Arachnida* include spiders and their allies, most of which are looked upon with disgust and aversion by the generality of mankind. *Arachnida* are divided into two orders, *Trachearia* and *Pulmonaria*. The first includes the *Acaridæ* or Mites, in which we find tracheæ, as in insects, but no distinct vascular apparatus: in the second, spiders and scorpions are included, and these have a pulmonary cavity, and a well-developed circulatory system. The above are distinguished from *Podophthalmia* or *Arthropoda* by their

aerial respiration, their possession of four pairs of legs attached to an anterior division of the body, and the total absence of antennæ. The body is also covered with a softish skin, which sometimes attains a horny consistency, but nothing more. In the higher forms, the body is divided into two parts, the anterior of which, as in *Crustacea*, consists of a thoracic segment, amalgamated with the head, and forming together a whole called the cephalothorax. In the highest classes the division of the thorax into separate segments becomes apparent; the anterior segment is, however, amalgamated with the head. The structure of the abdomen varies greatly. In some cases it forms a soft round mass, without any traces of segmentation; whilst in others, as scorpions, it is continued into a long flexible jointed tail.

*Acaria*, an order of animals not strictly belonging to insects, but rather to *Arachnida*, Spiders, Scorpions, &c. The general description of the class is that the head is united with the thorax, forming a cephalo-thorax; no antennæ, simple eyes, body presenting transverse striæ or furrows between the second and third pair of legs, which are eight in number, terminated by an acetabulum and claws. These animals are commonly called mites, and the best known species is that found in cheese, the *Acarus domesticus*. Most of the species are oviparous and viviparous, their eggs are very numerous. The spider envelops its eggs in a beautiful silken cocoon. Scorpions produce their young alive, and it is deserving of notice that in this family the embryo is developed in the ovum while it still remains in the ovary. The existence of a micropyle has not yet been made out in the ova of *Arachnida*. For the sake of convenience we have included Parasites in this part of our work, and in Plate VI. Nos. 144 to 147 are representations of their eggs, from some of which the larvæ are just emerging.

The *Malophagus*, or Sheep-tick, fig. 288, is apterous, and seems to be a connecting link between *acarina* and insects proper. The *Sarcoptes scabiei* produces the *itch* in the human being: it is also found to be the cause of *mange* in the dog. In one pustule on a dog suffering from this disease, as many as thirty parasites have been found.

The *Louse* (fig. 290, No. 1).—Whenever wretchedness, disease, and hunger seize upon mankind, this horrid parasite seldom fails to appear in the train of such calamities, and to increase in proportion as neglect of



Fig. 288.—*Malophagus ovinus*, Sheep-tick. (The small circle encloses one of life size.)

personal cleanliness engenders loathsome disease. When examined under the microscope, our disgust of it is in no way diminished. In the head may be distinguished two large eyes, and near to them are the two antennæ; the front of the head is long, and somewhat tapering off to form a snout, which serves as a sheath to the proboscis and the instrument of torture with which it pierces the flesh and draws the blood. To the fore part of its body six legs are affixed, having each five joints, terminated by two unequal hooks; these, with other portions, are covered with short hairs. Around the outer margin of

the body may be seen small circular dots, the breathing apertures, with which all the class are freely provided, rendering them very tenacious of life, and difficult to kill. There is another louse, rather differing in its characteristics



Fig. 289.

1, Dog's parasite. 2, Rat Acarus. 3, Head of Cat-Flea. 4, Larva, or, grub of Flea. (The life size of each is given in the small circles.)

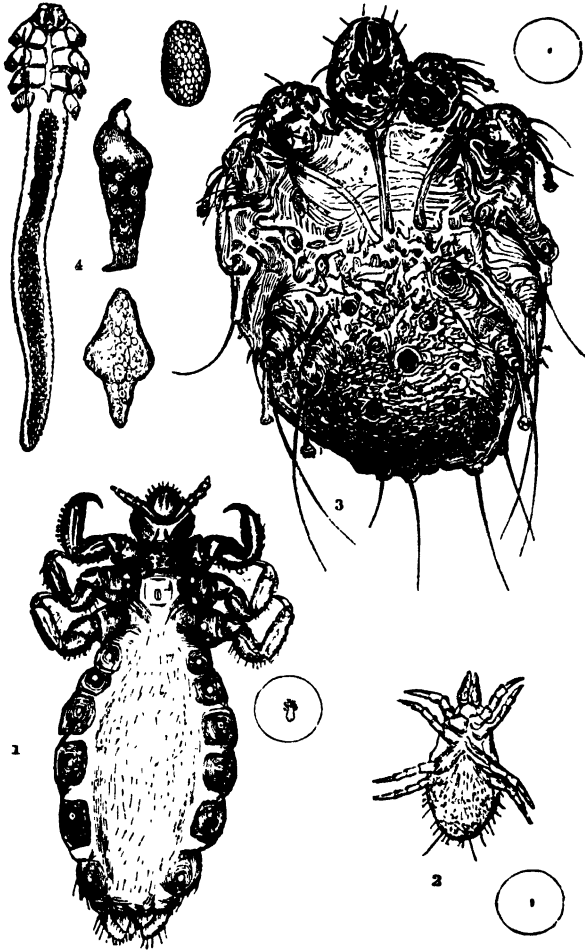

Fig. 290.—Parasites. *Acarina*.

1, Louse, Human; magnified 50 diameters. 2, *Acarus domesticus*, Cheese-Mite; under surface. 3, *Sarcoptes Scabiei*, Itch-Insect; magnified 350 diameters. 4, *Entocoon folliculorum*, Grub from the human skin in various stages of existence, from the egg upwards; magnified 350 diameters. (The small circles near represent the objects about the natural size.)



from this, found upon the body of the very poor and dirty, known as the *body* or *crab-louse*. Leeuwenhoek carried his researches on the habits of these insects further than most investigators, even allowing his zeal to overcome his disgust for such creatures as the louse. In describing its mode of taking food, &c., he observes: "In my experiments, although I had at one time several on my hand drawing blood, yet I very rarely felt any pain from their punctures; which is not to be wondered at, when we consider the excessive slenderness of the piercer; for, upon comparing this with a hair taken from the back of my hand, I judged, from the most accurate computation I could form by the microscope, that the hair was 700 times larger than this incredibly slender piercer, which consequently by its punctures must excite little or no pain, unless it happens to touch a nerve. Hence I have been induced to think that the pain or uneasiness those persons suffer who are infested by these creatures, is not so much produced from the piercer as from a real sting, which the male louse carries in the hinder part of his body, and uses as a weapon of defence." He found, from experiments made to ascertain the possible increase of these pests, that from two females he obtained in eight weeks the almost incredible number of 10,000 eggs.

The *Itch-insect*, *Sarcoptes scabiei* (fig. 290, No. 3, magnified 350 diameters). Dr. Bononio was among the first to detect the parasitic character of the disease known as the itch. On turning out one of the pustules, or little bladders, from between the fingers, with the points of very fine needles, under the microscope, a minute animal was discovered, very nimble in its motion, covered with short hairs, having a short head, a pair of strong mandibles or cutting jaws, and eight legs, terminating in remarkable sucker-like appendages.

It has no eyes; and when disturbed it quickly draws in its head and feet, and then somewhat resembles the tortoise in appearance; its march is precisely that of the tortoise. It usually lays sixteen eggs, which are carefully deposited in the furrows of the skin in pairs, and hatched in about ten days. It is an air-breathing insect, and to find it carefully search around the skin

about the pustule, and a red line or spot communicating with it will be seen; this part, and not the pustule, must be probed with a fine-pointed instrument; the operator must not be disappointed by repeated failures. Dr. Bourguignon bestowed much time in studying the habits of this troublesome parasite. To arrive at a knowledge of its haunts he arranged his microscope so as to enable him to observe it under the skin of the diseased person. The rays of light from a lamp or candle must be carefully brought to a brilliant focus by means of the condensing or bull's-eye lens upon the chosen point of observation; a Leiberkuhn should also be attached to the object-glass.

No. 4, fig. 290, *Demodex folliculorum*, is another remarkable parasite found beneath the skin of man: it is sometimes obtained from a spot where the sebaceous follicles, or fat glands, are abundant; such as the forehead, the side of the nose, and the angles between the nose and lip; if the part where a little black spot or a pustule is seen be squeezed rather hard, the oily matter there accumulated will be forced out in a globular form; if this be laid on a glass slide, and a small quantity of oil added to it, to cause the separation of the harder portions, the parasite in all probability will float out; after the addition of more oil, it can then be taken away from the oily matter by means of a fine-pointed sable pencil-brush, and transferred to a clean slide; when dry it should be immersed in Canada balsam, covered over with thin glass, and mounted in the usual way.

The Cheese-mite, *Acarus domesticus* (fig. 290, No. 2), has a peculiar elongation of its snout, forming strong, cutting, dart-shaped mandibles, which it has the power of advancing separately or together. The powder of old and dry cheese almost entirely consists of mites and their eggs, which are hatched in about eight days; if deprived of food, they have been seen to kill and eat each other. *Acari* infest almost the whole of our dried articles of food. *Ac. passularum* has two very long buccal bristles; it lives upon dried figs, and other saccharine fruits. *Ac. destructor* has long black hairs; it feeds upon the contents of entomological cabinets, especially butterflies; *Ac. pru-*

*norum* is found on dried plums, &c. ; *Ac. favorum* finds its food in old honeycombs ; *Acarus sacchari* (fig. 291) is commonly present in the more impure kinds of sugar. The discovery of the general prevalence of this acarus rests, we believe, with Dr. Hassall.

The Sugar acarus resembles somewhat, in its organisation and habits, *Acarus domesticus* ; it attains to a size so considerable, that it is plainly visible to the unaided eye.



Fig. 291.

Ova and young of the *Acarus sacchari*, Sugar-Insect, after Hassall.

When present in sugar, it may always be detected by the following proceeding : two or three drachms or teaspoonfuls of sugar should be dissolved in a large wine-glass of tepid water, and the solution allowed to remain at rest for an hour or so ; at the end of that time the *acari* will be found, some on the surface of the liquid, some adhering to the sides of the glass, and others at the bottom, mixed up with the copious and dark sediment, formed of fragments of cane, woody fibre, grit, dirt, and starch-granules, which usually subside on the solution of even a small quantity of sugar in hot water. The *Acarus sacchari*, when first hatched, is scarcely visible ; as it grows it becomes elongated and cylindrical, until it is about twice as long as

broad; after a time the legs and proboscis begin to protrude. The body is partially covered by setæ, and the feet terminate in hooks. These stages of the development of the acarus are exhibited in fig. 291.

The *Acarus farinæ*, Flour-mite.—This is of occasional occurrence in flour, but is never present unless it has become damaged. Any flour, therefore, containing the animal in question is in a state unfit for consumption. We believe that it is found more frequently in the flour of the *Leguminosæ* than that of the *Gramineæ*.

This acarus differs considerably in structure from the Sugar-mite, particularly so in its pennate setæ.

Dr. Burnett established to his satisfaction the following facts: "1. That though there are single species of parasites peculiar to particular animals, there are others which are found on different species of the same genus; as is the case in the parasites living on birds of the genus *Larus* (gulls), and the diurnal birds of

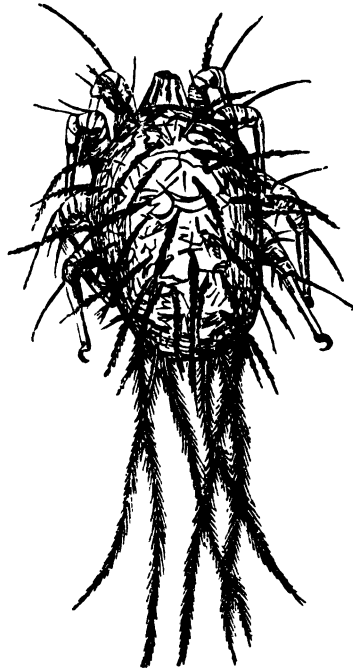

Fig. 292.—*Acarus farinæ*, Meal-Mite, magnified 250 diameters.



Fig. 293  
1, *Hippobosca Hirundinis*. 2, *Nirmus*, male and female, parasites infesting Swallow.

prey. 2. The parasites of the human body confine themselves strictly to particular regions; when they are found

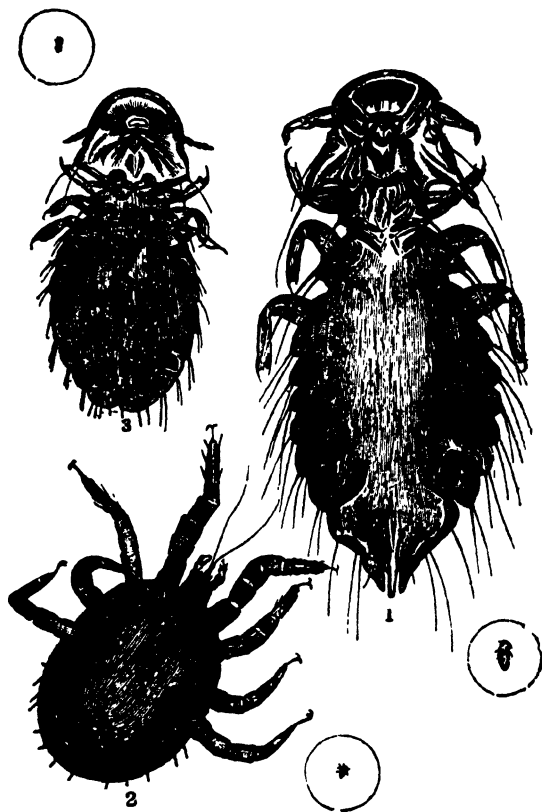

Fig. 294

1, Parasite of Turkey. 2, *Acarus* of common Fowl, under surface. 3, Parasite of Pheasant. (The small circle encloses each about life size.)

elsewhere, it is the result of accident. Thus, the *Pediculi capitis* live in the head; *P. vestimenti*, upon the surface of the body; the *P. tabescentium*, on the bodies of those dying of marasmus; and the *P. inguinalis*, about the groins, arm-

pits, mouth, and eyes." From an examination of the structure of these parasites, Dr. Burnett is of opinion that

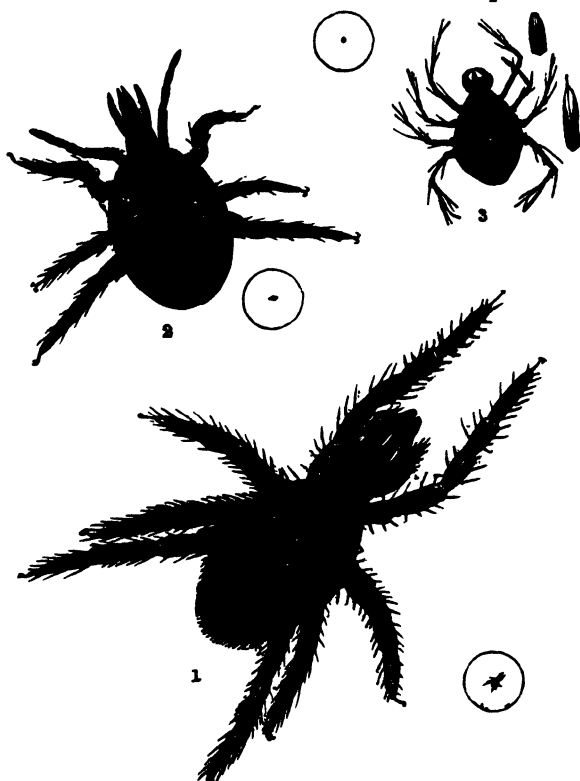

Fig. 296.

1, *Acarus* of Beetle. 2, *Acarus* of Fly. 3, *Acarus* of Clothes-Moth. (The circles enclose each about life size.)

they should be placed in an order by themselves, closely allied to *Insecta*; the mandibulate parasites occupying the highest, and the haustellate the lowest, position in the order: thus confirming to some extent the observations made by Mr. Denny.

There is a remarkable species of acarus described by

Dr. Robins, found spinning a white silken web on the base of the sparrow's thigh, or on the fore-part of its body; on raising this delicate web, you perceive that it is filled with minute eggs, from which the young issue, being in due time hatched by the warmth of the body it is destined to



Fig. 296.—Larvæ of the Parasite of Hornbill.

annoy. In fig. 296 are seen some eggs of a parasite infesting the hornbill; they are glued to the feathers near the head of the bird; the larvæ are ready to leave the egg in two days. Another, curiously enough, selects the pulmonic orifice of the snail: when the animal dilates this

orifice, for the purpose of allowing the air to penetrate its respiratory cavity, the female acarus slips through the opening, and lays her eggs in the folds of the mucous membrane, where they are gradually developed. The young, upon issuing forth from the eggs, select some portion of the snail's body upon which to feed and perfect their growth. *Ixodidæ* are furnished with a powerful rostrum, armed with recurvate spines, with which they pierce the skin of the unfortunate animal upon whose blood they live. So firmly do these anchor-like organs retain their hold, that if the parasite is pulled away it usually carries a portion of the skin of its victim with it. These creatures live upon a great variety of animals. The dog is very liable to their attacks, and many species fix themselves exclusively upon serpents and other reptiles. *Glyciphagus cursor* is found in the feathers of the owl, and in the cavities of the bones of skeletons. *Gamasidæ* are furnished with a sucking apparatus very similar to that of *Ixodidæ*, usually attaching themselves to the bodies of beetles; the common Dung-beetle (*Geotrupes*) is often found with its lower surface nearly covered with them.

There are other families leading a more active life, being furnished with eyes. One family, *Hydrachnidæ*.

Water-mites, inhabit the water, where they swim about with considerable rapidity by means of their fringed legs

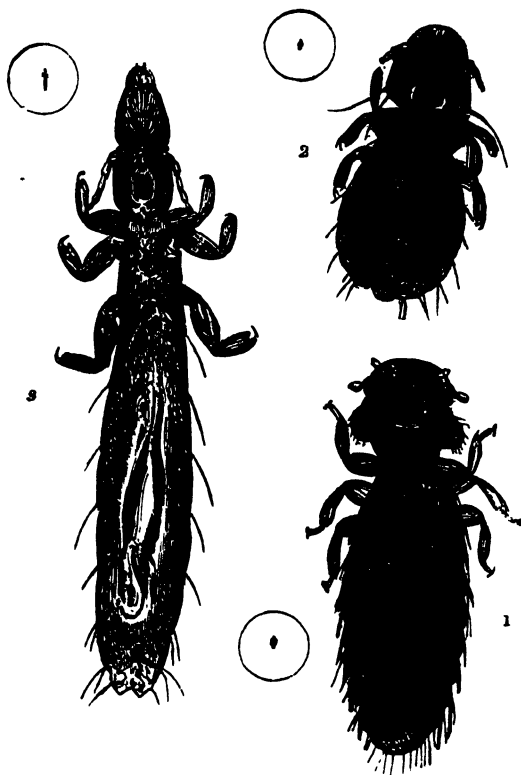

Fig. 297.

1, Parasite of Eagle. 2, Parasite of Vulture. 3, Parasite of Pigeon. (The circles inclose each about life size).

In their young state, they attach themselves parasitically to aquatic animals; they then possess only six legs, and pass through a quiescent or pupa state before acquiring the fourth pair. *Orbitadæ*, unlike other *Acaria*, live upon vegetable matter, principally damp leaves and moss;



they have a mouth adapted for biting such food, and are covered with a hard and very brittle skin. The *Bdellidæ* live among damp moss, have the body divided apparently into two parts by a constriction, and the rostrum and palpi very long; whilst *Trombididæ*, of which the little scarlet mite so often seen in gardens is an example, have their palpi converted into little raptorial organs.

Another family of parasites are commonly met with in the bodies of fishes, attaching themselves to the branchiæ, to the soft skin under the fins, or to the eyes, much to the annoyance of the unfortunate victim. Some of these found on fresh-water fish are sufficiently transparent to show the circulation of their fluids—most interesting objects for the microscope.

The Water-snail, *Limnæus*, is tormented by a larva of the family *Amphistoma*, which attaches itself by a series of hooklets and bristles to various parts of the body and mantle; under a low magnifying power, when congregated together, they appear somewhat like tufts of threads.<sup>1</sup>

ARACHNIDA, Spiders. — *Epeira diadema* is the best known of the British species of Garden Spiders: it is readily recognised by the beautiful little gem-like marks on its body and legs. Spiders abound on every shrub; and if we consider that the Spider is destitute of a distinct head, without antennæ, one-half of its body attached to the other by a very slender connexion, and so soft as not to bear the least pressure,—its limbs so slightly attached to its body that they fall off at a very slight touch,—it appears ill-adapted either to escape the many dangers which threaten it on all sides or to supply itself with food; and the economy of such an animal is deserving of the microscopist's attention.

The several important organs peculiar to the Spider tribe are represented in fig. 299. Of these, No. 1 show the spinning apparatus; four only are the spinnarets, or organs by which their silky threads are emitted. Their structure is very remarkable; the surface of each spinnaret is pierced by an infinite number of minute holes, shown

(1) The earliest known account of the parasite tribes is given in Redi's *Treatise de Generatione Insectorum*; see also H. Denny's *Monographia Anophelorum Britannica*. 1842.

in No. 2, from each of which there escapes as many little drops of a liquid as there are holes, which, drying the moment they come in contact with the air, immediately form so many delicate threads. Immediately after the filaments have passed through the pores, they unite first together, and then with those of the next, to form one common thread; so that the thread of the spider is com-

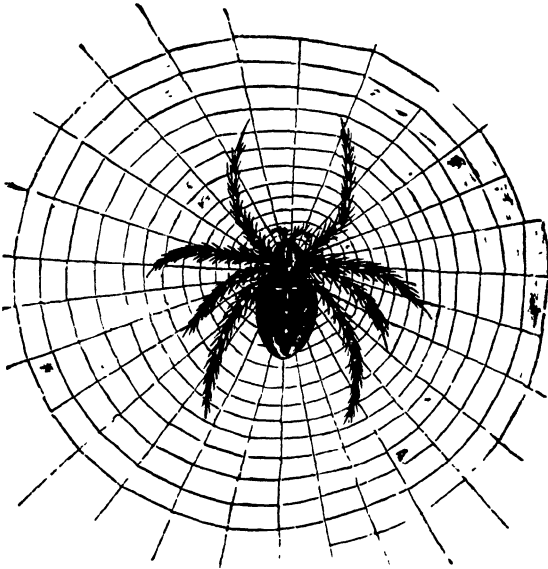

Fig. 298.—*Epeira diadema*, Diadem Spider.

posed of a large number of minute filaments, perhaps many thousands, of such extreme tenuity that the eye cannot detect them until they are twisted together into the working thread. In the two pairs of spinnarets a different anatomical structure can be detected; the pair above, which are a little the longest, show a multitude of small perforations, the edges of which do not project, and which therefore resemble a sieve. The shorter pair have projecting tubes independent of the perforations which exist

in those above. The tubes are hollow, and perforated at their extremities; and it is supposed that the agglutinating threads issue from these tubes, while those emitted from the perforations do not possess that property. It will be seen, by throwing a little dust on a circular Spider's web, that it adheres to the threads which are spirally disposed, but not to those that radiate from the centre to the circumference; the latter are also the stronger of the set

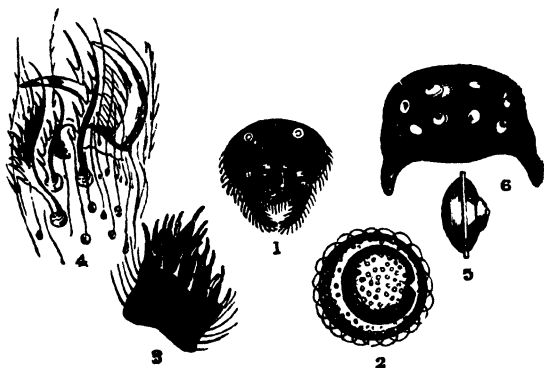

Fig. 299.

1, Spinnarets of Spider. 2, Extreme end of one of the upper pair of spinnarets. 3, End of upper pair of spinnarets. 4, Foot of Spider. 5, Side view of eye. 6, The arrangement of the four pairs of eyes.

The rapidity with which these webs are constructed is as astonishing as is the accuracy with which the webs are formed. There are many different kinds of Spiders; but nearly all of them envelop their eggs in a covering of silk, forming a round ball, which the Spider takes care to hang up in some sheltered place till the spring. The mode in which the ball is formed is very curious: the mother Spider uses her own body as a gauge to measure her work, in the same way as a bird uses its body to gauge the size and form of its nest. The Spider first spreads a thin coating of silk as a foundation, taking care to have this circular by turning its body round during the process. In the same manner it spins a raised border

round this till it takes the form of a cup; it is at this stage of the work that it begins to lay its eggs in the cup, and not content to fill it up to the brim, it also piles up a large round heap, as high as the cup is deep. Here, then, is a cup full of eggs, the under half covered and protected by the silken sides of the cup, but the upper still bare and exposed to the air and the cold. She now sets to work to cover these also: the process is similar to the preceding, that is, she weaves a thick web of silk all round them, and, instead of a cup-shaped nest, like some birds, the whole partakes of the form of a ball much larger than the body of the Spider.

The feet of the Spider, one of which is represented at No. 4, are curiously constructed. Each foot, when magnified, is seen to be armed with strong horny claws, with serrations on the under-surface. By this arrangement the Spider is enabled to regulate the issue of its rope from the spinnarets. Some have, in addition, a remarkable comb-like claw, for the purpose of separating certain threads which enter into the composition of their delicate webs.

One of the most remarkable members of the family, the *Argyroneta aquatica*, Diving Spider, weaves itself a curious little bell-shaped globule, which it takes with it to the bottom of the water, whither it retires to devour its prey. Notwithstanding its aquatic habits, this, like the rest of its order, is fitted only for aerial respiration; it therefore fills its miniature balloon with air, which it carries down with it entangled amongst the hairs of its body. This closely resembles the earliest diving-bells.

Mr. Quekett recommended the following as a simple method of obtaining a perfect system of tracheal tubes from the larvæ of insects:—A small opening having been made in the body, it is to be placed in strong acetic acid, which softens or decomposes all the viscera: the trachea must then be well washed with a syringe, and removed from the body, by cutting away the connexions of the main trunks with the spiracles, by means of fine-pointed scissors. For mounting, they should be floated on to the glass-slide, and laid out in the position best adapted for displaying them. If we wish to mount them in Canada balsam, they should be allowed to dry upon the slide,

but their natural appearance is best preserved by mounting in weak spirit and water, or Goadby's solution, using a very shallow cell, to avoid pressure. The spiracles should be dissected out with a fine knife and scissors.

*Mr. Hepworth's Mode of Preparing and Mounting Insects.*—He destroys life with sulphuric ether, then washes the insects thoroughly in two or three waters in a wide-necked bottle; he afterwards immerses them in caustic potash or Brandish's solution, and allows them to remain in it from one day to several weeks or months, according to the opacity of the insect; with a camel-hair pencil he then presses the contents of the abdomen and other soft parts dissolved by the potash out in a saucer of clean water, holding the head and thorax with one brush, and gently pressing the other with a *rolling* motion against the body from the head to the extremities. The potash must afterwards be completely washed out, or crystals may form. The insects must then be dried, the more delicate specimens being spread out or floated on to glass-slides, covered with thin glass and tied down with thread. When dry, they must be immersed in rectified spirits of turpentine, and placed under an air-pump. When sufficiently saturated they are ready for mounting in Canada balsam; but they may be retained for months in the turpentine without injury. Before mounting, as much turpentine as possible must be drained and cleaned off the slide; but the thin glass must not be removed, or air would be readmitted. Balsam thinned with chloroform is then to be dropped on the slide so as to touch the cover, and it will be drawn under by capillary attraction. After pressing down the cover, the slide may be left to dry and to be finished off. If quicker drying be required, the slide must be warmed over a spirit-lamp, but not made too hot, as boiling disarranges the object. Vapours of turpentine or chloroform may cause a few bubbles, but these disappear when condensed by cooling.<sup>1</sup>

#### TRANSFORMATION OF INSECTS.

The metamorphoses of the insect race offer some of the most curious and wonderful of nature's phenomena for

(1) *Journ. Micros. Soc.* vol. 1. p. 73.

contemplation. "We see," says an old author, "some of these creatures crawl for a time as helpless worms upon the earth, like ourselves; they then retire into a covering, which answers the end of a coffin or a sepulchre, wherein they are invisibly transformed, and come forth in glorious array, with wings and painted plumes, more like the inhabitants of the heavens than such worms as they were in their former state. The transformation is so striking and pleasant an emblem of the present, intermediate, and glorified state of man, that people of the most remote antiquity, when they buried their dead, embalmed and enclosed them in an artificial covering, so figured and painted as to resemble the caterpillar in the intermediate state; and as Joseph was the first we read of that was embalmed in Egypt, where this custom prevailed, it was probably of Hebrew origin."

Faint and imperfect symbol though it be, yet it may, perchance, offer a glimpse of the metamorphosis awaiting our own frail bodies. Between the highest and lowest degree of corporeal and spiritual perfection, there are many intermediate degrees, the result of which is one universal chain of being, no one can for a moment gainsay. Thus the angel Raphael soliloquizes in Milton's *Paradise Lost*,—

'What surmounts the reach  
Of human sense, I shall delineate so,  
By likening spiritual to corporeal forms,  
As may express them best: though *what if earth*  
*Be but the shadow of heaven, and things therein*  
*Each to other like, more than on earth is thought!*'

The great class of insects, which furnishes four-fifths of the existing species of the animal kingdom, has two chief divisions. In the one, the *Ametabola*, we have an imperfect, in the other, the *Metabola*, a perfect metamorphosis; that is, in the former there is no quiescent pupa state, and the metamorphosis is accompanied by no striking change of form; in the latter, there is an inactive pupa that takes no nourishment, and so great a change of form, that only by watching the progress of the metamorphosis can we recognise the pupa and the imago as belonging to the same animal.

The degree of metamorphosis is, however, very different

in different groups of insects. In its most *complete* form, as exemplified in the Butterflies, Moths, Beetles, and many other insects, the metamorphosis takes place in three very distinct stages. In the first, which is called the *larva* state, the insect has the form of a grub, sometimes furnished with feet, sometimes destitute of those organs. Different forms of insects in this state are popularly known as Caterpillars, Grubs, and Maggots. During this period of its existence, the whole business of the insect is eating, which it usually does most voraciously, changing its skin repeatedly, to allow for the rapid increase in its bulk; and after remaining in this form for a certain time, which varies greatly in different species, it passes to the second period of its existence, in which it is denominated a *pupa*. In this condition the insect is perfectly quiescent, neither eating nor moving. It is sometimes completely enclosed in a horny case, in which the position of the limbs of the future insect is indicated by ridges and prominences; sometimes covered with a case of a softer consistence, which fits closely round the limbs, as well as the body, thus leaving the former a certain amount of freedom. *Pupæ* of this description are sometimes enclosed within the dried larva skin, which thus forms a horny case for the protection of its tender and helpless inmate. After lying in this manner, with scarcely a sign of life, for a longer or shorter period, the insect, arrived at maturity, bursts from its prison in the full enjoyment of all its faculties. It is then said to be in the *imago* or perfect state. This metamorphosis is one of the most remarkable phenomena in the history of insects, and was long regarded as perhaps the most marvellous thing in nature; although recent researches have shown that the history of many of the lower animals presents us with circumstances equally if not more wonderful, nevertheless the metamorphosis of the higher insects is a phenomenon which cannot fail to arrest our attention. To see the same animal appearing first as a soft worm-like creature, crawling slowly along, and devouring everything that comes in its way, and then, after an intermediate period of death-like repose, emerging from its quiescent state, furnished with wings, adorned with brilliant colours, and confined in its choice of food to the

most delicate fluids of the vegetable kingdom, is a spectacle that must be regarded with the highest interest; especially when we remember that these dissimilar creatures are all composed of the same elements, and that the principal organs of the adult animal were in a manner shadowed out in all its previous stages.

Nor is the singularity of their natural history the only claim that these insects have upon our attention. Lowly as they seem in point of organization, there are few animals that exceed them in commercial importance. To give an instance or two; the finest red dyes known to our manufacturers are derived from insects. The *Lecanium ilicis*, an inhabitant of the *Ilex*, Evergreen-oak, growing in countries near the Mediterranean, was employed for this purpose by the ancient Greeks and Romans, as it is still by the Arabs; and, until the introduction of the Mexican cochineal, another species, the *Coccus polonicus*, living on the roots of the *Scleranthus perennis* in Central Europe, was much used for the same purpose. The Mexican cochineal, which has driven all other kinds out of the market, is one of the species *Coccinia*; this pretty insect was long regarded as a parasite upon the *Cactus opuntia*, Prickly-pear—a plant common in Central America. The commercial importance of this insect is shown by a single fact: in 1850, no less than 2,514,512 lbs. of cochineal were imported into Great Britain alone (value about 7s. per lb.); and as about 70,000 insects are required to weigh a pound, we may form some idea of the almost countless numbers annually destroyed. For many years the cultivation, or rather feeding, of cochineal was entirely confined to Mexico; but the insect has lately been introduced into Spain, and the French possessions in Africa, with every prospect of success. A fourth species, of great importance, is the Lac insect, *Coccus lacca*, an inhabitant of the East Indies, where it feeds upon the Banian-tree, *Ficus religiosa*, and other trees. It is to this insect we are indebted, not only for the dye-stuffs known as *lac-dye* and *lac-lake*, of which upwards of 18,000 cwts. were imported in 1850, but also for the well-known substance called *shell-lac*, so much used in the preparation of sealing-wax and varnishes. It is somewhat remark-



able that only the female insects yield a good colouring matter.

Of all the secretions peculiar to insects, *silk* may well be regarded as the most valuable, since it has become as much an essential to the purposes of mankind as to the economy of its producers. The fluid, before it comes in contact with the air, is viscous and transparent in the young larva, but thick and opaque in the more mature. It is found, by chemical analysis, to be chiefly composed of Bombic acid, a gummy matter, a portion of a substance resembling wax, and a little colouring matter. Silk may be placed in boiling water without undergoing any change; the strongest acids are required to dissolve it; and it has never yet been imitated artificially. More than 500,000 human beings derive their sole support from the culture and manufacture of silk; and the importance of the Silkworm to Great Britain alone is represented by the large sum of 16,500,000*l.* annually. Then we have large sums of money changing hands from the labours of the useful little Bee; tons' weight of honey and wax are yearly consumed; England pays more than 50,000*l.* for foreign honey and wax, in addition to her own valuable produce. A great variety of *scents*, which from their agreeable odours are much used in perfumery, are manufactured from insects. The Spanish Fly is an indispensable article in the treatment of certain forms of disease; and that invaluable agent, Chloroform, was first made from formic acid; an acid discovered in the *Formic ant*, and from which it has derived its name. Then there are Gall-nuts, produced by a small fly, for which a substitute could not be found in dyeing and ink-making.

“Much more extensive and important than any of the foregoing, but, as less palpable, even more disregarded, are the general uses of insect existence. Disease, engendered of corruption in substances animal and vegetable, would defy all the precautions of man, unless these were aided by scavenger-insects, those myriads of flies and carrion beetles, whose perpetual labours, even in our tempered climate—but infinitely more so in warmer regions—are essentially important to cleanliness and health.

“A use of this nature, and one performed perhaps to an extent we little think of is the purification of standing

waters by the innumerable insects which usually inhabit them. We have witnessed ample proof of the efficacy in this respect of Gnat larvæ, when keeping them to observe their transformations. Water swarming with these 'lives of buoyancy' has been perfectly sweet at the end of ten days; while that from the same pond, containing only vegetable matter, has become speedily offensive.

"We have already pointed out the utility of insects in affording ever-new subjects of interesting inquiry. And let those who will look scorn upon our pursuit; but few are more adapted to improve the mind. In its minute details, it is well calculated to give habits of observation and of accurate perception; while, as a whole, the study of this department of nature, so intimately linked with others above and below it has no common tendency to lift our thoughts to the great Creative Source of Being, to Him who has not designed the minutest part of the minutest object without reference to some use connected with the whole."

"The shapely limb and sinuated joint  
Within the small dimensions of a point,  
Muscle and nerve miraculously spun,  
His mighty work, who speaks, and it is done;  
The invisible in things scarce seen revealed,  
To whom an atom is an ample field."



## CHAPTER V.

### VERTEBRATA.

PHYSIOLOGY—HISTOLOGY—BOUNDARY BETWEEN THE TWO KINGDOMS—CELLS—  
DEVELOPMENT—GROWTH OF TISSUES—SKIN, CARTILAGE, TENDON,  
BONE, ETC.



THE most complicated state in which matter exists, is where, under the influence of life, it forms bodies with a curious internal structure of tubes and cavities, in which fluids are moving and producing incessant internal changes. These are called *organised bodies*, because of the various *organs* which they contain, and they form two remarkable classes; those of the lowest class are for the most part fixed to the soil, and are recognised as *vegetables*,—the structure of these we have already considered; those of the higher order are endowed with power of locomotion, and are called *animals*. Some of the peculiarities and minute structure of the invertebrate animals have already been made the subject of investigation, and we now propose to extend our observations to the vertebrate.

The study of the Science of Life, or the building up of the living structure, is termed *Physiology*, or *Biology*;<sup>1</sup> and that part of it more particularly relating to the minute structure of the organs of animals has been termed *Histology*.<sup>2</sup>

(1) From βίος, *life*, and λόγος, *discourse*—a discourse on life: a more expressive term than *physiology*

(2) From ιστός, *a tissue*, or *web*, and λόγος, *a discourse*.

INJECTIONS, ETC.

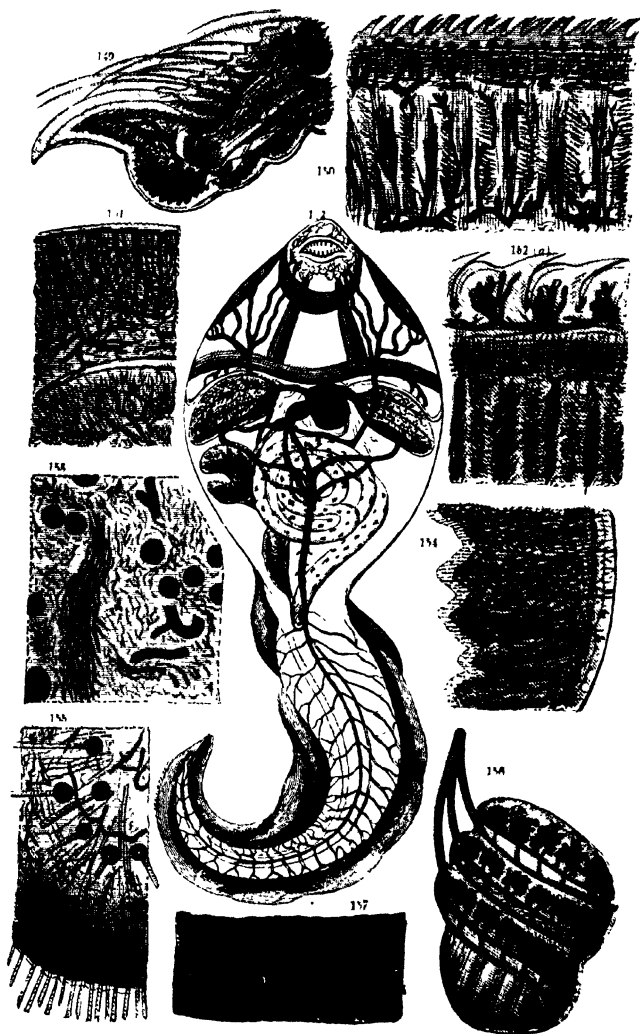

Tuffen West, del.

PLATE VII.

Edmund Evans.



Physiology has for its object the scientific co-ordination of the phenomena and laws of life ; yet, writes Mr. Lewes, "the attempts to define what we are to understand by Life. have hitherto proved almost if not quite valueless." In our previous investigations, we must have seen the value and advantage of "studying Life in its simpler forms, if Life is to be understood in its more complex ; and no sooner do we comprehend the fact that the lower animals present to us the more important phenomena of Life under simpler forms and conditions, than we at once recognise the study as indispensable."

It was Ehrenberg who first asserted that there was an absolute boundary between animals and plants ; finding even, as he fancied he did, in the smallest of the former,—the Infusoria,—which had previously been regarded as mere unorganised masses of mucus, the same systems of organs as those by which the most highly-developed animal is characterised, that is to say, distinct nutritive, motile, vascular, sexual, and sensitive systems. Siebold called the existence of these organs in question, regarding the organisation of the Infusoria as a homogeneous parenchyma, in which he recognised only a nucleus, and in one division a mouth and œsophagus. Nevertheless he asserted that plants and animals were essentially distinct, and that there was no transition from one to the other, the nature of the plant being always immotile and rigid, whilst the animal possessed the faculty of contracting and expanding its body. This contractility is, in his opinion, alone to be taken as the characteristic feature. It is not, however, the animal organisation itself which is contractile, but only a single tissue in it ; all the rest, skin, bones, and connective tissue, are as rigid or passive as the vegetable membrane, or, at most, only elastic ; in the higher animals the muscles only are contractile, and in those of the lowest classes, viz. the Infusoria, the entire body.

Whence Ecker assumed the existence of a special contractile substance, which sometimes occurs in a formed state, as a contractile cell or as muscular substance, sometimes amorphous, as in the bodies of the Infusoria, Rhizopoda, and Hydrozoa. Kölliker confirmed this view, and carried it out, particularly in the case of the Infusoria.

which he at one time declared to be unicellular animals with a contractile cell-membrane and contents. The contractile substance is characterised by the following attributes: it is homogeneous, or finely granular, transparent, of the consistence of albumen, gelatiniform, soft, more refractive than water, but less so than oil; insoluble in water, but gradually decomposed; destroyed by caustic potash; coagulated and contracted by carbonate of potash, as well as by alcohol and nitric acid; having the power of forming aqueous cavities, which originate either by the separation of the water contained in it, or by its reception from without; owing to which the remainder becomes denser and more granular, and lastly, it represents the appearance, in water, of contractile drops, which move like an *Amœba*. All these properties had already been observed by Dujardin, in a substance of which the Infusoria and Rhizopoda are principally composed, and which he termed "sarcodé;" the aqueous spaces or hollows he named "vacuoles," regarding them as the most characteristic features of the substance; these spaces had been erroneously regarded by Ehrenberg as stomachs. All these properties, however, are possessed by a substance in the plant-cell, which must be regarded as the prime seat of almost all vital activity, but especially of all the motile phenomena in its interior—the protoplasm. Not only do its optical, chemical, and physical relations coincide with those of the "sarcodé," or contractile substance, but it also possesses the faculty of forming "vacuoles" at all times, and even externally to the cell; a property, it is true, which has for the most part been hitherto overlooked or misinterpreted. These clear, aqueous spaces, the so-called vesicular contents, are present in all young cells, and play a considerable part in cell-division, and the sap-currents; they are in all respects analogous to the vacuoles of the sarcodé.<sup>1</sup>

(1) Mr. Huxley has satisfied himself that in all the animal tissues the so-called nucleus (endoplast) is the homologue of the primordial utricle, with nucleus and contents (endoplast) of the plant, the other histological elements being invariably modifications of the periplastic substance. Upon this view we find that all the discrepancies which had appeared to exist between the animal and vegetable structure disappear: and it becomes easy to trace the absolute identity of plan in the two, the differences between them being produced merely by the nature and form of the deposits in, or modifications of, the periplastic

In organised beings, the way in which nature works out her most secret processes is by far too minute for observation by unassisted vision ; even with the aid of the improved microscope, comparatively a very small portion has, up to this time, been revealed to us. To point out in detail the discoveries made through the employment of this instrument, as regards physiology, would be to give a history of modern biological science ; for there is no department in this study which is not more or less grounded upon the revelations and teachings of the microscope.

To the casual observer, the brain and nerves appear to be composed of fibres. The microscope, however, reveals to us, as was first pointed out by Ehrenberg, that these supposed fibres do not exist, or rather, that they all consist of numerous tubes, the walls of which are distinct, and contain a fluid which may be seen to flow from their broken extremities on pressure. In looking at a muscle, it appears to be made up of fine longitudinal fibres only. The microscope tells us that each of these supposed fine fibres is composed of numerous smaller ones, and that these are crossed by lines which have received the name of transverse striæ ; that muscular contraction, the cause of motion in animals, is produced by the relaxation or approximation of these transverse striæ.

The microscope has shown us that a distinct network of vessels lies between the arteries and veins, partaking of the properties of neither, and possessed of others peculiar to themselves. These have been denominated *intermediary* vessels by Berres, and, serving to connect the arterial with the venous system, are commonly known as capillaries.

On regarding with the naked eye the different glands in which the secretions are formed, how complex they appear, how various in conformation ! The microscope teaches us that they are all formed on one type ; that the

substance. In both plants and animals there is but one histological element—the endoplast—which does nothing but grow and vegetatively repeat itself ; the other element—the periplastic substance—being the subject of all the chemical and morphological metamorphoses in consequence of which specific tissues arise. The differences between the two kingdoms are mainly, first, That in the plant the endoplast grows, and the primordial utricle attains a large comparative size, while in the animal the endoplast remains small, the principal bulk of its tissues being formed by the periplastic substance ; and secondly, In the nature of the chemical changes which take place in the periplastic substance in each case.



ultimate element of every gland is a simple sacculated membrane, to which the blood-vessels have access ; and that all glands are formed from a greater or less number, or different arrangement only of the primary structure.

Our notions respecting the skin were vague until the microscope discovered its real anatomy, and showed us the existence and relations of the papillæ, of the sudorific organs and their ducts, the inhalent muscular apparatus, and so on. All our knowledge of epidermic structures, such as hair, horn, feather, &c., the real structure of cartilage, bone, tooth, tendon, cellular tissue, and, in a word, of all the solid textures, has been revealed to us by the same agency ; so that it may be truly said, that all our real knowledge of structural anatomy, and all our acquaintance with the true composition of every organ in the body, have been arrived at by means of the microscope, and could never have been known without it.

In addition to this, and what is of greater importance, after having studied the healthy structure of the body, most beneficial aid is afforded in the investigation of changes produced by disease. We may cite one notable example. Dr. Andrew Clarke, after having carefully studied the appearances of sputa from patients under his care, says, "that the microscopical inspection of expectoration affords, at a very early period of consumption, definite information, not otherwise attainable, regarding the nature of the malady ; and at all times must furnish valuable aid in forming a prognosis regarding the cause of the complaint." The expectoration generally shows pus, cells, lung tissue, blood corpuscles, and granular material, mixed with, at times, a small amount of fat corpuscles.

The space allotted to this division of our subject enables us to give only a short and imperfect sketch of a few of the fundamental tissues of the animal body. First, enumerating merely the elementary substances recognised by chemistry as entering into the formative processes, we shall proceed to inquire into that most interesting and wonderful starting-point of life, the *cell* ; admitted to be, and indeed demonstrable as, the *common centre* alike of animal and vegetable organisms.

THE HUMAN BODY, ITS PHYSIOLOGICAL COMPOSITION AND CHARACTER.

The *elementary substances* found in the human body are oxygen, hydrogen, carbon, nitrogen, phosphorus, sulphur, chlorine, fluorine, iron, manganese, titanium, and calcium. Silicon is found in the hair, and fluorine in combination

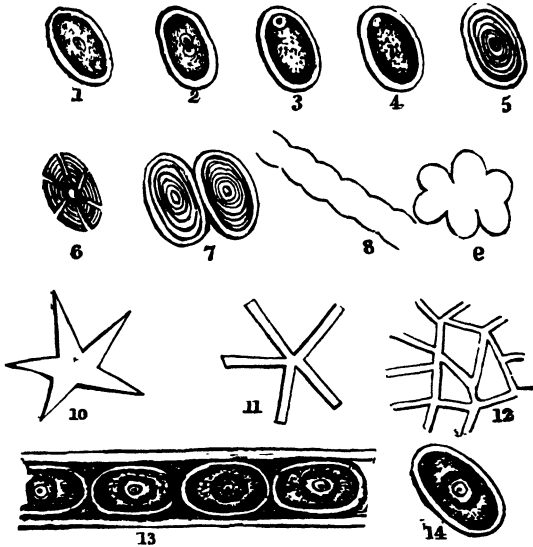

Fig. 300.—Diagram showing various forms of development in Animal Cells.

- 1, Shows a newly formed cell. 2, Subdivision of the nucleus. 3, The nucleus changes its situation, and at 4, subdivides and disappears. 5, The walls of the cell increase in thickness. 6, the cell becomes branched, or *stellate*. 7, Two cells are seen to coalesce. 8, They have coalesced and run into each other. 9, Again they take another form and become *multilocular*. 10, 11, 12, Cells sprouting out to form membrane and vessels. 14, Development of complicated cells, which, at 13, have coalesced to form tissue.

with lime forms the enamel of the teeth. Iron is the chief colouring-matter of the blood, the black pigment of the choroid of the eye, and the skin of the negro.

*Cells.*—All animal and vegetable structures, the microscope has revealed to us, are developed from cells or their nuclei ; and the materials for building up animal structures are furnished from the yolk and the blood.

The animal *nucleated cell*, fig. 300, is more or less of a globular form ; within the delicate cell-wall a granular matter is inclosed suspended in a fluid ; the wall being somewhat darker than the rest. There are usually one or two spherical masses termed nuclei ; these enclose central dots, termed the nucleoli. The size of a cell may be 1-300th part of an inch in diameter, some are larger, some smaller ; the nucleus may be 1,3000th of an inch in diameter ; the nucleolus 1-10,000th of an inch in diameter, more or less.

*Of the Cell.*—Dr. Beale's views of the cell are so original, and his theory of its development so carefully studied and worked out, that we shall attempt, in as few words as possible, to place them before our readers. The cell has always been considered, and is still so, by many good authorities, to consist, as just stated, of certain definite parts, viz. cell-wall, cell-contents, and nucleus ; to each of which various different functions have been assigned. Many affirm that the vital force is resident in the *nucleus* alone, while others attribute to the cell-wall, or even to the inter-cellular substance, the power of producing chemical and other changes. Dr. Beale considers this view to be entirely erroneous, and states that every cell or "anatomical elementary part" consists of matter in two different states or stages of existence—matter which *lives* (*germinal matter*), and matter which is *formed* (*formed material*), and which has ceased to manifest purely *vital phenomena* ; all living entities, from the smallest living particle to the most complex cell, consist of matter in these two states, the relative proportions of which differ at different periods of the life of the cell, and vary with the different conditions under which it may be placed. If a tissue be examined before development has proceeded to any great extent, masses of germinal matter will be found almost continuous with each other, without any appearance of the cells from which all tissues are said to be originally formed.

As growth proceeds, these masses become separated, and the small processes or tubes which connected them are drawn out, as it were, and become thinner and thinner ; so that, for instance, in the formation of stellate tissue, so far from the rays having been shot out by unequal growth from special points of the original cell-wall, they have been continuous from the very first.

*Of the Structure and Formation of the simple Cell Mucedines.*—The *mucedines*, commonly called mildews, are among the simplest living things known, and are therefore well adapted for observation. If the membranous investment of a fully developed spore taken from one of these fungi be ruptured, innumerable minute particles, some not more than 1-100,000th of an inch in diameter, are set free : these constitute the living growing matter, in contradistinction to the envelope or outer part of the cells. “Germinal matter” may always be readily distinguished from formed material by its capability of becoming dyed by an alkaline solution of carmine, while the latter remains perfectly colourless. Directly such a minute living particle comes into contact with air or water, a thin layer upon its outer part becomes changed into a soft, passive, transparent homogeneous substance (cell-wall), exhibiting a membranous character, which protects the matter within. Nutrient matter passes through this into the interior, and there becomes changed into living matter ; so that growth takes place, not by additions to the outside, but by the introduction of new matter into the interior. If pabulum be abundant, and the external conditions (temperature, moisture, &c.) favourable, it readily passes through the *thin* external membrane, and the living matter rapidly increases. But if the external conditions be unfavourable, less pabulum transudes, and the living matter within dies, layer after layer, until the envelope becomes very much thickened, with a proportionate decrease in the size of the living matter. If all this living matter die, and only formed material remain, no increase can take place ; but if the smallest particle remain alive, any amount of living matter, and afterwards of tissue or formed material, may be produced. The position of the germinal matter in the cell varies with the direction in which the pabulum reaches

it; thus in the columnar epithelial cells covering the villi of the intestines, in which the pabulum flows from the free surface towards the attached extremity, the germinal mass is found near the centre or near the free edge of the cells; but in the mucus-forming cells from the mouth and fauces, in which the pabulum flows in the opposite direction, the germinal mass is found to be placed quite at the attached end of the cells, where it has consequently easier access to the pabulum, upon which its growth and secretive power depends.

*Cell-wall and Cell-contents.*—In the mucus cells above mentioned, and in many other cells, two kinds of formed material are produced from the original germinal matter; these are spoken of as the cell-wall, and the peculiar matter found inclosed in it, the *cell-contents*. For instance, in the starch-containing cell of the potato, the cell-wall is formed around and invests the germinal matter, while the starch is deposited as small insoluble particles in the very substance of the germinal matter. So that by the death of particles on the surface of the cell-wall the *cellulose* cell-wall is produced, while by the death of some of the particles further inwards, and therefore under different conditions, *starch* is formed. This outer part of the germinal matter, which eventually lies between the starch grains on the inside and the cell wall on the outside, is known as the “primordial utricle” of the vegetable cell. Fat-cells or adipose vesicles are formed in precisely the same way; fat may, moreover, be deposited amongst the germinal matter of other cells, such as the cartilage or nerve cell.

*Of the so-called Intercellular Substance.*—In cartilage, tendon, and some other tissues there is no line of separation between the portions of formed material which belong to each respective mass of germinal matter; and hence it has been supposed that these tissues were developed in a different way to the epithelial structures. A “cell,” or elementary part of adult cartilage or tendon, merely differs from the epithelial cells, spoken of above, in not having a distinct margin around its own particular formed material, and if a line were drawn midway between the various germinal masses, it would roughly mark out

the point to which the formed material corresponding to each extended; and each cell would then be exactly analogous to the mucous-forming cells. In all of these cells, of mucous membrane, tendon, cartilage, muscle, &c., there is no abrupt demarcation between the germinal matter and the formed material, but the one passes gradually into the other. All living cells consist of matter in these two different states; the one being an active condition, *vital*; the other merely passive, in which no *vital* actions are exhibited: upon matter in this first state, all growth, multiplication, conversion, all *life* depends; while in the second condition, matter may exhibit many very peculiar properties, but it does not grow or multiply, or convert or form; in short, it does not *live*, though it may increase by new matter being superadded to it.

*Of the Nucleus and Nucleolus.*—A mass of germinal matter, besides increasing in quantity, may divide into several, and thus cell-multiplication may occur; and in all cases it is to be observed that this multiplication is *not* due to a “growing-in,” or constriction of the cell-wall or formed material, but entirely to changes occurring in the germinal matter. In many cases a smaller spherical mass may be observed in the centre of the germinal mass, which often divides before the parent mass itself does; but it is by no means a necessary part of the process, for division as often takes place where no such bodies are to be seen; and it frequently happens that these small bodies may make their appearance only after the division of the original mass. And again, within these, other still smaller ones are sometimes produced. The former are termed *nuclei*, the latter *nucleoli*. These are to be regarded as but new living centres appearing in centres already pre-existing, and may perhaps mark the commencement of a set of changes differing in some minor particulars from the first that have occurred. But although both *nuclei* and *nucleoli* are germinal or living matter, they are not undergoing conversion into formed material. *Nuclei* do not always exhibit their vital powers, but under certain circumstances they may do so, and then they exhibit the characters of ordinary germinal matter; they absorb pabulum and increase in size, and the original germinal matter

becomes changed into formed material, while fresh nuclei and nucleoli are developed. And so far from nuclei being formed first, and the other elements of the cell deposited around them, they always make their appearance in the substance of pre-existing matter, and have neither a different constitution to ordinary germinal matter, nor perform any special function.

*Of the Increase of Cells.*—Several distinct modes of cell-multiplication have been described, but in all cases the germinal matter divides, and is the only material actively concerned in the process; which may, however, take place in different ways.

1. The parent mass may simply divide into two equal parts, apparently in obedience to a tendency of the portions to move away from each other as soon as the original mass has reached a certain size.

2. The parent mass may divide in three, four, or more equal portions.

3. From every part of the parent mass protrusions may occur, each of which, when detached, absorbs nutrient matter, and soon attains the same size as its parent. During these processes of increase and multiplication, the formed material is perfectly passive, and when a septum or partition exists, it does not result from a "growing-in" of this dead structure, but is produced by the conversion of part of the germinal matter into a thin layer of formed material.

*Of the Changes of the Cell in Disease.*—If the conditions under which cells ordinarily live be modified beyond a certain extent, a morbid change may result. For instance, if cells, which normally grow slowly, be supplied with an excess of nutrient pabulum, they grow—that is, convert certain of the constituents of the pabulum that come into contact with them into matter like themselves—at an increased rate. In this way the inflammatory product *pus* results. "*The abnormal pus-corpuscle may be produced from the germinal or living matter of a normal epithelial cell, the germinal matter of which has been supplied with pabulum much more freely than in the normal state.*" In cells in which the access of nutrient pabulum is more restricted than in the abnormal state, as in normal cells

passing from the embryonic to the adult state, the outer part of the germinal matter undergoes conversion into formed material, which increases as the supply of pabulum becomes reduced.

Dr. Beale, in short, considers that "all formed matter results from changes in the germinal matter, and that the action of the cell really consists in a change from the living to the lifeless state of the matter of which it is composed; and that the products formed by the cell do not depend upon any metabolic action exerted by the cell-wall or nucleus upon the pabulum, nor are they simply separated from, or deposited by, the blood." And he looks upon the "living cell" as a minute body, consisting partly of living matter influenced by vital force, and partly of lifeless matter resulting from the death of the first, in which chemical and physical changes occur, which may be modified by the influence of surrounding substances and external forces.

In pursuing the subject of cell development, we shall proceed by the aid of our old lights in this intricate path of physiological science. And it is only right that we should add, that the views we have endeavoured to place fairly before our readers have not been unhesitatingly accepted, but, on the contrary, those of the German school are greatly preferred by many physiologists.

*Change of Cells into Tissues.*—This may take place by a joining together or coalescence of cells in a rudimentary state. Cells may meet, and at the point of contact coalesce and run into each other, thus forming a tube; indeed, in this manner minute tubular structures are formed. Another mode is: cells aggregate into a mass, and at the point of contact run into each other, thus producing a multilocular cavity; No. 9, fig. 300. Glandular structures are formed in this way. Membrane is formed of a deposit from the cytoblastema; before the cell-membrane is formed, the substance from the cytoblastema coalesces with those particles close at hand, thus forming a delicate film-like membrane. This membrane Professor T. Wharton Jones calls endosmotic, retentive membrane. We have the cells coalescing to form a filament or fibre. The nucleus may disappear, or form another structure; and where



regeneration of tissue is proceeding, there is found a larger number of granules.

According to some histologists, cells may be formed in cytoblastema independent of any pre-existing cells; this is cited as an instance of that mysterious agency designated *spontaneous generation*. There are cells which, so far as we know, after full development, undergo no further metamorphosis; such as those of the epithelium, the blood corpuscles, &c.

As an instance where previously-existing cells exert an influence on those about to be formed, we may adduce a fractured bone, between the ends of which osseous matter is deposited. We infer from this, that the substance of the bone determines, as it were, the formation of other cells, first into cartilage, and then into bone. Generally, however, where a part has to be repaired, it does not seem to determine the generation of a texture similar to itself—for example, muscle and skin. We have an exception to the last observation in the case of nerves, which if cut across, a substance is formed between the ends which transmits the nervous influence, but the ends must not be separated to any great distance, or this will not occur. The same remark applies to bone. There may be a single layer of cells so arranged side by side, and presenting a columnar or basaltic form; this arrangement is seen in the cells of the intestinal tract, fig. 303 *a*. Another change of cell is this: they shoot out processes from certain parts of them, as seen in fig. 300, Nos. 10, 11; this kind of formation occurs on the inner surface of the sclerotic coat of the eye. The cylindrical form of cell is found with delicate processes shooting out from the broad end; these are called ciliated, fig. 303 *d*, and the cilia having a vibratile motion urge on the secretions of the part in a particular direction.

In some cases the walls of the cell increase in thickness (fig. 300, No. 5). Under the microscope, some cells appear to be composed of concentric laminæ. In plants this is the common mode of increase in the thickness of the cell, but the deposit does not take place entirely around, but only here and there, so that vacant spaces are left which form canals, and may become branched:

these canals are named pore-canals (fig. 300, No. 6). They do not perforate the outer layers; consequently the blind ends seen through the outer membrane, and which were supposed to be apertures, are nothing of the kind. Henle believes he has found canals in cells in animals similar to those in vegetables—in the cartilage of the epiglottis, for instance. In other instances, cells may be aggregated, like a bunch of raisins, and the parts in contact with each other disappear, so constituting a multilocular cavity: examples of this are seen in the racemose glands (fig. 300, No. 9). Schwann conjectures another mode of coalescence. From cells formed as usual, processes sprout out; but this change takes place at the expense of the cell-membrane itself, and when it has gone on to some extent, we have the appearance of a net-work formed (fig. 300, No. 11, and 12). Capillary vessels are formed in this way. Cells, we thus perceive, coalesce to form tissues, when they have not attained their full growth as such; or when they have been fully formed they become flattened, and assume the solid form. Deposits of matter may take place from the cytoblastema with similar adjoining substance, constituting a delicate membrane, with here and there nuclei, as in the capsule of the lens, the membrane of the aqueous humour of the eye, or sheath of the primitive fasciculus of muscle; or the cells may coalesce in the linear series, to form fibre.

*Development of Complicated Cells.*—Here the nucleated cell is surrounded by a deposit, and that again surrounded so as to constitute a membrane; so that the nucleated cell may be looked upon as the nucleus to the cell so formed (fig. 300, Nos. 13 and 14). Sometimes the nucleus undergoes important changes in the development of tissues, as well as the cell itself. In some cases, where the cells have joined in the linear series, the nucleus becomes oval, elongated, so that the nucleus of one cell tends to meet the nucleus of another cell; they subsequently coalesce, and thus fibre is said to be formed.

*Action of Cells.*—The subsequent changes of the cell depend in a great degree on endosmosis, or diffusion. The nature of the membrane is a necessary condition, for it

determines the way in which the stream should pass; and we find in general that the current is from the rarer to the denser fluid. If we immerse a porous tube half filled with a strong solution of common salt in a jar of water, we notice that the level of the fluid inside the tube rapidly rises above the outside, while the water becomes slightly salt to the taste. It is not a constant circumstance that the stream is from the rarer to the denser fluid; with alcohol and water, for instance, the stream is from the latter to the former. Mineral substances, even pipeclay and chalk, permit of endosmosis in a low degree. In glands, the cells, being filled with their peculiar fluid, are conveyed to the wall of the intercellular passage, and through this the secretion arrives at the surface of the body.

*The Epithelium.*—If we cut very thin slices from the superficial portions of the skin, we can raise from it a delicate membrane; or, what is better, by using chemical or mechanical irritation, we obtain what is ordinarily called a blister; to it we give the name of *epidermis*. The microscope has shown this to be a tissue of high and remarkable organisation; being, in point of fact, an aggregation of cells, differing, in different situations, in regard to form, colour, and composition. These laminated elementary cells, found on the surfaces, have generally nuclei. The form of the nucleus is rounded or oval, and is the 1-3000th to 1-5000th of an inch in diameter. Each nucleus has two or three nucleoli, with outlines more or less irregular. The epithelium cells may be divided into three kinds: the 1st is termed the tessellated or pavement; 2d, the columnar or basaltic; 3d, the ciliated or vibratile epithelium.



Fig 301.—A section of the Epidermis.

Some make a 4th, combining the tessellated and the columnar: this may be considered as transition epithelium, and is found only in certain mucous passages. These various cells are represented in fig. 303, *a*, *b*, *c*, and *d*.

Tessellated epithelium is the simplest form, and, as its name implies, resembles flags of pavement, overlapping each other at their edges. They assume, more or less, the polygonal form, and their size varies in the different membranes. The cells of the pericardium, or covering membrane of the heart, are much smaller

than those of the covering membrane of the lungs, &c. On some surfaces we have many layers—in the skin, for instance; if a vertical section of such be made, and viewed under the microscope, it will be seen to be composed of numberless layers, shown in fig. 304. The skin taken from the sole of the foot, in consequence of the continued pressure there

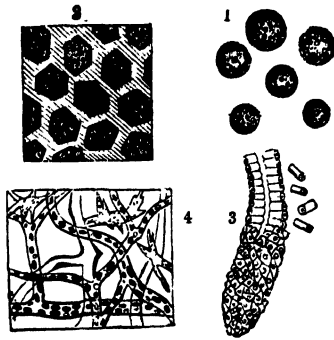

Fig. 302.

1, Simple isolated cells containing reproductive granules. 2, Mucous membrane of stomach, showing nucleated cells. 3, One of the tubular follicles from a pig's stomach. 4, Section of a lymphatic, magnified 50 diameters.

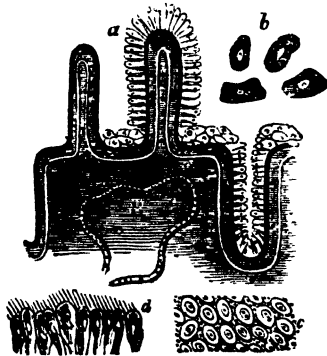

Fig. 303. (1)

(1) *a* is a diagram of a portion of the involuted mucous membrane, showing the continuation of its elements in the follicles and villi, with a nerve entering its submucous tissue. The upper surface of one villus is seen covered with cylindrical epithelium; the other is denuded, and with the dark line of basement membrane only running round it; *b*, pavement epithelium scales, separated and magnified 300 diameters; in the centre of each is a nucleus, with a smaller spot in its interior, called the *nucleoli*. *c*, pavement epithelium scales, from the mucous membrane of the bronchial or air tubes of the lung; *d* represents another form of epithelium, termed the *vibratile* or *ciliated*; the nuclei are visible, with cilia at their upper or free surfaces, magnified 250 diameters.

experienced, presents a distinctly stratified appearance. These layers of cells are held together by intercellular substance, which exists in quantities; if the epithelium be taken from these membranes it is more easily seen, because the cells are not so closely aggregated together as in the skin; therefore a piece of epithelium from the mouth is recommended for display under the microscope, and by the addition of a drop of the solution of iodine the cells are much better seen. The cells from serous and mucous membranes are acted upon by acetic acid, and dissolved if the acid be of considerable strength: but if the acid be weaker, the cells swell up. Cells are not affected by alcohol, ether, ammonia, or its salts; but they are dissolved by caustic potash, which also dissolves the intercellular substance.

*Columnar or Cylindrical Epithelium*, Fig. 303, *a*.—The nucleus is generally better seen than in the former kind of cells, although formed from them. If we examine a portion sideways, it resembles those at *d*, the upper part being broader, and the nucleus being midway between the two extremities. When the cells of the cylindrical epithelium are closely aggregated together, they become compressed into the prismatic form; when they are less so, the rounded shape prevails. Consequently, when we take a bird's-eye view of them, from above or below, they appear like the pavement epithelium, at *c*, and thus error might creep in; but we must become fully satisfied by examining them sideways, and with various reagents. Their chemical composition is the same, and the cells dissolve in strong acetic acid. As examples of the situations in which this form of epithelium is found, we may instance the intestinal tract along the ducts of the glands, as the liver, &c.

In no situations do we find these two kinds of epithelium terminating abruptly the one in the other; but there is a gradual change of the one kind into that of the adjoining; for example, where the tessellated epithelium is gradually supplanted by the cylindrical, as it passes from the oesophagus to line the interior of the stomach; it is then termed *transition* epithelium.

*Ciliated Epithelium*, Fig. 303, *d*.—The cells do not differ materially from those of the cylindrical; the great distinction between the two is, that in the former there are no

cilia attached to the broad end. Examples of the situations in which these are found are, investing membrane of the respiratory passages, upper part of the pharynx, larynx, bronchi, and the lateral ventricles of the brain, &c.

Epithelium is found to grow from the surface of the cutis outwards—in most places it is constantly growing outwards, and as continually being thrown off from the surface: it must at the same time be remembered, that though the epithelium is in close contact with the cutis, or true skin, it is not a deposit from it, but derives only its materials of formation and nourishment from it.

The epidermis is destitute of sensibility, yet it invests very sensitive parts: it is not vascular, but invests very vascular parts. Its exfoliation takes place regularly, as may be exemplified in reptiles and the *Batrachia*, who throw off their skin: the moulting of birds is analogous. In the early periods of life in the human subject, exfoliation takes place from the surface of the skin; from the mouth the morsel of food is always mixed with detached cells. In the process of digestion the same thing occurs—in fact, it is only when the epithelium cells are thrown off that the gastric juice is secreted by the tubes of the stomach.

*Cilia.*—The most remarkable circumstance in connexion with cells is the movement of their cilia. There are three ways in which the cilia ordinarily move—the rotatory, the undulatory, and the wavy, like a field of wheat set in motion by a steady breeze. No satisfactory explanation has been given of the cause of this vibratile motion. The current produced by them is from within outwards, in most places; in the respiratory passages, on the contrary, it is from without inwards. In the Frog's mouth, it takes the same course. The ciliary motion may be seen in the kidney of the Frog or Newt; the cilia in the latter continue in active motion for some minutes after the animal is dead. Make a very thin section of the kidney with a sharp knife, and take care to disturb the structure as little as possible; then moisten it with a little of the serum of the animal, place it in a glass cell, and cover with thin glass and a magnifying power of 250 diameters.

*Pigment.*—Pigment granules are found in greater or less quantities in the skin and bodies of white and dark

rices. In the eye there is pigment, and it affords a good example of nucleated cells, in which are contained the pigment particles, fig. 304. These are placed there for an optical purpose, that of absorbing the rays of light. In the peculiar

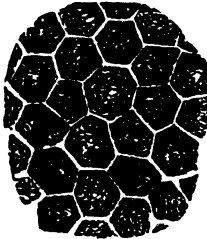

Fig. 304.—Pigment cells from the eye.



Fig. 305.—A single Hair, seen near its bulb.

colouration found in the eyes of some animals, called *Tapetum lucidum*, the colour is not owing to the pigment particles, but to the interference of the light: it is reflected from it, as in mother-of-pearl, coloured feathers, scales of fishes, &c. The colour of the skin is owing to the granular contents of the pigment cells; these are like ordinary elementary granules, with the addition of colour; and this latter may be removed by the action of chlorine.

*The Nails* are appendages to the epidermis, and present a mould of the cutis beneath; from the cutis the materials are furnished for the formation and growth of the nail. Like the epidermis, the nail is stratified, the markings are parallel to the surface, and the appearance is produced by the coalescence of the cells and their lying over each other. See Plate VII., No. 149, toe of mouse. The stratified arrangement when a section is examined by polarised light, presents the appearance seen in the processes of the cat's tongue. Plate VIII. No. 174.

*Hairs*, however much they may differ in form, are more or less flattened out scales. A hair is divided into a body or shaft, and a root which is in the skin (fig. 305). The shaft is again divided into two parts: the external is termed the cortical portion, and the internal the medullary

portion; the latter does not usually exist in the whole length of the shaft. The cortical part consists of fibres,



Fig. 306.

1, Transverse section of human hair, showing the internal of medullary substance. 2 Longitudinal section, showing the fibrous character of the same pigment or colouring matter, and serrated edges.

arranged parallel to each other: besides these there are, on the exterior, minute epithelial scales, which are arranged like the tiles on a house, producing the appearance of transverse markings. The fibres gradually expand out,

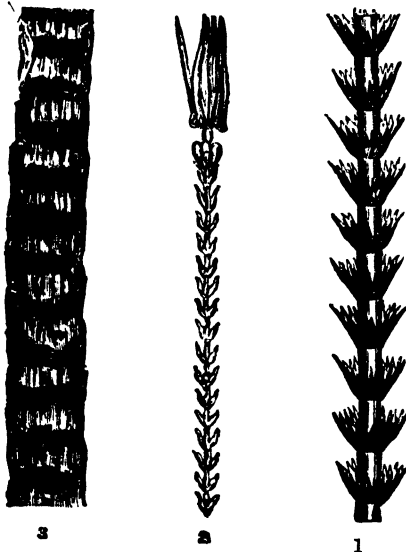

Fig. 307.

Hair from the Indian Bat, magnified 500 diameters. 2, Hair supposed to belong to (*Desmestes?*) *Anthrenus*, magnified 250 diameters. 3, Hair from the Mouse, magnified 250 diameters.



forming a wall to the bulb enclosed in its capsule. The development of a hair commences at the bottom of the follicle, and by the aggregation of successive cytoblasts, or new cells, are gradually protruded from the follicle, both by the elongation of its constituent cells, and by the addition of new layers of these to its base; the apex and shaft of hair being formed before the bulb, just as the crown of a tooth is before its fang. The cytoblasts are round and loose at the base of the hair, but are more compressed and elongated in the shaft; and by this rectilinear arrangement the hair assumes a fibrous appearance. Of sixteen species of the Bat tribe, the hairs of which were examined by the late Professor Quekett, all were analogous in structure; and the diversity of surfaces which these hairs present are in reality owing to the development of scales on their exterior. By submitting hairs to a scraping process, these minute scale-like bodies, tolerably constant as regards their size and figure, can be procured; so that Bats' hair may be said to consist of a shaft invested with scales, which are developed to a greater or less degree, and varying in their mode of arrangement in the different species of the animal; that part of the hair nearest the bulb is nearly free from scales, but as we proceed toward the apex the scaly character becomes evident. Many of the scales are not unlike those procured from the wings of butterflies, but, being very much smaller, exhibit no trace of striæ on their surfaces; those taken from dark-coloured hairs have colouring-matter deposited on them in small patches. In some cases they appear to terminate in a pointed process; in others the free margin is serrated. By



of Pecari, showing its fibrous and cellular structure.

scraping, many of them will be detached separately; but in some few cases, as many as four or five will be found joined together: in the larger hairs, the cellular structure of the interior, as well as the fibrous character of the shaft, are better seen after the have been removed.

The hair owes the greater part of its colour to *pigment-*

*cells*: as these decay, and become gradually divested of their colouring-matter, they appear whitened, or "turn grey." These hexagonal cells also give colour to the skin of the negro, and are situated immediately beneath the transparent coat. A small portion is shown in fig. 309, the vacant space denoting the situation of a lost hair.

Certain parts of the skin and mucous membranes are especially supplied with papillæ, which serve as organs of touch; throughout the greater part of the skin there are *papillæ* more or less sensitive, but only at the extremities of the fingers, lips, and in a few other situations, are these highly developed, as in fig. 310. Papillæ are either filiform or tubiform, and have entering into them nerves and blood-vessels; the former supplying the sensibility of the skin, and terminating in loops, as shown in fig. 310. Papillæ injected are shown in Plate VII. No. 150, tongue of mouse; villi from small intestine of rat, No. 154.

The skin is the seat of two processes in particular; one of which is destined to free the blood from a large quantity of fluid, and the other to draw off a considerable amount of solid matter. To effect these processes we meet with two distinct classes of glandulæ in its substance: the sudoriferous, or sweat glands; and the sebaceous, or oil glands. They are both formed, however, upon the same simple plan, and can frequently be distinguished only by the nature of their secreted product. The oil-glands of the skin are

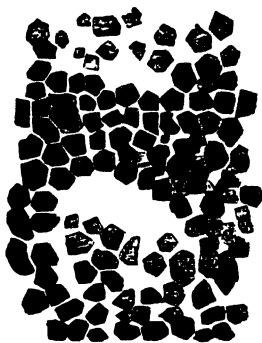

Fig. 309.—Pigment Cells from the skin.



Fig. 310.—A section of skin from the finger, showing the vascular network of papillæ, at the surface of the cutis.

similar in structure to the perspiratory ducts, being composed of three layers derived respectively from the scarf-skin, which lines their interior; the sensitive skin, which is the medium of distribution for the vessels and nerves; and the corium, with its fibres giving them strength and support. Like the sudoriferous ducts, they are in some situations spiral;

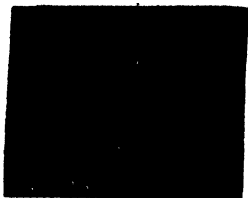

Fig. 311 — Capillary network and distribution of papillæ over the tongue.

but this is not a constant feature; more frequently they pass directly to their destination; they are also larger, as shown in fig. 312, proceeding from the oil or fat vesicle



Fig. 312 — Distribution of the tactile nerves at the extremity of the fingers, as seen in a thin perpendicular section of the skin.

situated at its lower extremity. Oil glands are freely distributed to some parts, whilst in others they are entirely absent: in a few situations they are worthy of particular notice, as in the eyelids, where they possess great elegance of distribution and form, and open by minute pores along the edges of the lids; in the ear-passages, where they produce that amber-coloured substance known as the wax of the ears; and in the scalp, where they resemble small clusters of grapes, and open in pairs into the sheath of the hair, supplying it with a pomade of Nature's own preparing.

*Internal parts of the body.*—We shall now have under consideration cells of a much higher order than any before referred to; the cell found floating in the animal fluids is known as the blood-cell, and requires a vascular system of its own for distribution over the whole animal body. The red blood cells, or corpuscles, have a circular form, somewhat flattened; their size is about 1-3,200th of an inch in diameter. It is well known that the blood-cor-

puscles, when floating in their own serum, or after having been treated with acetic acid or water, appear to be furnished with perfectly plain coverings, composed of a simple homogeneous membrane, without distinction of parts. But, when the blood is treated with a solution of magenta (nitrate of rosanilin) or with a dilute solution of tannin, the corpuscles present changes which seem irreconcilable with such a proposition. Dr. W. Roberts, of Manchester, communicated an account of his observations on this subject to

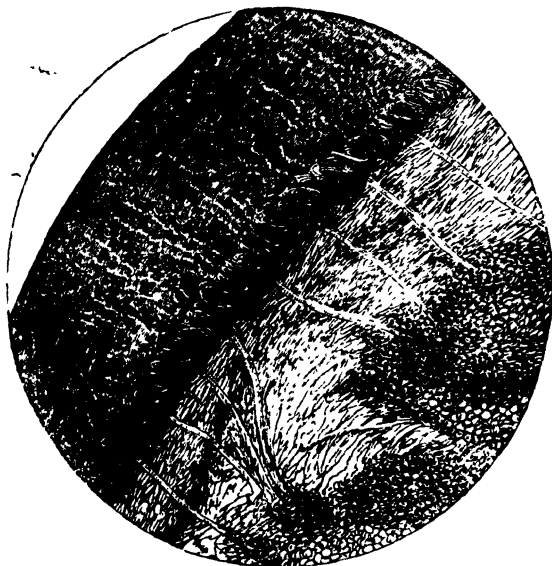

Fig. 313.—A vertical section of the Human Skin, showing the sweat-glands, surrounded by fat-globules, the ducts passing upwards through the epithelial layer to the epidermis or external cuticle, magnified 250 diameters.

the Royal Society (*Proc. Roy. Soc.* vol. xii. p. 481), in which he shows that nearly every disc possessed a parietal macula, capable of being stained by a dye. It was commonly of a lenticular shape, but sometimes square, and as a rule very minute, not covering more than 1-20th or 1-30th of the circumference. Moreover, in the blood of many of

the lower animals a similar tinted particle appeared when the corpuscles were treated with magenta. The conclusion to be drawn from this and other observations noted by Dr. Roberts, is that a duplication at one, or at most at two points only, is indicated by direct proof; but certain appearances occasionally observed favour the notion of a complete duplication.

The wall of the cell is a transparent structureless membrane, and is of greater thickness than we find the analogous membrane of cells to be generally. The red corpuscles of birds, reptiles, &c. possess a distinct nucleus; but, on examining those of the human subject and other *Mammalia*, no distinct nucleus can be made out. By applying dilute acetic acid, the red corpuscle becomes bleached, and its walls distended, but no nucleus appears. If a red corpuscle from the Frog be treated in the same manner, we see a nucleus, and the red colouring matter is drawn out by exosmosis. Water causes the corpuscle to swell up, and the colouring-matter disappears, but its real nature is masked; upon employing a drop of solution of iodine, the wall is coloured or tinged, and made distinct. The cells themselves have a tendency to undergo spontaneously certain changes, one of the most common is a wrinkling up of the walls, with a surface somewhat like that of a mulberry; this may also be produced by mechanical pressure, the addition of oil, &c.

There is another set of corpuscles, slightly larger than the red set; these are termed *colourless corpuscles*, which, when distended by the action of water, are seen as nucleated cells, whose diameter is about the 1-2,500th of an inch, and a double contour of the walls is observed; sometimes there is a slight tinge of colour to be seen in the nucleus. There is a third kind of corpuscles in the blood, more numerous than those above referred to, but of about the same diameter; when distended, they are seen to be cells filled with granular matter; sometimes a clear spot is noticed on one side; very dilute acetic acid being applied, the granules are dissolved out, and a clear central nucleus remains, if the acid be used stronger, an appearance is seen as if there were several nuclei aggregated together. This latter appearance was considered to be the natural

state of the nucleus, the particles of which were either tending to unite with one another, or there was a separation of the nucleus into several smaller portions. Wharton Jones, however, says there is no subdivision of the nucleus.

If we examine a drop of blood under the microscope,

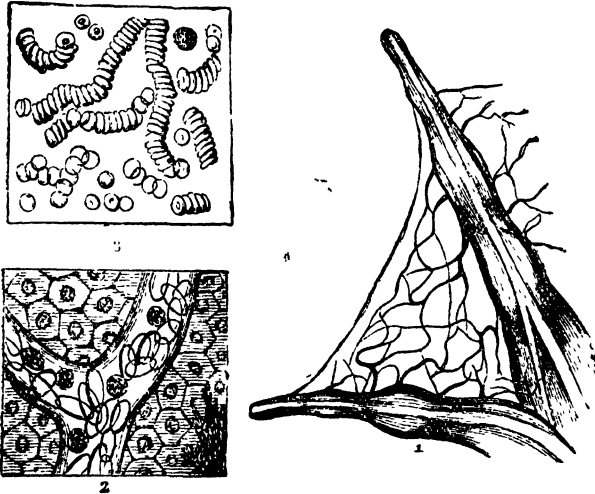

Fig. 314.

1 A portion of the web of a Frog's foot, spread out and slightly magnified to show the distribution of the blood-vessels 2, A portion magnified 250 diameters, showing the ovoid form of the blood-discs in the vessel, beneath which a layer of hexagonal nucleated epithelium-cells appear 3, Human blood discs, as they appear when fresh drawn (magnified 250 diameters).

the corpuscles aggregate themselves together like rolls of coins, fig. 314, No. 3, presenting a kind of network so long as they remain suspended in their *liquor sanguinis*. After the lapse of a few minutes, the fibrin, from its elasticity, contracts more and more, and a yellow fluid, called serum, is pressed out,—or, in other words, the components of the *liquor sanguinis*, with exception of the fibrin,—and only a shrunken, jelly-like mass remains.

The blood-corpuscles of the lower animals Mr. Gulliver has especially studied. In the blood-corpuscles of birds,

and animals below them, there are nuclei ; but the cells, instead of being circular, as in the human subject, are elliptical, and larger. The corpuscles in *Mammalia* in general are like those of man in form and size, being a little larger or smaller. The most marked exception is in the blood of the Musk-deer, in which the corpuscles are of extreme smallness, about the 1-12,000th of an inch in diameter. The Elephant has the largest, which are about 1-2,000th of an inch in diameter. The Goat, of all common animals, has very small corpuscles ; but they are, withal, twice as large as those of the Musk-deer. Another exception in regard to form is in the Camel tribe, where they are oval, and resemble those of the oviparous *Vertebrata*, as the Frog, shown in fig. 314, No. 2. In the *Menobranthus lateralis*, they are of a much larger size than in any animal, being the 1-350th of an inch ; in the Proteus, the 1-400th of an inch in the longest diameter ; in the Salamander, or Water-newt, 1-600th ; in the Frog, 1-900th ; Lizards, 1-1,400th ; in Birds, 1-1,700th ; and in Man, the 1-3,200th of an inch. Of Fishes, the cartilaginous have the largest corpuscles ; in the Gold-fish, they are about the 1-1,700th of an inch in their longest diameter.

The large size of the blood-discs in reptiles, especially in the *Batrachia*, has been of great service to the physiologist, by enabling him to ascertain many particulars regarding their structure which could not have been otherwise determined with certainty. The value of the spectroscope in the chemical examination of the blood has been already pointed out in our remarks on the application of this instrument to the microscope. See page 119.

An interesting subject to Physiologists has been noticed— the production from the blood, under certain conditions, of red albuminous crystals,—which, although formed from animal matter, and sometimes, in all probability, during life, have the same regular forms as inorganic crystals. Virchow was the first who paid particular attention to their actual nature, and proved them to differ from saline or earthy crystals. If we add water to a drop of blood spread out under the object-glass of the microscope, as the drop is beginning to dry up, the edges of the heaps of blood-corpuscles are seen to undergo a sudden change : a few

corpuscles disappear, others have dark thick edges, become angular and elongated, and are extended into small well-defined rodlets. In this manner an enormous quantity of crystals are formed, which are too small to enable us to determine their shape; they rapidly move lengthways, the entire field of vision being gradually covered by a dense network of acicular crystals, crossing one another in every direction, with other crystals presenting a rhomboid form.

Dr. Garrod discovered, that by a slow evaporation of portions of the serum of blood taken from patients labouring under gout, he could obtain strings of crystals of uric acid. His mode of procedure is to pour a little serum into a watch-glass, and add a few drops of acetic acid; in this mixture place a few very fine filaments of silk or tow, and stand it by for twenty-four hours under a glass-shade. Upon removing the glass and submitting the filaments to microscopical examination, they are found studded with minute crystals.

A peculiar fatty matter was discovered by Virchow in the tissues of the human body and in certain nerves which he termed *Myelin*. In the liver it exists in large quantities, and much is found in the yolk of the egg. It is colourless, glistening, semi-fluid, prone to form drops, and capable of being drawn out into long threads, which curve and twist into very peculiar forms. The masses often exhibit double contours, or many lines are observed equi-distant from one another and varying in thickness. Cholesterin is a component of all forms of myelin; Beneke has, in fact, shown that it is a mechanical mixture of *cholesterin* and *cholate* of *lipyl*. No. 1, fig. 314,

the foot of the Frog, when stretched out, shows the distribution of the blood-vessels in the web: the two sets of vessels—the arteries and veins—are very readily made out when kept steadily on the stage of the microscope; the rhythm and valvular action of the latter may be observed, although they are much better seen in the ear

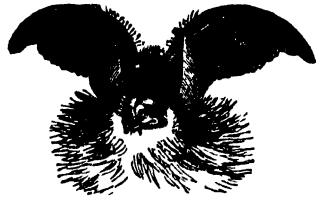

Fig. 315.—Head of Long-eared Bat.  
(*Plecotus Auritus*.)



or wing of the Long-eared Bat, as Professor Wharton Jones pointed out.

To view the circulation of blood in the Frog's foot, the older microscopists, Baker, Adams, and others, were in the habit of tying the frog to a frame of brass; at the present time the entire body of the animal, with the exception of the foot about to be examined, is secured in a black silk bag, and this is fastened to a plate, termed the frog-plate, shown at *a a a* in fig. 316. The bag provided should

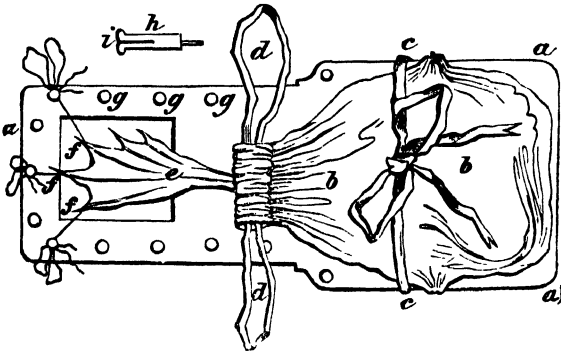

Fig. 316.

be from three to four inches in length, and two and a half inches broad, shown at *b b*, having a piece of tape, *c c*, sewn to each side, about midway between the mouth and the bottom; and the mouth itself capable of being closed by a drawing-in string, *d d*. Into this bag the frog is placed, and only the leg which is about to be examined kept outside; the string *d d* must then be drawn sufficiently tight around the small part of the leg to prevent the foot from being pulled into the bag, but not to stop the circulation; three short pieces of thread, *f f f*, are now passed around the three principal toes; and the bag with the frog must be fastened to the plate *a a* by means of the tapes *c c*. When this is accomplished, the threads *f f f* are passed either through some of the holes in the edge of the plate, three of which are shown at *g g g*, in order to keep the web open; or, what answers better, in a series

of pegs of the shape represented by *h*, each having a slit *i* extending more than half-way down it; the threads are wound round these two or three times, and then the end is secured by putting it into the slit *i*. The plate is now ready to be adapted to the stage of the microscope: the square hole upon which the foot must be placed is brought over the aperture in the stage through which the light passes to the object-glass, so that the web may be strongly illuminated by the mirror.

The circulation of the Tadpole is best seen by placing the creature on its back, when we immediately observe the beating heart, a bulbous-looking cavity, formed of the most delicate, transparent tissues, through which are seen the globules of the blood, perpetually, but alternately, entering by one orifice and leaving it by another. The heart is enclosed within an envelope or pericardium; and this is, perhaps, the most delicate and certainly the most elegant thing in the creature's organism. Its extreme fineness makes it often elude the eye under the single microscope, but under the binocular its form is distinctly revealed. Passing along the course of the great blood-vessels to the right and left of the heart, the eye is arrested by a large oval body, of a more complicated structure. This is the inner gill, which, in the tadpole, is formed of delicate, transparent tissue, traversed by arteries, and presenting a crimson network of blood-vessels.

The Tadpole is hatched with respiratory and circulatory organs resembling those of the fish. It lives in, and breathes oxygen from the air contained in, the water, and during the early period of its existence respire exclusively by gills.

It will be remembered that in nearly all fish the heart has but two cavities, an auricle and ventricle; that the blood of the latter is returned by the veins to the auricle, passes into the ventricle, is then transmitted to the gills, where, being exposed to the air contained in the water, it becomes deprived of carbonic acid, aerated, and rendered fit for re-circulation through the system. In the reptile we find a modification of plan. The heart has three cavities, two auricles and one ventricle; by this contrivance there is a perpetual mixture in the heart of the impure car-

oxygenated blood which has already circulated through the body, and flows into the ventricle from the *right* auricle, with the pure aerated blood returned from the lungs, and which also flows at the same instant into the ventricle from the *left* auricle. Thus the habitual circulation of this "cold-blooded" mixture is the cause of the low tone of vitality that distinguishes reptiles.

For the purpose of observation the tadpole must, of course, be selected during the period in which the skin is perfectly transparent. The first examinations reveal plainly enough the appearances already described of the form and situation of the heart, and the three great arterial trunks proceeding (right and left) from it. Many observations are required to arrive at the true anatomical arrangement of these vessels. First, they are closely connected with the corresponding gill. The upper one (the *cephalic*) runs along the upper edge of the gill, and gives off, in its course, a branch which ascends to the mouth, which, with its accompanying vein, is termed the *labial* artery and vein. The cephalic artery continues its course around the gill, until it suddenly curves upwards and backwards, and reaches the upper surface of the head, where it dips between the eye and the brain, towards which it is evidently travelling.

It would be a mistake to suppose that you can make this out distinctly, in the average of tadpoles taken, without some preparation. The great obstacle is the large coil of intestines, usually distended with dark-coloured food. This must be got rid of by making your tadpoles live on plain water for some days. Plate VII. No. 158, exhibits the view of the vessels obtained under the influence of low diet, and we are now enabled to trace the course of the three large arteries. The *third* trunk, traversing the lung, is seen to emerge from the lower edge and descend into the abdomen to form the great abdominal aorta. A small black-looking starved little tadpole shows the heart beating and the blood circulating, but the latter is quite *colourless*, not a single red globule visible anywhere. The globules chase one another away like globules of water, the heart is a colourless globe, the gills two transparent ovals, and the bowels a colourless,

transparent coil. Through the empty coil the artery is seen on each side descending from the gills, converging to the spine, meeting its fellow, and with it uniting to form the abdominal aorta, the large central vessel coloured red in the figure. After the aorta has supplied the abdominal viscera, a prolongation, or *caudal* artery is seen descending to the tail, the all-important organ of locomotion in the tadpole. This artery, entering the root of the tail, is imbedded deeply in the flesh, whence it emerges, and then continues its course, closely accompanied by the vein, to within a short distance of the tail's extremity, where, being reduced to a state of extreme fineness, it terminates in a capillary loop, which is composed of the end of the artery and the beginning of the vein. The artery, in its course, gives off branches continually to supply the neighbouring tissue. We may often observe that the blood current in the tail, even in the main artery or vein, is sluggish or even still. This occurs independently of the heart, which may continue to beat as usual; it happens, because the circulation in the tail depends very much on the motion of the organ. When this is suspended (as in confining the tadpole under the microscope), the blood moves sluggishly, or stops, till the tail regains its freedom and motion, when the activity of the current is restored. This fact is thus alluded to by Dr. Grant:—"It is the restless activity of the worm and of the insect that makes every fibre of their body, as it were, a heart to propel their blood and circulate their fluids, while the slow-creeping snail that feeds upon the turf has a heart as complicated as that of the red-blooded, vertebrated fish, that bounds with such velocity through the deep. It is because the fish is muscular and active in every point that it requires no more heart than a snail to keep up the necessary movements of its blood."

Having traced the arterial system, which conveys the blood from the heart to the extremities, we will now note its return by the veins back again to the heart.

The caudal vein runs near to the artery during the greater part of its course, with its stream, of course, *towards* the heart. This stream is swollen by perpetual tributaries from vessels so numerous that their loops form a network which

covers the entire surface of the tail. As the vein approaches the root of the tail it lies superficially to the artery, and diverges from it at the point of entering the abdomen. Here it approaches the kidneys, sends off branches to them, while the main trunk continues its course onward; and, passing upwards behind a coil of intestine, it approaches the liver, and runs in a curved course along the margin of that organ. This blood is seen to enter the *vena cava* by numerous fine channels, which converge towards the great vein as it passes in close proximity to the organ. Beyond the liver the *vena cava* continues its course upwards and inwards to its termination in the *sinus venosus* or rudimentary auricle of the heart. This termination is the junction of not less than six distinct venous trunks, incessantly pouring their blood into the heart. The circulation in the fringed lips forms a most complicated network of vessels, out of which proceeds a vein corresponding to the artery already traced. This descends in a direct course till it joins the principal vein of the head, which corresponds to our own *jugular*.

Thus we have traced the blood through its main channels, and completed the circle of its course.

The blood is driven by the heart into each inner gill through three large blood-vessels, which arise directly from the *truncus arteriosus*, and may be called the *afferent vessels of the gill*. (See enlarged view of gill, Plate VII. No. 156).

It will be seen that "each *internal gill* or entire branchial organ consists of cartilaginous arches (No. 156), with a piece of additional framework of a solidly triangular form, stretching beyond the arches, and composed of semi-transparent, gelatinous-looking material. These parts, forming the framework of the organ, support upon their upper surface the three rows of crests with their vascular network, and the main arterial and venous trunks which lie parallel with and between them. The three systemic arteries arising, right and left, from the *truncus arteriosus*, enter each gill on its cardiac side, and then follow the course of the crests, lying in close proximity to them. The upper of these branchial arteries runs alone on the outside of the upper crest, and another branch leaving the trunk and passing into the network of the

crest, whence a returning vessel may be traced carrying back the blood across the branchial artery, and to a vessel lying close to and taking the same course as the artery itself. Carrying the eye along the latter vessel we find, at a short distance from the first of these crest branches, a second, which leaves the main trunk and enters the crest, when a corresponding returning vessel conveys the blood across the arterial trunk into the vessel lying beside it, as in the former instance. A succession of these branches (each taking a similar course) may be traced from one end of the crest to the other. But it is now to be observed that the trunk from which these arterial branches spring diminishes in size as it proceeds in its course (like the gill artery in fishes), while the vessel running parallel to it and receiving the stream as it returns from the crest enlarges in the same degree. Thus, the artery or *afferent* vessel which brings the blood to the gill is large at its entrance, but gradually diminishes and dwindles to a point at the opposite end of the crest; while the venous or *efferent* vessel, beginning as a mere radical, gradually enlarges, and thus becomes the trunk that conveys the blood out of the gill to its ultimate destination. Calling this vessel the *upper branchial vein* as long as it remains in contact with the gill, we subsequently change its name when it leaves the gill and winds upwards for distribution to the head, and then designate it the *cephalic artery*. The *middle branchial artery and vein* proceed in like manner in connexion with the middle crest, and the *lower artery and vein* in connexion with the lower crest. The middle and lower venous trunks, having reached the extremity of the crests, curve downwards and inwards, and then leave the gill. The former trunk, converging towards the spine, meets its fellow, and with it forms the *ventral aorta*. The latter gives origin to the *pulmonary artery*, and supplies also the integuments of the neck. Curious and beautiful is the final stage of the metamorphosis, when the waning tadpole and incipient frog coexist, and are actually seen together in the same subject. The dwindling gills and the shrinking tail—the last remnants of the tadpole form—are yet seen, in company with the coloured, spotted skin, the newly-formed and slender legs, the flat head, the wide and toothless

mouth, and the crouching attitude of the all but perfect reptile.

“By the process now described, the three systemic arteries become continuous with the corresponding *effluent* trunks that convey the blood for distribution through the body, while, simultaneously, the vital fluid is being abstracted from the special trunks belonging to the gill and its vascular crests. These, with the gill structure connected with and dependent upon them, being thus deprived of their blood, shrink, become absorbed, and disappear. Such appears to be the beautifully simple mechanism by which the transition in the type of the respiratory function from fish to reptile is accomplished. If we take a tadpole a few days old, when the *outer* gills are fully developed, and immerse it for another few days in a weak solution of chromic acid (Mr. Archer's method), we may, by placing the tadpole under a dissecting microscope, and with the aid of a needle and camel-hair brush, then remove the integuments, disclose the tufts of the *inner* gills, and by carefully getting rid of a prominent roll of intestine that occupies the upper part of the abdomen, succeed in revealing the incipient lungs. These are situated behind the gut and close to the spine, and appear as a pair of minute tubular sacs, united at their upper and open extremities. The chromic acid renders the tissues friable, so that they can be readily peeled away.”

That we may see how the circulation is carried on during life in the gills, the outer covering must be carefully raised, or even stripped off. This can be accomplished by putting the Tadpole under the influence of chloroform—a drop of the fluid is sufficient for the purpose.<sup>1</sup>

The blood-vessels of mammals are divided with reference to their structure into arteries, capillaries, and veins; yet these three divisions are by no means broadly separated from each other, inasmuch as the capillaries are continued into the veins just as imperceptibly as they arise from the arteries. But with reference to their structure, while the capillaries possess only a single coat without any special structure, the larger vessels present, with but few excep-

(1) We refer the reader to Mr. W. U. Whitney's highly interesting and valuable paper in the *Trans. Micros. Soc.* for 1861 and 1867.

tions, three layers, which are designated as the inner coat, or *tunica intima*; the middle coat or circular fibrous coat, *tunica media*; and an outer coat, *tunica externa* or *adventitia*. The first is the thinnest coat, and consists of a cellular layer, the epithelium; generally, also of an elastic coat, with the fibres disposed in a longitudinal direction. The second, middle coat, is a thicker layer, and the principal seat of the muscular fibres of the vessels; in the veins, however, it contains numerous longitudinal fibres, and in the largest vessels more or less elastic elements and connective tissue. The third coat has its fibres again arranged for the most part longitudinally, and it is as thick as, or even thicker than, the middle coat, and consists of connective and elastic tissues. This coat, the *tunica adventitia* of large arteries, contains muscular fibres in animals, but none in man. According to J. Lister (*Quart. Journ. Microsc. Scien.* 1857, p. 8), the smallest arteries of the frog's web show contractile fibre-cells, which measure from the 1-100th to 1-200th of an inch, and run in a spiral direction, making one and a half up to two and a half turns round the inner coat of the vessel, and such fibre-cells in a single layer constitute the only muscular elements of the vessel.

The blood-vessels of the eye are extremely numerous, and present different conditions in the several parts. In the choroid coat, they are arranged in a most beautiful stellate manner, and the capillary network of the innermost layer of the choroid coat, when injected, forms an attractive object. A vertical section of the eye of a cat, showing its several vascular and nervous coats, is given in Plate VII. No. 157.

The circulation in the foot of the Frog and the tail of the Newt is, for the most part, the capillary circulation. The ramifications of the minute arteries form a continuous network, from which the small branches of the veins take their rise. The point at which the arteries terminate and the minute veins commence, cannot be exactly defined; the transition is gradual; but the intermediate network is so far peculiar, that the small vessels which compose it maintain nearly the same size throughout; they do not diminish in diameter in one direction, like arteries and veins; hence the term capillary, from



*capillus*, a hair. (Fig. 317.) The size of the capillaries is proportioned in all animals to that of the blood-corpuscles; thus, amongst the *Reptilia*, where the blood-corpuscles are the largest, the capillaries are also the largest:



Fig. 317.—A network of capillaries conveying blood to the lungs.

but it does not follow that they should be always of the same size in all the tissues of one and the same animal; for if we examine and carefully measure in the human subject their sizes in different tissues, we shall find that they vary greatly even in individual tissues, and, at a rough estimate, examples may occur as large as a thousandth, whilst others are as small as the four or five-thousandth of an inch. They should be measured, if possible, in their natural state; when injected, their size is slightly increased; but, when dried, they diminish so considerably that in some specimens vessels imperfectly filled with injection have been known to shrink from the three to the twenty-thousandth of an inch.

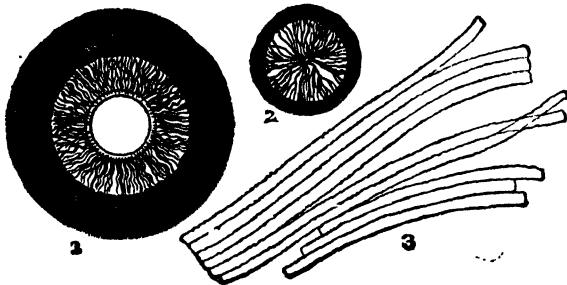

Fig. 318.

1, Blood-vessels of the Eye; back view of the *Iris* and ciliary processes. 2, Vessel of the *membrana pupillaris*, from the eye of a Kitten. 3, Fibres or tubes from the lens of the Ox. (A sectional view of a Cat's eye is given in Plate VII. No. 157.)

Capillaries are, with very few exceptions, always supported by an areolar network, which serves not only as an investment to them, but connects them intimately with the tissues they are destined to supply. A possibility arises, in first examinations, of mistaking or confounding capillaries with nerves, especially if the part under observation should have been left for some time in strong preserving or alkaline solutions.

A weak solution of caustic soda, and also another of acetic acid, are both of use; the first is available for the purpose of tracing nerves; the latter in making out vessels, structure of papillæ, unstriped muscle, &c., inasmuch as it renders their nuclei more obvious, while soda thickens and makes them less so. It is very useful sometimes to use these re-agents alternately; the rule is, to apply them to the object while under the microscope, so as to watch their gradual operation.

It is not in the blood alone that cells float in a fluid; the chyle and lymph are colourless corpuscles flowing along their especially - adapted tubes and ducts, and carrying the nutritive particles gathered from the food to the blood-vessels, for the



Fig. 319.—The bronchi, a fine network of air-tubes for supplying the lungs with air.

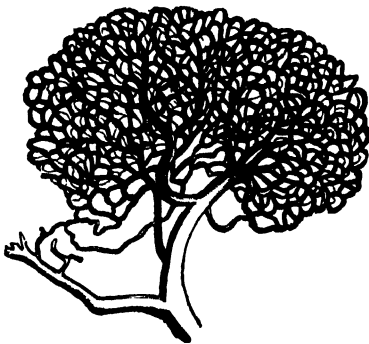

Fig. 320.—A capillary of blood-vessels distributed to the fat tissue. Better seen in some of the injected specimens, Plate VII.

reparation of the framework, or growth that incessantly goes on in the animal body.

*Classification of the Animal Tissues.*—Professor Schwann classifies the fundamental tissues of the human body as follows:—and it will be seen that more than half are made up of cellular tissue or simple membrane.

- |  |   |   |
|--|---|---|
| 1. Simple membrane: employed alone in the formation of compound membranes . . . . .  | } | Examples: Walls of cells, capsule of lens of the eye, sarcolemma of muscle, &c.             |
| 2. Fibrous tissues. . . . .  |   | Examples: White and yellow fibrous tissue, areola tissue, elastic tissue, &c.               |
| 3. Cellular tissues. . . . .   | } | Examples: Cartilage, fat, pigment, grey nervous matter, &c.                                 |
| 4. Sclerous, calcareous, or hard tissues   |   | Examples: Rudimentary skeleton of invertebrata, bone, teeth, &c.                            |
| 5. Compound membranes: composed of simple membrane and a layer of cells of various forms (epithelium or epidermis), or of areola or connective tissue and epithelium . . | } | Examples: Mucous membrane, skin, true or secreting glands, serous and synovial membranes. — |
| 6. Compound tissues; a, those composed of tubes of homogenous membrane, containing a peculiar substance . . . . .  |   | Examples: Muscle, nerve.  |
| b, those composed of white fibrous tissues and cartilage . . . . .   | } | Example: Fibro-cartilage.   |

*Cellular or Formative Tissue.*—Areolar or connective tissue is generally distributed throughout the body, and

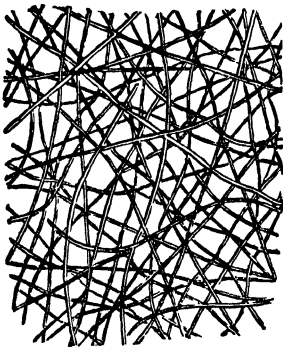

various forms of this tissue are found; it is seen uniting together component parts, filling up interstices between them, and affording a support to the blood-vessels and nerves, before they are distributed to the various organs. This tissue is soft, clear, smooth, and extremely minute, being the 1-12,000th of an inch in diameter, sometimes less. The fibre is usually found united together in bundles; if these be acted upon by dilute acetic acid, they swell up, become transparent, and the

Fig. 321.—Fibrous tissue, lining the interior of the eggshell, the lime having been previously removed by immersion in dilute hydrochloric acid.

appearance of fibrous structure is no longer seen, although

some fibres that were not previously observed may become more distinct. The first kind does not refract the light strongly; the second kind does, showing some chemical difference in their composition.

Cellular tissue, if dried, becomes a yellowish, brittle, transparent mass; but regains its former state if placed in water. The fibres have a remarkable arrangement and disposition. They are often deposited in a spiral manner; at other times they are regularly undulating. In fibres taken from some parts of the body, we find a fasciculus wound round in a spiral form. As a consequence, when acetic acid is applied, we perceive projections of swollen cellular tissue, and the depressions, from not having been acted on, have a constricted appearance. The fibrous tissue lining the eggshell, fig. 321, is the simplest form in which it is found.

Fat is generally found in the cellular tissue; it is not secreted from it, but is contained in its proper cells, and termed *adipose tissue*; the elementary cells of which are from the 1-300th to the 1-600th of an inch in diameter (fig. 322). The cell-wall is very delicate and transparent; sometimes there are one or two nuclei enclosed. Æther dissolves out the fat-cells from the tissues. Acetic acid acts upon the cell-wall, and causes the contents to pass from within outwards.

*Fibrous tissue*, elastic and non-elastic, is usually divided into *white* and *yellow* fibrous tissue. The yellow is elastic, and of great strength, consisting of bundles of fibres which are highly elastic. (Fig. 324, No. 2.) The white (fig. 324, No. 1), though non-elastic, is of great strength, and of a shining, silvery appearance.

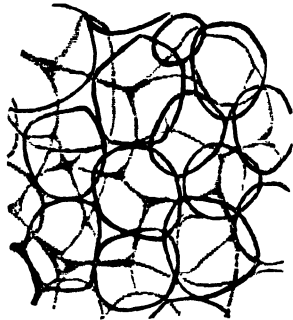

Fig. 322.—Cells from adipose tissue, or fat, magnified 100 diameters.

These two kinds of fibrous tissue differ from each other in many respects, but chiefly in their ultimate structure, their physical properties, and their colour: both are largely

employed in those parts subservient to the organs of locomotion.

The white fibrous tissue is (when perfectly cleared of the areolar) of a silvery lustre, and composed of bundles of fibres running, for the most part, in a parallel direction;

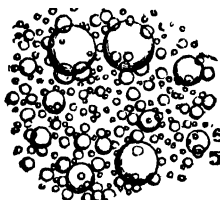

Fig. 323. *The contents of a single fat-cell, separated and magnified 250 diameters.*

but if there be more than one plane of fibres they cross or interlace with each other. In some specimens it is very difficult to make out the fibres distinctly, except with oblique light; from this circumstance it would appear that this tissue is composed of longitudinally striated membrane, which is often found split up into fibres. The white fibrous tissue is

principally employed in the formation of ligaments and tendons—a purpose for which it is admirably fitted on account of its inelasticity: it also enters into the formation



Fig. 324.

1, White fibrous or non-elastic tissue. 2, Yellow fibrous or elastic tissue taken near a ligament.

of fibrous membranes, viz. the pericardium, dura mater, periosteum, perichondrium, sclerotic coat of the eye, and

all the fasciæ. It is sparingly supplied with capillaries and nerves: the former always run in the areolar tissue, connecting the bundles of fibres together; in the generality of the fibrous tissues, the capillaries are not well seen, except in that of the dura mater and periosteum; in other parts it must be injected to show them.

The yellow fibrous tissue is highly elastic; it consists of bundles of fibres covered with, and connected together by, areolar tissue: the fibres are of a yellow colour, some round, others flattened; they are not always parallel, but frequently bifurcate and anastomose with neighbouring fibres. It is always difficult to separate the fibres from each other; and when separated, the elasticity of each individual fibre is shown



Fig. 325.—White fibrous tissue from the sclerotic coat of the eye.

by its tendency to curl up at the end. The fibres in the human subject vary in diameter from the 1-5,000th to 1-10,000th of an inch. Acetic acid of ordinary strength does not act on yellow fibrous tissue; nor for a very long time after maceration in water or spirit does its elasticity diminish. Very long boiling extracts from it a minute quantity of a substance nearly allied to gelatine; neither nuclei nor a trace of a cell can be seen in it after the addition of acetic acid: both are readily seen when white fibrous element is treated with this acid.

*Muscular Fibre.*—There are three different kinds of muscular fibre found in the animal body: 1st, in the muscle of the skeleton; 2d, in the muscle of the heart; and 3d, in the stomach, intestine, &c. The functions of muscular fibre may be referred to two kinds—voluntary and involuntary. The muscles endowed with voluntary power are those of the skeleton; the involuntary are those of the heart, stomach, intestine, &c.

Muscular fibre is held together by a very delicate tubular sheath, nearly resembling simple structureless membrane.

This cannot always be discerned ; but when the two ends are drawn asunder it will be perceived to rise up in wrinkles, or the fragments of the torn muscle will be seen to be connected by the untorn membrane, as at fig. 326. This membrane is termed *Myolemma*. It is best seen when a piece of muscle is subjected to the action of

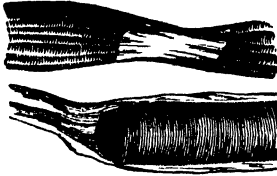

Fig 326 — Muscular fibre broken across, the fragments connected by the untorn structureless membrane, *myolemma*. (Magnified 100 diameters.)

fluids, as diluted acetic or citric acid, or the fluid alkalis ; which occasion it to swell and become easy of separation. It has no share in the contraction of the muscle itself, which is made up of a series of bundles of highly elastic fibres : portions of a separated bundle are shown at fig. 327, and the ultimate structure of

a fibre, under a magnifying power of 600 diameters, at fig. 328, No. 1.

Dr. Hyde Salter pointed out, that in the tongue the muscles pass directly into the bundles of the submucous

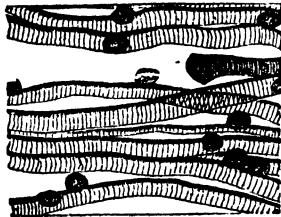

Fig 327. — Muscular fibre, broken up into irregular and distinct bands ; a few blood globules are distributed about (Magnified 200 diameters).

connective tissue, which serve as their tendons. Such a transition is shown in fig. 328, No. 2 ; the tendon, the lower part of which may be seen passing insensibly into the striped muscle, the glandular sarcous elements of the latter appearing, as it were, to be deposited in the substance of the tendon (just as calcareous particles are

deposited in bone), at first leaving the tissue about the walls of the cavities of the endoplasts, and that in some other directions, unaltered. These portions, which would have represented the elastic element in ordinary connective tissue, disappear in the centre of the muscular bundle, and the endoplasts are immediately surrounded by muscle ; just as, in many specimens of bone (see figs. of bone), the *lacunæ* have no distinguishable walls. On the other hand

at the surface of the bundle the representative of the elastic element remains, and often becomes as much developed as its sarcolemma. There is no question here of muscle resulting from the contents of fused cells. It is obviously and readily seen to be but a metamorphosis of the periplastic substance, in all respects comparable to that which occurs in ossification, or in the development of tendon. In this case, we might expect that, as there is an areolar form of connective tissue, so should

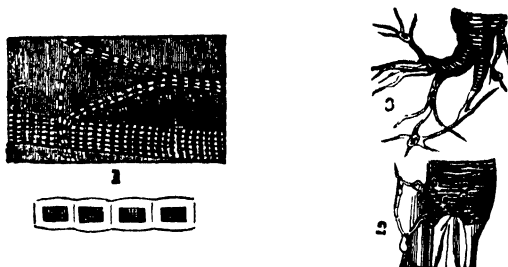

Fig. 323.

1, Muscular fibre, and a *fasciculus* of a muscle taken from a young Pig. (Magnified 600 diameters) 2, Muscular fibre from the tongue of Lamb, showing continuity of the upper portion, with connective tissue of the lower portion. 3, Branched muscle, ending in stellate connective cells, from the upper lip of the Rat.

we find some similar arrangement of muscle; such may, indeed, be seen very beautifully in the termination of the branched muscles, as they are called. In fig. 328, No. 3, the termination of a muscular fibre from the lip of a Rat, is shown: and the stellate "cells" of areolated connective tissue are seen passing into the divided extremities of the muscular bundle, becoming gradually striated as they do so. In the muscle it is obvious enough, that whatever *homology* there may be between the stellate "cells" and the muscular bundles with which they are continuous, there is no *functional analogy*, the stellate bodies having no contractile faculty. The nervous tubule is developed in essentially the same manner as a muscular fasciculus, the only difference being, that fatty matters take the place of syntonin. Now it commonly happens that the nerve-tubule terminates in stellate bodies (fig. 330) of a precisely similar nature; these are supposed to



possess important nervous functions; and are now known as "ganglionic cells."

The muscular fibre, known as the *non-striated*, or involuntary, consists of a series of tubes presenting a flattened appearance, without the transverse striæ so characteristic of the former: elongated nuclei immediately appear upon the application of a little dilute acetic acid. Professor Wharton Jones first demonstrated this structure in his lectures at Charing Cross Hospital, about 1843: he was led to infer, from appearances in very young fibre, that the striped muscular fibre is originally composed of similar elements to the *unstriated*, or plain muscular tissue,

which, in the process of development, becomes enclosed in a sarcolemma (simple membrane) common to many of them; the fibres then split into smaller fibres (*fibrillæ*). Thus accounting for the nuclei of striped muscular fibre; which, according to his views, are "the persistent nuclei of the primitive muscular-fibre cells."

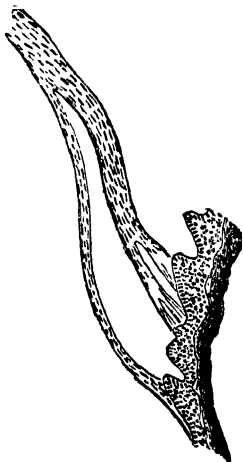

Fig 329.—A portion of the involuntary muscular fibre surrounding the hair.

The non-striated fibre is beautifully seen in connexion with the skin surrounding the hairs of the head, a few fibres of which are separately shown in fig. 329. Professor Kolliker originally described these muscles of the skin, of which there appear to be one or two in connexion with each hair-follicle, arising from the more superficial parts of the outer skin, then passing down to the root of the hair, close behind the fat-gland, and there embracing it. It is indeed most remarkable that skin, when covered with hair, should alone be provided with these muscular fibres; the effect of the contraction of which must be to thrust up the hair-follicles and depress the intermediate portions of skin, and thus produce that peculiar

and before unaccountable state of the surface known as *goose-skin*.

*Nerves*.—The nervous system consists of brain, spinal marrow, and nerves. There are two sets of nerves in the body ; in the one set the nerves are white, firm, shining, more or less rounded, with transverse markings ; in the other, they are softer, not so consistent, of a reddish grey colour, and generally flat.

Under the microscope, nerves are seen to be composed of minute fibres or tubules, full of nervous matter, arranged in bundles, and connected by an intervening fibro-cellulartissue, through which capillaries ramify. A layer of the same, or of a more delicate, transparent, structureless tissue surrounds the whole nerve, forming a sheath. The slight pressure of the thin glass, when placed on the nerve-fibre, causes nearly the whole of the contents to flow out in the form of a granular material ; it therefore becomes necessary to exercise considerable care in breaking up structures to view these tubules, which should be immersed in a very weak solution of spirit and water.

*On Microscopical Examination of Nerves*.—It would scarcely be necessary to insist on the great importance of removing and examining the nervous centres as soon as possible after death, were it not that the practice is too often neglected. Great caution also should be exercised to avoid injuring the parts, so that when hardened, perfect or *entire* sections of them may be obtained for examination under the microscope. After they have been carefully examined externally, by the assistance of a lens, if necessary, incisions should be made, not at random, but in a

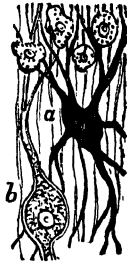

Fig. 330.—A satellite nerve corpuscle, with tubular processes issuing out, which at *a* is filled with a corpuscle containing black pigment, above this are corpuscles with nuclei and their nucleoli ; at *b* is a corpuscle enclosing within its sheath granular matter : this is taken from the root of a spinal nerve.



Fig. 331.—Termination of nerve-loops in muscles.

After they have been carefully examined externally, by the assistance of a lens, if necessary, incisions should be made, not at random, but in a

regular manner through them; and wherever there is reason to suspect the existence of disease, small portions should be removed, and examined while perfectly *fresh* under high magnifying powers. The *nature* of the lesion having been thus ascertained, the morbid parts, with some of the surrounding healthy tissue, should be removed, and after being divided, if necessary, into smaller portions, should be macerated in a weak solution of chromic acid. It is very important to cut and subdivide the parts, when necessary, in such a manner, that their relation to the rest may be recognised after they have become hardened for the purpose of making sections. Thus,—unless the locality of the lesion require a different course,—one incision may be made through the *crura cerebri*, immediately in front of the small or motor root of the trifacial nerves, and a third through the base of the anterior pyramids, immediately below the attachment of the sixth pair of cerebral nerves. With regard to the spinal cord, if it be cut up into small portions and hardened in chromic acid, it will be found better to divide it in three places: 1st, through the middle of the cervical enlargement; 2nd, through the middle of the dorsal region; and 3rd, through the middle of the lumbar enlargement.

If, however, the lesion be suspected to exist at another point, the cord must be divided there; as it is highly important that the *nature* of any morbid portion that may be found should be examined under the microscope in a *perfectly fresh* state; for the nerve-fibres undergo a considerable and very deceptive alteration by the action of chromic acid. But it is no less important, and indeed is absolutely necessary for an exact and complete investigation, that *entire* portions of the cord, in the locality of the lesion, be hardened in chromic acid, so that thin, but *perfect* sections may be made for examination under the microscope.

“The strength of the chromic acid solution should differ for different parts of the cerebro-spinal centres. For the convolutions of the cerebral hemispheres and cerebellum, the proportions should be one of the crystallised acid to about four hundred of water, while for the pons varolii,

medulla oblongata, and spinal cord, the strength of the solution may be in the proportion of one of the acid to about three or even two hundred of water. It is best, however, to begin with the weaker solution and increase its strength at the end of some hours. If the cerebral and cerebellar hemispheres be hardened in a solution of greater strength, they become friable and unfit for making perfect sections."<sup>1</sup>

*Method of Preparing Sections of the Spinal Cord.*—By a peculiar method, the late Dr. Lockhart Clarke obtained beautiful sections showing the arrangement of the nerve-fibres and vesicles of the spinal cord and other parts of the nervous system. The results are recorded in the *Philosophical Transactions* for 1851, Part 2. The cord, it appears, must be hardened in acetic acid and alcohol, when excessively thin sections may be readily obtained with a sharp knife. These are then soaked in pure spirit, which permeates the texture in every part, and drives out the acetic acid, and afterwards transferred to turpentine which expels the spirit, and lastly the sections are mounted in Canada balsam. By this plan the tissues of the embryos of mammalian animals can also be rendered so transparent that the smallest ossific points can be seen in the temporary cartilages. To render the specimen more transparent immerse it in alcohol to which a few drops of a solution of soda have been added, and allow it to remain quietly for a few days. When sufficiently acted on, remove it, and preserve permanently in weak spirit. The principle of the action of the fluid may be explained thus: alcohol alone tends to coagulate albuminous textures and render them opaque, at the same time that it hardens them. The alkali, on the other hand, renders the tissues soft and transparent, and if time were allowed, would cause their complete solution. These two fluids in conjunction harden the texture and at the same time make it clear and transparent. Many soft tissues may thus be hardened sufficiently to enable us to cut very thin sections.

Nerves may be examined in thin sections of the skin after the addition of acetic acid and a solution of soda. Gerber boils the skin until it becomes quite transparent,

(1) Lockhart Clarke on the *Microscopical Examination of Nerves*.

then allows it to remain a few hours in turpentine, or until the nerves are seen to be white and shining, when they are ready for cutting into perpendicular sections with the double (Valentine's) knife.

It is proposed to employ chloride of gold to stain the tissues of the body. Tissues soaked in a weak solution of from one to two per cent. of this salt in distilled water, and afterwards exposed to light, are found to exhibit certain parts, as nerve-fibres, connective tissue, corpuscles, and cells generally, stained of violet-red colour, while other parts, as intercellular substance, &c. are left untouched. The soaking must be continued until the tissue assumes a straw-yellow colour, then taken out of the solution and placed in dilute acetic acid of one to two per cent. The colour will be seen to gradually develop itself, and Kölliker and Cohnheim, who have tried it, say that nerve-fibre, &c. are exceedingly well shown in this way.

*Consolidated Tissues.*—Such tissues are formed by a chemical combination with the albumen and gelatine of



Fig. 332.—Cartilage from ear of Mouse, resembling a section of vegetable tissue, with superimposed layers.

the fibre; this in cartilaginous formations is termed *chondrine*, the cells of which become consolidated by calcareous deposits, and a gradual transition results therefrom. Cartilage is the firmest structure next to bone met with; it is very elastic, and, as an intercellular substance, is generally divided into two kinds. Between the ribs we find this substance presenting a uniform bluish appearance, and slightly granular; this is true, or white cartilage. The other form of intercellular substance is developed in fibrous substances; and it is in this peculiarly-formed felt-work that cells with nuclei are found. This is known as yellow, fibrous, or spongy cartilage, the yellow colour depending on the mode of fibrous arrangement of the intercellular substance: it is found in the ears, and other parts.

Cartilage forms the entire skeleton in some kinds of fishes, the Skate, Lamprey, &c. In man it is placed



1

FIG. 333.

2

1, Cartilage from Rabbit's ear, showing large cells embedded in a fibrous matrix. 2 Cartilage from Human ribs, with cells in groups, each having a granular nucleus. (Magnified 200 diameters.)

between all the long bones, and also the bones of the vertebral column, there acting as an elastic cushion. Cartilage receives its nourishment by minute blood-vessels. When examined microscopically, the simplest form of cartilage is seen to resemble in a striking manner the cellular tissue of vegetables; it consists of an aggregation of cells of a spherical or oval form, capable in some cases of being separated from each other, and every cell having a nucleus, with a nucleolus in its interior. In figs. 332, 333, and 334, we have varieties of this structure. In the more highly organized scale of animals, a strong fibrous capsule, or sheath, surrounds the cartilage-cells; some of the fibres dip in amongst the cells, and bind them firmly together. In those inhabitants of the water, the Ray and Shark, the entire skeleton being cartilaginous, the cell is embedded in a matrix, which may

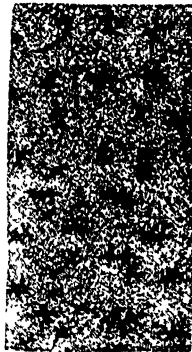
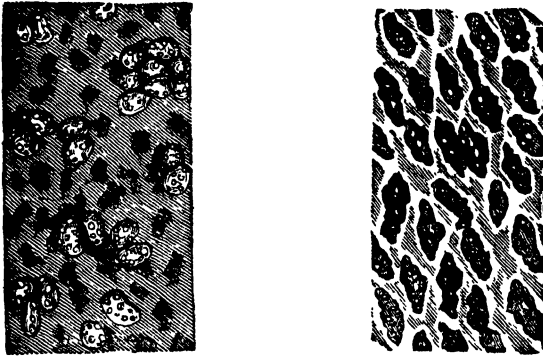

FIG. 334 — Cartilage from the Cuttle-fish, showing stellate form of cells.

be strictly termed *intercellular*. Cells are frequently or entirely isolated, as in the section from the ear of a Mouse (fig. 332), they then rarely become converted into bone. In the highest animals it is generally invested by a fine



1

Fig. 335.

2

1, Cartilage from the head of Skate, with clusters of nucleated cells and nucleoli inclosed. 2, Cartilage from the Frog, with cells having nucleoli, magnified 200 diameters.

and delicate membrane, termed *perichondrium*, which brings the blood-vessels in close contact with the cartilage; and, when in actual contact with the extremities of bones, is covered by a vascular membrane having a large number of vessels terminating in it, for the purpose of supplying a lubricating fluid to the end of the bones: this, the *synovial membrane*, is a very beautiful structure when injected and viewed under a 1-inch power.

In the earliest stages of existence, the entire framework—or a very large proportion—is composed of cartilage, which, by a gradual addition of earthy matter, becomes consolidated into bone. The mode of development, and the change from one to the other, is represented in the section (fig. 336); it will there be seen that the calcareous matter is deposited in nearly straight lines, which stretch from the ossified surface into the substance of the matrix of the cartilage, the amount of calcareous matter in which gradually diminishes as we recede from the ossified part. If the deposit has taken place to any great extent, the

calcareous matter becomes crowded and consolidated; as the process advances, the bone thickens, and a series of grooves, of a stellate form as in the annexed cut (fig. 337, No. 2), are found upon its surface, which become gradually converted into canals for the passage of blood-vessels.

In certain forms of disease, many of the soft parts of the human body are converted into cartilaginous and bony masses, which have received the name of *Enchondroma* (figs. 338 and 339). The microscopical characteristics of this change have been described by the author in the *Transactions of the Pathological Society of London*, vol. iv.

*Teeth.*—It is desirable to become acquainted with the structure of teeth under the microscope; they are highly interesting to the physiologist, and important guides to the naturalist in the classification of animals. Professor Owen has said, "If the microscope is essential to the full and true interpretation of the vegetable remains of a former world, it is not less indispensable to the investigator of the fossilised parts of animals. It has sometimes happened that a few scattered teeth have been the only indications of animal life throughout an extensive stratum; and when these teeth happened not to be characterised by any well-marked peculiarity of external form, there remained no other test by which their nature could be ascertained than that of the microscopic examination of their intimate tissue. By the microscope alone could the existence of Keuper

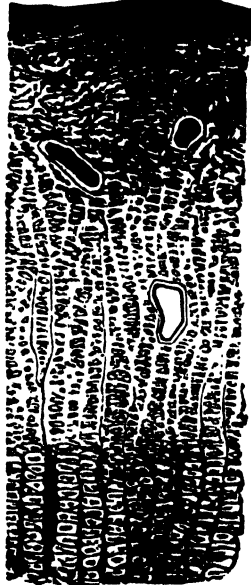

Fig. 336.—A vertical section of cartilage, with clusters of cells arranged in columns previous to conversion into bone, which is seen consolidated at the upper surface. The greater opacity of this portion is owing to the increase of osseous fibres, the opacity of the cell contents, and the multiplication of oil-globules; the dark intercellular spaces become occupied by vessels.



reptiles in the Lower sandstones of the New red system,



Fig. 337.

1, Section of the tendo-Achillis as it joins the os calcis ; showing the stellate cells of tendon gradually coalescing to form the round or oval cells of the cartilage. 2, A small transverse section of enchondroma, showing the gradual change of the cartilage-cells at *a* into the true bone-cells, termed *lacunae*, at *b*, with their characteristic *canaliculi*.

in Warwickshire, have been placed beyond a doubt. By

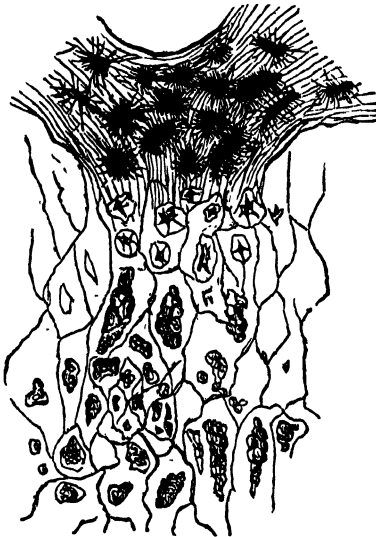

Fig. 338.—Microscopical character of *Enchondroma*, from a finger. The cartilage undergoes a gradual change, and is seen converted into bone at the upper portion.

the microscope, the supposed monarch of the Saurian tribes—the so-called *Basilosaurus*—has been deposed, and removed from the head of the Reptilian to the bottom of the Mammalian division. The microscope has degraded the *Sauropscephalus* from the class of reptiles to that of fishes. It has settled the doubts entertained by some of the highest authorities in palæontology as to the true affinities of the gigantic *Megatherium*; and by

demonstrating the identity of its dental structure with that of the Sloth, has yielded us an unerring indication of the true nature of its food."

The teeth of Man and of most of the higher animals are composed of three different substances, *Dentine* (known as *ivory* in the tusk of the elephant), *Enamel*, and *Cementum*, or *crusta petrosa*. These are variously disposed, according to the purposes which the tooth is to serve: in Man the whole crown of the tooth is covered with enamel, shown in the darker marginal part of fig. 340; its root or fang is covered with cementum, whilst the substance or body of the tooth is composed of dentine.

In the human subject, two sets of teeth are developed, the milk and permanent: the first are formed from one

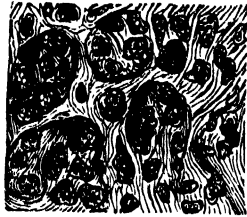

Fig. 339.—Portion of an . . . . .  
dromatous mass, nucleated cells,  
and fibrous tissue.



1



2

Fig. 340.—Sections of Human Molar Tooth (magnified 50 diameters)  
1, Vertical Section. 2, Horizontal Section.

set of bulbs, which in time shrink, and let the teeth fall out; the permanent set is then produced from new bulbs,

situated by the side of the old ones. Blandin was the first to point out that the teeth are developed in the mucous membrane, in a similar way to hair and nails. Other observers have been led to the same conclusion; and, more lately, Professor Goodsir demonstrated that the teeth are first formed in grooves of the mucous membrane, and subsequently converted into closed sacs by a process of involution, and that their final adhesion to the jaw is a comparatively late part of the process. It is now generally conceded that teeth belong to the *muco-dermoid*, and not

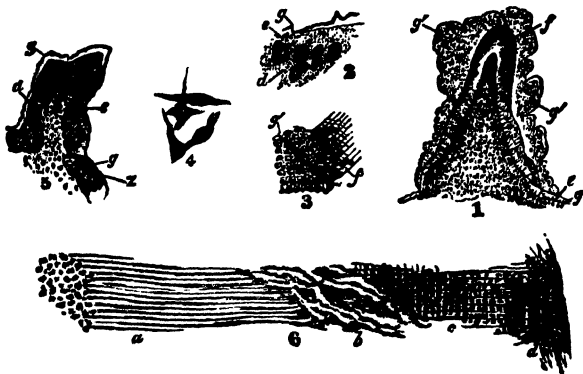

Fig. 341.

- 1, A section of a cusp of the posterior molar, upper jaw of a Child. The inner outline represents it before the addition of acetic acid—the outer afterwards, when Nasmyth's membrane *g* is seen raised up in folds; *f*, the enamel organ; *e*, the dentine. The central portion is filled up with pulp. 2, Edge of the pulp of a molar cusp, showing the first rudiment of the dentine, commencing in a perfectly transparent layer between the nuclei of the pulp and the *membrana preformata*. 3, Nasmyth's membrane detached from the subjacent enamel by acetic acid. 4, The stellate-cells of the enamel-organ. 5, Tooth of the Frog, acted on by dilute hydrochloric acid, so as to dissolve out the enamel and free Nasmyth's membrane. The structure of the dentine *e* is rendered indistinct. At the base, Nasmyth's membrane is continued over the bony substance at *a*, in which the nuclei of the *lacuna* are visible. (After Huxley.) 6, Decalcified tooth-structure; *a*, the dentine; *b*, enamel organ; *c*, enamel; *d*, Nasmyth's membrane.

to the periosteal, series of tissues; that, instead of standing in close relation to the endo-skeleton, they are part of the dermal or exo-skeleton; their true analogues being the hair, and some other epidermic appendages. Professor Huxley has proved that, although teeth are developed in

two ways, these are mere varieties of the same mode in the animal kingdom. In the first, which may be typified by the Mackerel and the Frog, the pulp is never free, but from the first is inclosed within the capsule, seeming to sink down as fast as it grows. In the other, the pulp projects freely at one period above the surface of the mucous membrane, becoming subsequently included within a capsule formed by the involution of the latter; this occurs in the human subject. The Skate offers a sort of intermediate stage.

The *enamel* forms a continuous layer, and invests the crown of the tooth; it is thickest upon the masticating surface, and decreases towards the neck, where it usually terminates. The external surface of the enamel appears

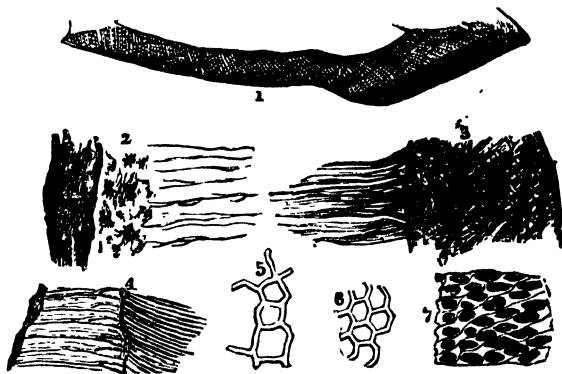

Fig. 342 — *Tooth Structure.*

1. Longitudinal section of superior canine tooth, exhibiting general arrangement, and contour markings, slightly magnified. 2 and 3. Portions from same, highly magnified, showing the relative position of *bone-cells*, *cementum* at 2, *dentine fibres*, and commencement of *enamel* at 3. 4. *Dentine fibres* decalcified. 5. *Nasmuth's membrane* separated and the *calcareous matter* dissolved out with dilute acid. 6. *Cells of the pulp* lying between it and the *ivory*. 7. A *transverse section of enamel*, showing the *sheaths of fibres*, contents removed, and magnified 300 diameters.

smooth, but is always marked by delicate elevations and transverse ridges, and covered by a fine membrane (*Nasmuth's membrane*), containing *calcareous matter*: this membrane is separable after the action of *hydrochloric acid*; it then appears like a network of *areolar tissue*, shown in fig. 342, No. 6; which is *Huxley's "calcified membrana*

*preformativa*," of the whole pulp. Nasmyth says: "In all cases where this covering has been removed by means of acid, it has, of course, the appearance of a simple membrane, in consequence of the earthly deposit having been dissolved out, and the animal tissue only remaining. The structure and appearance of the covering detached in this manner from the enamel is the same in every respect as that observed in the capsule of the unextruded tooth, and consisting, like it, of two layers, fibrous externally, and having on its external surface the peculiar reticulated appearance common to both."

"On examining carefully fine sections of several teeth under the microscope, I perceived here also," observes Nasmyth, "that the structure in question was continuous with the *crusta petrosa* of the fang of the tooth."

The enamel has a fibrous bluish aspect, is very brittle, and much harder than the other dentinal structures; it is, indeed, so hard, that it strikes fire with steel; if an attempt be made to cut it without the application of water to keep it cooled down, it burns with an ammoniacal odour, such as we perceive when horse-hoof is burnt. It is composed of prisms, about 1-5,000th of an inch in breadth, more or less wavy, and transversely striped. Two kinds of bands or stripes are seen traversing enamel, the direction of one of which nearly coincides with that of the dentine fibres; the other set of stripes indicate the laminated structure of enamel. Under polarised light, a third set become visible, arising from the variable inclination of the axes of the fibres to the plane of polarisation. The enamel is often traversed by cracks or fissures, mostly running parallel with one set of the fibres: these are sometimes described as canals; but as they resemble splits, and are seldom seen in young teeth, it is more likely that they are caused by the nature of the food and drink, which is taken into the mouth at temperatures varying many degrees; we also trace the commencement of disease from a fissure in the enamel. When a section of the enamel is cut obliquely, it has somewhat of a hexagonal or six-sided appearance. The dentine consists of a transparent basement membrane, with alternating layers of calcareous matter, traversed by very fine branching tubuli,

which commence at the pulp cavity, and pass up to the enamel.

Czermak discovered that the curious appearances of globular conglomerate formations in the substance of dentine depend on its mode of *calcification* and the presence of earthy material; and he attributes the contour lines to the same cause. Contour markings vary in intensity and number; they are most abundant in the root, and most marked in the crown. Vertical sections exhibit them the best; as fig. 342, No. 1. In preparing a specimen, first make the section accurately, then decalcify it by submersion in dilute muriatic acid; then dry it and mount in Canada balsam with continued heat, so as to allow the specimen to soak in the fluid resin for some time before it cools. It is the white opacity at the extremity of the contour markings which gives the appearance of rings on the tooth-fang.

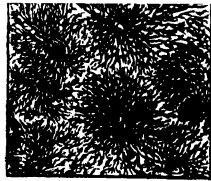

Fig. 343.—*Transverse section of Tooth of Pristis, showing orifices of medullary canals, with systems of radiating fibres (tubuli) analogous to the Haversian canals in true bone.*

"The tooth-substance appears," says Czermak, "on its inner surface, not as a symmetrical whole, but consisting of balls of various diameter, which are fused together into a mass with one another in different degrees, and on which the dentinal tubes in contact with the germ cavity are terminated. By reflected light, *back-ground* illumination, one perceives this stalactite-like condition of the inner surface of the tooth-substance very distinctly, by means of the varied illumination of the globular elevations, and by the shadows which they cast. Here one has evidently to do with a stage of development of the tooth-substance; for the older the tooth is, the less striking in general are these conditions, and the more even is the surface of the wall of the germ-cavity. In very old teeth considerable unevenness again makes its appearance; these, however, are not globular, but have a cicatrised, distorted appearance. It is best to make the preparation from a tooth of which the root is not perfectly completed. With preparations, one is readily convinced that the

substance of the last-formed layer of the tooth-substance appears, at least partly, in the form of balls, which are fused one among another, and with the balls of the penultimate layers; and one also perceives that in general their diameter becomes less and less, somewhat in the form of a point, towards the periphery of the tooth-substance. To obtain specimens, procure a tooth of which the fang is half-grown; then introduce the point of a penknife into its open extremity, and scraping the inner surface, detach small portions, which exhibit the globules admirably."<sup>1</sup>



Fig 344.—Transverse section of Tooth of *Myliobates*, Eagle-ray, viewed as an opaque object to show its radiating fibrous structure.

The cementum is the cortical layer of osseous tissue, forming an outer coating to the fangs, which it sometimes cements together. It commences as a very thin layer at the part where the enamel ceases, and increases in thickness towards the ends of the fangs. Its internal surface

is intimately united with the *dentine*, and in many teeth it would appear as if the earliest determined arrangement of the fibres of the dentine started from the *canaliculi*, as they radiate from the *lacunæ* in the cement. The interlacunar layer is often striated, and exhibits a laminated structure: sometimes it appears as if Haversian canals were running in a perpendicular direction to the pulp cavity. The *canaliculi* frequently run out into numerous branches, connecting one with another, and anastomosing with the ends of the dentine fibres. The thick layers of cement which occur in old teeth show immense quantities of aggregated *lacunæ* of an irregular and elongated form. Professor Owen believes that by age the pulp ceases to produce or nourish the dentine, which then becomes converted into *osteo-dentine*, and thereby the layer of *crusta* is so much increased as often to fill up the pulp cavity of the tooth. Professor Simonds assures us that this is not the case in the *Herbivora*. For instance, in the horse, the obliteration

(1) *Czermak*: translated by James A. Salter, M.B., *Quarterly Journal of Microscopical Science*, July, 1828.

tion of the cavity is gradually effected by an increased formation of dentine; and this is not supplanted by an *abnormal* or diseased growth, as would be the case were the pulp to become ossified, but as the pulp diminishes, so is the supply of nutriment to the tooth lessened, and at length entirely cut off from the interior. "To provide for the vitality of the tooth under these circumstances, the crusta increases in quantity on the fang, at the expense of the perfectly-formed dentine, which is lying in immediate contact with its inner surface. Through the medium of the canals in the crusta, which open on its borders, the tooth now draws its nourishment from the blood-vessels of the socket; and thus it continues, long after the obliteration of its pulp cavity, to serve all the purposes as a part of the living organism."<sup>1</sup>

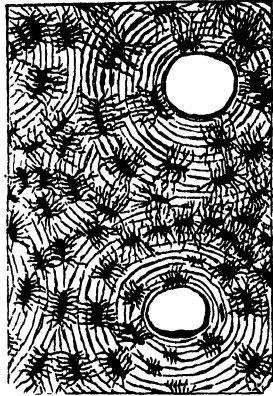

*Bone.*—The elements of bone are lamellæ and small corpuscles; the latter are possibly merely spaces between the former, in which is deposited the earthy substance. The lamellæ have for their basis a cartilaginous substance combined with earthy matter, or salts. These salts are chemically combined with the organic basis. Acids dissolve only the earthy salts, and leave the organic basis of the same form as the bone itself. The lamellæ are homogeneous throughout, like the intercellular substance of cartilage, but chemically different, being resolved by boiling in water into *colla*, whereas cartilage is resolved into *chondrine*.

Fig. 345.—A transverse section of the human clavicle, or collar-bone, magnified 95 diameters; which exhibits the Haversian canals, the concentric laminae, and the concentric arrangement of bone-cells around them. Some of the Haversian canals are white, others black; the latter are filled with a deposit of opaque matter, used in the grinding and polishing the section. When viewed under a lower power, they appear to be only a series of small black dots, as shown in fig. 346.

(1) Professor Simonds, on the "Structure and Development of Teeth of Animals"



Professor Quekett's paper, *Micros. Soc. Transactions*,

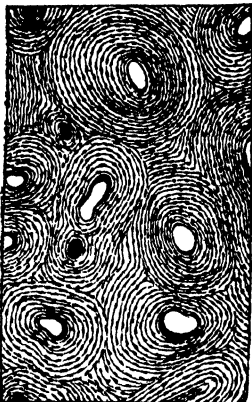

Fig. 346.—The same, viewed under a lower power, appear to be a series of small black dots.



Fig. 347.—A transverse section of the humerus, or fore-arm bone, of a Turtle (*Chelonia mydas*). It exhibits traces of Haversian canals, with a slight tendency to a concentric arrangement of bone-cells around them. The bone-cells are large and very numerous, but occur for the most part in parallel rows.

furnishes the earliest reliable information on the "Intimate structure of Bone." To this paper we are indebted for the following microscopical investigation of bone:—

Bone consists of a hard and soft part; the hard is composed of carbonate, phosphate, and fluoate of lime, and of carbonate and phosphate of magnesia, deposited in a cartilaginous or other matrix; whilst the soft consists of that matrix, and of the periosteum which invests the outer surface of the bone, and of the medullary membrane which lines its interior or medullary cavity, and is continued into the minutest pores. If we take for examination a long bone of one of the extremities of the human subject, or of any mammalian animal, we shall find that the bony substance, or shaft, is slightly porous, or rather occupied, both on its external and internal surfaces, by a series of very minute canals, which, from their having been first described by our countryman Clopton Havers, are termed to this day the Haversian canals, and serve for the transmission of blood-vessels into the interior of the bone. If now a thin transverse section of the same bone be made, and be examined by the micro-

scope with a power of 200 linear, we shall see the Haversian canals very plainly, and around them a series of concentric bony laminae, from three to ten or twelve in number. If the section should consist of the entire circle of the shaft, we shall notice, besides the concentric laminae round the Haversian canals, two other series of laminae, the one around the outer margin of the section, the other round the inner or medullary cavity.

Between the laminae is situated a concentric arrangement of spider-like looking bodies, which have, by different authors, received the name of osseous corpuscles, lacunae, or bone-cells, according as to whether they were ascertained to be solid or hollow: these bone-cells have little tubes or canals radiating from them, which are termed canaliculi.

The average length of the lacunae, or bone-cells, in the human subject is the 1-2,000th of an inch; they are of an oval figure, and somewhat flattened on their opposite surfaces, and are usually about one-third greater in thickness

than they are in breadth; hence, as will be presently shown, it becomes necessary to know in what direction a specimen is cut, in order to judge of their comparative size. The older anatomists supposed them, from their opacity, to be little solid masses of bone; but if the section be treated with spirits of turpentine coloured with alkanet-root, or if it has been soaked in very liquid Canada balsam for any great length of time, it can then be unequivocally demonstrated that both these substances will gain entrance into the bone-cells through the canaliculi. The bone cells, when viewed by transmitted light, for the most part appear perfectly opaque; and they will appear the more opaque the nearer the section of

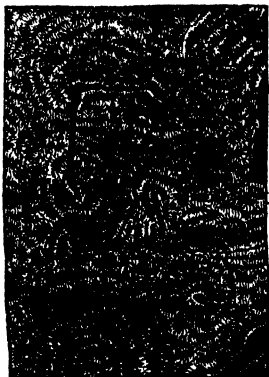
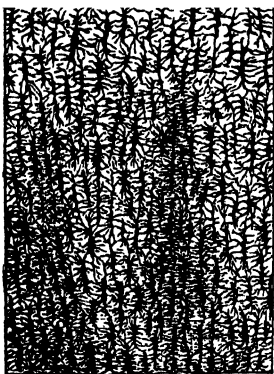

Fig. 348.—A transverse section of the Femur, or leg-bone of an Ostrich (magnified 95 diameters). When contrasted with the preceding figure, it will be noticed that the Haversian canals are much smaller and more numerous, and many of them run in a transverse direction.

them approaches to a transverse one: for when the cells are cut through their shorter diameter, they are often of such a depth that the rays of light interfere with each other in their passage through them, and darkness results; whereas if the section be made in the long diameter of the cells, they will appear transparent. When viewed as an opaque object, with a dark ground at the back and condensed light, the bone-cells and canaliculi will appear quite white, and the intercellular substance, which was transparent when viewed by transmitted light, is now perfectly



**Fig. 349.**—A horizontal section of the lower Jaw-bone of a Conger eel, which exhibits a single plane of bone-cells arranged in parallel lines. There are no Haversian canals present; and when this specimen is contrasted with that of fig. 347, it will be noticed that the canaliculi given off from each of the bone-cells of this fish are very few in number in comparison with that of the reptile.

dark. The soft part consists of the periosteum, which invests the outer, and of the medullary membrane, which invests the inner surface, lines the Haversian canals, and is continued from them, through the canaliculi, into the interior of the bone-cells; and of the cartilaginous or other matrix, which forms the investment of the minute ossific granules. The earthy matter of the bone may be readily shown by macerating the section for a short time in a dilute solution of caustic potash. The animal matter may be procured by using dilute hydrochloric acid instead of caustic potash;—when all the earthy matter is removed the section will exhibit nearly the same form

as when the earthy constituent was present; and if then viewed microscopically, it will be noticed that all the parts characterising the section previous to its maceration in the acid will be still visible, but not so distinct as when both constituents were in combination. When, however, the animal matter is removed, the bone will not exhibit the cells and the canaliculi, but is opaque and very brittle, and nothing but the Haversian canals and a

granular structure can be seen.

The parts which a transverse or a longitudinal section of a long bone of a mammalian animal exhibits, will be the Haversian canals, the concentric bony laminae, the bone-cells and their canaliculi; even these, except the bony laminae, may be seen in all mammalian bones (fig. 345).

Whether long or otherwise, they are, nevertheless, so differently arranged in the flat bones, such as those of the skull, and in the irregular bones, as the vertebrae, as to require notice. Those of the head are composed of two thin layers of compact texture; enclosed between which is

another layer of variable thickness, of a cellular or cancellated structure. The two outer layers are called tables—the one being the outer, the other the inner table; and the middle or cancellated layer is termed the diploe: in this last the principal blood-vessels ramify. The outer table of the skull is less dense than the inner; the latter, from its brittleness, is termed by anatomists the vitreous table. When a vertical section of a bone of the skull is made so as to include the three layers above mentioned, bone-cells may be seen in all; but each

of the three layers differ in structure: the middle or car-

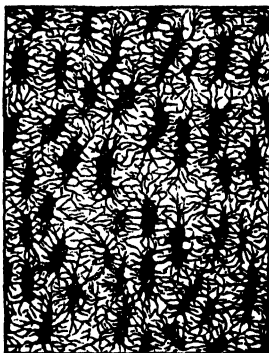

Fig. 350.—A portion of the Cranium of a *Siren* (*Siren lacertina*), remarkable for the large size of the bone-cells and of the canaliculi, which are larger in this animal than in any other yet examined. As in the preceding specimen, no Haversian canals are present.



Fig. 351.—A small portion of bone taken from the exterior of the shaft of the Humerus of a *Pterodactyle*, this exhibits the elongated bone-cells characteristic of the order *Reptilia*.

cellated structure will be found to resemble the cancellated structure in the long bones—viz. thin plates of bone, with one layer of bone-cells without Haversian canals; the outer layer will exhibit Haversian canals of large size, with bone-cells of large size, and a slightly laminated arrangement, but the inner or vitreous layer resembles the densest bone, as the outer part of the shaft of a long bone, for instance, and will exhibit both smaller Haversian canals and more numerous bone-cells of ordinary shape around them.

A transverse section of the long bone of a bird, when contrasted with that of a mammal, exhibits the following peculiarities: the Haversian canals are more abundant,



Fig. 352.—A horizontal section of a scale, or flattened spine, from the skin of a *Trygon*, or *Sting Ray*; this exhibits large Haversian canals, with numerous wavy parallel tubes, like those of dentine, communicating with them. This specimen shows, besides these wavy tubes, numerous bone-cells, whose canaliculi communicate with the tubes, as in many specimens of dentine.

much smaller, and often run in a direction at right angles to that of the shaft, by which means the concentric laminated arrangement is in some cases lost; the direction of the canals follows the curve of the bone; the bone-cells also are much smaller and more numerous; but the number of canaliculi given off from each of the cells is less than from those of mammals, fig. 348: the average length of a bone-cell of the Ostrich is 1-2,000th of an inch, the breadth 1-6,000th.

In the *Reptilia*, the bones may be either hollow, cancellated, or solid; but the specific gravity is not so great as that of birds or mammals. The short bones of most of the

Chelonian reptiles are solid, but the long bones of the extremities are either hollow or cancellated; the ribs of the Serpent tribe are hollow, the medullary cavity performing the office of an Haversian canal; the bone-cells are accordingly arranged in concentric circles around the canal. The vertebrae of these animals are solid; and the

bone, like that of some of the birds, is remarkable for its density and its whiteness. When a transverse section is taken from one of the long bones, and contrasted with that of a mammal or bird, we shall notice at once the difference which the reptile presents: there are very few, if any, Haversian canals, and these of large size; and at one view, in the section, fig. 347, we shall find the canals and the bone-cells arranged both vertically and longitudinally: the bone-cells are most remarkable for the great size to which they attain; in the Turtle they are  $\frac{1}{375}$ th of an inch in length, the canaliculi are extremely numerous, and are of a size proportionate to that of the bone-cell.

In fishes we have a greater variation in the minute structure of the skeleton than in either of the three classes already noticed. Of all the varieties of structure in the bones of fishes, by far the greater number exhibit nothing more than a series of ramifying tubes, like those of teeth; others exhibit Haversian canals, with numerous fine tubes or canaliculi, like ivory tubes, connected with them; a few consist of Haversian canals, with fine tubes and bone-cells, fig. 349; and a rare form, found only as yet in the sword of the Swordfish (*Istiophorus*), exhibits Haversian canals and a concentric laminated arrangement of the bone, but no bone-cells. The Haversian canals, when they are present, are of large size, and very numerous, and then the bone-cells are, generally speaking, either absent or but few in number; their place being occupied by tubes or canaliculi, which are often of a very large size. The bone-cells are remarkable for their graduate figure, and the canaliculi which are derived from them are few in number; they are seen to anastomose freely with the canaliculi given off from neighbouring cells; and if the specimen under examination is a thin layer of bone, such as the scale of an osseous fish, from the cells lying nearly all in one plane, the anastomoses of the canaliculi are seen beautifully distinct. In the hard scales of many of the osseous fishes, such as the *Lepidosteus* and *Callichthys*, and in the spines of the *Siluridæ*, the bone-cells are beautifully seen; in the true bony scales comprising the skeleton of the cartilaginous fishes, the bone-cells are

to be seen in great numbers. In the spines of some of the Ray family may be noticed a peculiar structure: the Haversian canals are large and very numerous, and communicating with each canal are an infinite number of wavy tubes, which are connected with the canals in the same manner as the dentinal tubes of the teeth are connected with the pulp-cavity; and if such a specimen were placed by the side of a section of the tooth of some of the Shark tribe, the discrimination of one from the other would be no easy matter. In the spine of a Ray, fig. 352, the analogy between bone and the ivory of the teeth is made more evident; for in this fish we have tubes, like those of ivory, anastomosing with the canaliculi of bone-cells.

Now, if we proceed at once to the application of the facts which have been laid down, and make a fragment of bone of an extinct animal the subject of investigation; we first find that the bone-cells in *Mammalia* are tolerably uniform in size; and if we take 1-2,000th of an inch as a standard, the bone-cells of birds will fall below that standard; but the bone-cells of reptiles are very much larger than either of the two preceding; and those of fishes are so entirely different from all three, both in size and shape, that they are not for a moment to be mistaken for one or the other; so that the determination of a minute yet characteristic fragment of fishes' bone is a task easily performed. If the portion of bone should not exhibit bone-cells, but present either one or other of the characters mentioned in a preceding paragraph, the task of discrimination will be as easy as when the bone-cells exist. We have now the mammal, the bird, and the reptile to deal with; in consequence of the very great size of the cells and their canaliculi in the reptile, a portion of bone of one of these animals can readily be distinguished from that of a bird or a mammal; the only difficulty lies between these two last: but, notwithstanding that on a cursory glance the bone of a bird appears very like that of a mammal, there are certain points in their minute structure in which they differ; and one of these points is in the difference in size of their bone-cells. To determine accurately, therefore, between the two, we must, if the section be a transverse one, also note the comparative sizes of the Haverian

canals, and the tortuosity of their course ; for the diameter of the canal bears a certain proportion to the size of the bone-cells, and after some little practice the eye will readily detect the difference.

A curious modification of horn is presented in the appendage borne by the Rhinoceros upon its snout, which in many points resembles a bundle of hairs. When a transverse section is made and viewed by polarised light, each cylinder is seen to have a cross diverging from a central spot ; the lights and shadows of this cross are replaced by bands of contrasted complementary colours, if the selenite plate is interposed (fig. 353). See Plate VIII. No. 178. Whale-bone is almost identical in structure, and is similarly affected by polarised light.



Fig. 353.—Transverse section of Horn of Rhinoceros, seen by polarised light.

A knowledge of the form and structure of scales of fishes (fig. 354), like that of teeth, has been shown by M. Agassiz to afford an unerring indication of the particular class to which the fish may belong : in the examination of fossil remains, the application of this knowledge has been attended with extraordinary results. As a class of objects for the microscope, the scales of fishes are exceedingly curious and beautiful, especially when mounted in fluid or Canada balsam, and viewed by polarised light. Many are seen best as opaque objects, and are then mounted dry between glasses. M. Agassiz divides the scales into four orders, which he names *Placoid*, *Ganoid*, *Ctenoid*, and *Cycloid* ; in the first two the scales are more or less coated with

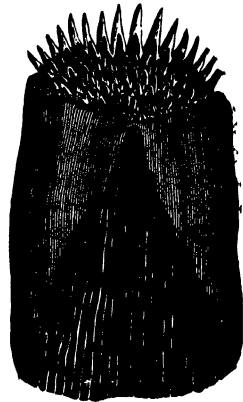

Fig. 354.—Scale of Sole.



enamel, in the others they are of a horny nature. To the *Placoid* order belong the Skates, Dog-fish, Ray, and Sharks; cartilaginous fishes, having skins covered with small prickly or flattened spines. To the *Ganoid* belong the Sturgeon, *Lepidosteus*, Hassar-fish, and Polypterus; fishes of this order are more generally found in a fossil state, and the scales are of a bony character. To the *Ctenoid* belong the Pike, Perch, Pope, Basse, Weaver-fish, &c.; their scales are notched like the teeth of a comb. To the *Cycloid* belong the Salmon, Herring, Eel, Carp, Blenny, and the majority of our edible fishes; their scales are circular and laminated. The scales of the Eel tribe are of an oval figure, and are among the most remarkable that can be selected for microscopic examination. To procure them, a sharp knife must be passed beneath the epidermal layer, and a portion of it raised, in a similar manner as directed for tearing off the cuticle from plants: after a few trials some will be detached. They are of an oval figure, rather softer than the scales of other fishes, and in some parts of the skin do not form a continuous layer. When the skin has been stripped off, previous to the fish being cooked, the scales can be obtained from the under surface, with a knife or pair of forceps. The scales of the viviparous Blenny are of a circular figure, situated under the epidermal layer; they were described by Mr. Yarrell as mucous glands, from their figure and small number. The surface of the skin of this fish, when fresh, appears to be covered with follicles; if, however, a portion be scraped off, it will be found to be a mass of delicate circular scales. A piece of the skin, when dried, exhibits the scales to great advantage, and, like those of the Eel, are beautiful objects for polarised light. The prismatic colours exhibited by fish are said to be due to the presence of fatty matter in the skin; but the beautiful metallic tints displayed by so many of them are rather due to the numerous microscopic plates, or scales, distributed over its surface.

Having thus brought our brief examination of a few of the more important structures of the animal economy to a close, it only remains for us to express a hope that it will be found to smooth the way, or in some degree assist the investigations of the student to a better and more

general survey of the whole fabric. Such a survey will not be unattended with its difficulties and disappointments, but it will bring its own reward for any amount of labour bestowed. To the medical student, desirous of obtaining further information, I would recommend Klein and Sanderson's "Handbook for the Physiological Laboratory," and Dr. Stirling's "Text-Book of Practical Histology."

The importance of becoming thoroughly familiar with the structural and microscopical characters of any particular organ in a healthy condition, cannot be too strongly urged upon the attention of the student; as to a want of this knowledge must be attributed many erroneous descriptions of morbid appearances. All who wish to use the microscope successfully, with reference to the examination of organs in a diseased state, will do well to acquaint themselves with minute anatomy generally, not only of the human subject, but of the lower animals; without such knowledge it will be found impossible to study pathology, or prosecute pathological inquiries with any degree of success.

A large amount of wrong observation has been recorded on cells and cellular structures: since Schwann announced his "cell theory," almost everything round has been regarded as a cell; any single body within this, or where there are several, the largest, has been regarded as a nucleus, and any spot within the nucleus has been viewed as a nucleolus. Whereas many of the so-called cells are homogeneous spheres; many of the nuclei are vacuoles, and so forth.

Such errors are natural, at first inevitable; they can be corrected only by practice, by testing observations in other ways, especially by chemical re-agents, and by comparison with the observations of others. "The marvel is not that the microscope should suggest false views—do not our eyes play us that trick?—but that it should reveal so many astounding facts as it really does; and the one con-

(1) The *Cyclopædia of Anatomy and Physiology* will be found a most valuable book of reference for the student in all matters relating to physiology and minute anatomy. Numerous valuable papers are distributed throughout the *Trans. of the Royal Micros. Soc.*: Huxley's *Lectures on Comparative Anatomy*; Owen's *Lectures on Comparative Anatomy*; Carpenter's *Physiology*, edited by H. Power, and Kölliker's *Manual of Human Microscopic Anatomy*.

solatory reflection which accompanies the difficult task of microscopic investigation is the *unanimity* which now reigns among observers on so vast a body of observations. If we read in physiological works of the yolk cells and coloured oil globules of the yolk, and the beautiful function of assimilation which has been attributed to them, they exist but in the imagination of the authors who have regarded the one as cells simply because they are round, and the other as consisting of fat because they are highly refractive,—such errors of *interpretation* do not discredit it any more than the mis-interpretations, which have helped to make Ehrenberg's name at once famous and suspicious, alter the facts which he saw, and could not rightly interpret. In truth, the eye is only a preliminary instrument in science. What we see has to be interpreted; and, as it is very difficult to confine ourselves to pure observation unmixed by hypothetical interpretation, we need many collateral confirmations."

The principal physical characters to be regarded in microscopic examinations may be summed up as follows:—

1. *Shape*.—Accurate observation of the shape of bodies is very necessary, as many are distinguished by this physical property. Thus the human blood-globules present a round biconcave disc, and are in this respect different from the oval corpuscles of birds, reptiles, and fishes. The distinction between round and globular is very requisite. Human blood corpuscles are round and flat; but they become globular on the addition of water. Minute structures seen under the microscope may also be likened to the shape of well-known objects, such as that of a pear balloon, kidney, heart, &c.

2. *Colour*.—The colour of structures varies greatly, and often differs under the microscope from what was previously conceived regarding them. Thus the coloured corpuscles of the blood, though commonly called red, are, in fact, yellow. Many objects present different colours, according to the mode of illumination; that is, as the light is reflected from or transmitted through their substance, as in the case of certain scales of insects, feathers of birds, &c. Colour is often produced, modified, or lost, by re-agents; as when iodine comes in contact with starch-granules, when

nitric acid is added to chlorophyle, or chlorine-water to the pigment-cells of the choroid, and so on.

3. *Edge or Border.*—This may present peculiarities worthy of notice. Thus, it may be dark and abrupt on the field of the microscope; so fine as to be scarcely visible; or it may be smooth, irregular, serrated, beaded, &c.

4. *Size.*—The size of the minute bodies, fibres, or tubes, which are found in the various textures of animals, can only be determined with exactitude by actual measurement. It will be observed, for the most part, that these minute structures vary in diameter; so that when their medium size cannot be determined, the variations in size from the smaller to the larger should be stated. Human blood-globules in a state of health have a pretty general medium size, and these may consequently be taken as a standard with advantage, and bodies described as being two, three, or more times larger than this structure; or all may be measured with a micrometer, as explained at page 51.

5. *Transparency.*—This physical property varies greatly in the ultimate elements of numerous textures. Some corpuscles are quite diaphanous; others are more or less opaque. The opacity may depend upon corrugation or irregularities on the external surface, or upon contents of different kinds. Some bodies are so opaque as to prevent the transmission of the rays of light; in this case they look black when seen by transmitted light, though white if viewed by reflected light; others, such as fatty particles and oil-globules, refract the rays of light strongly, and present a peculiarly luminous appearance.

6. *Surface.*—Many textures, especially laminated ones, present a different structure on the surface from that which exists below. If, then, in the demonstration, these have not been separated, the focal point must be changed by means of the fine adjustment. In this way the capillaries in the web of the Frog's foot may be seen to be covered with an epidermic layer, and the cuticle of certain minute *Fungi* or *Infusoria* to possess peculiar markings. Not unfrequently, the fracture of such structures enables us, on examining the broken edge, to distinguish the difference in structure between the surface and the deeper layers of the tissue under examination.

7. *Contents.*—The contents of those structures which consist of envelopes, as cells, or of various kinds of tubes, are very important. These may consist of included cells or nuclei, granules of different kinds, pigment matter, or crystals: a fair illustration of the changes effected by disease is given in fig. 256, from a cyst in a diseased liver: occasionally their contents present definite moving currents, as in the cells of some vegetables; or trembling rotatory molecular movements, as in the ordinary globules of saliva in the mouth.

8. *Effects of Re-agents.*—These are most important in determining the structure and chemical composition of numerous tissues. Thus water generally causes cell-formations to swell out from endosmosis; while syrup, gum-water, and concentrated saline solutions, cause them to collapse from exosmosis. Acetic acid possesses the valuable property of dissolving coagulated albumen, and in consequence renders the whole class of albuminous tissues more transparent. Thus it operates on cell-walls, causing them either to dissolve, or become so thin as to display their contents more clearly. Ether, on the other hand, and the alkalies, operate on fatty compounds, causing their solution and disappearance. The mineral acids dissolve most of the mineral constituents that are met with; so that in this way we are enabled to tell with tolerable certainty, at all events, the group of chemical compounds to which any particular structure may be referred.

All animal tissues should be stained, as previously directed, and cut into sections, otherwise an accurate idea of their general structure cannot be obtained. It is also of importance to examine specimens by reflected light, transmitted light, and by polarised light; when immersed in water, or in a highly refracting fluid, such as glycerine, oil, turpentine, and Canada balsam; with a cover and without a cover. The most scrupulous cleanliness should always be observed in microscopical examinations; many errors of interpretation have arisen in consequence of a want of sufficient care in preventing the admixture of various accidental substances. The better way of avoiding errors from this cause is to become familiar with the characters

of common substances which are likely to be mixed up with preparations, as the following:—oil globules, air bubbles, portions of worsted, cotton, and linen, silk and wool fibres, hairs from plants, vegetable tissues, human hair, portions of feathers, and the starches—wheat and potato starch from bread crumbs. In taking fluids from bottles and vessels, the possibility of mixing small portions of their contents must be avoided; the *pipette* should be washed immediately after it has been used. Another fallacy arises from the great transparency of some structures; a membrane may appear perfectly clear and transparent when in reality it is covered with a delicate layer of epithelium, which only becomes visible after the application of some chemical re-agent; on the other hand, by the action of re-agents, a fibrous appearance is produced. Acetic acid, when added to many preparations, frequently produces a swelling of the tissue, which looks like basement membrane, but which in reality has been formed by the action of the acid. The mechanical pressure of the thin glass, if pressed down tightly, alters structures very much; the appearance of the blood discs are, at times, much distorted in this way, and lead to false conclusions and erroneous descriptions.

To examine *blood*, prick the finger with a fine needle, and let it drop on a strip of glass. To differentiate the corpuscles, add a drop of the following solution:

Sulphate of Soda 104 grains;  
Acetic Acid 1 drachm;  
Distilled Water 4 ounces.

The contour of each disc will then be seen much clearer.

To the advanced observer, the examination of the mucous membrane will afford some instruction. Should the specimen be small, it will be better to pin it to a piece of cork; then well wash it by means of a small syringe. If the investing epithelium is required for examination, a portion can be detached from the surface by a knife; when placed on a glass slide, add a drop of iodine solution, then view it with a  $\frac{1}{4}$ -inch power. Villi and papillæ are best made out in injected specimens, as will be seen on reference to Plate VII.

## CHAPTER VI.

### THE MINERAL KINGDOM.

#### INORGANIC MATTER—FORMATION OF CRYSTALS—POLARISATION, 373.



IN our meagre search through organic nature we met with an endless variety of beautiful and instructive materials for the employment of the microscope. If we now turn our attention to the inorganic or mineral kingdom we shall find a vast storehouse filled with objects of unsurpassed interest to the microscopist. In the examination of the many beautiful forms presented to us in the phenomena of crystallisation, and the study of the varied chemical combinations, the student will discover a never-ending source of useful occupation.

We are as yet in great ignorance of the manner in which the majority of crystals belonging to the mineral kingdom are formed: we know, however, that very few can be reproduced by the chemist. But, although ignorant of the means whereby the great majority of crystals have been formed in the vast laboratory of nature, we can crystallise an immense number of substances, watch their numerous intricate modes of formation, and that in the smallest appreciable quantities, when aided by the microscope. Among natural crystals those employed in the formation of rocks open up a wide field to our view. The varieties of granites present us with the earliest crystallised condition of the earth's crust as it cooled down, the structure of which is beautifully exhibited under polarised light. Plate VIII. No. 160, is a section of a granite

shown on a red selenite ground. Crystallisation under a somewhat different condition and combination is seen in the New Red Sandstone, No. 158.

The prismatic rings of another crystalline substance, Quartz, represented in No. 159, possess great interest. Again, that of Arragonite, Tremolite, and Carbonate of Lime. The latter is frequently seen in combination with animal structure, and is then productive of many remarkable changes and modifications, such as we have represented in Plate VIII. Nos. 171, 172, 175, and 180, all of which should be prepared for examination with as well as without the polariscope.

The formation of artificial crystal may be readily effected, and the process watched, under the microscope, by simply placing a drop of a saturated solution of any salt upon a previously warmed slip of glass. The following list of salts and other substances form a beautiful series of objects for polarised light :—

Alum.	Oxalic Acid.
Asparagine.	Oxalurate of Ammonia.
Aspartic Acid. Plate VIII. No. 168.	Permanganate of Potash.
Bitartrate of Ammonia.	Phosphate of Lead and Soda.
Boric Acid.	Platino-cyanide of Magnesia.
Borax. Plate VIII. No. 164.	Plumose Quinidine.
Carbonate of Lime.	Prussiate of Potash, red and yellow.
"    Soda.	Quinidine.
Chlorate of Potash.	Santonine.
Chloride of Barium.	Salicine.
"    Cobalt.	Salignine. Plate VIII. No. 162.
"    Copper and Ammonia.	Sulphate of Cadmium.
"    Sodium.	"    Copper.
Cholesterine.	"    Copper and Potash.
Chromate of Potash.	Sulphate of Iron
Cinchonine.	"    Iron, Cobalt, and Nickel
Cinchonidine.	"    Magnesia.
Citric Acid.	"    Nickel and Potash.
Hippuric Acid.	"    Soda.
Iodide of Mercury.	"    Zinc.
"    Potassium.	Sugar.
"    Quinine.	Tartaric Acid.
Iodo-disulphate of Quinine.	Thionurate of Ammonia.
Murexide.	Triple Phosphate.
Nitrate of Bismuth.	Urate of Ammonia.
"    Barytes.	"    Soda.
"    Brucine.	Urea, and all the urinary deposits.
"    Copper.	Uric Acid.
"    Potash.	
"    Strontian.	
"    Uranium.	
Oxalate of Ammonia.	
"    Chromium.	
"    Chromium and Potash.	
"    Lime.	
"    Soda.	

## MINERALS.

Agates, various.  
Asbestiform Serpentine.  
Avanturine.  
Carbonate of Lime.  
Carrara Marble



Indurated Sandstone, Howth.  
 Indurated Sandstone, Bromsgrove.  
 Gibraltar rock.  
 Granite, various localities. No. 160.  
 Hornblend Schist.  
 Labrador Spar.  
 Norway Rock.  
 Quartz Rock, various. No. 159.  
 " in Bog Iron Ore.  
 Quartzite, Mont Blanc.  
 Sandstone, Plate VIII. No. 158.  
 Satin Spar.  
 Selenites, various colours.  
 Tin Ore, with Tourmalin.

## VEGETABLE SUBSTANCES.

CUTICLE of Leaf of *Correa Cardinalia*.  
 " " *Dentzia scabra*.  
 " " Pl. VIII. No. 173  
 " " *Elaeagnus*.  
 " " *Onosma taurica*.  
 Equisetum. No. 174.  
 Fibro cells from orchid. No. 169.  
 " *Oncidium bicallosum*.  
 Scalariform vessels from Fern.  
 Scyllium. No. 177.  
 SILICIOUS CUTICLES.—Various.  
 Starch.—Various. No. 167.

Very interesting results will be obtained by combining two or more chemical salts. Mr. Davies<sup>1</sup> succeeded in forming numerous beautiful double salts in the following manner. To a nearly saturated solution of the sulphate of copper, add a drop of a solution of the sulphate of magnesia, on the glass-slide, and dry quickly. To effect this, heat the slide so as to fuse the salts in its water of crystallisation, and there remains an amorphous film on the hot glass. Put the slide aside and allow it to cool slowly; it will gradually absorb a certain amount of moisture from the air, and begin to throw out crystals. If now placed under the microscope, numerous points will be seen to start out here and there. The starting points may be produced at pleasure by touching the film with a fine needle point, so as to admit of a slight amount of moisture being absorbed by the mass of salt. Development is at once suspended by applying gentle heat; cover the specimen with balsam and thin glass. The balsam should completely cover the edges of the thin glass circle, otherwise moisture will probably insinuate itself, and destroy the form of the crystals.

Mr. Thomas succeeded in crystallising "the salts of the magnetic metals" at very high temperatures, which gave interesting results, and produced curious forms of crystals. Plate VIII. No. 163 are representations of crystals of sulphate of iron and cobalt, No. 165, of nickel and potash, obtained in the following manner:—To form the sulphate of iron crystal, add to a concentrated solution of iron a small quantity of sugar, to prevent oxidation. Put a drop of the solution on a glass slide, and drive out the

(1) *Quart Journ. Micros. Scien.*, vol II p. 128. 1862.

water of crystallisation as quickly as possible, by the aid of a spirit lamp; then with a Bunsen's burner bring the plate to a high temperature. Immediately a remarkable change is seen to take place in the form of the crystal, and if properly managed the "foliation" represented in the plate will be fairly exhibited. The slide must not be allowed to cool down too rapidly or the crystals will probably absorb moisture from the atmosphere, and in so doing the crystals alter their forms. Immerse them in balsam, and cover in the usual way before quite cold.

*Sublimation of Alkaloids.*—Dr. Guy a few years ago directed the attention of microscopists to the fact that the crystalline shape of bodies belonging to the inorganic world might lead to their detection. Subsequently, Dr. A. Helwig, of Mayence, took the matter up, and showed that the plan was applicable not only to inorganic but also to organic substances, and especially to the poisonous alkaloids. By improving on Dr. A. Helwig's process, and substituting a bit of porcelain, Dr. Guy has been able to watch the process more minutely, and to regulate it more exactly. He has by this means been able to obtain characteristic crusts composed of crystals of strychnine weighing not more than 1-3,000th or 1-5,000th of a grain. Morphia gives equally characteristic results. For the examination of these, Dr. Guy recommends the use of a binocular microscope with an inch object-glass. But it is not to crystalline forms alone that one need trust; the whole behaviour of a substance as it melts and is converted into vapour is eminently characteristic, and when once deposited on the microscopical slide, under the object-glass, the application of re-agents may give still more satisfactory results. The re-agents, however, which are here to be applied are not of the kind ordinarily employed. Colour-tests under the microscope are, comparatively speaking, useless: those that give rise to peculiar crystalline forms are rather to be sought after. For instance, the crystals produced by the action of carbazotic acid on morphia are by themselves almost perfectly characteristic. These experiments should not, however, be undertaken for medico-legal purposes by one unskilled in their conduct, for the effects of the re-agents themselves might be mistaken by

the uninitiated for the result of their action on the substances under examination.

Dr. Guy's<sup>1</sup> method of procedure is as follows:—"Provide small crucibles, covers, slabs, or fragments of white porcelain; a few microscopic cell-glasses, with a thickness of about one-eighth of an inch and a diameter of circle of about two-thirds of an inch: and discs of window-glass about the size of a shilling. Place the porcelain slab on the ring of a retort-holder or other convenient support; then the glass cell; and upon the porcelain in the centre of the cell a minute portion of the alkaloid or other white powder, or crystal reduced to powder; then pass the clean glass dish through the flame of the spirit-lamp till the moisture is driven off, and adjust it with the forceps over the glass ring; now apply the flame of the spirit-lamp to the porcelain, underneath the powder or crystal, and continue the heat till the powder undergoes its characteristic change and gives off vapour. Watch the deposit of this vapour on the glass dish, and remove the spirit-lamp, either directly or after a short interval, as experience may determine.

"The white surface of porcelain being visible through the glass disc, as through a window, the behaviour of the substance under examination is easy to observe. It may be driven off without undergoing change or leaving residue, and the disc may be covered with crystals, as happens with arsenious acid, or with an amorphous sublimate, as happens with calomel; it may coalesce, throw out long silky crystals, to be gradually transferred as crystals to the glass disc, as is the case with corrosive sublimate; and it may melt, with or without previous change of colour, retain or shift its place, deposit carbon more or less abundantly, and yield a sublimate of detached crystals (veratrine), twigs (solanine), tufts (meconine), branching patterns (strychnine, morphine, cryptopia, &c), watered patterns with or without crystalloids (several alkaloids and glucosides), the melting and deposition of carbon being a common property of the alkaloids and of some analogous active principles.

(1) Dr. W. A. Guy, F.R.S. &c. on the "Sublimation of the Alkaloids,"—*The Pharmaceutical Journal*, June and August, 1867. *Microsc. Jour.* Dec. 1867

"The principal precaution to be observed in the application of heat is, that it should be moderate and gradual. It is best to act on the assumption that the substance under examination may be one of a considerable group of bodies, some of which sublime at very moderate temperatures. The spirit-lamp should, therefore, be placed at first three or four inches below the slab of porcelain, so that the point of its flame may not touch it; and if, under this low temperature, the disc of glass is not dimmed, the lamp should be raised by degrees till the mist makes its appearance. Then, as a general rule, the lamp should be withdrawn, the disc removed, and a new one put in its place. It may be well to state that, as the disc has been passed through the flame to drive off moisture, and has in this way been heated, the flame of the spirit lamp should not be allowed to play on the porcelain slab after the mist has appeared on the disc, at least not for any length of time; for, if this precaution be neglected, it may happen with the alkaloids as with arsenious acid or corrosive sublimate, that the mist does not form at all, or that it is driven off as soon as it is deposited. Perhaps, too, it may not be quite unnecessary to recommend that each disc of glass, as it is removed, should be placed with the sublimate upwards against a glass slide or fragment of porcelain; and that in this position (sublimate upwards) it should be retained. If this very simple precaution be overlooked, it is quite possible that we may mistake one surface for the other, and find ourselves applying our re-agents to the wrong one. The chief precaution relating to the examination and disposal of the sublimates consists in measures for preserving their identity during the examination to which we may have to subject them. This is best done by writing the names and that of the reagents on discs of paper, and placing paper and disk together in sunken grooves or circular spaces.

"As a precaution omitted by an experimenter so practised as Dr. Helwig is very likely to be overlooked by others, it is well to insist upon and to prescribe as the first step to be taken with a crystalline solution which we are about to use as a test, the determination of its proper crystalline form or forms as evaporated on a flat surface of

glass. Another mistake, arising out of a similar want of caution, may consist in confounding the effect of some saline re-agent with that of the water which holds it in solution.

“Now these remarks have a direct practical bearing on the selection of tests. A preference ought to be given to re-agents which leave no residue of their own: to distilled water, to alcohol, ether, chloroform, benzole, and fusel oil; and to acetic acid and the dilute mineral acids. Then those salts should be preferred of which the solutions yield dry residues of one or two definite forms, not such as put on many different shapes, are deliquescent themselves, and are likely to leave moist and unstable compounds. Nor is the strength of the solution a matter of little or no importance; for it should be borne in mind that the sublimes to which we apply them contain very minute fractions of a grain; and that a very strong solution, after acting on this minute quantity, would leave a coarse deposit of its own, both over the general surface and at the margin of the spot, which, blending with the reaction, would obscure and confuse it. As a general rule, therefore, solutions of a moderate strength are to be preferred, such as 1 grain of carbazotic acid to 250 of water, and 1 grain of bichromate of potash to 100, the same of the red prussiate of potash, and of the nitro-prusside of sodium.”

Other than the alkaloids and volatile metallic poisons were found to yield sublimes when heated, as urea, uric acid, hippuric acid, alloxan, uramile, &c.; but these results scarcely prepared one to expect a sublimate from a blood-stain. Yet, on separating the fibres of a small spot of a cotton texture stained with blood about twenty-five years since, and submitting a section of the fibre an eighth of an inch long to heat, a figured pattern of the colour of blood was obtained, such as might be caused by a solution of blood in some thin oily liquid: this figured pattern was surrounded by a colourless border, having bright figured patterns such as those which mark the less characteristic portions of crystalline sublimes. Dr. Guy, on repeating his experiments, found the results constant; and on conducting them with care, and under the guidance of microscopic examinations, two sublimes were uniformly ob-

tained, the first colourless and apparently crystalline, the second, under a high temperature, of the colour of the blood-stain from which it was procured, and of the figured pattern mentioned.

Mr. Sorby's attention has been directed to obtain a definite method of qualitative analysis of "animal and vegetable colouring matters," and of animal substances generally, by means of the spectrum microscope. He has also so combined the spectroscope with the binocular microscope as to make it available for the purpose of distinguishing minute portions of coloured minerals in thin sections of rocks and meteorites. He employs an ordinary large binocular microscope, with an object-glass of about three-inches focal length, corrected for looking through glass an inch thick; the lenses being at the top, and as far as possible from the slit. This objective is placed at the focus, and between it and the lenses, at a distance of about half an inch from them, is a compound prism, composed of a rectangular prism of flint-glass and two of crown-glass, of about  $61^\circ$ , one at each end. This arrangement gives direct vision and a spectrum of a suitable size for these inquiries, since a wide dispersion often produces indistinctness of the absorption bands. That we may have the opportunity of comparing two spectra side by side, a small rectangular prism is fixed over half the slit, and with the acute angle parallel to it and passing beyond it.<sup>1</sup>

"This gives an admirable result, the only defect being that, when the spectra are in focus, their line of junction is some distance within it; and therefore to correct this employ a cylindrical lens of about two feet focal length, with its axis in the line of the slit, which can easily be fixed at such a distance between the slit and the prisms as to bring the spectra and their line of contact to the same focus. In front of the slit, close to the small rectangular prism, is a stop with a circular opening, to shut out lateral light, and a small achromatic lens of about half an inch focal length, which gives a better field, and counteracts the effect of the concave surface of the liquid in the tubes used in the experiments, if they are not

(1) Mr. Sorby's prisms and their arrangement have been entrusted to Mr Browning's skilful hands, who is prepared to adapt them to any microscope.

quite full. These are cut from barometer-tubes, having an internal diameter of about one-seventh of an inch, and an external diameter of about three-sevenths of an inch. They are made half an inch long, ground flat at each end, and fixed with Canada balsam on slips of glass two inches long and about six-tenths of an inch wide, so that the centre of the tube is about one-fourth of an inch from one edge. By this arrangement the liquid may be examined through the length of the tube by laying the slip of glass flat on the stage of the microscope, or through the side of the tube, by placing the slip vertical and the tube horizontal. Cells of this size can be turned upside down and deposits removed without any liquid being lost; and the upper surface of the liquid is sufficiently flat, even when inclined at a considerable angle. If requisite, small bits of thin glass can be laid on the top, which are held on by capillary attraction, or fastened on with gold-size, if it be desirable to keep the solution for a longer time. When the depth of colour is too great in the line of the length of the cell, we can at once see what would be the effect of about one-fourth of the colour by turning it sideways; and thus we can save much time, and quickly ascertain what strength of solution would give the best result. Very frequently an excellent spectrum is obtained in one direction with one reagent, and in the other with another, without further trouble.

“The scale of measurement consists of two small Nicol’s prisms, and an intermediate plate of quartz. If white light, passing through two such prisms, without the plate of quartz, be examined with the spectrum-microscope, it of course gives an ordinary continuous spectrum; but if we place between the prisms a thick plate of quartz or seknite, with its axis at  $45^\circ$  to the plane of polarisation, though no difference can be seen in the light with the naked eye, the spectrum is entirely changed. The light is still white, but it is made up of alternate black and coloured bands, evenly distributed over the whole spectrum. The number of these depends on the thickness of the depolarising plate, so that we may have, if we please, almost innumerable fine black lines, or fewer broader bands, black in the centre and shaded off at each side.

These facts are of course easily explained by the interference of waves. It would be impossible to have a more convenient or suitable scale for measuring the spectra of coloured solids and liquids. If we use a micrometer in the eyepiece, an alteration in the width of the slit modifies the readings, and the least movement of the apparatus may lead to error, whereas this scale is not open to either objection. Besides this, the unequal dispersion of the spectrum makes the blue end too broad, so that a given width, as measured with a micrometer in the eyepiece, is not of the same optical value as the same width in the red. The divisions in the interference-spectrum bear, on the contrary, the same relation to the length of the waves of light in all parts of the spectrum, and no want of adjustment in the instrument alters their position. As will be seen from the diagram (fig. 355), the unequal dispersion makes the distance between the bands in the blue about twice as great as in the red. The perfection of a spectrum would be one in which they were all at equal intervals; but possibly no such uniform dispersion could be produced. By having a direct-vision prism, composed of one of flint-glass of  $60^\circ$ , and two of crown-glass of suitable angle, we can place it over the eyepiece, and can diminish the dispersion at the blue end, or increase that at the red end, by turning it in one position or the other, and thus see either end to the greatest advantage.

“Since the number of divisions depends on the thickness of the interference-plate, it became necessary to decide what number should be adopted. Ten it was thought would be most suitable; but, on trying, it appeared to be too few for practical work. Twenty is too many, since it then becomes extremely difficult to count them. Twelve is as many as can be easily counted; it is a number easily remembered, gives sufficient accuracy, and has a variety of other advantages. With twelve divisions the sodium-line  $\bullet$  comes very accurately at  $3\frac{1}{2}$ ; and thus, by adjusting the plate so that a bright sodium-light is hid in the centre of the band, when the Nicol's prisms are crossed, it is accurately at  $3\frac{1}{2}$ , when they are arranged parallel, so as to give a wider field. The general character of the scale will



be best understood from the following figure, in which the bands are numbered, and given below the principal Fraunhofer lines. The centre of the bands is black, and



they are shaded off gradually at each side, so that the shaded part is about equal to the intermediate bright spaces. Taking, then, the centres of the black bands as 1, 2, 3, &c., the centres of the spaces are  $1\frac{1}{2}$ ,  $2\frac{1}{2}$ ,  $3\frac{1}{2}$ , &c., the lower edges of each  $\frac{3}{4}$ ,  $1\frac{3}{4}$ , &c., and the upper  $1\frac{1}{4}$ ,  $2\frac{1}{4}$ , &c., we can easily divide these quarters into eighths by the eye; and this is as near as is required in the subject before us, and corresponds as nearly as possible to 1-100th part of the whole spectrum, visible under ordinary circumstances by gaslight and daylight. Absorption-bands at the red end are best seen by lamplight, and those at the blue end by daylight.

On this scale the position of some of the principal lines of the solar spectrum is about as follows:—

A..... $\frac{3}{4}$	B..... $1\frac{1}{2}$	C..... $2\frac{3}{4}$	D..... $3\frac{1}{2}$
E..... $5\frac{1}{8}$	b..... $6\frac{3}{8}$	F..... $7\frac{1}{2}$	G..... $10\frac{3}{4}$

At first plates of selenite, which are easily prepared, were used, because they can be split to nearly the requisite thickness with parallel faces; but its depolarising power varies so much with the temperature, that even the ordinary atmospheric changes alter the position of the bands. However, quartz cut parallel to the principal axis of the crystal is so slightly affected in this manner as not to be open to this objection, but is prepared with far greater difficulty. The sides should be perfectly parallel, the thickness about  $\cdot 043$  inch, and gradually polished down with rouge until the sodium-line is seen in its proper place. This must be done carefully, since a difference of 1-10,000th inch in thickness would make it decidedly incorrect.

The two Nicol's prisms and the intervening plate are mounted in a tube, and attached to a piece of brass in such

a manner that the centre of the aperture exactly corresponds to the centre of any of the cells used in the experiments, which are all made to correspond in such a manner that any of them, or this apparatus, may be placed on the stage and be in the proper place without further adjustment, which, of course, saves much time and trouble.<sup>1</sup>

In the preparation of vegetable colouring matters for the spectroscope, care must be taken to employ a small quantity of spirits of wine; filter the solution, and evaporate it at once to dryness at a very gentle heat, otherwise if we attempt to keep the colouring matters in a fluid state they quickly decompose. It is necessary to employ various reagents in developing characteristic spectra. The most valuable reagent is sulphite of soda, which admits of the division of colours into groups. Of the mode of applying reagents, ample directions are given.

Mr. Sorby's qualitative analysis is just the kind of thing to employ in detecting adulterations in many substances met with in commerce, as well as in inquiries where very small quantities of material are at command. By this method we might be able in a few minutes to form a very satisfactory opinion, or at least one that might meet all practical requirements, and narrow the inquiry to a surprising extent; if this can be said even now, surely further research cannot fail to make it most useful in cases where ordinary chemical analysis would be of little or no use; for in this way we may be able to detect the presence of chlorophyll in some of the lower animal forms; as the amœba, hydra, &c., or, on the other hand, the red colouring matter of the blood, *cruorine*, in worms, molluscs, and insects. A number of colouring matters can be obtained, by using ether, from sponges, polyzoa, and the crustaceans; these, if examined in this way, may give unexpected results.

For further information on this interesting subject we must refer the reader to Mr. Sorby's paper "On a Definite Method of Qualitative Analysis of Vegetable and Animal Colouring Matter by means of the Spectrum Microscope," published in the *Proc. Roy. Soc.* No. 92, 1867.

(1) See a paper by Dr. Gladstone, on the Spectra of Solutions of Salts *Quart. Journ. Chem. Soc.* vol. xi. p. 86.

It would be a vain attempt were we to try to convey to our readers any idea of the great discoveries which have been made by the microscope, or of the important purposes to which it has been applied. Second only to the telescope, though in many respects superior to it, the microscope transcends all other instruments in the scientific value as well as in the social interest of its results. While the human eye, the telescope and microscope combined, enables us to enjoy and examine the scenery around us, to study the forms of life with which we are more immediately connected, it fails to transport us into the depth of space, to throw into relief the planets and the stars, and to indicate the forms and arrangements in the worlds of life and motion, which distance diminishes and conceals. To these mysterious abodes, so long unrevealed, the telescope has at last conveyed us. It has shown us those worlds and systems, of which our own earth and our own system are the types; but it fails to satisfy us entirely as we would wish respecting the nature and constitution of the celestial bodies, and the forms of life for which they are created.

In its downward scrutiny, as well as in its upward aspirations, the human eye has equally failed. In the general view which it commands of animal, vegetable, and mineral structures, it cannot reach those delicate organizations on which life depends, or those structures of inorganic matter from which its origin and composition can be derived. Into these mysterious regions, where the philosopher has been groping his way, the microscope now conducts him. The dark abodes of unseen life are lighted up for his contemplation,—organizations of transcendent beauty appeal to his wonder—new aspects of life, new forms of being, new laws of reproduction, new functions in exercise, reward the genius of the theoretical and practical optician, and the skill and toil of the naturalist. With wonders like these all nature is pregnant: the earth, the ocean, and the air—times past and times present, now surrender their secrets to the microscope.

What we know at present, even of things the most near and familiar to us, is so little in comparison of what we know not, that there remains an illimitable scope for our inquiries and discoveries; and every step we take serves to

enlarge our capacities, and give us still more noble and just ideas of the power, wisdom, and goodness of God. This marvellous universe is so full of wonders, so teems with objects of latent beauty, that perhaps eternity alone will open up and develop sufficient opportunities to enable us to survey and admire and appreciate them all.

“ And lives the man, whose universal eye  
Has swept at once th’ unbounded scheme of things,  
Mark’d their dependence so, and firm accord,  
As with unflinching accent to conclude  
That this availeth nought? Has any seen  
The mighty chain of beings, lessening down  
From infinite perfection to the brink  
Of dreary nothing, desolate abyss !  
From which astonish’d thought, recoiling, turns ?  
Till then, alone let zealous praise ascend,  
And hymns of holy wonder, to that Power,  
Whose wisdom shines as lovely on our minds  
As on our smiling eyes his servant sun.”—*TRACY, 1008*





## APPENDIX.

## THE MICROSCOPICAL EXAMINATION OF WATER.

It must have struck most persons, as it has myself, as a remarkable circumstance that water analysts should lay so much stress on the presence in water of chlorides, nitrates, and ammonia, when these compounds are inorganic and harmless. Why is it that, whereas a few years ago chemists said plainly, "This or that water contains so much organic matter," that now "organic matter" should be estimated from "organic elements," "oxygen consumed," or "albuminoid ammonia?" The reason of this change is, that the several processes which promised to verify the weight of organic matter in a water have proved very unreliable, and at the present time no process is known by which the actual weight of organic matter can be determined. So far as the public is concerned this is perhaps a misfortune, but to the chemist it is of less moment, for although the actual weight of organic matter cannot be determined, yet it is possible, by estimating the amount of organic carbon in water, or in some other way, to obtain a comparative measure of the quantity, while the presence of chlorine (sodium in the water) and of nitric acid and ammonia, act as tell-tales of the presence of sewage and animal matter respectively. No doubt, every step in a water analysis is undertaken with an object and reveals a fact. Although this may be very interesting when it is known, it is evidently a language that must be thoroughly understood and read before it can become of the slightest value to any one. It is almost impossible for any question about water to be broached without the analysis or report of some chemist or another being brought forward to refute and confound you; it is therefore

desirable that those who are called upon to advise on such matters should be able to appreciate the chemist's arguments, and criticize his data. To do so properly we must know something of the theory of water analysis, and must bear in mind, or have at hand, the arbitrary standards which experience suggests as valuable in classifying waters.

It is perfectly clear, however, that the organic matter found in water—that known to be most detrimental to health—is completely destroyed by chemical analysis, and, therefore, the conclusion arrived at by the chemist as to the wholesomeness of water is either misleading or entirely fallacious.

The organic matter in water may be either animal or vegetable, or the two may be combined; the first being the more dangerous contamination, and to distinguish between the two kinds is, after all, important. Both animals and plants yield albumen; and, chemically speaking, albuminoid matters, whether of animal or vegetable origin, are practically identical in composition. It is an admitted fact that "chemical analysis is one of the poorest things possible to rely upon as giving a true indication of the actual nature of organic matter, much less to reach the delicate quantities which show that a particular specimen of water is free from sewage or infective organisms." No analysis of water can be pronounced complete without having been first submitted to microscopical examination. For the detection of living organisms, and of germs believed to set up disease in the animal body, we must at all times have recourse to the microscope. The determination of the organic impurity of water by the microscope is of immense value, as by its aid we are in a position to say what has had access to it, and thus approximately measure its unwholesomeness.

The mode of examining specimens of water is as follows:—A Winchester quart bottle at least should be taken and stood by, in a warm, quiet place, for twenty-four hours. If, after standing twenty or thirty hours, no great amount of deposit is thrown down, recourse should be had to other means of collecting the suspended

matter. A tall white glass vessel, holding a gallon at least, must be filled and allowed to stand by forty-eight hours. When all the sediment is settled down, the water must be siphoned off, with the exception of just a sufficient quantity to permit of the residual sediment being shaken up and poured out into a conical glass. After standing a short time, small portions of the sediment may be dipped out with a pipette, dropped on to a glass-slide, and covered over with a thin glass cover. The thin glass cover tends to equalize refraction and spread the drop evenly out before it is placed under the microscope.

M. Certes, when dealing with small quantities of organic matter taken from water, and having only a very minute amount of sediment, employs osmic acid. This re-agent kills all animal life and blackens it; it is then more readily seen. A single drop of a half per cent. solution of osmic acid is quite sufficient. If used stronger it produces, by reason of its too rapid action, a shrivelling or charring of the organisms. For the better detection of bacteria and other minute bodies, dissolve ten grains of pure white sugar in ten ounces of the suspected water in a tall white glass measure, cover it over with muslin and let it stand exposed to light for forty-eight hours. If sewage be present the water will become turbid and a thin scum of bacteria form on the top.

Ranvier recommends the use of picro-carmin solutions, with glycerine for staining and colouring the living organisms in the water, and by means of which they are more easily detected. In this way the very minutest forms of life—bacteria, amœbiform particles of protoplasm, the delicate flagellæ, and the locomotive organs of Monads, will become visible under a high-angled one-eighth objective.

The sanitary import of such organisms as bacteria, their probable danger to health and life, their persistency and great power of multiplication, all tend to render them objects of deep interest to the physiologist and the medical practitioner. Bacteria have been long known to microscopists; their active vibratory motion have attracted the attention of every observer. From



their peculiar wriggling motion they were formerly called *Vibrios*; Nägeli named them "Schizomycetes." Whether they are fungi, algæ, belong to the genus *Oscillatoria*, or to the animal kingdom, is yet undecided.

Bacteria are sure to be found wherever albuminoid matter affords the material for sustaining life: in water, in blood, in animal juices and secretions of all kinds: in plants, in the sediment of waters, and upon glaciers or the highest mountains. They appear in abundance when organic matter is putrefying slowly and exposed to the air. Their spores float in the air in every region, and accumulate if the atmosphere is moist and but little disturbed. Thus bacteria are easily obtainable for investigation, but it is only by the highest powers of the microscope that it has been found possible to study their development and variations.

Most forms of bacteria once recognized—that is, after carefully conducted observations—can scarcely again be confounded with other bodies. Only the smallest forms of micrococci or spheroidal bacteria present much difficulty; these may be mistaken for inorganic matter. The chemical reaction of colonies of micrococci was pointed out by Weigert. The granular mass is insoluble in acetic acid, hydrochloric acid, caustic potash, glycerine, alcohol, chloroform, and oil of cloves, and is not killed by immersion in either of these agents. Hæmatoxylin alum solution colours the mass dark blue, as also does methyl violet solution if it is subsequently washed in dilute acetic acid.

So far, it appears that all bacteria consist of single cells, and consequently their forms are not very manifold. Four fundamental forms at least are recognized: the spheroidal, rod-shaped, thread-like and spiral.

The question naturally arises, are the different species true, and confined to one definite form, or can one species pass into that of another? Hallier saw the growth of bacteria into threads. Klebs saw the conversion of micrococci into bacteria, and these into contractile pigment granules. Billroth takes the fundamental form to be the spheroid bacteria—*Coccobacteria septica*; these are said to multiply by elongation and

division. Nägeli takes the same standpoint, and assumes the spheroid cell to be the fundamental form, likewise ascribing to it the power of elongation and transverse division. On the whole, the morphological distinctions of the different forms appear to Nägeli to be "too small;" whilst other investigators maintain the truly specific character of the different bacteria, Fitz distinguishes them as ethyl and butyl.

It is very generally believed that the forms are quite definite which produce the known fermentations of infective diseases; that these forms are not changed by grafting upon other substances. That they are confined within quite narrow conditions of life has been shown by experiments; for instance, Koch upon *Bacillus anthracis*, carbuncle bacillus; Klein, upon *Bacillus minimus*, in the typhoid of swine; Klebs and Tommase, upon *Bacillus malaricæ*, the excitant of malarial fever; Obermeyer, Heidenrich and others, upon forms of Spirochætes in relapsing fever, &c. A similar perplexity existed for years in distinguishing Diatomacæ. Many species based upon differences in size had to be abandoned when investigators became acquainted with their developmental history.

Hallier, a German botanist, having made a careful examination of bacteria, concluded that they were the cleavage of the nuclei of fungoid cells, and he claimed to place them amongst unicellular plants. Consuming oxygen and giving off carbonic acid, their mode of respiration certainly implies that they are more closely allied to animals than to plants. The disputed question of the animal or vegetable nature of bacteria was only a very small one amongst the many bones of contention that botanists and zoologists waxed warm over in the early days of the microscope. Some years before bacteria received any special attention, Dr. A. Farre (1842) observed a new and strange form of fever, and this he found was associated with and due to a tangled mass of green-coloured filaments. On closer examination these were seen to belong to the genus *Oscillatoria*, the fine threads of which measured about the 1-5000th of an inch in diameter. Subsequently

it was discovered that the spores of the confervæ had been swallowed in drinking-water. Soon after this a distressing stomach malady was discovered to be due to the growth of another unicellular plant, *Sarcina*. This, however, should rather be described as a compound cellular plant, the first simple cubical cell splitting up and dividing into many other cells, all being closely united together by a cellulose membrane, and increasing from one to two, four, eight, and sixteen, in regularly-arranged series. *Sarcinæ* are not easily killed—that is, they resist the action of strong acids, in this respect resembling the silicious frustules of diatoms. *Sarcina ventriculi* is believed to be nearly allied to, if not identical with, ferment fungus; it is doubtless the product of a contaminated water supply.

Another internal entophyta, which I am inclined to believe belongs rather to the genus *Oscillatoria* than to bacteria, is termed corkscrew-thread or spirilla. It is an extremely fine, cylindrical, filamentous organism, of rather sluggish habits, and of a very destructive nature. The supposed relation of spirilla to epidemic visitations of famine fever have been confirmed. The disease was first observed in the eastern parts of Europe and in India, where a certain recurrent form of fever is indigenous amongst a badly-fed people, and in the blood of those who have died corkscrew-like threads are invariably found. *Spirillum*, or famine fever, appeared at Berlin in 1872, and then it was that the attention of the medical profession became more particularly directed to it, and the exact relation between certain specific organisms present in the blood, and the contagium of this peculiar form of fever became fairly established. During the same year famine fever appeared in Breslau, and in more than a hundred cases spirilla were seen to almost completely block up the blood-vessels. In some instances a single drop of blood, placed under the microscope, was observed to literally swarm with minute undulating spiral rods. In India, the specific nature of the disease has been proved by the inoculation of quadrumanus with infected human blood.

Splenic fever, charbon, or anthracoid fever, is another

remarkable fever; the chief interest in which centres in the fact that the specific organisms which induce it are bacteria. Splenic fever attacks horses, cattle, sheep, rodents, and even man; it covers a wide range of country, extending over Europe, Asia, and Africa. In Russia, it is known as Siberian plague; in India, as the Pali plague; in Germany and Austria, where it is endemic as well as epidemic, as Milzbrand. In Zululand it was the cause of an enormous loss of horses, as many as fifty per cent. a week dying from the fever. The algoid, rod-like bodies discovered in the blood are from the 1-20,000th to the 1-40,000th of an inch in diameter. When acted upon by a fluid of less density than blood, and near to the commencement of the putrefactive process, they break up into spheroids, each with a slightly darker spot or nucleus in the centre. A striking feature of the disease is its very rapid progress. An animal is observed to refuse its food, this is followed by a shudder, a convulsive or apoplectic fit, and in the course of a few hours it will be dead. The symptoms are accounted for by the rapidity of multiplication of bacteria in the blood.

For the preservation of bacteria Koch's method is the best. It consists in drying the liquid containing the bacteria in a very thin layer upon slips of glass, so as to fix the bacteria in a plane, treating this layer with the colouring material, and then again moistening it to restore the bacteria to their natural form and make them distinctly perceptible, so that the preparation may be enclosed in a preservative liquid and finally mounted in glycerine. Glass slips with dried bacteria last for a long time, and can be transmitted by post. For the moistening of the layer Koch uses a solution of one part of acetate of potash in two of water. In this solution the bacteria assume their original form without becoming loosened from the glass. For colouring he uses a mixture of a few drops of a concentrated spiritous solution of fuschin or methyl violet with 15 to 30 grams of water. Preparations so coloured may be mounted in concentrated solution of acetate of potash or in Canada balsam.

## THE EXAMINATION OF RIVER-WATER.

At the present time, the Thames basin drains more than two and a half million acres of land, the greater portion of which is highly cultivated and heavily manured. It might be safely predicted, on taking specimens of water from any part of the river, that it will contain organic impurities, in suspension and solution. A bottle of Thames water, taken near Windsor in the spring of 1881, abounded in various species of animal life. On standing the bottle in the light, in a very short time a considerable sediment was deposited, consisting of vegetable, animal, and mineral matters. On removing a drop with a pipette, and placing it under the microscope, numerous portions of confervæ, diatoms, decaying vegetable matter, the outer cases of entomostraca, &c., were visible, and apparently only very few of the minuter kinds of animal life. Allowing the water to stand by some forty-eight hours, exposed to light and warmth, another dip was taken, and a higher magnifying power used, when a number of embryos were seen moving about the field, the more noxious of which were minute filiform nematode worms, *Chaetogaster lymnæus*, *Anguillula fluviatilis*, *Hydra fusca*, Thames mud-worm, *Cyclops quadricornis*, *Daphnia pulex*, Paramœcium, pupa of culex, bacteria, &c. Now, considering how little the Thames had been disturbed by floods or rains during the previous three or four weeks of April and May, it must be admitted that this small quantity of water, containing, as it did, the ova and embryos of animals, constituted a serious amount of contamination. The habits, or rather the natural history, of some of these creatures are well worth a careful examination. First, nematode worms; these have obtained an unenviable notoriety amongst the greater pests of animal life. The typical form of filarian worms is the thread-worm: this affects human beings, sheep, and other ruminants, as well as several kinds of birds. There are eight or ten different kinds belonging to the genus, and some of which, like *Fasciola hepatica*, fluke, change their hosts once or more before attaining

to sexual maturity. One species of filaria penetrates

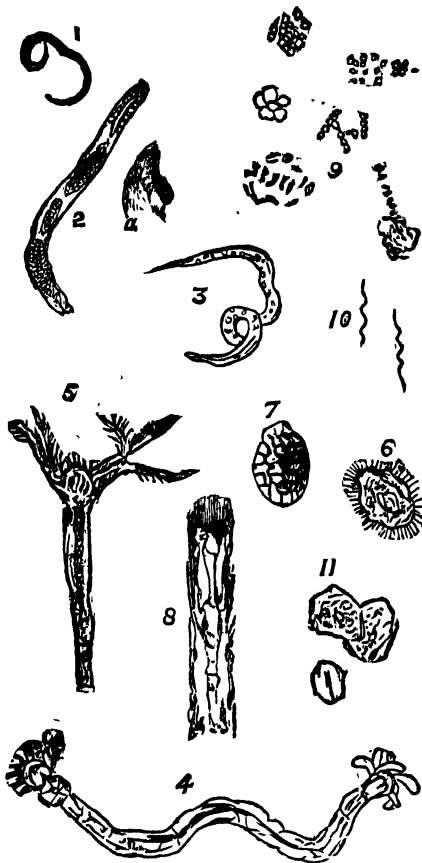

1. Filarian worm ; 2. *Chaetogaster lymnaeus* ; 2a. Enlarged head of same ; 3. *Anguillula fluviatilis* ; 4. Thames mud-worm ; 5. *Hydra fusca* ; 6. Paramoecium (engraver has made it too irregular in outline: it is nearly ovoid) ; 7. Egg of culex ; 8. Pupa of *Chironomus viridulus* ; 9. Bacteria ; 10. Spirilla ; 11. Starch and epithelium scales. The various objects magnified from 5 to 350 diameters.

the bronchial tubes of sheep, producing a debilitating

kind of cough; in lambs filarian worms accumulate rapidly in the air-passages and lungs, and a number of animals perish annually from what is called "the lamb disease." The worm represented in fig. 1 is the much-dreaded *Trichina spiralis*. This nematode worm derives its name from the circumstance that it was found spirally encysted in the flesh of pigs. It is usually found curled up in a spiral form in the middle of the large muscles. Before attaining to the encysted stage, it has a free existence, lives an aquatic or wandering life, and hides in moist situations or in bogs. It very closely resembles the filarian worm *Anguillula fluviatilis* (fig. 3). Very many of the Anguillulidæ are parasitic upon water-snails, slugs, earthworms, and the larvæ of insects. They are remarkable for their tenacity of life, resisting the extremes of heat and cold.

*Trichina spiralis* infests man and numerous warm-blooded animals—the pig, dog, rabbit, rat, &c. In forty-eight hours after the embryos are taken into the stomach they attain to maturity. They are most active little worms, in four days are full-grown, and are then rapidly carried by the blood-current and deposited in the muscles in almost every part of the animal body. The nature of the fever produced by these terrible parasites is as remarkable as it is fatal.

Another species of filarian worm, found in Thames water, is named by Von Bæer *Chætogaster lymnæus* (fig. 2), from its having been first observed crawling over water-snails, Lymnæus, and Planorbis. These worms are often found in specimens of Thames water, and they attract attention from their rapid, caterpillar-like motion over the body of their host. *Chætogaster lymnæus* is a very translucent, thread-like, whitish worm. The oral aperture is capable of a considerable amount of distension, like that of the eel. Its action is very rapid, and its body so transparent, that it is a difficult matter to trace the nervous system. It is affirmed by some observers that it feeds upon cercariæ. I cannot, however, confirm this observation, but I have seen its stomach filled with diatoms. *Chætogaster* are found in the body of the common

earthworm. Amongst other larvæ which abound in Thames water are the well-known blood-red Thames mud-worm. This worm is familiar to Londoners, as it not only finds its way into cisterns, but is frequently observed during the summer months covering the mud-banks at low water, and imparting to the mud a deep blood-red colour. The presence of mud-worms certainly indicates a dangerous contamination; their favourite breeding-haunts being the sewage-polluted mud-banks of rivers. The larvæ of the genus *Culicidæ*, especially that of *Chironomus viridulus* (fig. 8)—a very minute species of the gnat tribe, are at certain periods numerous. This larva, unlike most other species, builds up a brown tubular case, which it anchors to the bottom or side of the bottle. Therein it very quietly secretes itself. In a few days' time its larval stage is completed, and it becomes transformed into the imago, and towards evening, just as the sun is declining, it quits its dwelling and floats up to the surface of the water, and, having fairly balanced itself, it spreads its gossamer wings and flies away. The head of the male is surmounted by a pair of plumose antennæ, which are long and delicate. The body is of a pale green colour, apparently destitute of scales or feathers, a well-known characteristic of *Culicidæ*. All the gnat tribe, inclusive of the dreaded mosquito of the tropics, lurk and thrive in malarious and fever-stricken localities. The eggs of *Chironomus viridulus* are extremely minute, about the 1-100th of an inch in size (fig. 7). It may be remarked of gnats, that, like vultures, they are bred amongst carrion.

As usual, the smaller crustaceans, entomostraca, &c., are found in large numbers in Thames water.<sup>1</sup> In warm weather, and as soon as the temperature of all river-water reaches 60° Fahr., *Daphnia pulex* increase with amazing rapidity, and if swallowed may produce diarrhœa and dysentery. In Boston, America, the water at one time was much infested by water-fleas, and the consumers of the water suffered from fatal attacks of summer cholera. At Dorpat, Sweden, an epidemic

(1) See a paper by the author in the *English Mechanic*, April 30, 1850.



visitation of a peculiar fever was clearly traceable to the presence of *Paramecium* (fig. 6); and numerous deaths were attributable to them. Frogs, newts, and other aquatic animals have been killed by these noxious creatures. The water of the Firth of Forth is frequently seen, in summer time, deeply coloured by moving masses of minute crustaceans. To some rivers and seas they impart a deep red colour. The rate of increase of daphnia and cyclops is truly surprising. Such is their amazing fecundity, as estimated by the late Dr. Baird, that a single pair of *Cyclops quadricornis* will, in the course of six months, produce a progeny numbering four billions five hundred millions (4,500,000,000). A large number of species of entomostraca are parasitic on marine and freshwater fish. It is contended, however, that they attack the sickly, and so make way for the "survival of the fittest." Probably this is so, unless it will be conceded that the sickness of the fish is a consequence of the presence of the parasite. Fish thus afflicted are said, by fishermen, to be "lousy." A vegetable parasite, the *Saprolegnia*, is the cause of the Salmon disease, producing a sort of leprosy over the body of the fish.

Thames water favours the presence of hydroid polyps; consequently, various species of hydra may be found adhering to pieces of weed and decaying vegetable substances. Fig. 5 is a full-grown *Hydra fusca*. Starch granules and epithelium (fig. 11) are held in suspension, and nearly always form a small portion of the sediment of sewage-polluted river-water. Such bodies can in no way be estimated by chemical analysis, as they only form a minute part of any residual ash. Starch enters largely into the food of animals, and it may be assumed that this albuminoid product must have been conveyed into river-water in the excreta of animals.

The microscopical analysis of water is a large and very important one, and those of my readers who wish for further information on the subject will do well to consult Dr. J. D. Macdonald's "Guide to the Microscopical Examination of Drinking Water," published by Churchill.

# INDEX.

- ABERRATION, chromatic, 82.**  
 — of lenses, 68.  
 — how corrected, 68.  
 — spherical, 81.
- Abbe, Professor, on aperture, 75.**  
 — binocular eye-piece, 119.
- Absorption bands of blood, 131.**
- Acalephæ, 491.**
- Acarina, 632**
- Acarus beetle, 455.**  
 — cloth moth, 641.  
 — domesticus, 637.  
 — of dog, 634.  
 — farinæ, 639.  
 — of fly, 641.  
 — of fowl, 640.  
 — of rat, 634.  
 — sacchari, 638.  
 — scabiei, 635.  
 — of swallow, 639.
- Achetina, 627.**
- Achnanthes Longipes, 420.**
- Achorion, 296.**
- Achromatic condenser, the, 176.**  
 — Gillett's, 177.  
 — Ross's improved, 178.  
 — Beck's, 179.  
 — Swift's, 181.  
 — Hyde's, 184.  
 — object-glasses, 80.
- Acineta-form infusoria, 401.**  
 — vorticella, 447.
- Acineta tuberosa, 411, 449.**
- Actinia actinozoa, 465.**  
 — bellis, 484.  
 — rubra, 483.
- Actiniferum zoophytes, 465.**
- Actinophrys sol, 374.**
- Actinotrocha, 578.**
- Actinozoa, 485.**
- Adams' microscope, 10.**
- Adipose tissue, 693.**
- Adulteration of food, 345.**
- Æcidium, 298.**
- Æcistes, 451.**
- Agates, 399.**
- Alcyonella stagnorum, 526.**
- Alcyonidæ, 489, 524.**
- Alcyonium digitatum, 489.**  
 — polypidoms, preparation of, 509.
- Alder, section of, 334.**
- Algæ, development of, 269.**
- Alkaloids, sublimation of, 781.**
- Amici's microscopes, 12.**  
 — prisms, 187.
- Amphistome conicum, 565.**
- Amphitetras, 416.**
- Amœba, 378.**
- Amœboid stat. of volvox, 277.**
- Anacharis alsinastrum, 321.**
- Analysis, spectrum, 735.**
- Angle of aperture, 69.**  
 — measurement of, 75.
- Anguillulæ, 571**
- Anguinaria spatulata, 520.**
- Animalcule, Sun, 374.**
- Animalcules, 402.**  
 — collecting bottle, 193.  
 — history of, 405.  
 — infusorial, 414.  
 — troughs and cells, 195.
- Animal cell, 659.**  
 — action of cilia in, 671.  
 — cells, change into tissues, 668.  
 — cellular membrane, 692.  
 — connective tissue, 662.  
 — elementary substance, 659.  
 — epithelium, 668.  
 — fibrous tissue, 694.  
 — kingdom, division of, 366.  
 — life, 655.  
 — structure, 661.  
 — structure, mode of invest-  
 gating, 724.  
 — tissues, classified, 692.  
 — tissue consolidated, 702.  
 — tissues, staining, 225.
- Annelida, 575.**
- Annulosa, 569.**
- Anobium, 633.**
- Antennæ of insects, 607.**
- Anthony's, Dr., diaphragm, 169.**
- Aperture of the object-glass, 69.**  
 — numerical, 73.
- Aphides, 618.**
- Aphrophora bifasciata, 615.**
- Aplanatic doublet lens,**
- Aplysia, 529.**
- Apparatus for mounting, 210.**
- Aquatic box, 194.**
- Arachnida, 631, 644.**
- Arachnoidiscus, 482.**
- Arcella acuminata, 372.**
- Archer on amœboid bodies, 277.**
- Arenicola, 576.**
- Aristophanes, microscope known to, [?]**
- Artemis, 557.**
- Articulata, 579.**
- Asci of lichens, 305.**
- Aspergillus, 301.**
- Astasia, 412.**
- Asteroides, 495.**
- Atlantic soundings, 382.**
- Atropus, 623.**
- BACILLARIA paradoxa, 209.**

- Bacteria**, 411, 746.  
 Baird, Dr., on entomostraca, 557.  
 Baker on the microscope, 10.  
 Baker's microscope, 98.  
 — dissecting microscope, 200.  
 Balanidæ, 535.  
 Balbiani, Dr., on paramæcium, 410.  
 Barnacle, 554.  
 Bartley's warm stage, 146.  
 Bat, head of, 681.  
 Beale, Dr., on cell development, 659.  
 Beck's microscope, 94.  
 — achromatic condenser, 179.  
 — cell-making instrument, 209.  
 — double nose-piece, 96.  
 — lamp, 190.  
 — opaque disc-revolver, 188.  
 — side-reflector, 189.  
 Bee's eye, 586.  
 — tongue, leg, &c., 612.  
**Beetles**, 623.  
 — bacon, 624.  
 — diamond, 622.  
 — tortoise, 528.  
 — water, 625.  
 Bell-animalcule, 445.  
 Berg-mehl, 432.  
 Bergh, Dr., on urticating organs, 545.  
 — on podura scales, 628.  
 Berkeley on two new British fungi, 304.  
 — on fungi, 290.  
 Beroë, 492.  
 Biddulphia, 487.  
 Bilharzia hæmatobra, 567.  
 Binocular microscope, 116.  
 Bird's-head coralline, 518.  
 Bleaching sections, 246.  
 Blood-corpuscles, 678.  
 — crystallization of, 680.  
 — disc, size of, 680.  
 — spectrum, 131.  
 — vessels, structure of, 688.  
 Blow-fly, 590.  
 Bockett's lamp, 164.  
 Bone, 714.  
 — cutting sections of, 205.  
 — eel, 716.  
 — fishes, 719.  
 — human, 718.  
 — ostrich, 715.  
 — reptiles, 714.  
 — sting ray, 718.  
 Bot-fly, egg of, 607.  
 Botrytis, 301.  
 Bourgingnon, Dr., on acarus scabiei, 685.  
 Bowerbank on sponges, 386.  
 Bowerbankia, 512.  
 Brachionus, 455.  
 Brachiopoda, 535.  
 Brewster, Sir David, diamond lens, 11.  
 Brightwell on navicula, 419.  
 Brooke's double nose-piece, 96.  
 Browning's microscope, 99.  
 Browning's spectro-microscope, 123.  
 Bryozoa Bowerbankia, 512.  
 Buccinum undatum, palate, 538.  
 Bull's-eye condenser, 189.  
 Burnett, Dr., on parasites, 639.  
 Busk, Mr., on anguinaris spatulata, 520.  
 — on echinococci, 570.  
 — on starch granules, 342.  
 — on volvox, 276.  
 Butte fls., eggs of, 605.  
 — tubes of, 607.  
**CALCIFICATION of animal tissues**, 552.  
 Calepteryx virgo, 597.  
 Callithamnion, 273.  
 Canera-lucida, 132.  
 Campanularia volubilis, 481.  
 — gelatinosa, 481.  
 Campilodiscus clypeus, 439.  
 Cancer-cell, 296.  
 Canc., section of, 341.  
 Capillaries, 689.  
 — in fat, 691.  
 Carbolic acid fluid, 220.  
 Carbonate of lime in shell, 528.  
 Carpenter, Dr., on volvocineæ, 275.  
 — on diatomacææ shell, 553.  
 — on eozoon, 379.  
 — on tomopteris, 576.  
 Carter, Mr., on chara development, 318.  
 — on spongilla, 391.  
 Cartilage, 702.  
 — from ear of mouse, 702.  
 — rabbit's ear, 703.  
 Cassida viridis, 588.  
 Cedar, stem of, 357.  
 Cell formation, 659.  
 — action of, 667.  
 — animal, 660.  
 — changes, 258, 661.  
 — changes in disease, 664.  
 — contents, 662.  
 — development, 239, 659.  
 — making, 209.  
 — mounting, 216.  
 — nucleus, 663.  
 — pigment, 671.  
 Cells, complicated, 667.  
 — for desmids, 230.  
 — growing, 195.  
 — motile, 261.  
 — vegetable, 257.  
 Cellularia, 518.  
 — avicularia, 518.  
 Cellular tissue of plants, 322.  
 — in animals, 662.  
 Cements, 246.  
 Cementing, method of, 221.  
 Cephalopod, tongue of, 540.  
 Cephalopoda, 550.  
 Cephalosiphon, 451.  
 Characææ, 315.  
 — antheridia of, 317.  
 — development, 312.

- Chesne-mite**, 637.  
**Chemical re-agents**, 225.  
**China-grass**, 353.  
**Chitonidae**, 537.  
**Chloride of gold**, 701.  
**Chloroform and balsam mixture for mounting**, 223.  
**Cilia**, 404, 671.  
   — movement of, mode of exhibiting, 406.  
**Ciliated epithelium**, 670.  
**Cimex lecticularis**, egg of, 117.  
**Circular disc**, 209.  
**Circulation of blood in frog, to view**, 682.  
**Cirrhopoda**, 554.  
**Clarke, Lockhart, on the preparation of spinal cord**, 761.  
**Clematis**, section of, 333, 357.  
**Clopsinidae**, 574.  
**Clonæ**, 395.  
**Clip for mounting**, 211.  
**Closterium lunula**, 285.  
**Clothes moth**, 612.  
**Clypeastrodea**, 501.  
**Coal, structure of**, 363.  
**Cobbold, Dr., on helminths**, 567.  
**Cocconema**, 437.  
**Coccus persicae**, 604.  
   — egg of, 605.  
**Cochineal insect, its value**, 651.  
**Cocoa, adulteration of**, 346.  
**Coddington's lens**, 38.  
**Coelenterata**, 462.  
**Coffee, structure of**, 347.  
**Cohn on stephanosphaera**, 265.  
**Cole's stained specimens**, 242.  
**Coloptera**, 622.  
   — bottle, 193.  
   — net, 193.  
**Collins's microscope**, 105.  
   — mounting cabinet, 254.  
**Colloidion casts**, 58b.  
**Comatula**, 496.  
**Compressorium**, 194.  
**Condensers, Beck's achromatic**, 179.  
   — Collins's, 188.  
   — Gillett's, 177.  
   — oil immersion, 185.  
   — Powell and Lealand's, 180.  
   — Ross's, 178.  
   — Swift's, 181.  
**Confervoides**, 267.  
**Conjugation in desmids**, 279.  
**Conchillus**, 448.  
**Consolidated tissues**, 702.  
**Cook, Dr., on staining**, 236.  
**Coral reefs**, 491.  
**Corals**, 490.  
**Cordylophora**, 463.  
**Corethra plumicornis larva**, 600.  
**Corn-blights**, 293.  
**Corymorpha nutans**, 476.  
**Coryne-stauridia**, 475.  
**Coscinodiscus**, 440.  
**Cosmarium**, 282.  
**Crab-hell**, 523.  
**Crayfish**, 553.  
   — shell of, 553.  
**Cricket**, 627.  
**Crinoidea**, 505.  
**Crisiadae**, 519.  
**Cristatella mucedo**, 324.  
**Crustacea**, 554.  
**Crystals, formation of**, 720.  
   — mode of showing optical axis, 146.  
   — of snow, 153.  
**Cuckoo-spit**, 615.  
**Culex pipiens**, 598, 612.  
**Cutleria dichotoma**, 273.  
**Cutting sections**, 203.  
**Cuttlefish-bone**, 546.  
**Cyclops**, 556.  
**Cymba olla, tongue of**, 542.  
**Cymbella Ehrenbergii**, 418.  
**Cynips gallæ**, 618.  
**Cypridae**, 556.  
**Cystic disease of liver**, 570.  
**Cysticercus fasciolaris**, 564.  
   — pisiformis, 564.  
**Czermak on tooth substance**, 711.  
**DALLMEYER'S objective**, 81.  
**Dalyell, Sir J. G., on tubularidæ**, 474.  
   — on actinidæ, 467.  
**Dana, Prof., on corals**, 490.  
**Daphnia pulex**, 557.  
**Darker's solenito stage**, 148.  
**Dark field illuminators**, 172.  
**Darwin on infusoria**, 433.  
**Dasya Kützingiana**, 272.  
**Davis on a new rotifer**, 451.  
**Death-watch beetle**, 623.  
**De Bary on fungi**, 291.  
**Deep-sea soundings**, 381.  
**Defining power of objectives**, 58.  
**Delabarre's microscope**, 10.  
**Delessaris**, 274.  
**Demodex folliculorum**, 637.  
**Dentine**, 707.  
**Deparia prolifera**, 313.  
**Dermestes lardarius**, 624.  
**Dermestidæ**, 624.  
**Designing from microscopic forms**, 440.  
**Desmidiaceæ**, 278.  
   — finding and preserving, 268.  
**Deutzia scabin**, 339.  
**Diamond beetle, scales of**, 622.  
**Diaphragm, description of**, 169.  
   — Dr. Anthony's stage, 169.  
   — the Iris, 170.  
**Diatomaceæ**, 416.  
   — Kützing on, 417.  
   — on collecting, 428.  
   — their value as tests, 63.  
**Diatoms, movements of**, 423.  
**Diffugia**, 372.  
**Diplopoda**, 404.  
**Dipping tubes**, 192.

**Directions for mounting and pre-**  
**paring objects, 211.**  
**Dissecting knives and needles, 202.**  
 — microscopes, 199.  
 — scissors, 201.  
**Distoma, 567.**  
**Divini's microscope, 7.**  
**Doris tuberculata, palate of, 538.**  
**Dragon-fly, 597.**  
**Draper's microphotographic appa-**  
 **ratus, 161.**  
**Drone-fly, 591.**  
**Dytiscus marginalis, 626.**  
 — sucker from leg of, 588.  
  
**ECHINIDÆ, 498.**  
**Echinococci, 569.**  
**Echinodermata, 494.**  
**Echinorhynchus, 571.**  
**Ecker, on protozoa, 373.**  
**Eel, scales of, 722.**  
**Eggs of insects, 602.**  
 — of gasteropoda, 545.  
**Egyptian cloth, 354.**  
**Ehrenberg's brachionus, 455.**  
 — on boundary between plants  
 and animals, 655.  
**Elder-root, section of, 343.**  
**Elm, section of, 356.**  
**Enamel, 709.**  
**Enchondroma, 704.**  
**Encrinus, 506.**  
**Entomostraca, 555.**  
**Entozoa, 565.**  
**Eozoon canadense, 376.**  
**Epeira diadem, 645.**  
**Epithelium, tessellated, 608.**  
 — columnar, 670.  
**Equisetaceæ, 311.**  
**Equisetum, section of, 332.**  
**Errors of interpretation, 165, 723.**  
**Escharidæ, 521.**  
 — foliacea, 522.  
**Euastrum, 280.**  
**Eucratiadæ, 519.**  
**Euglena, 412.**  
**Eunotia, 437.**  
**Euphorbia nerifolia, 329.**  
**Euplectella, 402.**  
**Eye-glasses, their value 56.**  
**Eye, human, vessels in, 689.**  
 — pigment, 672.  
 — section of cat's, 689.  
**Eye-pieces, 47.**  
 — Huyghenian, 48.  
 — micrometer, Jackson's, 52.  
 — Ramsdon, 51.  
 — stereoscopic, 71.  
**Eyes of insects, 584.**  
  
**FASCIOLA HEPATICA, 506.**  
**Fat cells, 694.**  
**Favus fungus, 296.**  
**Feather-star, 496.**  
**Feet of insects, 587.**  
**Ferns, 311.**

**Ferns, section of root, 338.**  
**Fibre, muscular, 695.**  
 — in the tongue, 697.  
 — involuntary, 698.  
**Fibrous tissue, 693.**  
 — white and yellow, 694.  
**Finders, Amyot's, 191.**  
 — Maltwood's, 192.  
**Finger, mechanical, 218.**  
**Fishes' scales, 721.**  
**Flax, 353.**  
**Flea, 630.**  
 — cat's, 634.  
 — larva of, 634.  
**Flora of coal measure, 364.**  
**Floridæ, 271.**  
**Flower buds, 351.**  
**Flowers, colouring matter of, 352.**  
**Flukes, 565.**  
**Floscularia ornata, 458.**  
**Flosculariæ, 453.**  
**Flustræ, 521.**  
 — avicularis, 523.  
 — chartacea, 523.  
 — foliacea, 522.  
**Fly, foot and leg of, 587, 591.**  
 — tongue, 595.  
 — fungoid disease of, 596.  
 — Tsetse, of Africa, 596.  
**Follicles of pig's stomach, 669.**  
**Foraminifera, 375.**  
 — fungasina, section of, 380.  
 — fossil, 377.  
 — skelotons of, 381.  
**Forceps for dissecting, 201.**  
**Fossil infusoria, 431.**  
 — mode of preparing, 434.  
 — plants, 362.  
**Fragillaria pectinialis, 437.**  
**Frauenhofer's glasses, 10.**  
 — lines, 738.  
**Frog-plate, 682.**  
 — bit, 321.  
 — circulation, 679.  
 — hopper, 615.  
**Frustulia Saxonica, 423.**  
**Funaria, capsule of, 309.**  
**Fungi, 290.**  
 — Berkeley on, 290.  
 — De Bary on, 291.  
 — floating, 295.  
**Fungia, 484.**  
**Fungoid growths, 296.**  
  
**GALL-FLY, 618.**  
**Gallionella sulcata, 438.**  
**Garrod's, Dr., crystals in blood, 682.**  
**Gasteropoda, 537.**  
 — lingual bands of, 538.  
**Gemmules of sponges, 400.**  
**Geodia Barretti, 390.**  
**Gilbert's staining process 242.**  
**Gillett's condenser, 177.**  
**Gill of tadpole, circulation in, 636.**  
**Glass-cells for mounting, 216.**  
**Glass-ropo sponge, 401.**

- Glaucoma, 414.**  
**Globigerina, 384.**  
**Glossina morsitans, 596.**  
**Glycerine for mounting, 247.**  
 — Rimmington's, 219.  
**Gnat, description of, 598.**  
**Gnat's scale, 612.**  
**Goadby's fluid, 223.**  
**Gomphonema, 419.**  
**Goniometer, Schmidt's, 56.**  
**Gordiacea, 562.**  
**Gorgonidae, 487.**  
 — spiculæ from, 487.  
**Gorham, T., on eyes of insects, 584.**  
**Gosse on notommata, 456.**  
 — on cellularia, 518.  
 — on coryne stauridia, 475.  
 — on melicerta ringens, 459.  
**Gourd seed, section of, 335.**  
**Graminaceæ, 340.**  
**Grant, Dr., on flustra, 521.**  
 — on alcyonida, 489.  
 — on plumularia, 478.  
 — on sponges, 386.  
**Grass, cuticle of, 339.**  
**Gray, Dr., on mollusca, 539.**  
**Gregarina of earthworm, 270.**  
**Gregarinida, 367.**  
**Groves on staining, 230.**  
**Growing cell, 196.**  
**Guinea-worm, 563.**  
**Gulliver on raphides, 337.**  
 — on blood discs, 679.  
**Guy, Dr., on sublimation, 731.**  
**Gyrinus, paddle of, 625.**
- HAILES' section-cutting machine, 203.**  
**Hair, human, 672.**  
 — bat, Indian, 673.  
 — gregarines in, 369.  
 — moss, 311.  
 — mouse, 673.  
 — peccari, 674.  
**Haliotus splendens, 576.**  
 — tuberculatus, tongue of, 543.  
**Hallifax, Dr., on preparing insects, 604.**  
**Hard tissues, preparation of, 205.**  
**Hardening, preserving, and section-cutting, 237.**  
**Hartea elegans, 524.**  
**Hassall, Dr., on the adulteration of food, 319.**  
**Hemfrey, Prof., on ferns, 313.**  
**Hemp, 353.**  
**Hepaticæ, 308.**  
**Hepworth, Mr., on mounting insects, 648.**  
**Hera path's, Dr., polarising crystal, 143.**  
 — on polarisation as a test, 140.  
**Hermia glandulosa, 475.**  
**Herschel's aplanatic doublet lens, 33.**  
**Hicks, Dr. B., on amoeboid bodies, 227.**  
 — on lichens, gonida of, 306.  
**Highley's photographic camera, 159.**  
**Hill's microscope, 10.**
- Hipparchia janira, 611.**  
**Hirudinidae, 573.**  
**Holman's life-cell, 196.**  
 — syphon slide, 197.  
**Holothuridae, 508.**  
 — drawing of, life-size, 567.  
**Honey-bee, 620.**  
**Hooker's microscope, 7.**  
**Horn, rhinoceros, 721.**  
**Human body, composition of, 659.**  
**Huxley, T. H., on animal tissues, 656.**  
 — on actinozoa, 468  
 — on echinidae, 494.  
 — on tongue of mollusca, 538.  
 — on rotifers, 560.  
 — on tooth development, 706.  
**Huyghenian eye-piece, 48.**  
**Hyalonema, 401.**  
**Hydatids, 670.**  
**Hyde's condenser, 183.**  
**Hydra, 446, 466, 470.**  
**Hydrachnidae, 642.**  
**Hydractinia, 473.**  
**Hydrophilus, trachea of, 567.**  
**Hymenoptera, 616.**  
 — aquatic, 626.
- ICELAND SPAR, 137.**  
**Illumination, test of, 164.**  
**Immersion system, 81.**  
 — Condenser, 185.  
 — Homogeneous, Powell's, 86  
 — Stephenson on the, 83.  
**India-rubber tree, 329.**  
 — section of leaf, 334.  
**Indicators, 191.**  
**Infusoria, 402.**  
 — cilia, 405.  
 — fossil, 431.  
 — history of, 403.  
**Infusorial animalcules, 402.**  
 — Pasteur's researches on, 414.  
**Injecting, 248.**  
 — different systems of vessels, 250  
 — lower animals, 251.  
**Injections, transparent, 251.**  
**Insects, 579.**  
 — commercial importance of, 657.  
 — dissection of, by Swammerdam, 579.  
 — transformations of, 646.  
 — wings of, 597.  
**Insects' eggs, 602.**  
 — eyes, 584.  
 — feet, 587.  
 — hairs, tenent, 589.  
 — heads, 582.  
 — injecting, 240.  
 — itch, 635.  
 — ovipositors, 616.  
 — preparing and mounting 676  
 648.  
 — proboscis, 599  
 — spiracles, 586.  
 — stings, 619.  
 — tongues, 582, 607.

- Interpretation, errors of, 165.  
 Intercellular substance, 662.  
 Iris-leaf, 336.  
 Isthmia enervis, 432.  
 Ivory nut, section of, 350.  
 Ixodidae, 642.
- JACKSON'S** micrometer, 53.  
 Jelly-fish, 491.  
 Johnstone, Dr., on sponges, 385.  
 — on campanularia, 481.  
 — on hydra, 471.
- Jones, Wharton, on non-striated muscular fibre, 698.  
 — Rymer, on the corethra plumicornis, 600.  
**Jungermannia bidentata**, 310.
- KAISER'S** glycerine gelatine, 220.  
 Knives for dissecting, 202.
- K lliker on the muscles of the skin, 693.  
 K tzing on vegetables and animals, 256.  
 — on diatomaceae, 417.
- LADD'S** microscope, 115.  
 Lamps, Microscope, 190.  
 Lamp-shells, 535.
- Lankester, E. R., on Gregarina Lumbrici, 370.
- Lathe for polishing, 206.  
 Leaf-insect, 613.
- Leech, medicinal, 573.
- Leeuwenhoek's microscope, 6.  
 Lenses, amplification of, 57.  
 — angular aperture of, 69.  
 — chromatic aberration of, 32.  
 — concavo-convex, 31.  
 — condensing, 198.  
 — correction of, 63.  
 — curvature of, 29.  
 — double convex, 26.  
 — forms of, 26.  
 — magnifying power of, 34.  
 — meniscus, 29.  
 — periscopic, 38.  
 — plano-convex, 28.  
 — platyscopic, Browning's, 39.  
 — refraction of light through, 37.
- Lepidoptera**, eggs of, 605.  
 — tongue of, 608.  
 — wing-scales of, 609.
- Lepisma**, 529.  
 — scale of, as a test, 166.
- Lepralia nitida**, 517.
- Leuchart on echinorhynchus, 571.
- Lewes on actiniae, 467.  
 — on life, 655.  
 — thread cells, 467.
- Libellulidae**, wings of, 597.
- Lichens, 304.
- Lieberk hn**, Dr. N., on gregarina, 369.  
 — on spongilla, 389.  
 — the speculum of, 187.
- Life, animal, 655.
- Light, polarisation of, 133.
- Limax rufus**, 529.
- Limn ea stagnalis**, 545.
- Limnias ceratophylli**, 458.
- Lister's lenses**, 13.  
 — achromatic correction of, 63.
- Liver, diseased, 567.
- Liverworts**, 308.
- Lobb on micrasterias, 279.
- Lob-worm, 576.
- Loligo, palate of, 548.
- Lophopus crystallum**, 525.
- Loven on mollusca, 538.
- Louse, 633.
- Lubbock**, Sir J., on the eggs of insects, 605.  
 — on aquatic insects, 626.
- Lucernaridae**, 493.
- Luidia fragillissima**, 496.
- Lung, capillaries of, 690.
- Lymphatic**, vessels of, 669.
- MADREPORIDAE**, 486.
- Magnifiers, hand, 38.
- Magnifying power of single lenses**, 39.  
 — of object-glasses and eye-pieces, 57.
- Maple-aphis**, 613.
- Marchantia polymorpha**, 308.
- Mayall's**, Mr. J., semi-cylinder illuminator, 176.  
 — diaphragms, 186.
- Mechanical arrangements**, 70.
- Medusa**, 492.
- Meissner on the micropyle**, 608.
- Melicerta ringens**, 459.
- Melolantha**, eye of, 585.
- Mesoglia vermicularis**, 268.
- Micrasterias**, 280.
- Micrometers**, 63.
- Microscope**, the, 1.  
 — Abbe's binocular, 119.  
 — Baker's compound, 98.  
 — binocular dissecting, 98.  
 — student's, 96.  
 — Beck's popular, 98.  
 — ideal, 95.  
 — Brewster's diamond, 11.  
 — Browning's improved, 99.  
 — platyscopic, 39.  
 — Collins's binocular, 107.  
 — dissecting, 108.  
 — student's, 106.  
 — Crouch's, 110.  
 — Frauenh fer's lenses for, 10.  
 — G. Adams's, 10.  
 — Hooke's compound, 7.  
 — water, 5.  
 — How's student's, 112.  
 — Ladd's, 115.  
 — Lieberk hn's, 5.  
 — Murray and Heath's, 112.  
 — class, 114.  
 — Nachet's portable, 115.

- Microscope, Newton's speculum, 9.  
 — Pillischer's binocular, 104.  
 — Powell and Lealand's, 90.  
 — — arranged for test-objects, 92.  
 — Ross-Wenham, 15.  
 — Ross-Zentmayer, 87.  
 — — compound student's, 89.  
 — — student's, 90.  
 — S. Gray's globule, 4.  
 — simple, 5, 40.  
 — the stage of, 43.  
 — hot stage of, 46.  
 — Stephenson's safety stage of, 46.  
 — the mirror of, 47.  
 — the stand of, 86.  
 — management of, 162.  
 — Swift's, 109.  
 — Watson's new stand, 101.  
 — — binocular, 116.  
 — — medical or college, 103.  
 — Wollaston's, 36.  
 Microspectroscopy, 122.  
 Microtome, Swift's, 239.  
 Miller, Hugh, on fossil plants, 364.  
 Mineral kingdom, 728.  
 Mite, cheese, 637.  
 — flour, 639.  
 Molecular movements, 168.  
 — rotation, 156.  
 Mollusca, 511.  
 — injecting, 240.  
 — tongues of, 539.  
 Monads, 411.  
 Morpho Menelaus, scale of, 611.  
 Moss-agates, 399.  
 Mosses, 309.  
 Moths and butterflies, 607.  
 Motile organs in cells, 202.  
 Mottled umber moth, 606.  
 Mounting and preparing, general directions for, 211.  
 — apparatus, 210.  
 — medium, 219.  
 — spring-clip for, 211.  
 Movements of diatoms, 423.  
 Mucidines, development of, 661.  
 Mucor mucoso, 292.  
 Mucous membrane, 609.  
 Muscular fibre, 695.  
 Mushroom spawn, 343.  
 Mussel, 531.  
 Myelin, 681.  
 Myolemna, 696.  
 Mytilus, 535.  
  
 NAILS, the, 672.  
 Naviculae, 419.  
 Neckera antipyretica, 810.  
 Needles for dissecting, 202.  
 Nelson's sub-stage condenser, 171.  
 Nematodea, 563.  
 Nemertidae, 562.  
 Nerves, 699.  
 — perfection of sections, 701.  
 — stellate corpuscles, 699.  
  
 Newport on moths' tongues, 607.  
 Nicol's prism, 137.  
 Nitella, 320.  
 Nobert's ruled micrometer lines, 56.  
 Noctiluca miliaris, 409.  
 Notommata aurita, 456.  
 Nudibranchiata, 530.  
 — tongues of, 541.  
 Nummulites, 377.  
  
 OBJECT-GLASS, the, 58, 80.  
 — aperture of, 69.  
 — numerical aperture, 78.  
 — their selection, 80.  
 — the immersion, 81.  
 Object-glasses, forms of, 62.  
 — the correction of, 63.  
 Powell and Lealand's homogeneous immersion, 85.  
 — Swift's taper, 60.  
 — Wenham's binocular, 59.  
 Objectives and eye-pieces, magnifying power of, 57.  
 Objects, directions for viewing, 168.  
 Oidium, 293.  
 Onion, section of, 338.  
 Ophiocoma, 495.  
 Ophiura, 495.  
 Opuntia, 856.  
 Orchidæ, 350.  
 Organ of vision, 17.  
 Orthoptera, 626.  
 Osborne, Lord S. G., on fungi, 295.  
 — on closterium lunula, 284.  
 Oscillatoria, 266.  
 Ostracoda, 556.  
 Ova mollusca, 545.  
 Owen, Major, on foraminifera, 383.  
 — Professor, on animalcule life, 444.  
 — on microscopic investigation, 705.  
 Oxytricha, 414.  
 Oyster, 533.  
 — fry, 554.  
 — pearl, 533.  
  
 PALATES OF MOLLUSCA, 539.  
 Panax Lessonii, 329.  
 Papillæ of skin, 675.  
 Parabolic reflector, Wenham's, 173.  
 Paramecium, 409.  
 Parasites, 612.  
 — of dog, 634.  
 — of eagle, 643.  
 — eggs of, 607.  
 — of fowl, 640.  
 — of hornbill, 648.  
 — human, 633.  
 — of pheasant, 640.  
 — of pigeon, 643.  
 — of sheep, 633.  
 — of swallow, 639.  
 — of turkey, 640.  
 — of vulture, 643.  
 Parasitic fungi, 223.



- Parmelia, 805.  
 — stellata, 306.  
 Patella, tongue of, 541.  
 Pear cells, 338.  
 Pearl oyster, 533.  
 Pearls, artificial, 533.  
 Pedicellariæ of starfish, 496.  
 Pediculi, 636.  
 Penetrating power of object-glasses, 75.  
 Pentium, 283.  
 Pennatulidæ, 488.  
 — phosphorea, 488.  
 Peronosporæ, 290.  
 Peziza, 304.  
 Pholus dactylus, 531.  
 Photography applied to microscope, 157.  
 Phryganea, eggs of, 605.  
 Phryganeidæ, 601.  
 Phyllactinia, 294.  
 Pigment cells from skin, 675.  
 Pillischer's binocular microscope, 104.  
 Pinna, 530.  
 Planariæ, 562.  
 Plants and animals, 237.  
 — annular vessels, 358.  
 — cellular tissue of, 323.  
 — circulation in, 320.  
 — crystals in, 337.  
 — fossil, 362.  
 — hairs of, 324.  
 — lactiferous tissue of, 334.  
 — lice, 613.  
 — pollen and seeds from, 361.  
 — pollen grains, 361.  
 — preparation of tissues, 359.  
 — raphides in, 337.  
 — silicia in, 340.  
 — silicious cuticle of, 339.  
 — starch in, 341.  
 — starch of potato, 345.  
 — starch, wheat flour, 344.  
 — stellate tissue, 333.  
 — structure of, 323.  
 — unicellular, 260.  
 — vascular system of, 327.  
 — vascular tissue of, 324.  
 — vital characteristics, 257.  
 — woody tissue, 353.  
 Phosphorescence, marine, 408.  
 Pleurobranchus, mandible of, 542.  
 Pleurosigma, 421.  
 — as a test-object, 56.  
 Plumatella repens, 527.  
 Plumularia, 478.  
 — pinnata, 480.  
 Podura plumbia, 628.  
 — scale, as a test, 67, 610.  
 Polarisation of light, 183.  
 Polarised light, objects for, 720.  
 Polariser, 188.  
 Polyzoa, 512.  
 — mounting, 222.  
 — fresh-water, 524.  
 Polycystina, 384.  
 Polygastrica of Ehrenberg, 416.  
 Polyommatus argiolus, 610.  
 Polypifera, 462.  
 Polythalamia, 376.  
 Pontia brassica, 611.  
 Potato mould, 290.  
 — starches, 155, 343.  
 Powell and Lealand's microscope, 90.  
 Powell's immersion condenser, 180.  
 Preparation of insects, 643.  
 Preparing and mounting objects, 211.  
 — sections of hard tissues, 205.  
 — tongues of molluscs, 544.  
 — vegetable tissues, 559.  
 Prism for binocular, 118, 121.  
 — for microspectroscope, 125.  
 — polarising, method of using, 139.  
 Propita gigantea, 493.  
 Proteus, the, 373.  
 Protococcus pluvialis, 250.  
 Protozoa, 363.  
 Pteropoda, 532.  
 Puccinia, 292.  
 — buxi, 294.  
 Pumpkin fungi, 301.  
 QUEKETT on the vascular tissue of plants, 358.  
 — on fossil infusoria, 438.  
 — on polarised light, 155.  
 — on the structure of bone, 714.  
 Quinidine, test for, 152.  
 Quinine, its detection, 150.  
 RAINEY on artificial shell, 551.  
 Ralfs, Mr., on desmidiaceæ, 283.  
 — carbolic acid fluid, 220.  
 Raphides in plants, 337.  
 Re-agents, effects of, 726.  
 Redfern on separating naviculæ, 435.  
 Red seaweeds, 271.  
 Reflector, parabolic, Wenham's, 173.  
 Reznor's mechanical finger, 213.  
 Rhinoceros horn, 721.  
 Rhizopoda, 372.  
 Rhubarb cells, with raphides and starch, 388.  
 — spiral vessels, 355.  
 Ringworm, 296.  
 Roberts, Dr., on blood cell, 677.  
 Robertson, J., on pholus, 531.  
 Roes's microscopes, 87.  
 — object-glasses, 89.  
 Rotiferæ, 452.  
 Rush, stem of, 333.  
 SALTER, DR. HYDE, on muscle, 496.  
 Salts, urinary, 150.  
 Samuelson, J., on infusoria, 415.  
 Sandstone, 729.  
 Sarcina ventriculi, 295.  
 Sarcode, 656.

- Saw-fly, 616.  
 Scales of fish, 721.  
 — of lepidoptera, 609.  
 — of podura, 628.  
 Scapander, tongue of, 542.  
 Schultze, Dr., on rhizopoda, 375.  
 — on the diatom valve, 422.  
 Schwann's classification of tissues, 692.  
 Scissors, dissecting, 201.  
 Sea-cucumbers, 508.  
 — jelly fish, 491.  
 — lilies, 497, 505.  
 — slug, 529.  
 — soundings, 388.  
 — urchins, 498.  
 Section-cutting machine, 204, 239.  
 Sections, method of making, 208.  
 Sella's test-slide, 165.  
 Selenite, 142.  
 — stage, 148.  
 Sepia, palate of, 541.  
 Serpula, 575.  
 Sertulariadae, 476.  
 — pumila, 477.  
 — setacea, 477.  
 Sheep tick, 638.  
 Shell, structure of, 546.  
 — artificial formation of, 551.  
 Sheppard, J. B., on coloured monads, 418.  
 Silk, 354.  
 Silkworm moth, antenna of, 608.  
 Silkworm's breathing aperture, 586.  
 Single microscope, 4.  
 Skin, capillaries of, 675.  
 — fungoid diseases of, 296.  
 — nerves of, 676.  
 — section of, 677.  
 Slack, H. J., on a rotifer, 451.  
 Smith and Beck's microscope, 95.  
 Smith's, Prof., condenser, 186.  
 — mechanical finger, 436.  
 Snow, crystals of, 158.  
 Sollitt on diatoms as test-objects, 426.  
 — measurement of markings on diatoms, 428.  
 Sorby's standard interference spectrometer, 738.  
 — spectroscopic, 126.  
 Sori of ferns, 315.  
 Sphaeraria cirrhosa, 269.  
 Spectro-microscopy, 122.  
 Spectrum analysis, 735.  
 Spencer, Herbert, on the formation of fibre in plants, 325.  
 Sphaeriaceae, 294.  
 Sphaerosira volvox, 276.  
 Sphagnum, 309.  
 Spiders, 644.  
 — diving, 647.  
 Spiderwort, 350.  
 Sponges, 385.  
 — skeletons of, 390.  
 — spicula from, 387, 390.  
 Spongia coalita, 388.  
 Spongia geodia, 390.  
 Spongilla cinerea, 392.  
 — alba, 392.  
 — development of, 389.  
 — gemmules of, 400.  
 Spring-clip, 211.  
 Staining animal and vegetable tissues, 224.  
 — Groves on, 230.  
 — Schafer's method, 234.  
 — Stirling's method, 227.  
 Starches, 343.  
 — in plants, 342.  
 — potato, polarised, 155.  
 — tests for, 233.  
 Star-fishes, 495.  
 Staurostrum, 282.  
 Stellate tissue from a rush, 333.  
 Stenors, 450.  
 Stephanoceros, 458.  
 Stephanosphaera pluvialis, 265.  
 Stephenson's safety-stage, 46.  
 — catoptric illuminator, 185.  
 — on homogeneous immersion, 88.  
 Stichostegidae, 278.  
 Stinging-nettle hairs, 324.  
 Stokes's, Prof., absorption bands, 131.  
 Stomach, mucous membrane of, 609.  
 Structure of shell, 529.  
 Suetoria, 629.  
 Sugar insect, 638.  
 — cane, section of, 336.  
 — detection of, 156.  
 Surirella constricta, 420.  
 Swammerdam's dissection of insects, 579.  
 Swift's condenser, 181.  
 — microscope, 109.  
 — microtome or section-cutter, 239.  
 — taper object-glasses, 60.  
 Synapta chirodota, 503.  
 Synaptidae, 508.  
 — gill of, 686.  
 Tænidae, 563.  
 Tapeworms, 568.  
 Tea, adulterated, 349.  
 Teeth, preparing sections of, 206.  
 — of mollusca, how to prepare, 544.  
 — sections, mounting of, 208.  
 Terebratulina, 536.  
 Teredo, 531.  
 Test-objects, 423, 610.  
 Testacella, tongue of, 542.  
 Theory of microscopical vision, 19.  
 Thomas on crystallization, 730.  
 Thompson on mollusca tongues, 543.  
 — Prof. W., on sea-lilies, 497.  
 Thread cells, 544.  
 — in actiniae, 467.  
 — in mollusca, 544.  
 Thularoa, 478.

- Thysanura**, 627.  
**Tinea vestianella**, 611.  
**Tissue**, woody, 353.  
**Tissues**, consolidated animal, 702.  
 — elastic and non-elastic, 694.  
 — hard, 205.  
**Tomato**, diseased, 300.  
**Tomkins**, Mr. J. N., on alcyonella, 526.  
**Tomopteris onisciformis**, 576.  
**Tooth**, section of, 707.  
 — structure, 709.  
 — of eagle-ray, 712.  
 — of prestis, 711.  
**Tortula cerevisia**, 300.  
 — *diabetica*, 295.  
**Tourmaline**, 139.  
 — artificial, 144.  
**Tradescantia**, circulation in, 350.  
**Transformation**, insect, 648.  
**Transparent injections**, 251.  
**Trematoda**, 563.  
**Trembley** on hydra, 471.  
**Triceratium**, 419.  
**Trichobasis**, 294.  
**Trichocera hyemalis**, 598.  
**Trichoda**, 411.  
**Trichina spiralis**, 568.  
**Trochell**, Dr., on mollusca, 539.  
**Trough** for exhibiting circulation, 193.  
 — Beck's, 195.  
 — Botterill's live, 194.  
**Truffles**, 302.  
**Tsetse-fly** of Africa, 596.  
**Tubercularium**, 302.  
**Tubicola**, 574.  
**Tubiporidae**, 439.  
**Tubularia Dumortierii**, 497.  
**Tubularidae**, 473.  
**Tunicata**, 532.  
**Turbellaria**, 561.  
**Turbo marmoratus**, tongue of, 543.  
  
**ULVÆ**, development, 271.  
**Uredo**, 291.  
**Urinary salts**, 150.  
**Uromyces**, 291.  
**Urticating organs** in actinise, 467.  
 — in mollusca, 544.  
  
**VALLISNERIA**, 321.  
**Varley**, on chara, 815.  
**Vaucheria**, 274.  
**Vegetable structure**, 323.  
 — cell, 255.  
 — cellular tissue, 360.  
  
**Vegetable kingdom**, 255.  
 — division between animals and, 256.  
 — preparation of, 359.  
 — preparation of tissues, 359.  
 — starch, 341.  
 — tissues, method of staining, 340.  
 — vascular tissue, 324.  
**Velutina**, palate of, 540.  
**Vertebrata**, 654.  
**Vertical illuminator**, 186.  
**Vibrio spirilla**, 412.  
**Virchow** on trichina, 569.  
**Volvox globator**, 275.  
**Vorticellidae**, 445.  
  
**WALE'S Iris diaphragm**, 170.  
**Wasp**, 618.  
 — tongue of, 582.  
**Water**, microscopical examination of, 743.  
 — organic matter in, 751.  
**Water-beetle**, 625.  
**Water-microscope**, 5.  
**Water-mites**, 643.  
**Wenham's binocular object-glass**, 59.  
 — immersion illuminator, 174.  
 — binocular microscope, 121.  
 — method of using object-glasses, 66.  
 — parabolic reflector, 173.  
**West**, Tuffen, on feet of flies, 598.  
**Wheat**, portion of husk of, 340.  
 — flour, adulterations of, 344.  
**Wheik**, palate of, 537.  
**Whirligig**, 625.  
**Whitney**, W. U., on the tadpole, 653.  
**Wing-shell**, 630.  
**Wood**, cutting sections of, 204.  
**Woodward**, Mr., on polarised light, 140.  
**Wool**, 354.  
**Wright**, Dr., on alcyonida, 524.  
  
**XANTHIDLE**, 282, 441.  
  
**YEAST PLANT**, 299.  
**Yew**, section of, 356.  
  
**ZEIS'S objectives**, 80.  
**Zoophytes**, canal-bearing, 385.  
 — a fresh-water group, 463.  
 — preservation of polypidoms of, 509.  
 — skeletons of, 490.  
**Zygoceros rhombus**, 432.





