

UMASS/AMHERST



312066005809486

LIBRARY

OF THE



UNIVERSITY OF MASSACHUSETTS
LIBRARY

THE
LIBRARY
OF THE
MUSEUM OF
ART AND
ARCHAEOLOGY
OF THE
UNIVERSITY OF
CAMBRIDGE

THE AMERICAN BREEDERS MAGAZINE

A JOURNAL OF GENETICS AND EUGENICS

PUBLISHED BY THE
AMERICAN BREEDERS ASSOCIATION

INDEX TO VOL. III

WASHINGTON, D. C.
1912

UNIVERSITY
OF MICHIGAN
LIBRARY

Per
J8258

v. 3

THE WAVERLY PRESS
BALTIMORE, U. S. A.

INDEX TO VOLUME III AMERICAN BREEDERS MAGAZINE

Acclimatizing; Possibilities of, South American Birds and Mammals.....	144
A Million Years Hence.....	149
Anderson, W. S., Evolution of a Type of Horse.....	209
Animals, The Introduction of.....	140
Animal Breeding, Some Biological Principles in.....	270
Arabian Horse, A History of the, and Its Influence on Modern Breeds...	174
Association, The American Breeders, and the Practical Breeder.....	224
A Study in Eugenic Genealogy.....	241
Barleys, The Breeding of Winter.....	108
Biography, A. E. Blount.....	81
Nehemiah P. Clarke.....	161
Martin Hope Sutton.....	1
Biological Principles, Some, in Animal Breeding.....	270
Blount, A. E., Biography.....	81
Breed, The Karakul, of Sheep.....	158
Breeder, The American Breeders Association and the Practical.....	224
Breeding, Circuit.....	57
End Results in.....	137
Farm, A Fruit, in Minnesota.....	316
For Eggs, Testing System of.....	316
Genetics, Eugenics.....	308
Horses and Horse.....	282
Plant, as a Business for Farmers.....	64
Some Biological Principles in Animal.....	270
Ten Years of Corn.....	295
The Effect of Research in Genetics on the Art of.....	29, 125
Value of Seedling Characters in Plant.....	231
Breeds, A History of the Arabian Horse, and its Influence on Modern....	174
Broad-Tail Sheep, Concerning the Fat-Tail and the.....	181
Bush-Brown, H. K., Horses and Horse Breeding.....	282
Canadian Seed Growers Association, The, and Its Work.....	237
Castle, W. E., Some Biological Principles in Animal Breeding.....	270
Cattle, Korean.....	312
Relation Between Yields of Milk and Yields of Fat in Dairy.....	148
The Illawara Breed of Dairy.....	164
Census, Ethnic, in Minnesota.....	318
Characters, Value of Seedling, in Plant Breeding.....	231
Circuit Breeding.....	57
Clarke, Nehemiah P., Biography.....	161
Club, The Eugenics, at the University of Wisconsin.....	69
Clubs, Eugenics, in Educational Institutions.....	63
Committee, Report of, on Heredity of Feeble-mindedness.....	134
Conference, First Annual, of the Eugenics Field Workers.....	265
Congress, The International, of Eugenics.....	75

Corn Breeding, Methods of.....	99
Ten Years of.....	295
Cornell, The, Experiments in Breeding Timothy.....	85
Cross, Fertility of Hybrids in a Mammalian Species.....	261
Crosses, Transmission of Color and Color Markings in Hereford-Shorthorns	201
Demography, Fifteenth International Congress on Hygiene and.....	232
Derr, H. B., The Breeding of Winter Barleys.....	108
Detlefsen, John, Fertility of Hybrids.....	261
Domestication of the Fox.....	37
Ethnic Census in Minnesota.....	318
Eugenic Genealogy, A Study in.....	241
Eugenical Aspect of Venereal Disease, The.....	256
Eugenics, A Pertinent, Question.....	228
Breeding, Genetics.....	308
Club at the University of Wisconsin, The.....	69
Clubs in Educational Institutions.....	63
Congress, International.....	75
Constructive.....	5, 113
Field Workers, First Annual Conference of.....	265
Our Immigration Laws from the Viewpoint of.....	20
Record Office, An Account of the Work of the.....	119
Section, Report of the Meeting of the.....	74
The Pedagogics of.....	222
Evolution of the Standard Bred.....	45
The, of a Type of Horse.....	209
Experiments, The Cornell, in Breeding Timothy.....	85
Farmers, Plant Breeding as Business for.....	64
Fat-Tail, Concerning the, and the Broad-Tail Sheep.....	181
Feeble-mindedness, Report of Committee on Heredity of.....	134
Fertility of Hybrids in a Mammalian Species Cross.....	261
The Size of the Seed Plant and the, of the Plant Produced.....	293
Field Workers, First Annual Conference of Eugenics.....	265
Foals, Another Instance of Bay, from Chestnut Parents.....	228
Fogle, E. P., Hereford-Shorthorn Crosses.....	201
Fox, Domestication of the.....	37
Funk, Eugene, Ten Years of Corn Breeding.....	295
Gartley, A., A Study in Eugenic Genealogy.....	241
Genealogy, A Study in Eugenic.....	241
Genetics, A Field for the Scientific Philanthropist.....	303
Breeding, Eugenics.....	308
at the University of Illinois.....	310
Pedagogics of.....	302
The Effect of Research in, on the Art of Breeding.....	29, 125
Gideon, The, Memorial Tablet.....	310

Hall, Prescott F., Report of Committee on Immigration.....	249
Harris, J. Arthur, Size of Seed Planted and Fertility of Plant Produced.	293
Hayes, H. K., Methods of Corn Breeding.....	99
Hays, W. M., Constructive Eugenics.....	5, 113
Nehemiah P. Clarke. (Biography).....	161
Heredity of Feeble-mindedness, Report of Committee on.....	134
Studies in Human.....	318
History, A, of the Arabian Horse and Its Influence on Modern Breeds...	174
Horse, The Evolution of a Type of.....	209
Horses and Horse Breeding.....	282
Best Color for, in the Tropics.....	156
Human, Alternative Inheritance.....	26
Heredity, Studies in.....	318
Hybrids, The Fertility of, in a Mammalian Species Cross.....	261
Hygiene, Fifteenth International Congress on, and Demography.....	232
Illawara Breed of Dairy Cattle, The.....	164
Immigration, First Report of Committee on.....	249
Our, Laws from the Viewpoint of Eugenics.....	20
Inheritance, Alternative Human.....	26
The, of Skin Color.....	317
Insanity, The Geographical Distribution of, in Massachusetts.....	11
Instance, Another, of Bay Foals from Chestnut Parents.....	228
International, The, Eugenics Congress.....	75
Introduction, The, of Animals.....	140
Irwin, W. M., The Turkey as an Egg Producer.....	204
Jones, J. Walter, The Domestication of the Fox.....	37
Jordan, H. E., The Eugenic Aspect of Venereal Disease.....	256
Karakul Sheep, The Breed of.....	138
Knorr, F., A History of the Arabian Horse.....	174
Korean Cattle.....	312
Laughlin, H. H., Conference of Eugenics Field Workers.....	265
Eugenics Record Office.....	119
Law, An Early Work with Mendel's.....	145
Laws, Our Immigration, from the Viewpoint of Eugenics.....	20
Love, H. H., Hybrids and Selections in Oats.....	289
Malde, A. E., A Method of Recording Types.....	52
Markings, Transmission of Color and Color, in Hereford-Shorthorn Crosses.....	201
Marshall, F. R., Evolution of the Standard Breed.....	45
Massachusetts, The Geographical Distribution of Insanity in.....	11
McCaffrey, Frank, Illawara Dairy Cattle.....	164
Meeting, Report of, of Eugenics Sections.....	74
Mendelian Segregation, Illustration of.....	71
Mendel's Law, An Early Work with.....	145

Method, A, of Corn Breeding.....	99
of Recording Types and Variations by Direct Printing.....	52
Minnesota, Ethnic Census in.....	318
Nursery Stock, Pedigreed.....	156
Oats, Comparison of Yields Between Hybrids and Selections in.....	289
Olin, W. H., A. E. Blount (Biography).....	81
Organization of a Eugenics Club at Cornell University.....	229
Parents, Another Instance of Bay Foals from Chestnut.....	228
Pedagogics of Genetics.....	302
The, of Eugenics.....	222
Pedigreed Nursery Stock.....	156
Pure Lines, Selection in.....	311
Rayner, Ben I., Domestication of the Fox.....	37
Report of Committee on Heredity of Feeble-mindedness.....	134
of Meeting of the Eugenics Section.....	74
Progress, from the University of Wisconsin.....	230
Research, The Effect of, in Genetics on the Art of Breeding.....	29, 125
Results, End, in Breeding.....	137
Rogers, A. C., Heredity of Feeble-mindedness.....	134
Science, A New, and Its Findings.....	157
Seed Growers Association, The Canadian, and Its Work.....	237
The Size of the, Planted and the Fertility of the Plant Produced.....	293
Segregation, Illustration of Mendelian.....	71
Selections in Oats, Comparisons between Hybrids and.....	289
in Pure Lines.....	311
Sheep, Concerning the Fat-Tail and the Broad-Tail.....	181
The Karakul Breed of.....	158
Skin Color, The Inheritance of.....	317
Southard, E. E., Distribution of Insanity.....	11
Sutton, Martin Hope (Biography).....	3
The Size of the Seed Plant and the Fertility of the Plant Produced.....	293
Timothy, The Cornell Experiment in Breeding.....	85
Transmission of Color and Color Markings in Hereford-Shorthorn Crosses.....	201
Tropics, Best Color for Horses in the.....	156
Turkey, The, as an Egg Producer.....	204
Types, A Method of Recording, and Variations by Direct Printing.....	52
Type, The Evolution of a, of Horse.....	209
University, Organization of a Eugenics Club at Cornell.....	229
Progress Report from the Wisconsin.....	230
Variations, A Method of Recording Types and, by Direct Printing.....	52
Veneral Disease, The Eugenic Aspect of.....	256

INDEX TO VOLUME III

vii

Ward, R. DeC., Our Immigration Laws.....	20
Webber, Herbert J., Breeding Timothy.....	85
Plant Breeding as a Business for Farmers.....	64
The Effect of Research in Genetics on the Art of Breeding.....	29, 124
Wisconsin, Progress Report from the University of.....	230
The Eugenics Club at the University of.....	69
Woods, Alternative Human Inheritance.....	26
Yields, Relation Between, of Milk and Yields of Fat in Dairy Cattle....	148
Young, C. C., The Fat-Tail and the Broad-Tail Sheep.....	181

THE AMERICAN BREEDERS ASSOCIATION

An organization whose efforts are devoted to:

The study of heredity in man, animals and plants; the furthering of the art and science of practical breeding to increase the quantity and quality of the world's animal and plant resources; the breeding of farm crops and farm animals to a thorough adaptation to their respective uses in all industries dependent upon the farm for their raw materials; the promotion of eugenic knowledge and sentiment for bettering the human race.

Membership: Annual \$2.00; Life \$20.00

Institutions \$25.00

Washington, D. C.

THE AMERICAN BREEDERS MAGAZINE

Published Quarterly by the American Breeders Association

FOR THE USE OF ITS MEMBERS

PRICE OF SINGLE COPIES, 35 CENTS

Address communications to American Breeders Association, Washington, D. C.

Vol. III, No. 1

First Quarter, 1912

Whole No. 9

CONTENTS

PAGE

Martin Hope Sutton Biography (with portrait). F. W. GILES, Reading, England.....	3
Constructive Eugenics. W. M. HAYS, Washington, D. C.....	5
The Geographical Distribution of Insanity in Massachusetts. E. E. SOUTHARD, Boston, Mass.....	11
Our Immigration Laws from the Viewpoint of Eugenics. ROBERT DE C. WARD, Cambridge, Mass.....	20
Alternative Human Inheritance. F. ADAMS WOODS, Boston, Mass.....	26
The Effect of Research in Genetics on the Art of Breeding. HERBERT J. WEBBER, Ithaca, N. Y.....	29
Domestication of the Fox. BEN. I. RAYNER, J. WALTER JONES.....	37
Evolution of the Standard Bred. F. R. MARSHALL, Columbus, O.....	45
A Method of Recording Types and Variations by Direct Printing. O. G. MALDE, Madison, Wis.....	52
EDITORIALS:	
Circuit Breeding.....	57
Eugenics Clubs in Educational Institutions.....	63
Plant Breeding as a Business for Farmers.....	64
NEWS AND NOTES:	
The Eugenics Club at the University of Wisconsin. O. E. BAKER.....	69
Illustration of Mendelian Segregation. W. R. BALLARD.....	71
Report of Meeting of Eugenics Section. C. B. DAVENPORT.....	74
The International Eugenics Congress.....	75
Publications Received.....	76
ASSOCIATION MATTERS:	
Membership Fees are due.....	80
Place of the next Meeting, 1913.....	80
Worth of the Work of the American Breeders Association.....	80

(Copyright, 1912, by the American Breeders Association.)

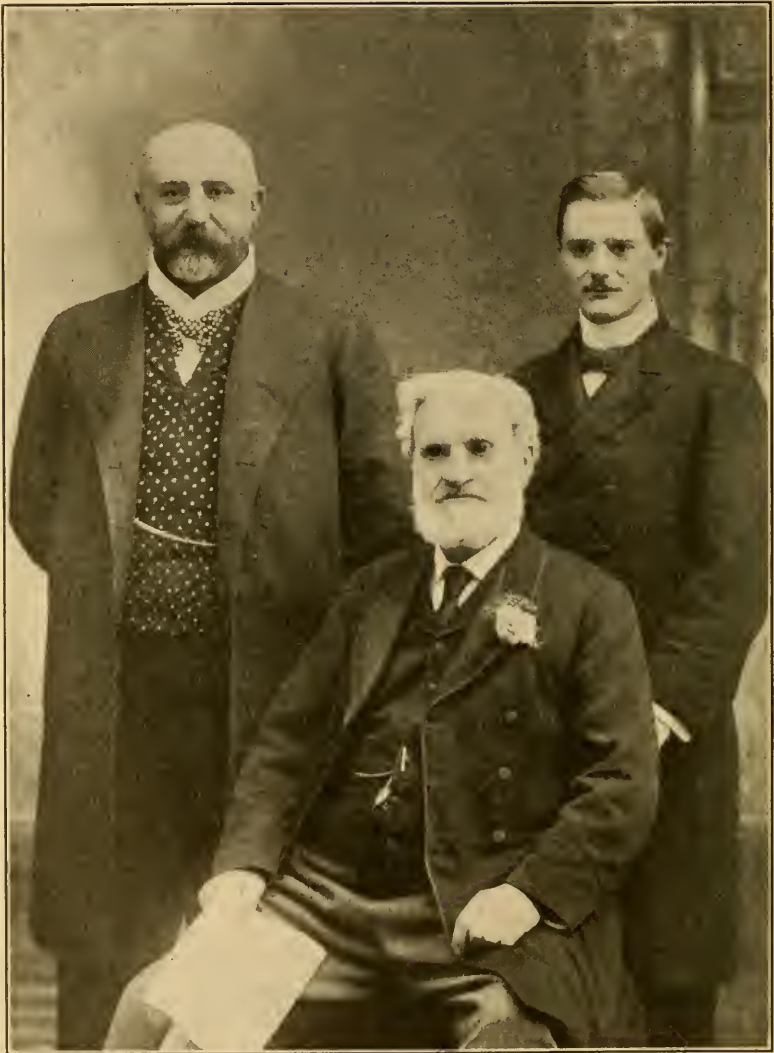

MARTIN HOPE SUTTON, HIS SON AND GRANDSON

THE AMERICAN BREEDERS MAGAZINE

"The character of a nation is determined by the character of the people living in it. The character of the people is determined by their heredity—the kind of blood that runs in their veins."

—DAVID STARR JORDAN.

Vol. III

First Quarter, 1912

No. 1

MARTIN HOPE SUTTON, 1815-1901

WALTER F. GILES

Reading, England

Martin Hope Sutton was born at Reading, England, the son of a corn factor and miller. From very early days he found his recreation in studying works on botany, and before the development of the railroads spent much of his leisure time in walking tours to visit famous gardens and nursery grounds within reach of his home. Later on he was able to extend these visits to greater distances, finally visiting some of the most interesting gardens on the continent of Europe.

His parents hoped he would adopt a profession, but his inclinations were strongly in favor of a business career, and being keenly interested in the improvement of plants, the knowledge he had gained in his travels inspired the idea of starting an experimental ground at Reading. Consequently at the age of twenty-two he commenced practical work in plant improvement, joining his father's old established business, and added to it the branch which was afterwards destined to play so important a part in the development of agriculture and horticulture.

The disastrous Irish potato famine in 1847 was one of the first means of focussing attention on the improvements which he had effected in selecting and adapting vegetables and plants for food. Public men of the day realized the value of his labors and the substitutes he suggested for the devastated potato crop, which by their quick growth would mitigate the severity of the famine, were at once accepted by the government.

The study of grasses under their natural conditions possessed a strong fascination for Mr. Sutton, and when, owing to agricultural depression, many thousands of acres were laid down to grass in England, he was able to apply his knowledge in recommending prescriptions which would be suitable for all kinds of soils. Previously

the only grass seeds generally procurable were the sweepings of hay lofts, usually consisting of worthless grasses, weeds, and the immature seeds of good varieties. In 1861 he contributed to the *Journal of the Royal Agricultural Society of England* an article on "Permanent Pastures." This was reprinted by desire, and since its enlargement by his eldest son, Mr. Martin J. Sutton, has passed through several editions, and is now one of the standard works on grasses.

Martin Hope Sutton had five sons, three of whom joined their father in his work of plant improvement. Upon the foundation already laid they were able to greatly extend the work, with the result that they have brought into commerce many new and improved types of roots, vegetables, and flowers, and their achievements are known practically throughout the world.

The Golden Tankard mangel, so highly esteemed by almost all dairy farmers, was introduced in 1872, and because of its high feeding value it was awarded a gold medal by the Highland Agricultural Society in 1873. In 1876 the Magnum Bonum potato was brought out, so well known as the pioneer of all the disease-resisting varieties of the present day. For combining the very important factor of earliness with the large podded types, the name of the Marrowfat peas stands in the front rank.

Many new types of flowers had their origin in experiments carried out by the Suttons. The pure white Gloxinia "Her Majesty" was produced by selection and reselection, the elimination of the pink shades in the type worked upon taking some fourteen or fifteen years. The "Duchess" type of Primula was a distinct break, resulting from a cross between a dark crimson flower and a blush type. It is acknowledged to be the most distinct *Primula sinensis* yet introduced, and was given an award of merit by the Royal Horticultural Society. The origin of the single tuberous rooted Begonia (Reading Beauty strain) dates from 1878. Begonia Pearcei (yellow) was crossed with Moonshine (small white). By crossing the hybrids, scarlet, coral, rose, bronze, cream, white, and many other shades of blooms have been produced; but whereas in 1880 the flowers averaged only 3 to 4 inches across, by continued selection they have been so improved as to attain to 6 or 8 inches in diameter.

Mr. Sutton's work was on many occasions recognized by the royal family. Her Majesty Queen Victoria was always very gracious to him, and at the annual shows, in which the Prince Consort was specially interested, Mr. Sutton was one of those appointed to accompany the Queen and explain the most interesting exhibits. He also had

the honor of personally receiving at Reading the late King Edward VII, when Prince of Wales, who sent kindest congratulations to him on the attainment of his eighty-second birthday.

Mr. Sutton took a great interest in religious and philanthropic work, and many societies besides those in his native town benefited by his advice and generosity.

He was in his eighty-seventh year when he died, and the work which he commenced, and which has for many years been continued by his sons, is now carried on by his sons and grandsons, each of whom specializes in a particular branch of the business.

CONSTRUCTIVE EUGENICS

WILLET M. HAYS

Washington, D. C.

Science and practical experience are rapidly evolving plans of so breeding plants and animals as to discard the undesirable and perpetuate only the desirable. Much of this work consists simply of selecting the best species nature has provided, and of selecting within these species so as to secure and perpetuate as useful varieties those types into which nature has divided the species. In many cases this means that marked economic mutations are discovered, the progeny of which are so far superior that the old stocks are entirely discarded for the new. Again, the best native and improved stocks each of which has specially desirable characters are cross-bred and from the resultant hybrids those in which occur recombinations of the highest value are secured by selective breeding and are multiplied. And again, from among those recombined stocks, mutations are sought and these are multiplied into varieties, again placing the values higher than before. Thus by these processes, step by step, controlled evolution produces types better fitted to the needs of man in the production of his food and clothing. And each year the genetic scientists and the breeders of plants and animals add new facts, clarify their philosophy, and create new bases in the forms of better foundation varieties and breeds upon which to build the next story in the achievements of breeding.

The truth is being developed that the facts and technique, the sensible philosophy and practice which all this work is bringing forward, have a relation to the heredity of man. And while the problem of the improvement of heredity in the human species seems radically

different from the problem of improving plants and animals, our plant and animal specialists call our attention to the fact that the breeders of each class of plants and of each species and even of each breed of animals have new problems to be solved. And those who are experienced in the developing of methods of improving the heredity of the numerous species of plants and of the numerous species or breeds of domestic animals, see in eugenics only another set of difficulties such as are being solved yearly by the genetic scientists and practical breeders who deal with plants and animals.

It must be admitted that the difficulties are more stupendous in the case of man, but the results are of such paramount importance that even minor improvement of the human heredity would yield high return on the cost of any sensible efforts made in that direction. That wonderful social institution, monogamy, the comparatively long life of the individual, the one child at a birth, and the relatively few children born to the parents, are all limiting factors. Those seem to be great obstacles as compared with the advantages arising in the plant kingdom from large numbers and from the brevity of the life of each generation, as in the breeding of wheat or corn. Yet there is in eugenics opportunity not only for the application of selective breeding, with fair prospects of not unduly delayed results, but also for multiplication of the progeny of human mutants and improvement by the recombination of desirable characters from separate families and separate, similar, races.

Much of the discussion of eugenics has been confined to a study of the defective classes. The eugenic problems concerning the feeble-minded, the insane, the immoral, and those non-resistant to such diseases as tuberculosis have seemed to be the problems first to be attempted. The methods of investigation devised by Darwin, Mendel, and others seem to be especially adapted to a consideration of the heredity of these classes of unfortunate people. The elimination from the human network of descent of the characteristics which produce these inefficient people is alone a problem worth many times any possible cost that can reasonably be used in the improvement of the heredity of man. The presentation of the facts concerning the heredity of human families is fast leading intelligent people past any prudishness in the scientific discussion of eugenics. And research shows that beyond and above the elimination of the least efficient of the race is the substantial improvement, through the centuries to come, of the 90 per cent who can not be classed as defective.

Speaking broadly, the eugenic problems are much the same throughout as the problems of plant breeding and animal improvement.

(1) How can we select the genetically best and by more rapidly multiplying them have the best blood eventually dominant in the whole of the race?

(2) How can we so recombine the strongest characters of families and of similar races as to secure from among large numbers of these recombined groups an opportunity to select better types?

(3) How can we select from the foundation classes and also from the recombined or hybrid classes mutations the progeny of which, when multiplied, make marked improvement over the average of the foundation stocks or of the selected cross-bred stocks?

(4) May we not hope to advance greatly the average of efficiency, to practically lop off the defective classes below, and also increase the number of the efficient at the top?

(5) While we must attend to the numerous minor matters and must continue to work out the science of the subject, shall we forget that the goal in the end is more splendid races of people, possibly averaging as high in efficiency as the very best individuals the races now possess?

Modern charity, science, and individual development—and may we not add also peace—broadly speaking, are rapidly lengthening human life from an average of approximately thirty-three years to fifty years. Fifty per cent added to the length of human life will help eventually to bring our something more than one and one-half billion of people in the world up toward three billion. It seems conservative to estimate that by the year 2000 the world will have three billion people. Shall the world remain in eugenic blindness or shall it bring to bear the clear light of fact upon the improvement of the heredity of this vast number of men? Shall the ten billion or more of human beings which the world eventually may maintain, carry its load of eugenically defective and its vocationally inefficient, as well as the present social and civic handicaps, or shall it become a race with greatly improved heredity trained as highly in the peaceful arts of production and citizenship as an improved heredity will allow?

It would seem that students of heredity have prepared the race to evolve its own efficiency, which would respond superbly to the greatly improved environment made possible by science and religion. The impulse given by scientists to cast off superstition has made possible the study of the full nature of man. The altruism which Christ awoke in humanity should have a vastly purer heredity through which to carry its blessings to all people.

Then vocational as well as general education can be offered to and taken advantage of by all youth, whatever may become their functions in society. The races will then be created more nearly equal and every man will be more nearly equal to every other man. Democratic forms of business as well as democratic forms of government will be practicable. Justice, hope, comfort, and happiness will become well-nigh universal. The improvement beyond the present may be as great as the present is beyond the dark ages.

As the complexities of society increase, as science develops, as the intricacies of industry and transportation increase, as charity becomes wider, and as social and governmental agencies become more efficient, the conditions under which men live are vastly ameliorated. Defective individuals and families which could not survive under the conditions of society in earlier periods, are now protected. Through charity, especially, do we interfere with the law of the survival of the fittest, and since society enables the inefficient to survive, society is really responsible for the reproduction of the defective classes. It would seem to be an important function of science to show that the genetic elimination of such families as are generally subject to feeble-mindedness, insanity, etc., may be quite as much of a religious duty as the giving of charity to the deficient individuals of these classes. It would seem to be a good function of our racial religion to place the duty of more abundant child bearing on the most efficient classes and the duty of less abundant child bearing on the least efficient classes; that thus, in several generations, the network of descent of the whole race may be developed so as to produce a genetically more efficient people.

There are two genetic facts of stupendous importance which need to be faced squarely, and their relation to human progress should be thought out fearlessly and clearly.

The first is the need of restraining from the function of reproduction the genetically deficient classes and families. Scientists who have studied the heredity of the feeble-minded, the insane, and several other classes of defectives have proof which abundantly warrants the affirmation that individuals who have in their heredity a large percentage of these defective characteristics have no racial right to perpetuate their kind, a large percentage of whom cannot sustain themselves and must be a burden on society. Mendel and his disciples have given a knowledge of unit characters which warrants the belief that if all persons with a transmissible defective character in their heredity were rendered unproductive, by segregation or

otherwise, nearly all of that characteristic could within a few generations be eliminated from the network of human descent.

A study of insanity and feeble-mindedness is resulting in an accumulation of facts which should lead to genetic genealogies of the defective classes and thus to facts upon which to act in the prevention of such unfit marriages as might be expected to result in the birth of feeble-minded or otherwise very defective children. It must be recognized, of course, that the great racial poisons, alcohol and venereal diseases, have stupendous effects and do doubtless contribute to these genetic frailties.

As to the means of reducing to a minimum the production of defective children, there is not room in this brief paper for discussion. Suffice it to say that even in this most difficult part of the problem progress is being made by science. The advantage to society of the elimination of the larger part of these classes which are a great public economic burden and a heart burden on their families, and which contribute greatly to crime, is so stupendous that even extraordinary means would seem justified. As a matter of fact, means devoid of either apparent cruelty or criminality are being sought for this purpose by the numerous scientists who are working along this line.

The second fact needing especial emphasis is the loss of genetic values through war. This fact has been most effectively emphasized by Dr. David Starr Jordan, chairman of the Eugenics Section of the American Breeders Association. The patriotic appeals of war are strongest to the best men. The young men of high school and collegiate age go forward to the conflict at arms with a racial impulse and unity most wonderfully admired by a world in which courage in arms has ever been worshipped. Not only the losses in battle but the diseases in camp also greatly reduce the number of men available for the production of succeeding generations of sound children. If during the last two thousand years wars had destroyed the least efficient of the race, instead of the most efficient, the world would today be far in advance of its present position. And the time has come when those families with the best blood should demand on the one hand that the world be peaceful, and on the other that the best heredity shall be safeguarded, to multiply and possess the earth.

Eugenics will show the city, state, and nation many things which should be changed in the interest of posterity. For example, no one doubts that the farm and the suburban homeroad are the best places

for children, that they may develop normally and strongly. No one disputes the fact that in these homes motherhood's condition is such that larger families are practicable. There is neither the enervation of the wealthy home nor the difficulties of the poor home. Here, then, is where the genetically best families should reside, that here the best folks may in the best manner produce the most folks.

The strongest argument for the use of vastly larger sums of public money for good roads in the country and for consolidated rural schools in which scientific farming and farm home making may be successfully taught is the eugenic argument. The country should be made attractive to the best parentage. And it is to the interest both of the city and of the nation that farming be so profitable, farm houses so excellent, and such adjuncts to these homes as roads and schools be so efficient that our best mothers will there find their largest life's work. From the standpoint of eugenics the state and nation should be the patrons of country life. Our forms of commerce having amassed and deposited too much of the nation's wealth in the centers of population, there must be devised ways of redistributing it where it will be used to the best advantage in the production of citizens. Homes should be less heavily taxed. Mothers of splendid genetic power should be endowed by non-public foundations, and even public endowments for this purpose could be justified.

If the genetically least efficient half of the people would have families only sufficient in size to maintain their own numbers and the genetically best half would increase 50 per cent in each generation of forty years, in two hundred years the best would become 88 per cent of the whole. These statements and figures illustrate the fact that the country does and doubtless will and should continue to supply fresh blood to the cities. Neither the city nor the country can afford to receive defective blood from the other; and Dr. Ward has abundantly shown the danger to our nation from the entrance of immigrants who are normal but whose heredity is defective and results in a percentage of defective children.

[CONTINUED IN NEXT NUMBER.]

NOTE ON THE GEOGRAPHICAL DISTRIBUTION OF INSANITY IN MASSACHUSETTS. 1901-1910^a

E. E. SOUTHARD, M.D.

Boston, Massachusetts

- I. ARE THERE EUGENIC AREAS IN MASSACHUSETTS?
- II. EUGENIC AND CACOGENIC AREAS DEFINED
- III. THE INCREASE OF COMMITMENTS OF THE INSANE IN MASSACHUSETTS. REVIEW OF FACTORS. (OWEN COPP'S DATA)
- IV. GEOGRAPHICAL IRREGULARITIES IN THE MORBIDITY-RATE AS REPRESENTED BY NEW (FIRST) COMMITMENTS
- V. FINDINGS
- VI. SUMMARY AND CONCLUSIONS

i. *Are there Eugenic Areas in Massachusetts?*—Are there areas in Massachusetts which can fitly be termed eugenic areas, areas maintained socially at least *in statu quo* by the forces of heredity? I raise this question; but I must confess the answer is not ready. I think I can prove (1) that areas exist which might be regarded as eugenic, (2) that conditions the reverse of eugenic (cacogenic) are suggested by certain other and quite separate areas, and (3) that a remarkable parallellism exists, if we may trust available data, in (a) the output of insanity and allied conditions, (b) the occurrence of social defectives, and (c) the incidence of general disease, in the areas considered in the present note. If we bear in mind the comparatively stable social conditions maintained in both types of area and the difficulty of explaining by any single set of environmental conditions the parallelism observed in mental, social, and physical defects, it will be found not unnatural to ascribe a certain weight to hereditary forces of varying character in the different regions.

I anticipate that some surprise will greet the statement that the Berkshire Hills and some of the islands of Massachusetts contain a group of twelve towns which have a zero rate of insanity production for the decade 1901-1910. I fancy that the facts may be questioned, that special conditions of commitment might be invoked, that the small total population might be thought to lead to exceptional conditions for the decade in question. Nor with the bare facts of commitment-rates from the different towns should I venture to draw more than the minor conclusions that commitment-rates vary greatly, from 0 to 20 in a decade per 1,000 inhabitants of a given town.

^a Read at the Eighth Annual Meeting of the American Breeders Association, Washington, D. C. December 29, 1911.

Less easy to ascribe to chance or small numbers was the observation that the towns with highest commitment-rates (far higher than those of cities, which as a fact I do not here consider) are largely grouped in the interior of the Commonwealth and are neither west of the Connecticut River in the higher hill region nor on the seacoast.

Interesting, too, was the parallelism that shortly transpired in respect to the development of conditions allied to insanity: the zero rate for insanity was maintained for feeble-mindedness, epilepsy, and inebriety in the towns we are tempted to term eugenic; whereas these allied conditions were found freely and proportionately developing in the other group.

To me the most convincing argument was afforded by the comparative findings of the census enumerators of the Massachusetts census of 1905. Not only did the enumerators find relatively fewer mental and allied cases in the homes in the "eugenic" group, but—and here the disparity was striking—relatively far more paupers and criminals in the "cacogenic" group, and, lastly, a darker background of general bodily disease in the "cacogenic" group. There was thus a sort of conspiracy among otherwise unrelated statistical facts which might discover its true arch-conspirator in the forces of heredity.

Before giving in more detail the findings so far obtained, I will, first, define more narrowly in a short section (ii) what eugenic areas, especially in Massachusetts, might be taken to mean. Secondly, in another short section (iii), I will rehearse the facts that led me to conceive that there might be significant geographical irregularities in the insanity production of Massachusetts towns.

ii. *Eugenic and Cacogenic Areas Defined.*—The eugenic area of state or country can be rightly defined both positively and negatively. An area in which the forces of heredity are operating to produce a better human stock is eugenic in a positive, incremental, evolutionary sense. If the hereditary forces are engaged merely in the prevention of deterioration within a given area, we may still usefully define such an area as eugenic, but in a negative or stationary sense. For the immediate purposes of society the more useful definition is very possibly the latter. Sufficient unto the day for practical propagandists is the more modest program which seeks to maintain at least our present social level, to hold, as it were, our human stocks at par.

Indeed, the incremental program of artificial human evolution, culminating in what might be termed the *aristogenic* program of producing more and greater great men for the world, at present hardly

escapes ridicule and certainly leaves your practical, Anglo-Saxon economist rather cold. The practical man is apt to feel, though he cannot readily prove, that the forces of deterioration are overcoming any possible forces of betterment, that the operation of hereditary forces, so far from acting in the eugenic or aristogenic direction, is slowly or rapidly pulling down the level of society. To prove this assumed levelling-down of society in a state, the ordinary citizen is likely to point to such and such places where degeneracy is rife, crime rampant, and pauperism supreme. Doubtless such areas exist and might be usefully termed *cacogenic* areas, in so far as heredity can be proved to underlie their social decline.

The data available for the present note (whose purpose is entirely one of orientation in the matter) permit remarks merely in the direction of that more modest eugenics which seeks to maintain the present social level. Moreover the materials of the note are limited in the main to certain forms of so-called degeneracy (insanity, feeble-mindedness, epilepsy, inebriety).

Massachusetts is of particular interest in this direction. Aside from the well-known spiritual pride of Bostonians, a statistical basis for the eminence of Massachusetts in certain departments has been given by Dr. F. A. Woods,^b from a study of the unprejudiced pages of *Who's Who in America*, Lippincott's *Biographical Dictionary*, and *American Men of Science*. However, we hear much at home concerning the decline of native stocks, rural degeneracy, and the increase of insanity and mental defect in the commonwealth at large. These rumors, coupled with suspicion of many immigrating stocks (to say nothing of the observation of mutual suspicions between the different immigrating races), lead many lovers of society to sorrow for Massachusetts.

Although such sorrow is born of statistics, I do not expect to allay it by more statistics. Hereditary forces have always produced in Massachusetts pessimists-in-the-bud and reformers-in-the-bloom. Mere facts of statistics hardly count against hereditary ideas. Much of our reform spirit is truly aristogenic, if not otherwise Utopian, in its aim.

iii. *The Increase of Commitments of the Insane in Massachusetts. Review of Factors.*—Regardless of eugenics, one good reason for a close investigation of the distribution of insanity in Massachusetts is the supposed increase of insanity in the institutions of the commonwealth.

^b Woods, F. A., *Historiometry as an Exact Science*. *Science*, n. s., vol. xxxiii, no. 850, pp. 562-574, April 14, 1911.

Owen Copp's work under the Board of Insanity shows conclusively enough that such major factors as (1) increase of general population, (2) declining discharge rate from the hospitals, and (3) immigration, as well as factors of smaller range like (4) the greater inclusiveness of the modern classification "insane," (5) greater longevity outside hospitals, uncovering possibly more senile demented, (6) greater longevity inside the hospitals, which bears on the lowering discharge rate, (7) more frequent commitments of dotards both by friends and by town officials, and (8) the trend to city life which is less consistent than country life with home care of the mentally defective, are factors together responsible for the increase of visible insanity. *The accumulation-rate, in brief, is not the morbidity-rate.* These conclusions of the Massachusetts Board of Insanity have been adopted and printed in summary form by the Massachusetts Commission of 1910 "To Investigate the Question of the Increase of Criminals, Mental Defectives, Epileptics, and Degenerates," which concludes in its report^c (January, 1911) that "only one-fifth of the accumulation (in hospitals) is due to increase in the ratio of admission of new cases of insanity. There is no evidence of a marked increase in the number of new cases of insanity in the community."

iv. *Geographical Irregularities in the Morbidity-rate of New Commitments of the Insane.*—Reflection upon such facts leads to the conception that there may be irregularities in the production of insanity in different communities of Massachusetts and that these irregularities may tend to balance each other. Indeed, if the conditions reported by social workers and by field workers in eugenics be at all representative, it seems irresistibly certain that cacogenic forces in one area are countervailed by eugenic forces in another, or that the up and down forces of heredity may mingle in the one and the same area.

I have made a small beginning upon this problem of the distribution of eugenic and cacogenic forces in respect to mental disease in Massachusetts by a study of data available at the office of the Board of Insanity. I make this report of progress in order to stir others to a similar study of the neglected bright side as well as the all too obvious dark side of this division of social service, and especially to a study of regions of another make-up.

^c Report of the Commission (Walter E. Fernald, Hollis M. Blackstone, Everett Flood, Benjamin F. Bridges, Ernest V. Scribner) to Investigate the Question of the Increase of Criminals, Mental Defectives, Epileptics and Degenerates, created by Chapter 59, Acts of 1910, Massachusetts, State Printers, January, 1911.

I have limited my consideration for the present to the new cases (first commitments) of insanity in Massachusetts in the decade 1901-1910. I have been especially aided by the elaborate Census of Massachusetts in 1905, both volume I (Population and Social Statistics) available in 1909^d and volume II (Occupations and Defective Conditions) available in 1910.^e The conditions found in the mid-decade state censuses may well serve as the characteristic conditions of the decade in question.

v. *Findings*.—The statistician will note (1) that the commitment rates here discussed are first- or new-commitment rates for the decade and give no picture of accumulation rates in hospitals, (2) that the available figures were based on 1910 population for the commitment-rates, on 1905 population for census-rates of defectives, and (3) that the commitments and non-institutional defectives are classified by residence and not by birthplace. The study is accordingly in the first instance environmental, and eugenic *sensu strictiori* only in so far as the persons in question are native-born. Only elaborate and year-long study could answer with exactness how far environmental, and how far hereditary, forces are responsible for the geographical irregularities here displayed. My usage of the term “eugenic” and its antonym “cacogenic” might therefore be opposed on the ground that hereditary forces have not been proved to account for the differences. But the usage is in sufficient accord with Galton’s.

I find (1) a somewhat markedly uneven distribution of insane commitments, classified by *counties of residence*. The ratios (figured on the population of 1910) vary from 4.2 per 1,000 in the island county of Dukes (Martha’s Vineyard, etc.) to 9.4 per 1,000 in the metropolitan county of Suffolk (Boston, etc.). The island county of Nantucket has a high ratio, 8.1 per 1,000, but the figures—population (1910) 2,962, first commitments 24 (1901-1910)—are perhaps exceptional. On the face of the figures, the island counties differ markedly, just as we shall find other apparently similar regions differing from one another. Other counties (besides Suffolk and Nantucket) having ratios higher than that of the State at large—7 per 1,000 (first commitments 1901-1910)—are Hampshire County in the south-Massachusetts part of the Connecticut River Valley and the midland county of Worcester, both yielding a ratio of 7.2 per 1,000. Essex, the northeastern seacoast county, approaches the general com-

^d Census of the Commonwealth of Massachusetts, 1905, vol. I, Population and Social Statistics, State Printers, 1909.

^e *Ibid.*, vol. II, Occupations and Defective Conditions, 1910.

monwealth rate, reaching 6.8 per 1,000. Rounding off the figures, we arrive for the counties at this series (calculated on population of 1910):

TABLE 1

	Per 1,000		Per 1,000
Suffolk.....	9	Middlesex.....	6
Nantucket.....	8	Plymouth.....	6
Essex.....	7	Barnstable.....	5
Hampshire.....	7	Berkshire.....	5
Worcester.....	7	Hampden.....	5
Bristol.....	6	Norfolk.....	5
Franklin.....	6	Dukes.....	4
The Commonwealth.....		7	

Having thus established the general likelihood of geographical variations in insane-commitment rates of a significance involving (but possibly deeper than) the urban vs. rural variation, I directed attention to the towns and found that (2) classification by residence in towns, just as by residence in counties, revealed surprisingly uneven distribution of first commitments. Though the towns as a whole show a markedly lower ratio (5.7 per 1,000) than the cities as a whole (7.6 per 1,000), yet individual towns to the number of twenty equalled or excelled the highest city ratio, viz. 10.1 per 1,000. Indeed, ten of these twenty towns yielded far higher ratios than that of the city in question, viz., ratios from 12.5 to 20.8 per 1,000. The highest ratio (20.8 per 1,000) is in one respect artificial and it would be fairer to state the highest ratio as about 18.8 per 1,000.

So much in support of rural degeneracy! But I found that (3) there are twelve Massachusetts *towns from which no insane have been committed* in the decade 1901-1910. This possibly eugenic role with respect to insanity is assumed by—

Alford	Gosnold	Monroe	Peru
Chilmark	Hancock	Mt. Washington	Washington
Gay Head	Holland	New Ashford	Wendell

Of these, three (Chilmark, Gay Head, and Gosnold) are in the island county of Dukes, and furnish in part the explanation of the low general percentage of Dukes County (4 per 1,000) which was so surprising in contrast with the 8 per 1,000 of Nantucket.

Of the others, all but two are west of the Connecticut River and might be classed as Berkshire Hill towns (Monroe on the Vermont line is the northwesternmost town of Franklin County). Wendell is in Franklin County, and Holland is in Hampden County on the

Connecticut line. The region, then, of seven of the towns which have produced no first commitments in 1901-1910 is the Berkshire Hill region, characterized by a general level of 1800 feet above the sea, narrow but fertile valleys, dairying opportunities, and the New York summer colony.

No Berkshire town yields percentages approaching those of the maximal town percentages, and I find that (4) the *regional occurrence*, studied comparatively in these two groups of zero and maximal commitment-rate, is roughly *suggestive*: Some island towns and several hill towns have contributed little or no insane in the period of study, whereas five Worcester County towns, two towns on the eastern line of Worcester County, and five other towns (none west of the Connecticut River and none on the seacoast) have supplied maximal ratios of first commitments (13 to 19 per 1,000). To unravel the reasons for these conditions in particular towns would be a very worthy object of a sociological survey on broad lines.¹ This we hope to compass some day. Meantime there are available some data of value.

(5) The question might naturally be raised: If twelve towns are producing no committed insane, may they not be producing other so-called forms of degeneracy? Search of the records has shown, however, that in 1901-1910 none of these towns has produced any committed cases of (a) insanity, (b) feeble-mindedness, (c) epilepsy, (d) inebriety. The towns with maximal insanity-percentages have produced other so-called forms of degeneracy in all cases but two. In more detail, the twelve possibly cacogenic towns chosen to compare with the twelve possibly eugenic towns have produced

189 new cases of insanity in 1901-1910.

29 new cases of feeble-mindedness in 1901-1910.

10 new cases of epilepsy in 1901-1910.

8 new cases of inebriety in 1901-1910.

being in all 15.3 per 1,000 of the population in 1910.

(6) The ratio of degenerates discovered by census in these towns hardly alters the above conclusions. In the absence of an intensive sociological survey, we can test the value of certain data of the Massachusetts Census of 1905. The findings of the census enumerators should be equally reliable (or unreliable) for the two groups. They found in the homes as of May 1, 1905, representatives of our four classes:

¹ Davenport, C. B., *Heredity in Relation to Eugenics*. New York, 1911, pp. 267-269.

In twelve eugenic(?) towns.....	8 (26 per 1,000)
In twelve cacogenic (?) towns.....	47 (30 per 1,000)

We should perhaps expect a greater difference than we find in the two groups. Such as it is the difference is in favor of the relatively non-degenerate towns. The findings may possibly be consistent with factor 8 discussed in our review of Copp's work on the supposed increase of the insane, viz, the greater likelihood of commitment of cases from larger than from smaller towns.

(7) The background of social defectives as a whole is a blacker background for the twelve towns with high insanity-rates. As social defectives, following the Massachusetts Census of 1905, we may classify prisoners, juvenile offenders, paupers, and neglected children. The census enumerators found social defectives as follows:

In twelve eugenic (?) towns.....	24 (8 per 1,000)
In twelve cacogenic (?) towns.....	310 (20 per 1,000)

(The difference is still sharper when we consider that 12 of the 24 social defectives in the eugenic (?) towns were from a single town (Washington) and may have represented unusual conditions, actual or incidental in enumeration.)^g

(8) The general medical and social status (established by extracting ratios for the totals of physical and social defectives) of the possibly cacogenic towns is somewhat worse than the general medical and social status of the possibly eugenic towns (53 per 1,000 against 44 per 1,000).

(9) The total population of the twelve eugenic (?) towns is far smaller than that of the twelve cacogenic (?) towns. The population of the eugenic (?) group is slightly decreasing, 3209 (1900) to 2945 (1910); that of the cacogenic (?) groups is slightly increasing 15,385 (1900) to 15,415 (1910).

(10) The nativity of the general population of these groups (1905) was as follows:

	Eugenic (?) group.	Cacogenic (?) group.
Native born.....	83	84
Parents native-born.....	73	67
Grandparents native-born.....	67	60

This ratio suggests a greater instability (in respect to the conditions here studied) in the more mobile population.

^g Eleven neglected male children and one pauper.

vi. *Summary and conclusions.*—The eugenic area or areas of a region are characterized by the operation of hereditary factors in either (a) the improvement of the contained human stocks or (b) the maintenance of these stocks *in statu quo*.

The aristogenic program is that extreme eugenic program which seeks to produce more and greater great men for the world by more effective mating.

Against an ideal aristogenic program are operating certain deteriorating factors of hereditary nature (cacogenic factors).

The data immediately available in Massachusetts may be used in the study of eugenic areas in the second or negative sense (see b above), with respect to insanity.

The morbidity-rate of the Massachusetts insane commitments is not the same as the accumulation-rate, as an effect of many combined causes (Owen Copp's data).

One possibly eugenic area exists in Massachusetts in three island townships; another, in nine more scattered western townships (seven in the Berkshire Hill region).

The twelve possibly cacogenic towns have produced, in 1901-1910, 236 new cases of insanity and allied conditions, being 15 per 1,000 of the population of these towns in 1910 (total Massachusetts rate 7 per 1,000) highest single town rate considered 19 per 1,000; Suffolk County (Boston, etc.) rate (9 per 1,000); highest single city rate 10 per 1,000.

These possibly cacogenic townships lie chiefly in the midland county of Worcester and in no case west of the Connecticut River or on the seacoast.

The possibly eugenic and possibly cacogenic towns as considered from the commitment standpoint remain so to a degree when considered from the standpoint of the census of the same four classes enumerated in the townships May 1, 1905, viz, 2.6 per 1,000 in the former to 3 per 1,000 in the latter group.

A more striking numerical disparity was shown by the census of social defectives (prisoners, juvenile offenders, paupers, and neglected children) May 1, 1905, viz, 8 per 1,000 in the eugenic group to 20 per 1,000 in the cacogenic group.

The population of the eugenic group is small (2945, in 1910) as compared with that of the cacogenic group (15,415 in 1910); the eugenic group is falling somewhat, the cacogenic group rising somewhat in general population.

The nativity of the general population in the two groups differs

little, 830 per 1,000: 840 per 1,000; but the eugenic group has a somewhat higher percentage of native-born parents and a still higher percentage of native-born grandparents, and may therefore represent somewhat stabler stocks, than the cacogenic group.

The general medical and social picture presented by the census of 1905 is distinctly worse for the cacogenic group than for the eugenic group, suggesting that the insanities and allied conditions are apt to occur in a background of more general diseases.

If we assume that active eugenic measures are the duty of society on the principles of self-preservation or of self-improvement, then such measures must begin somewhere. The present note has no measures to propose, but merely displays certain concrete social differences in different regions of Massachusetts. The prevailing *laissez-faire* policy cannot safely fall back on the idea that all the stocks are "just generally degenerating" and that we "should not know where to begin." I should therefore advocate more intensive locality-studies in Massachusetts, as well as elsewhere, and the collection of social statistics through every public and private channel in preparation for that active eugenic program which the concrete data will be sure to indicate.

If there be a *statistical* correlation between insanity, crime, pauperism, and disease, there may be a deeper *causal* relation between some of these factors.

OUR IMMIGRATION LAWS FROM THE VIEW POINT OF EUGENICS^a

ROBERT DEC. WARD

Harvard University, Cambridge, Mass.

How far do our present immigration laws enable us to exclude those aliens who are physically, mentally, and morally undesirable for parenthood; those whose coming here will tend to produce an inferior rather than a superior American race; those who, in other words, are eugenically unfit for race culture? We, in the United States, have an opportunity which is unique in history for the practice of eugenic principles. Our country was founded and developed by picked men and picked women. And today, by selecting our immigrants through proper legislation, we have the power to pick

^a Read before the Eugenics Section of the American Breeders Association, Washington, D. C., December 29, 1911.

out the best specimens of each race to be the parents of our future citizens.

The responsibility which rests upon this country in this matter is overwhelming. We may decide upon what merits, physical, intellectual, or moral, the fathers and mothers of American children shall be selected. But we have left the choice almost altogether to the selfish interests which do not care whether we want the kind of immigrants they bring or whether the immigrants will be the better for coming. Steamship agents and brokers all over Europe and western Asia are today deciding for us the character of the American race of the future.

It is no argument against practising eugenic ideas in the selection of our alien immigrants to say that the New England country towns are full of hopelessly degenerate native Americans, who are inferior, mentally, morally, physically, to the "sturdy peasants of Europe." The degeneracy of our country native stock is probably chiefly due to the drawing-off of the stronger and more capable men and women to the cities; to prolonged inbreeding, and to the continued reproduction of feeble-mindedness, which is rife in many of our country districts. It will not help to reduce the number of our native degenerates if we admit alien degenerates. National eugenics for us means the prevention of the breeding of the unfit native, as well as the prevention of the immigration, and of the breeding after admission, of the unfit alien.

Should we not exercise at least the same care in admitting human beings that we are now exercising in relation to animals, to insect pests, or to disease germs? Yet it is actually true that we are today taking more pains to see that a Hereford bull, or a Southdown ewe, imported for the improvement of our cattle, is sound and free from disease than we take in the admission of an alien man or woman who will be a parent of American children. We do not hesitate to prohibit the importation of cattle from a foreign country where a serious cattle disease is prevalent. It is only in very extreme cases indeed that we have ever taken such a step in connection with the importation of aliens. Yet there are thousands of aliens every year who should not be allowed to enter this country for reasons which are eugenically of the first importance.

Our present laws aim to exclude some twenty-one classes of mentally, physically, morally, and economically undesirable aliens. On paper the list of the excluded classes is long and formidable, and seems more than sufficient to accomplish our eugenic purposes. But

the fact is that careful and unprejudiced students of immigration agree that these laws do not keep out the unfit so as to preserve the *status quo*, to say nothing of promoting eugenic improvement. We already have an army of probably not less than 150,000 feeble-minded in the United States, of whom only about 10 per cent are in institutions, the rest being free to propagate their kind. And of those in institutions the large proportion are kept there only temporarily, being at liberty for much of the time during their reproductive period. The same is true of thousands of criminals, whom we shut up for varying periods of time, but allow, in the intervals when they are out of prison, to populate the world with children much of whose inheritance is criminal. We are today legalizing the begetting of criminal children by failing to give permanent custodial care to habitual criminals.

Further, there are more than 150,000 insane in the institutions of the United States alone, and of these many have already left offspring to perpetuate their insanity. In spite of this appalling situation—appalling from the standpoint of mere sentiment and of mere philanthropy—doubly appalling from the standpoint of eugenics, we have been admitting alien insane, and alien imbeciles, and alien epileptics and alien criminals, partly because of a lax enforcement of the law under former administrations; partly because the law is incapable, under existing conditions, of effective enforcement. The disproportionate increase of alien insane, of alien imbeciles, of alien criminals, and many other facts which may be ascertained by any person who is interested in this question, show that, as just stated, our immigration laws do not now enable us to preserve the *status quo*. Sir Francis Galton has clearly shown that “each married degenerate produces on the average one child who is as degenerate as himself or herself, and others in whom the taint is latent but liable to appear in a succeeding generation.” Further, it is well known that imbeciles have larger families than normal persons, and that they also have a large number of illegitimate children. Parenthood on the part of all these classes of persons, native or alien, is a crime against the future. To admit to this country the feeble-minded, the insane, the epileptic, the habitual criminal, is no less a crime against the future.

The ideal eugenic selection of our immigrants would be possible only if we could have a fairly complete history, running back a few generations, showing the hereditary tendencies of each alien. This is certainly in the immediate future impracticable, but there are some things we *can* do. We can insist that each alien, on land-

ing here, should undergo a very thorough mental and physical examination at the hands of our Public Health and Marine Hospital Service surgeons. These examinations would involve the stripping to the skin of each alien, the usual physical examination for physical defects, mental tests, tests for syphilis, and similar precautions. Is this too much to demand when the welfare of the future American race is at stake? I have myself seen thousands of aliens landed, and I have marvelled at the skill with which our surgeons are now able, by the most superficial examination as the aliens file by, at the rate of several a minute, to detect some of the physical and even some of the mental defects which put these aliens into one or another of the classes which may be excluded. But such a superficial examination is all wrong. It is nothing short of a crime to admit people, as often happens in a rush season, at the rate of 3,000, 4,000, or 5,000 in one day at Ellis Island. On April 11, 1910, 7,931 immigrants were inspected by the medical officers. Think of that! And these medical officers were supposed to detect any mental and physical defect which might exclude! I believe that we ought to limit the number of aliens who shall be landed in one day to a certain number which could reasonably well be carefully inspected. We ought largely to increase the number of the surgeons detailed for that most important work of inspecting arriving aliens. We ought to enlarge the accommodations at some of our immigrant stations, in order that this work might be properly carried out.

Again, we can go a long way towards the accomplishment of our object by increasing the fines which the steamship companies now pay when they bring over an alien who is found, on our own examination here, to be an idiot, imbecile, epileptic, or suffering from a loathsome or dangerous contagious disease which could have been detected at the port of departure. The fine is now only \$100. The steamship companies pay little attention to the provision. They run their chances of having such aliens detected on landing, and in some cases they insure themselves against possible loss by obliging the alien to deposit \$100 when he buys his ticket. Now, if we increase this fine to \$500, and that is none too large, the steamship companies would themselves, without expense to us, make a much more thorough examination abroad, before sailing. Further, for the more effective detection of aliens who are physically, mentally, and morally undesirable, and who are already enumerated in our list of classes excluded by existing law, we should put immigrant inspectors and our own surgeons on board of all immigrant-carrying vessels. These officials,

mingling with the immigrants on the voyage over, should see that they are properly treated and cared for; that they are not overcrowded; and that they receive adequate medical attention. But, of far greater importance than that, these officials would be able to detect a great many cases of physical and of mental defect which we can not possibly detect in our necessarily hurried examination when these people land. And in this way we should be able to exclude and to send back far larger numbers of eugenically undesirable aliens than is at present possible, however strictly we may try to enforce the law. An immigration bill introduced into the Senate in August last by Senator Dillingham of Vermont, numbered S. 3175, contains an excellent clause which provides for just such inspection on the voyage over as I have here advocated. We ought all to do what we can to have that bill enacted into law.

In addition to these steps which we should take, and take instantly, to accomplish the more effective exclusion of the insane, the imbecile, the idiot, the tuberculous, and those afflicted with loathsome or dangerous contagious diseases, we ought to amend our laws so that it will be possible to exclude more aliens of such low vitality and poor physique that they are eugenically undesirable for parenthood. The law of 1907 excludes persons "who are found to be and are certified by the examining surgeon as being mentally or physically defective, such mental or physical defect being of a nature which may affect the ability of such alien to earn a living." This clause has been found to be rather ineffective, partly because it has been taken to be an economic test and not a physical one; partly because of other provisions in the same act which largely nullify this section by making it possible to admit on bonds aliens who fall into the group here named. Now aliens of such low vitality, poor physique, or suffering from such mental or physical defect that their ability to earn a living is thereby interfered with are highly undesirable persons, economically as well as eugenically, in the large majority of cases. They are not only themselves weaklings and unlikely to resist disease, but they are likely to have defective and degenerate children. Bonds will not prevent them from breeding. We constantly speak of the need of more "hands" to do our labor. We forget that that we are importing, not "hands" alone, but bodies also. The vast majority of incoming alien immigrants are potential fathers and mothers. And the character of the race that is here to be born depends upon the kind of alien bodies which we as voters, and therefore as having some control over our legislation, are allowing to have landed on our

shores day by day. We ought to take this seriously to heart. It is a tremendous responsibility which rests upon us.

Conservation of our natural resources: How much we hear about that! Conservation of American forests is important. So is conservation of American coal, and oil, and natural gas, and water supply, and fisheries. But the conservation and improvement of the American race is vastly more important than all other conservation. The real wealth of a nation is the quality of its people. Of what value are endless acres of forests, millions of tons of coal, and billions of gallons of water, if the race is not virile, and sane, and sound?

Fearfully misguided has been most of our so-called philanthropy. We have housed and clothed and fed the defective, the degenerate, the delinquent, to such an extent that we have encouraged them to reproduce their kind in ever-growing numbers. We have spent increasing sums for asylums, almshouses, prisons, and hospitals, in which we have *temporarily* confined the insane, the pauper, the criminal, the imbecile, leaving them free, during most of their lives, to propagate their kind. It is a fact, disguise it as we will, that we have taxed ourselves to support institutions which have resulted in increasing and not decreasing the number of the unfit. We have before us an immediate duty, of tremendous importance, in caring for our own unfit; in seeing to it, by adequate legislation, that the insane, the criminal, the feeble-minded, and similar classes are *permanently* segregated, so that they cannot reproduce their kind to be a further burden upon the nation, and in enacting laws which shall prevent the marriage of those whose offspring will be unfit.

But, in addition to our own very heavy burden of those who are defective or degenerate, we are adding every year, by immigration, many hundreds if not thousands of aliens whose presence here will inevitably result, because of their own defects, or those of their offspring, in lowering the physical and mental and moral standards of the American race.

We readily admit that we have much to learn about heredity. But of some things we are already sure. Enough is known to make it absolutely essential, if the quality of the American race is to be preserved, that there should be a far more careful selection of our incoming alien immigrants, on eugenic grounds, than we have ever attempted.

The need is imperative for applying eugenic principles in much of our legislation. But the greatest, the most logical, the most

effective step that we can take is to begin with a proper eugenic selection of the incoming alien millions. If we, in our generation, take these steps, we shall earn the gratitude of millions of those who will come after us, for we shall have begun the real conservation of the American race.

Let us see to it that we are protected, not merely from the burden of supporting alien defectives, delinquents, and dependents, but from what George William Curtis so well called that "watering of the nation's life-blood" which is the result of their breeding after admission.

ALTERNATIVE HUMAN INHERITANCE AND EUGENICS^a

F. ADAMS WOODS, M.D.

Massachusetts Institute of Technology.

The sharp contrasts in traits of character between children born of the same parents and educated under the same surroundings is often a matter of wonderment, and such variations in the human strip, reckless as they at first sight seem in their individualistic expressions, have often deterred belief in the value of heredity. The real lesson is quite the reverse and these same contrasts when rightly understood form perhaps the strongest argument in favor of mental inheritance. They support the belief in the essentially predetermined nature of such differences as commonly exist between man and man, and bring the whole question of family and individual vicissitudes within the scope and understanding of the germ-cell theory.

The phrase "alternative heredity" was in use before the rediscovery of Mendel's law in 1900. It is a broader, looser term than strict Mendelian heredity, and does not raise the question of dominance and recession. It does, however, involve the idea of segregation of the germ-plasm and is a convenient term to employ when "factors" and "units," "dominance" and "recession" have not yet been unravelled.

There have been a number of researches published lately on human inheritance. They all, as far as I know, show alternative inheritance or an approach to the pure Mendelian segregation, and confirm a belief which I had forced upon me some dozen years ago, that human

^a Read before meeting of Eugenics Section of the American Breeders Association at Washington, D. C., December 30, 1911.

traits would be found in the main to be non-blending,—not an absolute election or exclusion of a large or important trait, but what is better expressed as a rough alternative inheritance. Anyone tracing out family histories can scarcely fail to notice this principle if he is careful to include in the records *all* the members of a group of close relatives—all the sons and daughters, all the uncles and aunts, and all of the ancestors for two or three generations. The reason why this mode of human descent has not been generally noticed I attributed to the fact that complete family records are difficult to obtain, especially as regards mental and moral differences.

Workers on the question of human heredity who had used scientific methods at all had confined themselves largely to questions of averages, of coefficients, and of correlation without making critical studies of small groups. Furthermore, private family records are often vitiated by purposely suppressed information. Unless the greatest care be taken to unearth the truth, the bad traits which stand out in alternative contrast to the good traits may not be obtained.

Now that records are being collected and constructed in a thorough way and the detailed pedigrees published, the facts of alternative inheritance are obvious. As a result of studies in royalty I found such traits as the following to be in a general sense alternative in descent—high intellectual qualities, which might be called genius, alternating with lesser mentality or mediocrity, or perhaps with mental deficiencies of a marked nature, distinct moral elevation alternating in the same way with ordinary or average types, or very often with notorious moral deficiencies. Marked types of brutality and debauchery show little tendency to lose themselves by blending, as they are passed on through the generations. It is very easy to see that such traits as licentiousness, treacherousness, cruelty, chastity, benevolence, and honesty, if not absolute unit characters, nevertheless hold themselves together more or less as a unit; and the facts of distribution on the pedigree charts are only to be explained if we suppose considerable germ-plasm segregation to take place. There is also a tendency for many of the features of the face to be inherited as units, such as the form of the nose, the slope of the forehead, the shape of the lips and chin.

Within the last two years some very complete pedigrees have been compiled by the Francis Galton Laboratory for National Eugenics in *The Treasury of Human Inheritance*. These have been published with the idea of merely bringing forward the facts and have

not yet been subjected to analysis or theoretical interpretation. They show alternative inheritance for diabetes insipidus, split-foot, polydactylism, brachydactylism, pulmonary tuberculosis, deaf-mutism, marked ability, chronic trophœdema, angio-neurotic œdema, hermaphroditism, hemophilia, insanity and allied characters, and probably for commercial ability and liberal thought. In none of the pedigrees within the *Treasury* is blending apparent.

But it does not appear that we can, with the exception of hemophilia and brachydactylism, make any of these traits either a dominant or a recessive. Brachydactylism appears to be a dominant, and the descendants of unaffected parents do not transmit the defect. Polydactylism, however, shows 24 cases in which the anomaly reappeared when both parents were unaffected. Therefore polydactylism is not clearly a distinct dominant like brachydactylism. That polydactylism is not a recessive is made probable by its frequent transmission by direct descent. It is improbable that the normal mates of these transmitters should all come from affected stocks, since polydactylism is such a rare anomaly. For chronic trophœdema there are 7, for angio-neurotic œdema 22, and for diabetes insipidus 24 cases, comparable to these 24 cases of polydactylism. For all the other traits here described, cases arise which prevent one from classifying them as dominant or recessive.

Even if factors and units can not at present be worked out, for many human characteristics, the appreciation of the general principle of alternative heredity has this double value. It shows that processes are at work during the maturation of the human gametes which lead towards segregation and gametic purity, and consequently one is stimulated to further research, to analysis of the complex into its elements, and to the hope of finding simpler factors or units.

The other lesson is this: The more these contrasts are found to exist and to breed true, to be equally characteristic of psychical and of physical traits, the more credit must be given to forces predetermined in the germ. Chromosomes and gametes, from every point of view, are in the light of our present knowledge now expected to give rise to alternative heredity. Environment (or more technically modification) on the other hand should tend to eliminate the contrasts. The fact that these differences are not obliterated even among those living in the same homes and the same social atmosphere is a strong argument in favor of germ-plasm causation and a support to the advocates of eugenics.

THE EFFECT OF RESEARCH IN GENETICS ON THE ART OF BREEDING^a

HERBERT J. WEBBER

Cornell University, Ithaca, N. Y.

The knowledge of breeding has advanced so rapidly in recent years that few of us realize the great change that has taken place in our understanding of the fundamental principles, and the effect which this change has had on the methods of practical breeding that we advocate. I had the good fortune to begin my studies and experiments in breeding in 1890, ten years before the rediscovery of Mendel's now famous principles of heredity, or the publication of De Vries' mutation theory. I have thus had the opportunity to follow this change through all its ramifications. From a condition of ignorance and largely of chaos, where all advance was taken as a lucky chance, we have developed to a position where practically each step may be taken intelligently. True, we touch the limits of knowledge on every hand and many of the most fundamental problems still remain unsolved, yet our understanding today, which enables us to analyze a plant into its component parts or characters and then in turn, by synthesis, to build up a new structure by the combination of different characters into a new race or variety, is to our former understanding as light to darkness. The knowledge of breeding has developed into the science of genetics, and is fast assuming, through the orderly presentation and classification of facts, the form of an exact science. Yet, with all this advance in our understanding, the methods of breeding which can be recommended for the use of practical breeders have changed but little in the last twenty years, the greatest change being primarily in the greater surety with which we now make recommendations. It is my purpose in this address to emphasize certain salient features of the advance that has been achieved, and point out what I conceive to be some of the most important problems awaiting solution.

Twenty years ago our understanding of the principles of breeding was derived largely from Knight's physiological papers, and Darwin's *Origin of Species* and *Plants and Animals under Domestication*. Verlot's admirable pamphlet *On the Production and Fixation of Varieties of Ornamental Plants* gave a general outline of the best methods then followed, and we derived our knowledge of the use of hybrids

^aPaper No. 27, Department of Plant Breeding, Cornell University, Ithaca, New York. Annual address of retiring chairman of the Plant Section, American Breeders Association, delivered December 30, 1911.

largely from Focke's excellent text, *Die Pflanzenmischlinge*, published in 1880, and the work of the French experimenter Naudin.

At that time breeders clearly understood the fact that hybrids segregated in the second generation and gave new combinations of characters, and the suggestion was even then present in the minds of scientific breeders that this segregation of characters took place during the reduction division. At that time breeders, just as definitely as now, planned experiments in hybridizing different varieties or species to secure certain recombinations of desired characters in the hybrids. The experiments in citrus hybridization conducted by Mr. W. T. Swingle and myself were planned in 1893 entirely on this basis, yet the principle was in no sense of the word original with us, but was at that time well understood by all practical breeders. This understanding, I believe, was largely derived from the investigations of Naudin, though various investigators contributed to it.

With a full understanding of the knowledge and practices of the breeders of two decades ago, it must be admitted that the conception of unit characters and Mendelian segregation was necessary to clarify this knowledge and bring out the latent possibilities of the material presented by nature for the use of the breeder, and it is doubtful whether we even yet adequately comprehend the almost infinite possibilities open to us.

To understand breeding today we must clearly understand the conception of unit characters. We no longer conceive the species, race or variety, as a fixed ensemble of characters. Following De Vries, we now commonly conceive the species or variety to be made up of a certain number of unit characters, that are in large measure associated together by the accident of evolution or breeding and which are separable entities in inheritance. We may liken these unit characters to bricks used in the construction of a building, each separate and yet dependent on the others for the maintenance of the structure; as each unit character is dependent on the other unit characters for the maintenance of the plant body. We may think of these unit characters as organic elements similar to chemical elements, that by their recombination through hybridization form new compounds—new plants—of distinctly different appearance, but which in turn do not effect the unit characters, which may again be separated and led to form other compounds, again resulting in distinct organisms. Related species may possess many distinct unit characters, but ordinarily would be expected to possess many similar unit characters. Cultivated races or varieties ordinarily

would differ only in a few unit characters, and difference in a single unit character would be sufficient to give a distinct and recognizable race or variety. Indeed, the difference between two varieties in a single unit character might mean that one variety would be exceedingly valuable and the other practically worthless. De Vries asserts that unit characters are discontinuous in inheritance and do not exhibit transitional forms. A plant cannot be hairy and at the same time smooth, or a fruit yellow and at the same time red. While there is yet much difference of opinion on these questions the preponderance of evidence certainly favors the unit character conception.

If, then, we recognize that species are made up of unit characters and that different species differ in the possession of different unit characters, the great problem in the evolution of species becomes the question of how the new unit character is acquired. Have all unit characters existed from the beginning, or are new unit characters being continuously acquired? A few years ago we supposed that new characters if acquired in any form must be seized upon, as it were, by natural selection and preserved, or otherwise that they would be swamped by intercrossing and lost. We now know from Mendelian analysis that the unit character may be apparently lost in crossing owing to the prevailing presence of its dominant allelomorph, but that in reality it is not lost or apparently changed and will reappear again when it happens that two gametes both bearing the character meet in fecundation. It may remain hidden for many years, but as we are now inclined to view the matter, the character or the determiner of the character would not be permanently lost to the species unless all individuals possessing it were killed before they produced seed. This unit character idea would lead us to the conception of the species as made up of all the unit characters that it has acquired by any means in its development and which still exist. The acquirement of any new unit character would add one more character to the species and double the number of possible varieties or races of the species.

In evolutionary studies we have long recognized that variation was the foundation of evolution and that no evolution was possible without variation, but we have assigned to selection an all important part as guiding and even stimulating the variation in a certain direction. Darwin and particularly some of his more radical followers have assigned to selection a creative force, in that it has been assumed that when nature by a slight variation gave the hint of a possible change in a certain direction, natural or artificial selection,

by choosing this variant and selecting from among its progeny the most markedly similar variants, could force the advance of the variation in the direction indicated. Since Darwin's time this cumulative action of selection has been emphasized so forcibly that we had come to recognize selection as an active force in creation rather than simply as a selective agency. Before selection can be accepted as a vital principle of evolution, the selectionist must show that a new character can be created by selection, otherwise selection becomes a secondary principle.

When viewed from the standpoint of the production of a new and definitely heritable unit which mendelizes, the task of selection becomes more doubtful. Darwin's idea that changes in species required many years and probably many centuries for accomplishment took the subject largely out of the field of experimentation and in a measure developed a speculative science. One of the greatest contributions to science made by De Vries was to establish the study of evolution on an experimental basis. With the demonstration that evolution could be studied experimentally, the question of the effectiveness of selection was taken up, and we are now doubtless on the road to a solution of the problem. It is only possible for us here to call attention to a few of the researches in this direction.

The classical researches of De Vries, now familiar to us all, challenged the correctness of the selection theory and sought to show that species originated by sudden jumps or mutations. We may admit that De Vries proved that species or new characters were formed suddenly as mutations, but this would not prove that they might not also be formed or actually induced to mutate by a continuous process of selection. Indeed, in his experiments on the production of a double-flowered variety of *Chrysanthemum segetum* (*Mutations-theorie*, vol. i, p. 523), a few generations of selection led to markedly increasing the number of ray-florets before the ligulate corollas appeared among the disk-florets, the change which he interpreted as the mutation that gave him the double variety.

Johannsen has contributed much to our knowledge of selection and has given us a more exact method of experimentation by his conception of pure lines, biotypes, genotypes, and phenotypes. His experiments in the selection of pure lines of beans in an attempt to produce large and small seeded types have led him to conclude that selection within a pure line is ineffective in producing changes. He did, however, secure new types from pure lines through mutations.

Tower's experiments with the potato beetle in attempting to

create by selection large and small races, albinic and melanic races, and races with changed color-pattern, although conducted carefully for from ten to twelve generations, failed to give any evidence of producing permanently changed types. While strains of plus and minus variates gave populations with a range of variation apparently markedly restricted to their respective sides of the normal variation range, still these selected strains did not greatly exceed the normal range of variation in either direction, and when the selection was discontinued, in two or three generations, again produced populations exhibiting the normal range of variation. Clearly no new unit characters had been added by the selection. Tower, however, found that by subjecting the beetles, during the process of the formation of gametes, to certain abnormal conditions, he was likely to obtain mutations in the progeny that would immediately form the beginnings of new races.

Jennings in a series of selection experiments conducted with *paramecium*, that were continued for over twenty generations, obtained no evidence of a permanent modification of the type.

Pearl has conducted an extended experiment in the selection of chickens in the attempt to produce a breed of high egg-laying capacity. His results have led him to the conclusion that selection alone has no effect in producing a permanent improvement or a change of type.

Up to the present time these are the principal contributions to the subject, discrediting the effectiveness of selection as an active agency.

On the opposite side of the controversy we have the very careful and extensive researches of Castle and MacCurdy in the selection of Irish rats to increase the black-colored dorsal band on the one hand and to decrease or obliterate it on the other. Castle appears to have gotten very positive results favoring the gradual cumulative action of the selection, as he succeeded in markedly increasing the amount of black in one strain until the rats were almost wholly black, and in the other strain almost wholly obliterating the black. I am not informed whether the inheritance in hybridization of these apparently new characters has been tested. If a new character has been added it should maintain itself and segregate after hybridization.

The experiments conducted by Dr. Smith and others at the Illinois Experiment Station in selecting high and low strains of corn with reference to oil and protein content have resulted in markedly distinct strains possessing these qualities, which are inherited apparently as long as the selection is continued. It seems certain that

they have increased the oil and protein content much beyond the maximum, which existed in the original race. I am informed by Dr. Smith that these new races of high oil and high protein content have maintained their character for several years in isolated plants without selection and it would thus seem that a permanent heritable change of character has been produced as a result of the selection. The behavior of these apparently new characters in hybridization has, however, not been tested and we thus do not yet have the complete evidence of the test of the characters which is necessary to enable us to fully analyze the results.

Very many cases of increases obtained in quantitative characters could be cited, but the majority of the experiments were undertaken, primarily, to obtain practical results, and whether such apparently new characters would stand the test of unit characters is doubtful.

The improvement of the sugar beet by selection forms a typical and instructive case of this kind. The careful selection of the sugar beet was started over sixty years ago by Louis Vilmorin, at which time a range of variation in sugar content of from 5 per cent to 21 per cent was known to exist. Since that time the industry has grown extensively until hundreds of thousands of beets are examined annually and the richest in sugar content selected for seed production. The process of selecting the beets richest in sugar content for mothers has now been continued for sixty years and is practiced extensively every year and yet there is no evidence that the maximum sugar content has been increased, and it is certain that the character of richness in sugar content has not been rendered permanently heritable, as sugar-beet growers well know that their success depends upon the continuance of the selection. Here it is certain that no distinct unit character has been added by the continuous selection.

The strongest evidence as to the method of origin of new characters is derived naturally from our knowledge of known cases of the origin of such typical new characters. When we view the evidence critically, I think it must be admitted that in practically all, if not all, of the cases of new characters appearing, they have come into existence suddenly. The cut-leaved *Celedonium*, the Cupid sweet pea, *Bursa heegeri*, the Otter sheep, the muley cow, are illustrations familiar to all and doubtless each of us could add several such illustrations from our own knowledge. Such new characters appearing suddenly are heritable and maintain themselves as unit characters in hybridization. We cannot but admit that the evidence of these known cases counts against the origin of characters by gradual cumulative selection.

In summarizing this part of our discussion we can only state that at present it appears that far the greatest weight of evidence is opposed to the origin of a new unit character through the cumulative action of selection.

Are we, then, to conclude that the practice of breeders in continually selecting from the best for propagation is useless, and must we advise practical breeders to discontinue their selection? How can we do this in the light of the success of the sugar-beet breeders? Have not Sea Island cotton growers increased and maintained the length and fineness of their staple by continuous selection? Have not corn growers maintained high productiveness of different strains by selection? Are not the Jersey and Holstein maintained at a high degree of efficiency by selection? Has not the speed of our trotting and pacing horses been increased and maintained at a high rate by the most careful selection? To one familiar with the history of agriculture and breeding these questions arise fast and are likely to be insistent. There can be no doubt that the practical breeders have made advances by selecting from the best individuals. No genetist or scientific breeder will deny this. It is simply the question of the interpretation of how the results were obtained that is in doubt and whether these results can be considered as permanent new unit characters. Before we can thoroughly understand this subject it is probable that each individual case will require to be carefully analyzed to determine the nature of the advance made and the interpretation of the process or processes concerned. At present we can only partially understand the phenomena presented.

It appears to me that we are dealing in breeding with two markedly distinct types of selection, based on different principles and arriving at different results, both right in principle and productive of equally valuable practical results, but of very different value when considered from a strictly evolutionary standpoint.

It would seem that such cases of improvement as are illustrated by the sugar beet indicate that the continuous selection, generation after generation, of maximum fluctuations shown by a character will result in maintaining a strain at nearly the maximum of efficiency; and that within a pure race the progeny of a maximum variate which would probably be classed as a fluctuation does not regress entirely to the mean of the race in the first generation succeeding the selection, but that we only have a certain percentage of regression similar to the regression determined by Galton. It would further seem to be indicated by the evidence now available that

in some cases we may even expect the continuously selected strain to exceed the ordinary maximum of the unselected population. In the Illinois corn experiments the maximum oil and protein content seems clearly to have exceeded the ordinary maximum, and is certainly maintained at a very high degree with a new mode and range of variation. If a new mutant of high protein content has been secured in the course of the experiments with a change of type, it is probable that this high protein content will behave as a unit character in inheritance. On the other hand, if the results are interpreted as simply the maintenance by isolation of a strain produced by selecting fluctuations, there would probably be a rapid return to the normal range of variation of this character if the selection was discontinued.

De Vries has pointed out that natural selection can produce races and maintain them, but its power to develop races beyond the natural range of variability remains to be demonstrated.

With reference to his experiments with the potato beetle Tower states, "It is demonstrated that among the fluctuating variations there are individuals which are able to transmit their particular variation and give rise by selection to a race, while the majority are not able to hand on their particular conditions to their progeny. Races developed by selection from such variations have not been carried beyond the normal limit of variability of the species." These races or selected strains maintain themselves as long as the selection is continued and when the selection is discontinued rapidly regress to the mean of the species.

The above examples from the sugar beet, corn and potato beetle will illustrate the type of improvement usually secured by practical breeders. By their selection they maintain a strain of high efficiency without having in general exceeded the limits of variation of the species or race and without having produced new unit characters which would be maintained without selection and segregate as pure units following hybridization.

[CONTINUED IN NEXT NUMBER.]

DOMESTICATION OF THE FOX.

BEN. I. RAYNER, *Alberton, P. E. I., Canada*
and

J. WALTER JONES, *Washington, D. C.*

The silver fox rearing industry is not new to scientists. As long ago as 1908 the Biological Survey of the United States Department of Agriculture published a bulletin on the subject and E. Thompson Seton in 1909 wrote of the industry in his *Mammals of North America*. The silver, cross, and red foxes have been bred for five or ten years in Ontario, Labrador, and Maine, but all these breeders secured their stock with few exceptions on Prince Edward Island, Canada. Visitors to Prince Edward Island, seeking information as to breeding methods, generally secured very little information. In fact, not 2 per cent of the 100,000 inhabitants of that beautiful and thickly settled island knew that an exceedingly profitable industry was being prosecuted somewhere in the woods on their neighbors' farms. Although the industry began twenty-three years ago, no breeding stock of large value had left the hands of the close circle of breeders who were guarding their secret well. Only a few choice skins and a few light silver foxes had come into the possession of those outside the "combine" previous to 1910, when it broke. At the present time there are about eighty ranches on Prince Edward Island stocked with about two hundred fine dark silvers, about 300 silver-grays and perhaps 400 very light silvers, crosses and reds. The total skin value is about \$550,000 and current prices of breeding stock make them worth at least \$1,500,000 but it is safe to say that the industry could not be purchased outright with twice that sum.

In the year 1888 one James Lamb, while hunting some strayed cows in the woods, found two silver fox pups, a male and a female, in a hollow log. He contrived to carry them home and swapped them with a neighbor for a cow and a few dollars to boot. The neighbor experimented for several years with various kinds of pens and treatment, but he became discouraged and sold the foxes for \$80 to another neighbor, who also was no more successful than the original finder. This second man gave over his experiment to yet another neighbor, who lived on an island in Casumpce Bay. The quiet of the new place, the increasing tameness of the foxes, and the understanding of the new keeper produced conditions that relieved Madame Reynard's nervous apprehension for her young's safety and three pups were reared to maturity in two seasons. This success,

the result of eight years of experimentation, gave a strong impulse to the industry, which began in earnest. About six men possessed a knowledge of the fine art of rearing foxes in captivity and jealously and successfully guarded their secret until 1910. Up to that time no live foxes were sold, except some light silvers to distant places.

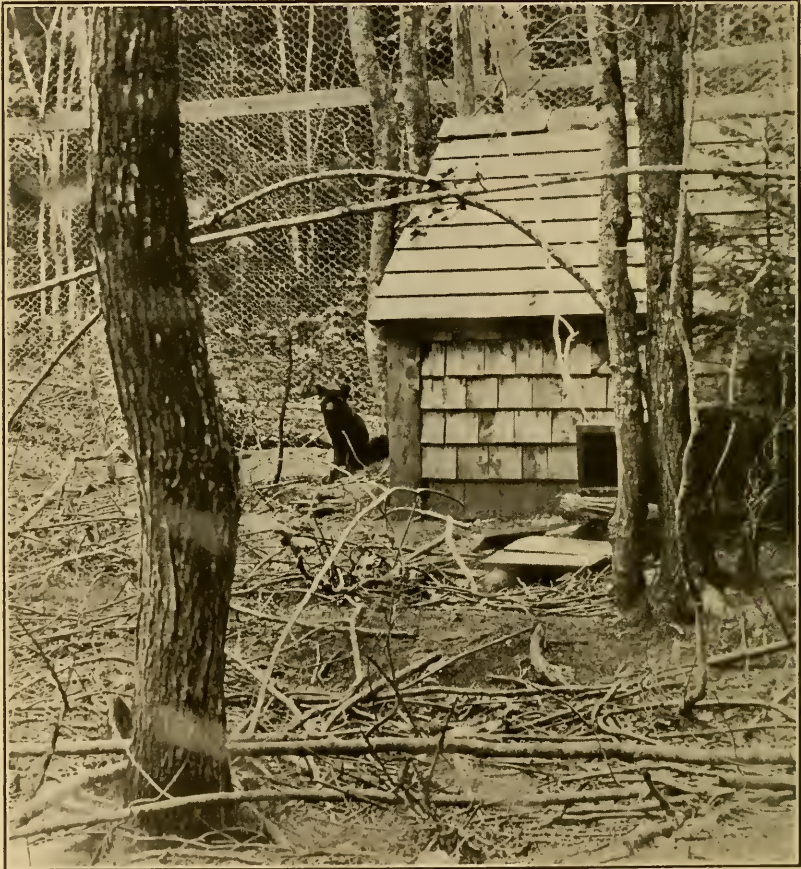

THE SILVER FOX.

The rarest and dearest of the hunters' prizes—the silver fox—is now reared in an inclosure as a domestic animal. Who will achieve the domestication of the Russian "sable?"

The surplus stock were killed and the pelts marketed in London. In 1901 a dark silver pelt brought £580 (\$2825) at a London auction, and last year (1910) prices of £540 and £480 were obtained. These are the highest prices ever paid for the pelts of any kind of animal.

The common red fox—*Vulpes fulvus*—is usually red in color, but redness is not a distinguishing mark of the species. The other color is black, or silver-black, when only a near-by examination reveals the presence of light hairs, excepting on the tip of the tail. The light hairs are black at the base and tip but have a silver portion not far from the outer end. Between the two color extremes there are found animals presenting every gradation of color between red and black. The animals are grouped in markets as red fox, cross fox, light silver fox, and dark silver fox. A black fox, so-called when alive, is classified as dark silver.

In nature, where indiscriminate crossing of the colors takes place, foxes occur in about the following proportions and pelts are bought from the trapper or breeder at approximately the following prices: Red 100,000, value \$5 each; cross 10,000, value \$15 each; light silver 1000, value \$2 each; dark silver 100, value \$1000 each. The price is in inverse ratio to the number produced. But while scarcity may influence the price of dark silvers, there is no question of the great intrinsic value of their pelts. They are marvels of richness and beauty and even if produced in as great numbers as the red ones, they would be many times more valuable. The price of the dark silver fox has always been high because that fur has always been popular with royalty and thus a constant demand existed. The enormous decrease in costly furs and the vastly increased numbers of people demanding them have brought about a situation very encouraging to the domestication of many animals with valuable fur because of the great profits.

The Siberian marten, called "Russian sable" in the trade, is now nearly as valuable as dark silver fox. A sable coat worn at the recent Horse Show in New York cost \$22,000. A set of natural black fox worn at the same place, consisting of not more than three skins, cost the owner \$16,000. Unless immediate steps are taken to increase the number of foxes, Siberian and other martens, otter, beaver and mink and some other valuable fur animals which promise to be capable of being domesticated, none but the extremely wealthy will be able to buy furs. The fact that the silver fox has been successfully domesticated by the efforts of a few men, without any encouragement from government, and with no financial backing except meager incomes from farming and trapping, should inspire extensive governmental experiments to determine the feasibility of extending the number of domestic animals to those which produce fur. The production of costly fur, henceforth, is a problem for the animal

husbandman. Doubtless the day will soon come when books of pedigreed records of foxes, martens, otters, and minks will be published.

When choosing a farm for purposes of breeding foxes three principal considerations—soil, climate, and location—must be kept in mind. A limestone or alkaline soil will decrease the value of the fur by making it harsh and brittle. A cold climate is a necessity in the production of high-class fur. The fox pens must be secluded from the intrusion,

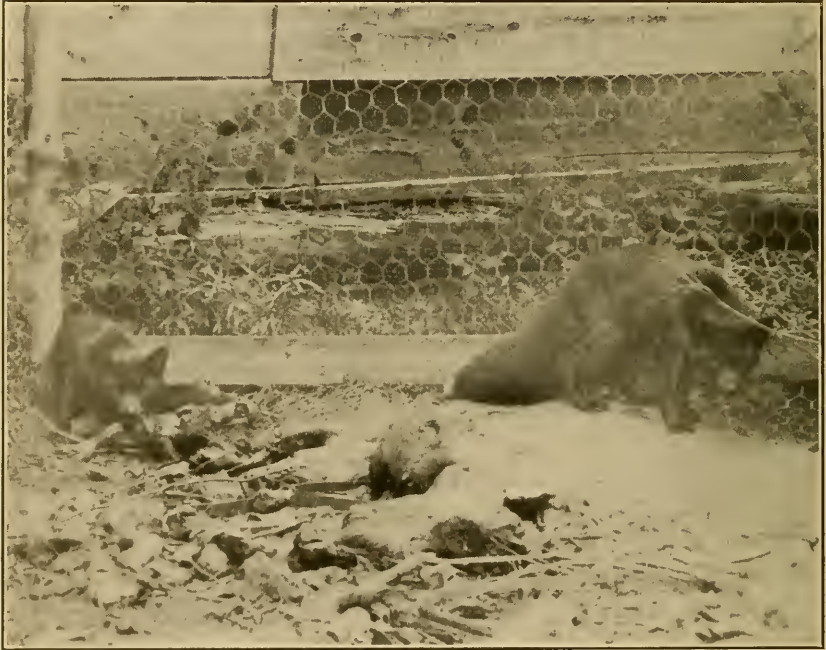

THE LITTER OF FIVE FOXES PRODUCED IN THIS PEN IN 1911 SOLD FOR \$14,000.

or even the observation, of strange men and animals, and a forest covering, preferably of spruce, fir, pine, or cedar, is very desirable.

The best breeders enclose from three to five acres with a 2-inch mesh wire fence 8 feet high. The wire is buried about 3 feet into the ground to prevent burrowing under and it is turned in at right angles for 2 feet at the top to prevent climbing out. No. 14 gauge, galvanized, wire is used in the ground and No. 16 gauge at the top. The gate in this outside fence is kept constantly locked and often the keeper, who sleeps in his little cottage close by, maintains watch dogs and bloodhounds. Inside the five-acre enclosure and for the most part not visible from the outer fence are placed the pens. The fences

about them are similar to those described above, but built with a little more care. Meshed wire is sold in 150-foot lengths and one roll is used to enclose a pen, which therefore is about 37 feet square.

The fox house, or kennel, has been in the past built like an ordinary dog kennel with a crooked spout for an entrance. The crook excludes the light and the spout resembles a burrow sufficiently to cause the fox to accept the man-made wooden substitute in lieu of her own "home-made" den. But more advanced husbandmen have devised better housing facilities. The best of these, probably, is the invention of B. I. Rayner, of Alberton, one of the pioneer breeders and on whose father's farm the original foxes were caught. His house is 8 by 10 feet, with a pitch roof and provided with ventilation. It is double-boarded and papered. A passageway extends through to admit the keeper. Four fox apartments—one for each pen—are constructed, one in each corner of the house. Each of these apartments leads through a spout or burrow to the pen, or paddock, outside. Each apartment has two rooms,—a cleaning room and a nest which is carefully lined with seaweed. Ventilation over these is provided, and provision is made for allowing the owner a sly peep into the nest while the mother is outside getting her meal. Such a house is always built strongly in order to resist the possible attempts of sneak thieves to enter. When strangers are about, foxes are nowhere else but in their nests.

In any well-settled country there is enough cheap food to provide for hundreds of foxes. A healthy old horse or cow, livers, heads, feet and other butchers' refuse, calves, fish, bread, milk, eggs, rabbits and even poultry—all provide the best of fox food. A nursing mother fox gets a goodly share of eggs, milk, and porridge. As a whole, in a province like Prince Edward Island, settled with fifty people to the square mile, it costs two or three cents per fox, per day, to feed them. Some of the ranches have great numbers of rabbits inside the outer fence which give the foxes a chase and familiar food frequently.

The problem of breeding for quality has been well worked out. When good dark silvers are once secured they always produce dark silver pups. It may prove that black is the recessive color,—breeding true when secured. It is said by trappers that sometimes crosses and silvers have been found in red fox dens. If so, the proportion of reds and silvers are near enough to indicate that the red color is dominant and the black recessive. But as far as Prince Edward Island experience goes only blendings of the two colors is produced by any mating and every blend breeds true to its own color.

Numerous attempts have been made to introduce silver stock from Labrador and Newfoundland. Though in every case size and strength were secured, quality of fur was lost. No high-priced pelt has resulted from such mating. Many cross bred foxes were imported from the Western States with the object of securing size and eventually breeding up to a dark silver strain from cheap stock. Descendants of these are on various ranches today, but not in those of experienced breeders.

The ranchers working with the best success have only descendants of the stock originally caught on Prince Edward Island. All high-

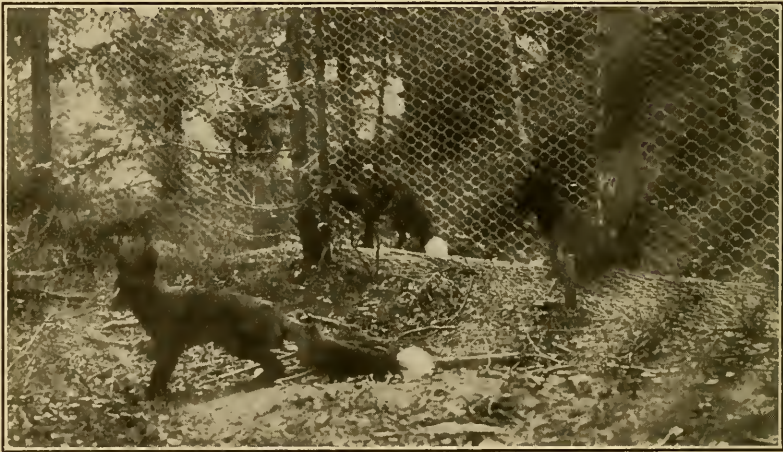

YOUNG FOXES

Note how the wire is turned in to prevent burrowing

priced pelts came off foxes of this strain. If an ordinary red fox of Prince Edward Island is bred to a black, and the resulting young is bred to a black, and thus for four or five generations, a good silver fox results. The first cross produces what is designated as a "cross" or "patched" fox. The next mating produces a cross of a better quality with almost no reddish tinge in any hair and silver patches over the back, the third mating produces a light silver worth probably five hundred dollars, and a fourth mating produced a silver worth probably one thousand dollars. Many farmers of small means thus breed up their stock by the use of only one high-priced animal

Foxes have been kept as pets and in zoölogical gardens from time immemorial but they have never been known to rear young. The reason of this seems to be the extreme nervousness of the female.

She has been known to carry her young about in her mouth for days, putting them now in one place, then carrying them to another, until they succumbed to exposure and handling. Keepers have had to stay by the pens day and night for several days at a time to keep watch on the mother. An instance of the behavior of a certain mother fox on an Ontario ranch is related as typical of what a slight incident may cause trouble. A ranch owner whose home was within sight of his fox pen was having his house painted. When the painter began to put the new color on the house, either the sight of the stranger or the smell of the paint so excited the mother that she brought out her young and killed them. They are so wild that ranchers make a habit of closing up the ranches in January to all except the keepers, and keeping the ranches closed until June, when the young are out playing about. Only keepers may approach the pens during the breeding season and it is declared by some of them to be risky even to change clothes lest the change worry the fox.

The male, which is monogamous in the wild state, forages for the young. But when food is provided two parents would probably kill the young with overattention. Therefore, the male is removed about the middle of March. The period of gestation is fifty-one days exactly. The young arrive in March, April or early May. Litters of from one to as many as eight are recorded but the average is usually about four pups. One mother fox has reared eighteen young in three years and a price of \$8000 was refused for her. They are fertile nine or ten years. They are mature in eight months for fur or breeding. Some breeders have been able to mate one male with two agreeable females, such as sisters, and the custom appears to be growing. Thus selection of sires can be made and quicker improvement in quality achieved, if indeed improvement be possible.

During their productive period of about nine years one pair of foxes will produce on an average about thirty young. If these are of the best stock, the pelts are worth fifteen hundred dollars each at the present market prices. Thus the yearly profits from a pair is about \$5,000. But certainly every joint-stock company that forms and hires a manager cannot expect to secure such results. Efficient managers are very hard to find and the best management will not prevent occasional escapes and thefts. The industry is best prosecuted as a regular part of the work on a diversified farm where waste food materials, quiet, and the personal interest of the owner will go farther towards insuring success than any skilled management capital can purchase. The business could be very profitably prose-

cuted by neighbors who could unite in the feeding, care, protection of the stock from thieves, and hunting and trapping of escaped animals. Joint stock companies with a total capitalization of over a million are now incorporated for fur farming in Eastern Canada and the result of applying capital to a farming industry of this kind is being watched with great interest. The result at this date has been to raise the price of foxes from \$1,500 or \$2,000—the actual fur value of good dark silvers—to \$3,000 and even \$4,000 for the pups of 1912. The quantity of foxes being limited to a small increase each year, there ought to be no danger of a “rush” or boom. At any rate, the prices are not yet high enough to prevent considerable profits, eliminating, of course, the risk of theft and escape from the argument.

The profits of this form of wild animal breeding was stated by an experienced breeder in another way, thus: “It is more profitable for an experienced breeder to rear red foxes at \$5 a pelt than to rear sheep, getting \$5 for each lamb and 20 cents a pound for wool.”

The fur is taken the last week of December. It is usually sold at the March sales in London, to which city it is sent by mail, insured. After the sale, the skins mostly go to Germany for manufacture. Many of the furs become the property of royalty, particularly those of Russia and Austria. A gorgeous effect is produced in some cases by putting gold, by electrolytic methods, on the hair tips,—black fox being the only fur that retains it.

The immense profits of the industry are a considerable inducement to farmers to enter into the business, and a question which naturally rises is as to when and where the break in price will occur. With growing wealth and love of luxury the day is far distant when the demand will decrease or the prices fall. There is a basis for a huge industry in production of furs. Between two and three hundred million dollars is the price the “consumer” annually pays for American reared fur alone. It may be argued that silver fox is only for the wealthy, but so is the whole diamond industry. The Cullinan diamond, now being cut and polished in Amsterdam for Britain’s King, will have an actual commercial value of \$2,500,000 when finished and its unique character will make it priceless.

And when estimates of increase in numbers of foxes are made it must not be assumed that all ranchers will be successful and produce the natural yearly increase of 300 per cent. Probably 200 per cent increase is nearer the actual results to be obtained. Thus there will be 4000 silver foxes in 1915. Even if every one of these were marketed

in the same year, so small a number would only stimulate prices by attracting more buyers to the auction. And finally, even granting that the price of dark, silver pelts shall in twenty years' time have dropped to \$100 each, there is at that price more profit in the industry than any of the fox ranchers could possibly make in other stock-breeding lines.

With such prospects, why is the domestication of other valuable fur bearers delayed? Why are the woods being depleted of our handsome wild animals by such a cruel method as trapping? Why are not trappers converted into animal husbandmen?

EVOLUTION OF THE STANDARD BRED

F. R. MARSHALL

Columbus, Ohio

The Standard Bred or American Trotting Horse is the most notable success of American effort in the field of breeding. The breeding and racing of trotters is a national sport and for many years past has engaged the closest study of some of the most capable Americans. We have other native breeds of note, but none that is anything like so generally distributed through the various states as is the trotting bred horse. All professions and all kinds of business include men who give much of their thought to the breeding and raising of a few colts each season. What such men do for pleasure and for recreation is usually done quite thoroughly. Accomplishment in breeding comes through careful study and the exercise of common sense and the ability to execute what the judgment dictates. Such men as have been referred to have usually given their horses the same study and good judgment that had been exercised in the development of their commercial interests. Their wealth has enabled them to carry their ideas into practice in a way that has seldom before occurred in the history of any breed. The result has been the combination of the best qualities of the various strains and families from which the breed in its present status has sprung. Men of more modest means have often accomplished with their brains what money alone could not do, but a surprisingly large proportion of the stronger breeding strains have arisen in the studs of men, characteristically American, in business lines and in the field of sport.

Standard-bred horses vary in color, size, shape, and way of going. Some writers argue that because of this admitted fact these horses

cannot be properly designated as a breed. The test of breed status is uniformity in the characteristics by which the animals are distinguished from others of their kind, and in their ability to answer the purpose for which they are bred. Percherons are bred for draft work, and lack the uniformity of a breed if considered from any other standpoint. Some saddle bred horses have speed, but the American saddle horse is a breed only when considered as adapted to use under saddle. Judged by color or conformation, the standard bred horse does lack uniformity. But his distinguishing trait and the reason for his existence is speed at the trotting gait. When considered on this basis, there can be no room for argument as to his fixity of type. The 50,000 stallions that have been recorded in the last thirty-five years include some foaled as early as 1840. Necessarily many of these stallions never received for themselves or for their get the opportunity to demonstrate their speed qualities. The total number of horses registered in the American Trotting Register up to date is something over 200,000. Of the mares included in this number, a considerable proportion have never had a fair opportunity to enter the 2:30 list. Yet the list of 2:30 trotters and 2:35 pacers at the present time includes over 46,000 horses and in 1910 there were entered 1661 trotters and 1983 pacers. At the close of 1910, 1367 trotters and pacers had records below 2:10. What other breed can show as large a proportion of its registrations having as high a degree of demonstrated merit? Nor is the criticism as to lack of uniformity in appearance well founded. A discriminating eye will find as high a degree of uniformity in the points of conformation that contribute to speed as is to be found in the essential features of any other breed.

Readers of the *American Breeders Magazine* are familiar with the history of our national horse. The purpose of this article is to use the trotters' history to show what may be the true rôle of selection in breed improvement. It used to be considered that successive crossings of superior sires effected a continuous advance of the progeny toward the qualities of the stock from which the sires came. We cannot yet discard this idea in considering the grading up of nondescript animals by the use of well-bred sires. But it is in the effort to explain the production of new types within breeds that the greatest difficulty is met. Those whose thoughts are chiefly of practical breeding hold to the idea of cumulative selection though they have to admit that the advance is much more marked at some times than at others. Persons less well acquainted with the history of breeds and alive to the significance of the developments of the last ten years are often

skeptical as to cumulative selection and explain improvement as the result of fortuitous combinations of characters, which also are much more likely to appear under some conditions than under others. This latter school would regard the epoch-making animals of the past and present as mutations. If that word is to be used, however, we can discard the thought that such animals really possess any character not previously found. They represent happy combinations of the good qualities of numerous ancestors, all combined in one package by the possibilities in reduction and combination of gametes. Such an animal may exhibit a particular character in a new degree by having received it in full strength through both parents. In this sense selection does permit an accumulative effect though it originates nothing. Such effect is not certain from any particular mating but is most likely to occur when the desired tendencies are present in both parental lines.

Professor Harper's figures showed that high producing cows come chiefly from high yielding strains and fast trotters occur most frequently among the offspring of fast parents because there is an enhanced probability of accentuating existing tendencies or of uniting facilities of speed not previously united in a single animal.

All the qualities that make up our fast horses were in existence even before 1788, the beginning of the era of Messenger. These qualities were widely scattered, however, and it has been the work of those doing the selecting to combine the elements that go to make up trotting speed and thus to secure horses having a greater proclivity to trot than was possessed by any single one of their various ancestors. Nothing was originated unless we think of a new combination of qualities as coming under that term.

To attempt to determine the ultimate source of the numerous peculiarities that facilitate speed at the trot, would lead into the earliest forms of the species and be much more a study for the evolutionist than for the breeder. I have referred to the component parts of trotting speed. No scientific or practical good can come from considering the ability to trot in record time as a single, separate or unit character. It is impossible to completely analyze speed, but the least experienced follower of the trotting game readily recognizes that speed is possible only in the presence of a combination of a large number of separate qualities or characters. While no data is at hand to support this, it is possible and highly probable that each one of these contributing factors is inherited in Mendelian fashion, but until these factors are reduced to unit characters their transmission cannot be studied with any approach to exactness.

One of the main features in trotting speed is driving power. The efficiency of driving power depends upon the proportions of the body and of the limbs and the muscular development. These determine the smoothness of the working of the machine, and the proportion of the power that contributes to the forward motion. Then there are differences in elasticity and capacity of muscles to withstand the tiring effects of extreme exertion. Defects of conformation, including muscling or proportion, eliminate some and limit many. "They go all shapes" but in spite of them, and when an ill-shapen one is really fast it is usually by virtue of unusual mentality. In a much larger degree than is commonly supposed, speed comes from the brain. Some horses cease trying to win when they lose the lead, while others fight through the stretch to the wire with all the courage and determination of the best athlete. Others with wonderful speed lack the balance and control and steadiness necessary to keep them at their gait. The main reason why the trotter is more popular than the running horse is that he must try to win and yet have mentality enough to resist the temptation to run. Troubles in feet and limbs and joints hamper many that are otherwise fitted to go fast, and soundness and wearing quality in these respects are vital elements of trotting speed.

In considering the rôle of selection in the evolution of the trotter, we will not be far astray if we consider the sources and development of his peculiarities of conformation, his mentality, the wearing qualities of joints and tendons, and chiefly his disposition to go at the trot in preference to any other gait. It has been the work of the breeders to combine these components of trotting speed in one animal and then to breed so as to secure horses strong enough in their inheritance of those qualities as to be similarly strong in the transmission of them. The work of combining inheritance of symmetry and refinement and reducing the dross of native equine stock had been notably well done in the home of the Arabian. The existence of the Arabs depended upon their horses and centuries of selection resulted in an animal having a combination of characters that portrayed the ideals of his breeders. In beauty, stamina, and structure of limb and joint the Arabian horse has been the pattern for all subsequent types. With English breeders he was deficient in size and he had been bred for a long-distance running rather than for track racing. The union of Arabian blood with that of the best English horses gave some animals more useful to the English breeder than the best representatives of either of the parent stocks. In time the same results might have come

from selection within pure Arab lines but the stock was scarce and its type too firmly fixed to be readily modified. On the other hand, England would have had a great running horse even without Eastern blood but such a performance as that of Eclipse in 1769 would have come at a much later date.

In the first crossings of the English and imported horses there were doubtless many that combined the undesirable features of both lines and in only a few instances did the then unknown germ cells bring into combination a preponderance of the best from both lines. Nor were performance and appearance sufficient to show which were the most valuable animals. Then, as now, the breeding test was supreme and some individuals of note left poorer offspring than others more obscure but really superior or else more fortunately mated. The final result of English effort was the thoroughbred.

The relation of the American trotter to the thoroughbred is analogous to the relationship between the thoroughbred and the Arabian. The horse stock of America was strongly charged with qualities received from the thoroughbred before there was any distinct effort to breed a roadster. The animal desired for road driving needed all the stamina and points of conformation and structure of limbs and joints that characterized the thoroughbred. Some thoroughbreds were very useful in harness, but as trotting races became more common it was apparent that the ungovernable propensity to run that was the making of this horse under saddle was his undoing when in harness. The founders of the trotting breed of trotters have not needed to develop a number of new qualities. Their chief work has been to take propensity to trot wherever it could be found, to accentuate it and combine it with the common points of equine excellence.

Just what enters into the propensity to trot is not clear. It is possible though unlikely that it is a single and separate inherited feature. There is no uniform difference between trotters and runners in body proportion or in the proportionate lengths of forearms and cannons. When we see yearlings and two-year-olds from certain families that make the most extreme efforts to win and yet never leave the trotting gait we must recognize the part played by the mental make-up of the trotters, and as yet mental features cannot be analyzed or easily followed in transmission.

By 1800 it was apparent that the get of the imported thoroughbred Messenger was especially good at the trot. Mares of other strains were mated to him and some of the get that inherited the trot-

ting propensity in its full strength from both parents, if their other characters permitted, were much better trotters than either of their parents. Thus, selection, while it does not originate anything, does accentuate minor tendencies or originate new degrees of tendencies or propensities. Selection when pursued in the light of careful study of individuality and ancestry seems to keep together in a single individual the desirable features of the best animals and also to add thereto such qualities from other sources as may serve to make higher degrees of excellence. Of course many of the animals bred will be no improvement upon their parents and sometimes the reverse. But where there is any harmony of mating, some chance combinations of good are bound to occur if the breeder is qualified to recognize them and they may be brought together, their produce similarly used, the misfits eliminated, and the type finally fixed.

Imported Messenger was not the only source of distinctive trotting qualities. Norfolk County breeders had long prized good driving horses and from thence came Bellfounder, thirty-four years after the landing of Messenger. A stallion strong in the blood of Messenger bred to a daughter of Bellfounder produced Rysdyk's Hambletonian, the first great sire of trotting speed and a progenitor of the large majority of living trotters. Hambletonian's second dam was a double granddaughter of Messenger. This or similar matings may have produced other horses able to transmit trotting qualities as did Hambletonian 10. If such were produced, they were never discovered. No other horse has ever meant so much to the trotters of his time as did Hambletonian 10 to the trotters of the third quarter of last century. He possessed nothing new unless we consider a new combination of previously scattered peculiarities of conformation and mentality as a creation. If he is to be considered as a mutation, then Henry Clay, sprung from the Arabian line, must have been the same, because Hambletonian's son George Wilkes from a daughter of Henry Clay was remarkable as an individual and as a breeder. If we adapt Mendelian terms, this result could not have occurred in the first generation unless George Wilkes' dam was a hybrid, and therefore able to transmit the trotting qualities.

Mr. Henry F. Euren has suggested an explanation of the greatness of Hambletonian 10 on the basis of the fact that both Messenger and Bellfounder trace to Blaze of 1733 to 1756. These are his words:

The fact that in the seventh generation from Blaze, on each side, the reunion of the blood in Rysdyk's Hambletonian, the sire of so many fast Ameri-

can trotting horses, should have proved to have been of the most impressive character, would appear to warrant the conclusion that there was a strong latent trotting tendency in the ancestors of one, if not on both sides of Blaze.

In 1887 Mr. J. H. Wallace wrote:

The foreign horse that played the most important part in originating the American trotting breed, and that figures in the ancestry of our greatest sires and performers, was Imported Messenger. Ever since trotting speed first began to be considered a mark of merit in the American horse, ever since trotting blood was talked of, the blood of this horse, Messenger, has been unanimously considered the chief foundation stone on which the greatest trotting families have been built. Just as the English race-horse was founded on oriental blood, and in years of selection and development for a special purpose was bred to a point of excellence unknown to the oriental, so the most unpretentious trotting blood of today is superior to what the direct blood of Messenger was. It is with writers on horse-breeding a very common but very erroneous thing to inculcate the idea that because some family of horses originated in a famous ancestor he was necessarily superior to his descendants of the present day. They forget that in forming a breed we rise superior to as we go away from the beginning. A stream meandering from a mountain spring may be the source of a great river; but if we follow that stream we find it joined by tributary after tributary until the aggregated whole is a mighty volume compared with which the source is insignificant. So the speed-transmitting power of Messenger, if it could be now drawn upon directly, would be a weak and sluggish element in the swift and intense speed currents of today. Still, none the less did it play its part as an original source.

Mr. Wallace's analogy can be regarded as a true one only when we think of the breed as a whole. The breeder deals with individuals and repeated matings of the same parents often give a wide variety of results. The combination of characters necessary to 2:30 speed is such a common one that there are now strains strong enough in their inheritance of those qualities to make the production of a 2:30 horse a practical certainty. As yet, the requisites of 2:10 speed are not regularly inherited together though some strains produce a surprising proportion of horses of that class.

Mr. Hamlin was peculiarly successful in breeding 2:10 speed and was able at the same time to combine with it size and style. Possibly fortune favored him, but his announcement at the beginning of his work that he would produce the then known 2:10 horse makes it seem that he must have had a remarkable insight that enabled him to bring from various sources the qualities he sought and unite them in the foals of Village Farm.

A METHOD OF RECORDING TYPES AND VARIATION IN FRUITS AND VEGETABLES BY DIRECT PRINTING

O. G. MALDE

Madison, Wis.

A special printing method has been employed with success in keeping records of cranberries in connection with nursery work at the Wisconsin State Cranberry Experimental Sub-Station, located at Grand Rapids, Wisconsin. Propagation by selection is carried on with about one hundred and sixty beds started from single cuttings of cranberry vines which were originally found on a few bogs and in wild marshes and which produced some exceptionally fine fruit. From the very choicest of these, seeds have also been planted and about thirty-five new varieties have thus been established. The recording or scoring is done on a basis of 10 for twelve characters or qualities, as follows: size, form, color, gloss, uniformity, keeping quality, firmness, flavor, productiveness, vigor of vine, time of flowering, season (early or late).

The first two characters on this score card it will be readily seen would require several measurements and considerable description. Size and form were first recorded by taking the measurements of three diameters of the berry. These however proved to be of little value for later reference, especially when it was necessary for the work to be continued by one not thoroughly familiar with the original method of taking the measurements.

Another character needing recording was that of the thickness of flesh of different varieties, and the writer therefore, in the winter of 1907, tried numerous experiments in bisecting large berries, stamping them on a well saturated inking pad in the same way that a rubber stamp would be used, and then printing directly on cards or in the record book. The method was found so satisfactory that it has been adopted for the record books and also in making up card indexes. Fig. 1 shows prints of the three main types of cranberries, namely, the round or "cherry," the oval or olive ("Jumbo"), and the long or "Bugle."

The main types each have two sub-types, one being tapering at the stem end and large at the blossom end, or bell shaped (this is in fact the prevailing or dominant sub-type); the other sub-type, but not nearly as common as the bell, is the one large at the stem end and tapering at the blossom end, or appearing as an inverted bell.

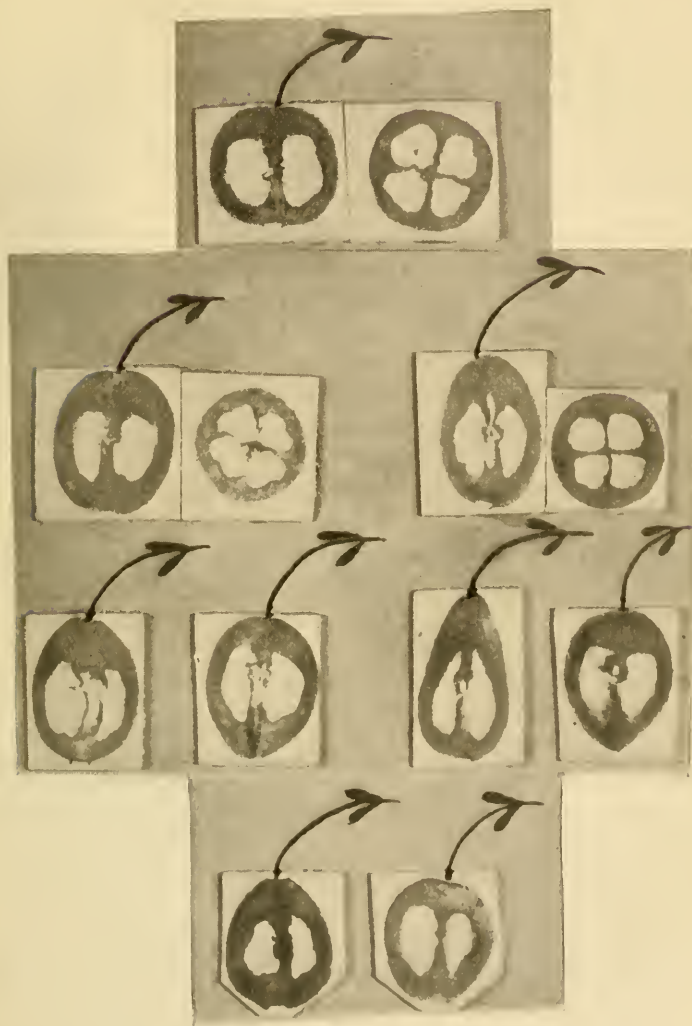

FIG. 1.—PRINTS OF THE THREE MAIN TYPES OF CRANBERRIES.

Rows 1 and 2.—The round or "Cherry," the oval or olive, ("Jumbo"), and the long or "Bugle."

Rows 3 and 4.—Six sub-types, two for each main type; the first tapering at the stem end and large at blossom end, called "Bell." This is the most common sub-type. The second sub-type is large at the stem end and pointed at the blossom end, like an inverted "Bell." It is described as a pointed berry, and is not common. The second sub-type of the "Bugle" is rather rare, as nearly all of the sub-types tend toward the "Bell."

The main method of bisecting to illustrate general form is by cutting longitudinally, while to show the general arrangement of the cells the berry is cut transversely at its largest diameter.

Immediately after the fruit is cut it is placed on the ink pad and pressed down gently so all of the cut surface will become inked. Then it is picked up with a substitute for a tweezers which consist of a No. 2 cork (fig. 2) with two pins extending about $\frac{1}{4}$ inch through and with the points about $\frac{1}{4}$ inch apart. The advantage of using the cork is that it permits applying pressure in making the print. In using the printing method with the cranberries all longitudinal prints are made with the stem end up. As the seeds easily shake loose when the berry is ripe there seldom is print of seeds, except where mature but unripe berries are used.

Fig. 3 illustrates the same method used with ripe imported tomatoes purchased on the market, and shows how well the thickness of flesh can be illustrated by this direct printing, and also shows how the seed mass in the ripe tomato has receded from the sides. Comparing two varieties not fully ripe and just removed from the plants in the greenhouse, one can readily see (as in fig. 4 of the "Comet") how well the thickness of flesh in the two is illustrated. In comparing these with fig. 3, one can see how the seed mass in the unripe tomato clings to the sides.

Fig. 5 illustrates the arrangement and size of stalks of celery.

Further tests with green peppers, carrots, onions (fig. 6), string and wax beans, apples, and pears have proved quite conclusively that this method can be used to much advantage in recording quickly characteristics and variations in types in connection with card indexing progress and results in various plant breeding experiments.

Such preliminary tests as have been made show that this printing method may be used also in copying cross sections of branches, or of galls and other injuries on branches.



FIG. 2.

THE "PICK-UP."

A substitute for a pair of tweezers (full size). This permits one to use some pressure in printing.

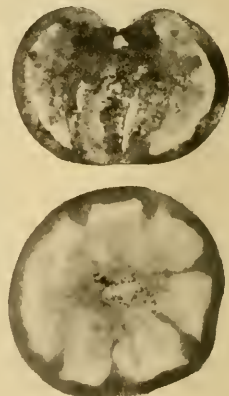

FIG. 3. LONGITUDINAL AND CROSS SECTIONS OF RIPE TOMATO (IMPORTED).

Purchased on the local market. Notice thickness of flesh and the seed mass contracted from outside walls. Reduced one-half.

Cross section of bulbs can be secured as can also stalks, buds, seed pods of simple-stemmed plants of the lily family, or the water hemlock, etc.

Some practice is necessary in securing the best results and the following points should be borne in mind when this form of copying is to be practiced:



FIG. 4.—CROSS SECTION OF "COMET" TOMATO.

Unripe and fresh from vine. Note thickness of flesh and the clinging of seed mass to sides.

(1) Have inking pad well saturated with regular stamping ink, red or black. Two pads are to be recommended in order that one may be freshly inked while the other is in use. There is considerable difference in the amount of ink required for different objects.

(2) Medium weight cards with a smooth but not too heavily calendered, slightly absorptive surface, give best results. Straw colored semi-gloss cards of medium weight are also satisfactory. Cards are found best as they do not warp with slight moisture.

(3) Bisection should always be done with a thin but rigid knife. Well worn case knives have given good results. Mounted Gillette safety razor blades are exceptionally well adapted to bisection cran-



FIG. 5.—CROSS SECTION OF CELERY PLANT.
Arrangement of stems.

berries and other small fruit. An ordinary thick-backed razor is not suitable.

(4) Mature fruits or vegetables give best results when fresh and not quite ripe.

(5) Very juicy fruit should first be stamped on a smooth blotting paper or left on it for a short time, but not long enough for the edges to contract.

(6) It is necessary to work rapidly when bisection and inking the material to be printed in order that none of the objects

shall be left long on the inking pad, for if left too long on the pad they become very moist and must be stamped on the blotting paper before making a print on the card.

(7) In the case of a large and hard object such as an apple, it is necessary after placing it on the card to pass the fingers gently over

the under side of the card to secure perfect contact with the printing surface.

There are only a few of the fruits whose juices would sufficiently color the card to give a satisfactory print and for that reason chiefly it is desirable to use the ink. One could no doubt satisfactorily



FIG. 6.—BISECTION OF COMMON ONION.
Notice distinct outlines of layers.

print a red beet, however, without the use of ink, as fairly good prints have been secured of cranberries by means of their own juice alone. The chief difficulty is that the juice has a tendency to spread and this is avoided by the use of the viscid stamping ink.

EDITORIALS

CIRCUIT BREEDING

Conditions existing upon the islands of Jersey and Guernsey and in the counties of Hereford and Lincoln in England are examples of the many advantages arising from the creation of a valuable new breed of domestic animals. The entire community is benefited by having superior animals for their own use, thus increasing the value of the products of their farms. Those who carry on the business of producing pedigreed breeding stock for sale outside the community make satisfactory profits from the high prices which breeders and farmers are willing to pay for superior pedigreed animals. The public at large are benefited by being able to secure animals of a new breed which adds value to their herds and farms.

Our own and other countries have long been lulled to sleep by the magic word "imported." We have rather assumed that only in England and western Europe could there be created new breeds of animals. Our own market for pedigreed animals is the largest and vastly the best in the world. Yet we threw the cream of it into the hands of the British breeders. They found that fat and the finish made by good keeping so caught the eye of the American breeder that even breeding horses of the draft breeds were often sold on a basis of weight. Horses with forms beautifully rounded and fashioned by fat brought prices all out of proportion to their values as parents of long-lived, tough, clean-limbed, sound-footed horses having, in their turn, genetic power to produce drafters full of years, crowded with days of work. The importer's standards have been too narrowly those of the farmers to whom he was to sell breeding animals, and the farmer accepted as standards too often those over-fatted meat or breeding animals which brought the highest prices in the sales ring or won the highest award in the show ring.

The time has come when Americans should discontinue the rather unoriginal device of importing European pedigreed stock. Few breeding animals should be imported and those few should be the exceptional mutations, and chosen with the greatest care and scientific skill, primarily to serve as foundation stock in the production of superior sub-breeds and breeds of our own.

There has been accumulated in the work of animal breeding, plant breeding, and genetics a sufficient body of scientific fact, philosophy, and method to serve as a basis for the construction of broad plans for the rapid and profound improvement of American domestic

animals. Many excellent foundation stocks of nearly all the species of domestic animals to be found in the world are already assembled in American herds and flocks. The blood of some of our wild species may prove valuable and our resources and possible profits are such as to warrant the importation of such stocks of domestic and wild species, wherever found in the world, as may promise to serve our purposes.

Plan of Coöperative Circuit Breeding.—Through its committee on Coöperative Breeding of Animals, the American Breeders Association has made a study of plans for better unity, science, and practice in the production of improved forms of our domestic animals. This investigation resulted in plans which have been put into operation by the United States Department of Agriculture and several experiment stations, under the name of Coöperative Circuit Breeding. These plans were so wrought out as to utilize to the greatest advantage the best practice of those who have created the existing breeds of animals and the similar but more highly perfected practice of those who produce new varieties of plants. These plans though scientific are simple, straightforward, and look to important results in the early development of families, sub-breeds, or even breeds which yield increased service and profits per head or per herd and flock; plans which are directed toward securing those combinations of characters which best serve in the production of the one or more specific purposes for which the breed is designed. They are designed to find the blood of those mutants whose blood when rather narrowly bred will give herds or flocks of high average excellence, and when used in upgrading herds of common or mixed breeding will be potent in rapidly improving them.

The plan of coöperative circuit breeding provides public funds for the scientific direction of such parts of the work of a group of twenty or more coöperating breeders, as recording the individual and genetic value of each animal, assisting the breeders in the methods of uniform care, and the mating of the animals. The coöperating breeders, in return for the scientific assistance rendered, serve the public under contracts to continue for a specified period in their efforts to secure the best foundation animals of the breed or breeds chosen to be improved, and annually to retain and so breed those which have the best individual and genetic records as to build up gradually a family, a sub-breed, or perhaps even a breed of the highest value to the public at large. Circuit breeding under public auspices takes the plans of our greatest breeders, improves upon

them, broadens out more widely the basis of the number of animals used, and seeks thoroughly for superior and mutating foundation stocks; it combines art and scientific records of performance in selecting and mating animals, discards more rigidly all but the very best, and avoids the loss which comes from the dispersion of a herd consequent upon the death of a successful breeder. These plans recognize the superlative importance, once a superior breed or family has been created, of having a permanent source of supply of breeding animals of the improved type, and that this source of supply be continued under scientific management; also that a permanent supply of large numbers of highly efficient breeding animals be continuously available to breeders outside the circuit, in the same state or in other states.

Organization of a Breeding Circuit.—Ten to twenty breeders form a coöperative circuit breeding association, the farms of these breeders being located preferably in the same county, or at least in adjoining counties with not too great distances between the farms. The State Experiment Station and the United States Department of Agriculture join in this coöperation. The association, the station, and the department each choose a person to act as member of a "circuit council." The coöperating breeders purchase and own the animals. The two public institutions furnish the money to pay the salary and expenses of a circuit superintendent, including the cost of record books, materials and apparatus for making tests, as well as traveling expenses. The breeders individually and collectively contract with the council that each will own and breed a herd of animals of a breed and quality approved by the council. They further agree that each year the council shall separate each herd into two classes. The best individuals are to be placed in a reserved class which cannot be sold except to other members of the circuit, so that they will not leave the circuit. The remainder are held for sale for breeding purposes to outsiders. It is practically certain that the breeders in these circuits will with this public help build up herds from which they will be able to sell breeding animals at good prices; and in some cases these circuit herds may become so famous that breeding animals coming from them will be held at a high premium, and the simple fact of an animal having been bred in the circuit may come to be considered a guarantee of quality. The contract provides that when one breeder drops out, another can be elected to the coöperative association to take his place.

In bringing together superior animals for the foundation stocks

the superintendent assists the breeders. He keeps all data concerning the herds, collects and studies the literature of the particular herd, travels if necessary in search of stock even to foreign countries. It is proving convenient and wise to have one of the coöperating herds on an experiment station or branch station farm. Then public funds can more properly be used in bringing into the circuit high-priced animals from very distant points. Young stock in the reserved class can then be sold by the station to the other coöperating breeders in the circuit.

Two Coöperative Circuit Breeding Associations already Successfully Established.—The expenditure of public funds is abundantly justified by the selection and creation of superior stocks of domestic animals to be used by breeders and farmers in producing livestock products. Thus, in Minnesota the Department of Agriculture and the State Experiment Station are coöperating in the production of a sub-breed of Shorthorn cattle which are at once good beef and good dairy animals. If that work had now been in progress twenty years and the breeders of pedigreed Shorthorns could there secure breeding animals with which to restore some of the lost milking ability of this breed—made too exclusively a beef breed—the breeders in this circuit would be able to command excellent prices for all they could register for sale outside the circuit. And if milking Shorthorns should prove more profitable for dairy farms, or for general farms where the desire is not to milk the year round yet where cows are kept for special-purpose dairy cattle or special-purpose beef cattle, they would come very much into demand in their own communities. The fact that there is a dispute on as to whether dual-purpose cattle are more profitable, herd for herd, than special-purpose cattle for the general or specialized farm, constituted good reason for choosing milking Shorthorns as one of the first breeds to place under circuit breeding. The methods which are growing out of the work of comparison of animals and herds in circuit breeding herds will be useful in comparing the profits of herds of the different classes of live stock.

The second coöperative circuit breeders association was inaugurated three years ago under the combined auspices of the United States Department of Agriculture and the North Dakota Experiment Station. The breed chosen was the Holstein-Friesian, and the coöperators are a group of farmers, mostly of German descent, out on the edge of the short-grass country. They had proved to their satisfaction that a combination of dairy and grain farming was necessary to success in that region of deficient rainfall. They are

delighted with the circuit scheme of improving their herds and they are gradually introducing the blood of superior Holstein-Friesian families. As these circuit breeders test these blood lines for their adaptability for their own peculiar conditions, they will weed out and select so as to have a sub-breed of Holstein cattle suited to the dry, windy, cold climate of the northwest.

The Possibilities of Circuit Breeding Have Only Been Touched at the Edges.—A number of localities have been mentioned and discussed in some detail for additional circuits. Thus in New Mexico, Colorado, and other states it has been suggested that circuits be established under which horse ranchmen would coöperate under scientific supervision in the production of light horses, both drivers and saddlers. It has been pointed out that in the production of saddlers the largest and best of the grades would be available for army remounts and that the smaller ones would be in demand for cow ponies and for prairie saddlers generally. The hilly country in the Appalachian region has been mentioned as suited to circuits for the production both of driving and saddle horses. The Morgan-horse project in Vermont will doubtless naturally take on more and more of the form of the typical circuit project. In the hilly country of Pennsylvania, West Virginia and southward are splendid areas in which circuits for either drivers or saddlers could be organized. Why not one such circuit devoted to purebred Arabs, another to purebred North African horses, as well as others to Thoroughbreds, to American Saddlers, and to American Roadsters?

In the light of modern efforts at making scientific plans for breeding, what a mistake Vermont made in allowing her famous Merinos to be dissipated and her Morgan horses to wellnigh pass off the state! Circuit coöperation on the part of the federal and state governments would soon secure to the Green Mountain State large profits from the sale of the choicest of breeding animals from these two breeds; and the country at large, the world in fact, would be receiving an annual blessing in the form of superior breeding stock. Why should not Vermont and New Hampshire organize a circuit association and become the great centers of Ayrshire cattle breeding? Why should not Maine and Rhode Island become the great centers for scientifically bred poultry? Massachusetts and Connecticut could easily take leading places in the breeding of dairy cattle for the production of city milk, as well as in the breeding of varieties of flint corn.

Experts in Tennessee are studying the feasibility of circuit breeding for the production of mules. Here the circuit must provide first

for the production of an improved strain of jack stock and an improved strain of horses, which when crossed will produce mules of a high average of excellence. Iowa and surrounding states have been suggested as the best places for circuits of purebred draft-horse breeds. Breeders near Duluth have expressed a preference for a circuit of Guernsey cattle and the breeders of Rice County, Minnesota, have laid a splendid foundation for a circuit of Holstein cattle, and Shelby County, Kentucky, needs but the skill of the organizer to establish a promising breeding circuit of Jerseys. Wyoming has many of the conditions for a successful circuit for creating the best type of short-grass-country sheep. Borden of Texas has successfully accomplished the initial work needed for the foundation of a circuit for forming a hybrid breed of cattle based on India or Brahma cattle and our common cattle. Even the breeders of silver foxes on Prince Edward Island might properly work under this plan.

Our state agricultural colleges are organizing divisions of genetics where they are producing men capable of serving as circuit superintendents, as members of governing boards, and as coöperating circuit breeders. Those who spent the time to devise the circuit scheme for creating new families, sub-breeds, breeds and even species have been in no haste and are in no haste now to push the matter forward. The American Breeders Association, which appointed the committee to formulate plans, at its recent meeting in Washington expressed its unanimous approval in the following resolutions:

RESOLVED: That the Animal Section of the American Breeders Association approves the so-called circuit coöperative system of breeding domestic animals, under which the federal and state government provide scientific guidance and assistance to coöperating groups of breeders in the production of superior sub-breeds and breeds of animals,

The time has evidently come when this subject should be discussed in more detail, and in reference to specific projects. The *American Breeders Magazine* would be pleased to receive brief statements suggesting specific plans for circuits for breeds of horses. General forms for writing out a circuit breeding project for any breed or any purpose have been prepared by members of the committee, and will be supplied upon application to the *Magazine* or to members of the Committee on Coöperative Animal Breeding.

EUGENICS CLUBS IN EDUCATIONAL INSTITUTIONS

On page 69 Prof. O. E. Baker, organizer of an Eugenics Club at the University of Wisconsin, gives a brief statement and report concerning that organization to which we desire to call special attention. It is clear that in the atmosphere of study and research of a college or university, conditions are favorable for the sane consideration of the subject of eugenics. The American Breeders' Association has done a public service of inestimable value, in that it has put the discussion of this subject, in its earlier stages, into the hands of scientists and students, to the end that this class of people may have a directing influence in the treatment of this delicate yet most important subject. No one can predict when or where the treatment of this subject may become a fad and the more earnest, scholarly, scientific people who have a sane and scientific knowledge of the subject take a part in it, the less harm will come of possible fadism.

The big part of this subject is dealt with in the last paragraph of Mr. Baker's statement. He says: "We must exalt motherhood and fatherhood and insist not only upon limiting the propagation of the undesirable classes but also upon encouraging the perpetuation of the most perfect. No social duty can exceed this." And a little farther on he says: "It is easier to reform the other fellow but I believe it would be better for the leaders of the eugenic movement to endeavor to establish a more sturdy social code among the higher classes, substituting for the criterion of conspicuous expenditure by which men and more particularly women are prone to judge each other, the more difficult accomplishment of rearing a healthy and happy family."

It is true that our educational system has an anti-eugenic affect. Our schools pay relatively more attention to training the tastes of the students for the enjoyment of rare and good things, than to training their ability to produce these good things. No doubt our educational system is somewhat unbalanced and should be so changed as to give more of vocational and technical education to people generally; especially to those people who have the best eugenic blood and who, on that account, should multiply more rapidly than the average.

Mr. Baker has clearly demonstrated that there are lines of serious investigation and discussion which college and university eugenics clubs could properly consider. It is a question whether there is any subject now before the American people which is at once of

prime importance, and requires more serious and unbiased consideration than that of the possible improvement of the heredity of future generations. The American Breeders Association is a scientific and coöperative organization. It can do no larger service than to assist in bringing to the American people a sane viewpoint concerning methods of improving the network of descent of the human family. This number of the *Magazine* will go to presidents of colleges and universities and to such deans and professors as should be especially interested in leadership in this work. The Association is anxious to be of assistance in elsewhere organizing clubs of this character.

PLANT-BREEDING AS A BUSINESS FOR FARMERS

To one familiar with the improvements that can be produced in plants and animals by breeding, it is difficult to realize why practical men are so slow to take up work in this field. This is particularly true of plant-breeding. With our domesticated animals breeding has come to be recognized as one of the primary elements of success and in almost all the counties of our principal states there are found special breeders of the different races of cattle, hogs, sheep and horses. In dairy sections, the importance of using good stock is well recognized and it is now common to find pure bred dairy herds, or at least herds of high grade animals that approach pure bred pedigree herds in effectiveness. For many years the production and sale of pure bred pedigreed stock has occupied the attention of many of our most intelligent and wide awake farmers and has proven in most cases an interesting and profitable business. Such live stock breeders in general, are stimulated by the nature of their work to more carefully study business methods and the principles of breeding, and almost invariably they are strengthened mentally and financially by their relation to this specialized industry.

It is true that animal breeding has by no means reached the high state of efficiency that we desire it to reach, but it has become a well recognized standard industry and is making rapid strides. Not all of the so-called breeders have developed the skill and judgment required for the most successful direction of breeding, and not all of them are as fully informed on the principles of breeding as we might wish, but the great majority are doing genuinely good work. We still find it necessary to import many pure bred animals but the time is rapidly approaching when this will no longer be necessary. Indeed, it is probable that we now have many breeders of the major-

ity of the important breeds, who can supply fully as good, if not better, animals than those ordinarily imported.

How different is the story of plant-breeding. The experiment stations and agricultural press have urged the importance of improved varieties until farmers have come to believe that there is something in plant-breeding, as well as in stock breeding, and experiment stations are being flooded with inquiries as to where improved pedigree seed of corn, wheat, oats, cotton, potatoes, and the like, can be purchased. At the present time, in most cases, these inquiries must be answered imperfectly. Usually experiment stations are compelled to confess that they know of no one having carefully bred seed for sale, or otherwise must refer inquirers to parties in distant states from which the importation of seed, no matter how highly bred, is an experiment. This is all wrong! Plant-breeding can be conducted with as great or even greater certainty of success than can animal breeding and is less expensive. There is just as great a necessity for having plant breeders as animal breeders, and it should be possible in every county in a state to purchase from local breeders, highly improved strains of the principal crops grown in the section.

Plant-breeding methods have now been developed that can be utilized by practical breeders in the improvement of almost any of our agricultural crops. These methods are easy to learn and simple of application. Hosts of young farmers are seeking new lines of work that give promise of advancement and remuneration, and in plant-breeding they can find a virgin field with unlimited possibilities for achievement.

Why should such a field be attractive to young men? In answer I would give three reasons.

(1) Because of the little capital necessary to start such work. In the beginning one would naturally start with but few crops, as possibly, corn and oats, or wheat and potatoes, and the general farming would go on as usual.

(2) Because of the profit to be derived from the sale of seed.

(3) Because by breeding and improving seed for the use of a community one is helping to improve and build up that community by bettering its agriculture.

The field is more than ordinarily attractive because while the individual is primarily working for the compensation derived from the sale of seed, if his work is honestly done, and he is earnest and faithful, his influence is certain to lead to the general use of better

seed in his community and therefore, to a very general improvement in conditions.

The importance of using highly bred seed can no longer be questioned. The improvement of the corn crop of Illinois, following the general introduction of methods of corn selection, has been very marked. It has been estimated that the crop of the state as a whole has been increased as a result by an average of about five bushels per acre, and in special instances, an average increase of nearly fifteen bushels per acre is claimed to have been obtained.

While working at the Minnesota Experiment Station, Professor W. M. Hays, now the assistant secretary of agriculture of our great national department, obtained increases with different highly selected strains of wheat, averaging from one to five bushels per acre.

Sea-Island cotton growers, by continuous selection over a period of fifty years, increased the length of fiber from an average of about $1\frac{1}{2}$ inches up to $2\frac{1}{4}$ and $2\frac{1}{2}$ inches in special strains, and these fine strains which sell at very high prices, are maintained by a continuous and rigid selection.

Sugar beets furnish an illustration of the value of selection that is familiar to many, the world over. Here an extensive industry has been built up that is dependent on the continuous use of seed from mother beets of high sugar content. The growing of sugar beet seed for the seed trade is conducted on a very extensive scale by certain German firms, hundreds of thousands of beets being tested annually as to form and richness in sugar content in order to secure good mother beets for seed production.

The writer's experiments in the breeding of timothy have led to the production of a number of new varieties, 17 of which in field trials in 1910, gave under identical conditions of cultivation and treatment, an increase in yield of 851 pounds per acre over test plats grown from the best timothy seed which could be purchased on the market. In 1911 these same plats gave an average increase in yield of 3,062 pounds per acre over ordinary timothy grown in comparison with them and four of the best varieties each gave an increase of over 4,000 pounds, or 2 tons, per acre over ordinary timothy. The very striking increases in yield given by these new sorts will be appreciated when it is remembered that the average yield in the section where these trials were made is only about 1.30 tons per acre and where 2 tons per acre is considered a good crop. An idea of the value of such new races to the country, if equally good sorts could be grown universally, can be gained from the following statement.

Hay is one of the largest agricultural crops of the United States, outranking all other crops, except corn, in total value of production. In 1910, according to the statements issued by the United States Department of Agriculture, there were grown in the United States 45,691,000 acres of hay which yielded a crop having a farm valuation of \$747,769,000. No statistics are available from which we can determine what proportion of this hay was timothy, but the writer believes that we may safely conclude that at least one-third of the entire hay crop of the country is timothy. If this is true, the timothy crop of the United States in 1910 had a valuation of over \$249,000,000. In the two years during which tests have been made, the 17 new sorts gave an average increased yield of slightly over $36\frac{2}{3}$ per cent above ordinary timothy. A $36\frac{2}{3}$ per cent increase in the valuation of the timothy crop as above estimated would give us over \$90,000,000 as the estimated annual gain in the value of the crop which would be obtained if equally good new sorts could be used throughout the country.

A method of breeding timothy has been introduced by the writer that is simple of application and is believed to be adapted to the use of farmers who desire to breed timothy and produce seed of improved races for sale. This method which will be described in detail in a bulletin of the Cornell University Agricultural Experiment Station soon to be published, is fully as simple and easy of application as the methods of corn breeding used by farmers in Illinois, Iowa and Ohio, and the writer believes is more certain to give marked increases in yield.

It may be considered doubtful whether it is wise to urge farmers to embark on new enterprises, but in urging them to breed improved varieties of timothy and grow the seed for sale, the writer thinks that he is on safe ground. A farmer near Ithaca, in the summer of 1911 had a crop of ordinary timothy that he estimated would yield about $1\frac{1}{2}$ tons per acre. He harvested the crop for seed, obtaining 7 bushels of seed per acre, which he sold in his local market at \$7.00 per bushel. The threshed timothy straw, of which there was a yield of about 1 ton per acre, when baled sold for \$14.00 per ton. This gave a gross income of \$63.00 per acre. The maximum wheat yields of the same area were less than 30 bushels per acre, which at a price of \$1.00 per bushel would give a gross income of only \$30.00 per acre. Timothy seed of improved new varieties may be expected to sell readily for many years to come at a rate of from \$10 to \$15

per bushel and a careful and successful breeder of this crop should be able to obtain an abundant reward for his study and labor.

The ease with which improvements can be made by careful breeding is also illustrated by results obtained by the writer in breeding corn for early maturity. In this experiment in the selection of corn to increase the earliness, conducted at Ballston Lake, N. Y., a test was made last year, after 4 years of selection, to determine what improvement had been effected. A careful grading of the ears at harvest time gave for the original seed with which the selection was started, a proportion of 87 per cent unripe to 13 per cent ripe and for the selected strain, 72 per cent ripe to 28 per cent unripe. This means a gain of nearly 2 weeks in earliness. The two strains were clearly distinguishable in the field. Another interesting feature exhibited was the fact that the selected strain had also increased in yield to the extent of nearly three bushels per acre so that considering its degree of maturity, it gave a heavier yield than the original strain.

These results were obtained by four years of selection by a method easy of application and inexpensive. While the breeding is in progress, a crop of corn is being produced that is just as valuable as any other corn and while not of sufficiently high grade to be sold as improved seed, can all be utilized except that portion reserved for planting, and no greater proportion of the crop will be utilized for seed purposes than would be used in planting the corn crop of the farm if no breeding work was being conducted. By the fourth year a certain part of the crop from selected seed can be sold for seed purposes and from that time forward a larger and larger amount of more and more highly bred seed can be offered for sale.

No special field of agriculture offers greater opportunities for advancement and profit than does plant-breeding. The country is coming to demand seed of known quality and high efficiency. This demand will surely and steadily increase so that no risk is involved in taking up the business except in the ability and adaptability of the individual. Intelligence, honesty and perseverance, are the three qualities most necessary. No man possessing these qualities or characteristics should fail to achieve success.—HERBERT J. WEBBER.

NEWS AND NOTES

THE EUGENICS CLUB AT THE UNIVERSITY OF WISCONSIN

Having been interested in plant breeding for several years, the writer last October suggested to other members of Professor Ross' seminar in sociology that the formation of a small study group would afford us more information about the eugenics movement. The idea was immediately approved, but it was soon learned that the various courses and seminars in biology, experimental breeding, and sociology were offering such work. Moreover, most of us were pressed for time, and hence wished our information condensed and from authorities, if possible. So it was decided to organize a more popular Eugenics Club, secure speakers, and meet twice monthly. Immediately several young ladies applied for membership, involving a second problem, which was decided in the affirmative. And may I add that the women have proven a source of strength to the club, and that at no time has there occurred any occasion for embarrassment.

Organization:—There are a president, vice-president, and secretary-treasurer, and five committees, whose chairmen, with the officers, constitute an executive committee:

The Extension Committee, whose work at present is three fold:

- (1) The investigation and tabulation of all laws, such as those of Indiana, Connecticut, Switzerland, relative to marriage of defectives, sterilization and other means of eugenic control.
- (2) The preparation of a study bulletin for distribution through the Extension Department of the University.
- (3) The recommendation of lecturers to the Extension Department.
The first piece of work is approaching completion, the second has been begun, and the third is under consideration.

The Research Committee, whose work is also three fold:

- (1) The gathering of genealogies of interesting cases.
- (2) The investigation of certain subjects allied to eugenics, several of the members securing credit for the work performed from the University departments concerned, while others are taking eugenic subjects for their seminary or thesis topics. Several members of the Extension Committee are also securing University credits for their work.
- (3) The supplying of information to the Extension Committee.

The Literature Committee, whose work is two fold:

- (1) The reading and tabulation of all available literature upon the subject.
- (2) The supplying of information, list of readings, etc., to the Extension Committee and to the Club.

The Membership Committee, whose work is two fold:

- (1) The solicitation of desirable members.

(2) Passing upon applicants for membership.

The Chairman of this committee is a woman.

The Program Committee, which,—

(1) Secures speakers, advertises the meeting, and inserts press notices.

Membership:—The membership at present is about 75, and the attendance averages one hundred. Probably one-half are graduate students, mostly from the College of Letters and Science and from the Agricultural College. An effort will soon be made to interest the medical and law students. About one-quarter are undergraduates from the same colleges, and the remaining fourth physicians (mostly women), a lawyer, and other mature people from the city, and several professors. Each of the three committees first mentioned, by the way, has three professors serving as consulting members.

Programs:—Four meetings have been held, three addressed by University professors, and one by a city physician. The next session will be devoted to a report of the Extension Committee, giving the results of its investigations; and now that the club has gotten into running order it is anticipated that fully half of the sessions will be conducted by the student members alone. Since willingness to work is as excellent a criterion of sincere interest in a subject in a university as an appropriation bill is in a legislature, it would appear that the eugenic movement has secured a substantial hold upon the affections of the members of the club.

Both Mr. Kelly, of the Research Committee, and myself have called the attention of the Club to the American Breeders Association, and I suppose that ere this Professor Cole has sent you some new names.

Now may I be pardoned in offering some observations, and asking opinions on some hasty suggestions upon a certain aspect of Eugenic reform. Probably our modern system of education, particularly of higher education, is one of the most potent anti-eugenic forces operating today. I believe that an investigation in England has shown that whereas defectives and criminals average over six children per family, the normal family ranges from four to five children, while the "intellectuals" are credited with less than four. Our own American college graduates appear in an equally undesirable light, Harvard and Yale men averaging much less than two children apiece. In other words, that portion of our population which is intellectually superior is not self-maintaining; but, as Professor Holmes remarked at a recent meeting of the Club, we are killing the goose that lays the golden eggs. Which he suggested might explain the prevalent opinion among instructors of increasing mediocrity of college students.

A few hours consideration of this problem has suggested to me several means of relief: First, I am inclined to credit the Carnegie Pension Fund, in addition to other excellent results, as being one

of the most effective eugenic measures ever accomplished. This suggests the ultimate desirability of the establishment of fellowships for married students. There appear to be three ways of encouraging fecundity among educated people:

(1) By shortening the period of preparation; and since the fetish of mental discipline is no longer being worshipped, and professional courses are being driven down into the freshmen and sophomore years, this would appear in process of accomplishment.

(2) By economic encouragement permitting marriage before the completion of professional preparation, as suggested above.

(3) By substituting a different social standard for that dilettante etiquette which today frowns upon family life. We must exalt motherhood and fatherhood, and insist not only upon limiting the propagation of the undesirable classes, but also upon encouraging the perpetuation of the most perfect. No social duty can exceed this. In the Eugenics Club reference has several times been made to the enactment of legal restrictions upon unfit marriages, which is well—it is easier to reform the other fellow; but I believe it would be better for the leaders of the eugenic movement to endeavor to establish a more sturdy social code among the higher classes; substituting for the criterion of conspicuous expenditures, by which men, and more particularly women, are prone to judge each other today, the higher and more difficult accomplishment of rearing a healthy and happy family.—OLIVER E. BAKER, *Madison, Wisconsin*.

ILLUSTRATION OF MENDELIAN SEGREGATION

On page 210 of the *American Breeders Magazine*, vol. ii, no. 3, Prof. Arthur W. Gilbert in his interesting article on "Suggestive Laboratory Exercises for a Course in Plant Breeding," gives in Exercise 18 an illustration of the application of the law of chance. Under "(a)" materials and methods are suggested to illustrate the union of gametes where two pairs of characters are concerned. While this illustration gives very well the theoretical ratio, an optical representation of Mendelian segregation would be greatly appreciated by those students who find it difficult to get a clear conception of abstract relations. For this purpose and to simplify matters it would seem better to let a single kernel of corn (or other object) represent a single character rather than two, i. e., yellow color and flintiness, in the above example. Starting with two individuals each having two characters which are to be combined in the cross, the resultant

hybrid will have in its make-up these four characters (partly dominant and partly recessive). In the F_2 generation these characters will be recombined into nine different types.

To illustrate this process the following method is suggested. To make it as clear as possible an actual case of Mendelian segregation has been taken, that of the origination of the "Waved King Edward" sweet pea, by the simple crossing of the plain red "King Edward" with the waved pink "Countess Spencer."^a

Provide four kinds of beans of as near the same size as possible in equal numbers: let the black beans, *B*, represent the dominant *plain* character of the sweet peas mentioned above, the gray beans, *G*, the recessive *wavy* character, the white beans, *W*, the recessive *pink* character, and the spotted beans, *S*, the dominant *red* character. Suppose the allelomorphic composition of the first parent is *BBSS*, the gametes of this parent will be *BS*. The composition of the second parent may be represented by *GGWW* with gametes *GW*. The cross between them is *BGSW*. This hybrid produces four types of gametes, viz: *BS*, *BW*, *GS*, *GW*. The union of these four types of gametes gives:

(1) 1 <i>BBSS</i>	(4) 2 <i>BGSS</i>	(7) 1 <i>GGSS</i>
(2) 2 <i>BBSW</i>	(5) 4 <i>BGSW</i>	(8) 2 <i>GGSW</i>
(3) 1 <i>BBWW</i>	(6) 2 <i>BGWW</i>	(9) 1 <i>GGWW</i>

Provide two vessels, in one of which place all the black, *B*, and gray, *G*, beans (the choice being between a plain and a wavy character); in the other, place all the white, *W*, and spotted, *S*, beans (the choice being between pink and red characters).

Draw at random two at a time from each vessel and combine them into groups of four which will represent individual sweet pea plants in the F_2 generation. It will be seen that the nine types above will be produced in a ratio as near the theoretical as is obtained in actual plant breeding practice. The larger the number of beans the nearer, of course, will the result correspond with the theoretical.

In ten trials using 100 beans of each kind the following result was obtained:

^a Mendel's Law of Heredity and its Application to Horticulture, C. C. Hurst, F. L. S., pp. 22-23. *Journal of the Royal Horticultural Society*, vol. 36, part I.

Trials.	Types.								
	(1) <i>BBSS</i>	(2) <i>BBSW</i>	(3) <i>BBWW</i>	(4) <i>BGSS</i>	(5) <i>BGSW</i>	(6) <i>BGWW</i>	(7) <i>GGSS</i>	(8) <i>GGSW</i>	(9) <i>GGWW</i>
1	3	14	5	19	22	15	7	6	9
2	3	14	7	13	26	13	10	8	6
3	6	14	3	9	29	16	7	13	3
4	6	15	4	10	26	14	7	12	6
5	7	13	6	13	20	15	5	16	5
6	7	10	10	11	21	14	9	14	4
7	9	14	2	11	25	14	3	14	8
8	5	17	8	13	17	10	8	13	9
9	4	21	4	13	16	13	7	14	8
10	3	12	7	18	27	12	5	11	5
Totals.....	53	144	56	130	229	136	68	121	63
Ratio, actual.....	1	2.7	1.05	2.4	4.3	2.5	1.2	2.2	1.1
Ratio, theoretical.....	1	2	1	2	4	2	1	2	1

It will be seen that the actual ratio corresponds more or less closely to the theoretical ratio of the nine types obtained where two contrasting pairs of characters are used.

To apply the results to the sweet pea cross we have the following:

- Type (1) *BBSS*, plain red sweet peas, pure (first parent).
 (2) *BBSW*, plain red sweet peas, with recessive pink characters.
 (3) *BBWW*, plain pink sweet peas, pure.
 (4) *BGSS*, plain red sweet peas, with recessive wavy characters.
 (5) *BGSW*, plain red sweet peas, with recessive wavy and pink characters.
 (6) *BGWW*, plain pink sweet peas, with recessive wavy characters.
 (7) *GGSS*, wavy red sweet peas, pure ("Waved King Edward").
 (8) *GGSW*, wavy red sweet peas, with recessive pink characters.
 (9) *GGWW*, wavy pink sweet peas, pure (second parent).

Of these nine types, 1, 3, 7, and 9 are pure types and come true as determined in the F_3 generation. The remaining five types break up in various ways, each of them producing more or less of one of the fixed types above.

Because of the dominancy of the red and plain characters we should expect in the F_2 generation to get plain red sweet peas (some pure, others not), wavy reds (some pure, others not), plain pinks (some pure, others not) and wavy pinks (pure). Collecting these four kinds from the table above we have:

Plain reds.		Wavy reds.		Plain pinks.		Wavy pinks.	
Types.	Totals.	Types.	Totals.	Types.	Totals.	Types.	Totals.
(1)	53	(7)	68	(3)	56	(9)	63
(2)	144	(8)	121	(6)	136		
(4)	130						
(5)	229						
Totals	556		189		192		63
Ratio, actual.....	8.8		3		3		1
Ratio, theoretical.....	9		3		3		1

To determine which of these are pure types it is necessary to raise the third generation self-pollinated. Those which come true from seed are pure types.

For laboratory practice it would be desirable to have disks with the names of the contrasted characters printed upon them and designated as to dominancy or recessiveness.—W. R. BALLARD, *Maryland Agricultural Experiment Station*.

REPORT OF THE MEETING OF THE EUGENICS SECTION

A meeting of the Eugenics Section of the American Breeders' Association was held at Washington, December 29 and 30, 1911, with the attendance of about fifty members at all sectional meetings.

At the general session, December 29, Dr. E. E. Southard, director of the Neuropathic Institute, gave a paper "Geographical Relations of Nervous Diseases in Massachusetts." At the general evening session of December 29, Hon. W. M. Hays, Assistant Secretary of Agriculture, gave a paper entitled, "Constructive Eugenics." At the general session in the afternoon of December 30, Dr. H. H. Goddard read a paper, "Heredity of Feeble Mindedness, a Social Danger."

The special session on the afternoon of December 29 was held at the Volta Bureau founded by Dr. Alexander Graham Bell. After an address of welcome by the superintendent of the Volta Bureau, Mr. Taylor, and response by the secretary of the Section Dr. E. E. Southard was elected chairman for the meeting. Dr. Bell gave an opening address concerning the foundation and work of the Volta Bureau. Mr. H. H. Laughlin, superintendent of the Eugenics Record Office reported on the work of the office for the past year. Prof. Robert DeC. Ward of Harvard University read a paper, "Our Immigration Laws from the View Point of Eugenics." Dr. A. H. Estabrook of the Eugenics Record Office presented a paper on inheritance

of shyness and of eroticism, based on some field studies. A party was personally conducted by Dr. Bell to inspect the vault and filing system of the Bureau.

A second special session of the Eugenics Section was held December 30 at 9:30 in the Government Hospital for the Insane. Dr. Henry A. Cotton, medical director of Trenton State Hospital was elected chairman pro tempore. Dr. William A. White, superintendent of the Government Hospital discussed the methods and results of the field work and spoke critically of the difficulties of diagnosis. He laid stress upon the importance of the charts in exhibiting the results in popular form. Dr. Frederick A. Rhodes of Pittsburgh gave a paper entitled, "Eugenics from the Standpoint of the Physician." Dr. Henry A. Cotton showed charts illustrating inheritance of insanity and a paper by Dr. F. A. Woods, entitled "Alternative Human Inheritance in Eugenics." On motion of Mr. W. M. Hays the following resolutions were adopted:

RESOLVED: That the Eugenics Section organize a permanent committee on immigration, with authority to cooperate with similar committees of other organizations in securing laws which will be more effective in securing immigrants which bring good health and only normal and superior heredity to this country.

RESOLVED: That the Eugenics Section request the Association to appoint a committee to report on the possibilities of securing data and useful eugenics legislation through the United States Census Bureau, the Bureau of Health and other societies and institutions.

After luncheon provided by Dr. White an opportunity was given for visiting the hospital. The following officials were elected at the sectional meeting of December 30, Dr. E. E. Southard, chairman; Dr. H. H. Goddard, Vineland, N. J., vice-chairman; Dr. C. B. Davenport, secretary.—DR. C. B. DAVENPORT, *Secretary Eugenics Section, A. B. A.*

INTERNATIONAL EUGENICS CONGRESS

The first international Eugenics Congress has been called to meet in London, on July 24 to 31, 1912 at the instance of the London Society of Eugenics. Dr. David Starr Jordan in a note to the editor states that: "The purpose of this Congress is to try to bring together as many people interested in the subject as possible and to have a series of papers and discussions, primarily those of popular interest; it not being intended to make the Congress a vehicle for exclusively technical papers."

The circular announces that the work of the Congress will be grouped in four sections:

- (1) The bearing upon eugenics of biological research.
- (2) The bearing upon eugenics of sociological and historical research.
- (3) The bearing upon eugenics of legislation and social customs.
- (4) Consideration of the practical application of eugenic principles.

The following persons are the vice-presidents from the United States: Alexander Graham Bell, Dr. C. B. Davenport, Charles W. Eliot, Dr. David Starr Jordan, Gifford Pinchot, Dr. E. E. Southard and Bleecher von Wagenen.

Dr. Jordan and Prof. Vernon Kellogg will both attend the Congress.

The American Breeders Association which holds a membership in the Congress will be duly represented.

Those who are interested in the proceedings of this Congress may obtain further information by addressing The Honorary Secretary, Eugenics Education Society, 6 York Building, Adelphi, London. Membership is one pound (\$5).

The president of this international body is Major Leonard Darwin; P. von Fleischl, Honorary Treasurer; Mrs. Gotto, Honorary Secretary.

PUBLICATIONS RECEIVED

THE INHERITANCE OF COLOR IN SHORT HORN CATTLE. H. H. Laughlin, Carnegie Station for Experimental Evolution, Cold Spring Harbor, New York. Reprinted from the *American Naturalist*, Vol. XLV, Dec., 1911. pp. 705-742; and Vol. XLVI, Jan., 1912, pp. 6-28, 9 figs.

THE MATING OF THE UNFIT: A STUDY IN EUGENICS. W. J. Conklin, A.M., M.D., Dayton, Ohio. Pp. 22, 4 figs.

THE PRODUCTION OF THE LIMA BEAN: THE NEED AND POSSIBILITY OF ITS IMPROVEMENT. G. W. Shaw and M. E. Sherwin. Bulletin No. 224, Agricultural College Experiment Station, Berkeley, California, 1911. Pp. 199-246. Illustrated.

TWENTY-SEVENTH ANNUAL REPORT OF THE BUREAU OF ANIMAL INDUSTRY DEPARTMENT OF AGRICULTURE, FOR THE YEAR 1910. 573 pp., pls. XLII, 75 text figs.

Three articles in this publication deserve to be especially named to members of the American Breeders Association, who are interested in animal breeding.

THE ARMY REMOUNT PROBLEM. Dr. George M. Rommel, Chief Division of Animal Husbandry. 85 pp. Illustrated.

THE PRINCIPLES OF BREEDING AND THE ORIGIN OF DOMESTICATED BREEDS OF ANIMALS. Dr. J. Crossar Ewart. 53 pp. Illustrated.

- THE ANCESTRY OF DOMESTICATED CATTLE. Dr. E. W. Morse. 53 pp. Illustrated.
- AN IMPROVED METHOD OF ARTIFICIAL POLLINATION IN CORN. G. N. Collins and I. H. Kempton. Circular No. 89, Bureau of Plant Industry, U. S. Department of Agriculture. 7 pp., 2 figs.
- BREEDING POULTRY FOR EGG PRODUCTION. Raymond Pearl. Bulletin No. 192, Maine Agricultural Experiment Station. Pp. 113-176.
- A COMPARATIVE MICROSCOPIC STUDY OF THE MELANIN CONTENT OF PIGMENTATION OF SKINS WITH SPECIAL REFERENCE TO THE QUESTION OF COLOR INHERITANCE AMONG MULATTOS. Prof. H. E. Jordan, University of Virginia. Pp. 449-470, 3 fig. Reprinted from the American Naturalist, Vol. XLV, Aug., 1911.
- EXPERIMENTAL STUDIES IN INDIAN COTTONS. H. Martin Leake, M.A. Pp. 447-451. Reprint from Proceedings of the Royal Society.
- STUDIES IN INDIAN COTTON. H. Martin Leake, M.A. Figs. 4, pls. II. Reprint from Journal of Genetics, Vol. L, No 3.
- THE GENOTYPES OF MAIZE. Dr. George Harrison Shull. Cold Spring Harbor, N. Y. Pp. 234-252. Illustrated. Reprinted from American Naturalist, 1911.
- REVERSIBLE MUTANTS IN *LYCHNIS DIOICA*. Dr. George Harrison Shull. Pp. 329-368, 15 illustrations. Reprinted from the Botanical Gazette, Nov., 1911.
- DEFECTIVE INHERITANCE. Ratios in Bursa Hybrids. Dr. George Harrison Shull. Pp. 12, pls. VI. Reprinted from Vol. XLIX of Transactions Des Naturforschender Vereins in Brunn.
- METHODS IN BREEDING CEREALS FOR RUST RESISTANCE. Edw. C. Johnson, U. S. Department of Agriculture. Pp. 76-80. Reprint from Proceedings of American Society of Agronomy. Vol 2, 1910.
- CROSS BREEDING CORN. C. P. Hartley, Earnest B. Brown, C. H. Kyle and L. L. Zook, Office of Corn Investigation, B. P. I., U. S. Department of Agriculture, Bulletin No. 218. Pp. 72.

NEW BOOKS

- HEREDITY IN RELATION TO EVOLUTION AND ANIMAL BREEDING. William E. Castle, Professor of Zoölogy, Harvard University. 184 pp., 53 illustrations. Appleton and Company, New York and London, 1911.

Few subjects are commanding such universal and popular attention as the rising science of genetics. The literature of the subject is rapidly growing voluminous. The task of putting this varied and interesting material into pedagogical form is fortunately being assumed by writers who possess the gift of presenting the subject clearly and interestingly. Heretofore we have known breeding only as an art.

Our most successful breeders of whatsoever kind of plants or animals were at best only artists—highly skilled ones, it is true. Their greatest successes were often surprises to themselves, and frequently the fondest expectations turned into severe disappointments. Through the discoveries of Mendel we have gained an entirely new viewpoint. Facts and groups of facts, formerly detached and unassimilable, have suddenly sprung into importance and have assumed a meaning.

Dr. Castle's book *Heredity* was suggested by a course of lectures delivered at different times before students at educational institutions. These lectures are now rearranged in book form and presented to the general reader, and the rapidly growing interest in genetics should accord this book a useful place. Because the use of scientific terms is confined only to the most necessary ones, the general reader will find it at once intelligible and interesting. Whatever uncommon words are used are defined and explained and even the reader not fully familiar with scientific terms should find no difficulty in comprehending the text fully.

The lack of fundamental breeding knowledge with which breeders, for instance of poultry, will invest their money and enter upon the business of "breeding" of fancy fowls has always been a matter of wonderment to us. The same applies to breeders of other forms of live stock. Unwittingly they are mere multipliers of stock but not breeders in the true sense. A book like *Heredity*, here before us, placed in the hands of hundreds of these mechanical breeders would illuminate their work greatly and actually open their eyes to a revelation.

The book is written along Mendelian lines, and should be of assistance to the breeder who combines the artistic with the technical.

The subject is covered in ten chapters. The titles of several may be mentioned to give an idea of their contents: The Individuality of Inheritance; Germ Plasm and Body; Mendel's Law of Heredity; Determination of Dominance; Evolution of New Races by Loss or Gain of Characters; Evolution of Races by Variation; Effect of Inbreeding and Heredity and Sex.

BREEDING FARM ANIMALS. F. R. Marshall, Professor of Animal Husbandry, Ohio State University. 287 pp. The Breeders Gazette, publishers, Chicago, Ill., 1911.

The man who was the first in this country to place animal husbandry and the understanding of the animal form upon a pedagogical basis has had his name fitly commemorated on the dedicatory

page of this book on breeding farm animals, namely, the late Prof. John Craig, and well has he deserved this tribute.

Breeding Farm Animals is a common-sense, sane, practical, and readable book, because the author has succeeded in presenting his subject in plain, every-day language. The book seems to have been written with a view of bringing to the stock breeder and the home student who wishes to extend the knowledge gained in the short-course work in agriculture, the latest and best information on the subject of heredity as applied to farm animals. It would also be useful as a text and reference book in agricultural high schools.

The matter of illustrations has received much care; the well-chosen character types of the various breeds of live stock awaken in the reader and lover of stock the enthusiasm and admiration for the artistic side of stock breeding. The author does not indulge in scientific speculation or the recital of the vagaries of heredity; thus atavism, which before our clear understanding of the physical basis of inheritance, received the bulk of attention in the earlier works on breeding, here is relegated to very minor mention.

There is emphasized throughout the book the relation of the breeder to the live-stock industry, management of breeding stock, the functions of markets, of breeders' associations, of live stock registry and advanced registry. Eleven pages devoted to determination of sex in the offspring sum up the present status of knowledge on that subject and should serve to clarify the conceptions current among those who have little or no fundamental knowledge of the cell processes of fertilization. The author remarks: "That sex of farm animals should generally be under the control of man seems hardly desirable."

A book of such varied contents should be indexed; the absence of this almost indispensable reference-aid is regrettable.

ASSOCIATION MATTERS

MEMBERSHIP FEES ARE DUE

Please send in your 1912 membership dues promptly upon receipt of due bill and try by all means to send dues of a new member in addition.

PLACE OF THE NEXT MEETING, 1913

The National Corn Exposition has invited the American Breeders Association to hold its ninth annual meeting at Columbia, South Carolina, February 8-9 1912, setting the date of the meeting so that it will be held on the two days immediately preceding the opening of the Exposition. In this way conflict of interest will be avoided, and members by staying over may visit the Corn Exposition, which promises to be not only on a larger scale than any previous one, but to include more educational features and a wider scope generally. No definite announcement will be made until the Council shall have decided this matter by vote.

The Corn Exposition authorities with their usual generosity have offered to the American Breeders' Association facilities for holding meetings and the use of rooms for lectures, and the commercial bodies of Columbia and Charleston have expressed the desire to entertain the members of the Association. An attractive program for the entertainment of members has been tentatively worked out and includes among other things a visit to the tea farm at Summersville South Carolina, the only tea farm in the United States, an auto trip from Summersville to Charleston.

WORTH OF THE WORK OF THE AMERICAN BREEDERS ASSOCIATION

I wish to congratulate you upon the wonderful progress you have made with your society and its publications. I am proud of it; I am proud of having a little connection with the organization.—WILLIAM GEORGE, *Aurora, Ill.*

I wish to express my appreciation of the excellent form in which our Magazine has been written, edited and published during the past year.—JOSEPH S. MONTGOMERY, *St. Paul, Minn.*

I congratulate you upon the fine appearance of the last number of the Magazine. I am pleased to note that you have included eugenics in the sub-title. I suppose it is more than a branch of genetics on account of its social bearings.—CHAS. B. DAVENPORT, *Cold Spring Harbor, N. Y.*

THE AMERICAN BREEDERS MAGAZINE

"One of the most precious things in the world is the labor of human beings; and I find myself asking over and over: 'What a vast difference in the reward of labor does it make what kind of seeds are planted on the millions of cultivated acres?' I have not yet answered my own question, but ask you to remember that the problem raised is also yours."—A. M. FERGUSON.

Vol. III

Second Quarter, 1912

No. 2

A. E. BLOUNT, 1831-1911

W. H. OLIN

Boise, Idaho

Since the 1911 meeting of the American Breeders Association at Columbus, Ohio, one of the pioneer plant breeders of America has "passed over the range"—Prof. A. E. Blount.

Ainsworth Emery Blount was born at Brainard, East Tennessee—a mission station—February 6, 1831. He passed his early boyhood in that region, leading a simple form of life in the midst of the Cherokee Indians. His children later in life delighted to hear their father talk and sing in the Cherokee language, which he learned from his boyhood playmates.

On his father's side Professor Blount was descended from Puritan stock, while his mother, born Harriet Ellsworth, was granddaughter of Oliver Ellsworth, first Chief Justice of the United States, and member of that memorable convention which drafted the Federal Constitution in 1787. Professor Blount graduated from Dartmouth College in 1859, and at the time of the Civil War he was principal of the Masonic Female Institute, Cleveland, Tenn. He resigned his position at the opening of the war; entering the first East Tennessee Cavalry as a private, he came out of the war with the rank of captain in above named regiment. In 1865 he married the daughter of Dr. J. F. Hall of Portsmouth, N. H.

After the Civil War, Professor Blount began elaborate investigations in the principles of heredity and the breeding of cereals. He was the first plant breeder in the cereals—corn and wheat—as well as one of the first workers with and propagators of alfalfa in America. The writer believes Professor Blount to have been the first plant breeder in America to use as the fundamental principle which governed all his breeding work with the cereals: "Select the *best* to cross on the *best* to make a *better offspring*." It is the use of this rule which has en-

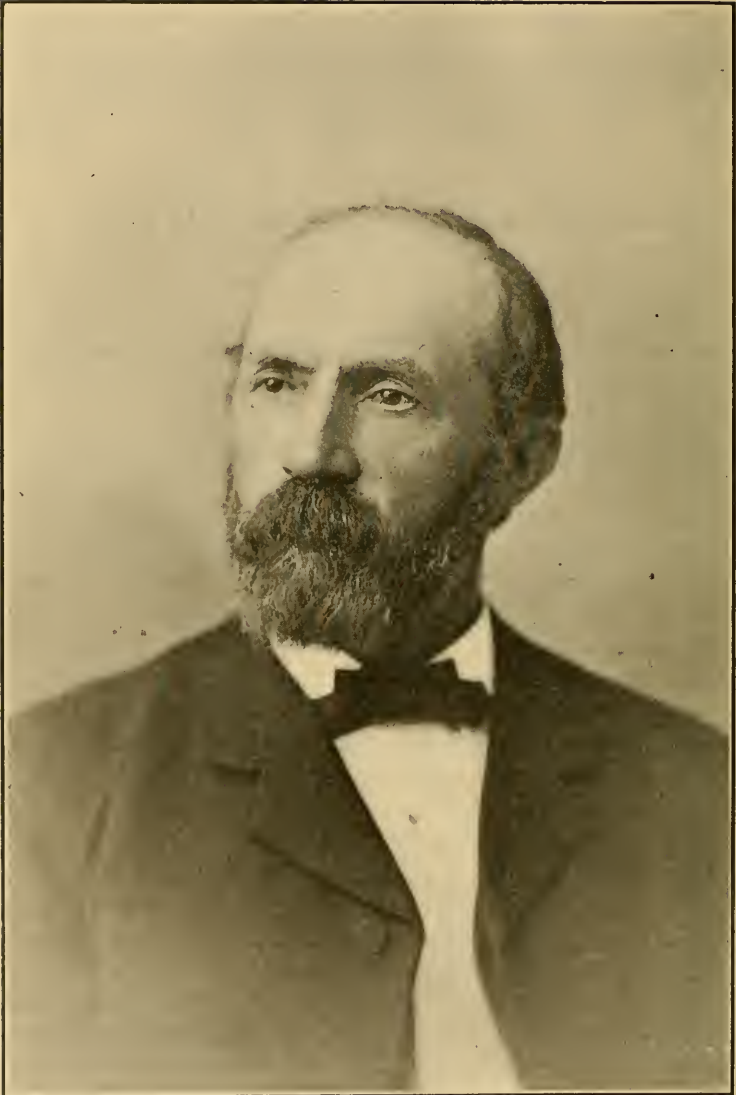

A. E. BLOUNT

abled Luther Burbank and others to produce such desirable and valuable results in nuts, fruits, flowers, and grains.

In his corn work Professor Blount began with an eight-rowed white dent corn and, after ten years' work in crossing and selection, he had created a new variety, Blount's Prolific. Of this, he says: "I had the satisfaction of putting into the hands of real live farmers a variety that excelled anything in the shape of maize that, up to that time, had been grown in America, as the *Rural New Yorker* of 1879 fully illustrates. It is still for sale all over the country by no less than a dozen seed houses, but, sad to say, it is so deteriorated that its prolific feature is hardly left. Corn mixes so readily it is impossible, even isolated miles away from all other kinds, to keep pure and genuine seed without a yearly protection."

Professor Blount was the first one to introduce durum wheats in the United States. It was while Professor Blount was at the Colorado State Agricultural College as Agriculturist that probably his greatest work was done in seed breeding.

Speaking of this work in correspondence with the writer he says: "While there [in Colorado], in 12 of the best years of my life, I made many crosses between the best varieties, only 43 of which were worth propagating. I then called them hybrids, but on further investigation declared them only 'crosses,' not hybrids. It was in 1879 that I received a very small sample of the then smooth Defiance Wheat and his Champion Bearded No. 9 from E. C. Pringle (Vt.), who claimed to have 'originated' them—how he never told me, though I sought to know his method. From this seed I gained quite a large number of average heads, the largest, if I remember rightly, not quite 3 inches long, with only about 21 kernels in the glumes, including the white cap. The next year I selected the 'best and crossed the best on the best to get a better offspring'—the rule I worked on in all my experiments. In 1885 you will see how much it was improved by 'selecting the best to cross on the best to get a better offspring.' See No. 8, page 44, Secretary's Report for 1886.

Professor Blount told the writer in a letter that one single grain of Defiance in his nursery, under irrigation, produced 106 good heads containing an average of 43 kernels each, heads fully 5 to 6 inches long from base to tip of white-cap.

The president of the college was a man of classical training who did not appreciate the work being done by Professor Blount, and the director of the experiment station—a graduate of the Agricultural College of Michigan—refused to recognize the worth and value of this vet-

eran plant breeder's most excellent work and so the world at large learned little of what was being done. It is to be regretted that much of the best work in plant breeding done by Professor Blount at the Colorado Station was lost after he was driven from the station by college politics. He had in his nursery over 400 named varieties of wheat, most of which he knew at a glance without consulting the labels. He was in correspondence with 40 of the best plant breeders of his day, in Australia, Asia, England, Continental Europe, North and South America. From 1890 to 1898 Professor Blount did active and valuable work in the new agricultural station of New Mexico. Failing health caused him to retire from active service. He spent his last years in his truly delightful home among family and friends at Wellesley, Mass. Even here, he was consulted by plant specialists for advice, for his experience, perseverance, and capacity for accurate and delicate work had made him an authority on plant breeding. As long as he lived he was constantly in receipt of letters from all the wheat-growing states and foreign countries growing this cereal.

His death, February 21, 1911, was caused by an attack of pneumonia. Defiance Wheat is his gift to the Irrigated West, demonstrated by miller and farmer to be the best milling spring wheat grown on the irrigated lands of America. He was a most modest man, an untiring investigator, a great lover of nature and of little children, as well as of plants and flowers. He attained success. A speed-mad and money-mad commercialized world would perhaps not consider it such. The writer inclines to proclaim as a successful man, one who has added one flower, one food grain, fruit or economic plant, useful to man or beast; who has not lost the love of little children; who has learned the love of Nature, and though he may not have amassed wealth, has made the world better for his having lived in it, living a life that speaks for purity, truth and love. Such success Blount had achieved.

THE CORNELL EXPERIMENTS IN BREEDING TIMOTHY^a

HERBERT J. WEBBER

Ithaca, New York

Introduction.—Almost all of our cultivated plants and animals are represented by numerous varieties and breeds. We do not cultivate merely wheat, corn, or apples, but we grow Dawson's Golden Chaff wheat, Leaming corn, or Baldwin apples. We have hundreds of races of corn and wheat and over a thousand varieties of apples. In cotton, oats, barley, peaches, plums, pears, strawberries, and, indeed, in almost all plants that man has domesticated, we find numerous varieties. Not so, however, in timothy, our greatest of all hay plants. Timothy is only timothy. When we buy timothy seed we do not ask for Excelsior timothy or Jones' timothy; we simply order timothy seed, and take seed from Illinois, Michigan, Iowa, or any other place if it is called timothy. Sometimes we ask for a guarantee that the seed is good, but by this we mean only that it will germinate. We do not concern ourselves with the all-important question of how much hay per acre it will produce. When we remember that the hay crop ranks among the three largest crops in value produced in the United States, and that timothy forms the bulk of this crop, it is difficult to conceive that this can be true, but such is the deplorable fact.

So far as the writer is informed only one series of experiments in the breeding of timothy has been carried to a successful conclusion. Between 1895 and 1899, Dr. A. D. Hopkins, then of the West Virginia Experiment Station, made selections of good timothy plants observed in nature and found that they could be bred into distinct varieties.^b These varieties were later placed with the U. S. Department of Agriculture for trial, but have not been introduced into general cultivation.

It is clear that the most important problem before hay growers today is to secure improved varieties which are known to be adapted to certain local conditions and fitted to give the best hay under these conditions. Not until good varieties adapted to various regions have been secured can we expect any very general improvement and increase in the hay crop of the country.

The Cornell Experiments.—The Cornell experiments in breeding timothy were started in 1903 under the direction of Prof. T. F. Hunt,

^a Paper No. 25, Department of Plant-Breeding, Cornell University, Ithaca, New York.

^b Hopkins, A. D., Proc. Soc. Pro. Agr. Science, 1895, pp. 29-33.

assisted by Professor Gilmore and Mr. Fraser. The writer was placed in charge of the experiments in the spring of 1907, and from that time until 1910 he was assisted in the work by Dr. C. F. Clark.

In order to secure various forms, seed was obtained from 231 different places throughout the world, 21 states, Canada, Japan, and 9 European countries being represented. These seeds were germinated in sterilized soil and the little plants grown for a time in the greenhouse. They were later transplanted into field plats, 42 plants being grown from each lot of seed. In the field the plants were placed in rows 30 inches apart each way in order to facilitate the cultivation and allow the full development of each individual. Grown under such conditions the plants gradually increase in size by stooling and the most vigorous individuals in two or three years reach a diameter of from 1 to $1\frac{1}{2}$ feet. Little can be told regarding their characters until the second year, when they begin to show clearly their mature character. No final conclusions can be drawn regarding the comparative value of the individuals until they have been under observation for four or five years.

In 1905 certain distinct plants were selected from among this lot, and open-fertilized seed retained, which was used in planting individual test rows, the plants being handled and planted separately as in the preceding case.

The original planting of 1903 included about 20,000 different individual plants, while that of 1905 included 6304 plants. A good stand was obtained at first, but a considerable number of plants died later from various causes. When the writer took charge of the experiments in 1907 there were probably about 20,000 different plants still living, and in most cases they were in excellent condition. At that time all of the plants had reached sufficient age to permit their mature characters to show plainly and thus were in prime condition for studying the variations and for choosing plants of different types.

Variations in Timothy.—The variations in different plants of timothy cannot be observed plainly when the plants are grown under field conditions. It is necessary to have the individual plants grown alone with considerable space around them in order to study the variations. No one who has not studied such a field of timothy plants can comprehend the richness of forms presented. It is beyond the scope of such a paper as this to discuss all of the forms presented, but the following illustrations will give some idea of the variation in those characters that are of most importance from a practical standpoint.

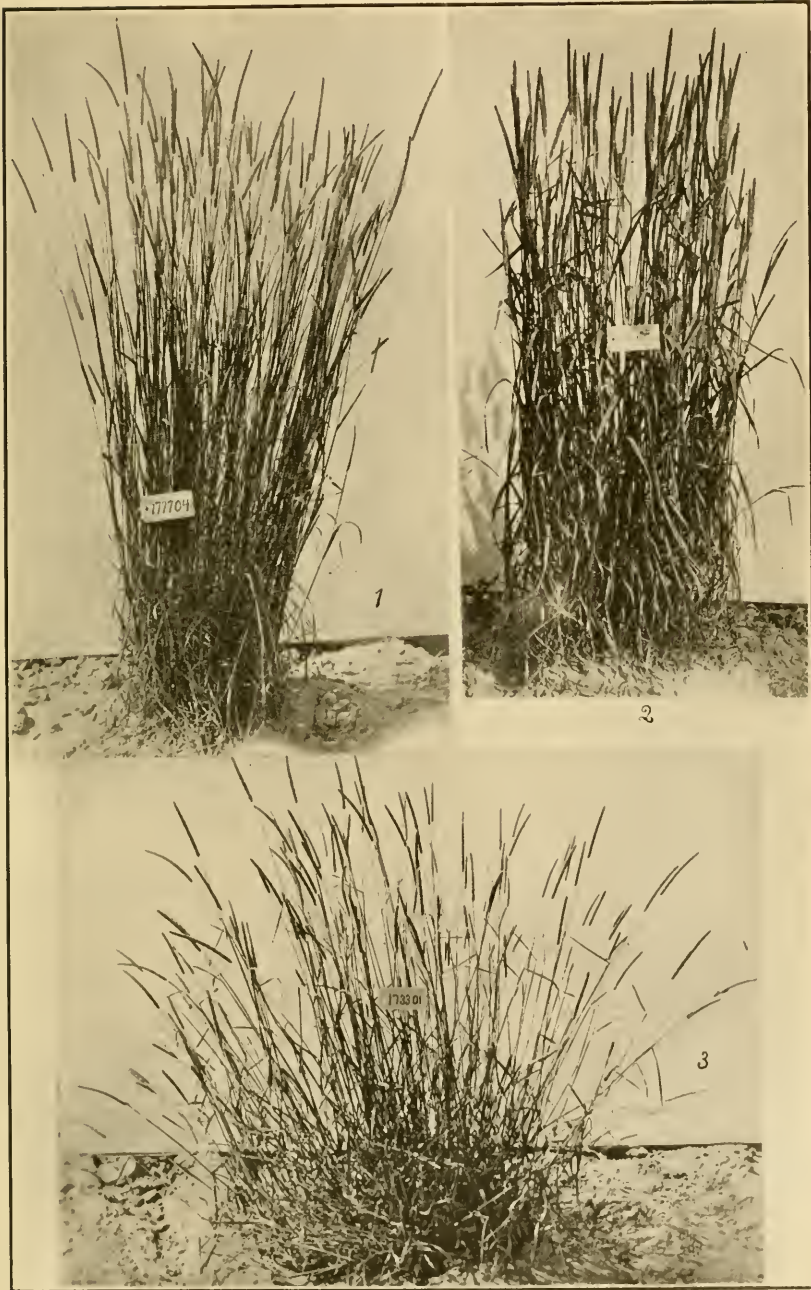

PLATE I.—VARIATIONS IN TIMOTHY.

1, A tall fine hay type; 2, a large tall, erect, dense, broad-leaved type; 3, a medium low spreading type.

Yield depends primarily upon the height and diameter of the plant and upon the density or number of culms developed and also on the size of each culm, size of head, number and size of leaves, and the like.

In height, the plants ranged from 18 inches to 55 inches, as shown by Dr. Clark's summary. Some are veritable dwarfs and others giants. The diameter of the plant is independent of height. Some of the dwarf plants formed in a given period clumps almost as large in diameter as the tall plants. Many plants of three and four years of age will remain very small, showing very little stooling and producing each year only a half dozen or a dozen culms. Other plants stool abundantly and form clumps from 1 foot to 1½ feet or more in diameter, with hundreds of culms.

In the original planting of 1903 the range of variation in yield of dried hay per plant was from 0.16 of an ounce to 21.60 ounces. If this difference in the yield of individual plants is transmitted, fields sowed with small and large yielders should show considerable difference in this important character.

The stems vary greatly in their diameters and ability to stand erect, some individuals showing a decided tendency to lodge.

The leaves vary greatly in length and width but show little variation in number. The great majority of plants produce almost regularly 5 nodes with 5 leaves, but occasionally plants are found which develop normally from 6 to 7 nodes and as many leaves, while occasionally also a lower number of nodes, 3 to 4, is found as the normal number. This character, however, apparently means but little in the production of valuable sorts.

The heads also present a large range of variation in size and shape. They are long and short, thick and thin, smooth and simple, or rough and branched, and the like.

Plants differ also in density, position of leaves, color, time of ripening, resistance to disease, and hosts of other characters more or less important. In season of maturity a variation of from two to three weeks is occasionally found, which is a very important character. The variation in susceptibility to rust (*Puccinia graminis*) is one of the most valuable characters observed. Some plants are badly affected every year, while other plants remain almost wholly free from this most serious disease of timothy.

The question of importance is whether these various individuals showing valuable characters will reproduce these characters, or whether they are hybrids or accidental variations that are unstable

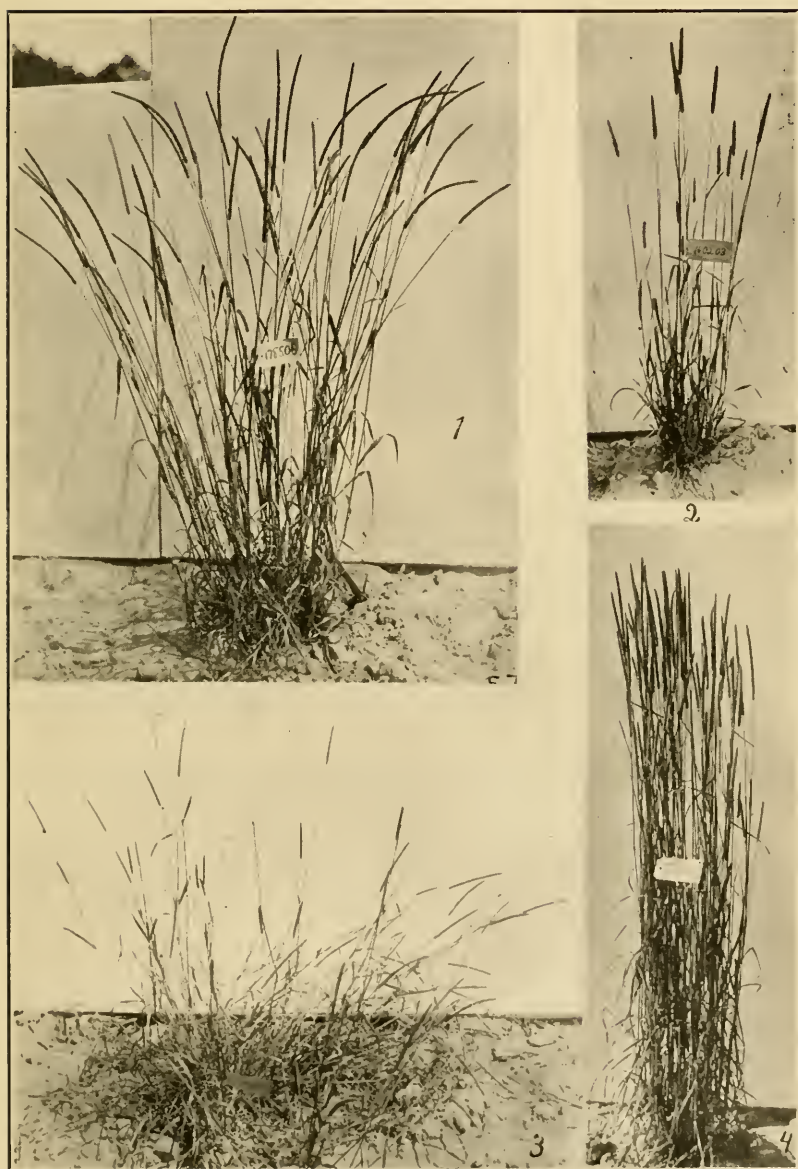

PLATE II.—VARIATIONS IN TIMOTHY.

1, A tall open type with few culms and long heads; 2, a low yielding dwarf type; 3, a lodging type with weak stems normally bending over; 4, a very tall erect plant but small in diameter.

in nature. The selection and testing of such variations has formed the basis of the experimental work since 1907.

Methods of Experimentation.—Plats grown from open-fertilized seed were found to show great variation and little indication of a transmission of the characters for which the plants were selected. Timothy is normally a cross-fertilized plant, and when plants are grown in a mixed field where they are freely crossed with all sorts of pollen, this lack of transmission would be expected. A few heads protected from cross-pollination by covering with paper bags in 1907 gave a few good seeds, showing that at least some seed would set by self-fertilization. Since that time each season a considerable number of the selected plants have been protected from cross-pollination by covering the entire plant with small cloth tents, or by covering certain heads with paper bags. In this way self-fertilized or inbred seed has been obtained from a large number of select types for testing.

The test of any particular chosen plant is conducted in the following way.

(1) The selected plant is propagated vegetatively by digging up and separating the bulbs that are formed in the stooling of the plant. These are taken in early September and a row of from 16 to 24 plants grown. These plants, it will be understood, are simply transplanted parts of the same individual. From such propagation the character of the individual can be judged much better and a more reliable idea can be obtained of the yielding capacity of the plant as well as other characters.

(2) Inbred seed is carefully grown in sterilized soil and the seedlings transplanted in rows in field plats as above described, to test the transmission of the characters for which the plants were selected.

(3) As soon as sufficient seed can be obtained, plats of the different select types are sowed broadcast in the usual way to test the yield under ordinary field conditions.

(4) As soon as a variety is known or believed to be valuable, isolated plats are planted with inbred seed to obtain seed for planting large areas which will finally give sufficient quantities of seed for distribution.

A large number of types have now been tested more or less thoroughly by these methods and very suggestive results obtained.

Do the Variations Transmit their Qualities?—In 1907 over 200 different types were propagated in rows by taking the bulbs and

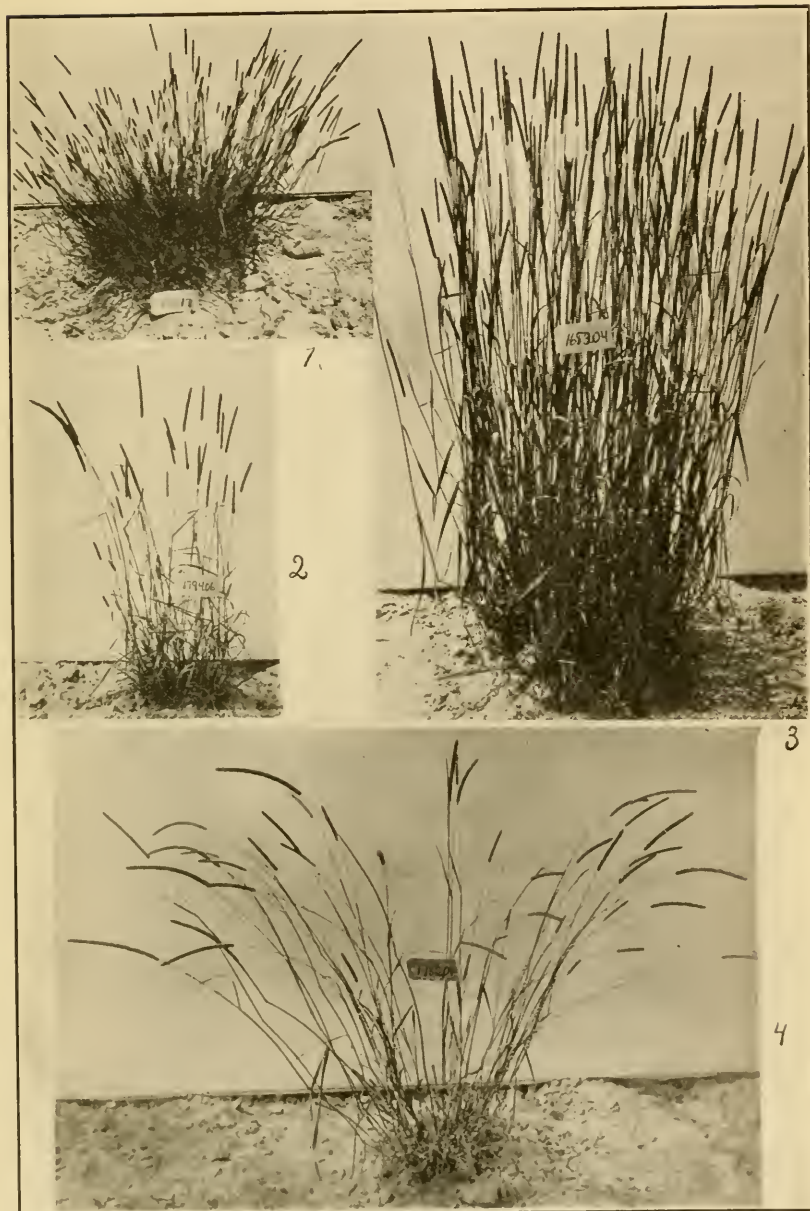

PLATE III.—VARIATIONS IN TIMOTHY.

1, A low dwarf type; 2, a low yielding type with few culms; 3, a heavy yielding good type, tall, large in diameter and dense; 4, a light yielding plant with few and spreading culms.

growing them as clonal^c varieties. The examination of these rows when they were two, three, and four years old showed wonderful differences in type and clearly demonstrated that the differences first observed in the individual seedlings were by no means accidental. Dwarf plants remained dwarf in such rows and giants remained giants. Heavy yielders and light yielders transmitted these qualities in wonderful degree (see Plate IV). In the following table the records of the average yield per plant by clonal propagation in 5 light-yielding and 5 heavy-yielding rows will give an indication of the differences

TABLE 1.—*Showing transmission of yield in timothy by clonal and seed propagation.*

No. of Original Plant.	Plat No.	Average yield per plant of mother by clonal propagation. ounces.	Plat No.	Average yield per plant of progeny by seed propagation. ounces.
LIGHT-YIELDING PLANTS.				
9.02	1786	2.672	3104	1.666
12.07	1797	.768	3216	1.875
17.25	1728	1.744	3167	1.411
128.19	1799	2.672	3217	0.857
211.31	1792	2.464	3211	1.333
HEAVY-YIELDING PLANTS.				
9.03	1611	15.520	1916	10.533
37.31	1630	19.680	1909	9.714
147.41	1620	15.008	1906	10.000
269.41	1743	16.592	1931	9.428
278.40	1752	15.904	1942	9.500

between the various types in this one important character. (See Table I, column headed "Average yield per plant of mother by clonal propagation.")

In 1908 and 1909 test rows of plants from inbred seed of a considerable number of different types were planted, and in many cases by the side of these were grown rows from open-fertilized seed and from clons of the same original plant. These plats had reached sufficient size in 1910 and 1911 to allow careful study and judgment. The writer is now able to state definitely that a very large number of the variations selected have transmitted their characters in marked

^c A clon or clonal variety is one propagated vegetatively by cuttings, bulbs, or grafts, such as the varieties of strawberries, apples, and the like.

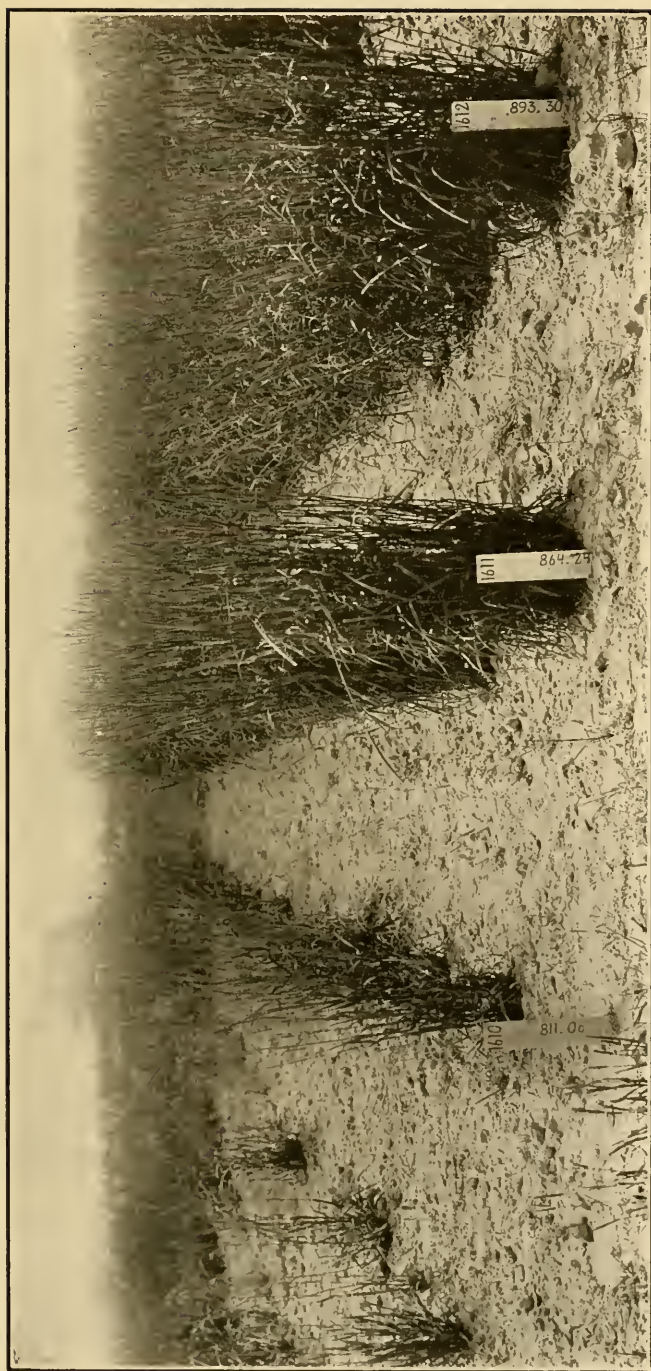

PLATE IV.—HEAVY AND LIGHT YIELDING PLANTS.

Propagated in rows as clonal varieties and showing the transmission of these characters.

degree. Indeed, many of the types appear to be as uniform as any of the varieties of wheat and corn that we have in cultivation. It would appear that the plants originally selected must have been mutations or biotypes. Certain it is, they represent distinctly different types which transmit their characters. Here as in the tests of the selected individuals by clonal propagation the character of light or heavy yield is strikingly transmitted. The record of the average yield per plant of 5 light-yielding and 5 heavy-yielding plants is given in Table I and will indicate the transmission through seed of these characters. (See Table I, column marked "Average yield per plant of progeny by seed propagation." These records are from inbred seed of the same original mother plants, the average yield of which by clonal propagation is given in the preceding column.)

Tests of New Varieties of Timothy.—The experiments described above have shown that when the plants are grown in rows, with all the space which they require for full development around them, they transmit their good qualities, such as yield, and are to be regarded as stable or fixed varieties. The grower will immediately inquire whether these qualities of differences in yield are shown when the different sorts are grown by broadcast sowing in the ordinary way, for of what value are they unless their good qualities are maintained under ordinary methods of cultivation?

To test the different sorts under ordinary conditions, open-fertilized seed, thus probably somewhat mixed, was sown in test plats in comparison with similar check plats of ordinary timothy. The open-fertilized seed of the 17 new sorts was taken from rows of these varieties propagated from bulbs and while not isolated was very much less subject to crossing than where one plant of a type stands alone in a mixed field. The later experience with the plats grown from this seed has shown that there was little crossing, as the plats of the different sorts clearly show their different characters, such as lateness and earliness, color and form of head, and the like.

The seed used for the check plats in these experiments was purchased from a local seedsman and was the best timothy seed which he supplied to his trade. The plats were 1 rod wide and 4 rods long, thus one-fortieth of an acre, and every fourth plat was used as a check and planted with the ordinary timothy seed. These plats were sown in the fall of 1909 and gave good test yields in 1910 and 1911.

Table II shows the actual yields per acre of field-dried hay obtained from each plat in 1910 and 1911. From a study of this

TABLE 2.—Showing yields of 17 new varieties of timothy in comparison with ordinary timothy.^d

Plat No.	Parent No.	1910 yields in pounds.			1911 yields in pounds.		
		Yield per acre.	Check yield per acre estimated.	Gain in yield.	Yield per acre.	Check yield per acre estimated.	Gain in yield.
		pounds.	pounds.	pounds.	pounds.	pounds.	pounds.
C 1831	Check	5280	5280		5400	5400	
1832	1606	6720	5410	1310	6880	5050	1830
1833	1611	7000	5510	1460	7760	4700	3060
1834	1620	6680	5670	1010	7040	4350	2690
C 1835	Check	5800	5800		4000	4000	
1836	1627	7680	6000	1680	8320	3990	4330
1837	1629	8320	6200	2120	8080	3980	4100
1838	1630	7600	8400	1200	7320	3970	3350
C 1839	Check	6600	6600		3960	3960	
1840	1653	7440	6790	650	7680	4050	3630
1841	1668	6040	6980	-940	7160	4140	3020
1842	1671	7640	7170	470	7240	4230	3010
C 1843	Check	7360	7360		4320	4320	
1844	1676	8200	7260	940	8280	4140	4140
1845	1684	7280	7160	120	6920	3960	2960
1846	1687	7600	7060	540	6080	3780	2300
C 1847	Check	6960	6960		3600	3600	
1848	1715	8000	7120	880	8040	3560	4480
1849	1722	7240	7280	-40	6280	3520	2760
1850	1743	7520	7440	80	5880	3480	2400
C 1851	Check	7600	7600		3440	3440	
1852	1745	Road put through this plat.				3560	
1853	1748	6520	7440	-920	5280	3680	1600
1854	1777	9206	7280	1920	7360	3800	3560
C 1855	Check	o. it			3920	3920	
Average yield 17 new sorts.		7451 lbs. per acre			7153 lbs. per acre		
Average yield checks.....		6600 lbs. per acre			4091 lbs. per acre		
Actual average increase...		851 lbs. per acre			3062 lbs. per acre		

^d In the above table the column headed "Check yield per acre estimated" may need explanation. The comparison of two plats grown side by side may not be fair, as the land changes somewhat even in one rod. We desire to get as nearly as possible an estimated check yield for each plat of what the check seed would have given if sown in that plat. Taking a specific illustration, in 1910, check plat 1831 yielded 5280 pounds per acre and the next check plat 1835 gave 5800 pounds per acre. Evidently for this season the land is getting better as we proceed toward the second check, plat 1835. The difference between the two checks is 520 pounds. In every four plats there is one check and one-fourth of 520 pounds is 130 pounds. Now if we add 130 to the yield of plat 1831 we get the estimated check yield for plat 1832 which is 5410 pounds. Adding 130 pounds to this gives us 5540 the estimated check yield for plat 1833. This will probably make the method clear. The correction number between each two checks will obviously be a different number in most cases.

table it will be seen that in 1910 three of the new sorts, 1841, 1849, and 1853, produced less than the yields of their estimated checks but that in the other cases the yields were much in advance of the checks. In this year all of the 17 new sorts gave an average

yield of 7451 pounds per acre, while all of the check plats gave an average yield of 6600 pounds per acre. The new varieties, even including three two low yielders, gave an average increase of 851 pounds per acre.

In 1911, which was in general a less favorable season for timothy, all of the new sorts showed substantial gains over the checks. In this year the average yield of all of the 17 new sorts was 7153 pounds per acre, while the check plats gave an average yield of only 4091 pounds per acre. The new varieties in this year thus gave an average increase per acre of 3062 pounds, or over $1\frac{1}{2}$ tons per acre.

The reason for the decrease in the check plats in the second season is clear to one who has followed this work. Ordinary timothy rusts badly and owing to lack of vigor is comparatively short-lived. A large part of the decrease is due to these causes, but it is also in some measure due to the poorer season. On the other hand, the new varieties are selected for vigor, rust resistance, and ability to stool, and they would naturally increase in size for three or four years and would gradually cover the ground more thickly. These varieties were clearly cut down by the poor season, or they would have given a better yield the second year than the first. Throughout this experiment, which was made as uniform for every plat as possible, the new varieties have clearly shown their superiority in greater height and thicker development on the ground (see Plate V). It may be stated furthermore that several hay dealers belonging to this Association who have visited the plats have stated without reservation that the quality of hay produced by the new sorts, owing to the retention of a fresh green quality and leafiness, would be much superior to that on the check plats of ordinary timothy.

What do these New Varieties Mean?—It may seem surprising to those unfamiliar with breeding that such striking results can be obtained in so short a time. It is truly rather remarkable, but is in no sense a greater increase than would be expected under the conditions. When we remember that timothy is one of the most general crops grown in the civilized countries of the world and that it has been cultivated for about two centuries under very widely differing conditions of soil and climate, we can see that every opportunity possible has been furnished for the stimulation of variations. We now know that a variation once produced is rarely lost in nature but usually is added to the total character variations of the species. Through many years and over millions and millions of acres, among countless billions of plants, these variations have been accumulating, with

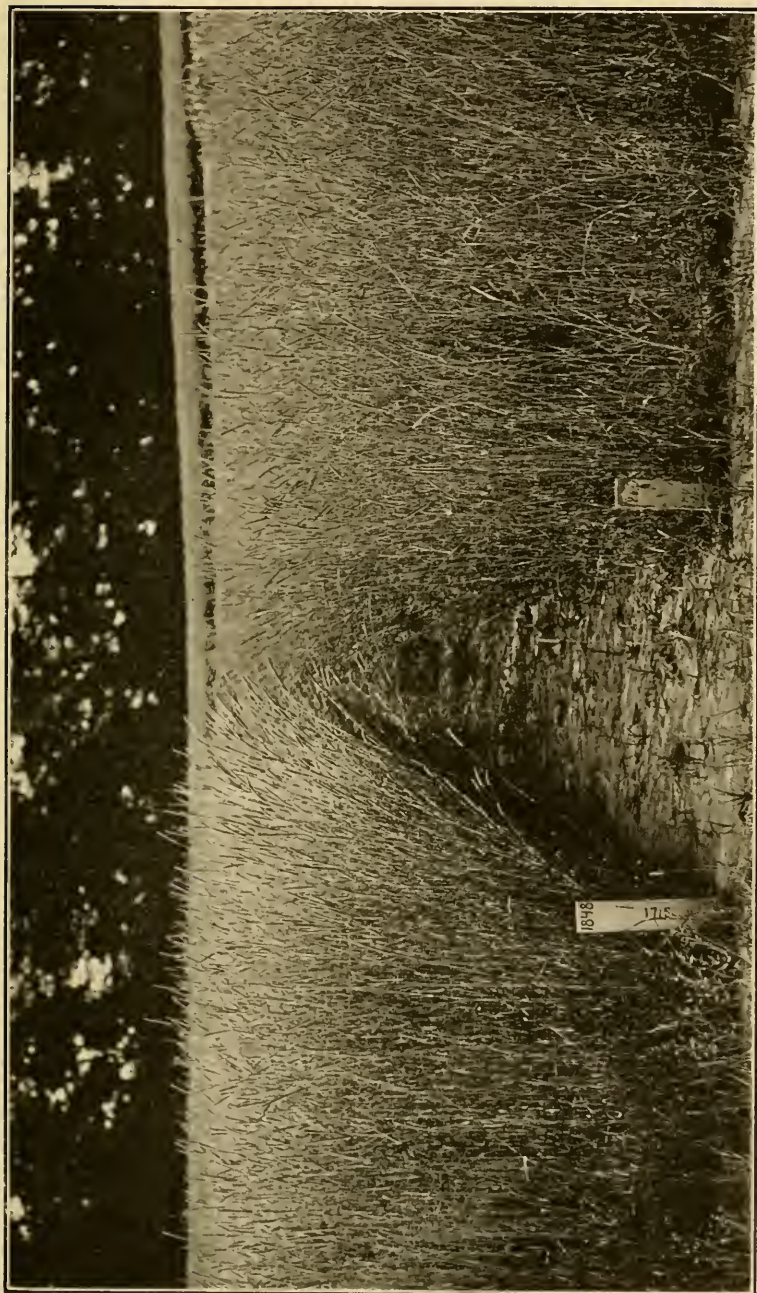

PLATE V.—BROADCAST PLATS SHOWING TRANSMISSION OF HEAVY-YIELDING CHARACTER.

On left, new variety; on right, ordinary timothy.

no attempts to isolate them and use the best for the foundation of improved races for cultivation. Is it any wonder then, that with this accumulation of material by selecting the best variations we get races that yield nearly double the mixture of all sorts of types?

Suppose, for comparison, apples had not been bred for the last two centuries and we had a 40-acre orchard planted with all sorts of variations taken at random, including the worthless wild types and all other sorts such as would have been produced in this period of cultivation without selection. What would be the comparison of value between the crop of such an orchard and the crop from a similar 40-acre orchard planted with Northern Spy or any one of 500 of our good modern varieties? The crop from the unselected varieties would in large measure be wholly unsalable in our modern markets. Probably not more than one-sixth of the crop could be sold for any purpose, and it is doubtful whether even one one-hundredth of the crop could be compared with our modern sorts. If we compare the results obtained in timothy, therefore, with a similar illustration in apples, we can readily see that the timothy results, as obtained in the experiments described above, are no greater, if as great, as we might expect. Indeed the writer feels that only a beginning has been made up to the present time.

Hay is among the three largest agricultural crops of the United States, in total value of production. In 1910 according to the statements issued by the United States Department of Agriculture there were grown in the United States 45,691,000 acres of hay which yielded a crop having a farm valuation of \$747,769,000. No statistics are available from which we can determine what proportion of this hay was timothy, but the writer believes that we may safely conclude that at least one-third of the entire hay crop of the country is timothy. If this is true the timothy crop of the United States in 1910 had a valuation of over \$249,000,000. In the two years during which tests have been made the 17 new sorts gave an average increased yield of slightly over 36 $\frac{2}{3}$ per cent above ordinary timothy. A 36 $\frac{2}{3}$ per cent increase in the valuation of the timothy crop as above estimated would give us over \$90,000,000 as the estimated annual gain in the value of the crop which would be obtained if equally good new sorts could be used throughout the country.

Such figures it must be remembered are simply estimates and mean but very little other than to give us quickly a comprehension of what such experiments under ideal conditions might mean to the country. The writer would state very emphatically, however, that

he believes it would be entirely possible to increase the yield of the crop to this extent if it were possible to have every field of timothy in the United States sown with the one of these new varieties best adapted to the conditions. In New York, which is the largest hay-producing state in the Union, and where these varieties have been developed, their introduction into cultivation should result in a marked increase in the average yield.

When can Seed of the New Sorts be Obtained?—For the next two years it is probable that every seed of the new varieties available will be grown to increase the supply. Every effort will be made to get these varieties into the hands of growers at the earliest possible date. While timothy increases very rapidly, a considerable period must necessarily intervene before the seed will be available in large quantities. The writer would request that growers do not write for seed at the present time, as it cannot be supplied.

METHODS OF CORN BREEDING

H. K. HAYES

Connecticut Agricultural Experiment Station, New Haven, Conn.

The purpose of this paper is to bring before the association some further evidence to show that practical corn breeding does not at present take advantage of its full possibilities.

We now recognize two main types of variation: the one which is germinal and transmits its characteristics to later generations and the other which is due to environmental conditions and is not inherited. The type which is heritable is of most importance to the breeder.

The excellent work of Johannsen, which has been corroborated by many other investigators, shows that commercial varieties of plants are composed of many types which by selection can be isolated and which will breed true to type. These types have been called "types."

The types of Maize.—The work of Shull and East shows that any variety of corn is composed of many types. Further evidence on this point has been obtained in the last few years at our station in connection with a study of inheritance in maize. For this purpose it has been necessary to use a number of inbred families. The most interesting of these from the standpoint of biotypes in maize are five inbred strains which originally came from the same

commercial variety of Leaming. These types have been given the numbers 6, 7-1, 7-2, 9 and 12 respectively. No. 9 is a pure red-silked form, but all the others have white silks. No. 6 and No. 9 are erect in habit of growth and have strong sturdy stalks, while the two 7 types and No. 12 are more slender in habit, being more easily blown down by the wind. No. 6 has a cylindrical ear, No. 9 a conical ear, while both the 7 types have flattened ears. Nos. 6 and 9 have a modal class of 16 rows, No. 7-1 a modal class of 20 rows, and No. 7-2 of 22 rows.

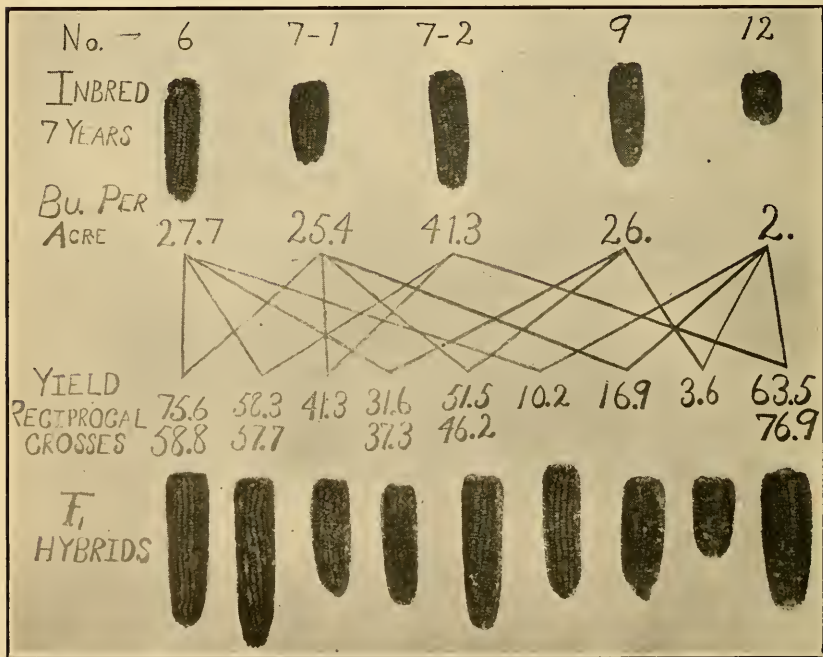

FIG. 1.—HYBRID STRAINS AND FIRST GENERATION HYBRIDS.

The lines between the inbred and hybridized series show the parentage of the latter.

These data show that in certain characters these types have measurable differences, besides others of course which cannot easily be either described or measured.

These inbred types have differed also in their yielding capacity and the average height of plants, as is shown in Table 1, which gives the number of generations each has been inbred, the yield in shelled corn figured to an acre basis and the average height of plants in inches.

TABLE 1.—*Yields of inbred strains for 1911.*

No.	Number of years inbred.	Bushels of ears per acre.	Height of plants.
6	5	27.7	86.7
7-1	5	25.4	81.1
7-2	5	41.3	90.5
9	6	26.0	76.5
12	6	2.0	81.8

In 1911 these inbred types were grown on a level plot of land at the experimental field but the season was so dry that the yields were much less than those of a normal year. All gave fair yields, however, except No. 12, which is a very poor yielding strain and can scarcely live when isolated.

That continuous selection may eventually reach the same goal as inbreeding is fast becoming evident. On the same plot of land with the inbred types four selections were grown from seed kindly furnished by Smith of Illinois. These were the Illinois erect, declining, high and low ear strains. The high and low ear strains bred true to their respective types. The main difference in the erect and declining ear types, as has been pointed out by Smith, is in the number of nodes to the ear shank. The yield of these four selections is given in Table 2, and averages about the same as that received from the inbred varieties previously mentioned.

TABLE 2.—*Yield of Illinois selections grown in Connecticut.*

Illinois strains.	Number of years selected.	Bushel per acre.
High ear.....	7	26.2
Low ear.....	7	18.8
Erect ear.....	6	32.6
Declining ear.....	6	42.9

That the same results can be more quickly reached by hand pollination than by continuous selection is confirmed by two strains of white rice pop which the writer has been able to isolate from a commercial white rice pop variety in two years by hand pollination. One of these strains has a very short ear shank and erect ear, while the other has a much longer ear shank and a declining ear. These strains appear more uniform than the Illinois erect and declining ear selections.

Effects of Inbreeding on Corn.—There is an old idea that inbreeding decreases vigor and will eventually run out a race, but the accumu-

lated evidence so far of the effects of inbreeding in corn does not show such results. The facts of the case seem much better stated by saying that F_1 hybrids between two different types are as a rule very vigorous; that inbreeding does not run out a race but isolates biotypes and that some biotypes can scarcely live unless in a state of hybridity. This may seem like stating the same thing in two different ways, but attention is called to the fact that in the latter case the type after being isolated will not be further affected by constant inbreeding.

Crosses between Biotypes.—The fact that a cross between two different types is very vigorous in the F_1 generation has been alluded to by many scientists. Darwin in his *Cross and Self-fertilization in the Vegetable Kingdom* gives many examples of such increased vigor. Mendel, the discoverer of the only known law of heredity, mentions the fact that a first generation hybrid between two of his sweet pea types grew more vigorously and to a greater height than either parent.

In two crosses between tobacco varieties which the writer has observed, the F_1 generation for all characters studied except the number of leaves per plants showed an increase in vigor due to the crossing. With cigar wrapper tobacco, however, quality is the important factor and F_1 crosses do not give as good quality as the parent types.

With corn, however, the important thing from a practical standpoint is total yield in bushels of ears and tons of stover per acre. Reasoning from this standpoint, three writers published articles in 1909 suggesting that some method for utilizing the added vigor due to crossing should receive commercial trial. Shull and East from their studies of inheritance in maize concluded that some method whereby only first generation hybrids be grown for the commercial crop would prove of advantage and materially increase the present yield of corn per acre.

Many examples have been collected by Collins of the Department of Agriculture showing that, as a rule, the F_1 generation crosses of corn prove better yielders than the parents. Some crosses do not prove beneficial, however, and it seems important to determine the reason for this.

Reciprocal crosses were made in 1910 between the inbred types shown in Table 1 and this year were grown on a level plot at our experimental field, the results being given in Table 3. In this table the female parent comes first and a cross between No. 6 and No. 9 is written 6×9 . A row consisting of 79 hills, 3 stalks to the hill,

was used for each cross. As has already been mentioned, the season was unfavorable and the dry weather materially decreased the yield; however, all crosses had an equal chance. All crosses gave large increases in height over the inbred types, but some were more productive than others.

TABLE 3.—*Reciprocal crosses.*

No.	Bushels of shelled corn per acre.	Height of plants in inches.
6 × 7-1	75.6	111.4
7-1 × 6	58.8	114.5
6 × 7-2	58.3	117.8
7-2 × 6	57.7	
6 × 9	31.6	109.3
9 × 6	37.3	109.
6 × 12	10.2	115.4
7-1 × 7-2	41.3	103.7
7-1 × 9	51.5	111.8
9 × 7-1	46.2	107.4
7-1 × 12	16.9	
7-2 × 12	63.5	114.7
12 × 7-2	76.9	114.0
9 × 12	3.6	103.6

It should be noted that the selections 7-1 and 7-2 are very similar and were isolated from strain No. 7 after it had been inbred for three years. A study of the previous table tends to confirm the following facts.

(1) Reciprocal crosses are equal within the limits of fluctuating variability. This fact shows that we are dealing with very nearly pure biotypes.

(2) All crosses between pure biotypes are not beneficial. Note the crosses between 6 and 12 and 9 and 12 which are poor yielders. It is interesting to note that these crosses had as one parent a type, No. 12, which in a state of self-fertilization was scarcely able to live.

(3) Crosses between nearly related types show little benefit from crossing. 7-1 × 7-2 only gave a yield of 41.3 bushels, the same yield as received from No. 7-2 when self-fertilized.

(4) Some crosses are much more vigorous than others. Reciprocal crosses between 6 and 7 and between 7 and 9 are good combinations.

Nos. 6 and 9 are without doubt more similar in characteristics than 7 and 6 or 7 and 9.

It seems very probable that those types which differ in the greater number of characteristics will prove, as a rule, the better for cross-

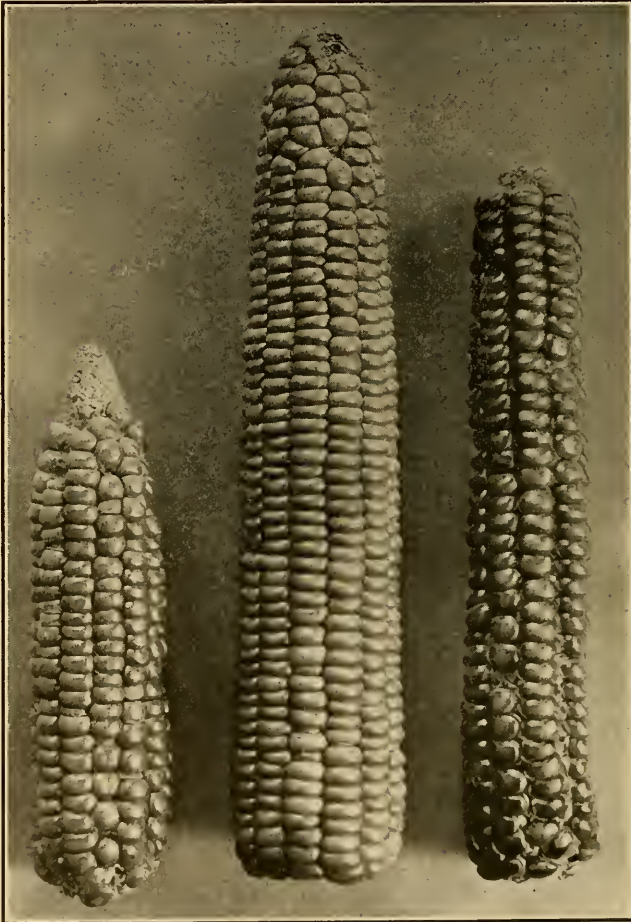

FIG. 2.—Outer ears inbred one generation. Middle ear result of their crossing, first generation.

ing. It should be recognized, however, that poor genotypes should be eliminated by selection.

Comparison of F_1 and F_2 Generations.—Two comparisons of the yield of F_1 and F_2 generations of biotype crosses were made in 1910. The F_1 generation of a cross between a dent and flint type yielded at

the rate of 105.5 bushels per acre, while the F_2 generation grown on the same field produced only 51.5 bushels. The F_1 generation of a cross between two Leaming strains produced at the rate of 117.5 bushels per acre, although the F_2 generation yielded only 98.4 bushels.

These data show that the greatest stimulus to development from crossing two distinct types is obtained only in the first hybrid generation. This necessitates making the cross each year. The expla-

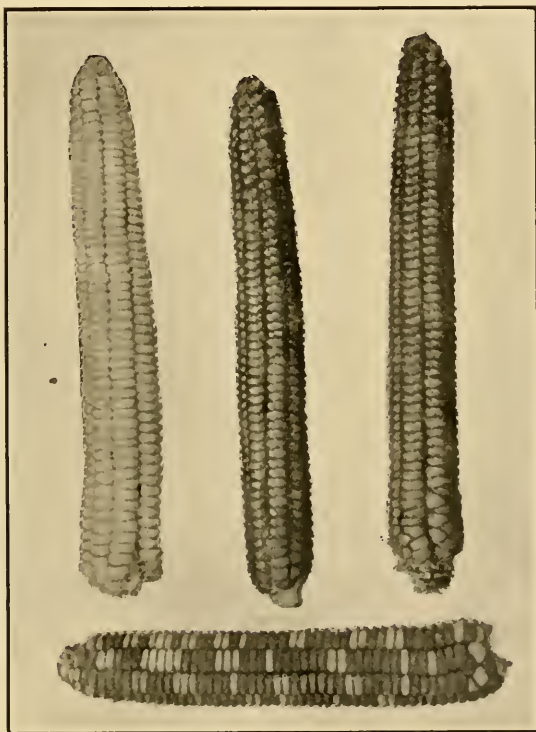

FIG. 3.—The middle ear is the result of an immediate cross between a white and yellow variety and the lower ear shows what would be obtained if such parents were used to produce a first generation hybrid.

nation of the decrease in vigor in the second hybrid generation is exactly the same as the explanation of the apparent deterioration when corn is inbred. Both are caused by recombinations of characters among which some "pure type" individuals are obtained. In inbreeding the apparent deterioration is more marked because the percentage of such individuals is likely to be much greater.

Crosses between Varieties.—Whether crossing of pure biotypes will prove of greater value than crosses between highly selected varieties is as yet an unsettled question. Many of our corn varieties have been grown for long terms of years under the same conditions and have been gradually selected to some type. Crosses between such varieties give, as a rule, increases in the F_1 generation. The following table gives the results received at our station and shows that F_1 generations are usually more vigorous than the parents. The first two crosses of this table were grown in 1908 and the remainder in 1911.

TABLE 4.—*Crosses between varieties and their parents.*

Selection.	Yield in bushels of shelled corn per acre.
Longfellow Flint.....	72.0
Illinois High Protein.....	121.0
Cross.....	124.0
Stargis Flint.....	48.0
Illinois High Protein.....	121.0
Cross.....	130.0
Conn. Top Over Flint.....	58.3
C. T. O. X Canada Flint.....	65.3
Woodbridge's Canada Flint.....	72.9
W. C. X Watson's White Flint.....	80.0
R. I. White Flint.....	62.2
R. I. W. X Mammoth White Flint.....	69.3
Stadtmueller's Leaming.....	75.7
S. L. X Reid's Yellow Dent.....	99.9
Brewer's Dent.....	77.6
B. D. X Early Dent.....	94.7
Longfellow Flint.....	60.5
Longfellow X Ives.....	69.1
Ives X Longfellow.....	63.5
Ives Flint.....	69.5

The varieties used in the above table are, as a rule, very pure to type. It will be noted that in some cases only one parent is given. This is due to the fact that these crosses were made by Connecticut farmers and seed could only be obtained from one parent. Where the cross has been grown both at the station and by the farmer who made it the average of the two tests has been used for comparison.

Summing up the crosses given in the above table and where both parents were grown, using the better yielding parent, we find that the average yield of the parents is 82.3 bushels per acre, while the average yield of the F_1 hybrids is 91.0 bushels. Thus we have an average increase of 8.7 bushels per acre for the crosses.

As the crossing of two corn types is such an easy matter and can be done on any farm it seems very desirable that further crosses



FIG. 4.—At the left and right of the photograph are shown respectively Longfellow Flint and Illinois High Protein Dent. The two central ears represent the F_1 generation. This is the first cross of Table 4.

should be made to determine, if possible, what varieties are the most valuable to use as parents.

Conclusion.—The utilization of F_1 hybrids in corn breeding will materially increase the corn yield.

Selection is of importance in isolating the better types and ridding the variety of the poorer types.

The highest yields of corn will be received from carefully bred selections which when crossed prove the most vigorous combinations by actual test.

LITERATURE CITED

- COLLINS, G. N.
 1909. The Importance of Broad Breeding in Corn. Dept. Agr. circular.
 1910. Increased Yields of Corn from Hybrid Seed. Dept. Agr. Year Book, pp. 319-328.
- EAST, E. M.
 1909. The Distinction between Development and Heredity in Inbreeding. Amer. Nat., 43, 173-181.
- EAST, E. M. and HAYES, H. K.
 1911. Inheritance in Maize. Conn. Exp. Sta. Bull. 167, 1-142.
- HAYES, H. K., and EAST, E. M.
 1911. Improvement in Corn. Conn. Exp. Sta. Bull. 168, 1-21.
- JOHANNSEN, W.
 1909. Elemente der exakten Erblichkeitslehre. Jena. Fischer. Pp. 1-515.
- SHULL, G. H.
 1909. A Pure Line Method of Corn Breeding. Amer. Breeders' Report, iv, 296-301.
 1911. The Genotypes of Maize. Amer. Nat., 45, 234-252.
- SMITH, L. H.
 1910. Increasing Protein and Fat in Corn. Amer. Breeders' Report, v., 5-11.

THE BREEDING OF WINTER BARLEYS

H. B. DERR

Washington, D. C.

History of the Work.—The work in cereal breeding in the Department of Agriculture was inaugurated a number of years prior to the establishment of the office of grain investigations, which now conducts that line of work. The breeding work was first established at Garrett Park, Md., in 1895, by Mr. M. A. Carleton, the present cerealist of the Department of Agriculture, and consisted principally in the production of disease-resistant strains of cereals. A few years later the work was transferred to the Agricultural Experiment Station at College Park, Md., and in 1902, Mr. H. A. Miller, formerly of this office, was placed in charge of winter cereal breeding. In 1902 Mr. Miller planted 22 varieties of winter barley and in the spring of 1903, 59 varieties of spring barley. This work he continued until 1906, when the writer became associated with the Office and has since conducted the experiments and breeding work.

The negative results obtained with spring barleys by both Mr. Miller and myself demonstrated the inadvisability of continuing

experimental work with them. It was clearly proven that, for the South Atlantic States at least, climatic conditions were against their successful cultivation, and since 1907 all our energies have been directed toward the improvement of the winter barleys. In 1907, the breeding work with cereals having assumed rather large proportions, it was removed to the Department of Agriculture's experiment farm at Arlington, Va., opposite Washington, D. C., and has since been conducted there. In our efforts to produce better-yielding varieties of barley we have succeeded, during the past four years, in chang-



EXPERIMENTS WITH BARLEY ARLINGTON FARM, VA., NOVEMBER, 1909.

This illustration shows the winter habit assumed by the different varieties. The taller plants are spring barleys being changed into winter forms. The low spreading form is that taken on by the regular winter varieties.

ing 16 of the leading spring barleys, such as Chevalier, Hamchen, etc., into winter forms (see illustration), and in several cases they are outyielding the standard winter barleys, of which 29 are under test. The breeding and testing of winter cereals occupied over 13 acres of space the past year.

Crossing of Barleys.—During the past seven years a number of crosses have been made both by Mr. Miller and myself, and from some of these crosses excellent practical results have been obtained.

As these results are to be published in bulletin form only a few of the lesser details can be given here.

Several of the most important crosses were made before the writer became connected with the work in 1906, consequently he knows but little of the character of the mother plants. In 1907, among the large number of variations produced, several attracted attention owing to their peculiar plant characters. The plants from one selection from the cross Tennessee Winter ♀ six-rowed, with Black Arabian ♂ two-row were especially noticeable. Several plants produced heads which, while they resembled two-rowed barleys, were not typical. The median spikelets were fertile and produced plump kernels with medium long awns, while the lateral spikelets were nearly all infertile with the exception of a few almost rudimentary kernels with short, bristly awns. These small lateral kernels were selected and planted in a head-row test, and the following year, 1908, produced plants, a number of which bore heads similar to those of the year previous but containing a much larger percentage of lateral kernels, the majority of which were almost entirely awnless. These were again carefully selected and planted in head-row tests, and in 1909 one of these selections produced 16 plants on which the heads were entirely awnless. Several other selections produced awnless plants but these strains were later discarded. In the fall of 1909 the heads from each of these 16 plants were planted in separate rows for comparison. In 1910 only three heads produced plants having bearded heads. These entire strains should have been destroyed and future annoyance thus averted. In September, 1910, over five hundred head selections were planted in the breeding plat and some interesting data are being compiled relative to the height, number of culms, length of head, etc., of the daughter as compared with the mother plants. Seed of this awnless barley was distributed to a number of reliable coöperators in the south in order to test the influence of environment.

Most of the plants bred true in 1911, but in a few cases the impure blood of the 3 plants that showed traces of bearded characters in 1910 appeared among the plants. By means of an index system adopted, the writer easily traced the record of the progeny from each plant through each generation back to the mother plant, and all the progeny from these 3 plants will be discarded.

It is believed that there is a great future for this barley. It stools heavily, has stiff erect culms and gives all indications of being an excellent yielding variety. Pedigreed seed of the awnless barley has been sent to nearly all the experiment stations and farms in

the northern states, with the request that it be sown next spring in an effort to change it into a spring form. With careful selection this is believed possible in 3 years.

The awnless hybrid was given a name and number and is now known as Arlington Awnless Barley, G. I. No. 702. It was described in *Science*, Vol. XXXII, No. 823, October, 1910, and the type specimen and description deposited in the economic herbarium of the Department of Agriculture at Washington.

Hull-less Hybrid.—A hybrid has also been produced between Maryland Winter and Hankau, a bearded hull-less spring barley. This hybrid known as Hansee Hull-less, G. I. No. 703, has bred true for two years, and is a hardy bearded hull-less winter barley. The bearded hull-less barleys are adapted to the higher elevations of the western and southwestern states. This seed is being distributed wherever it is thought likely to succeed. Winter barleys generally outyield the spring barleys and, in localities where they can be grown, the quality is superior and the weight per bushel heavier.

Hooded Hybrid.—Owing to the fact that, with the production of the Arlington Awnless barley, there were two distinct types of beardless barley, it was considered necessary to adopt another name for the common beardless barley. As this variety was not entirely awnless, having a three-pronged, hood-like appendage, the name "hooded" barley was proposed for it, the name "awnless" being restricted to the Arlington Awnless barley. These names will be used by this office in the future.

In the South Atlantic States hooded (beardless) barley is quite popular, as it yields a highly palatable and nutritious hay. In general, this has been a spring-sown crop, with the result that only under extremely favorable conditions can a crop of grain be produced therefrom. The necessity for a reliable winter form of hooded barley was so apparent that crosses were made. After several years of selection, the good qualities of one of the hybrids became apparent and it was named Virginia Hooded barley, G. I. 648. The seed is being distributed to reliable coöperators for further increase.

Standard Varieties.—There have been several standard varieties of winter barley cultivated in the Atlantic and Southern States, but, previous to 1900, little or no effort was made to improve them. In 1900, the Tennessee agricultural experiment station began the breeding of winter barleys, and in 3 years, wrought a considerable change in yield and quality. This was about the time that Mr. Carleton began the work at College Park. Excellent results have attended the work of this office since that time.

Since 1907 a large amount of selected seed of winter barley has been distributed. It may be thought that once having established a pure race the work was done, but with such factors as planting at the wrong time, or by improper methods, or last but not least the mixing due to the traveling thrashing machine, pure races among the farmers soon undergo decided changes and breeding and selection must, of necessity, be done over again.

The three varieties of winter barley that have been selected are Tennessee Winter, Maryland Winter, and Wisconsin Winter. The first two are, without doubt, similar strains from the original winter barley introduced by the early colonists many years ago. Our limited farm facilities permit only a small acreage of each variety, consequently, when a hybrid or selection has by its increased yield or improved plant characters demonstrated its superiority over the standard varieties, the seed is distributed to reliable coöperators over as wide an area as possible in order to test the influence of environment upon it, as well as to obtain a more rapid distribution of the seed.

In order to keep a line on the pure races, selections are made each year and carried through the series from the head-row test planted one year to the field test harvested four years later.

Reports received from coöperators located in different portions of the winter-barley-producing area all indicate the superiority of this selected seed. The two new hybrid barleys, Arlington Awnless and Virginia Hooded, will no doubt still further increase the popularity of the winter-barley crop owing to their freedom from beards, the most objectionable character of barley. The high prices prevailing the past few years have made barley an excellent money crop but cultivation has been restricted, owing to the offensive beards. In the United States are localities in which barley was formerly grown extensively but where it is now only grown in small quantities. In north central Texas large barley areas have been given over to other crops owing to the fact that farm hands absolutely refused to handle the barley crop. In eastern Tennessee the same condition prevails. Even if the farmer is successful in harvesting his barley many of the thrashing crews refuse to thrash the crop, owing to the beards. While barley straw is readily eaten by cattle, farmers are afraid to use it because of the injurious effect of the beards, consequently oats has largely taken the place of barley in the southern states. The total production of barley in the United States for 1911 was 160,240,000 bushels which was over 13,500,000 bushels less than in 1910. It is probable that if the experiment station workers and those inter-

ested in the production of barley in the northern states would take this awnless winter barley, by selection they would change it into a spring form, without injuring its present high-yielding qualities. If this were done, it would in a few years increase the total production of barley in the United States 25 per cent, and put at least \$24,000,000 more in the pockets of the American farmers.

CONSTRUCTIVE EUGENICS

WILLET M. HAYS

Washington, D. C.

[CONTINUED FROM FIRST QUARTER]

Let us then not have an open country of large estates manned with a semi-peasant class nor with defective classes. Let us rather have the family-sized farm, conducted by two or three workers, and splendidly supporting the farm family, that we may have our best heredity on the land. Let public money be freely used to supply the farm families with good roads, splendid consolidated rural schools, free delivery of mails, parcels post, and all kinds of informational and advisory help, the most important of which is the consolidated rural school. Let the state and nation in every way possible assist the farmers and suburban residents to organize among themselves those coöperative projects which enable them to carry on collectively such selling, buying, and other functions as the individual farmer and home maker cannot alone so well perform. And especially is there needed research and aid to make less burdensome the duties of the mother. If ways could be found of successful coöperation in doing the laundering, the baking, the canning of fruits, the killing of stock and curing of meats, and other heavy work, the genetically best mothers would have further encouragement to live on the land.

In order that the cities as well as the country may be rejuvenated every two hundred years, the eugenic slogan should be "the best people on the land." And there are other similar weighty genetic reasons for building up the suburban regions around about our cities and towns. Here encourage the efficient people of the non-agricultural vocations to live. And the public should provide vocational schools for all youths, that when grown they may be able to sustain superior homes. Low transportation rates for pupils to and from vocational schools is an example of how the public can give a

chance to the youth of suburban families to become efficient. Let the genetic burden be laid on the genetically efficient and give them the means and the security under which they can efficiently perform their task.

The Arithmetic of Mass Improvement.—To illustrate the fact that the improvement of the human race by selection is not, after all, so different from the improvement of animals or even of plants, some arithmetical calculations are offered. Suppose, for example, that we divide our nearly one hundred million people into three orders. Let us place in the first order the genetically best one-fourth, whose children will be the most efficient, and let these be represented by the number 25. Let us place in the second order the genetically medium in value, and let these be represented by the number 50. Then, let us place in the third order the genetically least efficient, and let them be represented by the number 25. Without assuming that to be at present the correct number of individuals per family, let us assume that if the second order, represented by the number 50, have families averaging $3\frac{1}{2}$ in number, this will be sufficient to keep the number intact, so that this 50 of medium genetic value will remain constant at 50 for succeeding generations. Thus there will be two left from the average family for parents of the next generation to take the place of the two who served as parents of the preceding generation. The other $1\frac{1}{2}$ of the average family will be sufficient to represent the number of infantile deaths, the number of non-married, and the number of those married but having no children.

Let us now assume that the best one-fourth have families somewhat larger—say four children per family. By subtracting the $1\frac{1}{2}$ for infantile deaths, non-marriages, etc., we have remaining $2\frac{1}{2}$ with which to produce the next generation where there were only the two parents of the family the preceding generation. This is an increase of one-fourth. By multiplying the 25 by $1\frac{1}{4}$, we have $31\frac{1}{4}$ as the number in the second generation. By continuing this multiplication by $1\frac{1}{4}$ for twelve generations we have 364, while during this entire time the medium one-half remains at 50.

Now, taking the 25 least efficient genetically, let us assume that there is an average of only three children per family. Here, taking out the $1\frac{1}{2}$ for infantile deaths, non-marriages, etc., we have for the next generation only $1\frac{1}{2}$ instead of the two parents of the preceding generation. This is a reduction of one-fourth, leaving each generation three-fourths as large as the last. Multiplying the 25 by $\frac{3}{4}$ we have in the second generation $17\frac{1}{2}$. Continuing this multipli-

cation for twelve generations, we find that this 25 becomes 1, or 0.2 per cent of the whole.

Thus, in twelve generations, or practically 500 years, we have the race made up of 87.7 per cent of the blood of the best one-fourth; 12.1 per cent of the blood of the medium one-half, and 0.2 per cent of the blood of the least efficient one-fourth.

We need not assume that these percentages mean that values would be worked out in exactly these proportions. The illustration is only to show that even with such little differences as an average of one more child per family from the genetically best families than from the genetically least efficient families, the undesirable will gradually become a smaller part and will give the field to the genetically more efficient people.

If instead of four children per family for the genetically best one-fourth we take five children per family and carry out the calculations as above, at the end of five generations, or in two hundred years, the proportions will be, in whole numbers, 410 from the best, 50 from the medium, and 6 from the genetically least efficient; or, expressed in percentage, we have 88 per cent from the genetically best 25, 10.7 per cent from the genetically medium 50, and 1.3 per cent from the genetically least efficient 25. If anything like such a ratio of sizes of the families from the most efficient and the least efficient parents could be maintained, there would be a marked increase in the efficiency of the network of descent in each period of two hundred years, and this could not fail to produce marvelous results in the inherent power of the people in the world.

With all of our studies of heredity we must not overlook the fact that our schools, our churches, and our homes must so conserve moral conditions that normal men and women may be fully developed, with their individual and genetic powers unimpaired as by the racial poisons of alcohol and venereal diseases. In case of intemperance, for example, not only are men ruined by alcoholic beverages who, in the absence of temptation, might be useful citizens and efficient parents, but the impaired vitality which they impart to their children and which they induce by neglect helps to perpetuate the demand for alcohol as a stimulant during the succeeding generation, if indeed, there may not be an actual acquired inheritance of the desire for the specific stimulant. Eugenic pride based on genetic genealogies may eventually greatly lessen the social evil and thus reduce the moral and physical poisoning which is now so widely prevalent. Those who might too critically regard the significance

of the figures above should understand that they are not to be judged from what is commonly termed "mass selection," such as the selection of seed wheat in the fanning mill. It is assumed that the selection would here be genetic, which is not mere mass selection. The basis for comparison in the selecting of individuals would be not so much their individual excellence as the superiority of their genetic power as determined by the average efficiency of their progeny, or as estimated from average efficiency values of their coördinate relations, as brothers, sisters, cousins, and also ancestors.

Some of our scientists who are creating new values by plant breeding have in their plant nurseries hundreds of thousands and even millions of individual plants so grown that each plant stands in a hill by itself, each with its individual number. These technical workers have wrought out plans of utilizing these individual plant numbers as helps in determining the genetic value of each and any plant. Thus they are able to determine in a given standard variety of a given species, as of wheat, the plants which give the largest net value per acre and produce the highest value in the market or in the mill and bake shop, and they are able to find among these best plants the progeny of the occasional mutation. Having found the new mutating stock they can rapidly and readily multiply this into a new and important variety. While such rapid results cannot grow out of systematic efforts applied to the human family, results approximately as rapid as those indicated in the calculations above might be possible. In any event, it would seem quite as proper and important that each person of the family in which we are interested should have a numerical name as that each plant should be so designated in the plant breeding nursery.

A name with eleven letters is not over long. The number 99,000,000,000 has only eleven figures, yet in a series of numbers of that size there could be individual number-names for each of sixty times as many people as now inhabit the earth. At slight cost per name the census bureaus of the world could place in such a single series the number-names of every person now living, every person of whom there is any history, and every person who might be born in the next thousand years. Once instituted, such a system of number-names would go on indefinitely and no two persons would have the same number. If desired, a block of these numbers could be allotted to each country. By exchanging their lists of names and number-names the main bureau of each country would have the

completed series as entered up to date. At relatively small cost the names and number-names of the parents of each person and the number-name of each child born to each person could be added to his own name, also birth and death dates and places, thus giving all needed basic facts regarding his lineage genealogy. These universal world number-names could then be used in lineage genealogies along with any system of family number-names desired, thus placing a means of reference from each genealogical compilation to every other similar compilation.

Private family bureaus, or even public bureaus, could request the census bureau to give each person of their families a lineage number in this world series. The interested family could then give to each member a single number, usually in the form of a percentage, expressing the individual value of the general efficiency of the person. In like manner a single numerical statement, as a percentage, could be used to designate any marked characteristic, as ability in music, or personal beauty, or tendency to obesity. Compilation of these percentages into averages, as of progeny, or of coördinate relatives, so as to give genetic ratings, also in a single numerical statement as a percentage of individuals and of families, would follow the same relatively simple bookkeeping or recording processes that are the common practice in plant breeding and in animal breeding.

Immense importance would soon be attached to these genetic family ratings. Those families with high ratings would be made to realize the importance of mating with those of equal genetic excellence, and the more rapid multiplication of their numbers. The individuals of these families would have a new incentive to gain high personal ratings and to develop their children so that they might merit high ratings, thus preserving and increasing the status of their families. The families of the best genetic blood would be at a premium, especially among other families with high genetic ratings. Again speaking broadly, the best one-fourth of the race would find the world expecting of it not only success as individuals, but that the individuals be multiplied more rapidly than the average. On the other hand, the genetic facts concerning families with definite genetic defects or with such indifferently low genetic efficiency that their members cause public concern and expense, as in eleemosynary institutions, should be publicly recorded. Marriageable members would not be at a premium. The common thought of the people would not place upon this class any large portion of the racial duty of multiplying

the race. They would properly feel that they had better bear fewer children and give especial attention to providing good opportunities for them.

It will be noticed in this discussion that differences are not drawn between small families and large families, but between families somewhat above the average and families below the average. If objection is made that genetic facts will throw society into classes, it must be admitted that the classification will represent efficiency and will not as a rule follow false or mischievous standards. In case of one family where this number-name scheme is used in compiling both the lineage genealogy and the genetic genealogy, many of the plans of determining and displaying the genetic values are already being devised. And doubtless ere long genetics will be showing the breeders of plants and animals even more artful ways than they now have for securing and making plain the genetic values of individuals and families.

Looking at the city, the country, or the world, with its peoples of pure and mixed races, and taking into view the fact that economic conflicts will continue permanently after wars with arms may have ceased, nothing stands out more clearly than the fact that races and families must make their conflicts with large numbers as well as with high averages of individual efficiency. Genetists will have much to do in their study of hybrid races, and with the place of these races in the conflicts among the races of the earth. When the genetist comes to study the great migrations of the races of men, the relation of racial make-up to the economic contests between countries and races, and legislative efforts to avoid or promote the genetic mixtures of races, he will find range for the highest possible wisdom and skill. It has been predicted that neither plant breeding nor animal breeding will eventually develop as highly trained genetists as will be found among those who make a specialty of eugenics.

Genetic knowledge promises to have an important relation to the cost of living and upon the life of the nation. It seems none too much to hope that the science of eugenics will greatly lessen the cost of our eleemosynary institutions, will lead to a better average of efficiency, to the reduction of divorce, to temperance, and to a higher morality. May we not hope that, in addition to increasing the average of intelligence, efficiency, and happiness, eugenics may lead even to a larger production of great geniuses and even to the production of families of special-purpose people? Eugenics as a whole will tend to produce sane, able, well-rounded characters, strong in

their allotted tasks, and good citizens. Who, except the prudish, would object if public agencies gave to every person a lineage number and genetic percentage ratings, that the eugenic value of every family and of every person might be available to all who have need of the truth as to the probable efficiency of offspring?

AN ACCOUNT OF THE WORK OF THE EUGENICS RECORD OFFICE^a

H. H. LAUGHLIN

Cold Spring Harbor, N. Y.

After having been forgotten and ignored by science for thirty-five years the re-discovery, twelve years ago, of the Mendelian laws of inheritance strongly supported the revolutionary work of Weismann then engaging the attention of those interested in heredity. This combination of forces gave biology a new key to the mysteries of inheritance and caused a renaissance in the study of experimental heredity in plants and animals. Foremost among the workers in this subject in America was Dr. C. B. Davenport, Director of the Carnegie Station for Experimental Evolution. His work with plants and animals had not proceeded far before human heredity began to attract his attention. By the summer of 1910 he had collected nearly three hundred records of family traits describing in considerable detail the family distribution of some thirty specific mental and physical traits. By this time the work had grown so greatly in interest and promise that he was invited to organize and direct an institution devoted solely to research in human heredity and its application to human affairs. This institution, the Eugenics Record Office, of Cold Spring Harbor, Long Island, New York, was duly organized, and as stated at the last meeting of this section by October 1, 1910 was ready for work. The family records collected by Dr. Davenport and referred to above formed the nucleus of the files of the institution which are now growing at a satisfactory rate. The functions of this office are (1) to serve as a clearing house for data on human heredity and its application to human affairs, (2) to build up an index of the American population indexing families, traits and their geographical distribution with special reference to sub-normal and super-normal characteristics,

^a Read before the Washington meeting of the Eugenics Section of the American Breeders Association at the Volta Bureau, Washington, D. C.

(3) to train field workers expert in gathering data of eugenic import, (4) to maintain a field force actively engaged in collecting such data, (5) to coöperate and to collaborate with persons and with other institutions concerned with human heredity, (6) to study authentic data, thereby discovering the general laws of inheritance and the specific manner of the inheritance of specific traits, (7) to aid and to promote the organization of new centers for eugenic research, (8) to advise concerning the fitness of marriage unions, (9) to disseminate eugenic truths to the end that society may proceed wisely to the application of plans for the betterment of the human stock.

In the first training class—July and August, 1910—ten persons already advanced students of biology and sociology, were trained as experts in collecting first hand data adequate to the needs of eugenic research, and six of these were employed jointly by the Eugenics Record Office and by other institutions. During the second year—July and August, 1911,—another and somewhat larger group of persons were given a similar training, and six more were added to the staff of field workers, thus making the field force reporting directly to the Eugenics Record Office twelve in all. Several other persons were trained during the year, but not in connection with organized class routine, so that in all nearly fifty persons have been given this special training by Dr. Davenport. The next training course will be given at the Record Office at Cold Spring Harbor, from June 26 to August 6. These twelve workers have been gathering data on the family distribution of the following traits: Feeble-mindedness, epilepsy, insanity, Huntington's chorea, criminality, juvenile delinquency, vagabondism, hare-lip, haemophilia, cancer, albinism, and skin color. Special studies are also being made in consanguinity, the eugenic import of isolated communities, the old Mormon families of Utah, the present day descendants of the old Juke family, the legal sterilization of degenerates in Indiana. Besides, on these lines data on a host of other traits has been gathered. This material is gotten at first hand in the home territories of the families studied. The absence of a body of facts suited to the intelligent application of Eugenic remedies makes this method of original observation imperative. The field workers chart out as far as possible the complete family network along all ancestral, collateral, and consort lines. They spare no pains to secure an accurate family network, and an equally accurate description of the inborn traits of each member. The facts so gathered are indexed at the Eugenics Record Office in accordance with a system devised by Dr. Daven-

port, and recorded in the book of traits (Bulletin No. 6, Eugenics Record Office, February 1912, C. B. Davenport). This index is an expansive one, and is based upon the decimal system, quite the same as the Dewey Decimal System for classifying books. The first synopsis of traits is as follows:

- | | |
|---|--|
| 0. General traits,
General diseases,
Occupations. | 4. Mental traits,
Movements. |
| 1. Integumentary System. | 5. Sense organs. |
| 2. Skeletal system,
Muscular system, | 6. Nutritive system. |
| 3. Nervous system,
Criminality. | 7. Respiratory system. |
| | 8. Circulatory system,
Lymphatic system. |
| | 9. Excretory system.
Reproductive system. |

All record is indexed on a sextuple system, with cards for each of the following combinations: (1) surname-trait, (2) trait-surname, (3) locality-trait, (4) trait-locality, (5) locality-surname, (6) surname-locality. The purpose of this system is to permit investigators to study traits and families and their geographical distribution from the point of view any of these combinations. The efforts of this office are directed toward indexing of all of the defective and sterling germ-plasms of the American population. The making of such an index is an immense task, and will demand the coöperation of many persons and institutions, but its value in the practical application of any scheme looking toward the cutting off of the defective strains of the American population is obvious. But the field worker is not the only source of data. Genealogical, biographical, and medical literatures are being reviewed by the office with the view to extracting data sufficiently biological and detailed in nature to permit of biological deductions. Genealogical records contain, save for data on consanguinity, longevity, and fecundity, but little material of value. Town histories, on the other hand, are much richer from the Eugenic point of view. Medical literature contains a considerable number of authentic family networks, describing in detail the distribution of certain traits and many valuable records have been gotten from this source. The number of physicians and institutions coöperating with the Record Office is gradually increasing. From these sources many pedigrees are secured, but the most valuable records are those of family traits which are still being secured from many splendid normal American families. For this purpose duplicate blank schedules are supplied by the Record Office, one for the files of the office, and the

other for the personal use of the collaborator. Besides this general record of traits, several special schedules have been prepared. Up to the present time these are schedules on (1) alcoholism, (2) hare-lip, (3) musical ability, (4) mathematical ability, (5) Huntington's chorea, and others are in the course of preparation. Any of these blank forms will be supplied to persons interested upon application to the Eugenics Record Office.

One of the most essential parts of the work of this institution is, of course, the study of the data, thereby making it tell the tale of the manner of the inheritance of specific traits. Here, as in other realms of science, the criteria of truth is predicability. Eugenic research seeks to answer this question: Given two parents of known ancestry and collateral kin with reference to a given trait, how will this trait be distributed among their offspring? Such work of reduction is essentially analytical or Mendelian. The mass of biometric methods avail but little in answering this question.

All work of reduction is done either by Dr. Davenport personally, or under his direction, jointly with the field worker, or jointly with the scientists in charge of the research work of the collaborating institutions. Thus far the following publications based in whole or in part upon data gathered by Dr. Davenport or by field workers trained as above described have been issued:

(1) Eugenics, C. B. Davenport (an elaboration of a lecture "Fit and Unfit Matings"). Henry Holt and Company, 1910.

(2) Heredity in Relation to Eugenics, C. B. Davenport (the text book of modern eugenics). Henry Holt and Company, 1912.

(3) Heredity of Eye Color in Man, *Science*, pp. 589, November, 1907.

(4) Heredity of Skin Pigment in Man, C. B. and G. C. Davenport. *American Naturalist*, vol. 44, November and December, 642-672, 705-731.

(5) Heredity of Hair Form in Man, *American Naturalist*, vol. 42, p. 341.

(6) Heredity of Hair Color in Man, *American Naturalist*, vol. 43, no. 508, April, 1909.

(7) Bulletin No. 1, Heredity of Feeble-mindedness, H. H. Goddard. April, 1911.

(8) Bulletin No. 2, Study of Human Heredity, C. B. Davenport, H. H. Laughlin, David F. Weeks, E. R. Johnstone, Henry H. Goddard. May, 1911.

(9) Bulletin No. 3, Preliminary Report of a Study of Insanity in the Light of the Mendelian Laws, Gertrude L. Cannon and A. J. Rosanoff. May, 1911.

(10) Bulletin No. 4, A First Study of Inheritance in Epilepsy, C. B. Davenport and David F. Weeks. November, 1911.

(11) Bulletin No. 5, A Study of Heredity of Insanity in the Light of the Mendelian Theory, A. J. Rosanoff and Florence I. Orr. November, 1911.

(12) Bulletin No. 6, The Trait Book, C. B. Davenport. February, 1912.

Other publications are in progress including one memoir on the "Nam" family, (a pseudonym given to a very inferior family in one of the isolated communities of New York State), based on field work conducted by Dr. A. H. Estabrook of this office, and another in which certain epileptic and feeble-minded families of Massachusetts are studied. This latter is based upon field work by Miss Florence H. Danielson, also of this office.

Eugenic research naturally falls into three classes:

(1) The study of the sub-normal strains and the combination of their traits into the types of the socially unfit.

(2) The normal classes and their traits.

(3) The super-normal classes and the traits of talent, special skill, and genius.

After the modes of inheritance of a great many traits have been worked but to a predicable nicety and many of the super-normal and sub-normal germ-plasms of the country has been indexed, it will doubtless be in order for society to devise some means of cutting off the supply of defectives and of bringing sterling germ-plasms together. Such efforts must, however, if intelligently directed, follow, not precede, investigation. Schemes for social betterment must, at first be experimental, but the safest experiments are doubtless based on the teachings of the greatest body of facts. Such a body of facts applicable to eugenic remedies is just beginning to be organized. The present program of eugenics is, therefore, research.

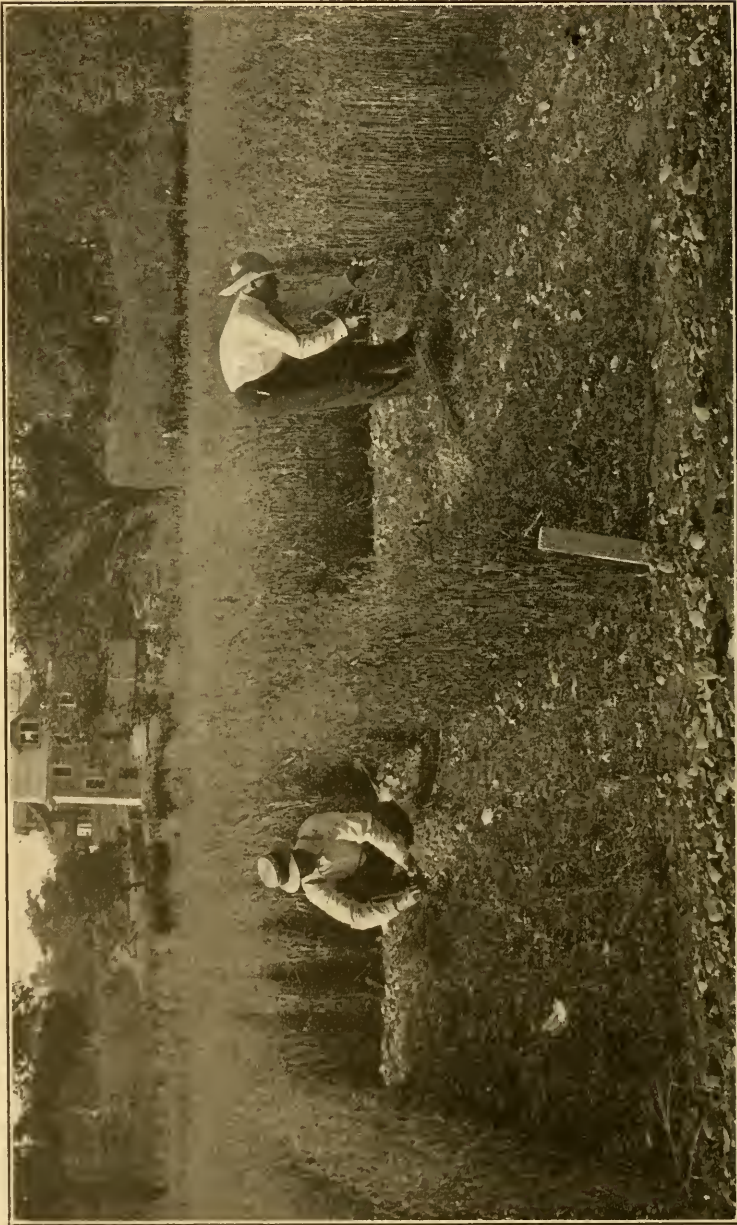

HARVESTING INDIVIDUAL ROWS OF OATS SELECTION. PLANT BREEDING GARDEN, CORNELL UNIVERSITY, ITHACA, N. Y., 1910.

THE EFFECT OF RESEARCH IN GENETICS ON THE ART OF BREEDING

HERBERT J. WEBBER

Cornell University, Ithaca, N. Y.

[CONTINUED FROM FIRST QUARTER]

Our different breeds of dairy animals are maintained in a state of high productivity by continuous selection. Cows are followed carefully with reference to their milk-producing capacity and their ability to transmit this quality to their offspring. The ability of bulls to beget high milk-producing daughters is taken as a test of their value. There can be no doubt, I believe, that this selection within the breed maintains the breed in a state of high efficiency and is absolutely necessary to the success of dairying. Strictly speaking, in the course of this selection, however, no new type has been produced. It is well recognized that continuous selection is necessary to the maintenance of high milk-producing capacity, and if the selection were discontinued the average milk production of any dairy herd would rapidly decline until it reached the normal mean for the breed concerned. The same can not be said, however, of the breed or race characters, that is those characters which distinguish the breeds or races from other breeds. Selection is not necessary to maintain the general characters of the Holstein breed, for, as long as it is not crossed with other breeds, it will in general maintain its characters so far as color, conformation, and dairy type are concerned. The same may be said of any of our breeds of cattle and horses. The high efficiency of our race horses is maintained by the most careful selection and yet probably in most cases no distinctly new character is added which would maintain itself as a unit character in inheritance.

It is true that we are dealing here with complex phenomena and limited exact experimentation and a distinct mutant in the direction of high efficiency might occur at any time and be chosen for breeding which would maintain itself without continuous selection.

It is interesting at this point to recall one of the most common differences between plant and animal breeding which is seldom clearly recognized by practical breeders. Plant breeders most commonly strive to produce new races or breeds with distinctive characters which will reproduce their desirable qualities without continuous selection; while animal breeders almost wholly limit their attention to selection within the breeds already established, to maintain them

in the highest state of efficiency possible. The failure to understand this difference in purpose has frequently led to confusion in our discussions.

It is beyond the scope of this paper to discuss the kinds of variation used in these different types of selection, even if we possessed the requisite knowledge which is doubtful. I may be pardoned, however, for digressing far enough to state that it is my conviction that there is no very hard and fast line between that variation which is in considerable degree inherited, such as is found frequently in high milk-producing cows in selection within the breed, and the mutation which gives absolute inheritance and established a permanent new mode. The great difficulty in determining whether there is any true cumulative action of selection which will extend a character beyond the limits of the race or species is met in determining what are and what are not mutations. My experience has led me to conclude that the continuous selection of maximum fluctuations in a certain direction may in some cases lead to the gradual strengthening of the character until finally it may become, more or less suddenly, fully heritable, and it would then be recognized as a mutation.

In many cases we find exceedingly small differences maintaining themselves generation after generation under different environments when the lines of descent are kept pure. A marked illustration of this is afforded by Mr. Evans' studies on pure lines of *Stellaria* reported at this meeting. The segregation of such characters in hybridization would be exceedingly difficult to recognize if it did occur. Again the occurrence of such small mutants, if we may so designate them, within a breed under selection, if not recognized and isolated, would be crossed with fluctuations and cause variations which would be recognized as regressions in the highly selected strain.

I think it will have become clear from the above discussion that in the present state of our knowledge of selection we can only advocate that practical breeders continue their selections as in the past. This is particularly true in the cases where it is the idea to maintain the race or breed at its highest efficiency. In the case of plant breeders working to produce new races, the mutation theory introduces a new element and leads the breeder to search for a mutant possessing desirable characters which he can isolate and which he may expect will reproduce its characters as soon as he has purified the type from mixtures derived through hybridization with other

types. He will select the type to purify it rather than to augment its good qualities.

Returning again to the question of new characters, we may profitably question more definitely where such new characters come from, if they are not produced by selection. Clearly no problem is of more importance to the breeder than to be able definitely to produce or cause such new characters to appear. If the breeder must await the pleasure of nature to secure the changes he desires, the waiting may be long and tedious. If he must watch thousands of plants of a certain race of species every year in order to find the apparently accidental variation or mutation in the direction of the improvement he has in mind which may rarely or never be found, the process will be so hazardous that we should have to await the accidental discovery of any new characters. Indeed up to the present time we have had practically no other recourse than to await the accidental discovery of such new characters. We, however, have had many theorists and investigators who believed that changed environment would stimulate the production of variations in the direction of better fitting the organism to its environment. Lamarck and his followers have strongly maintained this hypothesis and many scientists even today believe in the effectiveness of environment in developing adaptive changes. Breeders have carried this principle so far as frequently to advocate the growing of plants in the environment most likely to produce the change desired, as, for instance, cultivating tall plants like twining beans in the north or at high altitudes if it is desired to produce a dwarf type or, vice versa, breeding the plants in the south and at a low altitude if a giant or tall type is desired. Weissman and his school of followers have apparently exploded this idea by demonstrating that characters acquired as a result of changed environment are merely physiological changes and are not inherited. The question, however, is by no means settled and we must await further evidence.

Knight believed that increased food supply caused an increase in the range of variation and that it was important for breeders to manure their plants heavily. De Vries, on the contrary, would have us believe that such variations are fluctuations and nonheritable. The studies of Weisse, Reinhold, MacLeod, Tammes, and Love have given us many instances where the range of variation is increased as a result of food supply and other instances where the variation is apparently greater on poor or sterile soil.

It would seem that any treatment that would increase the range

of variation in plants that are grown for breeding purposes would be valuable, but it still remains to be definitely proven whether such increases in the range of variation are in any marked degree heritable and whether valuable maximum variates can be more frequently produced in this way than would be found in similar groups of plants under ordinary treatment.

It is only very recently that the idea has developed that we can go farther than possibly change the environment. With the publication of MacDougal's researches in 1906 describing mutations that were apparently caused by injecting the capsules of plants with certain solutions, such as zinc sulphate, magnesium chloride and the like, a possible new method of forcing variations was introduced. MacDougal apparently obtained, as a result of his treatments marked variations which were inherited in succeeding generations.

Tower, by subjecting potato beetles during the formation of the germ cells to extremely hot and dry or hot and humid conditions with changes of atmospheric pressure, was able to cause the development of marked changes or mutations which were found to transmit their characters true through several generations and which segregated as unit characters following hybridization. He concludes from his experiments "that heritable variations are produced as the direct response to external stimuli."

Gager has produced similar changes in plants by subjecting the developing ovaries of plants to the action of radium rays, and a number of similar studies by Hertwig and others indicate that radium emanations have a very active effect on both plants and animals.

While the evidence favoring the value of such external stimuli as the above in producing new heritable characters is apparently definite and positive, the extent to which the method can be used in practical breeding has not been determined and indeed we must await further evidence before we can finally accept the evidence, or the interpretation of the evidence, presented in these very valuable and suggestive researches. Dr. Humbert carried out experiments in my laboratory in which the capsules of a pure line of a wild plant, *Silene noctiflora*, were injected with the solutions used by Dr. MacDougal, and although the number of plants handled (about 15,000) was apparently as great or greater than was used in MacDougal's experiments, no mutations were found in the treated plants which were not also found in the untreated or check plants.

Some observations and experiments are recorded in literature which indicate that mutilations or severe injury may induce the develop-

ment of mutations. Most noteworthy among such observations are those of Blaringham, who by mutilating corn plants in various ways, such as splitting or twisting the stalks, apparently produced variations which bred true without regression and which he described as mutations. My own observations on the great frequency of striking bud variations on recovering trunks of old Citrus trees in Florida following the severe freeze of 1894-5 also furnished evidence in support of this theory.

In general, it is assumed that in hybridization we are dealing merely with characters already present and that new characters which appear are due to the different reactions caused by new associations of unit characters in their mutual effect on one another. It is, however, possible that new unit characters may result from the commingling of the different hereditary units which are to be considered as mutations rather than new combinations. As is well known, Weissman long ago advanced the hypothesis that valuable variations in evolution were due to the commingling of protoplasms from different parents having different hereditary tendencies, a process which he called "amphimixis." He did not have in view, however, the formation of new unit characters as distinct from new combinations.

The most marked case known to me of the appearance of a new character which was apparently caused by the stimulation of hybridization is the development of a marked spur or horn on the lip of a hybrid *Calceolaria* (fig. 1). This occurred among a series of hybrids between a herbaceous and a shrubby species made by Professor Atkinson and Mr. Shore, of the Botanical Department at Cornell University. One or two tapering horns about an inch in length and from 2 to 4 mm. in diameter at the base spring from the upper surface of the large corolla lip and grow erect to its surface. No such character, so far as can be learned, is known in the *Calceolarias* and it would seem to have been caused by the hybridization. It cannot, apparently, be considered as a combination of any of the known characters of the species concerned.

Such apparently new characters appear rather commonly among large batches of hybrids, and while there is little evidence available on the subject I am inclined to believe it will be found that hybridization may stimulate the production of new unit characters, which mendelize with the parental types.

While the evidence at our command regarding the artificial production of mutations is not yet sufficiently exact and trustworthy to

enable us to draw definite conclusions and formulate recommendations for practical breeders, it may be stated that this is apparently one of the most profitable lines of experimentation for the immediate future.

Thus far I have only incidentally discussed hybridization and the advance of our knowledge in this direction. The scope of this address will not allow of an adequate treatment of this subject and it appeared wiser to discuss more in detail the problems of selection and variation. I cannot, however, close this address without referring to this very important field of genetics.

No discovery in the field of breeding has had more effect or is more far reaching in its importance than the discovery of what have now

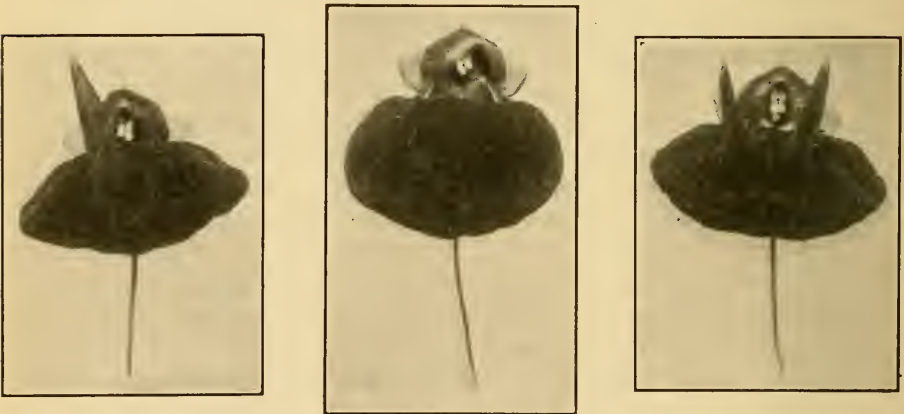

FIG. 1.—HYBRID CALCEOLARIA.

Showing the development of horns or spurs on the corolla lip. (One normal and two spurred flowers natural size).

come to be known as Mendel's principles of heredity. While, as stated in the beginning of this address, breeders had long before the rediscovery of Mendel's papers come to understand that there was a segregation of characters in the F_2 generation and that it was possible to recombine in certain hybrids the desired characters from different parents, there was no definite understanding of the underlying principles, and no conception of the almost infinite possibilities of improvement which the field of hybridization opened to us.

The law of dominance, while not universal, has explained many cases of prepotency in one generation and failure of certain individuals to transmit the character in the next generation. It has explained

many cases of latency of characters and may account for all such cases.

The law of segregation has shown us that the splitting of characters follows a definite method and that we can in general estimate the frequency of occurrence of a certain desired combination, if we know the characters concerned to be simple unit characters.

The study of hybrids has been resolved into a study of unit characters and their relation to each other. By hybridizing related types having opposed characters and observing the segregations which occur in the later generations we analyze the characters of each type and determine when we have a character pair. The researches on this subject by Mendel, Bateson, Davenport, Castle, Punnett, Shull, Hurst, Correns, Tschermak, East, and dozens of other now well known investigators have developed a science of heredity of which we had no conception a few years ago.

We can now study the characters presented by the different varieties of a plant or of different species which can be crossed with it and definitely plan the combination of characters desired in an ideal type and can with considerable confidence estimate the number of plants it will be necessary to grow to get this combination. We now know in general how characters behave in segregation and inheritance, so that we can go about the fixation of a desired type, when one is secured, in an orderly and intelligent way.

The farther the study of characters is carried the more we are coming to realize that the appearance of apparently new types following hybridization is due to recombinations of different units which in their reactions give apparently new characters. As an illustration, in a study of pepper hybrids which I have carried on during the past four years, it has become evident that the form of plant and branching is due to three pairs of characters or allelomorphs, namely; (1) erect or horizontal branches; (2) large or small branches; and (3) many or few branches (fig. 2). In crossing two medium-sized races, one with large, horizontal and few branches, and the other with small, erect, and numerous branches, there results many new combinations of characters, among which appear some with small, horizontal and few branches, which gives a dwarf plant, and others will have a combination of large, erect and numerous branches, which gives a giant plant. These dwarfs on one hand and giants on the other appear as distinct, new creations, though they are very evidently merely the recombinations of already existing unit characters and dwarfness

and giantness are the results of the reaction of the different units combined.

When we remember the large number of distinct characters which are presented by the very numerous varieties of any of our cultivated plants, we arrive at an understanding of the possibilities of improvement which the field of hybridization affords, yet I doubt if many of us have even then an adequate conception of the possibilities. Pos-

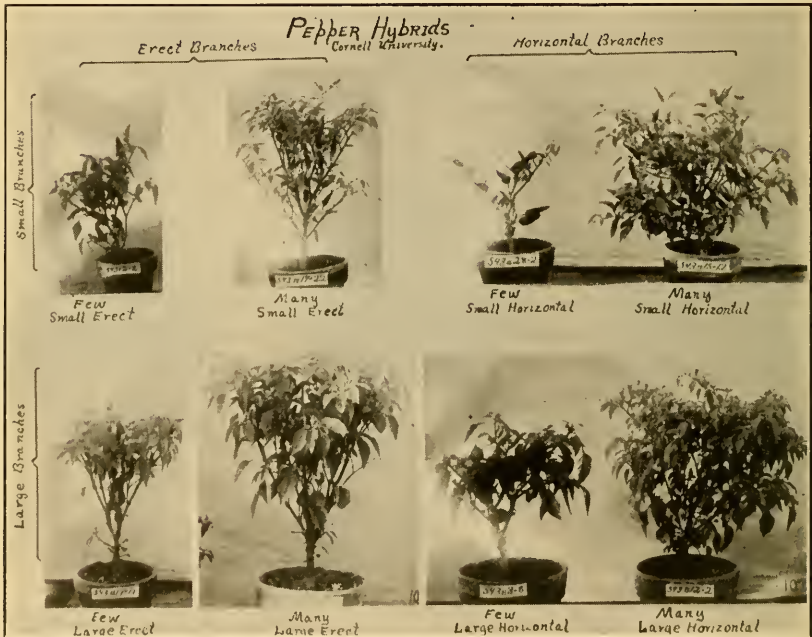

FIG. 2.—HYBRID PEPPERS (RED CHILI ♀ × GOLDEN DAWN ♂)

Segregation in second generation showing the segregation of different types of branching.

sibly I may make this more clear by an illustration from my timothy breeding experiments. While the various characters presented by the different types under observation have not been carefully studied in inheritance, the following characters can be distinguished plainly, and, from observations on accidental hybrids, are known to segregate. The following is a list of 28 such character pairs which it is believed will prove to be allelomorphs:

Timothy Character Pairs

Heads:

Long or short.
 Thick or thin.
 Dense or lax.
 Greenish or purple when young.
 Gray or tawny when ripe.
 Simple or branched.
 Erect or nodding.
 Continuous or interrupted.
 Apex blunt or pointed.
 Base blunt or attenuated.
 Seeds large or small.

Culms:

Tall or short.
 Thick or thin.
 Straight or wavy.
 Erect or bent outward.
 Green or purplish.
 Many or few.

Nodes:

Many or few.
 Green or brown.
 Internodes long or short.

Leaves:

Long or short.
 Broad or narrow.
 Erect or reversed.
 Rolled or flat.
 Clustered at base or extending to top of culm.

Habit Characters:

Lodging or nonlodging.
 Rusty or rust resistant.
 Early or late season.

It is possible that some of these characters may be expressions of the same unit, but in several cases they certainly represent several different unit characters. For instance, in length of head, height of culm, number of culms, and season of maturing, several different degrees are certainly present which are fully heritable. Doubtless there are many more than 28 pairs of unit characters which could be distinguished by careful study. If we have two pairs of characters, such as tall or short and early or late, we know that 4 pure homozygous combinations are possible. If three pairs are considered, 8 combinations are possible. Every time we add a different character pair we double the number of different combinations that are possible. Twenty-eight character pairs would thus give us as many possible combinations as 2 raised to the 28th power, or the astonishing number of 268,435,456. It would be possible then to produce this tremendous number of different varieties of timothy if there was any reason to do so, and each variety would be distinguished from any other variety by one distinct character and would reproduce true to seed.

The task of the breeder, then, is to find which among these character combinations gives the superior plant for commercial cultivation. He will soon eliminate certain characters as unimportant and concentrate his attention on those qualities that are essential.

It would be interesting to discuss the factor hypothesis, purity of germ cell, sex limited inheritance, and other important problems connected with inheritance studies, but I have already too severely tested your endurance.

As breeders and genetists we have every reason to congratulate ourselves on the rapid advance of our science and the growing recognition of the importance of the subject in practical agriculture. Colleges throughout the country are extending their courses of study to include genetics. In almost all of the experiment stations studies on genetics and practical breeding are now given fully as much attention as any other subject. With all of this advance, however, only in a few institutions have there been established special professorships or investigatorships in breeding or genetics. If the subject of genetics is to be properly taught or the investigations are to reach the highest standard, it is clear that men should have this as their special and recognized field. The subject should no longer be assigned indiscriminately to the horticulturist, agronomist, animal husbandman, or dairyman. We must establish more professorships of genetics or breeding.

REPORT OF COMMITTEE ON THE HEREDITY OF FEEBLE-MINDEDNESS^a

DR. A. C. ROGERS, *Chairman.*

Faribault, Minn.

Three institutions for the feeble-minded are employing field workers and investigating the heredity of their inmates. Of these, the institution at Faribault, Minnesota, is the latest addition. The situation there, at the time of writing this report, December 22, 1911, is as follows:

EUGENICS RESEARCH WORK IN MINNESOTA.

The Minnesota legislature, during the session of 1911, made an annual appropriation of \$5,000 for each of the two years ending August 1, 1912, and August 1, 1913, for "clinical and scientific work for the hospitals for insane, school for feeble-minded and penal institutions. The expenditure of this money is to be made under the direction of the State Board of Control. This board appointed a committee to

^a Read before meeting of Eugenic Section, Annual Meeting, A. B. A., Dec. 30, 1911.

report upon the best method of procedure. The committee consisted of Henry Wolfer, Warden State Penitentiary; Dr. H. A. Tomlinson, St. Peter State Hospital, and Dr. A. C. Rogers of the School for Feeble-Minded and Colony for Epileptics. The committee unanimously recommended that the initial work be started at the School for Feeble-Minded and Colony for Epileptics and that one field worker should be secured and started immediately. Miss Saidee Devitt was employed upon the recommendation of Dr. Davenport, secretary of the Eugenics section, and placed in the field in October, 1911. Up to the present time she has done the preliminary work on 25 cases, 6 of which have been carefully charted.

So far as the work has proceeded and a knowledge of what is proposed has been disseminated, the reaction of public sentiment has been sympathetic and favorable.

EUGENICS RESEARCH WORK IN NEW JERSEY

The State Home for Women at Vineland, N. J., has for somewhat more than a year employed a single field worker who has investigated about 40 cases from that institution. The results here, while not yet summarized, show practically the same conditions as those to be reported later from the Training School at Vineland.

At the Training School there are still three field workers. The results at the last summary were as follows: More than 11,000 individuals have been investigated and of these somewhat over 1,000 are feeble-minded. There are 22 with histories of criminal acts, while 3,000 or more are normal. There are 286 cases of tuberculosis, 180 cases of alcoholism, 31 epileptics, 114 sexually immoral and 19 histories of syphilis. These results come from the study of the families of about 300 patients. About 65 per cent of the families investigated show the hereditary taint. This material is being worked up for publication in book form. The Mendelian indications will be carefully considered. One family not included in the foregoing has been kept separate because of its peculiar character, the following results being shown:

The chart of this family shows over 1,100 individuals. There have been 41 matings where both parents were feeble-minded. They had 122 feeble-minded children, 25 unknown, 32 died in infancy, 4 died young, 4 miscarriages. Five matings without issue. Total conception 189, or 4.6 per mating. Of these children 15 were alcoholic, 1 tuberculous, 23 sexually immoral, 1 syphilitic, 1 epileptic, 1 criminal, 1 case of violent temper.

There are 8 cases where the father was feeble-minded and the mother normal; the children being 10 normal, 10 feeble-minded, 8 unknown, 6 died in infancy, 1 died young; total 35. Average per mating 4.3.

Twelve cases where the father was normal, the mother feeble-minded. Children 7 normal, 10 feeble-minded, 8 unknown, 6 died in infancy, 1 died young. Two matings without issue. Total number of children 32; average 2.6 per mating.

Both parents normal, 36 cases. Issue, 68 normal children, 13 unknown, 4 died in infancy, 3 died young. Four matings without issue. Total 89 children; average 2.5 per mating.

Sixteen cases where the father is feeble-minded and the mother unknown give 1 normal child and 24 feeble-minded, while 26 cases where the father is undetermined and the mother feeble-minded give 1 normal child and 32 feeble-minded.

There are many interesting things about this family and many items of great social importance. These are being prepared for publication and will soon be issued in book form by Dr. Goddard.

The cases in the Training School will soon have been covered in the somewhat superficial way in which they have so far been gone over, namely, for the main purpose of determining how many individuals were normal mentally and how many were defective. As soon as this work is completed the field workers will be employed to go over the ground again and investigate each family much more in detail to determine what traits that appear in the children were manifest in the parents and grandparents, with the thought of determining, if possible, what are the elements, the unit characters which taken together constitute the complex subject for mental defect, provided this is of itself not a unit character.

A method of making heredity charts which seems preferable to that mentioned in Bulletin No. 2 of the Eugenics Record Office, where rubber stamps were recommended, is in use at the Training School. Gummed labels are used on cross-ruled paper; the paper being ruled in blue, does not reproduce. These labels are prepared by the Dennison Company and there is one for each symbol necessary, viz. a square and a circle for normal, defective, and undetermined. By means of these labels a chart is quickly made and when finished is neat and accurate and ready for reproduction by the photographic method. Anyone interested in this can obtain further details and samples by corresponding with the Training School at Vineland, Department of Research.

EDITORIALS

END RESULTS IN BREEDING

On the whole substantial progress is being made both in the science and in the practice of breeding. Every person who is studying the laws of heredity, or is breeding plants, or animals, or is considering practical plans for the genetic betterment of man has his or her own bent. Each has his own viewpoint as gained by his preparation, study, and experience as to how to proceed in the phase of the subject which he has chosen to pursue. But all of us need occasionally to assume the position of the aviator and from a wide angle of vision let our minds discern which are the really large phases of the subject in which we are interested. The investigator and the breeder alike need to have their minds set upon the high points in the form of the end results. The goal of research is a constant addition to the scientific and usable knowledge of the subject. The goals of the breeder are improved forms, the increased value of which is clearly manifest.

The *American Breeders Magazine* has its peculiar niche to fill. One of its goals is to help hold the genetic workers to the task of rounding up results. The scientist in many cases, needs to be encouraged to be practical. It is better for his work and better for science that he follow one vital thing to a real conclusion than that he skim the surface of a wide range of subjects. In no branch of study is it more necessary to so repeat observations, and to study the subject from every conceivable angle, that true and broad generalizations may be made, than where living protoplasm is concerned. This being true, the investigator should use care and wisdom in choosing problems the solution of which is worth the effort. He should get close to the breeders that he may know their problems. He needs to do his research work in view of the use which may be made of his results; just as the inventor of a machine needs to know the condition under which his invention is to be used. He should be prepared to bring his labors down to the form of practical end results, useful both to science and in the practice of breeding.

In like manner the creative breeder—the person who is trying to produce a species, variety, breed, or strain superior to the available foundation stock—needs to have in mind a definite result. Here again the world will be vastly more enriched by the addition of one real acquisition in the form of a new strain, variety, or breed than by indifferent improvements in each of several species. The need is

not so much that the breeder shall have in mind the exact detail of the newly-formed variety or breed, but rather he should plan that the new form shall better meet a given definite purpose. Those who have passed through the experience of separating out the mutating networks of descent from standard or hybrid foundation stocks, as of wheat, cotton, corn, swine or poultry, and have carried some of these improved varieties or breeds to successful commercial use, know full well that a broadly practical system of selective testing places in the lead those strains whose heredity proves to give the largest value per acre, per animal, per herd or per flock, somewhat regardless of our earlier ideals. We cannot always engraft all of our ideas of form, color, or other desired character on the successful strain. We must carry to commercial use that which under our, at best crude selection, will best serve the farmer or other producer. The writer gained a general view of the problem of plant and animal breeding by employing a few dozen species.

There was need of a Burbank to give the world a zest for the interesting side of breeding and much inspiration has come from him because of the wide range of species he has employed. But the great majority of investigators will accomplish vastly more by confining their efforts to a restricted field or to a problem in which there is need of definite knowledge while the degree of improvement a breeder makes will in the long run not depend on the large number of species he undertakes to improve. And the creative breeder also should generally confine his efforts to one or to a few species. If Burbank, for instance, had spent all his efforts during the last half of his plant breeding activities, in the improvement of let us say potatoes, walnuts, and plums he would probably leave a vastly larger economic result, with a more lasting impulse to breeding than even have been his widely known results with many species.

Creative breeding is a long-time proposition and the public, and especially public boards of directors in charge of such work, should be very sure that lack of results, if such is complained of, is really the fault of the worker, before thinking of changing employees. Sometimes results come only after long efforts, and here especially is good work always cumulative. It is a waste to support a worker through a long period of preliminary training, and of accumulating and testing of foundation of stocks and of analyzing unit characters of foundation material, and then to change to a new worker. What is needed is more workers, and closer division of labor, more attention given to the improvement of individual species.

The possible end results of breeding are of such vast importance that the improvement of the heredity of living things is gradually gaining the status of a recognized public problem of large magnitude. Departments of agriculture and state experiment stations are slowly but surely gaining a strong hold upon the subject of plant breeding. They are slower in undertaking at public expense the genetic improvement of domestic animals, but in such efforts as have been made, no backward steps have been taken. And the vision both of possible practical plans for creative breeding, and of the immense economic results possible to achieve in the end, is gradually widening on the part of these institutions.

One of the least effective parts of our breeding work, with both plants and animals, is the testing of the final product offered to the grower for commercial work. There is not a sufficient number of testing stations determining the comparative values of field, fruit, garden and forest crops, and giving to the growers of each locality accurate information, which variety will under given conditions yield the largest net returns, or best meet any specific requirement. The producers of live stock are in the dark as to the relative values of breeds and families of farm animals. It is safe to say that a billion dollars more crops and live stock products would result annually if, for the past thirty years, we had been spending publicly under scientific direction a million more than has been spent privately, in testing varieties of plants and breeds of animals. The growers are not free of blame, because they are so often indifferent to proof of excellence or inferiority.

But the burden of this work is shifting to the public.

Like many problems, this comes back to a matter of education, and eventually it will pass into the hands of trained men who will create and secure the equipment and will assure the end results. The American Breeders Association's leadership through its committee on pedagogy of genetics, has done some valiant service in bringing attention to the need of trained men and to the methods of developing this as a college and school subject. Prof. Arthur W. Gilbert of Cornell University, the chairman of that committee merits wide coöperation from persons interested in this line of education. There are needed text-books of collegiate grade for those preparing to be teachers, investigators, and creative breeders. Other text-books are needed for agricultural secondary schools and consolidated rural schools. And once that subject is more thoroughly developed may we not hope to have text-books on eugenics? The new literature of

genetics is so far largely in bulletin and report form; new manuals and texts based on recent research are just beginning to appear. The promise is that this vigorous new science of genetics will ere long forge into a most vital place as both an economic and a culture subject in our educational system.

While there is every reason for our public departments of agriculture and agricultural experiment stations to take the lead in placing the science of heredity and the breeding of plants and animals on a strong basis, a large part of the work rests on the shoulders of the farmer. The producer of plants and animals in the aggregate deals with millions of individuals, at any rate with more than the experiment station researcher and breeder. On this account, and also because the grower deals with the individual plants and animals from their birth to maturity, mutating individuals may oftenest be found in commercial fields, gardens, orchards, and forests, and in the herds and flocks of the farmer and stockman.

THE INTRODUCTION OF ANIMALS

The United States Department of Agriculture has developed a world famous organization for the introduction from all countries of plants which promise to be useful under the varied conditions of this country. There are reasons why similar activities have not been so well developed in the introduction of animals. In the first place, there are relatively fewer domesticated breeds of animals in the world, as compared with the number of domesticated varieties of plants. Then, also, there was a vastly greater number of species of plants than of animal which in their native state were especially useful to man. Furthermore, the animals had a will to remain wild, an instinct to resist being restricted to one place, and so the process of domestication had to be an entirely different one. On the other hand many species of plants were at once ready for the garden or field and finding better conditions under care by man throve better than in the fiercer competition in the wild.

The introduction of animals has been left almost wholly to private enterprise. The excellence of the great breeds of cattle, horses, sheep, and swine of the British Islands and the nearby countries of west Europe made possible a profitable business for importers of pedigreed stock. And this field of animal introduction has therefore been fairly well covered. The economic results from the importation of

these improved breeds have been very large. We owe a debt of more than gratitude to the breeders of England, Scotland, the Channel Islands, France, Holland, and other countries. And by purchasing of their most popular strains we have paid large sums on this debt. Some of the fancy prices we have paid have been for animals better in individual appearance than in genetic ability to project their qualities into their progeny. But withal, in case of practically all breeds, our importers have secured a portion of the blood of nearly every long selected or mutating strain of peculiar excellence in the countries named, and while we shall continue to import portions of any newly originated strain of peculiar excellence which may arise in these breeds we already have as good or better foundation stock as have the farmers of the districts in which the respective breeds originated. In fact, in many cases, as in Holstein and Jersey cattle, in Percheron and Clydesdale horses, in Merino and Shropshire sheep, and in Berkshire swine, we have a larger number of the really useful animals of the breed, than has the old country. Our larger numbers, the wonderful scope of our domestic market, both for live stock products and for pedigreed stock, are great advantages which should enable our breeders to keep in front of the breeders of the old country as to intrinsic quality. On the other hand, we lack in the way of live stock keepers who will so nurse to perfection the individual animal and the choicest herd of the breed, as will some of our brethren in England or Scotland, for example.

Our rising agricultural science and education promise to give us the needed technique, the skill in the care of animals, and withal the ambition to create from our present grand foundations vastly better breeds. And why should not our rich live stock land become the great scientific breeding center from which to supply, at good prices choice pedigreed stock, as England and her neighbors have so long supplied the best breeding stock to nearly all other countries?

In addition to the continued introduction of the best foreign breeds we already have, there is need of the introduction of other species and breeds. A case illustrating this point is the recent introduction into Texas of the Karakul sheep, to be used in hybridizing with our common breeds in producing first generation hybrids for their fur-like fleeces. Even a more striking case is the introduction by Mr. Borden into Texas of the Brahma breeds of cattle of India which are resistant to Texas fever, and inhospitable to the cattle tick which carries that disease. These cattle are to be produced as pure breeds, and to be used in hybridizing with our native cattle. Both the pure

breeds and hybrids produce live stock products in the tick-infested South more economically than do the cattle of our other breeds which originally came from the moist, cool climate of west Europe. Mr. Borden found numerous breeds of cattle in India, and in his introduction of thirty head he could hardly have secured the strains of the several breeds which are best adapted to the respective conditions of our varied southern climate and agriculture. He has simply proven that India has breeds of cattle with certain heredity characters which produce rapidly-developing, large beeves in the presence of and quite indifferent to the cattle tick and the fever with which it infects Hereford, Shorthorns, and other European breeds.

Argentina has a breed of horses which had its origin in part in Morgan blood from our own Vermont, which might prove a valuable aid in the efforts now being made at producing a more valuable Vermont Morgan breed. Australia has in her Illawarra cattle a strain of milking Shorthorn blood which Minnesota should at once seek in her efforts at producing a really efficient dual-purpose sub-breed of milking Shorthorn cattle. East Europe is developing breeds of live stock of which we should know in detail. Here we may find breeds useful in their purity, or more likely bearing one or more unit characters needed in creating new breeds for our own use.

Our government needs men highly trained in genetic work and experienced in the breeding of each species and even of each breed; men who know the stocks of the given species or breed throughout the world. They should be familiar with Mendelian characters of the species or breed, its peculiarities, breeding, and the economic value of its strains and families. These men should have advisory and official relations to such breeders as are seriously endeavoring to create new strains and breeds of higher intrinsic value. Such men with an opportunity to aid in the general superintendence of many "breeding circuits" to improve various breeds, as noted in No. 1, Vol. III, of the *Magazine*, would become highly experienced in introducing needed new species and in placing them in their proper niche in our agriculture, to be used either as pedigreed breeds or as the partial basis of new hybrid breeds. By the successful making of new hybrid varieties, our plant breeders ere long will have gotten animal breeders over the theory that no new breeds shall be created. Then there will be no more prejudice to the mixture of the heredity of breeds in making new breeds than to the mixing of paints in making new pictures. On the other hand the indiscriminate mixing of breeds

will be more discredited than now, though the use of first generation hybrids will in many cases be adopted.

Then there is the need of introducing some species now wild. Some of the animals for which we might find use in stocking our extensive mountain pastures for instance, are certain species of small deer. We are in need of fur-bearing animals for our northern unused islands; birds which will thrive in our forests, and fish which might be more prolific in some of our streams and open waters than the species now inhabiting them.

Furthermore our fellow breeders in other countries will not be asleep in genetics and leave the field wholly to us. They will improve present breeds; will utilize first generation hybrids; will continue to form new hybrid breeds, and they, as well as we, will develop refined methods of determining and recording genuine genetic merit. We can find a large amount to do in keeping up with introducing their further improvements. They will bring into domestication more species from the wild and we shall need to secure superior samples of these newly tamed stocks.

The science of stock breeding, following the awakening in plant breeding and in eugenics, is rubbing its eyes; it is yawning, and is showing lively signs of the marvelous awakening of which it is capable. The editor remembers the apathy with which live stock breeders, and even teachers of animal husbandry, only several years back, looked upon the proposition to join the plant breeders in developing the American Breeders Association and its publications. The change in attitude has begun, and the time is ripe for a world survey of the network of animal descent which we need in our business as a nation in the production annually of four billion dollars worth of live stock which should soon be six billions.

NEWS AND NOTES

POSSIBILITIES OF ACCLIMATIZING SOUTH AMERICAN BIRDS AND MAMMALS

Recently I made a journey from Punta Arenas on the Straits of Magellan to the borders of Paraguay, noting with pleased interest the animal life of Patagonia, Argentina, and Uruguay. It seems to me that there are animals and birds in temperate South America that would thrive with us and should be given opportunity to naturalize here.

The South America ostrich lives nearly to the Straits of Magellan or did before men became so abundant. It is yet found far down in the snowbelt. It is common enough in Chubut where the climate is much as we have it in western Colorado. This ostrich is of the easiest breeding. In the fenced pastures it increases rapidly and seems quite hardy and healthy and very tame when not hunted. In Kentucky, southern Missouri, in Maryland, Virginia, and all the south country ostriches should thrive in pastures. They might afford a substitute for our turkeys, now often so difficult to rear. I saw many ostriches in villages, tamed and the pets of the peons, this in northern Argentina, and was told that they came from eggs carried in and hatched in the villages, under blankets. They are said to be fair food if eaten before they become mature, but tough eating when they are old. Their feathers are valuable for making into feather dusters. This hardy, interesting bird should appear in the parks of our wealthy cattle and horse breeders from Washington to Texas, where probably the most congenial climate would be found. In times of deep snow ostriches would no doubt need feeding with us. There would be not the slightest difficulty in introducing ostriches, since their eggs could be sent north, making the voyage in twenty-one days, hatched here with ease and reared more easily than turkey chicks.

There is a little bird that I am told belongs also to the ostrich family, the perdice. It is larger than our quail, perhaps twice as large, with a longer neck. It runs and seldom flies. It is very neat and pretty and is a very favorite game bird. It is often caught by riding it down and snaring it with a noose at the end of a stick. This bird is of great worth and ought to be in our fields. It should be liberated in Texas and Oklahoma and by experiment one could learn how far north it would endure. I saw it in the province of Buenos Aires

most abundant and there no snow falls. I do not know how far south it extends in Argentina.

There is also a much larger bird that flies like a partridge; it is highly esteemed for its flesh and would no doubt be hardy with us in the south; its name has escaped me.

Of animals, I will mention only the "mulita" (little mule), a species of armadillo about 12 inches long in body, with a tail nearly as much longer. The mulita is a harmless little beast, busy hunting for insects and roots. When one is caught it curls up and pretends to be dead. I carried one in my hands many a time when riding across the camps; its body was always delightfully warm and I used it as an animated hand warmer, turning it loose again before coming in to the headquarters of the estancias, since the peons and others eat mulitas and esteem them great delicacies. Mulitas would thrive perhaps from Washington south and could not fail to add interest to the countryside and doubtless perform service as insect destroyers and afford good food as well, if we would let them increase sufficiently for that.

There are many interesting small birds in South America that would, I hope, thrive with us. There is the oven bird that likes to build its mud oven-like nest on gate posts near dwellings. It is interesting and valuable and ought to do well in the south. It is not migratory. It would decrease the insects of the south. It has no bad qualities that I could discover. The cardinal bird, with its bright red head and crest and its cheery song, would thrive throughout our south, and there are many others that could be introduced with profit to us. Conversely, we could send them our robins; they should be at home there if they did not go in the wrong direction when time came for winter migration! There is probably no finer all-around bird than the American robin, in its song, its cheer, its homely, man-loving nature.—JOSEPH E. WING, *Mechanicsburg, Ohio.*

AN EARLY WORK WITH MENDEL'S LAW

During the winter of 1893-94, while working in the Ohio Agricultural Experiment Station greenhouse, I made about thirty crosses of tomatoes of various kinds; among these crosses was one of the Dwarf Champion \times Potato Leaf which I afterwards for no apparent reason ran out into the second generation. When in F_2 it showed very plainly segregation of units and gave me a plant of the Dwarf

Potato Leaf. This peculiar stature and form of leaf was new in tomatoes and the plant was sold to W. Atlee Burpee & Company, and introduced in 1899 under the name of Fordhook Fancy. This tomato was strictly homozygote. Although I have raised plants by the thousands I have never seen the least sign of sporting or running back. As far as I know, this was one of the first dwarfs of the tomato to be named aside from the Dwarf Champion; but there have been added quite a number since.

So plainly did this cross show where segregation takes place that I became convinced that there must be some law governing the case. In 1896, while living in Columbus, Ohio, I got hold of a new type of tomato which at the present time would probably be called a "mutant;" this tomato was introduced in 1897 by the Livingston Seed Company, under the name of Honor Bright. This tomato differs from any other kind in a peculiar yellowing of both fruit and foliage. At the present time this form of tomato has become fairly well known, as there are several forms of it, all of which I think I have had the privilege of originating from the first original one. In 1897, I crossed this new "mutant," the Honor Bright, with another new one—the Fordhook Fancy. In pondering over the work that I had done in making the Fordhook Fancy, one day the idea suddenly came to me that the combinations that go to make up the new tomatoes I wanted would be found only in the second generation, and in the first generation I would have something different from what I had used in making the cross. The cross that I had made succeeded, so, by gathering as much seed as I could the following year, I would probably find what I looked for.

The next season I planted enough seed to produce several thousand plants. What might be the total number of kinds that were produced I do not know. The practical plant breeder is interested only in the new and useful kind that may be obtained, and these I had figured out on paper before ever the fruit commenced to ripen, and when "round-up" came in the fall I had six out of a possible seven. Had I not had a fairly clear idea of the law which is now called Mendel's law I do not think I could have obtained these results. These new tomatoes were sold to the Livingston Seed Company and introduced in 1901. Tabulating the work in form of a diagram we have:

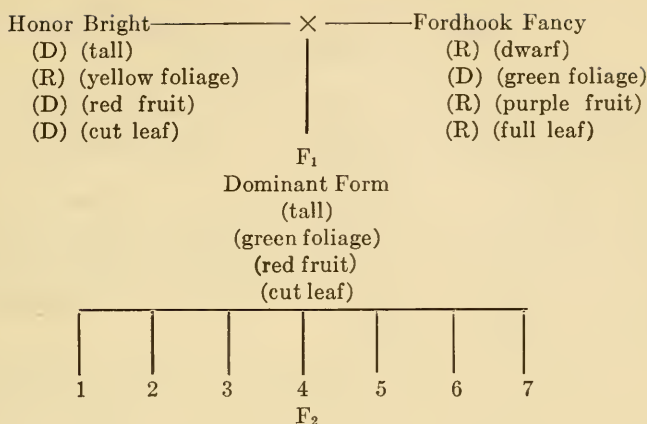

- 1 = Original form of Honor Bright, purple fruit = Livingston's Grandus.
 2 = Tall, potato leaf, Honor Bright, purple fruit = Livingston's Princess.
 3 = Tall, potato leaf, Honor Bright, red? = Livingston's Multicolor.
 4 = Dwarf, potato leaf, Honor Bright, purple = Livingston's Royal Colors.
 5 = Dwarf, potato leaf, Honor Bright, red = Livingston's Danay Dwarf.
 6 = Dwarf Champions, Honor Bright red = Livingston's Aristobright.
 7 = Dwarf Champions, Honor Bright, purple = Green's Neuevo.

Just which of these tomatoes were homozygote I do not know, although we raised No. 7 for several years and it has proven quite true to type. The fact that with help of Mendel's law one can get a new plant that will not vary, I believe to be an important one. The Resplendent tomato, introduced by John Lewis Childs in 1912, is a Dwarf Potato Leaf sort of the Honor Bright type, the fruit being of the Ponderosa-like shape and size. The scientific point of interest in regard to it is that it is a segregation—occurring in the F₂ cross. As far as I can remember, I had no plants of Honor Bright growing on my place for six years before the Resplendent came to light. Tomatoes while not absolutely self-fertilizing, cross-fertilize so seldom that I have never seen a natural cross even when different varieties were grown in the same field. I fail to see why a mutant cannot arise independently a second time, although in this case the fact that there were four plants found that carried the characters of the Resplendent is against it being called a mutant.—E. C. GREEN, *Medina, Ohio.*

*RELATION BETWEEN YIELDS OF MILK AND YIELDS OF FAT
IN DAIRY CATTLE*

The figures given in this article are taken from a master's degree thesis submitted by O. W. Reagin to the Animal Husbandry Department of the Ohio State University.

These coefficients of correlation are concrete expressions of commonly understood general relations between yields of milk and yields of fat in the dairy breeds. They relate in no way to inheritance though they may be of some use in statistical investigation of the inheritance of dairy capacity.

For Guernseys all authenticated yearly records published from 1902 to 1907 were used. Only 250 authenticated yearly Jersey records were obtainable and these cover the period of from 1905 to 1908. The coefficients for Guernseys and Jerseys are comparable. The figures from the two groups of Holsteins can be compared with each other only. Considerable numbers of Holstein yearly records can not be secured and results of 7-day tests were used. Group 1 comprises 1,000 seven-day records made between 1898 and 1902. The per cent of fat was not given in the year books and was computed from the total milk and total butter (80 per cent fat) as recorded. The second Holstein group of records were all made in the year 1908, affording a comparison of the yields of cows of this breed at two times ten years apart.

If in Guernseys, for example, the total fat yields should vary directly with the total milk yield, the coefficient of correlation would then be + 1. It was found to be somewhat less but quite uniform with similar results from Jerseys and Holsteins. The correlation between the pounds of milk and per cent of fat is in all cases a negative one showing that high milk yields are at the expense of richness in fat, or in other words that the yield of fat tends to constancy. The yield of milk and the per cent of fat are much more variable than the total amount of fat. The twelve coefficients worked out are included in the table. The means, coefficients of variability and regression will be furnished to any person desiring them.

Correlation existing between yields of milk and fat and yield of fat and per cent fat in different dairy breeds.

Breed of cattle.	Coefficient of correlation between:			Number of records used.
	Total milk and total fat.	Total milk and per cent fat.	Total fat and per cent fat.	
Guernsey.....	{ 0.8811	—3093	0.1068	558*
	{ Er. 0.0064	Er. 0.0258	Er. 0.0282	
Jersey.....	{ 0.8725	—3444	0.1319	256*
	{ Er. 0.0101	Er. 0.0372	Er. 0.0414	
Holstein I.....	{ 0.8620	—1851	0.3134	1000†
	{ Er. 0.0055	Er. 0.0206	Er. 0.0192	
Holstein II.....	{ 0.8696	—1516	0.3438	1000†
	{ Er. 0.0052	Er. 0.0209	Er. 0.0207	

* Authenticated yearly.

† Seven-day records.

The errors in coefficients are not stated as they are in no case large enough to be significant.—F. R. MARSHALL, *Ohio State University, Columbus, Ohio.*

A MILLION YEARS HENCE

It is a common practice among scientists to look back a million years; but it seldom seems to occur to them to look forward that length of time. Perhaps there is more to be gained by such a proceeding than might appear superficially. The general disposition to view the so-called laws of heredity as settled, and the progress of the animal from the primeval slime as beyond question, is apt to cause one, looking forward, to wonder how distant generations of scientists will manage to put in their time.

The truth of the matter is, that while we have discovered a few facts relating to the methods of nature's workings, the trend of recent research work and experimental investigation, have clearly demonstrated the evanescence of hastily concocted formulas. Certain well defined principles emerge to assist the breeder and supplement his practical experience. Depending upon anything further is apt to lead the experimenter off into a maze of unprofitable speculation. Dr. Wilson has shown in one of his later papers how the actual arrangement of chromosomes differ radically from the earlier conception of them. Dr. McClurg brings out the pronounced character of the germ cells of grass hoppers; and Dr. Lillie shows how the different stages of chromosomic development relate to some propensity of the entire organism. We might go on multiplying instances where some

popular biological conception had to be not only modified but radically changed.

There is much disposition to question the mutation theory in its various phases in the light of actual breeding experience as demonstrated by Prof. H. S. Bolley.

Practical breeders everywhere are beginning to find that a great deal of the experimental evidence, in favor of an indefinite multiplication of the earth's useful products, has testified to too much. They see that patient, persistent, personal effort in selection is the thing that counts.

During a million years what convulsions and changes of style will assail the cosmic conception! What discoveries and researches to undermine and disintegrate the biological stronghold! How often, think you, the biologic castle will be stormed and taken by various armies during a million years? How often established and how often contested for by warring faction?—WALTER SONNEBERG.

PUBLICATIONS RECEIVED

A LITERARY NOTE ON MENDEL'S LAW. W. W. Stockberger, U. S. Dept. of Agr. Reprint from *American Naturalist*, March, 1912. Pp. 151-157.

CONTRIBUCION AL MEJORAMIENTO DEL Caballo Para Usos Practicos. Revista De La Liga Agraria, Buenos Aires, 1911. 72 pages. Illustrated. Through courtesy of Wm. R. E. Blonin and Don Carlos Guerrero.

EXPANSION OF RACES. Charles Edward Woodruff, A.M., M.D. 495 pages. Rebman Company publishers, New York.

A review of this book, regarding the value of which the most diverse and opposing opinions exist, will be published in an early number of the *Magazine*.

THE TRAIT BOOK. Eugenics Record Office, Bulletin No. 6. Dr. C. B. Davenport, Cold Spring Harbor, N. Y., February, 1912. 52 pages, 1 text figure, 1 colored frontispiece. Price, 10 cents.

ALFALFA, THE RELATION OF TYPE TO HARDINESS. Philo K. Blinn. Bul. 181, Experiment Station of the Colorado Agricultural College. 16 pages, 14 text figures.

SECOND GENERATION OF THE CROSS BETWEEN VELVET AND LYON BEANS. John Belling, Assistant Botanist. Separate from Report of Florida Agricultural Experiment Station, 1911. 22 pages, 4 text figures.

EIGHTEENTH REPORT. NEGLECTED AND DEPENDENT CHILDREN OF ONTARIO. W. J. Hanna, Provincial Secretary, Toronto, 1911. 124 pages. Illustrated.

DELAINE MERINO REGISTER OF THE NATIONAL DELAINE MERINO SHEEP BREEDERS ASSOCIATION, Washington, Pa. Vol. VIII. 1909. 125 pages.

WOMAN AND LABOR. Olive Schreiner. 299 pages. Frederick A. Stokes Company, publishers, New York. Price \$1.25 net.

In her statement of the all too seldom realized fact that "with each generation the entire race passes through the body of its womanhood as through a mold, reappearing with the indelible marks of that mold upon it," Olive Schreiner strikes the keynote of her great book, *Woman and Labor*, which is at once one of the most logical, the most appealing, the most biologically convincing, and the most deeply-founded of all the literature which has attempted to deal with the so-called "new woman problem."

Sketching lightly, yet with bold and certain strokes, she draws a picture of the evolution of the human race with woman's part therein, showing that from its very infancy woman has served the race and the common good side by side with man and that in addition to her most important function of incessant child-bearing she has also performed her full share of the labor of supporting the race and of carrying it onward in its appointed path of progress. By many historical citations the author shows that races have held their own in the great battle for existence only so long as their women have labored—have exercised to the full all their qualities of heart, hand, and brain, and that when a race has become so opulent that it was no longer necessary for the women to labor, and when as a result the women became to a greater or a less extent parasitic, that race, producing through its weak and inefficient womanhood correspondingly weak and inefficient men, has gone down before other races whose women were still laboring women—strong in mind and body—virile, efficient, worthy of motherhood. To quote from the book itself: "Only an able and laboring womanhood can permanently produce an able and laboring manhood."

By a comprehensive outline of the economic progress of the ages, Miss Schreiner shows how woman's natural duties have, one by one, been taken from her: how for the spinning-wheels of an earlier generation are now the great steam-driven looms of our factories; for the hoes and grindstones of our earlier agriculture which it fell to the women to tend while the men fought and hunted, are now powerful agricultural implements, man-managed and often steam or electricity driven; how factory-made garments and factory-canned or prepared foods day by day usurp more and more the place of women as useful laborers, "while among the wealthy classes the male dress-

designer with his hundred male-milliners and dress-makers is helping finally to explode the ancient myth that it is woman's exclusive sphere, and a part of her domestic toil, to cut and shape the garments she or her household wear."

Even woman's great labor of child-bearing is being more and more restricted as the race progresses. Since, under modern conditions, our race is no longer decimated by plague, pestilence, famine, or continuous war, incessant child-bearing is no longer demanded of woman. From having been in times past her greatest duty it has come to pass in our present day that "child-bearing and suckling, instead of filling the entire circle of female life from the first appearance of puberty to the end of middle age, becomes an episodal occupation employing from three or four to ten or twenty of the three score-and ten years which are allotted to human life. In such societies the statement (so profoundly true when made with regard to most savage societies, and even largely true with regard to those in the intermediate stages of civilization) that the main and continuous occupation of all women from puberty to age is the bearing and suckling of children, and that this occupation must fully satisfy all her needs for social labor and activity, becomes an antiquated and unmitigated misstatement."

"Looking around then, with the utmost impartiality we can command, on the entire field of woman's ancient and traditional labors, we find that fully three-fourths of it have shrunk away for ever, and that the remaining fourth still tends to shrink."

With these great fundamental truths as her text she makes an impassioned appeal that for the good not of woman alone but of the entire race all fields of labor—scientific, educational, social, economic—be opened to her; that, having travelled the path of human progress thus far side by side with man, it shall not be denied her to go still farther by his side, developing as he develops and, by her own development, reacting upon the race in the production of still stronger generations of men in the years to come.

Taking the splendid ground of racial necessity, she demands that woman be not forced, by the narrowing of her former fields of labor and by the closure to her of all other fields, into a degrading parasitism, and declares the incontestable fact that: "If, at the present day, woman, after her long upward march side by side with man, developing with him through the ages by means of endless exercise of the faculties of mind and body, has now, at last, reached her ultimate limit of growth, and can progress no farther; that, then, here also,

today, the growth of the human spirit is to be stayed; that here, on the spot of woman's arrest, is the standard of the race to be finally planted, to move forward no more, forever: that, if the parasite woman on her couch, loaded with gewgaws, the plaything and amusement of man, be the permanent and final manifestation of female human life on the globe, then that couch is also the deathbed of human evolution."

In the face of these truths, that man or woman must be much more foolish than brave who would dare to stand in the path of any woman who, the traditional fields of woman's labor having failed her, asks permission to exercise her powers in any new field to which her talents or preferences may call her. The author has in this book contributed not only a social document, but unawares perhaps, a strong eugenic one. And whatever personal views one may hold regarding the woman's movement, one cannot get away from the fact that this book presents a number of eugenic questions from an entirely new viewpoint.—HATTIE M. WILSON.

THE HEREDITY OF RICHARD ROE: A DISCUSSION OF THE PRINCIPLES OF EUGENICS. Davis Starr Jordan, President of Leland Stanford, Jr., University. 165 pp. American Unitarian Association, publishers, 1911. Price \$1.20 net.

For a panoramic view and a popular and readable statement of the subject of Eugenics we have not yet seen anything which so well covers the ground as this little book. The title would lead one to believe that it is a novel with a problem hidden between its leaves; whereas it is a book on eugenics purely so—Richard Roe being a lay-figure, which helps us to think out the problem in concrete terms.

One fact which recommends *Richard Roe* to the reader, whether he be a general reader or a scientist, is, that the book is not a scientific one; and yet the subject is treated from the modern viewpoint, and the facts of science are presented together with a ripe philosophy of life, and with touches here and there of subtle wit. Its epigrammatic style makes the book entertaining and one reads it with as much tension as a story. Here are a few quotations from the text:

"The purpose of the study of Eugenics is to know the kind of ancestors we should pick for the next generation. . . ."

"A good stock is the only material out of which history can make a great nation. . . ."

"In spite of the facts of race suicide, and the number of foolish wives and broken families, motherhood was never so highly esteemed in civilized races as it is today. . . ."

"The gilded youth and the smart set are not typical of American manhood or womanhood and Richard Roe is not of their kind, for he belongs to a type that lasts. . . ."

"In the instant of conception, the gifts of life are granted. . . ."

"On the other hand unexpected glories sometimes arise from the happy mating of these common folk whose characters chance to supplement each other. . . ."

"Among men there have always been those to whom the art of living was impossible. . . ."

No doubt, the largest number of persons who concern themselves with eugenics see it chiefly in its broader light, and its sociological significance, and less in its relation to self and the individual. The author himself seems to have been strongly impressed by the former viewpoint and made it the dominant note in his book, which goes forth from a glance at the subheads of chapters, as instance, a few, taken at random: Race Decline not Collective, Race Decadence, The Poor Whites, Poverty and Pauperism, Paupers or Parasites, Corruption Fund of Public Charity, Foreign Immigration, Future of the Republic, Slavery, The Slums, Luxury, The Higher Foolishness, The Mind of Nations, Breeding of the Superman, All Englishmen of Royal Lineage, The Wholesome World.

Some defects we are quite willing to overlook; thus certain portions of the book bear evidence of either, haste in writing or at any rate lack of painstaking editing; at times the argument does not seem to be fully built out.

THE HORSE, HIS BREEDING, CARE AND USE. David Buffum. 160 pages, 5 inches by 7 inches, 7 text figures. Outing Publishing Company, publishers, New York, 1911. Price, 70 cents.

A treatise on the horse in narrative style, which makes it quite readable. It is evidently written by one who knows his subject well, and the thirteen short chapters abound in useful suggestions as to curing of vices, shying, the education of the colt, treatment of certain cases of sickness, shocing, etc.

The author very aptly states that "horses vary in character and disposition as much as human beings do and come by their traits in the same way—by inheritance. The disposition of a horse seems to be inherited more from his dam than his sire."

The author is strongly of the opinion that "meanness and viciousness in horses can best be avoided by not breeding it into them. Even if such horses can be subdued and made useful, is it worth while to raise them, if others without these undesirable traits can be raised.

There is a very interesting chapter of about twelve pages on "Our Debt to the Arab" narrating the fascinating story of Godolphins Arabian (in Tunis, Scham and Agba, his keeper).

Horse lovers and horse raisers will do well to add this book to their collection of horse literature.

"TOMORROW." A play in three acts, by Percy MacKaye. 176 pages. Frederick A. Stokes Company, publishers, New York. Price, \$1.25 net.

After the reading of this play one cannot fail to be impressed that in this the stage entered the field as a great moral teacher. In "Tomorrow" the author has cleverly and successfully presented one of the big and striking facts of eugenics, precisely as the thinking and seeing observe it enacted daily in real life. There is not a word or an incident which is overdrawn.

The story is simple—love of a woman for a man who had earlier "sowed his wild oats." Her first impulse is to follow him despite all; eventually her training asserts itself and she exercises the rights of her enlightened womanhood and drops the physically poisoned thing for a pure man.

The action of the play is laid in southern California, on the farm of a plant breeder, and the philosophy of selecting, of hybridizing, or of Mendelism and the accomplishments of plant breeding are cleverly and instructively woven into the play.

A characteristic sidelight is given of the attitude of the "practical man," who asks for the meaning of eugenics. A little blind girl is introduced into the play, apparently standing as a living answer to his question. It is probably the first time that the word "plant-breeder" is used in a literary production, and we feel especially grateful to the author for using this word. It is good, it is correct, and the public may as well now learn its meaning and become accustomed to its use. If the author had been a bit more of a scientist, he would have seen that by judiciously drawing upon a few more of the marvelous facts of heredity he could have greatly strengthened the play and added to its general interest.

The central thought of the play is this: That once eugenic truth is taught to women, the race will through them be regenerated, and progress to a new and wonderful human race be assured.

Only six principal characters enter into the play; a select company should be able to make a powerful and appealing presentation of it.

REFERENCES IN CURRENT LITERATURE

PEDIGREED NURSERY STOCK: Circular 18, New York Agricultural Experiment Station. An address given at the meeting of the New York Fruit Growers, Rochester, N. Y., January 5, 1912, by Prof. U. P. Hedrick, Geneva, N. Y.

The author questions the value or rather the commercial practicality of "pedigreed nursery stock." The ground he takes is "that there is nothing to gain even though there be a scintilla of truth in the claims of those who would have nursery stock sold with a pedigree," and "that a fruit grower can spend his time to better advantage than in attempting to breed fruit trees by selection."

In support of this view the author contends that individual seedlings grown from seed of the same plant may vary greatly. On the other hand a bud or a graft is literally a "chip of the old block" and while plants grown from buds may vary because of environment they do not often vary through heredity. "And in case of the occurrence of such a variation, only trial can determine whether or not it is heritable." There is no evidence to show that the total variations, due to "the richer soil, more sunlight, better care, the greater freedom from insects, and diseases, the longer season can be transmitted from parent to offspring. The fruit grower who wants to perpetuate such variations must renew for each generation the conditions which gave him the desirable traits. It is a question of nurture, not nature."

Summing up some of the difficulties standing in the way of pedigreeing fruit trees, the author fears that "opportunities for dishonest practices would be greatly multiplied. If pedigreed trees become a vogue, tree-growing must become a petty business. Climate and environment would permit nurserymen who are growing pedigreed stock, to propagate only a half dozen varieties of any fruit."

"Fruit trees are not sufficiently well fixed in their characters to make selection from single 'best trees' worth while even should their characters be transmissible."

"The burden of proof is upon those who advocate pedigreed trees, for the present practices of propagating fruit plants are justified by the precedents of centuries."

THE BEST COLOR FOR HORSES IN THE TROPICS. Lieut. Col. Charles E. Woodruff, Med. Corps, U. S. Army, Journal of the U. S. Cavalry Association, September 1911. Pp. 243-263.

Dr. Woodruff has been persistently pursuing the question of the influence of light on living matter and since the publication of his *Expan-*

sion of Races, and *The Effect of Tropical Light on White Man* has in various writings added facts of material values until he has succeeded in bringing together an amount of data which command attention, particularly because of their practical value. The article under consideration is written mainly with the view of eliciting further information on the matter of skin and hair color of horses, mules and cattle for tropical countries and incidentally of all stock much exposed to sunlight.

Dr. Woodruff maintains that "a few belated physicians still profess to believe that nature made a mistake in pigmenting living forms in light countries, but that is no reason why men should be so foolish as to try to acclimatize where God cannot do it." "Acclimatization is now used only by ignoramuses."

He believes that in transferring stock of whatever kind, from one climate and latitude to another, skin and hair coloring is an item that must be considered. If not, the lethal effect of light will effect a selection by killing of the least fit and this is true in tropical countries, climates with intense sunlight, or even large cities where during "hot waves" conditions exist, resembling those in tropical climates.

Best adopted in the tropics are animals with white, gray or sorrel, or mud colored hair and black skin, while for animals in the north temperate zones the best are black skins with either white or light coats.

A NEW SCIENCE AND ITS FINDINGS: Some disconcerting discoveries by Karl Pearson; Albert Jay Nock. *The American Magazine*, March, 1912. Illustrated with portraits. Pp. 577-583.

An article describing the progress of the study of eugenics in England and making "a plea for the organization of eugenics in this country." The writer displays an amazing lack of information concerning the status of eugenics study and organization in America. We cannot conceive how he can be ignorant of the organization of the American Breeders Association with its three great sections of breeders of plants, breeders of animals, and eugenists. In fact, there is not in all Europe an organization of similar scope. Without discounting the splendid work which our English friends have been and are doing, and the superb body of knowledge of "Rassenkultur" being built up by German scientists, it may in justice be said that America is not lagging behind.

The Eugenics Record Office is a permanent base for the collection and study of eugenic fact. It is, so far as our knowledge goes, the

only eugenics institution having a staff of field workers. There are ten special eugenics committees, composed of men of whom each is an authority in his special line. The *Magazine* presents a great variety of genetic and eugenic subjects in a popular way and the Annual Report contains all the scientific and technical contributions from members. Under the leadership of members of the Association, the formation of eugenic clubs at the important educational centers is being inaugurated.

This in brief is the present status of the organization of eugenics in this country, and we most strenuously take exception to the heedless statement of the writer, who assumes to know what eugenicists are doing in this country, but does not.

Mr. Nock suggests: "Let us divert if necessary, a little of the endowment that goes so prodigally into the multiplication of veterinarians, lawyers, dentists, engineers, and doctors, and endow an investigation into the workings of cause and effect upon our supply of men." He is in this only partially right. Funds are needed for research work in general genetics as well as in eugenics. Space is too limited here to explain why this is so.

DIE KARAKUL SCHAFE (The Karakule Breed of Sheep). H. Kraemer Hohenheim, Germany. April 12, 1912, number of *Mitteilungen der Deutschen Landwirtschafts-Gesellschaft*.

In an interesting article, the author reviews the recent contribution to the literature of breeding of karakul sheep by Professor Adametz of Vienna, Austria. This part of the sheep industry has been the object of discussion for many years, but the German with characteristic conservatism and circumspection has never risked going into it on a business scale. Professor Adametz of Vienna, Austria, found that karakuls are extensively bred and valuable furs produced in the Crimea, South Russia and Bosnia. Good results have been achieved at Gross-Engersdorf and at the imperial Thiergarten at Schoenbrunn, Austria. The conclusions which the author draws from all available Russian and Austrian experiments are here condensed very briefly as follows:

That there is not demonstrable any influence of either climate or soil of the steppes of Bokhara and Chiwa, on the quality and amount of "curl" of the skin of the Karakul lamb.

That a deteriorating influence of European climate and feed on pure European bred Karakuls is not observable.

That the characteristic "curl" and "penciling" of the fur is a mendelian character, which had originated probably by mutation.

That this character was probably strengthened by selection, and is capable of still further improvement by the same method.

It seems as if the German farmer was preparing in his systematic and irrepressible way to add a valuable industry to his agriculture. It is chagrining to say the least, that the United States exports annually millions worth of fine furs and skins, but *all as raw material*. Leipzig is the market center of the world's fur trade and our best and costliest skins go there and are reimported after being made valuable by skilled artisans who receive apprenticeship and industrial training in the excellent trades schools of that country. Now the Germans seem to have decided in their own minds that the curl and penciling in the Karakul wool is a unit character and is independent of climate or soil and that those valuable skins can be grown to as great perfection in Mecklenburg as in Bokhara. We would misjudge their proverbial thrift greatly, if they will not exploit that important fact. Here is another side. Does not all this illustrate forcibly the need in this country of a public service organization like the American Breeders Association? And ought not this Association to have at its disposal funds for the study of such and similar questions, which are too expensive and too complex for individuals to undertake, and for study of which it is as a rule difficult to obtain public money?

THE TRANSMITTING POWER AND INFLUENCE OF THE DAM IN DEVELOPING A HIGH CLASS HERD OF PUREBRED DAIRY CATTLE. Charles P. Reed. In the *Michigan Dairy Farmer*, Vol. III, No. 47, February 24, 1912. Pp. 3-6.

WHAT WILL YOUR CHILD INHERIT? Ethel C. Macomber. *Delineator* for April, 1912, with a foreword by Dr. C. B. Davenport.

DISSEMINATION OF PUREBRED GRAIN IN WISCONSIN. *The Farmer*, St. Paul, Minnesota; No. 10, March 9, 1912. Pp. 363-364.

THE RED SUNFLOWER. Prof. T. D. C. Cockerell. *Pop. Science Monthly*, April, 1912. Pp. 373-382.

Journal of Genetics, Cambridge, England.

Contents of February number, 1912:

The history of *Primula Obconica*, Hance, under Cultivation. Arthur W. Gilbert.

Account of Family showing Minor Brachydaetyly. H. Drinkwater.

A Critical Examination of Recent Studies on Color inheritance in Horses. A. H. Sturtevant.

A Further Contribution to the Study of Right and Left-handedness. (Torsion in plants.) R. H. Compton.

ASSOCIATION MATTERS

THE A. B. A. IN FOREIGN COUNTRIES

A most gratifying feature connected with the development of the American Breeders Association is the appreciation of its work by foreign scientists and breeders. The steadily growing world population is making the problem of food supply a formidable one in all countries

The question of enhancing the breeding values of the world's food-supply—plants and animals—has a decidedly international aspect and although bodies of men have organized in nearly all countries into societies serving in each respectively, purposes similar to those of the American Breeders Association in this, it seems, as if the American Breeders Association were universally recognized as the agency most largely concerning itself with that question. At least, that is the only interpretation we can place upon the fact, for instance, that ten per cent of the total membership of the Association are in foreign countries; or the further fact that eighteen per cent of the life members are in foreign countries.

The latest substantial addition to the foreign contingent of our membership comes from Russia. Nine new memberships were sent in by Mr. Basil Benzin of the Department of Agriculture at St. Petersburg, Russia, making the total number of our members in that country fourteen.

Two years or more ago you influenced me to join the American Breeders' Association. The publications have been received regularly and looked over somewhat, although the greater number of articles have been of too technical a nature to be of special interest to me. But in the preparation of a paper which I recently read before the meeting of the Western Michigan Holstein-Friesian Association I found a wealth of good material in the magazines. The information which I was enabled to give has been of such interest that the paper has been widely advertised and republished a number of times.—C. P. REED, *Secretary West Michigan Holstein Friesian Association, Howell, Michigan.*

Volume VI of the Annual Reports has been received, and, to say the very least about the material which it contains, I consider my membership fee better spent, or invested rather, than anything I have ever yet invested.—JOHN C. THYSELL, *Dickinson, N. D.*

You may rest assured that I will always be more than willing to subscribe \$2.00 a year for the excellent publication that is gotten out for the American Breeders Association under your efficient direction. Their worth is many times this amount to me.—M. M. JARDINE, *Professor of Agronomy, Kansas State Agricultural College, Manhattan, Kas.*

THE AMERICAN BREEDERS MAGAZINE

"Compared with him who has the power to conceive an ideal animal form and call it into life, through a profound knowledge of nature's intricate and hidden laws, the greatest sculptor is a mere mechanic."—A. H. SANDERS.

Vol. III

Third Quarter, 1912

No. 3

NEHEMIAH PARKER CLARKE, 1836-1912

Nehemiah P. Clarke of St. Cloud, Minnesota, one of the strongest breeders of pedigreed live stock in the United States, died on June 29, 1912. Interested primarily in merchandising and lumbering, Mr. Clarke gradually developed his talents as a breeder of live stock until this became his main business. The *Breeders Gazette* truly says of him: "As a constructive breeder of draft horses and beef cattle, it is doubtful if this country has produced his superior."

The pioneers in breeding as in every other calling, have filled a large place in American life. In nearly all cases they have been self-made men who have won because of sheer force of personality, and because of peculiar fitness for their especial business. We have no better example of this kind of live stock pioneer than Mr. Clarke. His achievements are not as well known as they would have been had he done his work more nearly in the center of the great live stock region of the middle west. He was located in the northern zone of live stock business, but in spite of that fact won not only a national but an international reputation as an importer and especially as a breeder of several classes of pedigreed animals.

While he bred other classes of live stock, his chief reputation came to him through his Shorthorn cattle, Clydesdale horses and Galloway cattle. For many years, in each of these three lines, he had kept on his three farms near St. Cloud among the largest and very best groups of females to be found in this country.

His Columbian World's Fair winnings in Clydesdale classes from his Clyde Mains Farm first attracted attention to Mr. Clarke's ability in assembling and breeding live stock. During later years the winning at The International Live Stock Expositions of international herd championships for Shorthorns, bred on his Meadow Lawn Farm, again emphasized the fact that Mr. Clarke had built up a great breeding establishment. His achievements in building up a splendid herd of Galloway cattle stood only second to his work with Clydesdale horses and Shorthorn cattle.

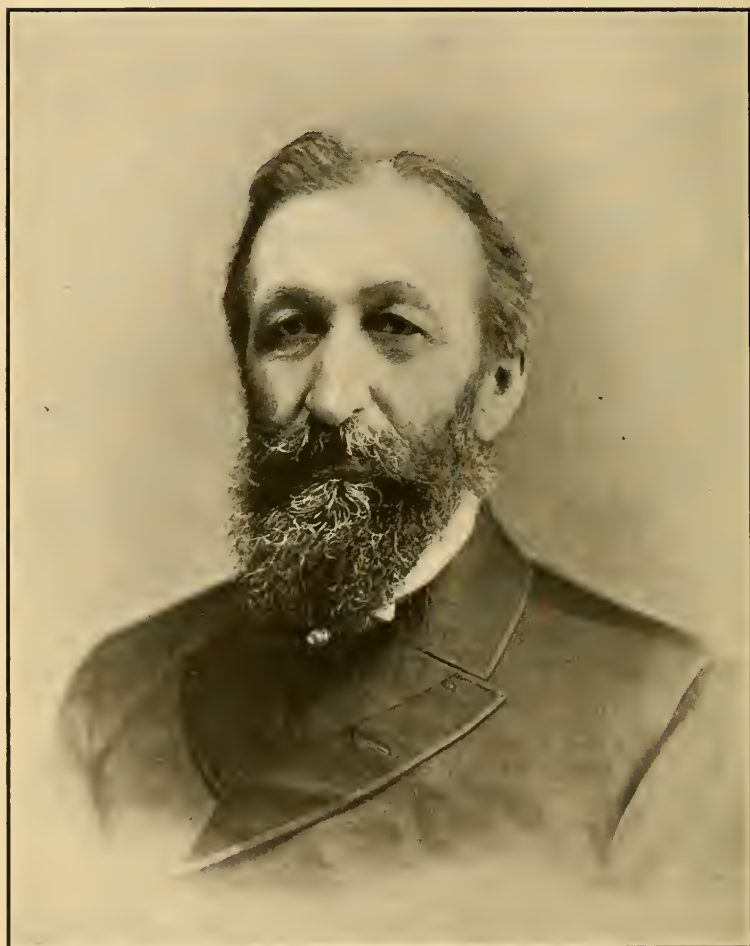

NEHEMIAH P. CLARKE

One element of Mr. Clarke's ability as a breeder was shown by his leaving the splendid collection of stock he had built up, in the hands of those who can continue the brilliant work he did in his life, so that the blood which he had assembled should be kept as a constant wellspring of new value to be multiplied and distributed to those who produce live stock. Too many of our breeders gain a state-wide or even a nation-wide reputation for herds which contain splendid individuals, and are splendid in their usefulness in producing breeding animals for sale, but at the death of the breeder the herds are dissipated.

Equal to, if not greater than Mr. Clarke's public service as a breeder was his work in connection with the development of agricultural organizations in his state. As President of the State Agricultural Society a third of a century ago he was the leader in securing and building up the magnificent State Fair Grounds between Minneapolis and St. Paul. In his work of organizing agricultural institutions Mr. Clarke was long associated with Mr. J. J. Hill. It was largely through their influence that the branch experiment stations and agricultural high schools were extended throughout Minnesota. Mr. Clarke was one of the leaders who stood for the establishment of the first agricultural high school in this country, at St. Anthony Park on the Minnesota Agricultural College Farm. He was interested to the end, in all measures to put forward the education of farm youth and of the mature farmers. He was a powerful factor in inducing the authorities to build up agricultural as well as general education for the farm youth of Minnesota. He was one of the most vigorous of those American business men who have aided the newer education to break away from the old academic learning of a third of a century ago. There should be placed for him a statue at Minnesota's University Farm, that those who reap the benefits of his life may know of his work as a breeder and as a worker for country life betterment.

Mr. Clarke was born in Massachusetts in 1836. He went west and, after a brief experience in Fond du Lac, Wisconsin, entered the mercantile business in St. Cloud, in 1836. He was long engaged in the transportation of government supplies between the Mississippi River and the Black Hills and for many years was extensively engaged in lumbering. During the last thirty years he gradually withdrew from most of his other enterprises and devoted himself to his three farms with their herds of pedigreed live stock. W. M. HAYS.

THE ILLAWARRA BREED OF DAIRY CATTLE

FRANK McCAFFREY

Kiama, New South Wales, Australia

Illawarra, New South Wales, embraces the eastern portion of the County of Camden, and the northern portion of the County of St. Vincent; bounded on the north by a line west to the head of the Cataract River, commencing on the sea shore near Bulli; on the west by the Illawarra range, thence straight to the middle source of the Kangaroo River; thence by that river to its confluence with the Shoalhaven River to about 2 miles south of the Warreamungo; on the south by the range north of Endricko River to the source of Yalmal Creek and again by a range to Lambe Grant—(Jervis Bay); and by the eastern shore of St. George's basin to Sussex Haven and thence by the sea shore, which forms the eastern boundary to Bulli, as aforesaid. The eastern face of the Illawarra range consists of numerous gorges.

Illawarra is a beautiful, fertile, romantic district between 50 to 90 miles from Sydney, covering about 250 square miles. The Illawarra Mountain is a lofty and precipitous range running parallel to the coast, and supporting the elevated table-land to the westward. Looking from the mountain toward the sea the views from a hundred different outlooks are indescribably beautiful and magnificent. The district proper consists of a belt of land enclosed between the mountains and the ocean, increasing in breadth to the southward. It was originally thickly wooded, and for the most part exuberantly fertile. In a word, nature did everything possible for Illawarra, on which mankind has lived without doing anything in return for upwards of eighty years. Baron Hugel, an Austrian gentleman, who resided some time in New South Wales, devoting himself to scientific research, observed that the scenery and vegetation of Illawarra strongly reminded him of scenes he had visited in the interior of Ceylon. Kiama, the center of the dairy industry in Illawarra, is situated 90 miles by road and 70 miles by railway south of Sydney.

The origin of our Illawarra dairy cattle takes us back to the year 1816. Illawarra was then in its virgin state just what a man of science would keenly appreciate, a display of natural harmony, unity in a multitude of variety; the delicate balance sustained for the time being by the addition of the very best strains of horses



FLOWER, I. D. C. A. HERD BOOK.

This cow can be traced forty years in direct line from the Evans & McGill strains of dairy cattle.



MILK MAID, 225 I. D. C. A. HERD BOOK.

Official one-day test: Morning, 36.50 pounds milk; 4.3 per cent butter fat. Evening, 35 pounds milk; 4.9 per cent butter fat. Commercial butter per week, 25.75 pounds.

and cattle that money could purchase in England. Prior to 1816 Major Johnson, Captain Macarthur, Dr. Throsby and Messrs. De Avey Wentworth, James Badgery, Robert Jenkins and others received grants of land from the government together with stock and convict servants in the vicinity of Sydney. The success of these early experiments was phenomenal, and stock of all kinds increased and multiplied in numbers and quality beyond all expectation. The second duke of Northumberland sent this friend, Major Johnson, a great gift of breeding horses and cattle. Major Johnson had obtained on the banks of the Macquaria Rivulet which empties into Illwarra Lake a grant of land that consisted of rich alluvial flats and sloping open ridges, known as open forest land. No better country could be selected in Australia for a stock farm. The other gentlemen just mentioned quickly followed Major Johnson with stockkeepers, surveyors, timber getters and herds of breeding animals. Hence by the time the mid-twenties of last century were reached, there were in Illwarra valuable herds of Durham, Longhorn, Shorthorn, Hereford, Devon, Holderness, Red and Dun Colored Polled, and Ayrshire cattle all doing well and increasing and multiplying by hundreds annually. Very little change took place in the system of cattle raising during the next twenty years. Here the stud animals were bred for the fast increasing inland stations. Many men with capital had settled in Illwarra just prior to 1840, when a flood of immigration set in which displaced the convict system of the past. This period marked the beginning of dairying in Australia, as an industry, and it is from this date that Illwarra men date the foundation of their breed of dairy cattle.

Having watched the several developments in dairy cattle breeding in Illwarra for a period of fifty years, I can safely say that many of our best types of cows and bulls appeared to be mere accidents of birth. Notwithstanding all that human art has done in the past, soil and climate seem to have been favorable to the production of a distinct type of dairy animal. So much perplexity surrounded every scheme of breeding and mating dairy cattle, from any point of view that, from the moment I grasped Mendel's Laws of breeding to this day, I have done naught but reflect on the breeding of our best families of Illwarra dairy cattle. For example, take the breeding of the tall and dwarf peas as explained by Mendelism. In Illwarra as long as I can remember we had a tall lengthy well-developed family of cattle. These cattle were evolved from crosses of the old Longhorned breed with the Shorthorn. They



PINK PEARL, 269 I. D. C. A. HERD BOOK.

Official one-day test: Morning, 38.5 pounds milk; 4.2 per cent butter fat. Evening, 38.6 pounds milk; 4.8 per cent butter fat. Commercial butter per week, 28.14 pounds.

were called Longhorned-Durham and were mostly of a strawberry color. They were splendid dairy cattle, perhaps rather coarse in the bone, and standing high off the ground. At one time there were thousands of this type of animal in New South Wales. Contemporary with that there was to be found in perhaps greater number a low-set red dairy cattle, evolved from crosses of the Devon and Ayrshire breeds. Now, I contend that by mating those two distinct and to some extent opposite types of cattle, we have produced our best strains of dairy cattle by striking a happy medium. This however must be borne in mind: Productiveness and udder formation has been the aim and object of our Illawarra dairymen for upward of seventy years. With regard to putting udders on their female progeny the imported English Shorthorns have been lamentable failures in Australia during the last forty years; hence the formation of the Illawarra Dairy Cattle Association which has for its object the preservation and conservation of the remaining types of the old strains of cattle. We think that when the dairymen come to understand the practical application of the laws of heredity, good results will follow. No doubt many of our most successful dairymen have been working for years on the simple plan of selection and crossing with the best types of the Shorthorn and Ayrshire breeds and it goes without saying that there are crosses of various kinds being worked into the modern milking types of both these breeds.

These methods were carried too far in Illawarra about thirty years ago and many dairymen became possessed of the pure Shorthorn craze and purchased station-bred Shorthorns and used them in their herds which procedure resulted in loss of udder capacity among their progeny, combined with other undesirable characteristics. Notwithstanding the great disaster wrought in our dairy herds by the introduction of those pure bred Shorthorn bulls there are still some of our dairymen to be found clinging to the "Flesh Pots," simply because the progeny of these beef bulls which have had pure Ayrshire dams look well in the show ring, and occasionally sell well. Dairy farming is not carried on in Illawarra for the mere sake of breeding show animals, it has an end beyond that. We may therefore anticipate that when Mendelism comes to be fully grasped by our Illawarra dairymen they will become its devoted students. Much of the every day observations on the farm confirm its simple rules and this will quickly appeal to common sense.

If we now turn from the science and the art of breeding to the purely practical, we may still see that beauty of form consists in the

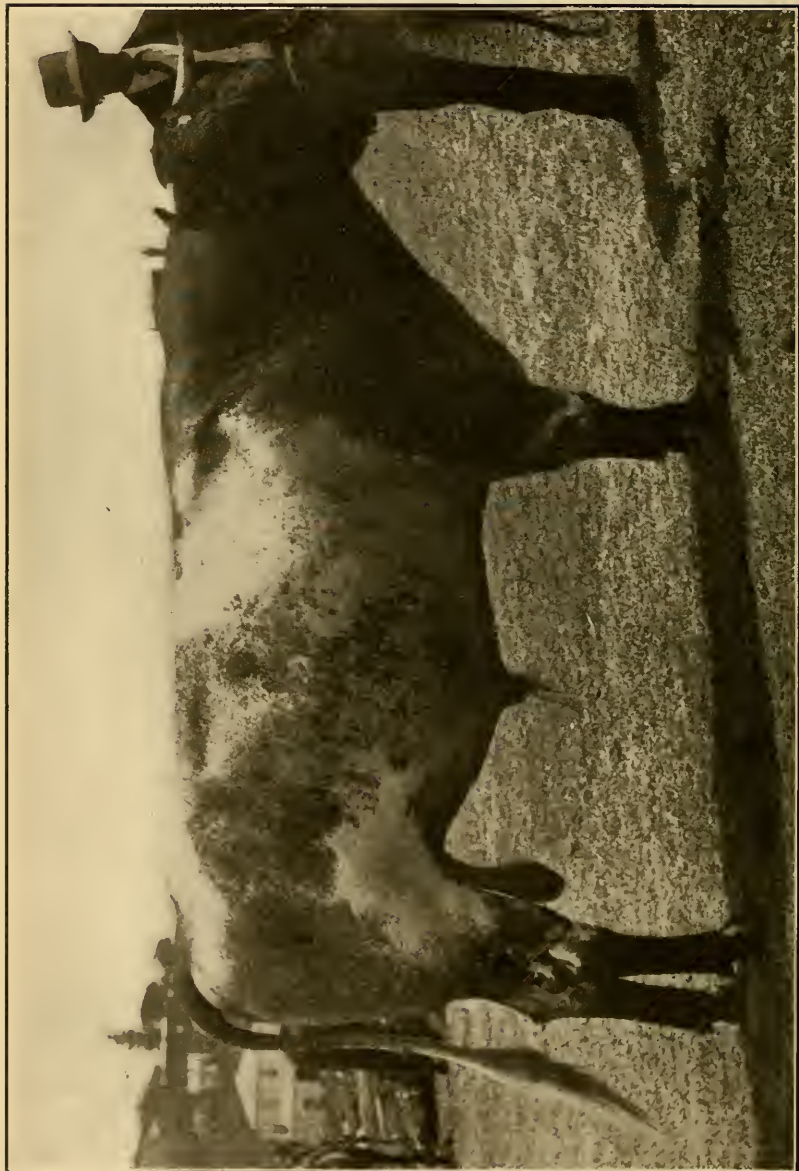

WARRIOR, I. D. C. A. HERD BOOK.

harmony and happy proportions between the several parts of an animal's mechanism. With regard to the udder formation of the Illawarra dairy cow there may be difference of opinion; but all breeders are agreed that as far as its productive functions are concerned, it is as pure bred as the wool on the back of a Merino sheep. With regard to body conformation or type, difference of opinion seems also to exist; yet all are agreed that the most economic type of cow for dairy purposes is what is termed the wedge-shape animal. Views regarding color vary according to the breeder's fancy, but generally speaking the lighter shades of any color or blend of colors are the most preferred. The photograph accompanying this article were taken of animals in the vicinity of Kiama, my native home, with the exception of Warrior which we sold from the Illawarra district some years ago. Too many valuable dairy animals are removed from places of usefulness at tempting prices by buyers who have no practical knowledge of dairy cattle breeding. The photograph of Warrior was taken in Queensland on a farm to which he should not have been taken.

With the oncoming of the great advance in knowledge of the principles of breeding as laid down by the adherents of Mendelism, we will no doubt soon see a much larger percentage of these high class dairy cattle, whose photographs accompany this article, than it has been our good fortune to raise. Instead of looking at these almost ideal animals as being so many accidents, we will become accustomed to look upon the waster as an accident of birth. Unfortunately the great mass of dairy farmers are too busy on their farms to do much reading, hence new ideas progress slowly.

Our cattle could not be registered in the English Shorthorn herdbooks—they are not of that type. They are of the English Shorthorn type that existed in England prior to 1870. That is to say, they are Shorthorns that carry little or no beef and possess plenty of size without being large boned. Our cattle are descended from the English Shorthorn of the thirties and forties of last century. Therefore, they could not be entered in Coates' herdbook.^a They will not carry the beef and that is what the English herdbook was originally established for.

^a In the *Journal of the Board of Agriculture*, September, 1910, p. 447, The Coates Herd Book is described by Mr. A. T. Mathews, as follows:

"A very great step in advance was taken when, after much persistent advocacy by Mr. Richard Stratton and others, the Shorthorn Society commenced in 1901 to give prizes for milking Shorthorns, although in so doing no definite aim was claimed. The movement served the great purpose of setting certain breeders to think, and in 1905 they formed a new society, called the "Dairy Shorthorn (Coates's



Togo, No. 1, I. D. C. A. Herd Book.

Nor could they be registered in the American Shorthorn herdbook if that is based on the same lines as the modern English herdbooks.

We have a strain of cattle here that have been bred exclusively for milk and butter production for seventy years back. To my knowledge, there have not been any records made as to the cost of producing milk and butter; at any rate not in the sense that experiment stations conduct such tests. Our dairymen are nearly all rent payers. Rents are very high in Illawarra, running in some instances as high as 2 pounds (\$9.72) per acre per year exclusive of taxes, rates, etc. We have the landlord system with us.

The dairymen know the breed and types of cattle that pay the rent, and they have held fast to them through all ills and will no doubt continue to hold on to them, improving them as they go along. Our breeders claim that our cattle are the original types of Shorthorn and that generations of feeding have produced the beef types. However, we are all living in hope of better results later on when the older worlds have solved a few of the many vexed questions in heredity—and found clues to the tangled facts of the causes of variation.

In conclusion I desire to convey my appreciation of the splendid efforts of the American Breeders Association and those who have contributed in the past to its publications. My wish is that their efforts may be crowned with success.

Herd Book) Association." Very wisely the founders of this body refrained from starting a separate Herd Book, which would have served no good object, but might have had the effect of splitting the Shorthorn interest into two distinct sections. Their object was not to introduce a cleavage in the Shorthorn ranks, but to restore the reputation of the breed as general purpose cattle, and incidentally to meet the growing national demand for milk."

The above article by Mr. Frank McCaffrey sets forth an ideal condition under which to carry forward to very great success some form of coöperative circuit breeding, such as is being developed in this country. These Illawarra breeders have an ideal basis in the hybrid product, after several generations of intercrossing the Shorthorn, Ayrshire, and other stocks of British cattle. This product naturally varies greatly with families and with individuals within the family. Having been bred by men who are under the necessity of making their money largely out of dairy products, combined with beef, doubtless very much of the unfruitful recombinations of the hybrid stocks have been discarded. Doubtless among the splendid families now in the hands of these breeders, there are occasional individuals and even families with very great power to project high "dual purpose" excellence into their progeny. The governments of Australia and of New South Wales could do no wiser thing in the interests of agriculture, than to thus coöperate in providing the expert assistance needed in establishing in the counties of Camden and St. Vincent, a breeding circuit similar to those being developed by the United States Department of Agriculture in coöperation with the State Experiment Stations.—THE EDITOR.

A HISTORY OF THE ARABIAN HORSE AND ITS INFLUENCE ON MODERN BREEDS

F. KNORR

Mitchell, Nebraska

The origin and early history of the Arabian horse is shrouded in a maze of myths and legends—some as charming as fairy tales. Many who have written about this breed of horses have given one or the other of these wonderful stories currency as fact, and have thereby perhaps led the attention away from the real individuality of the horse itself. The Arabian horse does not need the assistance of legendary lore to prove its superiority. The facts of history, and the real worth of the breed as we know it today, are sufficient to secure for it the recognition it deserves.

There is a tradition in Arabia, that all of the pure-blooded Arabs trace their ancestry to five mares. These five mares were owned by Sheik Salaman, who was the fourth descendant from Ishmael, and lived about 3000 years ago. These five mares fell to him as a dowry upon his father's death; he complained about his inheritance, but after being told that he received the greatest wealth that the land possessed he was satisfied. In time these mares foaled, and thenceforth the drove increased rapidly, and developed into the most wonderful breed of horses man ever saw.

Another legend has it that a certain prophet selected the best mares that could be secured in the land; these were enclosed in a corral within sight of feed and water, but both of these were withheld for several days. When the gates were opened the mares made a wild rush for water and feed; just at that moment the war bugle was sounded: five of the mares, half starved and famished for water, halted, turned to their master, and were ready to carry him to battle. These mares are supposed to be the ancestors of the present Arabian horse.

A third story relates that the Arabians trace the ancestry of their horses to those with which Mohammed made his escape to Mecca. But recent investigations by Count De Cantelcus show that instead of escaping on horses, Mohammed at that time had only several camels.

One legend refers to only one mare as the foundation animal. A certain Sheik was pursued by the enemy. While taking a rest by the wayside his mare gave birth to a colt. Being hard pressed

he left the colt to its fate and continued his flight. The Sheik reached camp in safety and after several hours the colt came running into camp and this mare and colt were the foundation animals of the breed.

Historical research has brought to light some facts which entirely discredit all the legends. They do not show the use of the horse so early as usually stated. Many writers on the Arabian horse

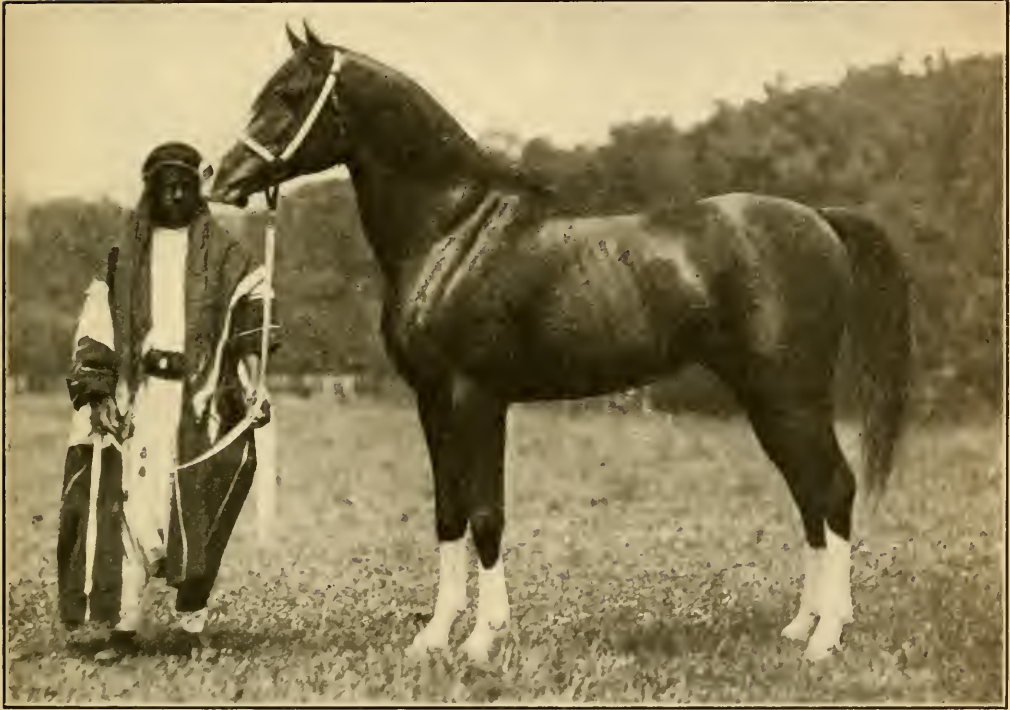

IBU MAHRUSS, A. N. G. B. No.22.

give its existence as early as 1635 B.C. We cannot find any reference to the horse outside of Egypt until Solomon's reign in 1015-975 B.C., and even at that time all of the horses were recruited in Egypt. We well know that in early Biblical times the ass was used as beast of burden almost exclusively, and even at a later day the wild ass is accredited with a greater speed than the horse. A nomadic tribe of Aryan origin pushed out from the mother tribes during one of their periodic migration waves, came drifting from the north, to the plateau southeast of the Caspian Sea, where they

settled and founded Media. Just when they came to that land is not definitely known but it was previous to 625 B.C. These Medians soon became known for their beautiful horses, that were "as swift as the wind." Horse racing was one of their pastimes and it attracted many people from other lands. Previous to this time the Olympian games at Athens had not included chariot racing but about

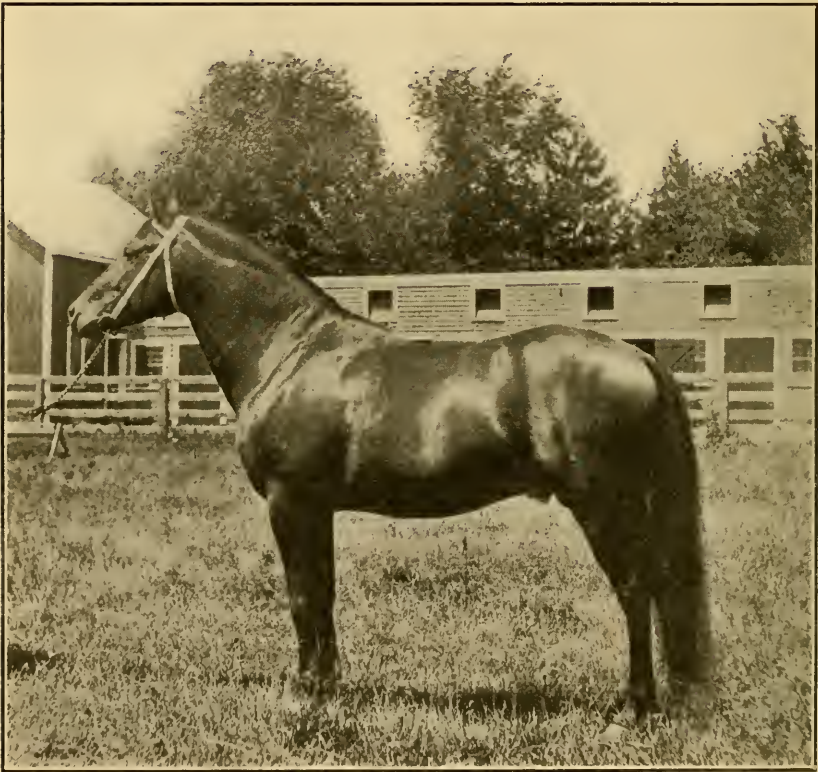

ANTAR, No. 37 A. N. G. B.

650 B.C. the chariot race for the first time played part in those games, but with horses brought "from other lands." Where the Medes secured their horses is not known. They may have brought them from their original northern home, but there are strong reasons for the supposition that these horses were the native wild horse of Media and Mesopotamia and that they were there captured and domesticated. When Naboplassar revolted in 625 B.C. and made alliance with the Median King Cyaxares, the fusion of the armies brought

the Median horse to the south. Later when Nebuchadnezzar (604-561 B.C.) extended his territory and built Babylon, subdued Jerusalem, and began the siege of Tyre, he brought the Median horse with his army into Syria. At this time horses were almost unknown in Phoenicia. The Phoenicians were the greatest merchants of that time; their ships and caravans were known everywhere, yet all their land traffic was with camels. We find these merchants trading with the Arabians, securing from them gold, spices and oils, but in no instance do we find records where they traded their goods for horses.

When the Medes were finally conquered by the Persians in 558 B.C., and were later again taken from the Persians by the Greeks under Alexander in 334 B.C., the rapid spread of the horse began, and we have every reason to believe that Alexander introduced the Arabian horse into the lands he conquered. Herodotus, the first accurate historian whom the world had, states: That so late as 450 B.C. Arabia could not contribute any horses for Xerxes' armies, but gave many camels. If the Arabians had had horses at that time, Xerxes would certainly have procured them and the historian would have noted the fact.

Some writers attribute the hardiness of the Arabian horses to the adverse conditions under which they have been reared for these several thousand years. We well know, however, that it is only the best environment that brings out the best qualities in man and beast. High excellence in animals cannot be produced under unfavorable conditions—in fact, they deteriorate rather than improve. How then can we accredit the desert, the sun-parched plains of Arabia to be the home of the beautiful Arabian horse? All indications point toward the grassy slopes and the foothills of the Caucasus Mountains, where physical conditions are so similar to those we have along the foothills of the Rockies where a dry climate and moderate rainfall make good pasture but without the tendency to make a soft, spongy hoof. Captain Upton in *Frazier's Magazine* (1876) says: "The best breeding is not on the peninsula of Arabia, where the water is only to be had from wells, but rather in Mesopotamia, and the great pastoral districts bordering the Euphrates." All this evidence leads up to the idea that the term "Arabian" horse is a misnomer, for the breed was fully established before it was introduced upon the plains of that land. That there is a gradual deterioration taking place in that breed of horses upon its new and foreign breeding ground, is proven by the improvement which the Arab is undergoing in this country in the hands of our best horsemen.

The Arabian horse has played no small part in the development of all of our breeds of horses; the blood lines of all of our best stock trace back to some Arab or Barb. The race horse, trotter, saddler, coach, and draft horse all have some Arab blood in their veins. It is often said that this Arab blood, used so long ago, can leave no



ABDALLAH, No. 52 A. N. G. B.

trace at the present time, and that for speed the American horse is a far superior animal. It matters not how long since the Arabian blood was infused. It was the foundation stock in the development of the horse and it gave us the animals that we now have. An authority has this to say on that subject:^a

^a *The Horse of America*, by Frank Forrest, vol. 1, 1857.

And though it can scarce be doubted that, in the very commencement of turf-breeding there must have been some mixture of the best old English blood, probably in great part of Spanish by descent, with the true Arab or Barb race, the impure admixture is so exceedingly remote, not within fourteen or fifteen generations that the present race-horse of England and North America cannot possess one sixteen thousandth part of any other blood than that of the Desert.

It is a long time since the horses Messenger, Diomed, Mambrino, Justin Morgan, Bashew, Spark, Selina, Blaze, Fearnaught, Traveller and Ethan Allen lived, yet our best stock traces back to them. Without Justin Morgan there would be no Morgan horse; Justin Morgan was rich in Arab blood. Messenger and Diomed, the progenitors of the American running horse were of like parentage. The beautiful coach horses known as the Hackney trace their lineage to the Arabian breed. At Fort Collins, Colorado, where the Department of Agriculture is now trying to perfect a new type of carriage horse, there is at the head of that stud, Carmon, who carries in his veins the blood of the Arab. The powerful and massive Percheron, whose weight at times exceeds a ton, is, in spite of its ponderous size, not without grace and has certain lines of beauty, both of which it owes to the Arab lineage which has removed that coarseness which prevails with many breeds of draft horses.

Many horsemen make a distinction between the Arab and the Barb, when in fact the difference is but slight. The Barb is more often spoken of as inferior, yet in spite of this it is generally admitted that the Barb has the better knee action of the two. The horses of Spain are Barbs with a strong admixture of the best Arab blood. Captain Upton wrote that not a single specimen of the Seglawi Jedram breed, for which Mesopotamia was once so famous, can now be found there. The Mohammedans when they moved westward secured much of the equipment for their army in that country, and no doubt appropriated most of its stock. They brought these with thousands of other Arabian horses to the Spanish Peninsula. When they were driven out of Spain many of the horses remained and these together with the Barbs, contributed to the foundation of the Spanish breed of horses now known as Jennets.

The late Mr. Keene Richards spent much money in importing and training the Arabian horses for racing purposes, and it was unfortunate that just when results might have been expected the Civil War dispersed his stud. However, his stock had its influence on the horses of Kentucky, and their blood can be found in many of

the best pedigrees of the horses of today in that state. While some pure-bred Arabs have been great race horses it is not for short distance racing that they should be tested. Put him, however, to the severest long distance tests and to continuous daily hardships on short rations of food or water, call on him for that emergency reserve which may be the salvation of life, and his equal will not be found. Grant him first place for weight-carrying and as a general purpose horse and then mere speed assumes a place of minor importance. As motor machines do more and more of the drudgery that heretofore has been performed by horses, this noble animal comes to occupy his original position in the world, that of the joy and companion of man in times of peace, and a most valuable and dependable servant in times of war. His superior intelligence gives him first rank for service and use. His beauty is an asset of much greater value than mere speed and it is his intelligent personality that goes to the heart of every one who is fortunate enough to become the owner of an Arab horse.

When horses will be bred for these highest uses and not for gambling purposes then the Arab horse will become more and more the favorite of horse lovers, and the public at large will be educated to appreciate and value this breed. And in the same manner as the English Thoroughbred and the American Trotter are superior to their Arab ancestors for the special purposes for which they have been bred, so the pure Arab, as he is now being bred in this country, for the qualities which especially characterize this breed, will make the Arabian horse of America the best in the world.

CONCERNING THE FAT-TAIL AND THE BROAD-TAIL SHEEP

C. C. YOUNG

Belen, Texas

This comprehensive treatise concerning the fat-tail breeds of sheep of Asia is most suggestive. This is a most emphatic illustration of the fact that there is needed a comprehensive campaign in animal introduction into this new continent, similar to the campaign now being carried on in the introduction of seeds and plants. The campaign must be accompanied by the utmost preparation and care to avoid admitting such animal diseases as we do not now have but which would jeopardize our entire live stock industry. Dr. Young's enterprising work should be encouraged in all legitimate ways. It were better that both public and private agencies work in this new field of developing fur and mutton breeds of hardy sheep. No one is more sensible than the editor of the fact that the worst which could happen to Dr. Young and his infant industry would be that this kind of sheep breeding should become a fad—even a shadow of the Belgian Hare fad. As to whether there is profit in these sheep in a commercial way only time can tell. Estimates of high priced rare skins are not quotations on commercial lots. This, as every other industry, needs to grow slowly and conservatively, until commercial quantities have proved out the profitability and the stability of the industry.—THE EDITOR.

In an article which appeared in the *American Breeders' Magazine*, vol. ii, no. 1, 1911, the writer called the attention of the breeders to the fur bearing broad-tail Karakul breeds. It is intended in this article to correct certain statements which were then made in reference to the big Karakul class. Whilst the description of the exterior of the big Arabi, so far as its habitat is concerned, was correct we were mistaken somewhat as regards the weight, which does not exceed that of the Lincoln sheep. The heaviest of all sheep in Asia belong to the *Ovis steatopyga* class which has an average weight of 250 pounds and belongs to the Kamolaja Koordiutsnaja kind.

The literature that deals with this sheep is not extensive and Russian authorities do not have much to say about it except that it is a very hardy desert animal possessing most excellent mutton and fat, but produces only fair fur. At present a commission authorized by the Russian Department of Agriculture is collecting data regarding this remarkable sheep, as well as other broad-tail and fat-tail varieties, and before very long we expect to have something more to say on this subject. This sheep crossed with our Lincolns ought to give us the kind of a broad-tail that we alluded to in our former article, and as but little Karakul pigment is required in order to produce an excellent fur, thanks to the wonderful luster of our Lincolns, Cotswolds, Wensleydales, and especially the Leicesters and Dartmores, we should have little trouble in producing the heaviest fur bearing broad-tail in the world, even if it became necessary to inject more Karakul pigment than an off-spring would possess resulting from a cross between a Kamolaja and a Lincoln, for instance.

There are about thirty different varieties of broad-tail and fat-tail sheep and yet practically nothing has been written on this subject by English writers, with exception of Prof. Robert Wallace of whom we will speak later in connection with the broad-tail sheep of Cape Colony. Some of the literature on these sheep has been translated from the Tartar, a few German writers have also contributed valuable information in a general way, but the classification seems to have been made almost entirely by such Russian naturalists as Sinitzin, Perepelkin, Kooleshov, Poniatovsky, Ivanaev, and others. We can especially recommend the well illustrated books of the first and third of these writers. No attempt has so far been made by any one to translate these works into the English language, a task which the writer has taken upon himself to perform. Another trip through Central and Asia Minor will be necessary before we are satisfied with certain classifications and can unhesitatingly state that we are of the opinion that the small Karakul, which should properly be called Arabi, is the original *Ovis platyura* from which all other sheep of the same class, as well as the *Ovis steotopyga*, are descended.

Whilst all Russian writers practically agree with Sinitzin, who today is considered an authority, that the Shirazi, Doozboy, Malitch, Tartarskaja-Tooshinskaja, Groozinskaja, Osetinskaja, Sokolskaja, Resheteliorskaja, Bessarabskaja-Tshooshka are grade Arabis, this cannot be said to be the case when it comes to the *Ovis steotopyga*. The stand which we took that this sheep is also a grade Karakul which owes its great hardiness and wonderful fat accumulating properties and black pigment to the Arabi, will be contested by certain authorities, who apparently believe that the fat-tail sheep is of different origin, chiefly so, on account of its very short tail consisting of only three to five vertebrae, and the peculiar position of the fat pillows covering the buttocks. We have observed a great variation in the size of the tails of the grade Karakuls, dependent entirely upon whether the non-Karakuls possess a short or long tail, and we think we are right in our assumption as expressed in the following pages of this article, but admit that there are several anatomical puzzles that we are unable at this time to answer, and we desire to state that for the present Natusius and Bom may be justified in their classification. Some broad-tails unquestionably have become mixed with the fat-tails and the proofs offered by Bom in the case of the Zigai is quite sufficient.

A number of preliminary experiments have been conducted by the Department of Agriculture at Washington, D. C., as well as by

various breeders, indicating that we can not only compete with Asia when it comes to the production of such grade Arabi pelts as are known on the market under the trade name of Persian Lamb, Astrachan, Krimmer, Afghan (called Caracul in this country), but that we can excel that country greatly and with much less Karakul blood. Quarter-blood Karakul-Lincoln skins have been produced in Texas equal in luster and tight curl development to the best of the so-called Persian Lamb skins, and as for the half-blood Karakul-Lincoln pelts, there is nothing Asia can produce that can compare with them. That proved to be the case, however, only where necessary precaution was exercised in the selection of our American long-wool ewes with the most luster. Some skins in this case were valued by wholesale furriers at \$10 each, and when one considers that in the southwest at least two such skins can be produced annually from a ewe, one can get some idea of the importance of this industry to our breeders.

There is but little difference between the half-blood and quarter-blood Karakul-Lincoln skins, the value as breeder depending upon the luster and tightness of the curl at the time of birth. It has been demonstrated that we cannot produce a marketable fur in the first cross unless we confine ourselves to the lustrous long-wool sheep, although good results have been obtained where half- and three-quarter bred Lincoln-Shropshire ewes have been bred to half-blood Karakul-Lincoln rams, the skins having been priced as high as \$6. The writer has one skin produced by Allbright from a half-blood Karakul-Shropshire buck and a three-quarter bred Lincoln-Shropshire ewe which is very pretty indeed, and while not yet priced, it should be easily worth \$5. Where Karakul bucks are employed that are free from Afghan blood (tight-wool) we do not have to use full blood long-wool ewes in order to produce \$10 skins and the same thing is true of the half-blood Karakul bucks, providing, however, that such rams have no tight-wool admixture.

Very satisfactory results indeed were obtained on the ranch of the Middle Water Cattle Company, and this is remarkable indeed, as the ewes possessed considerable of tight-wool blood, which to a certain degree was overcome by the presence of Karakul blood in them. These ewes are known in this country by the fancy name of Persian broad-tails, which at the best are half-blood Karakul-Tight-wools, as we will explain later when we go into the question of Persian Broad-tails and Persirianos. Some of these skins were priced by an expert at \$9, and the lambs from which these pelts were obtained

came from Persian broad-tail ewes sired by the two best bucks of the original herd of fifteen which we brought to this country. We were indeed surprised to find that some of these skins were in every way equal to half-blood Lincoln pelts, which only serves to prove that a certain amount of tight-wool blood can be overcome, providing as already stated, the full blood Karakul rams are free from the tight-wool taint. On our own ranch we learned that high grade Lincolns gave us the same results as the full-bloods, providing the Karakul bucks were free from tight-wool blood. Unfortunately in our first herd, our expert whom we trusted, selected some Karakuls for us that clearly show by their short and soft underwool that they contain a tight-wool strain, which can only be overcome by breeding them to the best types of lustrous long-wools. From a mutton standpoint, nobody has made more valuable tests than Messrs. Rhome and Goodnight, proving that Karakul-Shropshires with the Karakul strain predominating, show a wonderful increase in weight and lambs at 4 and 5 months have been found to weigh from 80 to 100 pounds. The Armour Packing Company of Fort Worth, Texas, vouched for these facts and also stated that the Karakul strain seems to have the faculty of absolutely removing the disagreeable woolly and musk-like flavor peculiar to the mutton of our tight-wools.

In our former article we spoke of the great hardiness of the Karakul. For three months we were pasturing on the Mesa at Belen, Texas, 200 high grade Lincolns, purchased from F. R. Gooding, and some 30 Karakuls. Old settlers were of the opinion that Merinos would have starved on this Mesa in one and a half months, as there was practically no grass on it, and the sheep had to live off the little brush and the few weeds found there. At the end of two months we began losing Lincolns on account of starvation, and yet the Karakuls were still in good shape. There is no doubt that the Karakul sheep should be more generally introduced in the southwest where sheep have to go a long distance for water and where they cannot possibly exist unless they possess the rustling and browsing qualities of the Mexican goat. From a strictly fur standpoint, the Karakul will probably be better off in the north where feed is more plentiful, as it has been found that unless the ewes are in good shape the last two months of pregnancy, the lambs are born with insufficient luster. Of course, in the irrigated districts where alfalfa is raised this objection can easily be overcome. Breeders of mutton strictly should know that 25 per cent of Karakul blood will make a great difference in their flock in hardiness, weight and

quality of mutton. In this case the Karakul bucks do not have to possess luster and tight curls at birth.

Professor Nabours of the Kansas Agricultural College stated in a lecture recently in Topeka, that in East India, Bokhara broad-tails crossed with native coarse wool sheep produced lambs weighing 90 pounds when 4 months old! This would tend to show that Rhome did not exaggerate in his report; again Rhome's figures are admitted to be correct by the Armour Packing Company. The writer is of the opinion that half-blood Karakul-Lincoln lambs will show the same weight, and before long we will know exactly, but it is doubtful



FIG. 1.—MONGOL SHEEP.

Note tail formation identical with Karakul. Is this not sufficient proof that Pallace's classification is wrong? Certainly, the Mongol sheep belongs to the *Ovis platyura*. By courtesy of Prince Yermoloff.

whether it is safe to cross such half-blood rams on the small Merino of the southwest and Mexico, as at birth the lambs will hardly be able to pass the pelvic opening.

OVIS STEOTOPYGA OR THE FAT-TAIL SHEEP

This breed, according to Prof. P. N. Kooleshov, bears the name of fat-tail sheep on account of the lobular accumulation of fat that is located on the buttocks and on each side of the very short tail con-

sisting of only 3 to 5 vertebrae. There are generally two symmetrical pillows on each side of the tail and these together with the short tail constitute the so-called "Koordiuk" which in the fat sheep weighs 30 pounds, but ordinarily weighs but 10 to 12 pounds. The two symmetrical fat pillows on each side of the tail are covered on top with long and stiff hair; underneath the surface is smooth and free from hair. The peculiarity of storing fat in such big quantities under the skin of the buttocks and tail is also characteristic of the broad-tail sheep known as *Ovis Platyura*. From the tail of both of these varieties one can ascertain the physical condition of these animals for the better they are fed, the larger in proportion is the "Koordiuk."

The fat-tail breeds are found in Asia, Africa and Russia. According to Robert Hartman, the fat-tail sheep originated in Arabia. Pallas asserts that the fat-tail originated directly from the Argali. Fitzinger, Wagner and Bom do not agree with Pallas. Fitzinger divides the fat-tail into the following classes: Tartar, Mongol, Daur, Burat, Khirgiz, Kalmik and Cape. A few fat-tails are found also in Egypt, Noobia and Sennar, but it is an established fact that the broad-tail sheep was in Africa several centuries before we had any record of the presence there of the fat-tail sheep. In many places the fat-tail sheep were crossed with the broad-tails in which case an animal was obtained with a much shorter tail than either, and a great many of these crosses are found in the Caucasus, and in the dry steppes of the Precaspian Province of Central Asia. According to Bom, the Madagascar, Mekka and Persian short-tail broad-tail varieties (Shirazi, Zigai, Doozboy, etc.) belong also to this class. We cannot agree with Bom, especially in regard to the Shirazi and Doozboy, the former being Karakul long-wools and the latter Karakul tight-wools. In many instances where the Karakul blood is in preponderance the tail does not differ from that of a Karakul, although in the Zigai the much shorter tail and other anatomical features would indicate an admixture of the fat-tail strain.

When in this country a Karakul is crossed with an American lustrous long-wool, we produce a magnificent fur, but our short-wools or tight-wools give us fully as inferior and matty fur as is the case with the Karakul tight-wools that Bom is attempting to connect with the fat-tail sheep. In any event neither Sinitzin nor Ponia-tovsky claim any such relationship. Of course, it would be very interesting to find out just what went into the formation of the Shirazi, Zigai, Doozboy, and other grade Karakuls. Roughly speaking,



FIG. 2.—KURETZBUCK, VOLOSNAKAIJA BUCK.
By courtesy of Prince Yermolof.

we only know that it is either tight-wool or long-wool blood. The fat-tail sheep are very numerous in Bessarabia, Charkov, Taurien, Crimea, Ekaterinoslav, Astrachan and the Caucasus. In the Volga district the fat-tails are known as "Ordi," also "Kirgizki-Tshoon-tooki;" on the other side of the river Don, as "Kalmitzkaja" and in Crimea they are called Greek sheep. In the Caucasus there are three classes, the so-called Mazechi, Bozachi and Karabachi.

Of late years these various sub-classes of fat-tail sheep have been crossed with other varieties of Russian sheep, but in the Caucasus and among the Nomadic tribes of Asiatic Russia the *Ovis steotopyga* is still kept in a pure state. That this sheep can cover a large area when necessary, is proven by its long and strong feet. The neck is also very long, and its ability to digest the scantiest of feed on the Steppes and even at that accumulate in no time immense quantities of fat, marks this as a typical desert sheep. And why should it not? Is its hardiness and rustling qualities not due to the Karakul blood which it contains and to which it owes its great fat storing qualities? Is the fact that those which resemble the Karakul most, actually produce furs, not another proof? From what source did it derive its black pigment if not from the Karakul? The weight is about 150 pounds; some types are much heavier. The nose line is greatly bent and the tendons are of the strongest kind. Among both sexes are those that are horned and others that are not. Some rams have as many as 4 to 6 horns; the head is small and the ears are pendulous. The fat-tail sheep is raised principally on account of its excellent mutton and fat. The fat is used in place of butter, and is very appetizing, and devoid of the strong wooly taste characteristic of the European sheep.

The wool is of two kinds, the long hard coarse outer wool (Karakul) and the soft fine under wool. The first is lustrous at birth, the latter dull. This is precisely what happens in crossing a Karakul to any tight-wool. It makes no difference how one might try to breed the tight-wool strain out, it simply can't be done, unless a lustrous long-wool is bred to the grade Karakul at least once. After several more crosses with the pure Karakul the short soft under wool seems gradually to disappear. The color of the wool is varied. Some is auburn, whilst other is gray, black and even white. In some the under wool is very lustrous and white with occasionally a black or auburn hair (Karakul long-wool). Excellent skins are obtained from the lambs of such ewes. The fur is either black or auburn with very pronounced curls. Where could such ewes have gotten their

pigment from if not from the Karakul which is the most lustrous and highly pigmented animal known? The wool of the adult is used in the production of the best of rugs and felt.

According to Glasco the wool of the Mazech is red, brown and white, whereas the Bozach possess gray wool and the Arick is entirely white. According to Sinitzin, fat-tail sheep have been raised in Crimea for four hundred and fifty years, but today the Malitch is replacing them rapidly because they produce a far superior fur.

The best of the so-called Malitches can hardly be differentiated from the full-blood Bokhara Karakuls, and are known by everybody to be Karakul long-wools, just such as we will have in America before very long as the result of crossing Karakul rams to our Lincolns, Cotswolds and Leicester ewes. If any enthusiast of the *Ovis steotopyga* prefers to believe that the Karakul has descended from it, or that there is no relationship between the two, we have no objections. As for ourselves, after reading everything that we could find during three years on this subject and seeing a number of the animals, we have come to the conclusion that the fat-tail sheep is nothing more than a grade Karakul, a fur producer where tight-wool blood is absent, and a very hardy sheep with excellent mutton producing qualities where tight-wool blood is present. What about the great difference in the number of vertebrae composing the tail of the fat-tails and broad-tails? In time we may offer a satisfactory explanation.

THE OVIS PLATYURA OR THE BROAD-TAIL SHEEP

The principal characteristic of this class is in their long fat tail which consists of fifteen to twenty-four vertebrae. The tail is covered on the outside with the same wool as the body and often comes clear to the ground. In some classes great masses of fat surround the tail from its setting to the tip, while in others the lower portion of the tail is free from fat and therefore movable. The broad-tail sheep is found in Africa, many parts of Asia and South Russia and there are a few even in Southern Italy, and France. Prof. Robert Wallace of the Edinburgh University, informs us that the native of Cape Colony raise a broad-tail with very long feet and middle weight, the tail weighing from $6\frac{1}{2}$ to $16\frac{1}{2}$ pounds.

The broad-tails are less liable to scabies, than Merinos and other tight-wools and their wool is coarse and long. Some of them have horns, others have not (Natusius and Bom). Among the Russian broadtails there are the common Russian broad-tail, the Karakul,



FIG. 3.—MALTICH SHEEP.
Some of the ewes appearing more pigmented, contain more Karakul blood. By courtesy of Prince Yermoloff.

the Pirnaja and Voloshskaja. Most of these varieties are horned. As for the ears, some have drooping ears, others only partly so and some have ears standing straight up. Another characteristic of these sheep is that when their lambs are killed shortly after birth, an excellent fur is produced as is especially the case with the Karakuls and Malitches. These sheep are raised almost entirely on account of the great value of their lamb skins.

In the common Russian broad-tail the tail comes down clear to the ground and is immense in size. This class is found in Bessarabia, Donskaja, Olblast, Taurien Province and Ekaterinoslav. Average weight about 140 pounds. The horns generally have two spiral coils and finally greatly diverge laterally. The ears are semi-pendulous and very long. The head and feet are covered with short white hair with occasionally a black spot on these parts. This sheep has a long hard outer wool and a short but a rather coarse yellow under wool. The meat is the best known. That this class of sheep came into Russia from Central Asia, the home of the Karakul which it resembles greatly, is commonly conceded.

The Pirnaja Ovtsa.—This sheep resembles the so-called Tshoontooki very much and in its makeup is a fat-tail rather than a broad-tail sheep, but the horns are very much longer and in spiral fashion protrude greatly. The ears stand up straight and the tail is even shorter than in the Tshoontooki but with great fat accumulations on the sides of the tail. The wool is white and it is not a fur producer.

The Department of Agriculture of Russia is of the opinion that this is merely one of the several sub-classes of the Voloshskaja sheep and bears no relationship to the Tshoontooki. The wool is sometimes black (no doubt due to a larger per cent of the black Karakul pigment) and there are in Hungary the so-called black and gray, "Zackelschafe" or "Voloschskaja," that must have still more Karakul blood in them and like the Malitsch, give excellent fur and closely resemble the Karakul. We understand that recently a small herd of them were presented by the Emperor of Austria to the Argentine Republic.

The Voloshakaja or Zackelschaf.—This broad-tail class is found in Russia, Roumania, Austro-Hungary, and on the island of Crete. At a distance some look like Angora goats with immense horns. Most horns do not coil as is the case in the preceding class, but diverge laterally and in some cases upward. The ears stand straight up, although some are semi-drooping. Few have no horns. The tail which is triangular, resembling a sugar beet, is larger than in the

common Russian broad-tail and manipular coupling is therefore necessitated. The outer wool is white, seldom gray and black, very long and coarse. The under wool is very fine, lustrous and in great demand all over Europe by manufacturers of fine wool rugs. This breed of broad-tail resembles the Voloshskaja sheep very much, and is renowned for its most excellent meat. The Malitches are raised exclusively in the Province of Taurien, and in Crimea. At the setting of the large tail, consisting of twenty vertebrae, there are found great quantities of fat. The hair is black, gray or white. The skins of very young lambs give excellent fur and resemble our half-blood American-Lincolns very much. In Crimea these sheep have been bred for four hundred and fifty years and closely resemble the Karakul or Arabi of Bokhara; especially in the formation of the rather triangular tail. The ears are half drooping. The bones of the forehead are very protruding and the nose line is curving. The horns are not unlike those of the common Russian broad-tail. The wool is very long and coarse and either black or gray. In fact, they change their color precisely as the Karakuls do, that is to say, when born the lambs are jet black, and velvety in appearance; after three to four months the hair becomes brownish and when one year old becomes decidedly gray. Some lambs are gray when born, and produce beautiful fur resembling black silver fox, but not many of this class are raised.

From April 1 to September 1, the ewes are milked and give about 70 quarts of exceedingly rich milk, and from which the "Brinza" cheese is made. In weight they compare favorably with our Shropshires. The meat of the very young lambs brings from 30 to 50 cents per pound and is regarded as a great delicacy. In that country it is broiled barbecue fashion (Shashlik) and seasoned with parsley and green onions, salt, pepper, the slightest trace of garlic and a powder made from a plant native in Afghanistan and resembling powdered grape leaves. It makes a most appetizing dish.

To the broad-tail class belong a number of breeds in the Caucasus, but what little literature there is found on these breeds is in Asiatic languages. The most important breeds are the "Tartarskaja-Tooshinskaja," "Groozinskaja" and "Osetinskaja." They vary greatly in weight and in the size of tail. The Caucasus breeds have very long and lustrous wool and most beautiful pelts. According to DeBitam, some have smooth, others very curly wool. K. D. Dunavsky states that the Tartarskaja-Tooshinskaja sheep resembles greatly the Groozinskaja. The Tooshinskaja has white wool, except on

the head, ears and feet which are covered with yellowish spots. The head is small, hook-nosed; the horns long and spirally bent. The females have no horns. The body is short, but broad. The tail consists of sixteen vertebrae. The average weight is 140 pounds. The wool is fine, long and very lustrous. The meat is very white and excellent and the fat of the tail is used in place of butter and in Tiflis brings practically the same price. The best of them are raised in Cachetinia. When crossed with Oxfordshires a very good meat is obtained.

Of great importance to the breeders of lamb skins are the so-called Sokolskaja, Resheteliovskaja and Bessarabskaja-Tshooshka. These varieties are unquestionably grade Karakuls and as there is no tight-wool blood present, they give us excellent skins. They are classified as belonging to the Long-tails or *Ovis dolichura*. We know that in all quarter breeds there is practically no change in the tail and as the non-Karakul strain in these varieties possess a long tail, these fur producing varieties cannot be classified with any other type except the Long-tail Thin-tail. There are four varieties of fur produced from these sheep, all of which have good luster and are black, but they vary greatly in the formation of the curls, those with larger curls resembling our half-blood Karakul-Lincoln pelts greatly, but are much inferior in quality.

The Persian Broad-tail.—There are a great many varieties of broad-tails in Persia, most important being the Arabi, Shirazi, Doozboy and Zigai. A party in California brought some Shirazis to this country and crossed them with Shropshires and called them Persian broad-tails. The Shropshire blood made them Karakul or Arabi tight-wools. They are therefore not fur producers, but are excellent mutton sheep, possessing great hardiness, good weight and their mutton is free to a large degree from the woolly flavor of our tight-wools. All this is due of course to the Karakul blood, which gives them a partial broad-tail effect. A half-blood Karakul-Lincoln is more desirable as it will have still more weight, just as much hardiness, better mutton and the best of fur, if crossed with lustrous long-wools. Breeders should not be misled, as Persian broad-tails *do not produce the so-called Persian lamb pelts*, which are beautiful half- and three-quarter-blood Karakul long-wool lamb skins tanned and dyed. Some breeders confound the Persian broad-tails of the United States with Persirianos which is an injustice to the Persian broad-tails, as the Persirianos, produced by crossing Persian broad-tails with Merinos, contain only half as much Karakul blood and

should not be used for breeding purposes if Persian broad-tails can be secured, as the Karakul blood is too dilute to do that name justice.

The Karakul Breeds.—The Karakul breeds are found in Arabia, Palestine, Syria Mesopotamia, Asia Minor, Persia, Afghanistan, Chiva and especially Bokhara, which is the home of the Arabi from which all other Karakul breeds descend. Today the Khanate of Bokhara with its immense oasis is the one place where the pure Arabi has been preserved, although a few are said to be found also in north-



FIG. 4.—ZIGAI BELONGING TO THE KARAKUL CLASS. KRIBOIZ BOUE.

This specimen apparently has less light wool in him than is generally the case, and is therefore a fur producer. By courtesy of Prince Yermoloff.

eastern Persia and Chiva. According to Poniatovsky of Bokhara and Sinitzin of Crimea, the name Karakul is applied not only to the Arabi, but to all grade Arabi most important of which are the Shiraz, Doozboy and Zigai.

The Shirazi is an Arabi Long-wool and like the Malitch an excellent fur producer, whilst the Doozboy is an Arabi tight-wool which has been crossed with certain varieties of the *Ovis steotopyga* (fat-tail) giving us the Zigai. Unfortunately what little literature there is on

the last three classes, is in Afghan, Persian and Tartar, and until the Russian Commission gets out its book on fat-tail and broad-tail sheep, we can say nothing more.

According to certain authors the small Arabi came to Bokhara from Arabia and hence the name Arabi or Arap. This is doubtful,



FIG. 5.—FULL BLOOD KARAKUL EWE, 1½ YEARS OLD AND LAMB.

This ewe contains no trace of Afghan blood; nevertheless, lamb came with beautiful curls and luster. By courtesy of Joseph Simonson. Exhibited in Omaha at the National Wool Growers Association, December 14, 15, 17, 1911.

but it must be added that Simitzin thinks it possible, being of the opinion that the Arabi originated in a hot country which explains its tight curls. He also believes that curls will only form in hot countries, in men as well as animals, and cites as an example the

negro. The Uzbecks on the other hand claim that the Arabi which they compare with the waves of a black lake (Kara-Kul, pronounced Kool) came into the desert of Bokhara from the Pamyr and that it is a mountain sheep and that is the reason why it can endure the cold as easily as it does. We agree with the Uzbecks for the ease with which an Arabi climbs mountains is remarkable. Any sheep accustomed to a warm climate when containing but 25 per cent of Arabi



FIG. 6.—BAKOUR DEER. ~~KARAKUL SHEEP~~
Showing evidence of containing Arabi blood. By courtesy of Prince Yermoloff.

blood, becomes at once a cold country sheep; nowhere is that fact more appreciated than in Northern Asia. Burch found that a quarter-bred Arabi-Merino could stand the coldest of weather and blizzards in Michigan, and whilst Simonson reports a great loss of Shropshires near Dalhart, Texas, last winter on account of the awful snow storms, not one single Arabi succumbed. On the other hand, we can say that six months during the hottest part of the summer

in Coahuila, Mexico, did not seem to in the least affect our herd. An experience of three years has shown us that the sheep can stand extremely hot weather and very cold weather as well. If the Arabi came originally from Arabia, should we not find something in that country that would serve as a proof? Yet, we need not expect any information from that source; it is not to be had.

The natives point in the direction of Lhasa and Thibet, and the Llama-Deli could probably enlighten us. Recently we had the pleas-



FIG. 7.—KARAKUL ~~BUCK~~ ^{GENERAL} BUCK.

Of the small *Arabi* type. By courtesy of Prince Yermoloff.

ure of talking to Lord Rochester who was one of the members of the English military expedition that fought its way into the Forbidden City. To my surprise he gave me the exact description of Sinitzin's small Arabi and spoke of the wonderful beauty of the lamb skins. Efforts were made to get a few head out, but they all died from improper care and lack of food whilst crossing the high mountains. The small Arabi which is extremely hard to find, and when found hard to purchase from the natives of Bokhara, has a narrow head,

elongated face, and slightly curving nose line, short ears, thin feet, tail triangular and not as large as that of the large Arabi; weight 130 pounds. On the head, tail and feet, which are covered with jet black, stiff, very lustrous hair, are found white spots, which may also be noted on the sides. The wool is long, coarse and gray in the adult, but jet black and in very tight beautiful curls the first few



FIG. 8—HALFBLOOD KARAKULE-PERSIAN BROADTAIL.

in every way equal to a halfblood Karakule-Lincoln priced by New York wholesale furriers and dyers at \$9.00. If sold to retail furriers or tailors it is easily worth \$15.00 and would have been still more valuable had the Persian Broadtail ewe not contained a strain of Shropshire blood.

days after birth. According to Sinitzin this is the type from which all others originate, and they are found *only* in Bokhara, between the river of Amu-Daria and the city of Bokhara. There is no fur on earth that can compare with that of the small Arabi, when obtained shortly after birth, and there is none on the market. Any one lucky enough to own them, would not be apt to kill them for fur.

The Large Arabi.—This class, Sinitzin states, resulted from a cross between the small Arabi and some fat-tail variety. If that is true then such a fat-tail must have been cinnamon brown, as occasionally a lamb comes of that color, instead of black. But even so, why should the large Arabi have such an immense lyre-formed tail, with an S-shaped appendage on the end? In our opinion this sheep was



FIG. 9—HALFBLOOD KARAKULE-PERSIAN BROADTAIL.

A portion of the fur in preceding illustration slightly enlarged to show the curl.

produced by crossing the Shirazi with the small Arabi. We have observed that where the so-called brown Persian broad-tail (Shirazi) was crossed with one of our bucks (answering closely Sinitzin's description of the small Arabi) an offspring was obtained in every way closely resembling the large Arabi. In all cases magnificent skins were obtained and this is something that should interest those

owners of Persian broad-tails, that have Shirazis that are comparatively free from tight-wool blood. The fact that they are brown in color makes no difference, the offspring will nevertheless be black.

The large Arabi has a very massive head, short face, nose line greatly curving, forming a convexity, the ears are drooping and larger than in the small Arabi, sometimes the ears are absent; feet are very strong, especially hind legs. The wool is coarse, hard and long, and black at birth; in three or four months it turns brown and in half a year gray, dark gray, seldom white and occasionally remains dark brown. We do not think this sheep excels the Lincoln in weight, but it is infinitely hardier, possessing the browsing qualities of the Mexican Goat. There are quite a few of these, and one other type is to be found resulting from crossing the small with the large Arabi; they are also quite plentiful, some containing a slight Afghan strain (on the tight-wool order).

The Small Arabi.—It is very difficult to find the small Arabi and it takes a great deal of study to learn how to differentiate them from the intermediate class. One can spend thousands of dollars and cross the entire desert and return without having secured a single small Arabi. Among our herd originally containing fifteen head we find all three classes of Arabi represented, and we called them the Karakul herd although properly the name Arabi should be used.

During 1911 and up to very recently His Excellency Prince A. Yermoloff, for twelve years Russian Minister of Agriculture, now life Senator and Member of His Majesty's Council, has been kind enough to gather certain data for the writer and it is due to his efforts that we own today a very exhaustive report on Russian and Asiatic sheep, issued by the Russian Department of Agriculture at St. Petersburg. His Excellency, the Prince, also sent us Sinitzin's, Perepelkin's and Kooleshov's books, also a number of photographs for all of which courtesies we hereby express our gratitude.

TRANSMISSION OF COLOR AND COLOR MARKINGS IN HEREFORD-SHORTHORN CROSSES^a

P. E. FOGLE

Beaver Creek, North Carolina

The breeder, whether of plants or of animals, needs all the information obtainable to assist in the creation of new strains and the improvement of the known strains, and especially is it needful for the animal breeder to have all possible knowledge as his work is slow at best.

The color factor is not a vital one at this time and perhaps never will be, though even now certain colors are preferred and others disliked by the buyer, and at some future time this preference and dislike may become more pronounced.

I have done nothing new in collecting these records, but have simply tabulated the results as they have appeared. Very little seems to be known regarding the transmission of the color and color markings in animals. I have not attempted a comprehensive classification of colors of hair, but have grouped the colors with which I was immediately dealing in these experiments, under five general groups as follows: Red, roan, spotted, white, red body with white face. The animals coming under the first four groups are pure or grade Shorthorns, the fifth the progeny of Hereford bull with Shorthorn cows.

From 26 solid red or nearly solid red cows there came 35 calves of which all had red bodies and white faces:

- 16 had red circles around eyes and spot on nose;
- 7 had red circles around eyes but no spot on nose;
- 2 had imperfect eye circles;
- 10 had no red on face.

From 7 roan cows there were 9 calves:

- 5 had roan bodies and white faces;
- 1 had red body and white face with no eye circles but spot on nose;
- 3 had red bodies, white faces with circles around eyes and spot on nose.

From 8 spotted cows there came 12 calves:

- 1 had red body and white face with eye circles around one eye only;
- 1 had red body and white face with imperfect eye circles;

^a Progress report from Committee on Animal Hybrids. Prof. W. J. Spillman, Chairman.

7 had red bodies and white faces with circles around eyes and spot on nose;
2 had red bodies and white faces with no red on face, and
1 had roan body and white face.

From 2 white cows there were 6 calves:

All had roan bodies and white faces;
1 had imperfect eye circles and spot on the nose.

From 1 cow with red body and white face with circles around eyes and spot on nose there came:

2 calves with red body and white face with no red on face.

From 3 cows with red bodies and white faces with red circles around eyes there came:

3 calves with red bodies and white faces with no red on face.

From 3 cows with red bodies and white faces having no red on the face there came:

3 calves with red bodies and white faces with no red on face.

From 3 cows with roan bodies and white faces there came 4 calves.

1 with red body and white face.
3 with roan bodies and white faces;

Placing the offspring of each of the different cows in separate groups for comparison there is one spotted cow that had 4 calves with red bodies and white faces, 2 of these calves had eye circles and spot on nose; 1 had imperfect eye circles and 1 calf had no red on face. Another spotted cow had two calves: 1 with red body, white face and circles around one eye. One with roan body and white face with no red on face. One cow white in color had 2 calves both of which had roan bodies and white faces, but 1 had imperfect eye circles and spot on nose. One red cow had 4 calves, all of which had red bodies, white faces and circles around eyes. Another red cow had 3 calves all of which had red bodies, white faces, eye circles and large spot on nose.

One roan cow had 2 calves both of which had roan bodies and white faces. Another roan cow had 2 calves, 1 of which had roan body and white face.

Without detailing each case, where a cow had more than 1 calf it may be stated, that in every instance where a red cow had more than 1 calf, those calves were all marked alike, with two exceptions; namely: A Jersey cow that had 2 calves, 1 with red body, white face and eye circles, the other with red body, white face and no red

markings on face. A brown cow that had 3 calves, 1 with red body, white face, eye circles and no spot on nose, 1 with red body, white face, eye circles and no spot on nose, 1 with red body, white face with no red markings on face.

Classifying the 50 calves which entered into those observations according to color and markings we have:

- 33 or two-thirds had circles around eyes;
- 27 or practically one-half had spot on nose, of these only 1 had spot on nose without eye circle;
- 7 had eye circles without spot on nose;
- 1 had circle around one eye only;
- 2 had imperfect eye circles;
- 12 had no red on face.

The proportions of two-thirds and one-half in relation to eye circle and spot on nose, as given above, seems to be fixed since it has held true in all my tabulations, even when there were only a few calves to record.

Summing up color markings of the roan calves we have out of a total of 16 calves with roan bodies; 16 calves with white faces; 1 with imperfect eye circles and 15 without eye circles or red markings on faces.

A few facts in transmission of color and markings have evidently stood the test of time and until revised by future knowledge will be of assistance to the breeder. Thus the circle around eyes would seem to go with the solid red color, as the greater number of red calves carry the characteristic eye circle. The fact that out of 16 roan calves 15 have no red markings on face (having only imperfect eye circles) strongly points to the dissociation of eye circles with roan color. The cross of red and white result in roan, and the roan cow, having received red from one parent and white from the other, transmits the red to about half her offspring and roan to the other half, so that about half the calves from a roan cow bred to a Hereford bull will be red and the other half roan.

All cattle breeders who have handled grade Herefords will understand what is meant by the eye circle and spot on nose. To those not familiar with such cattle, I would explain, that when a red cow is bred to a white face (Hereford) bull many of the offspring have a red circle around each eye and a red spot on the nose, this spot varying in size from 2 inches in diameter to nearly covering the face.

It is of interest to note that this eye circle and spot disappear in the offspring when a cow thus marked is bred back to a Hereford

bull. In other words, a three-fourths grade Hereford does not as a rule show this characteristic mark. I am not prepared to say this spot will be always removed in the first generation; it takes several more crosses to permanently remove it, but from 10 cows bred having white faces (4 with eye circles and 1 with spot on nose) not a calf shows a sign of these marks. The keeping of records of the transmission of color and color markings will be continued and further reports, comprising larger numbers of cattle and extending over several generations, will be made to the Association. It is as yet too early to attempt to draw definite conclusions, but from the results given above, the writer feels encouraged to continue, as the road to definite knowledge is now cleared.

THE TURKEY AS AN EGG PRODUCER^a

W. N. IRWIN

Washington, D. C.

From the settlement of our country until the present time the turkey is the only native^b that has been brought under domestication. In our economic system the turkey has been used almost exclusively as a bird for our table on Thanksgiving Day and other holiday occasions. It has for this purpose earned a justly popular place in the minds of our people.

According to the U. S. Census Report we had on June 1, 1900, 6,599,367 turkeys in the United States. These were undoubtedly breeding stock, since there is no record of their being kept anywhere for the sole purpose of producing eggs for the table, as is the case with chickens and ducks.

In forty years' experience on farms in Ohio and Kansas, where we were never without a small flock, the writer never knew or even heard of turkeys laying more than one or two settings, and that always in the early spring. I was ignorant of the *fact* that in some parts of our great country there were *some* turkeys that continued to lay more or less throughout the season from the latter part of March to January.

After living in Washington a few years I began the study of fruit varieties grown in the vicinity by walking through the market lines Tuesdays, Thursdays, and Saturdays, where the farmers within a radius

^a Mr. Irwin prepared this paper shortly before his death, which occurred June 24, 1911.

^b Both ducks and geese, have at different times and in limited numbers been domesticated, but are now so mixed up with Asiatic and European species that it is very doubtful if there is a single variety of purely American origin.

of twenty-five miles bring every conceivable product of the farm and woods. Early in July, about 1900, I saw some turkey eggs, but scarcely glanced at them, thinking some one had found an abandoned spring nest and that they would not be in condition for the table. On another trip through the market I saw turkey eggs on two or three different stands. Having tasted of turkey eggs in my boyhood days, and remembering their delicious quality, I purchased some, and after enjoying eating them, began a systematic search for all I could find. From March to June, inclusive, the eggs are worth \$1.50 to \$2.50 per dozen for hatching purposes. From July to January, inclusive, they are sold at about 5 cents per dozen above the price for chicken eggs. For about ten years my family, as well as many of our friends whom I have supplied, have been enjoying this truly native American luxury. In no single year since I began have I purchased less than twenty-five dozen eggs, while one year, 1903, from June 27 to December 31, I was able to secure 130- $\frac{2}{3}$ dozen, for which I paid \$42.57. In 1902, between July 15 and December 18, 53- $\frac{2}{3}$ dozen were purchased for \$18.34. These eggs were bought from farmers whom I found to be honest and truthful, one-half dozen to a dozen per week, running along through the season. These farmers are holding today many of the same customers they had when I began with them. One farmer, Mr. Benj. Groves, informed me of a hen that began laying the latter part of March and continued almost continuously until the latter part of November. He was sure she had laid 200 eggs. Having bought his eggs every week, I had no cause for doubting his estimate. Other men have told me of birds having laid as many as 150 eggs during the season.

This trait of the turkey here has been going on for so long a time that people think it quite commonplace to see the eggs in the market here. Many of my friends are buying and using them in preference to chicken eggs.

Turkey eggs, which usually sell at 5 cents per dozen above the price of chicken eggs, are more economical than any other, since they average about 2 $\frac{1}{2}$ pounds per dozen against 1 $\frac{1}{2}$ pounds for chicken eggs and seven-eighths of a pound for guinea eggs, which sell about 5 cents less per dozen than chicken eggs.^c

^cCOMPARATIVE WEIGHTS OF EGGS PER DOZEN.

	ounces
Plymouth Rock.....	.26
White Wyandotte.....	.27
Guinea.....	.13
Turkey.....	.42
Pekin Duck.....	.36
Chinese Goose.....	.64

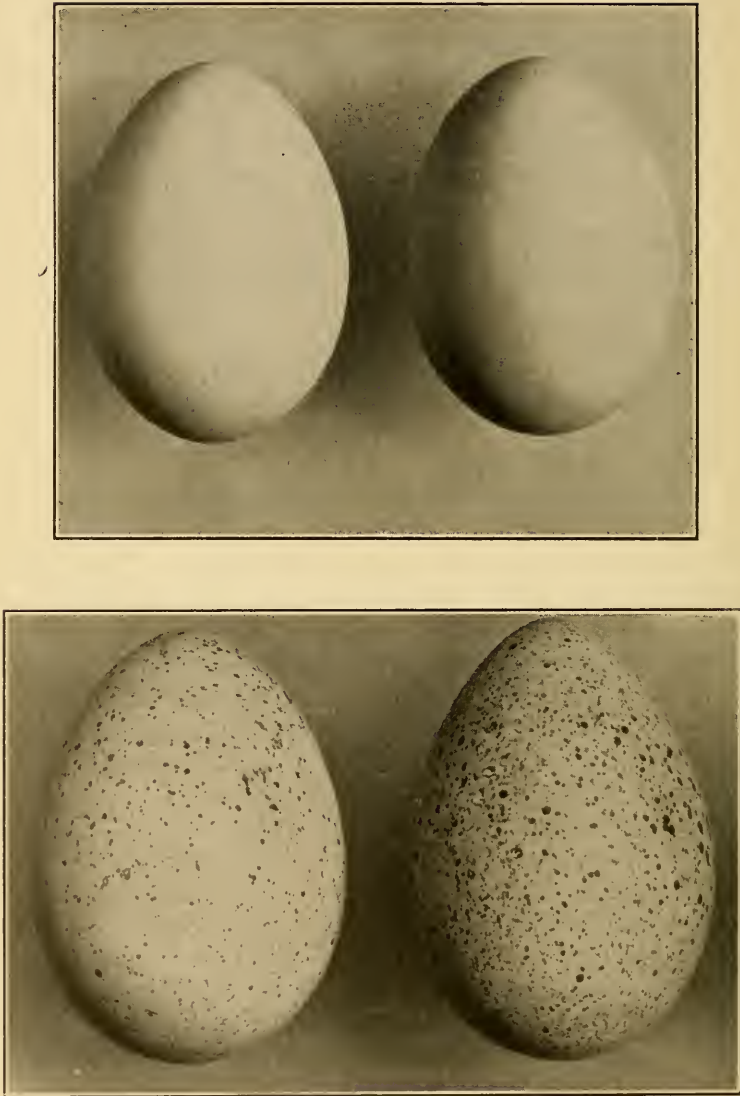

FIG. 1.—COMPARISON OF EGGS AS TO SIZE.

Two White Leghorn eggs laid second week in February, 1911, weight 8½ ounces. Two Turkey eggs laid in October, 1910, weight 13½ ounces. Slightly reduced. Photographed by E. L. Crandall.

On account of the thicker shell and membranes surrounding the contents they retain their good quality very much longer than chicken eggs, which have thin shells and membranes.



FIG. 2.—YOLK OR VITELLUS OF WHITE LEGHORN EGGS.
Natural size. Photographed by E. L. Crandall.

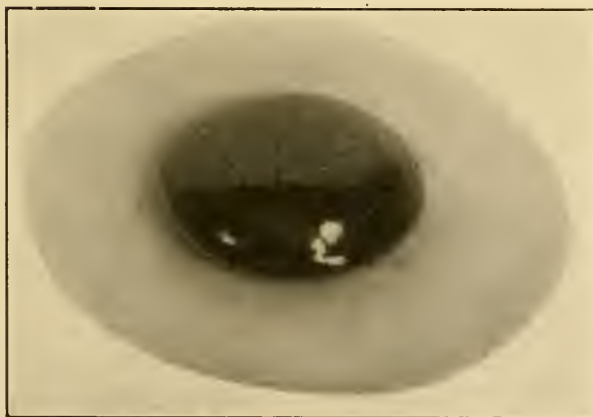

FIG. 3.—YOLK OR VITELLUS OF TURKEY EGG.
Natural size. Photographed by E. L. Crandall.

We have kept eggs purchased in September and October until March when, on opening, the yolks would drop out round and plump, and the white or albumen be perfectly normal.

In Allegan County, Michigan, and in one locality in Massachusetts turkeys are reported to me by thoroughly reliable parties as laying quite regularly throughout the season, in the latter case continuing into January.

If we can in a few decades breed up the turkeys to 100 eggs per bird, which I believe is possible by proper selection from known good layers, our six million turkeys would produce approximately 450,000,000 more eggs than we now are getting from them. At 3 cents per egg this would add \$13,500,000 to our annual wealth, besides materially strengthening our national supply of better foods.

The effort will not, or need not, cost much, so that in case of failure we are no worse off than when we began.

Turkey chicks, 2 to 3 pounds in weight and certain to be from late laying birds, are on the market here throughout the winter at eating prices; \$1 to \$2 each ought to buy the best of these baby birds, crated for shipment, where 3 or 4 are found at one time.

There are only a few female turkeys in this locality that lay eggs out of the usual season; but from the fact that one of my friends reports a similar case in Michigan and another in Massachusetts, it would seem that there is a possibility or even a probability that there are a few of these good layers scattered possibly all over the country.

That this proposition will be ridiculed by wise men, laughed at by fools, discussed by intelligent people, and finally adopted and a new and profitable enterprise added to our poultry industry, I have not the slightest doubt. Every proposition for the betterment of man's condition on the earth, from the time Christopher Columbus started out to discover the New World to the present time, has received like treatment. When Marcus Whitman in the winter of 1842-3 rode on horseback from Oregon to St. Louis and thence by boat and stage proceeded to Washington to protest against Great Britain securing control of our Pacific Coast country, that great and wise statesman, Daniel Webster, to whom as Secretary of State Mr. Whitman appealed, took from his pocket a copper cent and flipping it on his fingers said: "Whitman, I would not give that for all beyond the Rocky Mountains; we could never defend it, nor get across the mountains to it." If Mr. Webster could return and view the millions of happy and prosperous people enjoying a contented life in that salubrious climate, and could know how helpful that country was to the east in shipping its 50,000 to 75,000 cars of fruit a year, he would, I think, admit that his conception of the value of that country had been very poor indeed.

THE EVOLUTION OF A TYPE OF HORSE

W. S. ANDERSON

Winchester, Kentucky

The early settlers of America imported from Europe their general purpose horse. Later, when a horse was needed by the sportsman, the thoroughbred was brought over the Atlantic. Later still, the demand arose for a heavy draft horse and he, too, had to come across the water. But there has since been developed, mostly from thoroughbred blood, a horse peculiar to this country, known as the American Trotter. The families of this standard bred horse are so diverse that it cannot yet be called a distinct breed.

Near the beginning of the nineteenth century there had sprung up, as by chance, in the state of Vermont, a breed of horses called the Morgan Horse. This breed all trace to a horse of unknown ancestry whose name was Justin Morgan. He was taken from Massachusetts to Randolph, Vermont, when a two-year-old colt. Farm mares were taken to his service, and by inbreeding his get, a very compactly built, serviceable and beautiful type of horse was produced. It is a very great misfortune, to the horsebreeding industry of our country, that this very superior type of horse should have been, by out crossing, almost lost as a pure breed.

Something over fifty years ago, there were developed the first saddle and show horses. These were produced by mingling the blood of the thoroughbred and that of the common farm horse. Owing to the great varieties of blood lines there has been no stability in the families of these saddle horses. By fortuitous combinations an occasional animal of real greatness was bred. As the production of such a horse had been largely accidental, so matings were made with him in a like haphazard way. The industry of producing saddle horses is even now in much the same chaotic condition. The owner of Harrison Chief used to say that one show horse was all a man could reasonably hope to produce in a life time.

It is easy now for the student, acquainted with the Mendelian laws of hybrid behavior, to see why these early breeders so often failed. They had too many undesirable traits in the germ plasm of their best horses. It is difficult enough to get a pure bred horse when only two traits are involved in the hybrid ancestry; but when a half dozen, or more, are wrapped up in the germ plasm it is a task almost impossible to obtain a strain that will breed true. To place the fine horse industry on any thing like a scientific basis, it is necessary to eliminate the hybrid.

So far as is known to this writer, but one earnest and intelligent attempt has been made to evolve a pure bred type of saddle horse. It is to tell of this work and its success that I write this paper. Thirty years ago a young man, J. Gano Johnson, in Montgomery County, Kentucky, undertook to evolve a saddle horse that would breed true to type. He was aware of the distinct breeds of beef and dairy cattle, of draft horses, of hogs and of sheep, so he reasoned that the fine horse is of more value than a sheep. Why not a type of the saddle horse? Even at the time he began thus to reason he was a practical horse breeder, and knew something of the magnitude of the task he was about to undertake; but he did not fully realize, until later years, the extreme difficulty of realizing his ideal. It must be noted that the horse to be evolved had to be the result of hybridization. As a matter of fact, when an analysis is made of the blood lines of the breed produced, it is found to come from four sources. First, the farm horse, second the thoroughbred, third the trotter, and last the Morgan Horse.

The following three sires, each great in his respective line, Johnson chose as the ones to furnish the foundation material for his new horse: Indian Chief, descended from Justin Morgan through Sherman Morgan, Vermonts Black Hawk and Bloods Black Hawk who dominated the show rings of Kentucky for the twenty years preceding his death in 1879. At St. Louis in 1868 he won three firsts; namely for best harness stallion, for best roadster, for sweepstakes for all ages and sexes. In this last contest there were sixty-three competitors. Harrison Chief foaled in 1872, goes back to Imported Messenger through Clark Chief, Mambrino Chief, Mambrino Paymaster, and Mambrino, and was during his day one of the distinguished horses of Kentucky. The third great sire chosen was Wilkes, by Hambletonian 10, the most prepotent of trotting sires. All three sires were of the light harness type rather than the saddle conformation. In the great speed of Wilkes, the soundness, strength and action of Harrison, and the intelligence and refinement of Indian, he believed that he had the essential elements to make a great breed of fine horses. He believed that up to his death Indian Chief was the greatest individual horse that had been bred in America. This opinion is verified by the unique distinction which Indian has of having to his credit a number, through his own quality and that of his sons and daughters, among the great sires of the American Trotting Register, the American Saddle Horse Register, and the Morgan Register. So the descendants of these three were used, drawing on just as little material, from other sources, as possible.

The saddle horse is also a carriage horse. That is to say, the horse which has the saddle gaits, walk, canter, rack and fox-trot, is also trained to trot in harness. It is not enough that the show horse shall be fast at the gaits, but he must also be beautiful of conformation, carriage and style. As a matter of fact, as the fine horse exists at present, he is a most intelligent and a most beautiful as well as a most useful animal.

After studying the available material, Johnson thought he saw points of perfection in the various individuals of his foundation animals, which if properly combined in a horse would make him a perfect one. In the descendents of the three foundation sires there were these qualities: the refined, bony head, the large, mild eye, the neatly pointed ear, the long, gracefully arched neck, high withers, the straight barrel ribbing out to the hips, the short back, the full round quarter well let down, the short sturdy legs, the wide strong bone, the flat foot, beauty, animation, brilliant action, extreme speed, docility and intelligence. The task was one of selection and of combination.

He did not have Mendel's work as a guide. At the time that this work on the new type began, the monumental paper of Mendel had not been discovered, and was not for nearly twenty years afterward. He possessed but little theoretical knowledge of biology, but he knew the points of the horse, and had a clear idea of the type he set out to breed. Dominant and recessive unit characters were unknown—at any rate by such names—yet he had learned by studying the behavior of various traits that some always made themselves manifest in the soma and others did not, but might be passed on by the animal whose body was free from them. His breeding has been done with what he calls "manifested characteristics" and "latent" ones. These, of course, prove to be nothing more nor less than the dominant and recessive unit characters. Without their independent discovery his work would have been a failure. For example, he must have in his horse the flat, strong foot, as contrasted to the narrow "mule" foot. He needed a heavy tail and a water-spout tail carriage. He required the flat, strong bone, rather than the round, weak one. Some otherwise good horses had thick, heavy ears, and in their stead there must be the thin, slender, pointed ear. The lung capacity and the walls of the heart must insure strength and endurance. In short, no point of weakness or of coarseness must be allowed. To make progress the breeder had to learn how these various characteristics behave as they pass from parents to offspring.

Had he depended on the result of the matings which he alone could make the knowledge would have come but slowly. The farm on which all this work was done, is in the very center of the fine horse industry. Every other breeder's results could be and were studied. The same blood lines were being used near by.

The very first conclusion was that the method of continued cross breeding usually practised, would not lead to the goal. The hybrid was essential to mix the ingredients, but when it did that, its usefulness ended. So the first endeavor was to get the same desirable points in both sire and dam, or in other words, to make the qualities pure bred. With the great scarcity of animals of like desirable traits it was however impossible to reach the pure bred condition for any qualities except by inbreeding. There was, and is yet, a deep seated prejudice against the inbreeding of horses. There are even those who consider it morally wrong. These views are exceedingly narrow, yet to go counter to traditional belief is no pleasant experience. His task was all the more difficult because he himself could not foretell just what the results of inbreeding would be on the families in use. Trial furnished the evidence that it was safe to inbreed. By this method groups of qualities were soon secured pure-bred. Just here, I must not fail to say that Johnson could afford to own but few of the great horses whose blood he was mingling. Such horses are very expensive. It was necessary for him to make a living as well as move toward his ideal. This necessitated the sale of many excellent individuals which should never have left the stud. Out crossing in other studs soon dissipated their excellence.

Harrison Chief had two renowned sons, Bourbon Chief and Wilson's King. Johnson bought and brought to Montgomery County the former, Bourbon Chief, using freely these two distinguished sons of Harrison Chief.

The second conclusion to be reached as a result of this work was that the shortest route to the goal lay in the female ancestry and not the male. Stallions are more expensive than mares, and of little value unless mares of like qualities can be had to mate with them. Then, too, it is easy to get the services of a great stallion without owning him. So he determined to develop a line of brood mares, by inbreeding, which should have the points of excellence which he needed in his ideal horse. One of these, Queen, traces through Whirlwind to Indian Chief; and through Gov. Wilkes to both Indian Chief and Geo. Wilkes. While her sire, Red Cloud, was by Indian Chief and out of the dam of Wilson's King. In addi-



GOLDEN KING.

tion to this there were in her ancestry two notable show mares: Daisy Burns, and Bird. This beautiful inbred mare, Queen, was mated with Wilson's King.

From this mating was expected the best horse he had yet produced. He had such an accurate knowledge of every feature, and the source of every quality of both Queen and King that he knew what the result must be. The colt, Golden King, verified every expectation. This animal is not for sale; years of work have been spent to produce him that there might be a stallion who could be successfully bred to a line of mares from that other great son of Harrison, Bourbon Chief.

The half brother of Golden King, Cloud King, by Wilson's King out of May Chief by Harrison Chief, is scarcely less famous than Golden himself. Both are show horses, both are successful as sires. To have evolved these stallions alone would have been of but little value to the fine horse industry, unless at the same time a line of mares worthy to mate with them had also been developed. This was done, not only by Johnson but also by others who owned horses of the same blood lines and who believed in the same methods of inbreeding and line breeding. By the time these stallions were ready for service there were many mares pure bred for their qualities, and many more, nearly so. From the pure bred ones and these stallions have come foals of the type. The oldest of these are now producing and their produce are likewise of the type.

The horse of the imagination has been made a reality. There are in this stud a number of sons of Golden King, matured or just maturing, of whom he is the prototype. There are owned by progressive horsemen in Montgomery and surrounding counties many more horses which show considerable resemblance to that type. Thus as a breeder he has rendered a service of great value to his state and nation, by evolving a new type of saddle horse. I call this type the Johnson Horse.

The distinctive features of the type are: intelligence and docility; beauty with most graceful lines; soundness, stamina and strength; height 15.3; short, strong legs set on the four corners of the body; a short back, broad and deep over the loins; long, graceful neck rising out of neatly turned withers; delicate head and sensitive ears; three natural gaits—walk, trot and gallop, the other gaits easily acquired; in action, "The hocks set well up under the body, the knee breaks over in a fold, every joint flexing from the shoulder down in just the right angle to give the utmost roundness of leg fall, every foot falls

in the right place in the right way, all with purity of motion;" in speed unsurpassed; color bay or chestnut. I think I am justified in saying that the Johnson Horse is an improved Morgan, revised and brought up to date: a Morgan, improved in conformation, size, beauty, action, speed, with all the strength, soundness, and endurance of the old Vermont breed.

With permission of Lieut. R. M. Danford U. S. A. the measurements recently made of Golden King are given herewith: "He stands



PURE GOLD BY GOLDEN KING.

15.3, and weighs 1200 pounds. From girth line (just back of the withers) over withers, neck, and forehead to line between the eyes, $53\frac{1}{2}$ inches; across hips, 21 inches; hips to point of buttocks, 25 inches; length of back (from girth line to line joining points of hips), 13 inches; around hocks, 17 inches; around leg below hocks, 9 inches; below knee, 8 inches; girth, $72\frac{1}{2}$ inches; around loin and belly, $73\frac{1}{2}$ inches." The mature sons of Golden King, as Kentucky Golden, Pure Gold, Peter Rabbit, and Young Bill, are so near like him that a stranger finds it difficult to distinguish the sons from one another or from their sire.

The unit characters of the horse may, in a tentative way, be stated to be as follows: that the finer qualities are recessive to the coarse ones; as the thin, pointed ear is recessive to the heavy thick one; the clean, small head recessive to its opposite; the short neck recessive to the long one; the flat foot recessive to the "mule" foot; the calf knee dominant to the straight, perfect knee; strength dominant to weakness; true action and superior action recessive to untrue and inferior action. In color, chestnut is recessive to grey bay and black.

This must be understood as a working hypothesis only. It must be remembered that qualities go in groups. Often a blend of antagonistic traits is a blend only in appearance, and will segregate in a later generation. I have notes made on matings during the last breeding season which, when the foals come, will no doubt throw some light on the dominant and recessive characters of the horse. It may be possible to work out the unit characters of the horse, and to this task the writer expects to devote much of his time.

ORIGIN AND DESCENT OF THE NORWEGIAN BREEDS OF CATTLE^a

DR. J. FROST

Kristiana, Denmark

In some recent contributions to the publications of the German Agricultural Society, Dr. Dettweiler discusses the origin and descent of certain races of cattle whence the various European breeds of cattle are supposed to have sprung, and reverses what, heretofore, has been the almost universally accepted theory, namely; that the black, black and white, and black spotted cattle were originally the cattle of the primitive Germans, and the red and red spotted cattle belonged to some pre or post Germanic race. The black cattle were usually denominated offhand, Germanic cattle, and the red and vari-colored cattle, the Celtic cattle. Dettweiler, as noted, reverses the positions of these two races of cattle and his statements have so far not been contradicted, according to the best of my knowledge.

In the following I will discuss his theory, with special reference to cattle in Norway, and will show that the theory is applicable also to breeds in that country.

The theory which he advances is briefly as follows:

^a Arbo, *Den blonde Brachycephal.*

The red breed of cattle are the Germanic cattle and were tamed and bred by the ancient Germans. Long before the Celtic occupancy of western Europe the race of black cattle was tamed by the Celts, somewhere in the interior of Russia, whence these cattle were brought along on their migrations through north Germany, Denmark, and other countries, in which the Celts had settled on dispersing over western Europe. Dettweiler places this immigration of the Celts into Europe at about 2000 years before Christ, or even earlier.

The black spotted Celtic cattle had come into Norway from Jutland. Dettweiler says:

The appearance of the black color in cattle on the coast of Norway by the proximity of Jutland, is not at all remarkable. Ethnologically speaking, the existence there of a race of people which was a derivation from the pure north-Germanic type has been established; but I do not know whether the area of the expansion of these people covers that of the black and white breed of cattle.

To arrive at a solution of the problem of the derivation of the breeds of cattle in Norway it is necessary to ascertain whence came the first settlers of that country, for the assumption closest at hand is that different races or breeds of cattle were brought thither by various peoples coming there, especially as we know that Norway was settled by different bands of migrants. The first remains found of man in Norway date with certainty to the earlier stone age. Those earliest occupants, as a matter of course, led a very primitive existence. They were mostly fisherman and hunters, and their only domestic animal was the dog.

The Norwegian coasts of those days were rather inhospitable and offered much less favorable conditions for a dense population than today. Therefore, this first population cannot have been numerous, but it spread over almost the whole of the peninsula, that is from south to north and from west to east. The largest settlements were on the southwest coast by reason of people coming there first.

They were members of a race of people which, during the stone period, inhabited the coasts bordering on the North Sea, and without doubt had come there from the south or east of Europe.

This North Sea race of the stone age was characterized by blond hair and round skulls and was apparently closely akin to the Finns of today; it occupied the whole of western Europe from Jutland to northwest Germany, included Holland, and extended clear to Scotland. From Jutland these "blond, round heads" flocked in large numbers to the nearest landing places on the south and southwest coast of Norway, and from there pressed forward north and east.

At the close of the early stone period the inhabitants of southern Norway gradually took to agriculture and cattle husbandry and all the more fertile valleys became populous and well settled by a permanent population.

Whence came the first horses and cattle to Norway is still a matter of conjecture. However, there is much in favor of the supposition that the immigration of the before-mentioned people of the early stone age was not a sudden movement, but took place in successive periods and that these immigrants brought their domesticated animals from Jutland or Friesland. Among these was also the horse, which at that time was common to all the territory adjacent to the North Sea, and was related to the horses of the primitive Finns, and not, as is generally asserted, the Celts. From this horse has descended the Fjord horse of today. It is a small horse which is closely related to the horses which are being bred in Ireland, the Hebrides, the Shetland Islands, the Faroe Islands, and Iceland. The Fjord horses, as indicated by the name, originated in Norway on the Fjords of the western coasts which, during the stone age as before explained, were inhabited by a people belonging to the North Sea race.

In the eastern portion of Norway, that which was inhabited by an ancient Germanic population, was bred an entirely different breed of horses, which might be designated as the northernmost branch of the Occidental horse. It is the same horse which has in Denmark developed into the present day Sudlander, in the adjacent portions of northwest Germany into the Marsh horse, and in Holland into the Friesian horse. In Norway the best and most typical representatives of this breed of horses, are the "Gudbrandsdaler."

Just as the Norwegian horses may be divided into two large groups, namely, those of Germanic and those of non-Germanic origin, we may similarly group the breeds of their cattle. The first cattle in Norway, as the first horses, were owned by that North sea race of the stone age, which sometime probably brought them along from the interior of what is today Russia. In color those cattle were black or black spotted, and are presumably the ancestors of the black and white cattle which may at the present time be found in the countries of northwest Europe.

Jutland is assumed by Dettweiler to be the source whence the black-and-white cattle came to Germany and Holland within comparatively recent times and even to different sections of Norway in earlier (prehistoric) times. There is much to be said in favor of

this assumption as it is fairly definitely established that the inhabitants of southwest Norway had come from Jutland.

The year 1750 B. C., approximately, marked the beginning of the bronze age in Scandinavia. There is no evidence that a new race of people had come into Norway at the beginning of the bronze age, instead, the civilization of the people of the stone age advanced slowly into that of the bronze age. Agriculture played an important part, and about the same domestic animals were kept then as are kept today.^b

Toward the end of the bronze age and at the beginning of the iron age there seems to have taken place an immigration of Celts into Norway. In ancient remains, forms of skulls characteristic of the Celts have been found, and similar skull formation may be found there among the living, at the present time. Arbo, the eminent Norwegian specialist in skull measurements calls them the "black round-heads" in contradistinction to the considerably older "blonde round-heads." The former are rarer than the blonds but they occur less localized.

Little is known of the earlier periods of the iron age, whose beginning is generally estimated at about 500 years B.C. The oldest finds, dating from the iron age, point to the Celts as having occupied middle Europe during those last few centuries before Christ. Therefore, it was not Celts who had bred cattle or introduced cattle husbandry to any appreciable extent into Norway as raising and breeding of cattle are of much older standing than the immigration thither of Celtic elements. For Holland as well as Belgium I have been able to fix the time of the Celtic immigration at as late as the last centuries before Christ.^c A safe assumption is therefore to credit the first Norwegian breeds of cattle and horses as well as the first breeding operations to the so-called North Sea race of the stone age.

It is true, further, that the cattle coming from Jutland to the west coast of Norway were black-and-white spotted and black, as the majority of their descendants have remained till today.

Wherever, in Norway one finds descendants of the blond haired and round skulled race, which in the stone age had settled south and west Norway, one may come across the black, gray, and black or gray spotted cattle, all the way from the province Jaderen south of Stavanger, clear up to the Lofoten with the exception of a few scattered red cattle, in portions which demonstrably were settled

^b Schetelig, *Vestlandets äldste Kulturhistorie*.

^c Frost, *Agrarsammling and Landwirtschaft in den Underlanden, in Belgium*.

by the Germans before mentioned. Such is, for instance the case with the country around Drontheim.

The majority of and the most typical of Norway's population today, is blond, tall and blue eyed, having the long skulls of the true north Germanic race. These ancient Germans originally came to Norway from the east or the south-east but the time when this occurred is unknown. It is supposed that this so-called north Germanic race occupied nearly all of Sweden in the early stone age, while according to Arbo, their appearance in Norway, in the iron age, occurred 2000 years later. It is probable that their advance into Norway during these 2000 years took place by degrees. They came there as families and kinship groups carrying on farming and cattle breeding. They chose the best and most fertile valleys, conquering and driving before them the resident population and converting the best and most productive portions of the country into more or less purely Germanic colonies. They brought with them their horses and their red cattle, which without doubt they had bred in their Swedish home for thousands of years before.

If it be true that a north Germanic people lived in Sweden as early as the earliest stone period, it is most plausible to accept with Dettweiler and Holdefleiss that the red Germanic cattle descended from a species of bovines which was first tamed, domesticated and bred in Scandinavia, and that the Scandinavian breed called the Fjell cattle is one of the purest and oldest of breeds.^d

The descendants of the red Germanic cattle are now in evidence wherever, in Norway, the preponderance of the population is descended from that ancient Germanic people, as for example, in all the valleys of eastern Norway; in Osterdal, Gudbrandsdal, Numeda', Glommental, Satersdal, as well as the whole of the province of Telemarken, in Drontheim and in the colony of Osterdale peasants in the extreme north in Bardu and Maalselovdal.

In course of time a great number of other and different breeds of cattle came to Norway either in herds which the immigrants brought with them, or as individuals which the Vikings brought back as booty from their raids. Crossing and greatly differing environment brought forth several different types or breeds of cattle which we find in Norway today.

For purposes of improvement of the native cattle much breeding stock has been imported during the past century; notably, Ayrshires.

^d Holdefleiss, *Über die Herkunft und Systematik unseres Hausrindes. Illus. Landw. Zeitung* 28: 10, 1911.

Notwithstanding that a certain amount of blurring of the original race characters took place in the course of the thousands of years past, the distinctive features of the various breeds (or races) have maintained themselves in Norway more completely perhaps than in other countries. High mountains, broad streams and deeply cut fjords interposed the most difficult obstacles conceivable to communication between even adjacent districts and thereby prevented any extensive and general mixture of the original breed characteristics.

Norway is a particularly profitable field of study for the ethnologist, because the different racial elements which originally took part in settling that country, have maintained themselves in a comparative state of purity and distinctiveness to this day and the same is true in even a greater measure of breeds of cattle.

Dettweiler's theories cannot be demonstrated as absolutely true; they are hypotheses just as are the foregoing statements concerning the original settlement of Norway in prehistoric times. But as all the facts regarding the first men, the first horses, and the first cattle in Norway cover each other to a remarkable degree, we feel justified in accepting the correctness of Dettweiler's theory of a red Germanic breed of cattle and of a black post-Germanic breed of cattle.^o

^o *Mitteilungen der Deutschen Landwirtschafts-Gesellschaft*. No. 53, 1911. Translation by Mrs. O. S. Knorr, Washington, D. C.

EDITORIALS

THE PEDAGOGICS OF EUGENICS

One of the marvels of the new century is the rapid popularization of the subject of eugenics. In 1906 when the secretary of the American Breeders Association announced the intention of organizing a committee on eugenics a large part of the daily press treated the matter with levity and ridicule. But the public viewpoint has undergone a radical change, in no small part due to the work of the Association. Now, in all the substantial popular magazines and even in daily papers, appear articles which in subject matter are quite as progressive as those admitted to the Association's own publications. The facts presented by such Association workers as Dr. Davenport, Dr. Goddard, Dr. Rodgers, Dr. Southard, and others in this country and in Europe by Galton, Mudge, Reid, Plöetz, Pearson and a host of others have been so convincing that the new subject has already won its field; and the movement to know man's heredity and to utilize this knowledge in producing races of higher efficacy and capabilities, has suddenly become world-wide. The Association, having assumed responsibilities in helping to guide the eugenics movement in safe channels, is itself just beginning to comprehend the magnitude, the importance, the complexity and difficulties of the task. Suggestions are arising from every standpoint. The public, having accepted as a fact that there is need of reforms, is ready for instruction and guidance. The policy of the Association has been to investigate vigorously rather than to preach; to learn the truth and allow the truth to be its own power. As a group the members of the Association have chosen the rôle of researchers rather than that of propagandists. We have amply proven that our point of view is that of true science. The country has taken us at our word. We have gained a respectful hearing from the intelligent people of the continent.

In the meantime eugenics has come to be the subject of popular discussion, of collegiate instruction, of legislative enactment. It seems, that the era of instruction, of advice, of defining public and private policies, of the practice of scientific eugenics had made an earlier advent than the most optimistic propagandists thought possible. Those who have had the foresight to see this new field of service, and had the courage to break its virgin sod, had hardly time to look back in the furrows, when they were confronted with the need of

being teachers and leaders of the popular side of the movement, as well as of its research problems. The Association officers and workers, in meeting the double task are in part ready to rise to the tasks which are rapidly multiplying. But the field grows so rapidly day by day and month by month, that the number of workers must be multiplied.

The avenues for giving expression to the results of the research of the growing number of investigators banded together under the eugenics section of the Association must be enlarged. And workers must be trained to teach. The pedagogics of eugenics must be wrought out in the departments of our universities and colleges, and from there carried to our secondary schools and through college extension departments to all the people. And it requires no special vision to see that genetics, that is, heredity and the breeding of plants, animals, and men, is to become one of the most vital of the truly cultural subjects of our educational system. Our eugenic investigators need to be broadly and intimately in touch with those who are to develop the pedagogy of this subject, and the teachers must constantly sit at the feet of those engaged in research. There is a rapidly growing need for the enlargement of the publications and other popular activities of the Association, such as exhibits at state fairs and national and international expositions. Persons fully trained in the known facts and in giving them through public address aided by charts and stereoptican illustrations will be needed long before the universities will have had the foresight, enterprise and the time to produce them.

Without assuming the rôle of alarmist, it must be admitted that this subject is sure to drift more or less for a lack of adequate leadership. The breeders of plants and animals will serve largely as conservators of sensible, conservative and practical theories, but if fads do not arise it would be because this subject is unlike any other unripe subject. And the appeal cannot be made too strongly to the governing boards and those in executive authority in our universities to grapple with this subject at once that leaders may be produced in adequate numbers. The old theory that the function of our educational institutions was simply to give men general training has drifted upon the rocks. Modern division of labor has created the demand that men and women be trained for the specific kind of leadership required to care for the problems now demanding solution. If any university president doubts the oncoming of eugenics as a field for vital university service, not merely to the university man, but through university trained experts to the community, let him

scan the literature of the subject in 1905 and then in 1912. The Association's publications need a radical change in policy, that they may deal with the instructional and the popular phases of the subject as well as become repositories of the research work of Association investigators. While the first need of the results of research is to make them available for other investigators, yet the ultimate and broad purpose is that this information may be available as a basis for practical plans of race development.

The Association was conceived in part to bring together the research worker, the practical improver of species, and the educator. The sudden growth of eugenics into an educational and even a popular subject has greatly enlarged and intensified the need of this function of coördinating the results of all workers and of giving them all the composite breadth of the view of the whole genetics movement. In the critical work of popularizing eugenics the coöperation of those persons trained in creating new values in plant and animal heredity are needed. And on the other hand the rapidly developing philosophy of eugenics will help in the more detailed work of the producers of new varieties of plants and of improved families and breeds of animals. But the great need is leaders, and the call is to our great universities to train a scientific, safe, and sane leadership which through eugenics, education, and religion, can develop a stronger human race.

THE AMERICAN BREEDERS ASSOCIATION AND THE PRACTICAL BREEDER

The American Breeders Association has a most vital relation to the work of the thousands of national, state and local associations, which are composed of persons engaged in the breeding of pedigreed animals and plants. These live stock breeders associations, also organizations of horticulturists, nurserymen, seedsmen and plant breeders, for the most part stress the commercial rather than the scientific aspects of their business. They lay stress mainly on the work of multiplying plant and animal stocks for general use.

The American Breeders Association on the other hand has set itself to the task of giving emphasis to research work in heredity. We need more exact knowledge, as a tool to work with. The American Breeders Association also emphasizes the more definitely creative phases of producing new values, the origination of new types with added values, and the improvement of existing breeds of live stock

and varieties of fruits, vegetables and flowers. A third general function of the Association is to popularize the results of scientific research through its publications and to take such knowledge forth to the largest number of breeders possible. It will be seen, that the scope and work of these state breeders associations and that of the American Breeders Association are mutually inclusive, the interests of each include those of the other. The two are not in competition, but are supplementary to each other, and should be intimately and widely in coöperation. The American Breeders Association, through its annual meetings, its bound annual reports, and its quarterly journal, the *American Breeders Magazine*, endeavors to center thought upon the broader features of genetics and practical breeding. These publications follow with close attention the results of genetic research in America and abroad. They emphasize the large economic values which arise from the improvement of the heredity of our great wealth producing crops and breeds of live stock. They discuss in the light of modern science of heredity, the methods by which great leaders in breeding have secured their substantial results. They place, besides all these discussions, the larger phases of eugenics in their economic and social relation.

MANY GENERAL BREEDERS ASSOCIATION

The numerous associations of practical breeders are coming to deal more with the theory of breeding. The trotting register associations, the advanced registries of dairy breeds, the cow testing associations, and the circuit breeders associations, are examples of a tendency to follow out science in a statistical way in building up families of exceptional breeding value within the respective breeds. Field crop breeders associations, horticultural societies, florists societies, and associations of seedsmen and nurserymen are gradually paying more attention to scientific discussions in their meetings and conversations. But in the end the great work of all these organizations is to take the products of the creative breeder and to multiply and bring into wide use the new family of this breed or that, and the new variety of plants. Thus, thousands of Shorthorn breeders have multiplied the "Scotch" cattle brought them through the genius of Cruikshank. N. H. Gentry built up and also widely multiplied his Berkshires, but in the latter work he had thousands of expert swine breeders as helpers. Burbank finds and creates new forms, but the seedsmen and nurserymen are the multipliers and purveyors of his

new things. Experiment stations put out new varieties; and seed growers, seed dealers and nurserymen become agencies to multiply them so that eventually they come within reach of all growers.

Until recent years the science of breeding was in a very undeveloped form, and it is even now very incomplete. But it is a lusty youth and the time for a new order of things has arrived. The practical breeder can now ill afford not to know the widening knowledge which relates to his business. He needs the knowledge and skill of the scientist. We are rapidly getting rid of our old breeding superstitions, of knowledge of things that are not so and breeding is being placed on a firm basis. It will pay the practical breeder to study the present status of the knowledge of heredity, and to keep abreast of advancement along this line. It will pay him for economic reasons, that he may the better use the best materials available in his own breeding work. But beyond that it will pay him for the substantial pleasure and personal development he will receive from this study, as it is being cleared up through research and practical experience.

THE FIELD OF THE AMERICAN BREEDERS ASSOCIATION

The American Breeders Association first sought out and secured in its membership the genetic scientists and the creative breeders of this country and many from other countries. It now desires to enlist under its banner the practical breeders also. The genetic scientists and the creative breeders number only hundreds or at most a few thousand. The practical breeders of live stock, including the no less important ones of poultry and bees, are numbered by the hundreds of thousands. The American Breeders Association will come into its larger purpose, work and influence only when its membership numbers by the tens of thousands these practical technicians who breed and multiply pedigreed animals and plants.

Its thought and influence will reach all countries of the earth for that which is interesting, new and vital in connection with genetics. It will make plain to the laymen the theory of heredity. It will interest legislators in putting forward scientific supervision for creative breeding in coöperation with the practical breeders. It will lead the public press in the discussion of the genetic improvement of the human race. In fact if our enterprising breeders of pure blooded stock and our plant breeders, seedsmen and nurserymen knew how much the association is already doing they would all want to share in the inspiration and results by being members of the Association and thus become subscribers to its publications.

The fact of having brought the students, scientists of heredity and the practical breeders together in a large national organization is an achievement worth all it has cost on the part of the members and officers in money, patience and loyal effort. The placing of the leadership of eugenics in this country in the hands of scientific committees, and the development of scientists in genetics is an outcome of this general plan which is worth all the Association will cost in a generation.

BREEDERS ARE MULTIPLIERS AND BENEFACTORS

The so-called breeder of live stock, even though he does not improve upon the purebred stock he breeds, but only maintains its good qualities, is a public benefactor. He multiplies this stock in its purity and supplies it to stockmen and farmers who thus use pedigreed or upgraded stock where otherwise only mongrel and indifferent live stock would be used. The breeder of purebred animals, needs to know the fundamentals of heredity, or, as we now call it, genetics, that he may secure, multiply and distribute that which is really superior; not merely in looks but in net profits per herd. It does not make one a breeder to pay unduly large prices in the excitement of the sales ring, nor does a long list of entries of his stock in a national herd book. A breeder to be worthy of the name needs to know how to select a foundation of cattle which, when he multiplies them for his farmer patrons, will give the farmer larger net profits per farm herd. Mere show of a few highly fed animals is too often accepted as the badge of scientific success as a breeder. While shows have a large place, winnings of phenomenal animals do not give such a basis for genetic values as do data of individuals tabulated into family averages. The time has come when such science as is coming forward from the researchers and practical members of the American Breeders Association will help the practical breeder to disregard mere show and to build up herds of the best available practical stock whether for meat, work, milk, wool, or for a combination of two or more of these purposes.

The science of breeding is beginning to take rank with the sciences of chemistry, physics and botany. Men have learned how to investigate heredity and breeding. This magazine appeals to breeders to become members of the American Breeders Association. It needs them and they need it. Good can be both received and given.

NEWS AND NOTES

ANOTHER INSTANCE OF BAY FOALS FROM CHESTNUT PARENTS

Another instance of bay foals produced by the mating of chestnut parents is to be found in the catalog of the Algeria Stud Farm, which was located at Erie, Pennsylvania, until its dispersal occurred. The catalog of 1889 of this great stud of thoroughbreds gives the produce of the chestnut mare Monopoly as follows:

Produce

- 1881—Missed to Voligeur.
- 1884—b f, by Versailles.
- 1885—b f, by Versailles.
- 1886—b c, Jake Miller, by Rayon d'Or.
- 1887—Missed to Rayon d'Or.
- 1888—b f, Exclusion, by Rayon d'Or.
- 1889—ch c, by Rayon d'Or.

Rayon d'Or was a chestnut stallion, and it will be noted that two of the three foals Monopoly produced by that horse were bay. This would indicate that the theory advanced by a scientific writer in a contemporary recently that the chestnut color in horses was a recessive color, and that it would always be the result of mating of sire and dam of that color, is entirely lacking in foundation—*The Horse World*, May 21, 1912.

A PERTINENT EUGENICS QUESTION

The Darwinian theory is based on what Herbert Spencer has aptly styled "the survival of the fittest." This theory is so well known that it is not necessary to enlarge upon it. In investigating insanity and degeneracy in Massachusetts, Dr. Southard found twelve towns which he characterized as a "eugenic group" and which he found to be decreasing in population, and twelve other towns which he brought under the heading of "cacogenic group," and which he found were increasing in population. Does this mean that the "cacogenic" population represents an advantageous variation and the "eugenic" population a disadvantageous variation? There is food for thought here. Is the American Breeders Association endeavoring to bring the entire population of the east into the dying-out group, or is it

aiming only at the white man? Or, more restricted still, is it seeking only to set up in America a modern example of the fading-away process which characterized Babylon, Egypt, Greece and Rome?

It is quite true that many members of the Association have earnestly advocated a more numerous progeny by eugenic individuals, but are these members themselves raising families of six or eight children or are they only advising others to do so? It is fairly well established that, counting accidents and celibates, an average of three children to each marriage barely maintains the population stationary. Let those members of the Association who have families of four or more children raise their hands.

If there are any members of the Association who are not raising as many as four children, or who are not in a fair way to do so, do they recognize any disadvantageous variations in their cases? If so, what are these disadvantageous variations? It is more important to know the reason why people who may be fairly classed as part of a eugenic population, do not increase in numbers by propagation, than it is to study the causes of insanity. We will never get anywhere by random shots in the air. We must ask those who fail to reproduce their kind why it is that they fail. They should answer fully and frankly. It is their duty to their fellow men to do so. Doubtless many of those who fail to produce a reasonably numerous offspring would not like to make public the real reasons for their failure. Well, Dr. C. B. Davenport is collecting statistics on human beings, and what he collects appears only as statistics. This is an appeal to members of the Association to send real reasons to Dr. Davenport to the end that he may tabulate them and tell us what is the matter with the eugenic part of our population.—C. L. REDFIELD.

ORGANIZATION OF A EUGENICS CLUB AT CORNELL UNIVERSITY

Last March, some students at Cornell University, who were interested in the eugenics movement, decided to form a club for the study of eugenics. During the same week, but unknown to them, the Cornell Philosophical Club had passed resolutions hoping to bring before the "various organizations within the university likely to be interested in eugenics," their desire to establish "a society whose aim it shall be to promote the study of the laws of inheritance and of eugenic agencies, to disseminate information about such laws and agencies, and to arouse interest in them wherever possible within

the university community." The result was that a general meeting was called to effect an organization. On short notice a large audience gathered on March 26th to hear Prof. H. J. Webber, of the Department of Experimental Plant-Breeding, give a lecture on eugenics. On that same evening the society was organized, and the following officers were elected: President, E. G. Boring; vice-president, H. B. Switzer; secretary, E. E. Barker; treasurer, L. R. Koten.

The membership of the society was drawn from various parts of the university community, and in view of this diversity of interests represented in the membership, as well as because of its large numbers, the society was divided into several subordinate study-groups. Each group is designed to consider eugenics in a different aspect, the biological, psychological, sociological and economical, and so on. Each group meets independently, elects its own leader, and outlines its own course of work. These meetings are held once a week. The chairmen of the various groups, together with the president, vice-president, secretary, and treasurer of the Society, form an executive and program committee, whose function it is to direct the general affairs of the society, and to arrange a program for each of the common meetings of the society as a whole, which occur monthly.

At a second public meeting of the Society, held on August 16, Prof. S. H. Gage, research professor in the college of medicine, made an address, and President J. G. Schurman added remarks endorsing the movement in behalf of the university. The audience filled one of the largest lecture rooms on the campus. Interest in the movement is quite general, and membership is open to all persons. A considerable number of the members are women. The officers, however, are restricted to members of the university who are registered students.

The eugenics society at Cornell is ready to ally itself with other local organizations for the promotion of the eugenics movement.—
ARTHUR W. GILBERT.

PROGRESS REPORT FROM THE UNIVERSITY OF WISCONSIN

I have just received from someone a clipping telling of the organization of the Cornell Eugenics Club. The Eugenics Club of the University of Wisconsin rejoices in the founding of this sister society.

We began with about 50 members and an attendance of 75. At the session last Saturday night we had an attendance of 300 and our membership has now risen to nearly 150. We meet every two weeks,

generally alternating reports on some line of research by the members, with addresses by members of the faculty on eugenic subjects. The literature committee has almost finished a classified list of eugenic literature, together with a statement of the purposes of the movement, which is to be published as a bulletin by the Extension Department of the University for distribution through the state. The research committee is engaged at present in an investigation of the size of families of college professors, a rural township, a labor union, a group of business men, the tuberculosis patients of the city, and the applicants for relief from the Associated Charities, the individuals in each case also reporting upon the families of their fathers and mothers, brothers and sisters in other occupations, and similar data for the wife. We are trying to make it adequate from both a biological and sociological viewpoint. We had a report some time since on eugenic legislation in the United States, and another on insanity in Wisconsin, the first especially surprising us in the extent of legislation already enacted on the subject. It has just occurred to me that a summary might be of interest to readers of the *Breeders Magazine*.—O. E. BAKER, *Madison, Wisconsin*.

THE VALUE OF SEEDLING CHARACTERS IN PLANT BREEDING

A distinction is made, for the purposes of plant-breeding, between desirable dominant and recessive characters. Once we have a plant with a desirable recessive character or characters, it gives us pure seed for the next season's planting. While if we have a plant with a desirable dominant character, we do not know whether it is pure or not (except in those cases where the homozygote can be distinguished from the heterozygote), and have to sow the seed and wait a year to find out. But if we have studied the seedling characters, and any of them are found to be connate (that is, *born together*) with the mature character in question, then we can pick the pure dominants from the second or any subsequent generation from a cross with as little loss of growing time as the recessives.

A selected strain of *Stizolobium*s was found, in the third generation from the cross, to contain a recessive factor which caused the young shoots and pods to be covered with a close black tomentum instead of the usual whitish pubescence. These black plants were all late-flowering. The pure dominant plants were selected without any loss of growing time, and at a minimal expense, by sowing separately in a cold frame, early in the season, fifty seeds from each of the plants

with the dominant character. In two weeks it was obvious, from the colors of the plumules, which of the lots of fifty were free from the recessive black. In the same strain there were reasons for thinking that the albino condition (in which purple color is absent from the whole of the plant) was less vigorous than the dominant purple-flowered. (Erwin Baur also found the albino *Antirrhinums* to die in greater numbers than the colored plants. Compare his admirable genetic monograph in *Zeitschrift fuer inductive Abstammungs und Vererbungslehre*, iii: 70. 1910.) The purple-flowered plants have purple-stemmed seedlings. Thus by sowing fifty seeds each from a number of plants of this strain, we can readily find the plant or plants all of whose seedlings have both purple epicotyls and whitish pubescence on the plumules. These will breed true to both dominant characters, and will have been obtained without loss of time. Such a test can readily be carried out in the winter season, by sowing the seeds in flats.

The larger the mature plants are, the more important is the study of the seedlings, because of the expense of growing to maturity many lines which will have to be rejected. This is especially the case in breeding shrubs and trees. (For instance, one may notice seedling characters in the mango and guava which are possibly connate with definite qualities of the fruit.) I am convinced that in the future it will pay the scientific plant-breeder in some cases to make a microscopical and chemical study of the seedlings, to learn what seedling characters are connate, in the strains with which he is working, with desirable dominant characters of the mature herb, shrub, or tree.—
JOHN BELLING, *Gainesville, Florida.*

THE FIFTEENTH INTERNATIONAL CONGRESS ON HYGIENE AND DEMOGRAPHY

This Congress will be held in Washington, D. C., September 23 to 28, 1912. The preliminary announcement which, by-the-way, is printed in three languages, English, French, and German, contains part of the program which is elaborate and extensive. The work program takes up its two divisions: Hygiene and Demography, these divisions consisting of eight and one sections respectively, and each section having its own program. This convention is of considerable interest to eugenists by reason of the close relation of its subject matter to eugenics. Dr. C. B. Davenport and Dr. Raymond Pearl will read papers before the sub-section of sex hygiene.

PUBLICATIONS RECEIVED

- ATHLETIC SUPERIORITY OF OUR NEW STOCKS. Lieutenant-Colonel Chas. E. Woodruff. Reprinted from the *Medical Record*, April 27, 1912. Pp. 10.
- MODERN VITALISM. Chas. E. Woodruff, M.D. Reprinted from the *New York Medical Journal*, August 26, 1911. Pp. 41.
- THE PRODUCTION OF NEW AND IMPROVED VARIETIES OF TIMOTHY. Herbert J. Webber in collaboration with Thomas P. Hunt, John W. Wilmore, Charles F. Clark, Samuel Fraser. Bulletin 313, April, 1912. Pp. 338 to 392, illustrated with 10 plates.
- THE CANADIAN SEED GROWERS ASSOCIATION AND ITS WORK. Address delivered by Mr. L. H. Newman, Secretary of that Association, before the Select Standing Committee on Agriculture and Colonization, February 6, 1911-12.
- COÖPERATIVE TESTS OF CORN VARIETIES. Evvard R. Minns. Bulletin 314, April, 1912, Cornell University, Agricultural Experiment Station. Pp. 394 to 412. Illustrated.
- THE HEREDITY OF SIZE, SHAPE AND NUMBER OF TOMATO FRUITS. B. H. A. Groth, Ph.D. Bulletin 242, New Jersey Agricultural Experiment Station, Brunswick, N. J. Pp. 401, pls. iii, 7 text charts.
- THE VITALITY OF REPRODUCTIVE CELLS. Lowery L. Lewis. Bulletin 96, December, 1911, Oklahoma Agricultural and Mechanical College. Pp. 47, 7 text figures.
- ANOTHER SEX-LIMITED CHARACTER. Ed. N. Wentworth in *Science*. June 28, 1912. Pp. 986.
- THE WOMEN OF TOMORROW. William Hard. The Baker and Taylor Company, New York, 1911. Review will appear in a later number of the *Magazine*. Pp. 211, illustrated.

NEW BOOKS

- EINFÜHRUNG IN DIE EXPERIMENTELLE VERERBUNGSLEHRE. Prof. Dr. Erwin Baur. Gebr. Borntraeger, publishers, Berlin, Germany. Pp. 293, 7 x 11 inches, 80 text figures, 9 colored plates.

The volume of Mendelian literature is continuing to grow at an amazing rate. One of the more notable recent contributions to this literature is by Prof. Dr. Baur, professor at the University of Berlin, Germany, a book in German under the title of *Introduction into the Study of Experimental Heredity*. This book grew out of a course of lectures delivered at the University of Berlin. Although the lecture form has been retained the subject matter has not suffered in arrangement.

The results of a most extensive series of original experiments by the author in breeding and hybridizing enter into these lectures. Most of these experiments have been with *Antirrhinum* or *Snapdragon* and have not previously been published.

From these cross breeding experiments is also drawn a large part of the material for the numerous drawings and colored plates. The illustrative material is drawn from the plant and animal world according to the author's needs but in the main examples from plant breeding preponderate.

The author does not allow himself to chase theories, nor does he place over-much value on untested theories of others. Baur does not attempt to explain disputed cytological processes and does not admit adherence to any school or theory of the mechanism of heredity. His work is exactly what the title says it is; an introduction into those phases of heredity which are capable of experimental demonstration. Doubtful processes and hazy theories are in every case simply and sensibly referred to the future for more complete research and study. Thus the transmission of modifications is disposed of as follows: "Summa Summarum up to the present not a single case is known, which might be interpreted as one of inheritance of modifications." Hence also, the mutations observed by Dè Vries in *Oenothera* are regarded with decided suspicion "The unstability of this species is something singular." "The cause of this, undoubtedly remarkable mutability of *O. Lamarkiana*, we do not know." He punctures the theory of the genesis of new varieties and even of species by direct mutation by citing the "circumstance, that all cases of mutations generally accepted as such, if not in fact all mutations, are such by reason of loss of a single factor, and the new variety on being crossed with the original variety, behaves so that we can without hesitancy assign the difference to the absence of some one factor."

The trend has for some time been away from strict mathematical interpretation of factorial processes and this is evidently supported by Baur. Those who have been figuring over interminable formulas of correlation tables may question themselves if their mathematical endeavors have yielded results commensurate with the expenditure of effort. Baur holds that so called correlation of two or more characters is frequently merely the manifestation of the same unit character in two or more different directions. "Correlation is a concept which under the light of modern research is in process of dissolution."

The economic importance and practical bearing of genetics on the breeding of plants and animals is summed up more tersely perhaps than in any recent similar literature. "Already, practical breeding has become a distinct science, which bears about the same relation to the science of heredity as technology bears to chemistry." It is

only a question of time that all useful and important plants and animals will be analyzed as to their unit characters but this work will necessarily have to be done by technicians in well equipped and well manned state institutions. Actual breeding will probably always be the work of the plant and animal breeders who will utilize these facts and will make it their business to originate and place on the market new forms and new values.

“A matter of far reaching importance, is the investigation of the intimate processes of mutation,—the solution of the question, whether we can give rise to new material, whether under controlled conditions we can initiate new unit characters, which will give us new material for selection in creative breeding. What we know about these things to day is not worth mentioning.” The final chapter brings this observation: “The theory of natural selection stands and falls with this: whether or not it will be shown that mutations really occur with sufficient frequency to make possible an effective process of selection.”

The conservatism and caution with which this book is written lend it solidity and strength. It is a well rounded publication, calculated to give the student a splendid grounding in the principles of Mendelism. Graduate students, researchers, and advanced students of heredity and breeding who wish to obtain a thorough working knowledge of Mendelism will find this book exceedingly useful.

HEREDITY IN RELATION TO EUGENICS. Dr. C. B. Davenport, Secretary of the Eugenics Section of the American Breeders Association. Henry Holt and Company, New York City. Pp. 320.

This book is a general analysis or broad review of a subject which should be represented on the shelves of every public library, and should be read by every humanitarian, publicist, physician, teacher, parent, and student. This book bears evidence to the fact that eugenics is rapidly accumulating a body of usable knowledge and that its initial period of research may be followed by a permanent period of research, education and application. Eugenics or the breeding of men is clearly placed beside and parallel to eusthenics or the development of man through home, school, and church, as the second great agency for upbuilding the civilization of nations and races.

It is only six years since the secretary of the American Breeders Association organized a committee on eugenics; four years later it was enlarged into a eugenics section, coördinate with its plant section and animal section. At that time no constructive eugenics work

had been done in this country, and the purpose to place the leadership of this subject in the hands of careful scientists has been more than realized. The charlatan and the half-baked scientist is no more to control the public teaching of eugenics than that of engineering, agriculture, or home economics.

Dr. Davenport clearly forecasts the introduction of genetics as a study into our educational system. This is also foreshadowed by the organization of genetic associations at a number of our universities and colleges, and the promise of organization of many more such organizations in connection with the American Breeders Association. In our agricultural colleges the newer genetic principles are being taught in reference to plant breeding and animal breeding; and in a few institutions lecture courses are given in eugenics. Thus these institutions of higher learning are coming into coöperation with this central association in this genetics movement which is gaining a mighty momentum. May we not hope that at no distant date the elements of eugenic fact may become a part of the curriculum of our secondary schools, thus to reach those who compose the body of the millions who work on the land, in the shop, and in the home?

The subject matter treated by Dr. Davenport is so closely related to much that is common knowledge and is so well presented, often with the aid of graphic illustrations, that the laymen will find it both interesting and instructive, and easy to grasp. The preliminary chapters define and state the aim and importance of eugenics, and give some of the more recently discovered facts, and the newer methods in the study of human heredity.

Nearly 200 hundred pages are given to the subjects of the inheritance of family traits and to the eugenic significance of the migration of defective and valuable traits into new territory. Of special interest are the chapters on the influence on the race of certain individuals which have been especially potent in projecting faults or excellencies into a large number of their progeny, as in case of the strong Kentucky families, and in the debased Jukes family.

Dr. Davenport's outlines for state eugenic surveys point out one of the directions in which practical work is being undertaken. In New Jersey and other states these surveys are already under way, with the coöperation of institutions which deal with the defective and criminal classes. The Eugenics Record Office at Cold Spring Harbor, New York, in connection with the American Breeders Association, has reached a point of great importance. That genealogical and other data there collected is already of great value is illustrated by the use Dr. Davenport has made of such information in this

volume. The superintendent, Mr. H. H. Laughlin, who is ably accumulating in a fire-proof vault the available records of lineage and genetic genealogies, invites the coöperation of all interested in either the science or the practice of eugenics. This volume illustrates again the fact that the genetic movement is making substantial progress all along the line.—W. M. HAYS.

REFERENCES IN CURRENT LITERATURE

- MARRIAGE OF THE DEAF. Fred DeLand. *Volta Review*, no. 3, June, 1912. Page 186.
- HEREDITY AND INTERMARRIAGE, FACTORS IN DEAFMUTISM. Linnaeus Roberts. *Volta Review*, no. 3, June, 1912. Page 184.
- UNFIT FOR PARENTHOOD. John Harris. *Westminster Review*, May, 1912. Pages 579-582.
- THE CANADIAN SEED GROWERS ASSOCIATION AND ITS WORK. Edited by the Secretary, Mr. L. H. Newman. Ottawa, Canada. Pp. 64, 13 text figures.

This large and useful public service organization, the Canadian Seed Growers Association, has as its object the advancement of the interests of seed growers and farmers in Canada, by exerting such influence and devising such means as will tend to improve the bulk of the forty million of bushels of farm seed which are used annually in Canada, to the end that the per-acre production of those crops may be permanently increased. This pamphlet gives a statement of the organization of the Canadian Seed Growers Association, the general system of seed growing officially adopted by the Association, registration of seed, handling of commercial seed. It further touches on choice varieties, production of "Elite Stocks" of seed, maintaining purity, grading of seed, seed inspection, etc.

We recognize the names of many American Breeders Association members among the administrative officers as well as in the council and directors. The following are the officers for this year: President, James W. Robertson, C. M. G.; vice-presidents, Prof. C. A. Zavitz, G. A. Gigault, John Mooney, and secretary-treasurer, L. H. Newman.

ERRATA

The Editors wish to call attention to the following errors in the article, "Methods of Corn Breeding," by Professor Herbert K. Hayes, in No. 2 of Volume III: On page 99 in place of "these types have been called types," read "these types have been called biotypes," and on page 104 in line 5 read "biotypes" instead of "genotypes."

ASSOCIATION MATTERS

THE EUGENICS RECORD OFFICE

The purpose, the work and the importance of the Eugenics Record Office is coming more and more to public notice. As a research institution it is singular of its kind. The facts brought to light and turned into usable knowledge by its research and field workers have furnished the themes and the inspiration of countless lectures, addresses and articles on eugenics the country over.

The social engineer of the perhaps not so distant future, will increasingly draw from this source facts from which to argue, and upon which to base plans for social uplift, regeneration and organization.

The legislator in state and national councils will also come here to get certain basic facts and statistics so essential to understanding the nature of a population, the interrelations of whose component parts are daily becoming more intricate and complex, and where every problem, whether it be one of industry, of education, of health, of immigration, of sociology, ultimately traces back to one of heredity.

MEMBERS AND ENDOWMENT

The American Breeders Association has 1690 annual and 197 life members, and thousands of new members are needed. Every member is urged to invite three friends to join and to request the secretary to send them an invitation and a copy of the *Magazine*. The Association has earned a place by the side of other great movements. Has it not earned an endowment? How shall that be secured? The best endowment for this publication would be a large membership: best, because the membership is a living endowment.

This Association is the vanguard of research and creative work in genetics. It has in hand much work which an endowment of money would enable it to carry out. It needs money to bring into the field of public effort a number of things which public institutions are not ready to undertake. It needs means to be devoted to the coordination of the forces working along genetic lines.

The proposition of bringing together the plant and animal breeders was once met with much doubt and even with opposition, but it has proven of very great value. Making possible the placing of eugenics in America in the hands of real scientists was a service of inestimable



HEADQUARTERS OF FIELD WORKERS OF THE EUGENICS RECORD OFFICE, COLD SPRING HARBOR, L. I., NEW YORK.

Here under the direction of Dr. C. B. Davenport a force of twelve field workers is engaged in eugenic research. The workers spend their time in studying the family distribution of specific mental and physical traits.

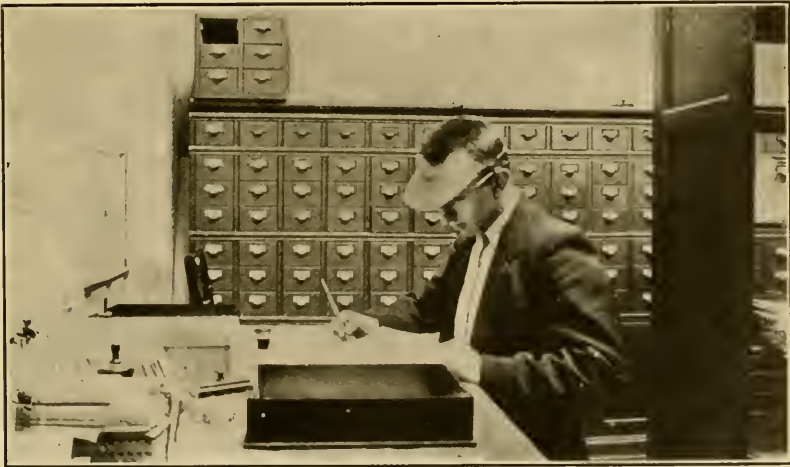

EUGENICS RECORD OFFICE: INDEXING FAMILY TRAITS.

All data received at the Eugenics Record Office is indexed on the basis of surname, trait and locality in accordance with a system devised by Dr. Davenport.

value. The association of those concerned with eugenics with those working in plant and animal improvement, is proving not only its wisdom, but is of very large scientific value. Who will suggest the sum which should be raised for an endowment? And who will suggest a plan of securing it? And while formulating plans for a money endowment for research in genetics let one and all ask our friends, by becoming members, to become a living membership endowment to the *Magazine*, the annual reports and other publications. Let us set the sum for an endowment at \$500,000 or more and work till we get it.

THE MAGAZINE TO OPEN ITS PAGES TO ADVERTISEMENTS

Preparations are being made to change the status of the *American Breeders Magazine* as to second class privileges, in order to enable it to accept advertising matter for publication.

This change of policy will not cause any material change in the *Magazine* except perhaps in appearance. There will be the same number of pages of reading matter as advertising will be placed on additional pages. Complete details will be published in the next number of the *Magazine* when, it is thought, the necessary arrangements with the Post Office Department and the publishers will have been made.

I am glad to contribute to such a good work as you are doing. May you live long and prosper.—C. L. WATROUS, *Des Moines, Iowa*.

I conceive that there can scarcely be anything of more importance than the fostering of a wholesome public sentiment concerning the facts of eugenics.—W. A. BARNES, *Marston, Missouri*.

I consider the publications of this Association the most instructive and useful literature published today and I am convinced that no young man interested in any phase of genetics can afford not to read this literature.—CHAS. MCINTIRE, *Chandlersville, Ohio*.

I regard the American Breeders Association as the most important and influential agricultural association in America and probably second only to the American Association for Advancement of Science in promoting general progress and welfare of the nation—T. V. MUNSON, *Denison, Texas*.

I am tired of your duns for annual membership in the American Breeders Association, so please drop them and make me a life member. Check enclosed.—S. M. TRACY, *Biloxi, Mississippi*.

THE AMERICAN BREEDERS MAGAZINE

"When in any nation the standard of intellect and the number of intellectual men have increased, we may expect from the law of the deviation from an average that prodigies of genius will appear somewhat more frequently than before."—CHARLES DARWIN.

Vol. III

Fourth Quarter, 1912

No. 4

A STUDY IN EUGENIC GENEALOGY

A. GARTLEY^a

Honolulu, Hawaii

Eugenics is probably the most important and urgently necessary scientific work being pursued today as measured by its value both to the individual and to the state. This science was named by Sir Francis Galton, a cousin of Charles Darwin. Galton's lucid writings on the subject are fundamental and may almost be accepted as the eugenic creed. His definitions, "Eugenics is the study of the agencies under social control that may improve or impair the racial qualities of future generations either physically or mentally," and the more comprehensive one, "Eugenics is the science which deals with all influences that improve the inborn qualities of a race; also those that develop them to the utmost advantage," broadly set forth the scope of the work of the men and women who have undertaken to organize the science in its scientific and practical phases.

The science is new, and the subject has been misunderstood and misapprehended by some persons. The thought of a biological consideration of man—as a human animal—has been so abhorrent to the average mind that sociologists and biologists have lacked the courage or inclination to urge their theories or publish their truths, knowing that prejudices precluded rational and sensible consideration. Discussions of the relative importance of environment or heredity usually result whenever the subject is mentioned. But nurture and nature are very closely related and the eugenicist proposes to unite the forces of the sociologists and biologists and increase the physical and mental soundness of man, and to raise to higher level the culture and the intelligence of the great citizen body. The his-

^a Paper read before the Social Science Club of Honolulu, Hawaii, May, 1912. Mr. Gartley is Life Member A. B. A.

torian, the political economist, the sociologist and the philosopher have so far deduced no natural law nor suggested any practical rules of ethics by which this object might be obtained. The eugenist will endeavor to deduce such a law and prescribe methods of its application. Certainly this endeavor cannot be considered unworthy.

The law of Mendel has given us the key and it is hoped that great advance will be made through the study of precise data as to the unit characters in the germ plasm of man and the method of their transmission from generation to generation.

For centuries philosophers and thinkers, from Plato down, have recognized the inheritance of qualities from the individual but have usually only considered negative or recessive qualities and have warned against the inheritance of degeneration and defects. Galton in his book, *Hereditary Genius*, published in 1869, pointed out that mental qualities are inherited as are physical qualities and that it is both possible and desirable to improve the human race. Years of study and patient investigation have advanced the subject from an academic to a working basis. The publication of Galton's address "Eugenics, Its Definition, Scope and Aims" met with an enthusiastic response, and the work as outlined is now being actively advanced in Great Britain under the direction of Prof. Karl Pearson at the Eugenics Laboratory of the University College, London, which was established in 1905 by Sir Francis Galton, and was made his residuary legatee at his death in 1911. In the United States a beginning in the organization of eugenics study and propaganda have also been made and the Eugenics Record Office was established at Cold Spring Harbor, Long Island, N. Y., October, 1910, in connection with the Eugenics Section of the American Breeders Association and the collection and study of records and data is now well under way.

Pearson has stated three fundamental biological ideas. First, "That the relative weight of nature and nurture must not *a priori* be assumed but must be scientifically measured; and thus far our experience is that nature dominates nurture and that inheritance is more vital than environment." Second, "That there exists no demonstrable inheritance of acquired characters. Environment modifies the characters of the existing generation, but does not (often) modify the germ plasms from which the next generation springs. At most, environment can permit a selection as to which germ plasms, among the many provided, shall be potential and which shall remain latent." Third, "That all human qualities are inherited in a marked

and probably equal degree." If these ideas are substantially true the theoretical side is much simplified and "selection of parentage is the sole effective process known to science by which a race can continuously progress."

Studies in heredity indicate that every man is an aggregation of large numbers of certain physical and mental characters, and that these characters are not reducible to simpler forms. They are therefore called unit characters; and they are transmitted through the germ plasm as separate units. Furthermore, the inheritance of these unit characters seems to follow Mendel's law and the presence or absence of desirable or undesirable characteristics marks the differences in the character of the men and women about us. It has been convincingly demonstrated that a unit character, absent in both parents, will also be absent in all their offspring, or, in Mendelian terms, when a recessive mates with a recessive, only recessives result. This has been most strikingly shown in the results of the

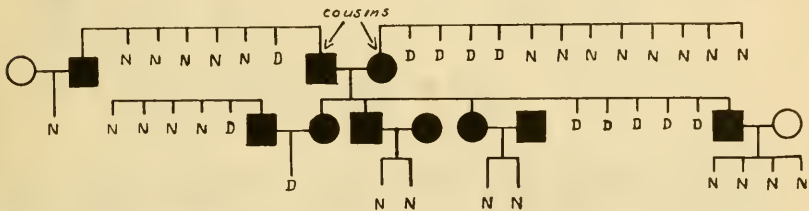

FIG. 1.—TRANSMISSION OF DEAF-MUTISM

In this as well as the following heredity charts the squares represent male members of families, the disks female members. Squares or disks shaded black represent individuals possessing the character under consideration, white symbols, normal ones. Where sex is unknown the letter N stands for normal, D, deaf-mute. "Note the fraternity of deaf-mutes derived from the central mating of cousins. Most of those who outmarried, even though their consorts were deaf, had hearing children." (After Davenport, *Heredity in Relation to Eugenics*, p. 127.)

selective mating of the feeble-minded, and never has a normal child been known to result from the union of two feeble-minded parents.

As another example, vigor and virtue seem to be dominant, and weakness and vice to be recessive. When a dominant character mates with a recessive the children will all have the dominant character but possibly in a dilute condition; the recessive character, however, remains latent, and will reappear one-fourth as often as the dominant.

In order to show more clearly the principles outlined above, three heredity charts are shown and these, selected out of several thousands already plotted, are quite convincing and should furnish material for thought and study.

The first chart shows the inheritance of deaf-mutism to be complete by the marriage of cousins, in families or strains possessing this defect, when the defect is produced no doubt from the same cause. It will be noted that the out-mating of this defective strain with deaf-mutes or other strains produces normal children. This chart emphasizes the necessity of care in consanguineous matings when defects are known to exist in the strain. There is also danger in such matings, of the reappearance of latent defects, after having been absent from one or more generations. This chart shows the inheritance of only one physical defect, but many other physical and mental defects show a similar method of inheritance and follow the Mendelian law.

What are perhaps the most remarkable and most convincing results have been obtained from the study and the charting of heredity

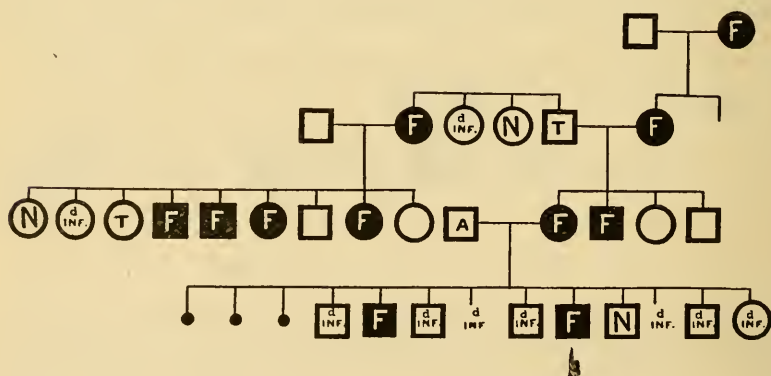

FIG. 2—HEREDITY CHART SHOWING TRANSMISSION OF FEEBLE-MINDEDNESS THROUGH THREE GENERATIONS.

(Courtesy of Dr. H. H. Goddard, Vineland, N. J.)

of feeble-mindedness and are especially shown by the work of Dr. Henry H. Goddard of Vineland, N. J., in charge of the Institution for Feeble-Minded. One chart, showing the transmission of feeble-mindedness, is worthy of special study. Concerning the history of the case Dr. Goddard says:^b

This chart is particularly interesting as showing the mental defect running through four generations, and through the mother's family in three of these, although there is defect on the father's side also in the third generation.

^b *American Breeders Magazine*, vol. 1, no. 3, p. 176.

The chart, figure 3, brings out the unfailing transmissibility of feeble-mindedness with peculiar force. The central figure is a woman who had three husbands, and the social experiment, charted above, was as follows:

This woman was a handsome girl, apparently having inherited some refinement from her mother, although her father was a feeble-minded alcoholic brute. Somewhere about the age of seventeen or eighteen she went out to do housework in a family in one of the towns of this state (New Jersey). She soon became the mother of an illegitimate child. It was born in an almshouse to which she fled after she had been discharged from the house where she had been at work. After this, charitably disposed people tried to do what they could for her, giving her a home for herself and her child in return for the work which she could do. However, she soon appeared in the same condition.

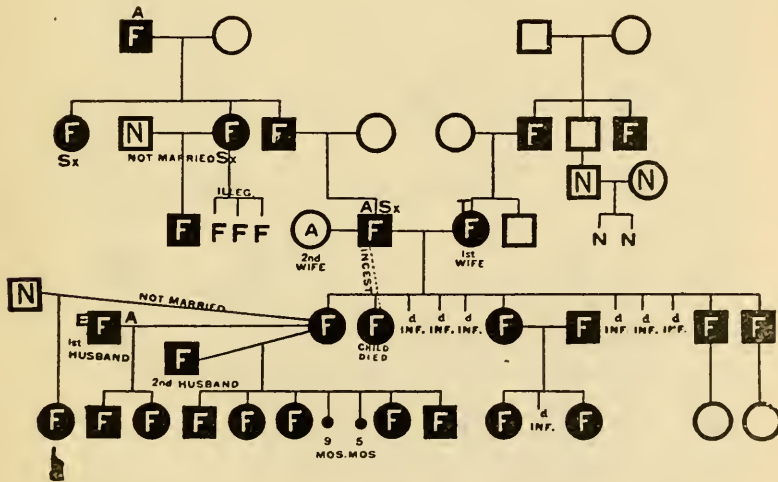

FIG. 3—HEREDITY CHART SHOWING TRANSMISSION OF FEEBLE-MINDEDNESS THROUGH FOUR GENERATIONS

(Courtesy of Dr. H. H. Goddard, Vineland, N. J.)

An effort was then made to discover the father of this second child, and when he was found to be a drunken, feeble-minded epileptic living in the neighborhood, in order to save the legitimacy of the child, her friends saw to it that a marriage ceremony took place. Later another feeble-minded child was born to them. Then the whole family secured a home with an unmarried farmer in the neighborhood. They lived there together until another child was forthcoming which the husband refused to own. When finally the farmer acknowledged this child to be his, the same good friends interfered, went into the courts and procured a divorce from the husband, and had the woman married to the father of the expected fourth child. This proved to be feeble-minded, and they have had four other feeble-minded children, making eight

in all, born of this woman. There have also been one child still-born and one miscarriage.

As will be seen from the chart, this woman had four feeble-minded brothers and sisters. These are all married and have children. The older of the two sisters had a child by her own father, when she was thirteen years old. The child died at about six years of age. This woman has since married. The two brothers have each at least one child whose mental condition is known. The other sister married a feeble-minded man and had three children. Two of these are feeble-minded and the other died in infancy. There were six other brothers and sisters that died in infancy.

No record can show more black symbols, or in other words, transmission of defectiveness, than that of the last two generations, where all known members of the strain are feeble-minded.

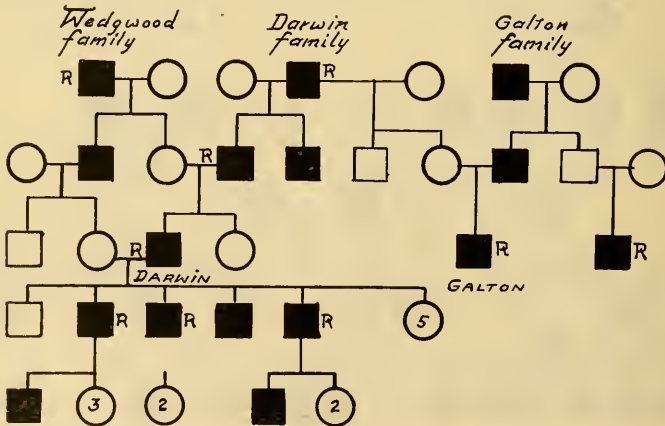

FIG. 4—GENETIC CHART OF THREE FAMILIES POSSESSING MARKED ABILITY

Black symbol signifies that the person which it represents in the kinship, possessed scientific ability. The letter R on side of symbol denotes that in addition the person is a Fellow of the Royal Society. Numbers within symbols indicate other children in childhood not charted.

It will be noted that the two feeble-minded brothers of the second generation (shown on the right of the chart) had one normal brother whose normal son, mated to a normal woman, produced two normal children.

But there is a bright side as well and Galton's efforts were largely positive; that is he endeavored to demonstrate the inheritance of mental capacity and the possibility of improving the human race. An abbreviated record of his own family including the Wedgwood

and Darwin families is pregnant with data in support of the conclusion that these strains carry the potential germ plasm of hereditary genius, great mental capacity, powerful physique, and longevity. There can be no question that "Inhibitions responsible for honesty and dishonesty, morality and licentiousness, temperance and drunkenness, as well as strength and defectiveness of mind, talents for music, for poetry, for oratory, for mechanical invention and the

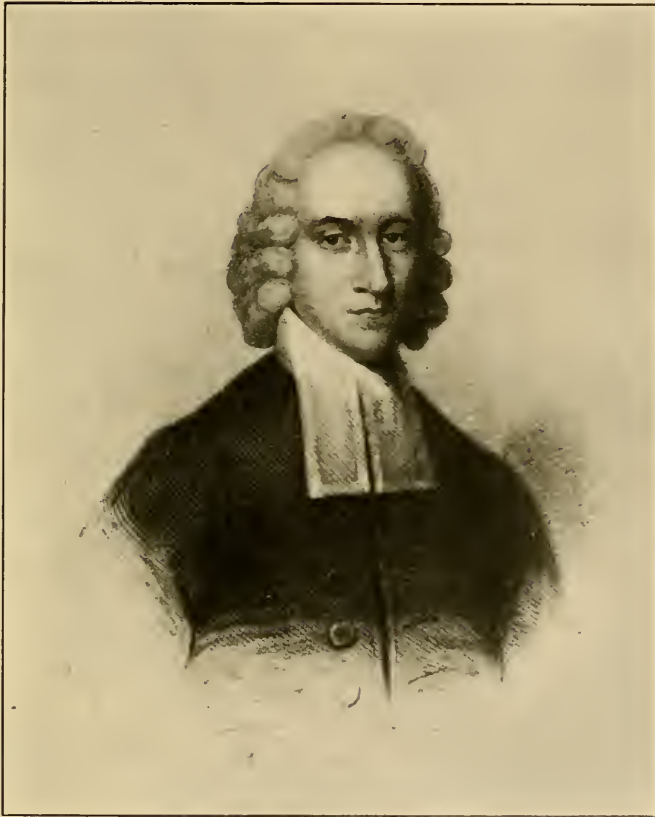

JONATHAN EDWARDS

absence of these talents" are wholly or in part "subject to the Mendelian laws of segregation, dominance, and recombination." What we want is a nation of individuals possessing physical and mental capacity, soundness, aggressiveness, concentration, and sympathy and a germ plasm transmitting these qualities. Unfortunately these qualities are only occasionally combined in one individual, but usually

appear separately. The production of a race of men and women, a great majority of whom shall possess these qualities, will be the next step in human achievement.

The value of the individual possessing a potentially strong plasm is excellently illustrated by Davenport^o who cites one of our best known genetic records, namely, that of Elizabeth Tuttle.

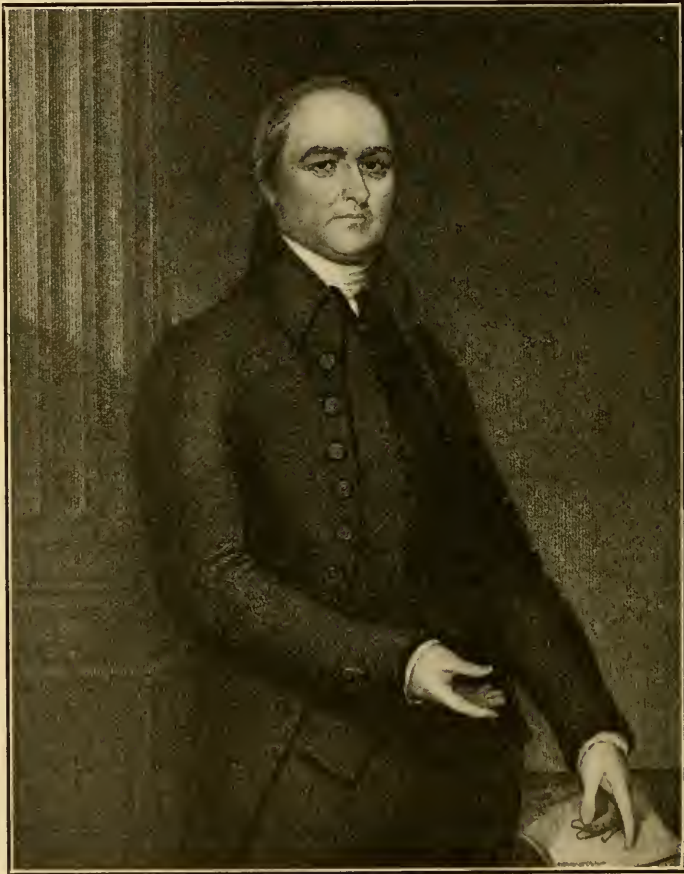

TIMOTHY DWIGHT, S.T.D., L.L.D.

From two English parents, sire at least remotely descended from royalty, was born in Massachusetts, Elizabeth Tuttle. She developed into a woman of great beauty, of tall and commanding appearance, striking carriage, of strong will, extreme intellectual vigor, of mental grasp akin to rapacity, attracting by not a few magnetic traits, but repelling when she evinced an extraordinary deficiency of moral sense.

^o *Heredity in Relation to Eugenics*, Davenport, p. 225.

On November 19, 1667, she married Richard Edwards of Hartford, Connecticut, a lawyer of high repute and great erudition. Like his wife he was very tall and as they both walked the Hartford streets their appearance invited the eyes and the admiration of all. In 1691 Mr. Edwards was divorced from his wife on the grounds of her adultery and other immoralities. The evil trait was in the blood, for one of her sisters murdered her own son and a brother murdered his own sister. After his divorce Mr. Edwards re-married and had five sons and a daughter by Mary Talcott, a mediocre woman, average in talent and character and ordinary in appearance. None of Mary Talcott's progeny arose above mediocrity and their descendents gained no abiding reputation.

Of Elizabeth Tuttle and Richard Edwards, the only son was Timothy Edwards who graduated from Harvard College in 1691, gaining simultaneously the two degrees of Bachelor of Arts and Master of Arts, a very exceptional feat. He was pastor of the church in East Windsor, Connecticut, for fifty-nine years. Of eleven children the only son was Jonathan Edwards, one of the world's great intellects, preëminent as a divine and theologian, President of Princeton College. Of the descendants of Jonathan Edwards much has been written; a brief catalogue must suffice: Jonathan Edwards Junior, President of Union College; Timothy Dwight, President of Yale; Sereno Edwards Dwight; President of Hamilton College; Theodore Dwight Woolsey, for twenty-five years President of Yale College; Sarah, wife of Tapping Reeve, founder of Litchfield law school, herself no mean lawyer; Daniel Tyler, a general of the Civil War, and founder of the iron industries of North Alabama; Timothy Dwight the second, President of Yale University from 1886 to 1898; Theodore William Dwight, founder and for thirty-three years warden of Columbia Law School; Henrietta Frances, wife of Eli Whitney, inventor of the cotton-gin, who, burning the midnight oil by the side of her ingenious husband, helped him to his enduring fame; Merrill Edwards Gates, President of Amherst College; Catherine Maria Sedgwick, of graceful pen; Charles Sedgwick Minot, authority on biology and embryology in the Harvard Medical school; and Winston Churchill, the author of *Coniston*. These constitute a glorious galaxy of America's great educators, students, and moral leaders of the republic.

(TO BE CONTINUED)

FIRST REPORT OF THE COMMITTEE ON IMMIGRATION OF THE EUGENICS SECTION

ALEXANDER E. CANCE; JAMES A. FIELD; ROBERT DE C. WARD;
PRESCOTT F. HALL, Secretary

At a meeting of the Eugenics Section of the American Breeders Association, held at Washington, December 30, 1911, the following resolution was adopted:

RESOLVED: That the Eugenics Section organize a permanent committee on immigration, with authority to coöperate with similar committees of other

organizations in securing laws which will be more effective in securing immigrants which bring good health and normal and superior heredity to this country.

In accordance with this vote a committee on immigration was organized as follows, the chairmanship of it being left in abeyance for the present:

Prof. Franz Boas, Columbia University, New York City; Dr. Alexander E. Cance, Amherst, Mass.; Prof. James A. Field, University of Chicago; Prescott F. Hall, Boston, Mass., *Secretary*; Prof. Robert DeC. Ward, Harvard University, Cambridge, Mass.

The first meeting of the committee was held March 26, 1912, in Boston, Messrs. Field, Hall and Ward being present. There was a discussion of the situation, and the committee felt that the first year of its work should be devoted to a general survey of the needs and possibilities of eugenic work in immigration matters, rather than to starting any original investigations.

The starting point for eugenic work in immigration seems to be to ascertain in what particulars the present law governing the admission of aliens are defective or inadequate, and whether the administration of those laws is or can be effective to shut out those elements of immigration which are dangerous to the well being of the nation for eugenic reasons. The need for information on these points is the greater as our citizens generally know very little of what goes on at the ports of entry. Furthermore what is printed in our newspapers regarding administration methods is often false or misleading. Your committee, therefore, consulted numerous immigration officials, especially in New York and Boston; visited Ellis Island; talked with Commissioner Williams and with New York State officials, and went over a large number of official reports regarding immigration and the methods of inspecting and deporting aliens.

As a result of this work, your committee finds that not only are the immigration laws inadequate to effect the exclusion of the unfit, but that the inspection is not as thorough as it ought to be, owing to inadequate facilities, an insufficient number of inspectors, and the frequent arrival of very large numbers of aliens at one time. It further finds that in some cases the law is actually violated, both in the spirit and in the letter.

A specific instance of the kind of thing that is now going on is the case of Pace Chosen, a Hebrew boy arriving from Russia, February 15, 1912. The boy was certified as an imbecile by the examining surgeon. This certificate was confirmed subsequently by three dif-

ferent medical boards summoned to pass on the case, and his condition was admitted by his family. Sect. 2, of the immigration act and the case of Zatarian V. Billings, 204 U. S. 170, make it clear that the boy was an alien and that his exclusion was mandatory. Intercession was made, however, in his behalf by a Jewish organization in Washington, and finally Secretary Nagel ordered him landed on bond. In the similar case of Mosche Rabinowitz, landed November 13, 1909, the alien immediately became a public charge as an inmate of an insane asylum in Missouri; and could not be deported, because having been landed, he acquired citizenship through the citizenship of his father.

These two instances show that even where the inspection is thorough, unfit aliens are occasionally admitted, owing to alleged motives of humanity or personal influence with the Department. That, whatever the cause may be, large numbers of unfit persons are landed every year is made clear by the experience of New York State. According to Goodwin Brown, Special Counsel to the New York State Commission in Lunacy, the state has suffered an expense of at least \$25,000,000, to say nothing of the damage to the public health, through the admission of defective aliens. By the last available census, New York State's foreign born population is less than 30 per cent, while the foreign born population of the insane hospitals is over 50 per cent, reaching 65 per cent in New York City. In Bellevue Hospital in 1908, 84 per cent were of foreign parentage.

Perhaps of even greater menace to the public health than the alien insane, are the alien feeble-minded. The former are, at least to some extent, segregated, and prevented from breeding; the latter, except in one or two states are not segregated sufficiently to remove the menace of their presence. Feeble-mindedness is peculiarly a defect where family histories become important. In his report for 1911, Hon. William Williams, Commissioner of Immigration at New York, has this to say about this class (Report of the Commissioner-General, p. 147):

I desire to add a few words on the subject of "feeble-minded" immigrants. Our attention is from time to time called to the number of feeble-minded alien children in the public schools of New York, many of whom have passed through Ellis Island. One reason why they are not excluded is, as pointed out in my last annual report, lack of time and facilities for thorough examination as to mental condition. Another is that while idiocy and imbecility can usually be recognized even in infancy, yet feeble-mindedness can rarely be discovered so early, and is usually recognized only as the child approaches the school age. As to children under 5 (and a great many such alien children come here),

it is probably correct to say that nothing short of an inquiry into their heredity will enable the government to determine whether or not they are feeble-minded, and since no such inquiry is now made, the law as to the exclusion of young feeble-minded children is virtually a dead letter, and the Ellis Island authorities have not the means at their command to vitalize it. Not only is a feeble-minded person likely to become a charge upon the community, but such an individual may leave feeble-minded descendants, and so start a vicious strain that will lead to misery and loss in future generations and influence unfavorably the characters and lives of hundreds of persons. A great majority of feeble-minded children are born of parents who have suffered from feeble-mindedness, insanity or epilepsy. A large proportion of the inmates of Elmira reformatory are feeble-minded. The feeble-minded contribute largely to the criminal class and are often the cause of incendiary fires. At a time when the subject of feeble-mindedness is becoming more and more important in civilized countries and the nature and bearings of this taint are being carefully studied by scientists the government would seem called upon to make far greater efforts than it does to prevent the landing of feeble-minded immigrants.

From a eugenic standpoint, however, the danger from classifiable defectives, great as this is, is probably less than the danger from the much larger class of aliens who are below the mental and physical average of their own countries and cannot fail to lower the average here. To quote again from the report of Commissioner Williams (Report of the Commissioner-General for 1909, p. 133):

I have already adverted to the easy-going character of our exclusion laws and stated that even their strict enforcement keeps out only the very bad elements of foreign countries. Between these elements and those that are a real benefit to the country (as so many of our immigrants are) there lies a class who may be quite able to earn a living here, but who in doing so tend to pull down our standards of living. . . . I wish merely to emphasize what must be known to every thinking person, that [this class] is coming here in considerable numbers and that we are making no effort to exclude it.

In 1907, a clause was added to the immigration law debarring those certified by a surgeon as being mentally or physically defective, such defect being likely to affect their ability to earn a living. The object of those supporting this amendment was to have defectives absolutely barred upon the surgeon's certificate; but it has been construed so as to make the certificate merely one piece of evidence to be considered by the board of special inquiry sitting on the case, and so virtually reduces the eugenic question to the economic one whether the alien is liable to become a public charge.

This construction is the more serious on account of a ruling of the Secretary of Commerce and Labor, made February 8, 1912, commonly known as "Decision No. 120." The law says (Sect. 20)

that an alien who becomes a public charge "from causes existing prior to landing" may be deported within three years from the date of his entry. In this case a girl who entered in 1909 became an inmate of a New York insane hospital in 1911. The New York State Board of Alienists certified that the causes of insanity were constitutional psychopathic tendencies and mental instability, and that these causes existed prior to landing. A surgeon of the Marine Hospital Service gave a similar certificate. The patient claimed a felonious assault in 1911 as the cause of her condition. The Secretary ruled that it had not been shown that the causes named by the surgeons were the sole causes of the insanity; and that the department officials, though possessing no medical knowledge, could revise the opinion of medical experts. The New York State Board of Alienists vigorously protested, quoting numerous medical authorities to show that an external cause, like the alleged assault, could not be the cause of the patient's condition; but deportation was refused, and the decision still stands.

This decision as to deportation shows that it is even more important than before to make examination at the time of entry thorough. It also shows that if medical experts are of any value at all, the law should be altered so as to make the decision of the medical officer, or of a medical board on appeal, final. As a concrete illustration of the present condition of things, it appears that in 1910 at one of our largest ports, of 1483 aliens certified by the surgeons for serious mental or physical defects, 1370 were landed. That such persons do not delay in becoming public charges is shown by the experience of Massachusetts in 1910.^a

Class.	Total number.	Less than one year in United States.
Insanity	99	49
Tuberculosis	31	31
Typhoid	22	21
Total	152	101

Attention should be called in this connection to another most dangerous decision made by the Secretary of Commerce and Labor July 12, 1912, in the case of Riwke Polayes. This decision holds, in effect, that minor foreign born children of naturalized citizens are free from the operation of the immigration laws. In other words, an alien may come here, take out naturalization papers, and bring

^a Report of Surgeon of Public Health Service at Boston, for 1910.

in his children, even though they are idiotic, insane, tuberculous, leprous, or otherwise dangerously diseased. Of course, in many cases such children must at once be placed in institutions in order to protect the public health, and, in many other cases, will soon become public charges; while the danger of epidemics and general infection will be greatly increased. This decision reverses the practice of the Immigration Bureau since 1882, and is, we believe, in direct conflict with the decision of the Supreme Court above referred to.

The commissioners at the various ports are undoubtedly doing the best they can; but when 5000 aliens arrive in one day at Ellis Island, as not infrequently happens, it is obvious that either they must be detained for a longer time or more surgeons must be furnished in order to have an adequate medical examination. In mental cases especially, it may be necessary to have doubtful cases under examination for a longer time; but the saving of expense to the state and municipal authorities as well as the protection of the public health demand this.

Not only should Decision No. 120 be reversed, but the present period of deportation should be extended to at least five years. There is no time limit on the deportation of immoral persons. Why should there be on other defectives and delinquents? Further, it seems to your committee that instead of the burden of proof being placed as now upon the government to show that the alien became a public charge from causes arising prior to landing, the burden should be upon the alien to show that the cause of his becoming a public charge arose subsequent to his landing. The extension of the period to five years has been recommended as to major criminals by the Immigration Commission.

Under the present law transportation companies are liable to a fine of \$100 for bringing any idiot, imbecile, epileptic, or a person having tuberculosis or a loathsome or dangerous contagious disease, if the alien's condition could have been detected on embarkation (Sec. 9). Although this provision has been in force several years, the fines collected in 1911 amounted to \$24,600, showing that the companies are willing to take considerable risks. It has been found that they sometimes protect themselves by requiring a deposit of the amount of the fine. The Immigration Commission recommends increasing the fine to a maximum of \$500, leaving the minimum as at present. Your committee endorses this recommendation.

Your committee has had access to the results of a questionnaire sent in 1911 to all living graduates of the Harvard Medical School.

Of the replies received all but five favored a more rigid inspection of immigrants and the application of more thorough physical and mental tests. Many doctors having experience in immigrant localities wrote strongly to the effect that the present inspection is not sufficient.

Your committee recommends the adoption of the following resolutions by the Eugenics Section for transmission to and adoption by the American Breeders Association; and further recommends that the Secretary of the Association send copies of these resolutions to the President of the United States, and the members of the Immigration Committees of the Senate and House of Representatives:

WHEREAS it appears that in spite of existing immigration legislation, and the faithful enforcement of such legislation by the Commissioners of Immigration at New York and other ports, many mentally and physically defective aliens obtain entrance to this country, to the detriment of the public health, and of the eugenic future of the race, and to the burdening of the public treasury,

RESOLVED: That in the opinion of this Association the decision known as "Decision No. 120" and the decision that minor children of naturalized aliens are exempt from the operation of the immigration laws should be at once reversed.

RESOLVED: That the period of deportation (except in the case of immoral persons, as to whom there is and should be no limit of time) should be extended to five years, and that the burden of proof should be changed so that the alien must show that the cause of his becoming a public charge arose subsequent to landing.

RESOLVED: That the fines imposed on transportation companies for bringing inadmissible aliens be made to cover also the bringing of insane persons, and that the amount be changed to not less than \$100 nor more than \$500 in each case.

RESOLVED: That enlarged facilities should be given the Commissioners of Immigration at the various ports, especially at Ellis Island, in order that a more thorough examination of aliens may be possible; and that a sufficient number of expert alienists should be appointed to examine mental cases.

Professor Boas dissents from the conclusions and recommendations of the Committee.

THE EUGENICAL ASPECT OF VENEREAL DISEASE

H. E. JORDAN^a

University, Virginia

The most insistent reason for the eradication of the venereal diseases, namely, the eugenic, does not seem to have received adequate popular emphasis. Public sentiment is gradually being evolved, and legislation framed, to protect the race against the reproductive libertinism of the pauper, the criminal, and the idiot. Also, society is now quite generally fully protected against such serious contagious diseases as diphtheria, scarlet-fever, and small-pox. But nothing short of criminal negligence still prevails almost universally in the matter of protecting both the present generation and the future race against the dangers of syphilis and gonorrhoea. There exists not a single valid argument against the legal registration, isolation, detention, and prohibition of marriage of certain classes of patients. It is the purpose of this note to present what appear irrefutable arguments for the statutory limitation of venereals, to attempt to discover the speciousness of the arguments sometimes urged against legal restrictive measures, and to evoke discussion of this matter so supremely significant from the standpoint of the future race.

A serious consideration of the widespread prevalency and racial harm of the "social diseases," leaves no shadow of doubt that they are fundamental and extremely pernicious anti-eugenic factors. Attention to other eugenic endeavors will be of little avail unless we include in our program a crusade to the death upon venereal disease. No interest can be paramount to that of the race. There can be no loftier motive than to aid in the production and universal establishment of the highest type of physical, moral, and intellectual man, within the limits of human protoplasm. This being granted, all questions of practicality and constitutionality must give way to *right*. Nothing can be more practical than the elimination of economic and racial inefficiency. When we agree that it is right to eradicate venereal diseases—and no one will seriously argue the point—then it would seem that those measures which will most speedily effect this condition are the most justifiable. The personal liberty and individual comfort of the unfortunates need, and should, be regarded

^a Chairman of the Eugenes Section of the American Association for the Study and Prevention of Infant Mortality. In slightly altered and amplified form this paper was presented at the Cleveland meeting, October 3, 1912.

only to an extent not incompatible with full protection to society and the race. Society surely has a right, even an obligation, to guard its well-being against destructive and deleterious agencies.

Under the heading Prudery, in an article on "The Sterilization of Criminals and Defectives," Dr. John N. Hurty, State Health Commissioner of Indiana, writes thus:

What are we doing for posterity in the protection of human blood and human health? We are permitting thousands, tens of thousands, hundreds of thousands of human beings to marry and reproduce their own kind, when at the time of their marriage they are deviates or they are afflicted with unmentionable diseases which if they will not directly cause death, will visit themselves to the third and fourth generation in the forms of blindness, bone disease, insanity, imbecility and all varieties of tuberculosis and cause nervous wrecks, moral degenerates, and perverts. We are doing this because we will not stop it, not because we cannot. 'Tis puling, pury prudery which prevents. We are filling our almshouses, hospitals, jails, penitentiaries and homes for the morally and physically unfortunate, by our refusal to meet the social question, the sex problem, the prevention of the procreation of degenerates, in an honest, sensible, pure-minded manner. The medical fraternity knows the horrible price modern society is paying for this prudery. Their hospital records and the records of their private practice, were they made public, would be the blow that would stagger humanity.

The need for some radical immediate action is surely obvious. But what can be done? And how? The problem is more difficult than that of preventing the reproduction of ordinary defectives. Here sterilization (vasectomy) can be resorted to. But such measure will not help in the case of syphilis and gonorrhoea, for the infection would still remain. Registration, in order that the public may be in a better position to protect itself against this type of infection; detention under custodial care, until pronounced permanently cured by expert authority, in order that the source of infection may be properly controlled; and legal prohibition to marriage, in order that innocent and noble women may not be betrayed into a life of misery and sterility and that children may not be born with blighted heritage. One or the other of these safeguards alone will not be effective in meeting the demands of the situation; all together, coupled with an educational propaganda, must be observed coincidentally.

What are the difficulties regarding registration? First, expense. But in a country as potentially rich as America, and one that spends more than \$100,000,000 annually in caring for its defectives and unfortunates, this additional expense is a mere bagatelle. The creation and maintenance of the necessary machinery for registration

are relatively simple matters. How will regulation effect the solicitation of professional help on the part of those infected? Will not some continue untreated, become more virulent foci of infection and of protracted standing, suffer needless incapacity, and die a needless death in consequence? Possibly. But this condition is an inevitable transition phase from the old to the new order of things. Moreover, it being common knowledge that infected individuals will be registered in the department of health, any candidates for debauch may be restrained from taking the risks. Once the public is properly informed concerning the true and serious nature of these diseases, public sentiment will not simply tolerate, but indeed demand, registration.

What are the difficulties in the way of custodial care? Again, great expense. But wars have been fought and are being paid for; enormous quantities of tobacco, liquor and narcotics are still being consumed—without good, indeed with positive harm to the race—and the whole expense is patiently and cheerfully borne. Perhaps if it were made clear to our generation that, in consequence of our supine indifference and our shortsighted satisfaction with simply palliative measures, our children and grandchildren will inherit heavy burdens in the shape of enormous demands for the support of ever-increasing misery and incompetence, and that the welfare of the race is being jeopardized, we might become willing to sacrifice the enjoyment of superfluous comforts for this altruistic and of racial salvage. Surely no other course seems to hold such promise of permanent solution.

What are the difficulties in the way of procuring and enforcing restrictive legislation against the marriage of gonorrhoeal and syphilitic patients? In this case, only relatively small expense. But we we will have to combat here legislative lack of information, public prejudice, moral inertia, legal conservatism, clerical and institutional opposition, medical professional ethics, and the universal traditional fetish of "personal liberty" and "equal rights." Perhaps all that is needed, however, to overcome the opposition is a common sense educational propaganda. Progress may be slow, but a successful issue is inevitable.

Dr. Charles Elliotts' remarks (*The Crusade for Sex Hygiene*) seem pertinent:

It is absolutely inconsistent with all other public health measures that venereal patients, patients with syphilis or gonorrhoea, should be allowed to keep these diseases secret, should be walking about the streets, working in the shops

and factories, sitting in the street cars, and frequenting the hotels. We do not allow such conduct nowadays with regard to any other contagious diseases. . . . It is high time, gentlemen, that this practice within the medical profession should be brought to an end, and that all venereal diseases should be registered and made subject to control as scarlet fever, diphtheria, and small-pox are. Indeed, the reasons for publicity with regard to venereal diseases are stronger than they are with regard to any other of the contagious diseases. In the second place, cities and states should make large public provision in dispensaries and hospitals for the treatment of the venereal diseases. They should be treated with a view to prevent their further distribution through the community.

In the third place, the practice of the medical profession needs to be completely changed in regard to their sense of responsibility towards innocent people who may be infected by persons whom the physicians know to have venereal disease. That is a very important point, and it is going to be a very difficult point in the prosecution of this crusade. It is the practice of many physicians to conceal the fact that the young man who is under treatment for venereal disease is so affected, even when the physician knows that the young man is about to marry an innocent girl. Many physicians justify that concealment, and say it is the only mode of action consistent with the general ethics of the profession, namely, a sacred confidence between the physician and his patient. That sort of ethics ought no longer to be endured.

But the most important phase of the evil, the primary cause of its considerable prevalency even among the better classes, remains to be considered, namely, prostitution. The publication of the Report (1911) of the Vice Commission appointed by the Mayor of Chicago—a commission composed of some of the best men and women of that city—gives cause for hope that measures for the extermination of prostitution will soon receive more general intelligent consideration. Above all, the report makes very clear that prostitution is not a negligible evil, but one of prime and fundamental import. When we are told that in Chicago alone \$16,000,000 are the profits annually accruing from this vice, served professionally by 5000 (the most conservative estimate) potentially useful young women, and patronized by thousands of the best young manhood of our country, the evil appears as the most momentous that society has to contend against. For the ruin of this fair manhood, the consequent frequent suffering and sterility of their later marriage-mates, and the blasting of little children's lives presents a picture truly appalling. Multiply Chicago proportionately by the number of cities in this country and the world, and then contemplate the enormity of the results in terms of misery, degradation, poverty, blasted homes, ruined lives, and racial injury! Truly, this is not an evil that we can longer afford to harbor and neglect. Miss Jane Addams, of Hull House, Chicago,

in her recent series of four splendid articles in *McClure's Magazine* (1911-12) on "A New Conscience and an Ancient Evil," sympathetically portrays the evil in faithful colors and proper perspective. She would pay the price of another Civil War to rid the country permanently of this curse, and deem it infinite gain. It is most gratifying that social workers of her type and caliber sternly refuse to compromise with medical inspection, segregation, or "regulation"—in short, with anything less than absolute eradication. To say that to abolish an evil as old as the race is impractical or impossible is to belie one's native aspirations for a better world, and one's perennial faith in the final triumph of right. If prostitution ought to be abolished if it be possible, *then it can be abolished, for what is right is possible*. Indeed, for the life of the nation and the race it *must be abolished*.

One wishes to solicit here especially the help of the medical profession who too frequently simply connive at prostitution and its sequelae of disease; and of the clergy who largely ignore the latter in their relation to marriage. It is wrong also that physicians to venereal patients should count fidelity to the Hippocratic oath as of more consequence than the saving of an innocent girl from a necessarily unhappy marriage, and her possible offspring from probable defect. If the Hippocratic oath works such ill it ought no longer to be administered. Nor will properly trained high-minded physicians any longer respect it in those instances where it means harm to an unsuspecting individual or the unborn race.

Men have long-held the legislative reins. Concerning those matters which relate most closely to woman's welfare and that of the race they have sometimes been indifferent and at other times they have largely bungled. They need expert advice from those most concerned, the women, to whom the future race is most closely related. Only woman can fully know the price paid for human life. She will no longer tolerate to have so valuable a thing so recklessly produced and so ruthlessly squandered.

Women will soon be universally admitted to equal suffrage with men, because it is *right* that they should be if they desire. The suffragist movement contains great possibilities for powerfully abetting the eugenic propaganda. Woman will legislate to properly protect herself as the "mother" of the race against wanton infection. She instinctively feels more keenly the importance of conserving the greatest national asset, human life, and will bring about proper action for the preservation of the best elements of the race. Of

course we shall probably have to pass through a period marked by radicalism and extremes. This is perhaps inevitable. But eventually men and women will together work out some ethical code of life in accordance with the best eugenic ideals.

THE FERTILITY OF HYBRIDS IN A MAMMALIAN SPECIES-CROSS

JOHN DETLEFSEN

Laboratory of Genetics, Bussey Institution, Harvard University

Sterility is a common phenomenon in the hybrids obtained by mating members of distantly related groups or types, both in animals and in plants. In fact, there is a tacit understanding among the taxonomists that members of the same species produce fertile offspring when mated inter se; but a successful cross between members of different species or genera may result in sterility of one or both sexes among the hybrids. In case both sexes are sterile, a further genetic study becomes impossible. When one sex alone among the hybrids is sterile, that sex is usually the male; and since the females are fertile, it becomes possible to study the inheritance of characters and fertility of offspring by crossing these female hybrids back to the males of either parent species.

Among mammals, at least, work on inheritance and fertility in species crosses is in its inception. Various compilers, such as Rörig and Przibram, have given lists of mammalian species crosses, with brief mention of the partial or complete dominance of one parent, and the fertility of the hybrids, when known. Grateful as we are for the facts that are thus accumulated, we must, nevertheless, admit their general inadequacy; for most mammalian species crosses were made by those who were merely interested in sheer possibility of the cross. Those breeders who are interested in the economic mammals have been the most fortunate, because most attention has been directed to their study. The consensus of opinion is that the time-honored cross between horse and ass results in sterile male mules but that the female mule is occasionally fertile with either the horse or ass (Waldow von Wahl, 1907). The zebroid (zebra \times horse) is supposedly sterile in both sexes (Ewart, 1899; Iwanoff, 1911). The same is true of the zebrule (zebra \times ass). When the cow and bison are crossed, they produce fertile female catteloes, but sterile males (Boyd, 1908; Iwanoff, 1911).

The offspring of the fertile female mule have merely been mentioned, but further reports regarding their fertility and other characters are lacking. The female hybrids between the cow and bison have been crossed back to males of both parent stocks, thus producing one-quarter bison, or three-quarters bison. The one-quarter bison females are fertile, as may be expected. The three-quarters bison female have not been fully tested, but are possibly also fertile. The one-quarter bison males are not always fertile, for Boyd reports the appearance of but one out of four tested males. Iwanoff reports a fertile three-quarters bison male; and supposes, on purely theoretical grounds, that a mating of such a fertile male with a quarter-bison female would result in fertile one-half bison of both sexes.

Material.—It has been the good fortune of the writer to work with the progeny of a mammalian species cross which in many respects is comparable to the horse-ass cross and bison-cow cross. It is my purpose to report briefly on the fertility of these offspring. The parent species were the wild Brazilian cavy (*Cavia rufescens*) and the domesticated guinea-pig (*Cavia porcellus*). The two forms differ consistently and clearly in color, texture of hair, size, shape of skulls and skull sutures, tooth formation, and the like. There is no doubt but that the two parent stocks are separate species; for, even if the evidence of the systematist were really arbitrary, such evidence must obtain more weight when one considers that the male hybrids are completely sterile.

The original crosses between these two species were the result of mating the wild males to the tame females. The reciprocal cross was not attempted, for, it was feared that the smaller wild female would succumb in pregnancy when mated to the much larger sized tame male. The wild males were wholly fertile, with tame females, although matings were secured only with much difficulty. The tame females bore their hybrid young in due time and with the usual guinea-pig average per litter. Now since the average number per litter in the tame guinea-pig is much larger than in the wild, and since a tame female gives this larger average, even when impregnated by a wild male, we have every reason to believe that such wild males are wholly fertile with tame females and the abundant number of spermatozoa insures complete fertilization. Having obtained these one-half wild hybrids, the females were mated back to the wild males and the tame guinea-pig males, producing three-quarters wild, and one-quarter wild respectively. The matings to the wild males were not very successful and only one three-quarters wild male was reared

to maturity. He was sterile. The matings to the tame males were wholly successful, and produced 83 one-quarter wild. Pursuing the same method of mating the hybrid females of one generation back to the tame guinea-pig males, there were produced a regular series of more dilute wild-blooded generations ranging from $\frac{1}{4}$ wild to the $\frac{1}{51\frac{1}{2}}$ wild. In all, over 1700 hybrids of various blood dilutions have thus been produced. The fertility of about 400 male hybrids has been tested. All female hybrids are fertile.

Problems.—The wild males were wholly fertile in captivity, hence captivity itself may be eliminated as a factor causing the sterility of their less wild hybrid sons. The problem immediately suggested itself: how great must be the blood dilution, or for how many generations must the hybrid females be crossed back to the guinea-pig in order to eventually produce fertile male hybrids? When fertile male hybrids were produced, would all their offspring be fertile in both sexes, if such males were mated to their hybrid sisters or guinea-pig females?

Method.—To judge an animal's fertility, the breeding test is hardly sufficient. It is well known that a male may be potentially fertile, and yet fail to show it because of some physiological state, such as the emaciation of sickness or the sluggishness of obesity. Furthermore the number of males to be tested increased so rapidly that facilities were lacking to breed all of them. Hence, another test was devised. By making a small incision in the scrotum and puncturing the epididymis at one or several points, and placing the liquid contents in a normal salt solution at bodily temperature, with the aid of a microscope a complete index of the male's fertility was obtained.

Results.—Now, whereas any male always gave the same microscopic test during his adult life, there was a great difference between individual hybrids. Some males might not possess any sperm at all; but in their place were found a few or many incompletely matured spermatogonia. Other males might possess a few non-motile or motile spermatozoa in addition. Still others might have an abundance of motile spermatozoa, just as any normal male. All grades and combinations were found; but the last class alone could be successfully mated to females. Fully 200 offspring from such males have been born.

The results of the experiments on the male hybrids up through the sixth generation are given in the table presented. The one-half wild hybrid males had no spermatozoa. The succeeding generations

of less intense wild males present a consistent series, in which a continually increasing percentage of males show spermatozoa. Of the 21 males tested in the sixth generation, or the $\frac{1}{64}$ wild, all had spermatozoa. But the mere presence of sperm does not produce fertile males. In order that fertilization of the egg shall take place, the sperm must be motile to reach and penetrate the egg. Many males with immotile sperm were mated to females, but invariably gave the same result: no progeny.

When we consider those males which had any motile spermatozoa whatsoever, we find the same sort of a series. The $\frac{1}{2}$ wild hybrid males had no sperm and naturally would have none which were motile. The $\frac{1}{4}$ wild males likewise had no *motile* sperm, although we saw in the previous column that 25 per cent showed sperm. The $\frac{1}{8}$ wild males were the first which showed motile sperm, and were likewise the first to be successfully mated with females. The per-

Table of fertility of hybrid males.

Class of hybrids.	Total number tested.	per cent with any sperm.	per cent with any motile sperm.	per cent readily fertile.
$\frac{1}{2}$ wild	6	0	0	0
$\frac{1}{4}$ wild	22	25.0	0	0
$\frac{1}{8}$ wild	71	47.8	17.3	9.8
$\frac{1}{16}$ wild	94	71.1	46.6	35.5
$\frac{1}{32}$ wild	89	88.7	62.9	60.7
$\frac{1}{64}$ wild	21	100.0	66.7	66.7

centage of males with motile sperm increased rapidly in each succeeding generation until finally the $\frac{1}{64}$ wild showed 66.7 per cent with motile sperm. So far as I have been able to test, it would seem that any male with motile spermatozoa is fertile; but in those cases in which immatured spermatogonia or non-motile spermatozoa greatly outnumber the motile spermatozoa, the chances that such will reach and penetrate an egg are small. An intimate study of the motility of sperm and the possibilities of obtaining offspring from male hybrids, has led me to believe that any male with an abundance of motile sperm is readily fertile. Abundance of motile sperm means at least one-half motile. The last column gives the percentages of male hybrids in each generation, which are readily fertile and which can successfully impregnate females. This last category shows the same sort of increase that the others show. It is therefore clear that fertile male hybrids may be produced in constantly increasing numbers in the offspring of a cross which originally gave only sterile males and fertile

females. In the original cross, elements are introduced or formed which prevent the full maturation of the male reproductive cells, but the female reproductive cells seem unaffected. These disturbing elements may be eliminated by continually crossing the female hybrids back to normal tame males, thus producing fertile male hybrids.

Offspring of fertile male hybrids.—It is not out of place to mention the fertility of the sons of the fertile male hybrids. The male hybrids with an abundance of motile spermatozoa could be successfully mated to female hybrids, and to tame female guinea-pigs.

When a fertile male hybrid was mated to a female hybrid their male offspring were not necessarily fertile. We hardly expected they would be, for the female might transmit the disturbing elements in this cross just as much as when mated to a tame guinea-pig. About forty male hybrids from this sort of a cross have been tested, and they give all grades between absolute sterility and fertility.

When, on the other hand, a fertile male hybrid was mated to the guinea-pig female, all the male offspring have been fertile. This is the expected outcome, for the fertile male hybrid may be regarded as a sort of recessive, in which the disturbing elements introduced in the original cross have been eliminated; and when he is mated to the female guinea-pig, no such elements are again introduced. About thirty male hybrids from this class of crosses have been tested and all found to be wholly fertile.

Practical application.—If the cattaloes, mules, and other mammalian hybrids are at all comparable to the hybrids in these experiments, then fertile races of such hybrids may be produced in the same manner. As a simple illustration, I may say that all the color, coat, size, and anatomical characters known in guinea-pigs, have been transferred to these hybrids. Any combination of these characters may be united with fertility. It is conceivable that desired characters in hybrids between other mammalian species may be combined with fertility of both sexes, in the same manner.

FIRST ANNUAL CONFERENCE OF THE EUGENICS FIELD WORKERS

SUPT. H. H. LAUGHLIN

Cold Spring Harbor, New York

The recent interest in the study of human heredity has led to the development of a new sort of specialist—the eugenics field worker—

whose business it is to go into the home neighborhoods of certain persons for the purpose of studying and charting their family connections and describing each individual of the network with care and accuracy with special reference to traits characteristic of the family. Modern eugenic research which seeks among other things, to determine the manner of the inheritance of traits demands that authentic and extended pedigrees be provided for study. Experience has taught that such data can be secured only by sending trained field workers into the home territories as above mentioned. Up to the time of this conference, which was called by Dr. Davenport at the Eugenics Record Office, Cold Spring Harbor, Long Island, New York, on June 20 and 21, 1912, thirty-two persons had, at some time during the preceding three years, been engaged in this new sort of work. Twenty of these workers were present at the conference.

Prior to this meeting several meetings of the research committees of the Eugenics Section of the American Breeders Association had been held, but there the research committees held sway and the field worker played a secondary rôle. The June meeting, however, was primarily a field workers' meeting. They met for the purpose of exchanging experiences, for receiving fresh inspiration and new ideals, for standardizing the methods of charting authentic pedigrees, and for standardizing the use of descriptive terms. The methods for recording descriptions of individuals and for charting family pedigrees suited to eugenic study were standardized in 1910 by the Eugenics Record Office, the Skillman School for Epileptics, Skillman, N. J., and the Training School at Vineland, N. J., and published in Bulletin No. 2 of the Eugenics Record Office. This Bulletin will shortly be supplemented by Bulletin No. 7—the Family History Book by Dr. C. B. Davenport. This latter bulletin is in reality a field workers' manual.

In view of the rapidly growing demand for trained field workers in eugenics it is doubtless of interest to recall that this method of securing at first hand the data for the careful study of the inheritance of human traits was foreshadowed by Robert L. Dugdale in his work on the "Jukes" in the isolated valleys of New York; by Dr. Oscar McCullough of Indianapolis who, a generation ago, instituted field study of the degenerate "Ishmaelites" of Indiana; and by Dr. Alexander Graham Bell, who made a careful family trait survey of Martha's Vineyard, R. I. Such field work in human heredity has for its purpose the working out of pedigrees of sufficient accuracy and detail to justify prediction as to the hereditary potentialities of selected strains and individuals.

The work in the study of human heredity in America followed closely upon the genetics revival of recent years. Prof. C. W. Farabee, of Harvard University, who made observations on the inheritance of brachydaetylysm, and Dr. and Mrs. Davenport of the Carnegie Station for Experimental Evolution, who made studies in the inheritance of the characteristics of human eye color, and skin color and hair color and form, were the earliest American investigators by the new methods, of human traits. The growth of eugenics research has been so rapid within the last three years that now institutions in Massachusetts, New Hampshire, New York, New Jersey, Michigan, and Minnesota are employing trained field workers. Since this conference was held (the date of this writing is August 15, 1912) this office has made agreements with one institution in Minnesota, one in Illinois, one in New York, one in Pennsylvania, and two more in Massachusetts whereby trained field workers are to begin eugenic studies on October 1, 1912. Two more workers are also to be added to the office staff of the Eugenics Record Office.

This growth is permanent because it is built upon truth. A body of facts, sufficient to enable eugenists to determine the laws governing the behavior in heredity of specific traits, is being built up by the professional work of these trained field workers. Slowly but surely eugenics is wresting from nature the truth concerning the manner of the inheritance of human traits, and it is becoming apparent to state administrative and institution officials, to social workers, and to men of science generally that the problems of the social misfits among humanity are at root biological problems that ultimately must be solved by applying biological remedies, in essence if not in external or social aspect identical, with those applied by the breeders of plants and animals in the rise of domestication. New York State, through its State Board of Charities, has recently established a Bureau of Analysis and Investigation. This is essentially a bureau of eugenics, and will devote its attention to the eugenic aspects of the work of the State Board of Charities. Dr. Gertrude E. Hall is chief of this new bureau, and has recently held its first civil service examination for the selection of field workers. Ultimately every state must look toward the cutting off of its supply of defectives rather than of maintaining more institutions as the final solution of the problem of social misfits, and from the history of the field workers movement in the last three years, it is evident that the states are appreciating the ultimate possibilities of applied eugenics.



FIRST ANNUAL FIELD WORKERS' CONFERENCE, EUGENICS RECORD OFFICE, COLD SPRING HARBOR, LONG ISLAND, NEW YORK, JUNE 20 AND 21, 1912

Standing (left to right).—Mary M. Sturges, employed by the Eugenics Record Office in studying consanguineous marriages on the islands off the Maine Coast. Former Eugenics work, study of family distribution of cancer for the Crocker Cancer Research Fund.

E. P. Moore, employed jointly by the Eugenics Record Office and the New Jersey State Hospital, Trenton, N. J., in studying the inheritance of insanity in the New Jersey State Hospital. Former eugenics assignment, study of family distribution of cancer for the Crocker Cancer Research Fund.

Helen T. Reeves, employed by New Jersey State Home for Feeble-Minded Women, Vineland, N. J., in studying the inheritance of feeble-mindedness in families represented in that institution. Formerly employed jointly by that institution and the Eugenics Record Office.

Elizabeth S. Kite, employed by the Vineland (N. J.) Training School for Feeble Minded Boys and Girls in studying the inheritance of feeble-mindedness in families represented in that institution.

Marion Collins, employed by the Monson State Hospital, Palmer, Mass., in studying the inheritance of epilepsy in the families represented in that institution.

Dr. Elizabeth B. Muncey, employed by the Eugenics Record Office in studying the inheritance of Huntington's chorea in New York, Connecticut, New Jersey, and Pennsylvania families.

Jane H. Ross, employed jointly by the Eugenics Record Office and the Government Hospital for the Insane, Washington, D. C., in studying the inheritance of insanity in families represented in that institution.

Mrs. George A. Hathaway, employed jointly by the Eugenics Record Office and the State Industrial School for Girls, Lancaster, Mass., in studying the inheritance of delinquency in families represented in the latter institution.

Ruth S. Moxcey, employed jointly by the Eugenics Record Office and the Danvers State Hospital, Hathorne, Mass., in studying the inheritance of insanity in families represented in the latter institution.

Ruth W. Lawton, employed jointly by the Eugenics Record Office and the Boston State Hospital, Dorchester, Mass., in studying the inheritance of insanity in families represented in the latter institution.

Veda Elvin, employed by the New York State Reformatory for Women, Bedford Hills, N. Y., in studying the inheritance of traits of delinquency in families represented in that institution.

Ethel C. Macomber, employed jointly by the Eugenics Record Office and the New Hampshire State Hospital, Concord, N. H., in studying the inheritance of families represented in the latter institution.

Florence H. Danielson, employed by the Eugenics Record Office in making a eugenics survey of Woodbury Town, Connecticut. Former assignments, jointly employed by the Eugenics Record Office and the Monson State Hospital, Palmer, Mass., in studying the inheritance of epilepsy in families represented in the latter institution. Employed by the Eugenics Record Office in studying the inheritance of skin color in mulatto families in Bermuda and Jamaica, B. W. I.

Sitting (left to right).—Dr. Arthur H. Estabrook, employed by the Eugenics Record Office in extending the studies of Robert L. Dugdale on the "Jukes." Former assignments, study of the inheritance of albinism in Eastern Massachusetts, and the study of inheritance in the criminal insane at the Matteawan State Hospital Fishkill-on-Hudson, New York, and the study of the heredity of the "Nam" family of degenerates in "Nam Hollow."

Amey B. Eaton, employed jointly by the Eugenics Record Office and the Utah Agricultural College, Logan, Utah, in studying the inheritance of mental and physical traits in the Mormon families in Salt Lake Valley, Utah. Formerly employed by the Eugenics Record Office in seeking data upon the inheritance of biological traits recorded in American genealogies, and in studying the inheritance of mental and physical traits in the Amish sect in Pennsylvania.

Mrs. D. L. F. Woodward, employed by the Skillman (N. J.) State Village for Epileptics, in studying the inheritance of epilepsy in families represented in that institution.

Florence Orr, employed jointly by the Eugenics Record Office and the New Jersey State Hospital, Trenton, N. J., in studying the inheritance of insanity in the families represented in the latter institution. Former eugenics work; in Kings Park State Hospital, Kings Park, N. Y., studying the inheritance of insanity in families represented in that institution.

H. H. Laughlin, Superintendent of the Eugenics Record Office.

C. B. Davenport, trustee and director of the Eugenics Record Office; Director of the Station for Experimental Evolution, Carnegie Institute of Washington, Cold Spring Harbor, Long Island, New York.

William F. Blades, editorial secretary, Eugenics Record Office. Also especially studying the inheritance of hare-lip and cleft palate.

Besides those who attended the meeting, the following have also been engaged in field work in eugenics: Miss Jane Griffith, who was for some time employed in field work by the Vineland (N. J.) Training School; Miss Saidee C. Devitt, now a field worker of the Faribault, Minnesota, School for Feeble-Minded, was formerly employed by the Skillman School for Epileptics in the same work; Mary O. Dranga was formerly employed by the Eugenics Record Office in studying the inheritance of factors in juvenile delinquency in the Chicago Psychopathic Institute and later engaged in extending the work of Dr. Oscar McCullough on the "Ishmaelites" of Indiana; Adele McKinnie is employed jointly by the Eugenics Record Office and the Michigan School for Feeble-Minded, Lapeer, Mich.; Maud W. Moore, formerly employed by the Vineland Training School in eugenics field work; Gertrude C. Cannon, formerly employed by the Kings Park State Hospital, Kings Park, N. Y.; Miss Florence R. Davis, archivist, Eugenics Record Office; Susan K. Gillian, employed by the Eugenics Record Office in studying the inheritance of skin color in mulatto families in Louisiana; Dr. Jaime de Angulo, employed by the Eugenics Record Office in describing the effects of vasectomy upon the inmates of the Indiana Reformatory, Jeffersonville, Indiana, and later in charting out pedigrees of these men with reference to criminalistic traits; and H. H. Le Seur, who has succeeded Dr. de Angulo in the same work.

SOME BIOLOGICAL PRINCIPLES OF ANIMAL BREEDING

W. E. CASTLE

Bussey Institution, Forest Hills, Massachusetts

Animal breeding is the most ancient of all arts. Its beginnings antedate civilization, going back to a time when man lived as the beasts of prey live, subsisting upon such animals as he could catch or kill. As man increased the game began to decrease, and the more provident would keep alive for a time the young of their favorite animal, when taken, until these young had grown larger and would yield more food. Often no doubt, a feeling of attachment grew up between captor and captive and the day of slaughter was postponed until the captive had reached breeding age. If young were born in captivity, the thought must at once have occurred to the observer, "Here is an easier and more sure way of getting food than by hunting; why not raise cattle and sheep rather than hunt them." But not all men reasoned thus or, if they did, abandoned the chase, for this continued with increased vigor. The game grew scarcer and wilder and was pursued into less accessible places. Horses and wild dogs were employed to aid in the chase. Wild cattle were hunted to death and wholly exterminated, and wild sheep were almost exterminated. The disappearance of the wild form gave impetus to the propagation of the tame one. Thus the pastoral stage of man's existence was reached. He moved from place to place in search of forage for his flocks and herds, the dog and the horse being his assistants. The most important of our domesticated animals trace back their existence to this stage of culture. The flocks and herds furnished flesh, milk, clothing and shelter; the horse transportation; the dog defense, aid in the care of the flock, and, not least, companionship. Under the open sky, watching the stars by night and the changing seasons by day, man laid the foundation of the first science, astronomy. In the fertile river valleys, he found he could raise food for himself and his animals when the supply on the plains grew short. Thus agriculture began. It necessitated fixed abode in one spot, regulations as to land-tenure, irrigation, and the like. New uses were now found for the animals; the ox was yoked to the plow, and the horse was harnessed. Thus civilization began, largely through the instrumentality of domesticated animals.

Though animal breeding is the oldest and most fundamental of the arts, its practise down to the present time has been almost wholly

empirical. A science of animal breeding scarcely yet exists, not because thoughtful men have failed to give attention to the subject but rather because of its inherent difficulty. We breed animals as our fathers and grandfathers did because their time-honored methods succeed and we know of no reason for changing those methods. Indeed we can not expect to improve them in a rational way until we learn why certain methods succeed and why others fail. Such knowledge of the underlying reasons for successful practise will when secured constitute a science of animal breeding.

The technique of successful animal breeding is difficult and special in the case of each kind of domesticated animal and can best be learned from an apprenticeship on a farm or study in a farm school. The general principles empirically deduced from centuries of practise may be concisely stated thus:

(1) *Like begets like*, hence the breeder must select for propagation the type of animal he desires to perpetuate.

(2) *Pedigree counts*. The desired type is more certain to occur among the offspring, if it has occurred repeatedly among the ancestors.

(3) *Inbreeding* brings uniformity of type but causes loss of vigor.

(4) *Crossbreeding* increases vigor but destroys uniformity of type.

No one of these generalizations is universally true. To state the recognized limitations and exceptions would be to recapitulate the literature of breeding with the omission only of its technique. The new science of genetics is concerned with the discovery of the reasons for these four empirical generalizations and their various exceptions.

To the very first of the four generalizations there are frequent exceptions as every experienced breeder knows. Like does not always beget like. Thus roan short-horned cattle do not always breed true. They produce their like, roans, in about 1 case out of 2, but in the remaining case an all-red or an all white or a spotted red-and-white animal is likely to be produced. Blue Andalusian fowls are another well known exception to the rule that like produces like. Besides producing blue offspring, Andalusian fowls produce also black ones and white ones. Yellow mice are another unfixable variety of animal. They breed true in about 2 cases out of 3. In the third case a black or brown pigmented animal is produced. Illustrations need not be multiplied; the literature of breeding is full of cases in which like has failed to produce like. Until quite recent years no satisfactory explanation of such cases has been forthcoming. Why a roan variety of cattle or a blue variety of fowl should be fixable to the extent of 50 per cent, whereas yellow mice should be fixable to

the extent of 66 per cent was quite incomprehensible until a general law of color inheritance had been worked out.

The first serious attempt to formulate a general law of heredity was made in 1889 by Francis Galton, a pioneer in the study of genetics. He went about the matter in a systematic way, first collecting facts and then generalizing from them. In studying family records of the height of human beings he observed both that like begets like and that pedigree counts. For tall children are in general born only to tall parents, and the children are more certain to be tall if the grandparents also have been tall. He concluded that the resemblance of children to their grandparents was on the average only half as close as to their parents. Or to express it mathematically, if we call the parental influence one-half, that of the grandparents is one-fourth; that of the great-grandparents one-eighth; and so on, each earlier generation of ancestors exerting only half as much influence as the next later one. This generalization, at first adopted tentatively only, Galton called the law of ancestral heredity. It states the facts of relative average size of ancestors and offspring about as well as we can state them at the present time, but offers no biological explanation of this relation. Nor does it inform us as to the probable limits of size variation among the children. This so-called law of Galton in reality rests on a false biological assumption, viz., that the character of the germ-cell regularly corresponds with that of the parent producing it. Galton himself recognized and pointed out this defect, but could devise no way of obviating it.

In order to test his empirical law more widely Galton in 1897 applied it to a case where it is now clearly not applicable, viz., to color inheritance in mammals. The particular case selected by him for study was unfortunately a peculiarly difficult one, viz., the inheritance of black spots in Bassett hounds. The result was that he reached erroneous conclusions.

The race of dogs studied was the Bassett hounds of Sir Everett Millais, a carefully bred race having the short crooked legs of a Dachshund combined with the spotted coat of a beagle. Careful records had been kept of the breeding of these dogs for many generations. In most respects they had been bred to a uniform type, but in color two different conditions occurred. The dogs were all (or nearly all) spotted yellow-and-white. Part of them bore in addition spots of black, being thus *tricolor* yellow-black-and-white. Those without black spots were called by Galton non-tricolor.

Galton found on examination of the records that parents of one

sort may produce young of the other sort as well as its own, though in smaller numbers. Neither kind, then, breeds entirely true, though each tends to produce its like. It was found further that parents produce a larger proportion of offspring like themselves if the grandparents also have been of that same sort. Hence there exists an apparent ancestral influence which Galton believed to be roughly approximated by his mathematical law. That this influence is apparent only, not real, I have shown elsewhere.^a

Galton had verified in this case as in that of human stature, the two, century-old generalizations, "Like begets like" and "Pedigree counts." He had attempted to measure the force of pedigree in his law of ancestral heredity, but not to account for it.

A more successful attempt to formulate a general law of heredity had been made some years earlier by Gregor Mendel, but this was



FIG. 1.—A FAMILY OF RATS, THE PARENTS AT THE LEFT, THEIR OFFSPRING, A SINGLE LITTER AT THE RIGHT

unknown to Galton as to other biologists of that time. We call it Mendel's law. In accordance with this law, the facts of color inheritance observed by Galton can be more fully explained.

It is a fundamental feature of this law that the characteristics of animals and plants are inherited as units. For example, in figure 1 are seen the skins of a family of rats; of the parents at the left, of their offspring at the right. The parents obviously differ in coloration, and the young are divided in a corresponding way into two groups approximately equal. Five of the young resemble one parent,

^a The Laws of Heredity of Galton and Mendel, and Some Laws Governing Race Improvement by Selection. Proc. Am. Acad. Arts and Sci., vol. 39, pp. 223-242, 1903; On The Inheritance of Tricolor Coat in Guinea-Pigs, and Its Relation to Galton's Law of Ancestral Heredity. *American Naturalist*, vol. 46, pp. 437-440, July 1912.

together in the same individual by cross breeding and then separated out again in later generations.

If instead of crossing a hooded rat with an Irish one, as in the family already discussed, we cross it with a wild gray one, we obtain a different result. The children are all gray like the wild parent, but the grandchildren are of four sorts, gray-all-over, black-all-over, gray hooded, and black hooded, approximately in the proportions, 9 : 3 : 3 : 1. By a cross two new color varieties have been created, the all-black and the gray hooded. It is evident that in this case, as in the foregoing, color-pattern is sharply alternative in inheritance, but the wild parent was homozygous in pattern not heterozygous, so all the children showed that same dominant pattern, and the hooded pattern reappeared first among the grandchildren, in one-fourth of the individuals. But among the hooded grandchildren, as well as among the self colored, both gray individuals and black ones occur. The same pattern occurs portrayed in different tints, gray or black. It is evident therefore that the gray color is alternative to black in the same way that self pattern is alternative to hooded. It is evident further that color and pattern are wholly independent, just as I may write the letter *A* either in red or in blue crayon. There is no necessary relation between the letter which I write and the color in which I write it.

Likewise the hooded, Irish, and self patterns of rats may be portrayed either in black or in gray. Color and pattern in rats are therefore units independently transmitted in heredity and the varieties produced by crossing are nothing but new combinations of these same units. It is conceivable however that a new variety might be produced by actual alteration of one of these units, that the black for example might become blacker, or the gray might become lighter and that the modified units might still behave as alternatives. But the idea has somehow become prevalent among students of heredity that such modification is impossible, that Mendelian units cannot change. We have got in the habit of designating unit-characters by symbols, *A*, *B*, *C*, etc., and we have come to think of unit-characters as no more variable than these symbols. In reality no two organisms are ever exactly alike, and it is doubtful whether any unit-character is ever exactly the same in any two organisms. Some would frankly admit this and yet maintain that what is transmitted is in every case the same, that is that the germinal basis of a unit-character is unchangeable, whatever may be true of its manifestation in the individual. The theoretical consequence of such a view is

that selection can have no effect in modifying unit-characters. This conclusion is frankly avowed by many leading students of genetics. To show its unsoundness, it will be sufficient in a specific case to modify a unit-character. Many unit-characters have been so modified. I will describe a case in which the hooded pattern of rats has been changed by selection. This work has been done with the assistance of Dr. John C. Phillips, though others of my associates have shared in it to a lesser extent.

TABLE 1.—*Results of Selection for Modification of the Coat-pattern of Hooded Rats.*

Description of selection.	Number of generation.	Average grade parents.	Average grade offspring.	Number of offspring.
Plus series shown in figure 2.	1	2.51	2.05	150
	2	2.52	1.92	471
	3	2.73	2.51	341
	4	3.09	2.72	444
	5	3.33	2.90	610
	6	3.52	3.11	861
	7	3.56	3.20	1,077
	8	3.75	3.48	1,408
	9	3.78	3.54	1,322
	10	3.86	3.72	706
	11	3.94	3.76	158
Total.....				7,548
Minus series shown in figure 2.	1	1.46	1.00	55
	2	1.41	1.07	132
	3	1.56	1.18	195
	4	1.69	1.28	329
	5	1.73	1.41	701
	6	1.86	1.56	1,252
	7	2.00	1.70	1,680
	8	2.05	1.80	1,655
	9	2.11	1.92	1,591
	10	2.18	2.01	1,406
	11	2.27	2.16	543
Total.....				9,539

Several years ago the experiment was begun of selecting from a stock of hooded rats extreme plus and minus variates and breeding the two selections separately. The most extreme variations of the hooded pattern at the outset are indicated roughly by grades -2 and $+3$ of figure 2. At first the two series overlapped in the region of grade 0, but soon they ceased to do so and have drawn wider and wider apart ever since. In each generation the most extreme individuals were selected as parents. Table 1 shows the average grade of parents and offspring in each generation. But tables 2 and 3 show the average grade of offspring of parents of a particular grade

in each generation. Attention is called to the following facts concerning the plus selection, that is, selection in the direction of blackness and solid color (table 2).

(1) At the outset the darkest parents we had were of grade 3, now we have parents of grade $5\frac{1}{2}$, an all-black rat being grade 6 (the self condition). It is evident, therefore, that new grades of parents have appeared during the experiment; the table shows that they have come in gradually, $3\frac{1}{4}$ grade parents, in the third generation; $3\frac{1}{2}$ grade parents, in the fourth generation; $3\frac{3}{4}$ grade and 4 parents, in the fifth generation, and $4\frac{1}{4}$ grade parents in the seventh generation. The modification has progressed through all intermediate stages between hooded and self, including Irish.

(2) An examination of the horizontal rows of the table shows that in any generation the higher the grade of the parents, the higher

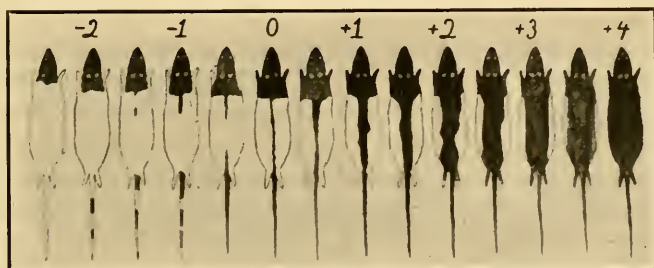

FIG. 2—AN ARBITRARY SET OF GRADES USED IN ESTIMATING THE EXTENT OF THE PIGMENTATION IN A RACE OF HOODED RATS.

that of their offspring. In general therefore the somatic character of an animal in this series is an index of its genetic character. This makes change through selection possible.

(3) An examination of the vertical columns of the table shows that upon the appearance of a new grade of parents, the regression of the offspring is considerable, but with further selection it diminishes. I may add, what this table does not show: that with repeated selection it disappears altogether and is even reversed. That is, the lowest-grade offspring produced by selected high-grade parents do not regress *downward* toward the starting point of the series, but *upward* toward the mode of the parental generation. This indicates that the effects of the selection are permanent, for a new mode has been created toward which regression occurs.

In the minus selection series (table 3) the initial selection consisted of animals between -1 and -2 in pigmentation. Pairs of -2 par-

TABLE 2.—Relation Between Average Grade of Parents and

Average grade of offspring.	Number of generation.	Average grade									
		1.87	2.00	2.12	2.25	2.37	2.50	2.62	2.75	2.87	3.00
1		1.82 (7)	1.76 (18)	1.87 (20)	2.06 (37)	2.15 (5)	2.12 (51)	2.35 (12)
2		1.70 (46)	1.28 (56)	1.87 (8)	1.92 (45)	1.80 (133)	2.11 (44)	1.92 (52)	2.41 (23)	2.47 (59)
3		2.06 (21)	2.15 (17)	2.32 (54)	2.63 (64)	2.46 (43)	2.70 (47)	2.49 (71)
4		2.55 (11)	2.65 (18)	2.97 (37)	2.60 (143)
5		3.00 (12)	2.87 (21)	2.81 (15)
6		3.25 (2)
7	
8	
9	
10	
11	
		Total.....									

NOTE.—Figures in parentheses show numbers of offspring on which the averages in each case are based.

ents occur for the first time in generation 4. Table 3 shows for this series the relation of average of offspring to grade of parents, and the results agree in every respect with those of table 2. Note, that:

- (1) New grades of parents appear as the experiment progresses. We now have parents pigmented only on the top and sides of the head, and with a large white spot on the forehead. If such rats have ever existed elsewhere at any time, I have failed to learn of them.
- (2) The higher the grade of the parents in any generation, the higher that of their offspring.
- (3) Regression grows less with repeated selection and finally changes its direction.

What is the conclusion of the whole matter? We find that hooded, Irish, and self patterns in rats, though Mendelizing as unit characters in relation to each other, are quantitative variations no more stable in character than intermediate stages; that any desired intermediate stage may be produced by selection alone, and when produced is fully as stable as any one of the three conditions named; that in a similar way stages of less pigmentation than any previously known in rats other than albinos have been produced and that there is every reason to suppose that this reduction can be carried forward by selection until all color is eliminated from the coat.

Selection consequently is not a mere agency for the sorting out of unit variations (factors or genes); it is a creative agency by means of which unit characters can be modified and variation can be given

Average Grade of Offspring in Plus Selection Series.

of parents.										Number of Offspring.	
3.12	3.25	3.37	3.50	3.62	3.75	3.87	4.00	4.12	4.25		4.37
.....	150
2.50 (5)	471
3.07 (10)	3.17 (6)	2.91 (8)	341
2.69 (122)	2.89 (64)	2.70 (23)	3.02 (20)	2.75 (6)	444
2.81 (114)	2.81 (138)	2.94 (145)	2.87 (69)	3.08 (64)	3.07 (14)	3.35 (8)	3.36 (7)	3.00 (3)	610
2.84 (28)	3.10 (143)	2.96 (123)	3.10 (212)	3.16 (181)	3.22 (78)	3.26 (80)	3.41 (14)	861
2.87 (28)	3.09 (131)	2.97 (160)	3.18 (177)	3.23 (289)	3.35 (184)	3.49 (90)	3.53 (15)	3.75 (3)	1,077
.....	3.46 (59)	3.50 (484)	3.49 (469)	3.53 (238)	3.31 (64)	3.72 (60)	3.69 (22)	3.96 (8)	1,408
.....	3.25 (4)	3.43 (244)	3.50 (591)	3.65 (424)	3.57 (45)	3.57 (7)	3.75 (4)	3.50 (3)	1,322
.....	3.68 (252)	3.72 (307)	3.76 (107)	3.77 (32)	3.84 (8)	706
.....	3.75 (4)	3.67 (88)	3.88 (55)	3.75 (7)	3.94 (4)	158
.....	7,548

a particular direction, the only limits to its action being physiological limits.

But someone may say, you have considered merely one sort of unit character; grant that this is modifiable, what of the numerous other ones which have been described? In reply I can only say that I confine my attention to one for lack of space. I have not limited my study to one, and I have yet to meet with a unit-character which is not both variable and modifiable. It is only by closing one's eyes to minor variations that one can see gametic purity in heredity. Some recognize the occurrence of these minor variations but deny that they are of any consequence. This is the position of de Vries and Bateson, Johannsen, and Jennings. Bateson for example in studying the inheritance of an extra toe in fowls recognized that it was not always equally well developed; nevertheless he grouped together in one class (having the extra-toe) all animals which developed even a trace of it, and placed in another class (as not possessing it) all which failed to develop an extra-toe, even though some of the latter actually did transmit the extra-toe. Now this is perhaps the best one can do in sorting out the material; but it is clearly unwarrantable to conclude that all fowls with an extra-toe possess a unit character or gene which is wanting in all birds which do not have the toe, or *vice versa*. Clearly toe-character is inherited in various grades precisely as whiteness is in rats. Undoubtedly toe-character also is modifiable by selection; indeed I have fully established this fact in guinea-pigs (1906).

TABLE 3.—*Relation Between Average Grade of Parents and*

	Number of generation.	Average grade						
		1.12	1.25	1.37	1.50	1.62	1.75	1.87
Average grade of offspring.	1	1.34 (8)	0.85 (31)	1.37 (6)	1.05 (10)
	2	1.05 (12)*	1.17 (17)	1.45 (5)	1.11 (37)	0.67 (3)	1.09 (27)	1.10 (12)
	3	0.85 (5)	1.05 (20)	1.03 (28)	1.31 (28)	1.22 (48)	1.26 (63)	1.96 (3)
	4	1.56 (4)	1.16 (29)	1.31 (59)	1.36 (40)	1.34 (93)	1.18 (95)
	5	1.50 (51)	1.25 (53)	1.35 (54)	1.30 (262)	1.64 (143)
	6	1.34 (24)	1.46 (94)	1.49 (244)	1.59 (502)
	7	1.55 (5)	1.67 (32)	1.65 (330)
	8	1.84 (19)
	9
	10
	11
Total.....								

*Figures in parentheses show numbers of offspring on which the averages in each case are based.

I therefore regard as unsubstantiated the genotype conception of heredity in which unit-characters are regarded as indestructible and unmodifiable entities. Organisms are not devoid of variability; neither are the unit-characters which they manifest devoid of variability, nor yet is the germinal basis of such unit-characters devoid of variability. Unit-characters may arise gradually as the result of repeated selection in a particular direction.

I have dwelt thus at some length upon this question because of its theoretical and practical importance. If unit-characters are immutable, then straight selection is a waste of time, and the only procedure for the breeder well worth while is to hybridize and thus seek new combinations of unit-characters. This view has been repeatedly presented in recent years, but has met with scant favor at the hands of experienced animal breeders.

Experienced breeders, to be sure, are not qualified to pass final judgment on a theoretical question, but a theory which will not work out in practice needs careful scrutiny; there is surely something wrong with it. If, however, unit-characters are modifiable, then selection is of value not only in the isolation of particular combinations of units, but also in the improvement of the units themselves.

Mendel's law, in its broad general features, does stand the test of practice. It represents a fundamental general law of heredity. Many of the characteristics of animals and plants are transmitted substantially as units and are therefore capable of recombination in the form of new varieties through the agency of crossing. By apply-

Average Grade of Offspring in Minus Selection Series.

of parents.								Number of offspring.
2	2.12	2.25	2.37	2.50	2.62	2.75	2.87	
								55
								132
								195
1.36 (9)								329
1.52 (109)	1.80 (5)							701
1.58 (283)	1.52 (85)			1.82 (11)				1,252
1.72 (969)	1.74 (260)	1.93 (41)	1.62 (4)	1.88 (15)	2.28 (18)	1.87 (6)		1,680
1.78 (1170)	1.85 (377)	1.87 (36)	1.87 (30)	1.85 (17)	1.66 (6)			1,655
1.90 (811)	1.93 (403)	1.93 (148)	1.91 (175)	2.07 (53)				1,591
1.95 (473)	2.00 (469)	2.04 (197)	2.06 (104)	2.13 (67)	2.16 (49)	1.97 (27)	2.19 (20)	1,406
2.08 (48)	2.14 (149)	2.15 (144)	2.18 (117)	2.24 (45)	2.09 (19)	2.33 (16)	1.95 (5)	543
								9,539

ing Mendel's law to specific cases one is able to predict with a considerable degree of accuracy what combinations will result from a particular cross and in what proportions these will be produced. Such a practical test is the best possible evidence of the correctness of a theory. Mendel's law throws light on each of the generalizations of empirical animal breeding previously enumerated:

It throws light on those recognized exceptions to the generalization that like begets like, and shows under what circumstances those exceptions are to be expected.

It shows why and when pedigree counts, and under what circumstances a knowledge of pedigree is of no consequence whatever.

It shows why inbreeding brings uniformity of type, and crossbreeding destroys it.

Mendel's law is then a first step toward the establishment of a *science* of animal breeding. But it is only a first step on a long and weary road, and we must be careful not to misinterpret or misapply it. Otherwise we are liable to be turned aside from the direct road of progress. We must not, for example, conclude on insufficient evidence that unit-characters possess an immutability which organisms do not possess. It is the purpose of this paper to insist on this point. Further we are not yet warranted in concluding that all inheritance is unit-character inheritance. A too sweeping generalization of this sort may also lead us astray. Let us proceed with enthusiasm, but with caution, noting well our landmarks.

The practical utility of Mendel's law is much greater to the plant

breeder than to the animal breeder, because the plant-breeder is concerned largely with the production of a very few first generation or second generation hybrids of merit, which are then multiplied indefinitely by asexual means or self fertilization. In the case of the domesticated animals such methods of multiplication are impossible. Every individual produced has two parents, and purity of race in the parents is indispensable to uniformity of type in the progeny.

As a theoretical foundation principle Mendel's law is equally valuable to animal breeders and to plant breeders.

HORSES AND HORSE BREEDING^a

H. K. BUSH-BROWN

Washington, D. C.

In a former article published in the *American Breeders Magazine*, I suggested that the best race horses, both trotters and runners, be studied anatomically in their living active form, and from the skeleton after death, as a means of mathematically determining what differences there are in structure. This would enable us to not only establish a method of defining types but also to ascertain which structural propositions are the most favorable to speed and endurance, and in what way the runner differs from the trotter. Every horseman recognizes the differences of proportion at a glance and by instinct, but so far as I know they have not been reduced to mathematical and comparable terms.

No one will question that the separate types of horses which we breed and keep for specific purposes, are the results of selective breeding, and that the differences between breeds are largely a matter of differences in the proportions of the structure of the skeleton. And this suggests the need of an accurate and reliable method of measuring the bodies of individuals, which will make full allowance for variations in size, so that not only large and small individuals of the same breed may become comparable, but also individuals belonging to different breeds, and even the same individual in different stages of growth. Such a method must clearly be based upon a unit common to all individuals, and upon a comparison of proportions rather than upon absolute measurements.

^a This is the second article of the series on Horses and Horse-Breeding begun by the author in *American Breeders Magazine*, vol. 11, no. 2, and no. 3.

I therefore submit to the consideration of animal breeders a system which I have devised after much study and experimentation. It is as follows:

The height of the horse at the withers is divided into three equal parts denominated "heads"; in order to facilitate closer measure-

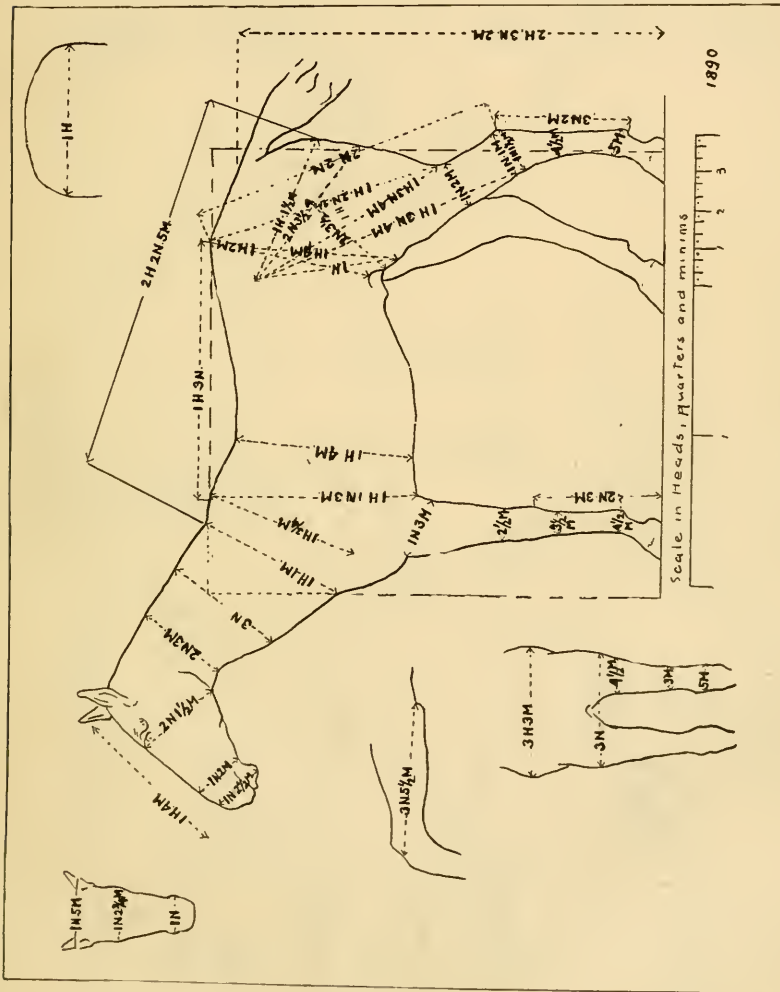

FIG. 1—WOOLSEY.
Sixteen hands, 1 inches.

ments the "head" is divided into four further parts, called quarters; each quarter is divided into six parts called minims. In the diagrams Figures 1 to 5 these denominations are abbreviated H for "head," N for "quarter" and M for "minim." By this scale, no matter what

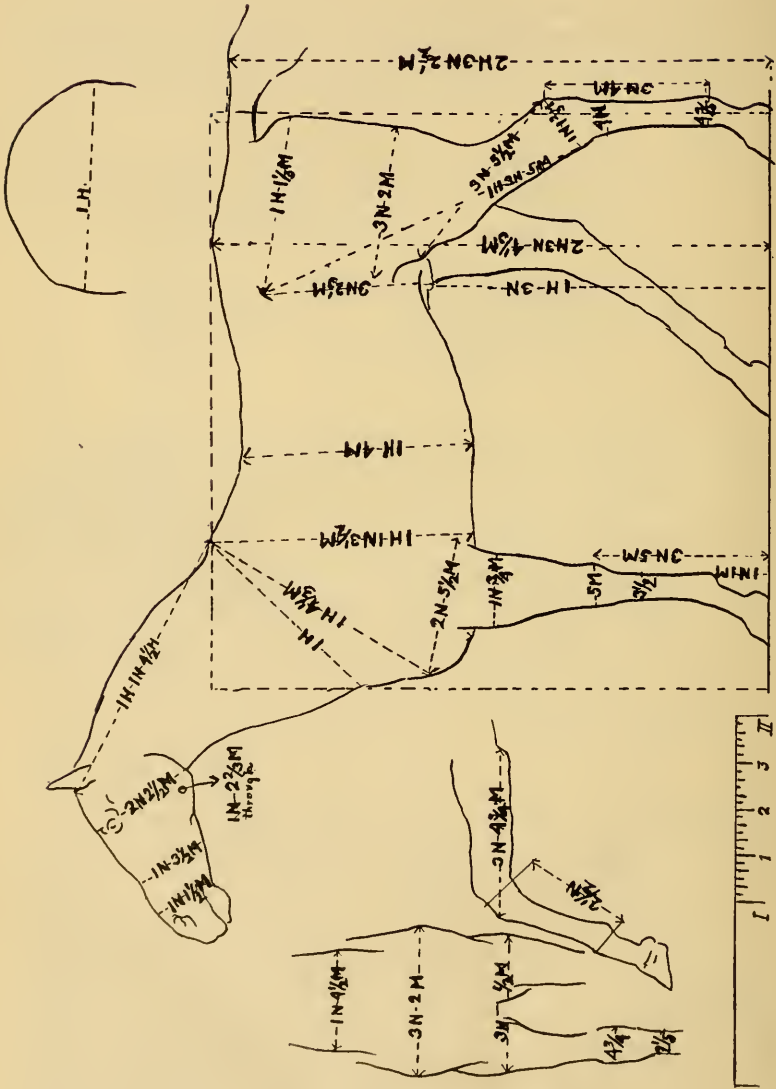

FIG. 2—LEOPARD.
Fourteen hands, 3/4 inches.

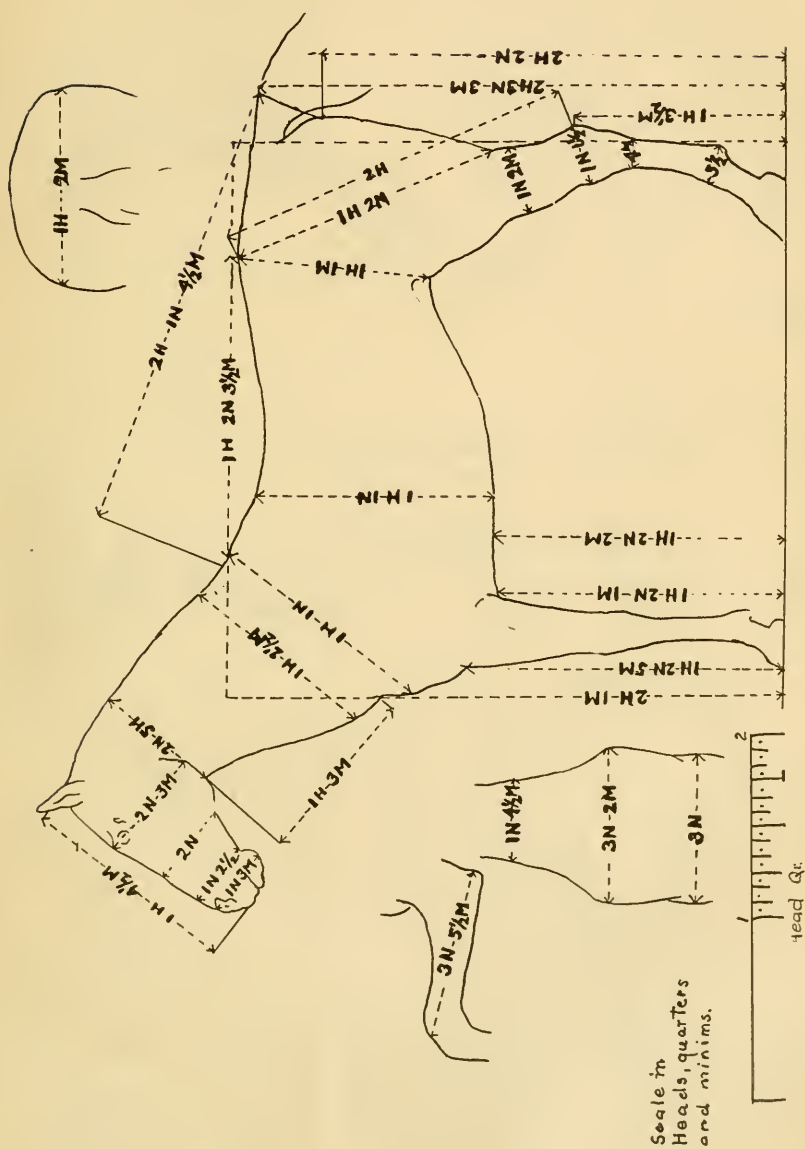

FIG. 3—ETHAN ALLEN 3D.
Fourteen hands, $3\frac{1}{2}$ inches high, 15 hands, 2 inches long.

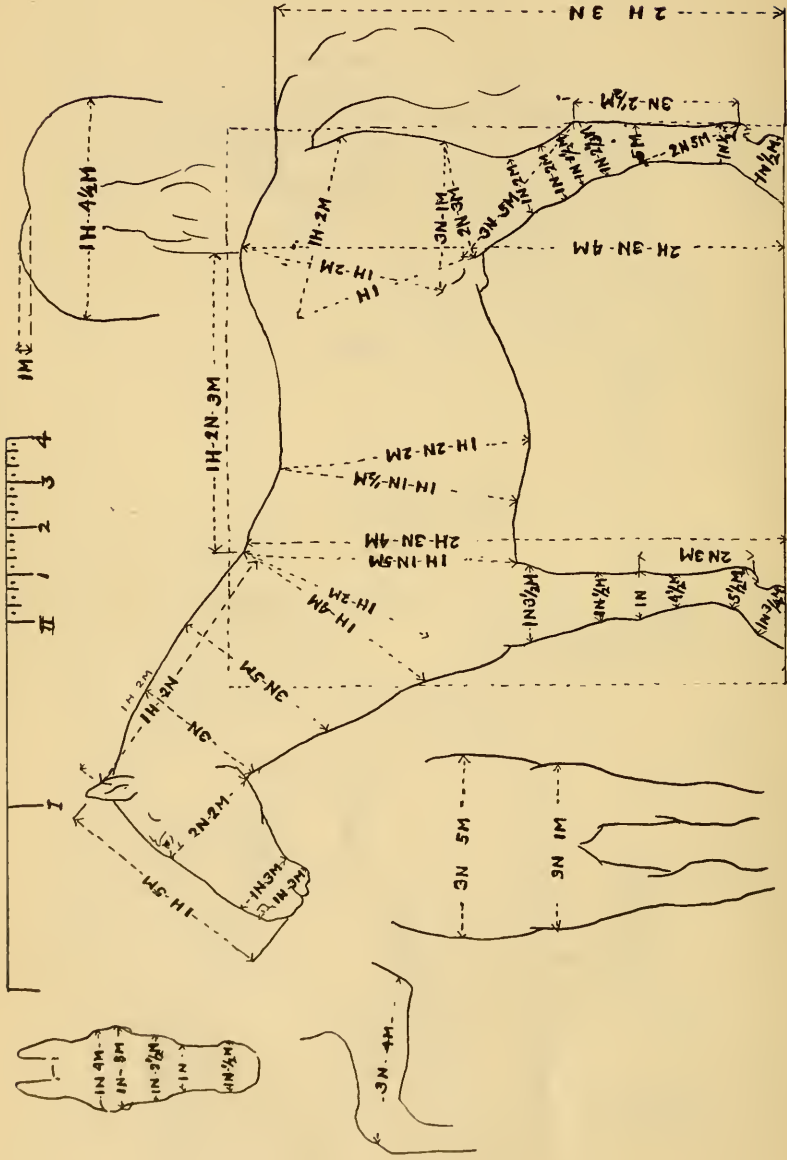

FIG. 4—HONS FLEUR.
Imported Norman, 17 hands, 1 1/2 inches.

size the individual is, his own height determines the unit of his measure. By setting down all the actual proportion measurements, on this scale, an exact record of the form and structural peculiarities of an animal may be obtained which may be available for comparing other individuals, whether living or dead. With help of those proportion measurements a sculptor or painter can reproduce an exact form of some one individual horse, in drawing or painting or in model in any size.

A system of absolute measurements is of no value whatever when we come to compare individuals of different sizes, even within the same breed. Similarly, a comparative measurement based upon the circumference of an animal, as unit, is of little value. On the other hand, by means of the system of measuring as outlined above, the exact outline, as presented to the eye from any given point of view, can be reproduced.

By determining what constitutes the perfect type of Thoroughbred, Morgan, Trotter, Percheron or other breed whatsoever, each horse in his own type, can be measured and standards of proportion be established for that type. If the breeders would work this out on an agreed system, the judges in a show ring would have an exact mathematical test to assist their judgment as formed by visual comparison and experience.

To illustrate the manner of using this method, the proportion-measurements of "Woolsey" are given in Figure 1. Woolsey was an old time trotting sire, the full brother of Sunol.

For purposes of comparing breeds, I add the measurements of the imported Arab, Leopard, presented to General Grant by the Sultan of Turkey, Figure 2; Ethan Allen 3d, a typical Morgan, Figure 3; Hons Fleur an imported Norman, Figure 4, and also of Red Lion, Figure 5, a cross bred son of the latter from a thoroughbred dam.

The same system of measuring may be applied to cattle, but a cow's body does not fill a square as does a horse; so instead of taking the height of the cow at the withers it is necessary to take the length from the front of the shoulder to the end rump bone or illium, and divide this length into three and this into quarters and minimis the same as for the horse. With this scale the cow will be found to be as harmoniously proportioned as the horse, and to be one-half a head lower at the withers than the horse.

I am inclined to believe that the reason why the large number of records of measurements of individual cows, massed in the herd

books of the Holstein Friesian Association have been difficult to digest and to utilize for statistical work, was that all these measurements were absolute and therefore not comparable except in averages comprising large numbers of cows. This system of notation of proportions applied to a large number of cows would furnish us most exact data on the question of form and function, and would enable us to determine whether, and if so in what particular, of form of physical conformation or of type the 14 pound cow differs from the 20, 25 and 30 pound cow. All measurements, so far made on growing cattle from calthood to maturity, have given no positive results because the data concerning even the same individuals were not comparable.

With this scale standard types of cattle can be established by averages or otherwise the same as has been suggested for horses. I have measured the stuffed specimen of a giraffe and find that the length of his head bears the same relation to the length of his body as is found in the horse. It would be interesting to know to how many mammals this system of measuring can be made to apply.

COMPARISONS OF YIELD BETWEEN HYBRIDS AND SELECTIONS IN OATS^a

DR. H. H. LOVE

Ithaca, New York

The purpose of this paper is to set forth the results of some attempts to improve the oat crop by selection and hybridization. This work has been under way at the Cornell Experiment Station for the past five years. The hybrids and selections were made by Mr. J. B. Norton, of the United States Department of Agriculture. The preliminary work was done in Illinois but on accepting a position in the Plant-Breeding Department of the Cornell Agricultural College, Mr. Norton brought a set of the hybrids and selections to New York. After a year at Cornell Mr. Norton returned to the Bureau of Plant Industry and the testing of the hybrids and selections has been left for others to do. The writer has had charge of the work for the past four years.

The work originally consisted in planting rows, a rod in length, of the different strains and repeating the series on a different type of soil. Later, however, the different strains were planted in rod-rows

^a Paper No. 31, Department of Plant-Breeding, Cornell University, Ithaca, New York.

and the rows repeated a number of times. The rod-row system is used by this department for all small grain work. Some of our results were furnished Dr. T. L. Lyon, of this Station, to compare with some plat tests and it was found that the rod-row repeated a number of times is apt to be more nearly correct than a large plat repeated only once.

The following varieties and combinations were represented in the hybrids and selections tested:

Series.	Hybrids.	Series.	Selections.
27	Garton's Tartar King × Clydesdale	62	Sixty Day
31	Burt (Early White) × Texas Red Rust-proof	63	Burt (Extra Early)
		120	Silver Mine (Great Dakota)
32	Burt (Early White) × Early Champion	123	Welcome
34	Burt (Early White) × Sixty Day	132	Sixty Day
42	Asia Minor Rustproof (3676) × Clydesdale	137	Early Champion
		138	Early Champion (Prosperity)
49	Sixty Day × Clydesdale	5938	Sixty Day
50	Sixty Day × Probsteier		

The strains showing the highest yield in 1907 and 1908 were sown in a larger number of rows in 1909, in order to give them a fairer test. These strains were also repeated in 1910 and 1911. In the following table the ten best selections and hybrids are shown with their average yields for the three years. This table includes only strains which have been tested 5 to 8 times in 1909, 8 to 13 times in 1910 and from 15 to 21 times in 1911.

Three year average, 1909 to 1911.

Hybrids.		Selections.	
Pedigree No.	Average yield bushel per acre.	Pedigree No.	Average yield bushel per acre.
31a1-16-1.....	51.7	132-2.....	47.3
34a1-24.....	51.8	62-II-17-1.....	49.4
49a2-18.....	52.1	63-1-4.....	49.5
49a1-27-1.....	52.4	62-II-6-3.....	51.1
50a1-22.....	53.1	62-II-6-2.....	51.1
49a2-13.....	53.6	62-II-18-1-1.....	54-5
49a2-20.....	54.0	5938-1.....	54.6
49a2-22.....	54.3	123-5.....	57.3
50a1-10.....	55.0	120-9.....	57.7
34a1-11-2.....	62.1	62-II-18-3.....	58.6
Average.....	54.0	Average.....	53.1

This shows an average yield of 54 bushels for the hybrids and 53.1 bushels for the selections. The highest yielding strain for the three

years is a hybrid, while the three strains ranking next in order are selections.

It seemed desirable to know how these new sorts would compare with some of the well known commercial varieties and such a test was begun in 1910 and continued in 1911. The seed of the commercial varieties was obtained from different seed houses. The hybrids and selections, together with the commercial varieties were sown in rows and these rows repeated usually 21 times. The results for the ten best hybrids and ten best selections, together with the results for the 8 best commercial varieties, are shown in the following table:

Two year average, 1910 and 1911.

Hybrids.		Selection.		Varieties.	
Pedigree No.	Average yield bushel per acre.	Pedigree No.	Average yield bushel per acre.	Name	Average yield bushel per acre.
49a2-13.....	55.5	62-II-17-1.....	53.0	Black Tartarian...	40.7
34a1-32-1.....	56.0	5938-1.....	53.5	Golden Giant Side	42.3
34a1-28-2.....	56.9	63-1-4.....	54.2	White Tartar King	45.5
49a2-16-10.....	57.4	62-II-6-3.....	54.9	Welcome.....	47.8
49a2-18.....	57.9	62-II-6-2.....	55.0	Swedish Select....	52.0
50a1-10.....	58.3	33a1-15.....	56.0	Danish Island.....	54.0
50a1-22.....	59.6	120-9.....	62.3	Silver Mine.....	61.4
27a1-31.....	60.3	123-5.....	62.6	Lincoln.....	62.4
49a2-20.....	61.7	62-II-18-3.....	64.3		
34a1-11-2.....	66.5	62-II-18-1-1.....	65.1		
Average.....	59.0	Average.....	58.1	Average.....	50.8

This table shows an average yield for the hybrids of 59 bushels per acre, for the selections 58.1 bushels per acre, and for the eight best varieties 50.8 bushels per acre. The analysis of this data also brings out the value of certain classes of hybrids and selections and the value of certain varieties, as a basis on which to start improvement.

Among the 10 best hybrids, 4 are from series 49, 3 from series 34, and 2 from series 50. Series 49, as is shown in table, is a cross between Sixty Day and Clydesdale; series 34 is a cross between Burt (Early White) and Sixty Day; and series 50 is a cross between Sixty Day and Probsteier. Thus 9 of the best hybrids have Sixty Day as one of the parents which shows the value of this variety in these combinations. This variety also shows its value in the selections, for 6 of the 10 best selections are from this variety. No doubt for other localities and other environments there will be found certain other varieties which will be just as valuable for selection work or hybridization. Another point of interest is whether the hybrids or selections prove themselves

the better yielders. Considering the 10 best hybrids and selections in each case, the averages for 1909 and 1910 favor the hybrids, while for 1911 the conditions are reversed. The three-year averages and the two-year averages show for the 10 best an advantage for the hybrids of about one bushel in each case. In each year, however, the best selection yields better than the best hybrids from 1.3 to 5.9 bushels per acre, yet the three-year and the two-year averages give respectively an advantage of 3.5 and 1.4 bushels to the best hybrid over the best selection. The same hybrid is best in the three-year and in the two-year averages, while the best selection in the three-year average is second best in the two-year average.

In 1907 the tests of all hybrids gave an average of 49.19 bushels per acre, while the average of all straight selections gave a yield of 52.64 bushels per acre. In 1908 the calculated average yield per acre of all hybrids was 56.2 bushels and of all straight selections 48 bushels. In 1909 the average yield of all hybrids was 33.6 bushels per acre, while that of all straight selections was 26.9 bushels per acre. For 1910 the average yield of all hybrids was 65.9 bushels per acre, while that of all selections was 54.2 bushels per acre. For 1911 the average yield of all hybrids was 45.8 bushels per acre, of all selections 48.7 bushels per acre. The average for the five years was for the hybrids 50.14 bushels per acre and for the selections 46.09 bushels per acre. The average for the five years shows that the hybrids gave a higher yield than the selections and seems to indicate that as far as yield is concerned the hybrids are better, on the average, than the selections.

The data thus far obtained furnishes considerable evidence on the value of different classes of hybrids. It would seem that the most promising combinations of those tested are the Burt crossed with Texas Rustproof, Burt crossed with Sixty Day, and Sixty Day crossed with Extra Early Burt. These conclusions cannot be taken as absolute, as other combinations than those tested might turn out more promising.

These results show the possibilities of improving the oat crop by the selection of good plants from a variety or by the combination through hybridization of the desirable qualities of different varieties and thus obtaining a strain of superior value, and it is hoped this article will create sufficient interest to induce plant breeders and careful grain growers to follow this line of work.

THE SIZE OF THE SEED PLANTED AND THE FERTILITY OF THE PLANT PRODUCED

J. ARTHUR HARRIS

Cold Spring Harbor, Long Island, New York

In the practical growing of animals and plants both breeding and feeding are factors of great significance. In our enthusiasm over the possibilities of the newer methods in genetics, we are apt to forget that there must be limits to the improvements of the innate racial qualities which can be attained by hybridization or selection. These limits once reached, we are thrown back upon refinements in culture and feeding—upon the physiology of the individual as contrasted with the germinal constitution of the race—for further margins of improvement.

For these reasons, I have always planned my breeding experiments to obtain incidentally as much information as possible on the strictly physiological factors influencing yield. Such factors are, for example, the influence of the environment of the parent plants furnishing the seed planted^a upon the characteristics of the offspring, the influence of the size of the seed planted, etc.

The purpose of this note is merely to explain a diagram illustrating the importance of one of these physiological factors, namely, the weight of the seed planted, in determining yield.

The data for the diagram are drawn from twenty experimental crops of garden beans, involving Navy, White Flageolet and Ne Plus Ultra, represented by many thousands of individuals. The scale at the bottom shows the range of variation, of the weight of the seed planted, in units of 0.025 gram.^b The vertical scale on the left hand side shows the mean number of pods per plant. The height (on the latter scale at the left of the diagram) at which the twenty sloping lines cut the ordinates (vertical lines) erected on the weight classes, gives the smoothed mean number of pods per plant for that weight of seed.

The actual means are of course very irregular, since the bean plant is very sensitive to its environment, for in ordinary field cultures, uniform conditions cannot be given. Moreover, exact agreements of the empirical and theoretical means are never secured because of the

^a See "A First Study of the Influence of the Starvation of the Ascendants upon the Characteristics of the Descendants. I-II." *American Naturalist*, vol. 46, pp. 313-343, 656-674, 1912.

^b That is, class 3 = 0.050 to 0.075, or a mean of 0.0625; class 4 = 0.075 to 0.100; class 5 = 0.100 to 0.125; class 24 = 0.575 to 0.600.

errors of sampling common to all statistics.^c Of course, the lines as given here are to be looked upon merely as a conventionalized representation of the increase in mean number of pods per plant associated with an increase in the weight of the seed planted. But, considering the difficulties inherent in the materials, they are very accurate conventions.

The twenty series not only represent three distinct varieties but were grown under widely varying conditions and show in consequence

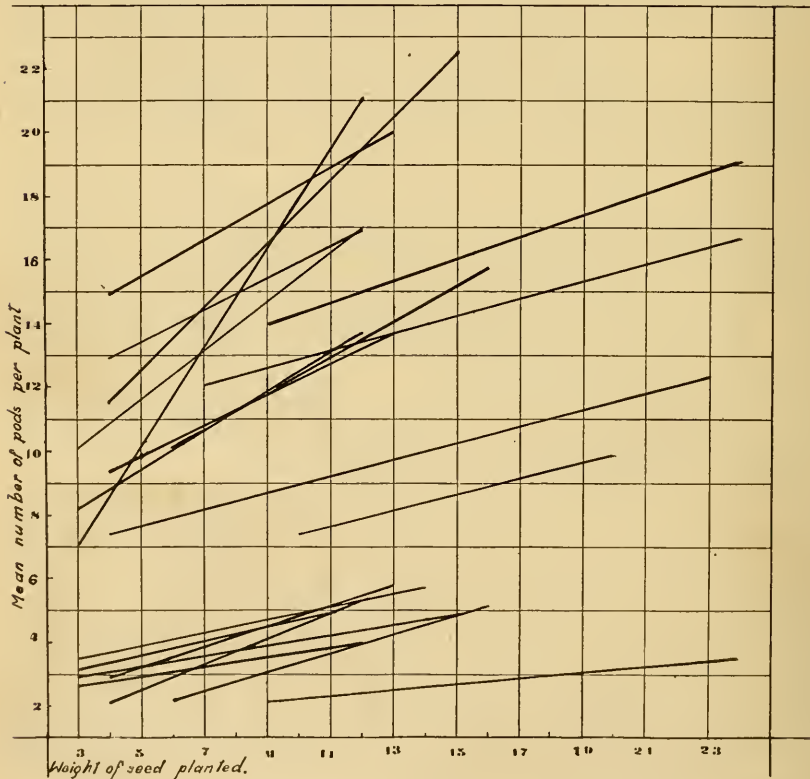

DIAGRAM ILLUSTRATING INFLUENCE OF WEIGHT OF SEED UPON THE YIELD

great differences in the slope of the lines which express in concrete terms the mean number of pods per plant. Yet, in every case there is a conspicuous gain by the planting of heavier seeds.

Considerable attention has already been given by experiment station workers to the question of light and heavy seed, with the general

^c Full details are given in a paper in vol. ix, part I of *Biometrika*: "On the Relationship Between the Weight of the Seed Planted and the Characters of the Plant Produced. I."

result that the heavier seed gives the heavier yield. But generally, the lighter seeds have been separated by fanning and in many cases included blighted or shrivelled seeds. Here all seeds were perfect, as far as could be determined by individual examination.

The practicability of seed grading depends entirely upon the ratio of the cost to the returns from the increase in yield thus secured. These are problems which practical men must figure out. The purpose of this note will have been fulfilled if it suggests to the breeder the importance of planning his work so as to take more fully into account than is generally done, the purely physiological factors.

TEN YEARS OF CORN BREEDING

EUGENE D. FUNK

Shirley, Illinois

That little kernel, corn, capable of springing forth into a beautiful living plant and growing to a height of twelve or more feet within the short period of ninety days, and what is greater still, to be able to reproduce itself over 1,000 fold during one short season, surely we ought to talk more about it, to study its characteristics and habits until we have learned many things yet unthought of. The farmer of the corn belt has scarcely begun to realize the possibilities and necessities that lie before him in order to meet the future demands for corn.

No two ears of corn are exactly alike, yet it is found that within varieties there exist certain strains or families. Breeding corn is simply carrying out nature's own methods, but in addition one must keep a record of each individual plant or set of plants resulting from certain ears. By selection we are enabled to increase certain desirable qualities and thus we bring about the tendency of each succeeding generation to become more uniform and fixed in its certainty to reproduce these qualities.

What the ear-to-row method reveals.—On planting the kernels of corn from a given mother-ear in a single row, that row of progeny will invariably have a certain degree of individuality throughout the season and show a contrast with other rows similarly planted. It may be that this particular row will germinate almost perfectly, out-grow the neighboring rows completely and at gathering time having ears of uniform size and few nubbins outyield all others in the field. Yet the selection of the original ears for planting may have been made with the greatest care to have them all as nearly uniform as possible.

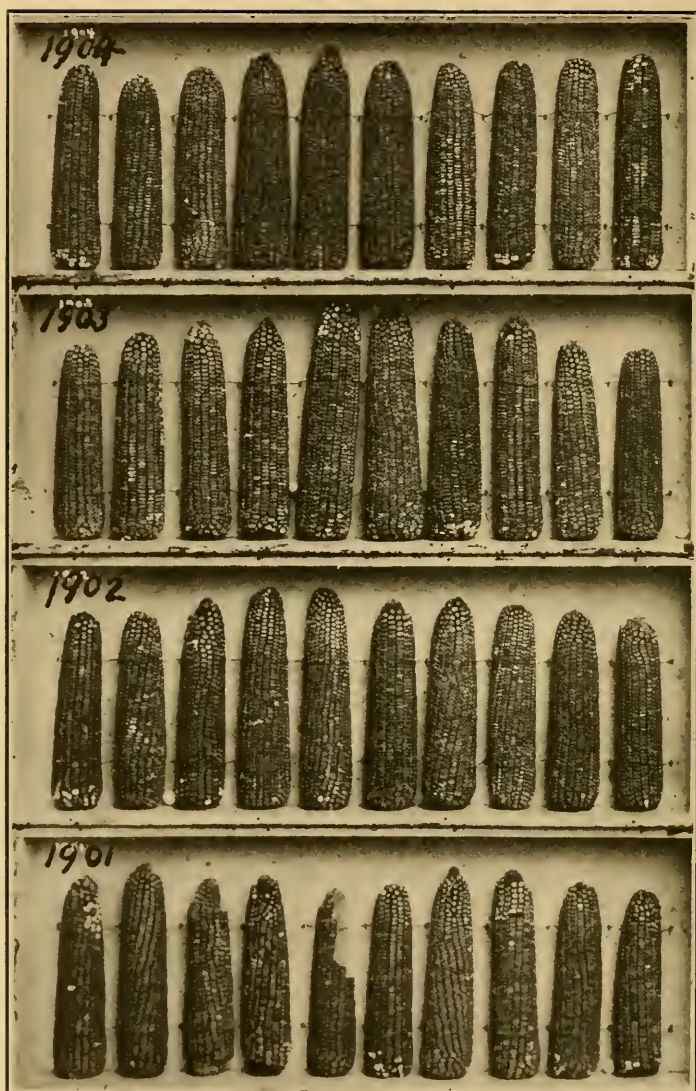

FIG. 1—REPRESENTATIVE SAMPLES OF SEED CORN SELECTED FOR PLANTING IN THE YEARS 1901 TO 1904

For ten consecutive years there have been carefully put in a hermetically sealed can—a bushel of Leaming corn representing the seed selected for planting on about 160 acres. Each of the ten-ear lots, shown in the illustrations, figures 1 to 3, represents the seed selected for planting in their respective years and so these are not the ten best or the ten poorest ears, but as nearly as possible a true representation of the whole.

In order to obtain the very best seed that could be found from the crop of 1901, Prof. P. G. Holden and Dwight Funk visited several of the best corn breeders of that time to obtain seed ears, and the sample marked 1901 shows this corn. The eleven samples show the improvement which has been wrought from year to year by selection.

It would not be fair to say, concerning the increase in yield, that the 62-bushel crop of 1902 and the 85-bushel crop of 1911 is a correct comparison because the soil used was better and more fertile in 1911.

The treatment through the season for each row may be identically the same and the chances for any variation in fertility of the soil reduced to the minimum. The very next row to this vigorous and high yielding row of corn may represent the opposite extreme, poor germination, weakly, perhaps of a pale green color through the season and giving a very small yield. Notes are taken of these different rows of corn during the growing season. Previous to the time of pollenization all tassels of weak and undesirable stalks are removed to prevent the pollen from the inferior stalks fertilizing the more vigorous plants. All ears and rows bear individual numbers which are recorded in a book especially prepared for this purpose. Each row is husked separately and the corn weighed. By this means we secure the yield per acre of the progeny of each mother ear.

From the rows yielding at the highest rate per acre, thus showing their mother ear to have the highest producing power, we save the best corn for the next year's breeding plot. These ears are selected from hills which contain three stalks in order that each ear selected may have been grown under the same conditions. From these same best rows, seed is also saved for larger fields of from five to ten acres, which we call multiplying plots; the yields of which are carefully noted.

Making the performance record.—The yields, first of the mother plants, then of the multiplying plot and then the larger fields become the performance record of the strain of corn, the same as the individual track record of his progeny becomes the record of the trotting horse.

The results for the first few generations, while we may have large yield composed of all sorts and sizes of ears—hybrids from many hundreds of other plants—we find comparatively few ears equalling or excelling the mother ear. But these are the ears selected for future propagation and improvement and after the type is once fixed, we may expect a reasonable uniformity in the progeny of succeeding generations. Corn breeding is not necessarily the getting of typical beauty of ears, or perhaps a few ears and the rest nubbins, but it is to produce corn that will increase an average yield of 28 or 29 bushels per acre to an amount that will justify the labor and expense and that farmers have a right to hope for.

Yield per acre is the unit, the all essential point in which the farmer is most interested. The score card, the corn shows and the competitive corn judging are all good and have their place in awakening the interest to better and more profitable corn raising. The commercial corn breeder should not allow himself to become too greatly absorbed

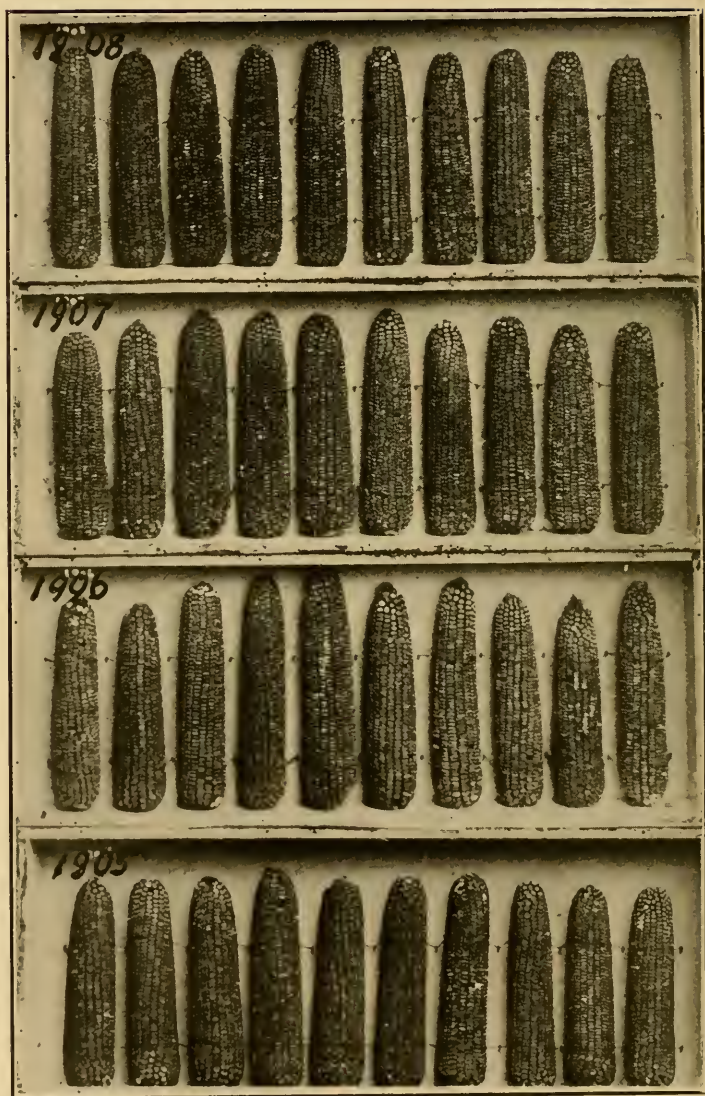

FIG. 2—REPRESENTATIVE SAMPLES OF SEED CORN SELECTED FOR PLANTING IN THE YEARS 1905 TO 1908

in ideal ears, unless these can show for themselves by authenticated records prepotent powers in reproduction. Dr. H. J. Webber, of Cornell University, advises in plant breeding to stick closely to the important characteristics and not to give weight to features not of practical value. Apparent but slight deformities will eventually take care of themselves, or may be improved. Personal experience has abundantly proven this to us, for some of our highest yielding

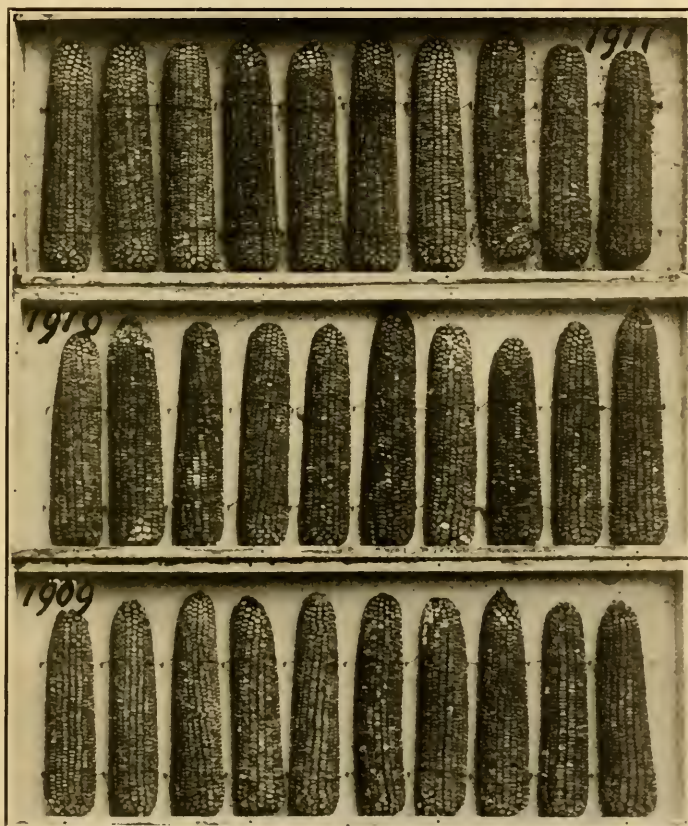

FIG. 3.—REPRESENTATIVE SAMPLES OF SEED CORN FOR PLANTING IN THE YEARS 1909 TO 1911

strains of corn today are anything but ideal ears from the standpoint of the score card.

Theoretically a mother ear should be cylindrical, with well filled tip and butt, wedge-shaped kernels close together at both crown and next to the cob. The kernels should be of as nearly uniform size as possible in order that the planter may drop a given number of grains

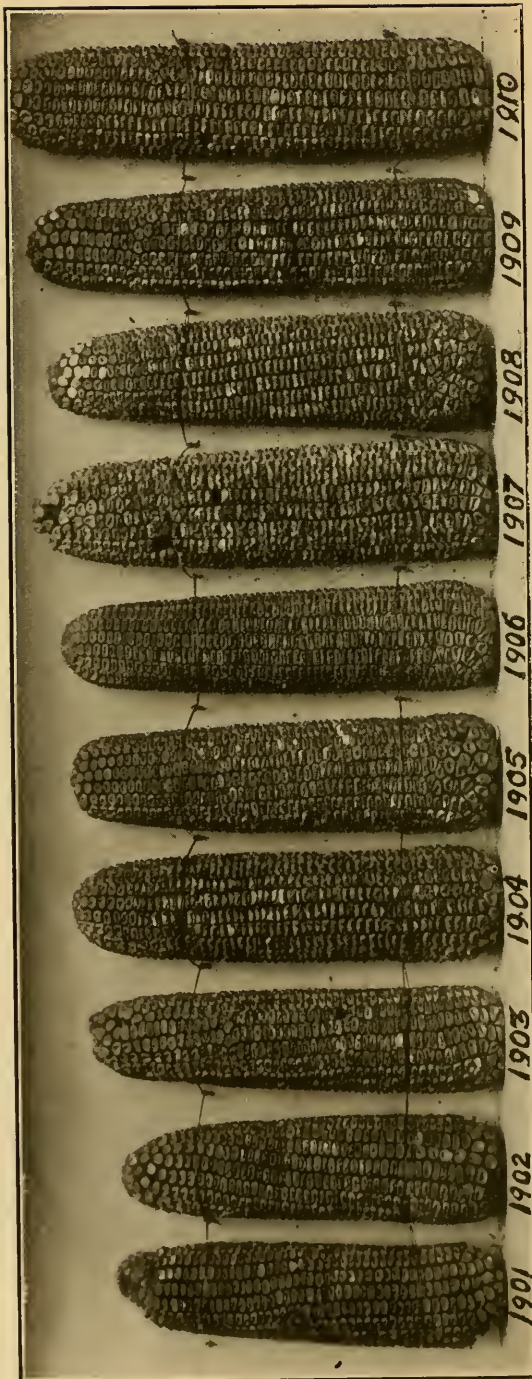

FIG. 4—TEN EARS OF CORN SHOWING THE IMPROVEMENT MADE BY SELECTION DURING AS MANY YEARS, THE SEASONS FROM 1901 TO 1910
Each ear represents the average of the selected progeny for the crop of that year

in each hill, thus securing an even and perfect stand of corn. But in front of all this, there must be a performance record. In other words, a pedigree of what the ancestors of this strain of corn have been capable of doing. Seed coming from ordinary looking ears but possessing such strains of inherent power as to produce a medium size ear on a maximum number of stalks, is certainly far superior for the farmer to plant than the finest show corn that was ever at a corn show which has been selected merely from the point of beauty and the ideal score card. This is not saying that nothing can be accomplished by physical selection alone, and the planting of seed from good, symmetrical ears. A great deal can be accomplished both in the improvement of type and to certain extent in yield.

Now comes the most interesting point. While we have maintained this selection for type and uniformity, in our breeding plots for highest yields, an entirely different type of the same variety of corn has gradually become prominent. Here the selection is largely governed by the predominating type of the seed corn gathered from the highest yielding rows and by comparison with the type of the mother ear. After a selection of ten ears from some of our highest yielding strains of Funk's Gold Standard Leaming and Funk's Yellow Dent, it is most striking to observe, that both varieties show a tendency toward the same type and neither of them conform to the present score card or our arbitrary selection of type for a perfect ear. In general the increase has been about fifteen bushels to the acre. Several hundred farmers, who have planted this seed in practically all of the corn growing sections of the world, agree that the increase in yield over the ordinary selection by the average farmer is from five to twenty bushels and in many cases more per acre. This compares favorably with our check plots. A series of experiments showed that six years out of seven the smooth type of corn made the highest yield, and in another case the same was true five out of seven times.

I wish it were otherwise and that we could discover some relation of idealism to high yield. I anticipate the question that if like produces like why should we not be able to reproduce a lot of fancy and high scoring ears? We may produce them, but we have to use a somewhat different method, and in so doing we fail to get the largest yield. A great many farmers are making a mistake in demanding too large an ear for a seed ear. This throws the corn too late in maturing, even during an ordinary fall a large proportion of the stalks with large ears are caught by the frost; large ears are not really necessary for a bumper crop of corn. I have a report of an average of 106.8

bushels per acre of corn grown in Minnesota, with Minnesota No. 13 seed. And with what we would consider a nubbin in Illinois, Jerry Moore of South Carolina grew 228 bushels on an acre none of the ears that he planted measured over $8\frac{1}{2}$ to 9 inches in length. Corn breeders should strive for a medium sized ear on a maximum number of stalks, and then they can grow all the corn that the fertility in the soil will allow.

PEDAGOGICS OF GENETICS

The teaching of the science of heredity and breeding, and the training of experts in plant and animal breeding and in eugenics, is rapidly coming into our system of education. The value of a study which peculiarly combines cultural with vocational values appeals to the student and will bring this subject rapidly into demand, as will also its interest as a phase of biology, which fascinates. Its vital relation to the economic production of farm products and therefore its relation to the cost of living, will make it attractive to students pursuing general and vocational courses not concerned primarily with genetics. Classes in genetics in our colleges and universities will be especially interesting and vital for those preparing for vocations which relate to eusthenic betterments.

Those universities and colleges which can employ special teachers have here a most unique opportunity to take the lead and place this subject upon a basis at once scientific, pedagogic proper and practical. The American Breeders Association appeals to these institutions to take on this important work much more rapidly. This Association took the lead in bringing the subject of eugenics under the guidance of a group of scientific investigators. Almost before we realized that it could be so the subject had passed into the stage of teaching and of propaganda. No small group of investigators can alone cope with these phases of the subject. The educators, physicians, preachers and philanthropists are now needed to do their part. Those who would lead must study the available literature.

Philanthropists who contemplate giving money to colleges and universities could do no better than to dedicate generous sums to the endowments of chairs of genetics. Legislative bodies should make substantial appropriations to their state agricultural colleges and state universities to establish and liberally sustain chairs of genetics.

EDITORIALS

GENETICS—A FIELD FOR THE SCIENTIFIC PHILANTHROPIST

When the American Breeders Association was organized nearly ten years ago it was in response chiefly to a need that was felt for conference among breeders and scientists, and to give stimulus to research work in the science of heredity and the art of breeding.

Subsequent events, as for instance the wonderful and exceedingly popular work of a number of plant breeders, and the oncoming Mendelian and DeVriesian thought, have made of genetics a remarkably practical, productive science. The recent and seemingly permanent rise in the cost of living, which is giving economists and legislators so much concern, has served to make immensely important and vital the increasing of food production through the developing of better breeds and varieties. The fact that one-half of the increased food production of whatever kind will eventually come through the use of better bred varieties of plants, cereals, fruits, and animals makes this matter of genetics or breeding the biggest proposition in agriculture, after soil conservation.

The work of the American Breeders Association has been carried on by a few sincere and devoted individuals, with such means as were raised by a membership consisting of scientists, practical breeders of plants and animals, of physicians, sociologists, social workers, ministers, officers of eleemosynary institutions, and men and women of affairs, all alert and interested. Through their efforts a new world of research has been opened. But what has so far been done, though a mere beginning, has afforded a glimpse of amazing possibilities. With these developments of a decade, the American Breeders Association has grown to an organization equipped with effective methods to attack some of the most vital problems facing the race in its progress. The Association has attracted a large number of scientists of other countries, and seems in a fair way to become international in scope.

The influence of the Association has made itself felt in numerous other ways. The plant breeder, a name and a man theretofore unknown, has come into public prominence; colleges and universities are establishing chairs of genetics; eugenics and genetic societies are being organized at intellectual centers; experiment stations are increasingly giving attention to the subject of experimental breeding; states, as Minnesota and New York, are organizing great establish-

ments for the breeding of their field crops; the former State has a farm for the specific purpose of breeding and originating fruit varieties.

All this work has been received by the public with an open-mindedness bordering on avidity. Its influence has gone forward so rapidly that it is in a fair way to overtake and swamp us because of our inadequate means of taking care of the new openings and demands. Having originated the movement, the Association feels the responsibility of directing it, that it may proceed along a sound and useful course, and to save it from falling into the hands of quacks, impostors, and half-baked scientists.

Several circumstances have favored us in the promotion of this educational propaganda in genetics, eugenics, animal breeding, and plant breeding. Chief among these is the greater public appreciation of out-door life, of nature and nature study. Recent years have seen the beginning of the "back to the land" movement among the more virile elements of the race; a keen and active interest in matters pertaining to farming and to country life is almost universal. Numerous books and magazine articles, the daily press, and even the stage, have drawn public interest to the questions of genetic race culture, and of the improvement of the heredity of plant and animal life in an advanced and permanent agriculture. These matters have all become very vital parts of our civilization and are becoming more so daily, as increasing population and greater complexity of civilization make us more dependent upon an intensive, highly specialized, and scientific agriculture.

So much for the aims and the work of the American Breeders Association. It has passed through the struggle of becoming an institution. It has brought together the genetic scientists and breeders. It has brought into the closest coöperative relations the breeders of plants, the breeders of animals, and those interested in eugenics. By a quiet policy of stating the results of research in eugenics it has overcome the opposition of an at first hostile press and of indifferent public opinion. It has thus been a powerful factor in compelling a respectful hearing for the science of eugenics and of genetics in general. It is recognized as already having rendered a large service, and its members believe it has further large and important functions to perform. Its scientific and philanthropic status is almost ideal. It is now ready for two things which alone can enable it to lead in the large service before it:

It needs endowment for its research work and it needs many more members as bearers of its educational work.

The man of research, the scientist, is on trial and is successfully demonstrating his usefulness. It is a characteristic of our modern science, that it fully recognizes its own importance. We are living in a time in which science is more and more applied to the affairs of man and to problems of public welfare. Persons with means could not find a more admirable group of people with whom to coöperate in putting forward enduring constructive work than the men and women of this Association. It is now so thoroughly organized and seasoned as to its field, its specific problems, and its methods, that its work should be recognized by persons who wish to invest money in truly vital service. In these days of large fortunes men and women seek to give in such manner that some large and permanent purpose is served which will do the most for human welfare and uplift. Scientific philanthropy has taken the place of scattered, indiscriminate charity.

Public and private money has been forthcoming from various sources for practical extension work in teaching, on a nation-wide scale, the facts of soil conservation and conservation of soil fertility. But owing to the peculiarity of research work in genetics and eugenics, the financial results are not always immediately in view, and in consequence public money is not usually so generously appropriated. Thus, much of the burden is borne by private individuals or the needed work is not done. Strange to say, the large live stock and herd book associations do not appropriate any money for research work. And in regard to that branch of genetics which concerns itself with eugenics, practically all research and educational work has been done under private agencies and with limited funds. Few as yet view eugenics in its broader aspect, namely; as a means of conserving the race through the preservation of family stocks of genius and leadership and exceptional ability, and the discovery and encouragement of capable and prepotent blood lines.

There is a much closer connection between genetics and the large social and public questions than the superficial student is aware of. The scientists who are doing research work in eugenics need the support of those who are in touch with the problems of charity and correction; and these, in equal measure, need to be in touch with those who are rapidly building up the science of eugenics. We have no public interest in which there is greater need of common sense based on experience and research.

It should appeal to each member of the Association as a personal duty to bring the work of this Association to the attention of his friends, particularly to the attention of persons who are in position

to assist this work with funds. There are hundreds of persons of wealth in this country who would be glad of an opportunity to advance a cause racially so important if only the facts in the matter were brought to their attention. The Association is officially in touch with only a comparatively small number of these people. Through its members it may reach many thousands. Let then each member feel it his personal duty to secure the interest and support of persons who are in position to endow the Association with large funds for carrying forward its work.

It is to be earnestly hoped that the next important foundation of historical note in scientific philanthropy will be made by some person or group of persons, to place genetics and eugenics in position to work out freely and in the fullest measure their logical tasks. Here is a work whose importance overshadows almost all else in human affairs, because it is basic of all permanent betterments; it concerns the race in its widest meaning and has to do with its very soul and life blood. From the endowment of this institution, the American Breeders Association, which is at once one of research and education, would date a period whose influence would give a permanent and new direction to the course of human affairs.

EUGENICS AT THE HYGIENE AND DEMOGRAPHY CONGRESS

That eugenics and sex hygiene have suddenly sprung into prominence was shown during three weeks in September at the International Congress on Hygiene and Demography in Washington. In a great exhibit, held in connection with the Congress in the Red Cross building, these subjects held a leading place. The officers of the National Federation of Sex Hygiene and of the Eugenics Section of the American Breeders Association boldly and very successfully carried on a campaign of education and publicity. At least, the tens of thousands of visitors at the exhibition and delegates to the Congress on Hygiene and Demography, and the people of Washington, have seriously accepted at face value the proposition that sex and eugenics matters are up for solution by scientific and educational methods.

The truly astounding fact about the entire eugenics and sex hygiene exhibit is that almost no controversy was aroused. The facts of sex diseases were driven home by means of graphic charts and reading charts and even by photographs and models in a most effective but unobjectionable way. That the annual cost of immorality and social diseases approximates three billion dollars out of a total of

thirty-four billion dollars, of our national production, makes one shudder. We are worse than playing with race making, we are rioting with nascent souls. A million and a quarter of infected women, who rightly blame men for their downfall, infect millions of men and through them probably millions of unblamable wives. Race morality and race hygiene are our greatest immediate national needs. Science, education and religion are ready to join in a mighty coöperation, in an energetic struggle against these devitalizing influences which tend to our undoing as a nation and a race.

The more pleasant and the ultimately more vital subject is race building. The Demography Congress clearly brought out the fact that we have 2 per cent of subnormal or abnormal children; or about two million people who are feeble-minded, or with a genetic tendency to insanity, immorality or criminality; and still others with a tendency to consumption or other organic weaknesses. It was also shown that some families of the nearly ninety millions of so-called normal people average high in efficiency while others rank low in their inherited ability to become useful citizens. The practicability for expert eugenists to assist young people in avoiding matings, in which a given weakness coming from both sides is certain to result in unfortunate children, was clearly stated by Drs. Davenport and Laughlin of the Eugenics Record Office, and is based upon their practical efforts at making scientific diagnosis on which people can base self-advice.

The Eugenics Record Office had about fifteen hundred square feet of wall space occupied by a display of very neat reading-charts and illustrations. This, together with the exhibit of sex hygiene, was perhaps the most intently studied exhibit in the entire building. No estimate has been made of the number of visitors to this eugenic exhibit. It is sufficient to say that the floor was much of the time crowded and that a large number of persons came with note-books and freely took notes from the charts.

A popular and interesting feature was the series of half-hour lectures on eugenics, in the special lecture room. These lectures or talks, some illustrated with charts and slides, were along popular lines, and were attended by intelligent audiences to the full capacity of the room. Dr. Chas. B. Davenport, Dr. H. H. Goddard, Dr. E. E. Southard, Dr. H. E. Jordan, Mr. Bleeker van Wagenen, Secretary, W. M. Hays, Mr. V. M. Cady, Mr. H. H. Laughlin, all members of the Association, had volunteered to fill the various lecture periods, so that three daily lectures could be given during the entire week. Mr. Cady of the Sex Hygiene Society, estimates the number of

attendants at the eugenics lectures at 3,000. The Association is greatly indebted to the gentlemen who donated their time and services.

BREEDING, GENETICS, EUGENICS

The dictionaries and common usage need to be brought closer together in the use of the words breeding, genetics and eugenics. As used in this *Magazine* and by the persons associated in the American Breeders Association, these words have each come to have a definite meaning somewhat different from that assigned by the dictionaries. By Breeding is meant: That part of the production of plants and animals which relates to making varieties and breeds of a special type or of superior value, and extending the use of these values so that this blood may be used by other breeders. The word Genetics is accepted to mean: That branch of the science of living things which deals with their heredity and variation, and the breeding of plants, animals, and men. Eugenics, as defined by Galton, and generally accepted, means: "The science which deals with all influences that improve the inborn qualities of the race." That there is a divergence of definition and usage is shown by the fact that the 1910 edition of one of our leading dictionaries defines Eugenics as "The science of improving stock, whether human or animal, or of improving plants."

The international society devoted to the science of breeding has adopted the term Genetics as a part of its name—the International Society of Genetics—and some of its members, who are also members of the American Breeders Association, suggest that the name of this Association be changed to the American Genetics Association. This change has, in fact, been under consideration for some years among the members of this Association. This change would naturally carry with it the change of the name of this *Magazine* to American Genetics Magazine, American Journal of Genetics, or an equivalent name. When this Association was formed the name "Breeders" was the only commonly known name available. That name has been of great advantage in conveying to the public the practical purpose of the organization. On the other hand, it has been somewhat misleading, in that the public has always assigned it a restricted meaning, classing this organization and its publications with associations and publications which almost exclusively relate to the practical art and business of animal breeding.

Under the proposed change of name our association would enjoy a designation which would distinguish it entirely from all other breed-

ers associations, and our publications also would be distinguished from periodicals devoted mainly to the interests of the practical breeder. Some live-stock journals, which have felt that the *American Breeders Magazine* might become a rival, would then recognize its distinctive field under a name more clearly expressing the large purpose it is trying to fill.

The word "Genetics" would carry the broader meaning and would not be out of harmony with the present use of this term. The broader relation of the word genetics to the science of heredity, and breeding, and to the art of the improvement of the heredity of plants, animals, and man would be recognized. The word "Breeding" would be given its due prominence in the names of the Plant Section and the Animal Section, and the word "Eugenics" would be used in its restrictive sense in the name of the Eugenics Section. Workers, investigators and students could then be recognized by the following terms: Genetists: those interested in a broad way in the entire field of the science of heredity and the art of breeding. Genetic Scientists: students and investigators of the theoretical aspects of heredity and breeding. Eugenists: those interested in the improvement of the heredity of the human species. Breeders: raisers and improvers of plants and animals. Plant Breeders: improvers and originators of varieties of plants. Animal Breeders: raisers and improvers of breeds of domesticated animals.

The word Thremmatology has also been somewhat in use, with a meaning nearly the same as given above for genetics. It would not be as convenient for general use as the latter word. For example, the name American Thremmatological Association would not make a convenient nor easily understood name. The word genetic, from the root word, gen, genea suggests the thought, to be born, as the word "eugenic" suggests the thought, to be well born.

The division of meanings outlined above for the words Genetics, Breeding, and Eugenics, has the advantage of simplicity, and of being easily understood by the laity, and of conforming closely with uses already common in the leading countries.

NEWS AND NOTES

GENETICS IN THE UNIVERSITY OF ILLINOIS

Professor John Detlefsen formerly connected with the Laboratory of Genetics, Bussey Institution, Harvard University, has been elected to the assistant professorship of genetics in the College of Agriculture of the University of Illinois, Champaign, Illinois. Professor Detlefsen will also fill the place of assistant chief in genetics in the Agricultural Experiment Station.

THE GIDEON MEMORIAL TABLET

The readers of the *American Breeders' Magazine* will be interested to know that the Native Sons of Minnesota have erected a tablet to



the memory of Peter M. Gideon, originator of the Wealthy apple. The tablet, which was unveiled by his daughter, was placed near where the original Wealthy tree stood, on the old Gideon homestead at Excelsior, Minnesota. The exact location of the original tree seems

to be in doubt; this would indicate that this act of recognition, in common with many others, was planned somewhat too late.

Among those assembled to witness the dedicatory exercises were many prominent in horticultural work as well as in the affairs of the state. There were a number of speeches in testimony of the services of Mr. Gideon to horticulture. A group of the older horticulturists present, who knew Mr. Gideon, and who saw the first apples exhibited from the original tree, seemed to link the present with the past.

Mr. Gideon really erected his own monument in 1864, when he planted the seed from which the Wealthy apple tree came, and the dedicatory exercises on June 15, 1912, only expressed in another manner the appreciation which many who grow and use the Wealthy apple have had, and still have for this man and his services to posterity.—M. J. DORSEY, *St. Anthony Park, St. Paul, Minnesota.*

SELECTION IN PURE LINES

One of the most pressing problems of today for the science of biology, as well as for the scientific plant-breeder, is to discover whether genetic factors are constant or are variable. This can probably be determined by experiment, if executed with the precision of the physical laboratory. The practical question is, whether selection can have any measurable effect when carried out in two opposite directions within a homozygous strain. Leguminous plants that are functionally cleistogamic (self-fertilized) seem to offer, in the dimensions of their dry seeds, suitable material for the experiment. Several sources of error, however, must be guarded against. Dry seeds measured in the spring, and again a month later, will sometimes be found to have shrunk perceptibly in the interim. The actual length of the dry seeds is also, in some strains, certainly determined by the amount of crowding in the pods.

The dimensions of a bean are maternal characteristics, and the only advantage of measuring more than one seed to each plant is to obtain an average which will be freer from the effects of "modifications." Now it seems that we should first reduce the modifications to as low a degree as possible. We can sometimes do this by taking our beans only from ripe pods of the average length and number of seeds, and by omitting the proximal and distal beans in strains of plants where these are often much smaller or larger respectively than the median beans. We should, I think, select in each generation those *plants* the average size of whose seeds is respectively highest or lowest.

Any seeds from each of these selected plants can then be grown, and the selection of plants continued for further generations. Each of the variates used in our work will then always be the mean dimensions of the typical beans of one individual plant.

If we mix at first all the beans of the plants of the homozygous strain, and then select the largest beans for one line and the smallest beans for another line, we shall, in some leguminous plants at least, be testing the distal beans of a pod against the proximal beans, and we may perhaps find no effects from such selection, even after ten years. The separate beans of a leguminous plant are certainly not individuals with regard to their dimensions, but are only limbs or members of the zygote on which they grow. The great modifications in beans from different parts of the pod, and in pods with different numbers of seeds, will, in some leguminous plants at least, quite mask, for the purpose of selection, any small genetic differences which might or might not arise from variations of the individual genes.

It has been considered as proved, with *Phaseolus vulgaris*, that selection continued for several years produce no effect in different homozygous lines. But in these experiments, the separate beans, and not the individual plants, were selected.^a Hence, I think that further search for a possible result of selection in pure lines (much less quantitatively than the immediate result of selection among the progeny of heterozygotes) will be useful.—JOHN BELLING, *Gainesville, Florida*.

KOREAN CATTLE

I have seen occasional specimens of Manchurian or Mongolian cattle that are good enough to catch the eye but the average specimen is a decided "Canner." Manchurian and Mongolian cattle are long horned, raw boned beasts that excite no admiration whatsoever. The Korean cattle on the other hand are magnificent specimens, resembling our Aberdeen Angus cattle very much. The Korean cattle are kept by the Koreans mainly for work purposes, being used in plowing the rice paddies, and in carrying freight to market on their backs or in heavy two-wheeled carts. They are commonly polled, black and sleek in color, with a tinge of Guernsey yellow or brown along the back. Some types are brownish yellow all over. The bulls attain large sizes, 1600 to 2000 pounds. The breed has less blockiness of type, less spring of rib and less compactness than our Aberdeen

^a W. Johannsen, *Elemente der exakten Erblichkeitslehre*, pp. 113-157, Jena 1909.

Angus breed. Taken as a whole though the breed is a magnificent one and doubtless under careful breeding management would fully equal any of our selected, domesticated breeds.—E. C. PARKER, *Johnson, Montana.*

PUBLICATIONS RECEIVED

EUGENICS. W. E. Neiberger, M.D., Bloomington, Ill. Pp. 7. Reprint from the *Clinique*, July, 1912, being a paper read before the Illinois Homeopathic Medical Association, May, 1912.

ANOTHER SEX-LIMITED CHARACTER. Edward N. Wentworth, Ames, Iowa. Reprinted from *Science*, June 28, 1912, page 936.

SOME DATA ON THE INHERITANCE OF HORNS IN SHEEP. T. R. Arkell. Bul. 160 of New Hampshire Agricultural Experiment Station, Durham, N. H. Pp. 35, 43 text-figures.

EVIDENCE OF ALTERNATIVE INHERITANCE IN THE F₂ GENERATIONS FROM CROSSES OF BOS INDICUS ON BOS TAURUS. Dr. Robert K. Nabours. Reprint from *American Naturalist*, 1912, pp. 428-436, 9 text-figures.

COÖPERATIVE COW TESTING ASSOCIATIONS IN MINNESOTA. Bulletin 1. Department of Agriculture, Albert Lea, State High School, Theo. Sexauer, Director, Albert Lea, Minn. Pp. 55, illustrated.

MENDELIAN INHERITANCE IN COTTON HYBRIDS. C. A. McLendon. Bulletin 99, Georgia Experiment Station, August, 1912. Pp. 141 to 228, 20 text-figures, 8 diagrams.

NATIONAL RESERVATIONS FOR THE PROTECTION OF WILD LIFE. T. S. Palmer. Circular 87, Bureau of Biological Survey, U. S. Department of Agriculture. Pp. 32, 5 text-figures (maps).

THE KALLIKAK FAMILY. H. H. Goddard. Pp. 121, fig. 14, charts 14. The Macmillan Company, New York, 1912, publishers. Price \$1.50 net.

In this monograph, the eugenics movement is enriched by a substantial piece of literature. It is in line with the publications of research work issued by the Eugenics Record Office, being a contribution to more definite knowledge of a specific phase of human heredity. Dr. Goddard, who is an active member of the American Breeders Association is known to our members by his contributions and lecture work on the subject of feeble-mindedness.

The author could not possibly have chosen a stronger and more convincing manner of presentation of the hereditary character of feeble-mindedness. Such a story as this must strike home and attract public attention and arouse the public conscience. The book is an outline of a vast breeding experiment, extending over six generations, undertaken by the principals all unconsciously, but an experiment nevertheless as the scientist, who always controls and checks his work, could not have planned much better.

There are charted and recorded a total of 1146 individuals connected with this family. In one branch are recorded 41 matings, in which the parents were feeble-minded persons, the offspring of these were 222 feeble-minded and 2 normal. Another branch of the family has only normal individuals, and many of them of high physical and mental attainments.

We predict that this book will give the study of eugenics a strong impetus. The simplicity of the story, its appealing every-dayness and the warm human interest that fills its every page, make the book splendid reading for the layman and general reader. Dr. Goddard writes cautiously, he makes no attempts to draw generalizations. Suggestions in the way of "what is to be done" are made with the Doctor's characteristic reserve and carefulness.

The book is a primer of eugenics—anyone who can read, can understand it. It is a sermon—it drives home a lesson, the result of one thoughtless act. It is a demonstration of the effectiveness of modern methods of research as applied to human heredity. It is an unspoken appeal to other philanthropists, than the one who made this piece of research work possible, to support similar work in this new, marvelously productive and important field in the understanding of the human soul and human society.

The reflective person will receive from this little sketch new light on a large number of old problems. From it, the idea that many of our economic problems are at bottom biological ones, gains strong support. Dr. Goddard very correctly says:

Such facts as those revealed by the Kallikak family drive us almost irresistibly to the conclusion that before we can settle our problems of criminality and pauperism and all the rest of the social problems that are taxing our time and money, the first and fundamental stop should be to decide upon the mental capacity of the persons who make up these groups. . . . Thus it is, that if all the slum districts of our cities were removed tomorrow and model tenements built in their places, we would still have slums in a week's time, because we have these mentally defective people who can never be taught to live otherwise than as they have been living.

IS MANKIND ADVANCING? Mrs. John Martin. Pp. 302, numerous diagram tables. The Baker and Taylor Company, New York, 1910, publishers.

Mrs. Martin, who by the way is a life member of the Association, essays an answer to this question in a highly interesting and instructive book, which shows evidences of resourcefulness and a vast amount of library research work.

The broad inference to be drawn from this book, is that the present day race of the white man, as measured by morals, by religion, by general intelligence, by genius, by art, stands behind that of the ancient Greeks. That our civilization is below the level of the Ancients, not merely in many, but in most respects.

Although not prepared to agree with the author throughout, we are willing to admit that she presents an impartial analysis of our civilization. She is optimistic with faith in the eventual evolution of man. Note that the book is dedicated "to the super-man with the hope that his coming may not be too long delayed."

The question is put to our consciences whether we are more moral than the ancient Greeks; whether we can truly say that we are more honest, or more temperate, or chaste or just, or tolerant or hardy, or public spirited. Have we progressed in Democracy? do we hold life more precious? These questions are difficult to answer concisely; at best we can deal only in comparisons.

We are asked to judge man—homo—on his individual basis. We are asked to divest our minds of the idea that the accumulation of centuries in the way of knowledge, property, appliances, houses and other physical evidences as railroads, steamships, wireless, aeroplanes, skyscrapers, and so forth, represent our very own civilization. Man is not to be measured by the quantity of things he makes or by his wealth, or by the vastness of his undertakings, but by his own intrinsic worth.

Eugenics is recognized by Mrs. Martin as a possible factor of great moment, but she appears to lay greater stress upon environment as an evolutionary factor. The race must make a new start by providing a suitable "breeding ground for the coming super-man." Thus the exodus of woman from home activities in city and on farm into the industries, factories and shops is deplored. A strong plea is made for the farm as a breeding place for the race. "The state must recognize the human right of every child to be brought upon a farm," and Mrs. Martin advances numerous excellent euthenic reasons for this opinion.

The book is written in strong and vigorous style, becoming at times delicately and bitinglly ironical. One feature especially, which commends it to the reader is the entire absence of dreary compilations of statistics, which at first thought one would expect in a book which, from its nature, must depend largely upon comparisons to carry its point. On the other hand, the glorification of the ancient Greeks in superlatives, detracts from, rather than adds, strength to the argument. The classicists, who have filled all literature with their exu-

berant appraisalment of Greek culture, were largely governed by sentimental and poetical rather than by practical and scientific motives and Mrs. Martin has erred in accepting their dicta too literally.

The diagrams showing graphically the levels of attainments in various lines of human endeavor, during several centuries, should be more fully explained. This manner of presentation is open to criticism, as no explanation is given of the technique or method by which the various values were assigned.

The reading of this book is commended to legislators, congressmen and senators; teachers and educators and to eugenists in general.

REFERENCES IN CURRENT LITERATURE

THE SINGLE TESTING SYSTEM OF BREEDING FOR EGGS. D. F. Laurie, Department of Agriculture, Adelaide, South Australia. Pp. 14, text-figures 3.

Mr. D. F. Laurie, who is the Government expert and lecturer in South Australia, scarcely needs an introduction to the members of the Association. The interesting publication here named contains an outline of a system of breeding, and a method of housing that were used by Mr. Laurie in developing several distinct South Australian laying strains of poultry. The trap-nest is discarded and the single pen, 3 feet by 30 feet, with house 3 feet by 3 feet at end of pen, adapted. This breeder believes thoroughly in line breeding, because according to Mendel's law the proper course is to breed the various generations *inter se* until segregation is definitely assured. "Never breed from unsound or unfit and your work will proceed, but if one parent be unsound no amount of fresh blood will give any definite improvement."

A FRUIT BREEDING FARM IN MINNESOTA.

An article in *The Farmer*, St. Paul, Minnesota, Number of October 5, 1912, describes the fruit breeding farm, which is owned by the state of Minnesota and is located in that state. Dr. Chas. Haralson, for many years associated in plant breeding work with Prof. Niels Hansen of the South Dakota Agricultural College has been the superintendent of this interesting breeding farm ever since it began operations in 1907. The purpose of this institution is, of course, to originate new varieties of fruit, hardier and better than present varieties, and also adapted for a greater variety of special uses. The methods employed are those usually followed by plant breeders—selection and cross breeding. While this kind of work is naturally a long time proposition, the results obtained even in the short space of five years have

justified the wisdom of establishing this institution. At present, 6,000 cross-bred seedlings of apples, 6,000 of plums, 60,000 of strawberries, 13,000 of grapes, 10,000 of raspberries, and large numbers of cherries, apricots and peaches promise to turn in results in the shape of new commercial varieties. At any rate, this is a splendid foundation for a beginning. Hardy and desirable varieties of fruit trees and vines from all parts of the world are here brought together and by crossing new combinations of blood lines are made to form new varieties. Every state ought to have such an institution.

PROBLEMS IN EUGENICS. Containing the papers communicated to the First International Eugenics Congress, held at the University of London, July 24 to 30, 1912. Pp. 490. Published by the Eugenics Education Society, London, 1912. Price, 8/6 net.

This highly interesting publication is introduced by the presidential address before the congress, in which Mr. Leonard Darwin sounds the "keynote" of the Eugenics movement. The papers read and submitted at the congress are arranged under the sections of: I, Biology and Eugenics; II, Practical Eugenics; IIa, Education and Eugenics; III, Sociology and Eugenics; IV, Medicine and Eugenics.

The papers are printed in the language of the country in which they were originally prepared by their respective authors; many of the papers, however, have been translated into English. We note that of the papers contributed, 16 were originally in English, 9 in French, 5 in Italian and 2 in German. An additional volume of papers which were submitted too late to get into this volume, is promised.

THE INHERITANCE OF SKIN COLOR. Dr. H. E. Jordan, University of Virginia. Reprint from *Science*. August 2, 1912.

The writer expresses the opinion that skin color unquestionably is a Mendelian character. Segregation in the Mendelian sense takes place and there are records in mulatto offspring, cases of reversion, as well as cases of undoubted segregation of the white skin color in the third generation. This paper touches a large number of relevant topics, as for instance, the close histological resemblance of brunette and mulatto skins and the fact that protracted exposure to the sun will "tan" even very fair skin, causing an increase in the number of pigment granules in white skin. "Dark skinned races like the Italians and Spanish and finally the brunettes of the Anglo-Saxon race, may owe their pigmentation to negroid ancestry. The connecting link may well have been the negro slaves of Roman times, and the conquering Teutons."

STUDIES IN HUMAN HEREDITY. Dr. H. E. Jordan. Bulletin of the Philosophical Society of the University of Virginia. Pp. 293 to 317, illustrated by numerous heredity charts. Price, 40 cents.

Investigations by the author, into the heredity of left-handedness have incidentally brought to light other characters which seem to show hereditary tendencies. Among those are tuberculosis, cancer, hermaphroditism, onyxis, nephritis, melancholia and thumb-prints. Dr. Jordan holds, that "if pathologic conditions are determined even in part by hereditary constitutional bases, then methods looking to permanent racial cure, i.e., complete eradication, must reckon more intelligently and widely with the hereditary aspect of disease."

ETHNIC CENSUS IN MINNEAPOLIS. Prof. Albert E. Jenks. *American Journal of Sociology*, May 1912.

Professor Jenks discusses the "forces of ethnic cohesion and amalgamation" on the basis of an ethnic census recently made in Minneapolis and embracing 80,000 heads of families. This article is in the nature of a preliminary report; the deductions given are drawn from that part of the material which have been digested to date.

For the first time perhaps, we are enabled through the data furnished by this census taken in a city with a large and diverse foreign population to gain a fair idea not only of the rate of amalgamation taking place in a large city, but of the diverse elements which enter into it. These preliminary statements suggest that the blood mixture coming under the observation of this census is complete, ethnic (racial) lines being totally obliterated. To quote Prof. Jenks:

Of the slightly less than 80,000 heads of families whom we have under consideration, not one pure-blood individual of the fourth generation American birth has been found who has married with another pure-blood person of his own people, no matter what the generation of this second individual may have been. In other words the force of ethnic cohesion has broken down completely after the third generation of American birth, and the amalgamation process is then given full rein. This is true of the 80,000 heads of families coming originally from 37 distinctive people whom our investigation has found in Minneapolis, and, strange as it may seem, it is as true of the Jew as of the other.

The effects of crossing on fecundity of families are of decided interest. Some combinations as pure Irish with pure Irish are more fecund than Irish with Scandinavian; the latter tending to pull down the degree of fecundity. We incline to the opinion that these fecundity data will need to be handled with extreme caution as the classification of individuals in the census is based, not on ethnic but on geographic (nationality) distinctions.

ASSOCIATION MATTERS

AN APPEAL

Members who are in arrears for their 1911 or for 1912 membership dues are respectfully requested to settle, so that all funds coming from this source may be available before the close of the year. The Association has been to rather more than usual expense in the printing of the combined annual reports VII and VIII. Increased cost of material and printing, as well as an unusually large amount of complicated typographical work, has made this volume more expensive than any two preceding numbers. The Council of the Association hopes that its efforts will be appreciated by the membership at large, and that the outstanding annual dues for 1912 will be sent with promptness. The total of this amounts to a considerable sum and it will go far toward enabling us to meet our obligations.

The price of Volume VII-VIII has been fixed at \$3 and members are asked to assist in finding sale for single copies to libraries and non-members.

ELECTION OF LIFE AND DELEGATE MEMBERS DURING THE PAST QUARTER

Mr. E. A. McIlhenny, Avery Island, Louisiana; Norges Landeruksheiskole, Foringsforsoksstationen, Norway; Johns Hopkins University, Baltimore, Maryland; State Normal and Industrial College, Greensboro, North Carolina; Canadian Medical Association, Montreal, Canada; Hamilton Public Library, Hamilton, Ontario, Canada; Mrs. Aaron M. Wilcox, Baltimore, Maryland.

REDUCED RATES TO THE MEETING OF THE AMERICAN BREEDERS ASSOCIATION

The secretary of the National Corn Exposition, Mr. George Stephenson, announces that he has secured reduced fares in the territory of the South Eastern Passenger Association, for persons intending to attend the Corn Exposition and the Annual Meeting of the American Breeders Association. The selling date of these tickets begins January 20. It is possible that several of the other passenger associations will grant reduced rates also. In the event that they do not, however, visitors from territory outside should purchase tickets to some point within the territory of the South Eastern Passenger Association, say Washington, D. C., Cincinnati, Louisville, Memphis, St.

Louis or New Orleans and from there take advantage of the excursion fares which amount to just about one-half of the regular fare.

On the 24th and 25th the meetings of the American Breeders Association will be confined to the regular sessions. On Monday the 27th, the members will visit the exposition on its opening day. On January 26, the visiting members of the Association, together with all men at the exposition in connection with the educational exhibits, will be taken for a pleasure trip to Charleston, as the guests of the Southern Railroad and the Charleston Chamber of Commerce. A brief visit will be made to the Drainland Experiment Station; thence to Summerville where the visitors will be shown the only tea farm in the United States, and last, but most interesting of all, will be the visit to the quaint old city of Charleston, where all will be entertained by the Chamber of Commerce. Among the features planned for the entertainment is a visit to the points of scenic and historical interest about the city; a harbor trip taking in the Navy Yard, Fort Sumter and Fort Moultrie, and a clam-bake on the Isle of Palms. The secretary of Charleston Chamber of Commerce writes: "You may rest assured that to the members of the American Breeders Association the day at Drainland, Summerville and Charleston will be the time of their lives." Charleston hospitality will be on tap. The American Breeders Association will have a booth in the exposition for its headquarters, also an exhibit and will have use of a lecture room where lectures and talks may be illustrated by lantern slides if desired.

The Association is especially appreciative of the work, along various lines, of Mrs. Aaron M. Wilcox of Washington, D. C. Mrs. Wilcox, who is a life member of the Association, has presented delegate memberships to the Canadian Medical Association, to the Public Library at Hamilton, Ontario, Canada. The last of these she gave in honor of her son the late Horace W. Wilcox who resided at Hamilton, Ontario. Mrs. Wilcox has also presented a delegate membership to Johns Hopkins University, at Baltimore, Maryland.

Ga

