

BLM LIBRARY



88067315

Final Environmental Impact Statement for the White Pine Energy Station Project

FES 08-38



Volume 1

Executive Summary

Chapter 1

Chapter 2

Chapter 3

October 2008

BLM

Ely Field Office / Nevada



BLM Mission Statement

The Bureau of Land Management is responsible for the stewardship of our public lands. It is committed to manage, protect, and improve these lands in a manner to serve the needs of the American people for all times.

Management is based upon the principles of multiple use and sustained yield of our nation's resources within a framework of environmental responsibility and scientific technology. These resources include recreation, rangelands, timber, minerals, watershed, fish and wildlife, wilderness, air and scenic, scientific and cultural values.



United States Department of the Interior

BUREAU OF LAND MANAGEMENT

Nevada State Office

P.O. Box 12000 (1340 Financial Blvd.)

Reno, Nevada 89520-0006

<http://www.nv.blm.gov>

In Reply Refer To:

2850(NV040)

N-78091

Dear Reader:

Enclosed for your information is the Final Environmental Impact Statement (EIS) for the White Pine Energy Station Project. The EIS evaluates the environmental effects that would result from granting rights-of-way requested by White Pine Energy Associates, LLC (WPEA) for the purpose of constructing and operating the White Pine Energy electric power generating plant and ancillary facilities. This approximately 1,590-megawatt coal-fired power plant and associated features would be located on public lands in White Pine County, eastern Nevada, that are presently managed by the Ely Field Office of the Bureau of Land Management (BLM). The power plant site for the Proposed Action is in the Steptoe Valley Hydrographic Basin, approximately 34 miles north of Ely, 22 miles north of McGill, and one mile west of U.S. 93.

The BLM compiled a Draft EIS that analyzed the environmental impacts of granting the rights-of-way requested by WPEA to construct and operate the White Pine Energy Station. The Draft EIS was released to the public on April 20, 2007 with publication of a Notice of Availability (NOA) in the *Federal Register*. The NOA initiated a 60-day public comment period ending on June 19, 2007. Public meetings on the Draft EIS were held May 8, 2007, in Ely, Nevada, and May 9, 2007, in Reno, Nevada. The BLM received 95 sets of written comments to the Draft EIS. BLM reviewed the comments and has provided written responses in this Final EIS. Some comments resulted in modifications to the text in the EIS.

The BLM may issue one or more records of decision (ROD) based on this Final EIS. The ROD(s) will not be issued until at least 30 days following the date on which the NOA announcing the availability of this Final EIS was published in the *Federal Register*. Persons wishing to provide BLM with comments to this Final EIS, which will be considered in formulating any resulting ROD, may do so within 30 days by providing said comments in writing to:

Doris Metcalf
Bureau of Land Management
Ely Field Office
HC 33, Box 33500
Ely, Nevada 89301-9408

If you have questions concerning the document, please contact Jane Peterson, Energy Projects Manager, at (775) 289-1800.

Sincerely,

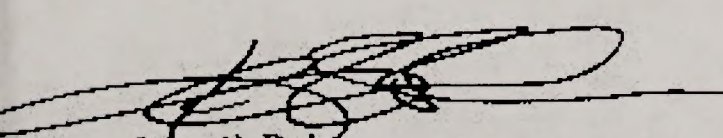

John F. Ruhs
District Manager
Ely District Office

Final Environmental Impact Statement for the White Pine Energy Station Project

Draft

Final

Lead Agency: United States Department of the Interior
Bureau of Land Management

Cooperating Agencies: National Park Service
Nevada Department of Wildlife
White Pine County, Nevada

Counties Directly Affected: White Pine County, Nevada

Environmental Impact Statement Contact: Correspondence on this Final Environmental Impact
Statement (Final EIS) should be directed to:

Jane Peterson
Bureau of Land Management, Ely District Office
HC 33 Box 33500
Ely, Nevada 89301-9408

Date Draft EIS filed with U.S. Environmental Protection Agency: April 20, 2007

Date this Final EIS made available to U.S. Environmental Protection Agency and the public: October 3, 2008

Abstract

This Final EIS evaluates the environmental effects that would result from constructing, operating, and maintaining the proposed White Pine Energy Station electric power generating plant. This approximately 1,590-megawatt (MW) coal-fired power plant and associated features would be located on public lands in White Pine County, eastern Nevada, that are presently managed by the Ely District Office of the U.S. Bureau of Land Management (BLM). The Proposed Action and Alternative 1 include the following project actions and features: issue Rights-of-Way for White Pine Energy Station construction and operation and subsequently arrange for the sale of the power plant site to White Pine Energy Associates, LLC; construct, operate, and maintain an approximately 1,590-MW (maximum) coal-fired electric power generating plant using a hybrid cooling system that has an expected commercial life of 40 years or longer; develop a wellfield in the Steptoe Valley Hydrographic Basin to meet the water needs of the power plant; construct a new rail spur from the Nevada Northern Railway to the power plant site to supply coal; develop the linear infrastructure necessary to connect the power plant to the new water source, to existing electric transmission lines serving the region, and to provide site access; construct and operate an off-site mineral material sale area to supply earth and rock for project construction; implement a seeding project to enhance the grazing and wildlife value of 700 to 900 acres; and implement best management practices and mitigation measures during construction, operation, and maintenance of the White Pine Energy Station to avoid or prevent the occurrence of impacts and, where possible, to minimize the magnitude, extent, and duration of those impacts when their occurrence cannot be prevented.

The Proposed Action and Alternative 1 differ primarily in the location of the power plant site, wellfield, and transmission line alignment (northern vs. southern). The power plant site for the Proposed Action is in the Steptoe Valley Hydrographic Basin, approximately 34 miles north of Ely, 22 miles north of McGill, and 1 mile west of U.S. 93. The power plant site for Alternative 1 is approximately 12 miles south of the Proposed Action

power plant site and 1 mile west of U.S. 93. The BLM has selected the Proposed Action as the environmentally preferred alternative.

Federal actions addressed in the accompanying document are the BLM's issuance of Rights-of-Way needed to construct and operate the White Pine Energy Station and facilitate the ultimate sale of land for the power plant site. This Final EIS satisfies the National Environmental Policy Act, which mandates that federal agencies analyze the environmental consequences of major undertakings.

Official responsible for the Environmental Impact Statement:

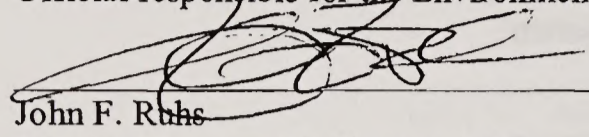

John F. Ruhs
District Manager, Ely District Office

9/17/08
Date

#276870609

1D88067315

HD
243
.N3
W458
2008
v.1
c.2

BLM

Final Environmental Impact Statement for the White Pine Energy Station Project



Volume 1
Executive Summary
Chapter 1
Chapter 2
Chapter 3

October 2008

Ely Field Office / Nevada



Contents

Chapter	Page
Volume 1	
Acronyms and Abbreviations	xix
ES.0 Executive Summary	ES-1
ES.1 Introduction	ES-3
ES.1.1 General Overview	ES-3
ES.1.2 BLM Purpose and Need	ES-3
ES.1.3 Project Purpose.....	ES-3
ES.1.4 Project Need	ES-3
ES.2 Description of Proposed Action and Alternatives.....	ES-7
ES.2.1 Proposed Action and Alternative 1	ES-7
ES.2.2 No Action Alternative	ES-9
ES.2.3 Preferred Alternative	ES-9
ES.2.4 Alternatives Considered but Eliminated from Detailed Evaluation.....	ES-9
ES.3 Affected Environment and Environmental Consequences.....	ES-10
ES.3.1 Proposed Action and Action Alternatives.....	ES-10
ES.3.2 No Action Alternative	ES-16
ES.4 Consultation and Coordination.....	ES-16
1.0 Introduction.....	1-1
1.1 General Overview	1-1
1.2 Purpose, Need, and Background.....	1-1
1.2.1 Introduction.....	1-1
1.2.2 BLM Purpose and Need.....	1-2
1.2.3 Project Purpose	1-2
1.2.4 Project Need.....	1-2
1.3 Project Location.....	1-6
1.4 Policies, Plans, and Programs	1-6
1.4.1 Relationships to BLM Policies, Plans, and Programs.....	1-6
1.4.2 Relationships to Non-BLM Policies, Plans, and Programs	1-6
1.5 Applicable Laws and Regulations and Authorizing Actions and Permits.....	1-9
1.5.1 Applicable Laws and Regulations	1-9
1.5.2 Permits and Approvals.....	1-9
1.6 Summary of Public Scoping and Issue Identification.....	1-9
1.7 Actions Considered for Cumulative Analysis.....	1-12
2.0 Description of Proposed Action and Alternatives.....	2-1
2.1 Introduction.....	2-1
2.2 Proposed Action.....	2-2
2.2.1 Description of BLM Actions	2-2
2.2.2 Description of Station Area	2-3

Chapter	Page
2.2.3 Description of Project Features and Rights-of-Way	2-4
2.2.4 Construction Activities	2-49
2.2.5 Operation, Maintenance, and Abandonment	2-61
2.2.6 Enhancement Measure	2-65
2.2.7 Best Management Practices	2-66
2.3 Alternative 1.....	2-67
2.3.1 Description of BLM Actions	2-67
2.3.2 Description of Station Area	2-67
2.3.3 Description of Project Features and ROWs.....	2-68
2.3.4 Construction Activities	2-75
2.3.5 Operation, Maintenance, and Abandonment	2-75
2.3.6 Enhancement Measure	2-76
2.3.7 Best Management Practices	2-76
2.4 No Action Alternative.....	2-76
2.5 Alternatives Considered but Eliminated from Detailed Evaluation	2-76
2.5.1 Alternative Power Generating Technologies	2-76
2.5.2 Conservation/Energy Efficiency.....	2-99
2.5.3 Alternative Power Plant Site Locations	2-100
2.5.4 Alternative Air Pollution Control Technologies.....	2-108
2.5.5 Alternative Cooling Technology.....	2-110
2.5.6 Alternative Power Plant Site Configuration	2-113
2.5.7 Alternative Rail Spurs.....	2-113
2.5.8 Alternative Structure Designs for Crossing Duck Creek.....	2-113
2.5.9 Alternative Well Field Electric Distribution Line Alignments and Design.....	2-114
2.5.10 Alternative Transmission Line Route	2-117
2.6 Preferred Alternative.....	2-117
3.0 Affected Environment	3-1
3.1 Introduction.....	3-1
3.2 Geology, Soils, and Minerals.....	3-1
3.2.1 Geology.....	3-1
3.2.2 Soils.....	3-7
3.2.3 Minerals	3-9
3.3 Surface Water Resources	3-13
3.3.1 Hydrologic Setting.....	3-13
3.3.2 Local Climate/Past Flooding Events.....	3-13
3.3.3 Surface Water Features	3-14
3.3.4 Water Quality.....	3-22
3.4 Ground Water Resources	3-23
3.4.1 Regional Conditions and Basic Concepts.....	3-23
3.4.2 Local Conditions.....	3-24
3.5 Biological Resources	3-51
3.5.1 Vegetation.....	3-51

Chapter	Page
3.5.2 Noxious and Invasive Weeds.....	3-60
3.5.3 Wildlife and Fisheries Resources.....	3-66
3.5.4 Threatened, Endangered, Candidate, and Sensitive Species.....	3-76
3.6 Air Quality, Climate Change, and Noise	3-107
3.6.1 Air Quality	3-107
3.6.2 Climate Change.....	3-123
3.7 Visual Resources.....	3-133
3.7.1 Analysis Area.....	3-133
3.7.2 Existing Conditions.....	3-133
3.7.3 BLM Visual Resource Management System.....	3-134
3.7.4 Key Observation Points	3-137
3.8 Recreation Resources.....	3-149
3.8.1 Analysis Area and Methodology	3-149
3.8.2 Recreational Opportunities on Federal Lands.....	3-149
3.8.3 Recreational Opportunities on State Lands.....	3-153
3.8.4 Recreational Opportunities on County Lands.....	3-154
3.8.5 Private Recreational Opportunities	3-154
3.8.6 Recreation Management Plans and Policies	3-155
3.9 Land Use.....	3-159
3.9.1 Existing Land Use and Land Ownership	3-159
3.9.2 Designated Land Use	3-160
3.10 Rangeland Resources.....	3-169
3.10.1 Livestock Grazing.....	3-169
3.10.2 Wild Horses	3-169
3.11 Special Designations.....	3-177
3.11.1 Wilderness Areas	3-177
3.11.2 Areas of Critical Environmental Concern.....	3-178
3.11.3 National Historic Trails.....	3-178
3.12 Wastes, Hazardous and Solid.....	3-181
3.12.1 Existing Conditions.....	3-181
3.12.2 Regulatory Framework	3-181
3.13 Cultural Resources.....	3-183
3.13.1 Resource Definition	3-183
3.13.2 Analysis Area and Methodology	3-183
3.13.3 Regulatory Framework	3-183
3.13.4 Criteria for Significance.....	3-184
3.13.5 Affected Environment Setting	3-184
3.13.6 Resources Identified Within the Area of Potential Effect	3-184
3.14 Environmental Justice.....	3-189
3.14.1 Study Area	3-189
3.14.2 Populations.....	3-189
3.15 Native American Religious Concerns.....	3-193
3.15.1 Analysis Area and Methodology	3-193
3.15.2 Regulatory Framework	3-193

Chapter	Page
3.16 Paleontological Resources	3-197
3.16.1 Analysis Area and Methodology	3-197
3.16.2 Regulatory Framework	3-197
3.16.3 Existing Conditions.....	3-198
3.17 Socioeconomics	3-199
3.17.1 Population	3-200
3.17.2 Employment and Job Base.....	3-201
3.17.3 Unemployment.....	3-202
3.17.4 Earnings and Income.....	3-203
3.17.5 Tax Receipts and Fiscal Resources.....	3-205
3.17.6 Housing.....	3-206
3.17.7 Community Infrastructure and Public Services	3-208
3.18 Transportation.....	3-215

Volume 2

4.0 Environmental Consequences.....	4-1
4.1 Introduction.....	4-1
4.1.1 Assumptions and Assessment Guidelines.....	4-1
4.1.2 Connected Actions Data Sources.....	4-2
4.1.3 Incomplete and/or Unavailable Information.....	4-4
4.2 Geology, Soils, and Minerals.....	4-5
4.2.1 Proposed Action.....	4-5
4.2.2 Alternative 1.....	4-6
4.2.3 Connected Actions	4-7
4.2.4 No Action Alternative.....	4-8
4.3 Surface Water Resources	4-9
4.3.1 Proposed Action.....	4-9
4.3.2 Alternative 1.....	4-12
4.3.3 Connected Actions	4-13
4.3.4 No Action Alternative.....	4-14
4.4 Ground Water Resources	4-15
4.4.1 Proposed Action Impacts	4-15
4.4.2 Proposed Action Mitigation.....	4-22
4.4.3 Alternative 1 Impacts.....	4-26
4.4.4 Alternative 1 Mitigation.....	4-33
4.4.5 Connected Actions	4-33
4.4.6 No Action Alternative.....	4-34
4.5 Biological Resources	4-35
4.5.1 Vegetation	4-35
4.5.2 Noxious and Invasive Weeds.....	4-50
4.5.3 Wildlife and Fisheries Resources.....	4-55
4.5.4 Threatened, Endangered, Candidate, and Sensitive Species.....	4-75
4.6 Air Quality, Climate Change, and Noise	4-95
4.6.1 Air Quality	4-95

Chapter	Page
4.6.2 Climate Change.....	4-135
4.6.3 Noise	4-137
4.7 Visual Resources.....	4-141
4.7.1 Description of Facilities.....	4-141
4.7.2 Proposed Action.....	4-142
4.7.3 Alternative 1.....	4-153
4.7.4 Connected Actions	4-160
4.7.5 No Action Alternative.....	4-160
4.8 Recreation Resources.....	4-163
4.8.1 Proposed Action.....	4-163
4.8.2 Alternative 1.....	4-166
4.8.3 Connected Actions	4-166
4.8.4 No Action Alternative.....	4-166
4.9 Land Use	4-167
4.9.1 Proposed Action.....	4-167
4.9.2 Alternative 1.....	4-173
4.9.3 Connected Actions	4-176
4.9.4 No Action Alternative.....	4-176
4.10 Rangeland Resources	4-177
4.10.1 Proposed Action.....	4-177
4.10.2 Alternative 1.....	4-179
4.10.3 Connected Actions.....	4-180
4.10.4 No Action Alternative.....	4-180
4.11 Special Designations.....	4-181
4.11.1 Proposed Action.....	4-181
4.11.2 Alternative 1.....	4-182
4.11.3 Connected Actions	4-183
4.11.4 No Action Alternative.....	4-183
4.12 Wastes, Hazardous and Solid.....	4-185
4.12.1 Proposed Action.....	4-185
4.12.2 Alternative 1.....	4-185
4.12.3 Connected Actions	4-186
4.12.4 No Action Alternative.....	4-186
4.13 Cultural Resources.....	4-187
4.13.1 Criteria for Determining Effect.....	4-187
4.13.2 Station Description.....	4-188
4.13.3 Assessment of Direct Impacts.....	4-189
4.13.4 Assessment of Indirect Visual Impacts.....	4-191
4.13.5 Connected Actions	4-225
4.13.6 No Action Alternative.....	4-226
4.14 Environmental Justice	4-227
4.14.1 Proposed Action.....	4-227
4.14.2 Alternative 1.....	4-228
4.14.3 Connected Actions	4-228
4.14.4 No Action Alternative.....	4-228

Chapter	Page
4.15 Native American Religious Concerns.....	4-229
4.15.1 Proposed Action.....	4-229
4.15.2 Alternative 1.....	4-229
4.15.3 Connected Actions.....	4-229
4.15.4 No Action Alternative.....	4-229
4.16 Paleontological Resources.....	4-231
4.16.1 Proposed Action.....	4-231
4.16.2 Alternative 1.....	4-231
4.16.3 Connected Actions.....	4-231
4.16.4 No Action Alternative.....	4-232
4.17 Socioeconomics.....	4-233
Methodology.....	4-233
4.17.1 Proposed Action.....	4-235
4.17.2 Alternative 1.....	4-259
4.17.3 Connected Actions.....	4-259
4.17.4 No Action Alternative.....	4-261
4.18 Transportation.....	4-263
4.18.1 Proposed Action.....	4-263
4.18.2 Alternative 1.....	4-266
4.18.3 Connected Actions.....	4-266
4.18.4 No Action Alternative.....	4-267
4.19 Cumulative Impacts.....	4-269
4.19.1 Introduction.....	4-269
4.19.2 Description of Actions Considered for Cumulative Analysis.....	4-269
4.19.3 Results of Cumulative Analysis.....	4-273
4.20 Summary of Mitigation Measures.....	4-325
4.20.1 Mitigation Measures Committed to by WPEA.....	4-325
4.20.2 BLM-Identified Mitigation Measures.....	4-331
4.21 Unavoidable Adverse Impacts.....	4-333
4.21.1 Geology, Soils, and Minerals.....	4-333
4.21.2 Surface Water Resources.....	4-333
4.21.3 Ground Water Resources.....	4-333
4.21.4 Biological Resources.....	4-333
4.21.5 Air Quality, Climate Change, and Noise.....	4-334
4.21.6 Visual Resources.....	4-335
4.21.7 Recreation Resources.....	4-335
4.21.8 Land Use.....	4-335
4.21.9 Rangeland Resources.....	4-335
4.21.10 Special Designations.....	4-335
4.21.11 Wastes, Hazardous and Solid.....	4-335
4.21.12 Cultural and Historical Resources.....	4-336
4.21.13 Native American Religious Concerns.....	4-336
4.21.14 Environmental Justice.....	4-336
4.21.15 Paleontological Resources.....	4-336

Chapter	Page
4.21.16 Socioeconomics	4-336
4.21.17 Transportation	4-336
4.22 Relationship Between Local Short-Term Uses of the Environment and the Maintenance and Enhancement of Long-Term Productivity	4-337
4.22.1 Introduction	4-337
4.22.2 Short-Term Uses	4-337
4.22.3 Maintenance and Enhancement of Long-Term Productivity	4-338
4.23 Irreversible and Irrecoverable Commitments of Resources	4-339
4.24 Energy Requirements and Conservation Potential	4-341
5.0 Consultation and Coordination	5-1
5.1 Introduction	5-1
5.2 Public Scoping	5-1
5.3 Coordination During DEIS Development	5-1
5.3.1 General Consultation	5-1
5.3.2 Native American Consultation	5-2
5.4 Notice of Intent and List of Agencies, Organizations, and Persons to Whom Copies of the DEIS were Sent	5-3
5.4.1 Notice of Intent	5-3
5.4.2 Distribution	5-3
5.4.3 Availability	5-4
5.5 Public Meetings	5-4
5.6 Public Comments on the DEIS	5-5
5.7 List of Preparers and Reviewers	5-5
6.0 References	6-1
Glossary	GL-1
Index	IN-1

Tables	Page
ES-1 Comparison of Project Components for the White Pine Energy Station Proposed Action and Alternative 1	ES-8
ES-2 Summary of Impacts by Resource for the White Pine Energy Station Proposed Action, Alternative 1, and No Action Alternative	ES-10
1-1 Laws, Regulations, and Executive Orders That May Apply to the Proposed Action and Alternative 1 of the White Pine Energy Station.....	1-10
1-2 Federal, State, and County Permits and Approvals That May be Needed to Implement the Proposed Action or Alternative 1 of the White Pine Energy Station	1-11
2-1 Estimated Acres of ROWs and Disturbed and Reclaimed Areas for the Proposed Action.....	2-11
2-2 Estimated Average Number of Construction Workers per Month for Three Construction Scenarios	2-50
2-3 Estimated Acres of ROWs and Disturbed and Reclaimed Areas for Alternative 1.	2-71
2-4 Comparison of Alternative Power Generating Technologies	2-78
2-5 Approximate Distance to Major Infrastructure Components for Potential Site Areas in the Northern (N), Central (C), Southern (S), and Ely-McGill (E-M) Study Regions	2-103
2-6 Comparison of Infrastructure and Environmental Items of Interest at Station Sites for the Central, Southern, and Northern Alternatives	2-106
2-7 Alternative Air Pollution Control Technologies.....	2-109
2-8 Comparison of Original and Revised Power Plant Design Alternatives	2-110
3.2-1 Mining Districts in Steptoe Valley	3-10
3.3-1 Average Monthly Climatic Data Ely and McGill, Nevada.....	3-14
3.3-2 Average Annual Flow in Steptoe Creek 1966 -2002	3-18
3.3-3 Duck Creek Discharge South of Cherry Creek Road	3-21
3.4-1 Values of Hydraulic Conductivity and Storage Coefficient for Basin-Fill Aquifers in Steptoe Valley.....	3-26
3.4-2 General Geologic Description of Basin-Fill in Steptoe Valley	3-30
3.4-3 Depth to Ground Water in Selected Wells in Steptoe Valley	3-34
3.4-4 Discharge Information on Selected Springs in Steptoe Valley.....	3-40
3.4-5 Information on Selected Geothermal Springs in Steptoe Valley	3-44
3.4-6 Ground Water Pumping History in Steptoe Valley	3-46
3.4-7 Summary of Ground Water Budget for Steptoe Valley.....	3-46
3.4-8 Water Quality Data From Selected Wells and Springs in Steptoe Valley	3-47
3.5-1 Areas Addressed During the White Pine Energy Station Wetland Delineation for the Proposed Action and Alternative 1 Project Components.....	3-58
3.5-2 Nevada Department of Agriculture Noxious Weed List.....	3-62
3.5-3 Invasive Plants Identified in Project Area	3-63
3.5-4 Weed Populations Present in or Along Project Feature Sites for the Proposed Action and Alternative 1	3-64
3.5-5 BLM and State (NDOW) Wildlife Species of Concern Potentially Occurring in the White Pine Energy Station Project Area.....	3-82
3.5-6 Greater Sage-grouse Leks Within the Survey Corridor (2-mile-wide-buffer) of the Project Area in Steptoe and Butte Valleys.....	3-89

Tables	Page
3.5-7 Historical Relict Dace Occurrence in Steptoe and Butte Valleys.....	3-95
3.5-8 Known Habitat Requirements and Status of Species with Special FWS, BLM, State of Nevada, or NNHP Status Evaluated for Potential Habitat in the White Pine Energy Station Project Area	3-97
3.5-9 Potential Habitat and Potential For Occurrence of Special Status Plant Species in the White Pine Energy Station Project Area	3-103
3.6-1 Great Basin National Park CASTNet Ozone Monitoring Data	3-111
3.6-2 Mercury (Hg) Concentrations and Dry Deposition Rates at Gibbs Ranch (24-Hour Averaging Period)	3-114
3.6-3 Mercury Fish Tissue Test Results in White Pine County from NDOW for 2006.	3-114
3.6-4 NDOW Suggested Monthly Fish Consumption Limits	3-114
3.6-5 Summary of IMPROVE Data	3-116
3.6-6 Average Minimum and Maximum Temperature and Precipitation.....	3-117
3.6-7 Source Inventory for Increment and NAAQS Modeling.....	3-118
3.6-8 Typical Noise Levels (dBA)	3-130
3.7-1 VRM Classes and Management Objectives.....	3-134
3.8-1 Developed BLM Recreation Sites within 50 Miles of the Project Area.....	3-150
3.8-2 Private Campgrounds and RV Parks within 50 Miles of the Project Area	3-155
3.9-1 Land Ownership Status within White Pine County	3-160
3.10-1 Grazing Allotments in the Study Area.....	3-170
3.10-2 Wild Horse HMA Characteristics.....	3-175
3.11-1 Wilderness in the Project Area	3-178
3.12-1 Summary of Applicable Regulations and/or Administering Agencies for Hazardous Materials	3-182
3.13-1 Summary of Identified Cultural Resources by Station Project Area	3-185
3.14-1 Poverty Thresholds Annual Income (\$) for 2004 by Size of Family and Number of Related Children Under 18 Years.....	3-190
3.14-2 Income Levels of Individuals Surveyed in Nevada and Project Area Census Tracts.....	3-190
3.14-3 Minority Population in Nevada and Project Area.....	3-191
3.17-1 Historic and Current Population Levels.....	3-200
3.17-2 Population Projections through 2026.....	3-201
3.17-3 Employment by Industry in White Pine County (2004)	3-202
3.17-4 Labor Force and Unemployment (2006).....	3-203
3.17-5 Personal Income (2004)	3-204
3.17-6 Earnings by Place of Work by Industry in White Pine County (2004)	3-204
3.17-7 Housing Characteristics (2000).....	3-207
3.17-8 School Enrollment and Capacity (2006-07)	3-211
3.18-1 Potential Source Towns and Cities for Project Construction and Operation Personnel and Associated Roadways to the White Pine Energy Station Project Sites.....	3-215
3.18-2 Roadway Levels of Service	3-216
3.18-3 Roadway Characteristics of Potential Routes to the Alternative Project Sites.....	3-217
4.5-1 Proposed Action: Estimated acres of Temporary and Permanent Impacts on Vegetation Communities	4-37

Tables	Page
4.5-2 Alternative 1: Estimated Acres of Temporary and Permanent Impacts on Vegetation Communities	4-44
4.5-3 Weed Densities for the White Pine Energy Station Proposed Action and Alternative 1 Sites.....	4-51
4.5-4 Potential for Adverse Effects to Special Status Wildlife Species Potentially Occurring in the White Pine Energy Station Project Area from the White Pine Energy Station Proposed Action and Alternative 1	4-76
4.6-1 Emissions During the Station Construction Phase.....	4-101
4.6-2 Total Emissions During the Station Construction Phase	4-101
4.6-3 Proposed Control Technologies for Pulverized Coal Boilers	4-103
4.6-4 Total Facility Estimated Emission of Criteria Pollutants	4-103
4.6-5 Estimated Emissions for Operation of Railroad Locomotive	4-104
4.6-6 Results of PSD Class II Modeling Analysis	4-106
4.6-7 Source Inventory for Increment and NAAQS Modeling.....	4-107
4.6-8 Air Toxics Risk Assessment Analysis	4-110
4.6-9 Stack Parameters Used in the Modeling Analysis	4-116
4.6-10 Emission Rates Used in the Modeling Analysis	4-116
4.6-11 Class I Area Single Source PSD Significant Impact Levels (SIL) and Cumulative Sources PSD Increments for Class I Areas	4-118
4.6-12 Department of Interior National Park Service (NPS) Sulfur and Nitrogen Deposition Analysis Thresholds (DATs).....	4-118
4.6-13 CALPUFF Estimated PSD Pollutant Concentrations Impacts at Class I Areas	4-120
4.6-14 CALPUFF Estimated Short-Term Sulfur Dioxide PSD Pollutant Concentrations at Class I Areas for the White Pine Energy Station Plus PSD Cumulative Sulfur Dioxide Sources	4-121
4.6-15 Comparison of the Highest Second High CALPUFF-Estimated at the Jarbidge Class I Area.....	4-121
4.6-16 CALPUFF Estimated Maximum Daily Extinction Estimates at Class I Areas for the White Pine Energy Station	4-122
4.6-17 Sensitivity of White Pine Energy Station CALPUFF Estimated Visibility Impacts at Class I Areas to Relative Humidity (RH).....	4-123
4.6-18 Summary of Hourly Surface Meteorological Observations at National Weather Service Site Nearest to the Jarbidge Wilderness Area Class I Area on February 4, 1996	4-124
4.6-19 Weather Interference Events During Estimated Adverse Visibility Days.....	4-125
4.6-20 Summary of Estimated Visibility Impacts at the Jarbidge Wilderness Area and Zion National Park Using CALPUFF f(RH) Factors, EPA's f(RH) Factors, Monthly f(RH) Factors, and Accounting for Rain and Snow in the Visibility Backgrounds	4-125
4.6-21 Nitrogen Deposition (kg-N/ha/yr) Averaged Across the Jarbidge Wilderness Area for the 3 Years of CALPUFF Modeling	4-128
4.6-22 Sulfur Deposition (kg-S/ha/yr) Averaged Across the Jarbidge Wilderness Area for the 3 Years of CALPUFF Modeling	4-128
4.6-23 Nitrogen Deposition (kg-N/ha/yr) Averaged Across Zion National Park for the 3 Years of CALPUFF Modeling.....	4-129

Tables	Page
4.6-24 Sulfur Deposition (kg-S/ha/yr) Averaged Across Zion National Park for the 3 Years of CALPUFF Modeling.....	4-129
4.6-25 CALPUFF Estimated PSD Pollutant Concentrations Impacts at the Great Basin National Park (GRBA) and Ruby Lake National Wildlife Refuge (RLNW) Class II Areas for the White Pine Energy Station Using 1-Kilometer CALMET Meteorological Fields and With Puff Splitting	4-130
4.6-26 CALPUFF Estimated Maximum Daily Extinction Estimates at the Great Basin National Park (GRBA) and Ruby Lake National Wildlife Refuge (RLNW) Class II Areas for the White Pine Energy Station.....	4-131
4.6-27 Nitrogen Deposition (kg-N/ha/yr) Averaged Across the Great Basin National Park (GRBA) Area for the 3 Years of CALPUFF Modeling	4-131
4.6-28 Nitrogen Deposition (kg-N/ha/yr) Averaged Across the Ruby Lake National Wildlife Refuge (RLNW) Class II Areas for the 3 Years of CALPUFF Modeling.....	4-132
4.6-29 Sulfur Deposition (kg-S/ha/yr) Averaged Across the Great Basin National Park (GRBA) Class II Area for the 3 Years of CALPUFF Modeling.....	4-132
4.6-30 Sulfur Deposition (kg-S/ha/yr) Averaged Across the Ruby Lake National Wildlife Refuge (RLNW) Class II Area for the 3 Years of CALPUFF Modeling.....	4-133
4.6-31 Greenhouse Gas (Carbon Dioxide) Comparison	4-136
4.6-32 Comparison of Carbon Dioxide Emissions from the White Pine Energy Station.	4-136
4.6-33 Calculated Proposed Action Construction and Operation Total Noise Levels at Hot Springs Ranch	4-138
4.7-1 Visible Facilities Associated with the White Pine Energy Station Power Plant Site	4-141
4.7-2 Summary of White Pine Energy Station Proposed Action and Alternative 1 VRM Class Objective Consistency.....	4-150
4.9-1 Land Uses Direct Impacts	4-169
4.9-2 Developed Land Uses and Distance from Center Line.....	4-169
4.9-3 Road Crossings by Segment and Route Alternative In the Station Project Area ..	4-170
4.9-4 BLM Land Use Authorizations in or Adjacent to Site/Row.....	4-172
4.10-1 Grazing Allotments Permanently Impacted by the White Pine Energy Station Proposed Action and Alternative 1	4-178
4.17-1 Summary of Estimated Annual Economic Output, Income, and Employment Impacts of the Proposed Action (Phase I-Two Generating Units)	4-239
4.17-2 Summary of Estimated Annual Economic Output, Income, and Employment Impacts of the Proposed Action (Phase II-Third Generating Unit)	4-240
4.17-3 Summary of Estimated Tax Revenues Generated Under the Proposed Action (Phase I-Two Generating Units)	4-242
4.17-4 Summary of Estimated Tax Revenues Generated Under the Proposed Action (Phase II-Third Generating Unit).....	4-244
4.19-1 Summary of Measured Ambient Background Concentrations	4-288
4.19-2 Comparison of Cumulative Impacts to the NAAQS.....	4-288
4.19-3 Comparison of Cumulative Impacts to the Class I PSD Increments	4-292

Tables	Page
4.19-4 Comparison of Cumulative Impacts to the Class II PSD Increments	4-292
4.19-5 Predicted Visibility Impacts at Jarbidge Wilderness Area	4-293
4.19-6 Predicted Visibility Impacts at Zion National Park	4-293
4.19-7 Predicted Visibility Impacts at Great Basin National Park.....	4-294
4.19-8 Predicted Visibility Impacts at Ruby Lake National Wildlife Refuge	4-294
4.19-9 National Park Service Predicted Visibility Impacts Due to the EEC and WPES Combined.....	4-295
4.19-10 Existing Measured Deposition Levels.....	4-296
4.19-11 Area-Specific Aquatic Ecosystems Analyzed.....	4-297
4.19-12 Summary of Cumulative Sulfur Deposition Analysis	4-299
4.19-13 Summary of Cumulative Nitrogen Deposition Analysis.....	4-299
4.23-1 Irreversible and Irretrievable Commitments of Resources.....	4-337
5-1 Comment Letters on the Draft MFP Amendment/EIS	5-6
5-2 EIS Interdisciplinary Team.....	5-8
5-3 EIS Core Team.....	5-8
5-4 EIS Consultant Team.....	5-9

Figures	Page
ES-1 Project Area	ES-5
1-1 Project Area	1-7
1-2 Projects Considered for Cumulative Analysis	1-13
2-1 Proposed Action.....	2-5
2-2 Preliminary Site Layout Proposed Action	2-7
2-3 Conceptual Rendering of Proposed Power Plant.....	2-9
2-4a Schematic of the Production Process.....	2-13
2-4b Boiler Emission Controls.....	2-15
2-4c Coal Handling Systems.....	2-17
2-4d Hybrid Cooling System.....	2-19
2-5 500-kV Transmission Line, Typical Tangent Steel Pole H-Frame.....	2-28
2-6 500-kV Transmission Line, Typical Dead End Steel Pole	2-29
2-7 500-kV Transmission Line, Typical Single Circuit Tangent.....	2-30
2-8 500-kV Transmission Line, Typical Single Circuit Dead End.....	2-31
2-9 500-kV Transmission Line, Typical Tangent Tower Double Circuit.....	2-32
2-10 Typical Groundwater Well Site	2-35
2-11 Water Supply System Linear Facilities.....	2-36
2-12 Typical Tangent Single Wood Pole	2-38
2-13 Typical Angle Single Wood Pole	2-39
2-14 Typical 13.8-kV Three Phase Transformer Bank Wood Pole	2-40
2-15 Thirtymile Substation ROW	2-43
2-16 Mineral Materials Sale Area	2-45
2-17 Alternative 1.....	2-55
2-18 Preliminary Site Layout Alternative 1	2-69
2-19 Areas Assessed for Power Plant Siting.....	2-101

Figures	Page
2-20	Project Feature Configurations Considered But Eliminated..... 2-111
2-21	Rail Spur Alternatives..... 2-115
3.2-1	Location and General Extent of the Basin and Range Province..... 3-3
3.2-2	Geologic Map of White Pine County 3-5
3.2-3	Mining Districts in the Steptoe Valley..... 3-11
3.3-1	Hydrologic Setting of the Proposed Action and Alternative 1 3-15
3.3-2	Location of Surface Water Divide Within Steptoe Hydrographic Region 3-19
3.4-1a	Geologic Log—Steptoe Well 2..... 3-28
3.4-1b	Geologic Log—Steptoe Well 1 and 3 3-29
3.4-2	Location of Wells with Geologic Logs and Water Quality Data 3-31
3.4-3	Hydrographs for Selected Wells in Steptoe Valley 3-35
3.4-4	Groundwater Elevations in Steptoe Valley, 1985..... 3-37
3.4-5	Location of Springs in Steptoe Valley 3-41
3.4-6	Locations of Ground Water Rights, Applications, and Permits..... 3-49
3.5-1	Vegetation Communities 3-53
3.5-2	Sage Grouse Habitat 3-91
3.6-1	Class I, Class II of Interest, and Non-Attainment Air Quality Areas 3-109
3.6-2	Wind Rose..... 3-119
3.6-3	Nearby PM10, SO2, and NO2 Sources..... 3-121
3.6-4	Global Mean Annual Temperature Anomaly, 1880-2007 3-124
3.6-5	National Weather Service Long-Term Temperature Trend Data 3-125
3.7-1	BLM Visual Resource Management (VRM) Classes..... 3-135
3.7-2	Key Observation Points (KOPs) 3-143
3.8-1	Developed Recreation Sites, ACECs, WAs, WSAs, ISAs 3-151
3.9-1	Land Ownership Status 3-161
3.9-2	Utilities and Utility Corridors 3-165
3.10-1	Grazing Allotments..... 3-171
3.10-2	Herd Management Areas 3-173
3.11-1	Wilderness Areas 3-179
4.4-1	Proposed Action Potential Project Induced Ground Water Level Declines 4-17
4.4-2	Proposed Action Potential Project Induced Ground Water Level Declines and Potentially Affected Springs 4-19
4.4-3	Proposed Action Potential Project Induced Ground Water Level Declines and Locations of Groundwater Permits 4-23
4.4-4	Alternative 1 Potential Project Induced Ground Water Level Declines 4-27
4.4-5	Alternative 1 Potential Project Induced Ground Water Level Declines and Potentially Affected Springs 4-29
4.4-6	Alternative 1 Potential Project Induced Ground Water Level Declines and Locations of Groundwater Permits 4-31
4.5-1	Big Game Species Deer 4-57
4.7-1	Proposed Action Stack and Power Block Seen Area Analysis..... 4-145
4.7-2	Proposed Action Transmission Line Seen Area Analysis 4-147
4.7-3	Alternative 1 Stock and Power Block Seen Area Analysis 4-155
4.7-4	Alternative 1 Transmission Line Seen Area Analysis 4-157
4.19-1	Summary of Predicted Temperatures..... 4-304

Photos	Page
3.7-1 View from KOP 1	3-139
3.7-2 View from KOP 2	3-139
3.7-3 View from KOP 3	3-141
3.7-4 View from KOP 4	3-141
3.7-5 View from KOP 5	3-147
3.7-6 View from KOP 6	3-147
4.7-1 Simulation of View of Proposed Action from KOP 2. Representative of simulation of view from KOP 1	4-151
4.7-2 Simulation of View of Proposed Action from KOP 3	4-151
4.7-3 Simulation of View of Alternative 1 from KOP 4	4-161
4.7-4 Simulation of View of Alternative 1 from KOP 5	4-161
4.13-1 View Toward Proposed Action with Historic Structure in Foreground	4-195
4.13-2 View Toward Proposed Action with Schellbourne Ranch in Foreground	4-195
4.13-3 View of Proposed Action (5.5 Miles Distant) from Schellbourne Ranch	4-197
4.13-4 View of Proposed Action From County Road 18 (the Intersection of Pony Express NHT and Lincoln Highway)	4-197
4.13-5 View South Toward Proposed Action From County Road 18	4-201
4.13-6 Lincoln Highway Facing North – South of the Proposed Action	4-201
4.13-7 Lincoln Highway Facing South – North of Alternative 1	4-203
4.13-8 View of Proposed Action Facing West	4-203
4.13-9 View of Proposed Action From the North End of Magnuson Ranch	4-205
4.13-10 Cherry Creek Station – View of Proposed Action From North of Water Tank ..	4-205
4.13-11 View Towards Proposed Action From Ray Siding	4-209
4.13-12 Raiff Siding – View toward Proposed Action	4-209
4.13-13 View Toward Proposed Action From Warm Springs Siding	4-211
4.13-14 View Toward Proposed Action	4-211
4.13-15 View Toward Alternative 1 From Western Edge of Ranch Property	4-213
4.13-16 View Toward Alternative 1 (Historic structure in lower portion of photograph)	4-213
4.13-17 View of Lincoln Highway Facing South (Alternative 1 would be located in the background to the right)	4-217
4.13-18 View of Alternative 1 From Magnuson Ranch	4-217
4.13-19 View of Alternative 1 directly west from Lincoln Highway	4-219
4.13-20 View of Alternative 1 From Lincoln Highway and Duck Creek Road	4-219
4.13-21 View Toward Alternative 1 From Warm Springs Siding	4-221
4.13-22 View Toward Alternative 1 From Corrals	4-221
4.13-23 View Toward Alternative 1	4-223
4.13-24 Glenn Siding – View toward Alternative 1 Site	4-223

Volume 3

Appendixes A through Q

- A Development Agreement
- B Water Rights Agreement
- C Best Management Practices
- D Evaluation of Alternative Control Strategies
- E Carbon Capture and Sequestration
- F Memorandum Between White Pine Energy Associates, LLC and State of Nevada
- G Ground Water Monitoring Program
- H Alternative Coal-Fueled Generating Technologies
- I Wetlands
- J Biological Resources Supplemental Information
- K U.S. Fish and Wildlife Service Correspondence
- L Cumulative Analysis for Air Quality
- M Understanding and Evaluating Climate Change
- N Visual Inventory Forms
- O Programmatic Agreement
- P Cultural Resources Background Information
- Q Documentation of the Application of Numerical Model to Simulate Ground Water Response to Pumping for the Proposed White Pine Energy Station in Steptoe Valley, Nevada

Volume 4

Appendixes R through U

- R Responses to Federal Comments on the DEIS
- S Responses to State and Local Comments on the DEIS
- T Responses to Group and Organization Comments on the DEIS
- U Responses to Individual's Comments on the DEIS

Acronyms and Abbreviations

AADT	Annual Average Daily Traffic
ACEC	Area of Critical Environmental Concern
ADT	average daily traffic
ADTT	average daily truck traffic
AEGL	acute exposure guideline levels
APE	Area of Potential Effect
n	nitrogen
bgs	below ground surface
BLM	Bureau of Land Management
BMPs	best management practices
BP	Before Present
BPI	Building Profile Input Program
CFR	Code of Federal Regulations
cfs	cubic feet per second
dba	A-weighted decibels
DEIS	Draft Environmental Impact Statement
DOI	U.S. Department of the Interior
EIS	Environmental Impact Statement
EPA	U.S. Environmental Protection Agency
ESA	Endangered Species Act
FAA	Federal Aviation Administration
FEIS	Final Environmental Impact Statement
FEMA	Federal Emergency Management Act
FLM	Federal Land Manager
FLPMA	Federal Land Policy and Management Act
FWS	U.S. Fish and Wildlife Service
FY	fiscal year
gal/day/ft	gallons per day per foot
GIS	geographic information system
gpd/ft	gallons per day per foot

gpm	gallons per minute
HAP	hazardous air pollutant
HMA	herd management area
HWI	Hawkwatch International
IPP	Intermountain Power Project
ISA	Instant Study Area
ITA	Indian Trust assets
IWAQM	Inter-Agency Work Group on Air Quality Monitoring
kg/ha.yr	kilogram per hectare per year
KOP	Key Observation Point
kV	kilovolt
LOS	Level of Service
$\mu\text{g}/\text{m}^3$	micrograms per cubic meter
MBTA	Migratory Bird Treaty Act
MMBTU	million BTU
MP	milepost
MRL	Minimal Risk Levels
MW	megawatt
NAAQs	National Ambient Air Quality Standards
NDEP	Nevada Division of Environmental Protection
NDOT	Nevada Department of Transportation
NDOW	Nevada Department of Wildlife
NEPA	National Environmental Policy Act
NHT	National Historic Trail
NIEHS	National Institute of Environmental Health Sciences
NNHP	Nevada Natural Heritage Program
NNR	Nevada Northern Railway
NPDES	National Pollutant Discharge Elimination System
NPS	National Park Service
NRHP	National Register of Historic Places
NRS	Nevada Revised Statute
NSPS	New Source Performance Standards

NWI	National Wetlands Inventory
NWP	Nationwide Permit Program
PCB	polychlorinated biphenyls
PM ₁₀	particulate matter with mean aerometric diameter smaller than 10 microns
PSD	Prevention of Significant Deterioration
RCRA	Resource Conservation and Recovery Act
ROW	right-of-way
RV	recreational vehicle
SCORP	Statewide Comprehensive Outdoor Recreation Plan
SCR	selective catalytic reduction
SHPO	State Historic Preservation Office
SIL	significant impact level
SNWA	Southern Nevada Water Authority
SPCCP	Spill Prevention, Control, and Countermeasure Plan
SR	State Route
SWIP	Southwest Intertie Project
TCP	traditional cultural property
TDS	total dissolved solids
USACE	U.S. Army Corps of Engineers
USC	U.S. Code
USDI	U.S. Department of the Interior
USFS	U.S. Forest Service
USGS	United States Geological Survey
VOCs	volatile organic compounds
VRM	Visual Resource Management
WA	Wilderness Area
WMA	Wilderness Management Area
WPES	White Pine Energy Station
WPEA	White Pine Energy Associates, LLC
WSA	Wilderness Study Area

ES.0 Executive Summary

The following sections summarize the *Final Environmental Impact Statement (FEIS) for the White Pine Energy Station Project*. This summary provides a general overview of the proposed project and its purpose and need; briefly describes the Proposed Action and other alternatives; summarizes major impacts for key resources associated with the Proposed Action, Alternative 1, and the No Action Alternative; and lists key consultation and coordination activities.

There are a number of differences between this FEIS and the *Draft Environmental Impact Statement (DEIS) for the White Pine Energy Station Project*. This FEIS is a much larger document than the DEIS, primarily in response to comments by the public on the DEIS. However, conclusions reached in this FEIS regarding potential direct, indirect, and cumulative effects of the proposed White Pine Energy Station (also referred to as the Station) are essentially the same as conclusions reached in the DEIS. Reasons for the increased size of this FEIS compared to the DEIS include the addition of new appendixes that provide background discussions of information presented in the DEIS and that also provide information that informs responses to comments by the public on the DEIS. By themselves, comments by the public on the DEIS and responses to those comments, which are presented in the appendixes of this FEIS, contribute substantially to the increased size of this document.

The following types of additional information are presented in this FEIS that support the analyses contained in the DEIS. Resource or subject areas that received additional analysis or where potential effects were discussed further in response to a public comment on the

DEIS, or simply to clarify for the reader potential project effects, are also listed below. They are as follows:

- Public Comments and Responses
 - Comments from the public on the DEIS and responses to those comments grouped according to the following four categories: Federal Agencies (Appendix R), State and Local Agencies (Appendix S), Groups and Organizations (Appendix T), and Individuals (Appendix U)
- Agreements between White Pine Energy Associates (WPEA) and White Pine County
 - Interim Development Agreement between WPEA and White Pine County for the proposed White Pine Energy Station (Appendix A)
 - Water Supply Agreement between WPEA and White Pine County for the proposed Station (Appendix B)
- Alternative Technologies
 - Discussion of Alternative Coal-Fueled Generating Technologies at the proposed Station (Appendix H)
 - Evaluation of Alternative Control Strategies for air quality at the proposed Station (Appendix D)
 - Discussion of Alternative Air Pollution Control Technologies (Chapter 2, Section 2.5.4)
- Air Quality and Climate Change
 - Additional discussion of baseline conditions (Chapter 3, Sections 3.6.1 and 3.6.2) and potential direct, indirect, and

- cumulative effects (Chapter 4, Sections 4.6.1, 4.6.2, 4.19.3.6.1, and 4.19.3.6.2) on air quality and greenhouses gases/climate change resulting from the proposed Station
 - Understanding and Evaluating Climate Change and assessing the potential contribution of the proposed Station (Appendix M)
 - Air quality analyses (Chapter 4, Section 4.6.1) discussing carbon dioxide emissions from the proposed Station would be approximately 12.88 tons per year rather than 20 tons per year as described in the DEIS
 - Air quality analyses (Chapter 4, Section 4.6.1) discussing the potential for acidification of high mountain lakes and impacts to visibility in sensitive airsheds resulting from the proposed Station
 - Cumulative Analysis for Air Quality for the proposed Station and past, present, and other reasonably foreseeable actions (Appendix L)
- Carbon Capture
 - Potential for Carbon Capture and Sequestration at the proposed Station (Appendix E)
 - Memorandum of Understanding between WPEA and the State of Nevada and Commitment by WPEA for the Station to be a Carbon Capture Ready Facility (Appendix F)
 - Commitment by WPEA of a Land Set-Aside for Future Carbon Capture Technology as a feature of the proposed Station (Chapter 2, Section 2.2.3.1.2)
- Ground Water
 - Ground Water Monitoring Program and mitigation actions for the proposed Station production wells to minimize the potential for ground water impacts and avoid impacts to springs (Appendix G)
 - Ground water cumulative impacts analysis of potential impacts with past, present, and other reasonably foreseeable actions, including the proposed Ely Energy Center (Chapter 4, Section 4.19.3.4)
- Wetlands
 - Clarification that potential Station effects on wetlands are estimated at 4 acres for the Proposed Action and 6 acres for Alternative 1 (Chapter 4, Section 4.5.1) and commitment by WPEA to mitigate for wetlands effects according to agency policy (Chapter 4, Section 4.5.1.3.3)
- Cumulative Effects
 - Additional discussion in Chapter 4, Section 4.19, on the potential for cumulative effects from the proposed Station when combined with the effects of past, present, and other reasonably foreseeable future actions
- Mitigation Measures and Best Management Practices
 - List of all mitigation measures committed to by WPEA (Chapter 4, Section 4.20.1); additional mitigation identified by the BLM (Chapter 4, Section 4.20.2); and Best Management Practices (Appendix C) that will be implemented by WPEA for the proposed Station

ES.1 Introduction

ES.1.1 General Overview

The Proposed Action and Alternative 1 for the White Pine Energy Station were developed in response to a proposal by White Pine Energy Associates, LLC, (WPEA) to construct, own, operate, and maintain an approximately 1,590-megawatt (MW) coal-fired electric power generating plant in White Pine County in eastern Nevada. The power plant and associated features (electric transmission facilities, water supply system, electric distribution line, rail spur, access roads, mineral material sale, and Moriah Ranches Seeding Project) would be located primarily on lands managed by the Ely Field Office of the U.S. Department of the Interior Bureau of Land Management (BLM) (see Figure ES-1).

The power plant site for the Proposed Action is in Steptoe Valley, approximately 34 miles north of Ely, 22 miles north of McGill, and 1 mile west of U.S. Highway 93 (U.S. 93). Steptoe Valley is bordered on the east by the Schell Creek Range and on the west by the Egan Range. The Utah border is approximately 40 miles east and the northern boundary of Great Basin National Park approximately 57 miles southeast of the Proposed Action power plant site. An alternative power plant site (Alternative 1), also in Steptoe Valley, is approximately 12 miles south of the Proposed Action power plant site and 1 mile west of U.S. 93.

ES.1.2 BLM Purpose and Need

The purpose of the BLM action is to provide public land for the development of energy production by allowing for the construction of power plants on public lands managed by the BLM. The multiple-use mission of the BLM includes managing activities such as mineral development, energy production,

recreation, and grazing, while conserving natural, historical, cultural, and other resources on public lands. The BLM's objective is to meet public needs for use authorizations such as Rights-of-Way (ROWs), permits, leases, and easements while avoiding or minimizing adverse impacts to other resource values. The proposal to construct, operate, and maintain a coal-fired power plant on public lands would be in accordance with this objective.

ES.1.3 Project Purpose

The purpose of the White Pine Energy Station is to supply reliable, low-cost electricity in an environmentally responsible manner to meet baseload energy needs in Nevada and the western United States, and to bring economic benefits to White Pine County, Nevada. The purpose of WPEA's ROWs applications to the BLM is to allow the White Pine Energy Station to be developed on BLM-managed public land.

ES.1.4 Project Need

Adequate and reliable electricity supply is essential to the well-being of the American people and the economy. The construction of new power generation and transmission facilities is required to meet increasing demands for electricity. The White Pine Energy Station is being developed to serve baseload electric needs.

The Western Electricity Coordinating Council forecasts that "reported generating capacity additions in the region may not be sufficient to reliably supply the forecast firm peak demand and energy requirements throughout the [2005-2014] period" (Western Electricity Coordinating Council, 2005). The Energy Information Administration (2007) forecasts (starting in 2006) the need for approximately

20,500 MW of new power generation in the western United States by 2015 (72,500 MW by 2030) to meet growing energy needs and maintain reliable operation of the electric system. The need for additional electric power forecasted by the Energy Information Agency and the Western Electricity Coordinating Council assumes a reasonable amount of conservation will occur and is factored into the demand.

The Energy Information Administration (2007) estimates that new coal-fired generation facilities will supply 7,600 MW by 2015 (51,000 MW by 2030) of this need for new generation capacity. The report indicates that in the West the proportion coal generation contributes to total electric generation will increase from 23.2 percent in 2007 to 35.6 percent in 2015 and 59.0 percent in 2030.

The Public Utility Commission of Nevada (PUCN) has reported a projected capacity shortfall of 4,000 MW by 2020 in Nevada if new generation capacity is not added (PUCN, Resource Planning 2007, Nevada's Electricity Future: A Portfolio-Focused Approach). Also in Nevada, Nevada Power Company (2006) and Sierra Pacific Power Company (2006) have identified the need for approximately 5,500 MW of additional electric capacity beyond their existing generation capacity and secured purchases by 2015. The White Pine Energy Station would help fill part of the identified need for electricity by providing approximately 1,590 MW of new baseload coal-fired electric generation capacity.

Completion of the White Pine Energy Station also would help meet stated objectives of the Nevada State Office of Energy and Nevada electric utilities to increase fuel diversity in the State of Nevada. The addition of stable-priced, low-cost, coal-fired capacity would reduce

the risk of reliance on volatile and more expensive natural gas-fired generation and the impacts of droughts on hydropower.

WPEA's proposal to locate the Station in Steptoe Valley approximately 34 miles (Proposed Action site) or 22 miles (Alternative 1 site) north of Ely is based on the following factors:

- The Station site is near the NNR, which would be upgraded and used to supply coal to the power plant that is needed in order to generate electricity.
- The Station site is near a utility corridor that is permitted for a new 500,000-volt electric transmission line that would extend from Idaho to Clark County, Nevada. Access to this utility corridor provides a route to existing electric transmission facilities in White Pine County, specifically 345,000-volt and 230,000-volt transmission lines near Robinson Summit, and provides access to planned regional electric transmission facilities.
- The Station site is centrally located to the ground water source that would be used to supply the White Pine Energy Station's water needs. A reliable and economical water supply is central to a low-cost baseload, steam power plant and is available in the form of water rights held by White Pine County.
- The Station site can be easily accessed via U.S. 93 and is within a short driving distance to the population centers of Ely and McGill.
- The availability of a water supply was among the key factors in WPEA's decision to undertake the proposed Station and to site it at the proposed location in White Pine County.

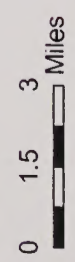
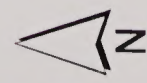
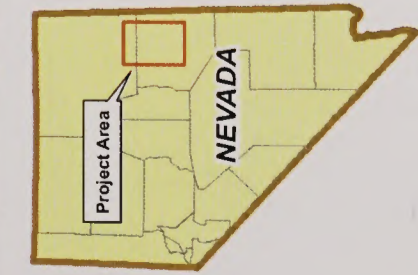
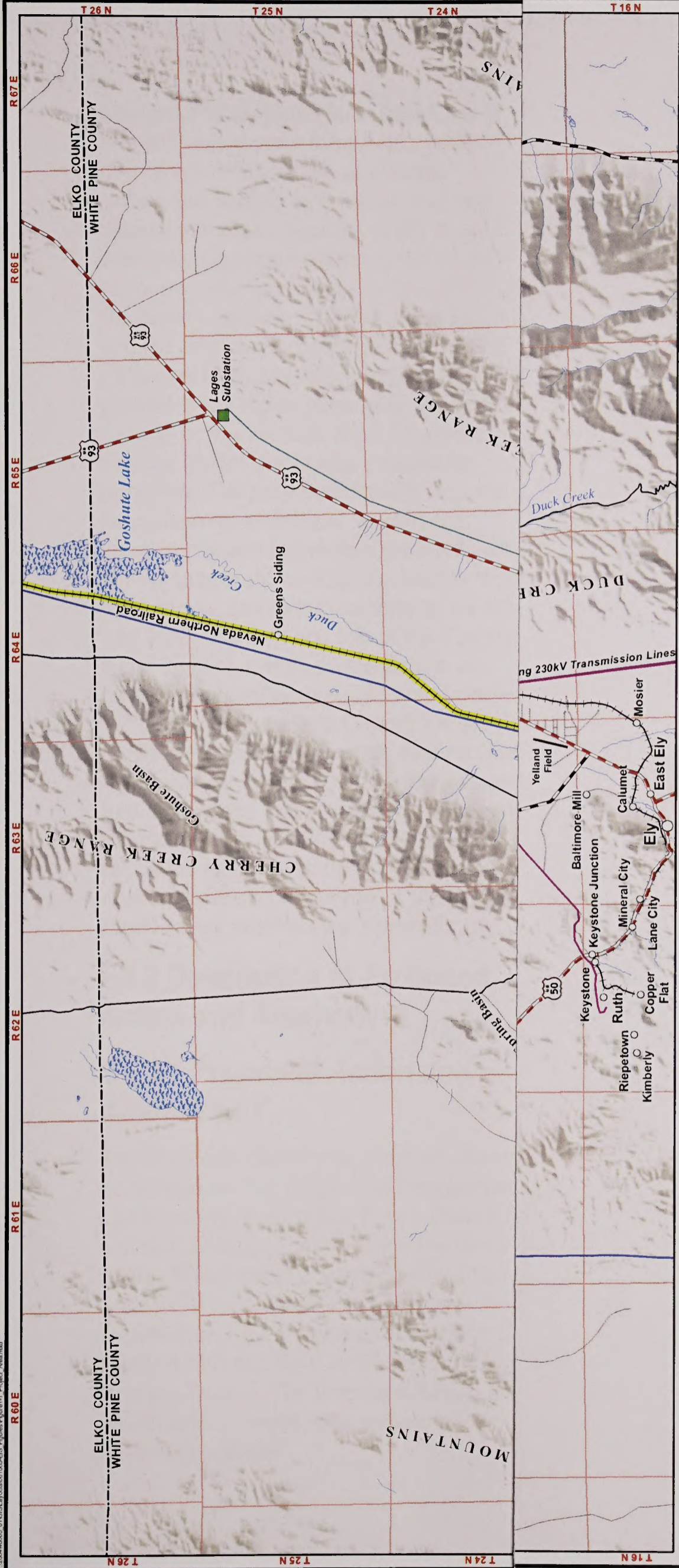

1:300,000 when printed at 11 x 17 inches

- Existing Electrical Features**
- Existing Substation
 - Existing Transmission Line
 - Existing Distribution Line
- Surface Water**
- Perennial Stream or River
 - Wetland
- Connected Action**
- SWIP Transmission Line
 - NNR Upgrade
- Common Project Features**
- Minerals Materials Sale Area
 - Moriah Ranches
 - Seeding Project

- Proposed Action Project Features**
- Proposed Well Site
 - Proposed Water Pipeline/ Distribution Line
 - Proposed Rail Spur
 - Proposed Transmission Line
 - Proposed Electric Distribution Line
 - Proposed Access Road
 - Proposed Substation Site
 - Proposed Power Plant Site

- Alternative 1 Project Features**
- Proposed Well Site
 - Proposed Water Pipeline/ Distribution Line
 - Proposed Rail Spur
 - Proposed Transmission Line
 - Proposed Electric Distribution Line
 - Proposed Access Road
 - Proposed Substation Site
 - Proposed Power Plant Site

Project Area
White Pine Energy Station Project

Figure ES-1

20,500 MW of new power generation in the western United States by 2015 (72,500 MW by 2030) to meet growing energy needs and maintain reliable operation of the electric system. The need for additional electric power forecasted by the Energy Information Agency and the Western Electricity Coordinating Council assumes a reasonable amount of conservation will occur and is factored into the demand.

The Energy Information Administration (2007) estimates that new coal-fired generation facilities will supply 7,600 MW by 2015 (51,000 MW by 2030) of this need for new generation capacity. The report indicates that in the West the proportion coal generation contributes to total electric generation will increase from 23.2 percent in 2007 to 35.6 percent in 2015 and 59.0 percent in 2030.

The Public Utility Commission of Nevada (PUCN) has reported a projected capacity shortfall of 4,000 MW by 2020 in Nevada if new generation capacity is not added (PUCN, Resource Planning 2007, Nevada's Electricity Future: A Portfolio-Focused Approach). Also in Nevada, Nevada Power Company (2006) and Sierra Pacific Power Company (2006) have identified the need for approximately 5,500 MW of additional electric capacity beyond their existing generation capacity and secured purchases by 2015. The White Pine Energy Station would help fill part of the identified need for electricity by providing approximately 1,590 MW of new baseload coal-fired electric generation capacity.

Completion of the White Pine Energy Station also would help meet stated objectives of the Nevada State Office of Energy and Nevada electric utilities to increase fuel diversity in the State of Nevada. The addition of stable-priced, low-cost, coal-fired capacity would reduce

the risk of reliance on volatile and more expensive natural gas-fired generation and the impacts of droughts on hydropower.

WPEA's proposal to locate the Station in Steptoe Valley approximately 34 miles (Proposed Action site) or 22 miles (Alternative 1 site) north of Ely is based on the following factors:

- The Station site is near the NNR, which would be upgraded and used to supply coal to the power plant that is needed in order to generate electricity.
- The Station site is near a utility corridor that is permitted for a new 500,000-volt electric transmission line that would extend from Idaho to Clark County, Nevada. Access to this utility corridor provides a route to existing electric transmission facilities in White Pine County, specifically 345,000-volt and 230,000-volt transmission lines near Robinson Summit, and provides access to planned regional electric transmission facilities.
- The Station site is centrally located to the ground water source that would be used to supply the White Pine Energy Station's water needs. A reliable and economical water supply is central to a low-cost baseload, steam power plant and is available in the form of water rights held by White Pine County.
- The Station site can be easily accessed via U.S. 93 and is within a short driving distance to the population centers of Ely and McGill.
- The availability of a water supply was among the key factors in WPEA's decision to undertake the proposed Station and to site it at the proposed location in White Pine County.

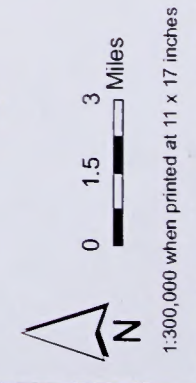
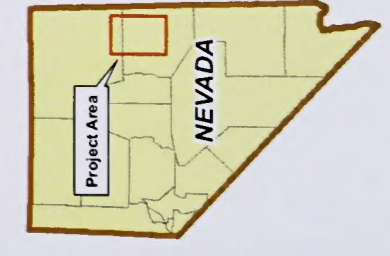

Existing Electrical Features

- Existing Substation
- Existing Transmission Line
- Existing Distribution Line

Surface Water

- Perennial Stream or River
- Wetland

Connected Action

- SWIP Transmission Line
- NNR Upgrade

Common Project Features

- Minerals Materials Sale Area
- Moriah Ranches
- Seeding Project

Proposed Action Project Features

- Proposed Well Site
- Proposed Water Pipeline/Distribution Line
- Proposed Rail Spur
- Proposed Transmission Line
- Proposed Electric Distribution Line
- Proposed Access Road
- Proposed Substation Site
- Proposed Power Plant Site

Alternative 1 Project Features

- Proposed Well Site
- Proposed Water Pipeline/Distribution Line
- Proposed Rail Spur
- Proposed Transmission Line
- Proposed Electric Distribution Line
- Proposed Access Road
- Proposed Substation Site
- Proposed Power Plant Site

Project Area
White Pine Energy Station Project

Figure ES-1

Siting the Station in White Pine County, Nevada would meet long-held county objectives of attracting an electric generation facility to bring needed and desired economic benefits to the county, strengthening and stabilizing the county economy, and improving the quality of life for county citizens. The Proposed Action and the other action alternative (Alternative 1) would put to beneficial use ground water rights granted to White Pine County by the Nevada State Engineer in Steptoe Valley for energy production purposes. The proposed Station also would help generate additional support for reactivating and upgrading the NNR, which would benefit the county's economy through recreational and industrial uses of the NNR. The NNR upgrade and use of the County's water rights are both recognized in an Interim Development Agreement between WPEA and White Pine County for the proposed White Pine Energy Station (see Appendix A). White Pine County entered into an updated Water Supply Agreement in February 2008 granting WPEA the exclusive right to use these water rights for development and operation of the White Pine Energy Station (see Appendix B).

ES.2 Description of Proposed Action and Alternatives

ES.2.1 Proposed Action and Alternative 1

The Proposed Action and Alternative 1 were developed for the White Pine Energy Station and would each include a Power Plant ROW and sale, Electric Transmission Facilities ROW, Water Supply System ROW, Rail Spur ROW, Access ROW, Electric Distribution Line Construction ROW, Mineral Material Sale, and Moriah Ranches Seeding Project. The Proposed Action and Alternative 1 would each include the following actions:

- Issue ROWs for construction and operation of the Station and subsequently arrange for the sale of the land covered by the Power Plant ROW to WPEA.
- Construction and operation of an approximately 1,590-MW coal-fired electric power generating plant using hybrid cooling systems that has an expected commercial life of 40 years or longer.
- Construction and operation of a water supply system in the Steptoe Valley Hydrographic Basin to meet the water needs of the power plant.
- Construction and operation of a new rail spur from the NNR to the power plant to supply coal.
- Construction and operation of electric transmission facilities to connect the power plant with existing and planned electric transmission facilities serving the region.
- Construction and operation of road access and certain utility access to the power plant and other Station features.
- Construction and operation of an electric distribution line for the supply of power during the construction period.
- Construction and operation of an off-site mineral material sale area (borrow area) for the supply of earth and rock materials to be used in the construction process.
- Implementation of a seeding project to enhance the grazing and wildlife value on 700 to 900 acres.
- Implementation of best management practices (BMPs), mitigation measures committed to by WPEA, and additional mitigation measures identified by the BLM during Station construction, operation, and maintenance to avoid or prevent the occurrence of impacts and, where possible, to minimize the magnitude, extent, and

duration of those impacts when their occurrence can not be prevented.

Table ES-1 compares project components for the Station Proposed Action and Alternative 1.

TABLE ES-1

Comparison of Project Components for the White Pine Energy Station Proposed Action and Alternative 1

Project Component	Proposed Action	Alternative 1
BLM Action	Issue ROWs for construction and operation of all Station features on BLM-managed land. Subsequent sale of power plant site to WPEA	Issue ROWs for construction and operation of all Station features on BLM-managed land. Subsequent sale of power plant site to WPEA
Power Plant Construction	Construct and operate up to a three-unit, approximately 1,590-MW coal-fired, hybrid-cooled power plant	Construct and operate up to a three-unit, approximately 1,590-MW coal-fired, hybrid-cooled power plant
Power Plant Location	Sections 31 and 32, T22 North, R64 East and Sections 5 and 6, T21 North, R64 East in White Pine County, NV (Northern Site)	Sections 28, 29, 32 and 33, T20 North, R64 East in White Pine County, NV (Southern Site)
Electric Distribution and Transmission	Construct and operate a 32-mile-long overhead 500-kV transmission line connecting the Duck Creek Substation to the Thirtymile Substation. Construct and operate a 2.5-mile-long loop of the overhead 500-kV SWIP line connecting to the Duck Creek Substation.	Construct and operate a 28-mile-long overhead 500-kV transmission line connecting the Duck Creek Substation to the Thirtymile Substation. Construct and operate a 6-mile-long loop of the overhead 500-kV SWIP line connecting to the Duck Creek Substation.
Switchyards	Construct and operate the 60-acre Duck Creek Substation at the power plant and the 77-acre Thirtymile Substation near Robinson Summit	Construct and operate the 60-acre Duck Creek Substation at the power plant and the 77-acre Thirtymile Substation near Robinson Summit
Coal Supply Access	Construct and operate a 1.3-mile-long rail spur crossing Duck Creek and connecting to the upgraded NNR.	Construct and operate a 3-mile-long rail spur connecting to the upgraded NNR.
Power Plant Road Access	Construct and maintain a 1-mile-long paved access road from U.S. 93	Construct and maintain a 0.3-mile-long paved access road from U.S. 93
Ground Water Well Field	Construct and operate a system of 8 production wells and up to ten monitoring wells north of the power plant site	Construct and operate a system of 8 production wells and up to four monitoring wells south of the power plant site
Well Field Pipelines	Construct and operate 13 miles of 10- to 30-inch-diameter water pipeline connecting the wells to the power plant	Construct and operate 8 miles of 10- to 30-inch-diameter water pipeline connecting the wells to the power plant
Well Field Electric Distribution Line and Access Road	Construct and operate 13 miles of 13.8-kV overhead distribution lines and a 10-foot-wide access road servicing each well site	Construct and operate 8 miles of 13.8-kV overhead distribution lines and a 10-foot-wide access road servicing each well site
Mineral Material Sale	Use during construction, a 40-acre earth and rock borrow area in Section 35, T22 North, R63 East in White Pine County, NV.	Use during construction, a 40-acre earth and rock borrow area in Section 35, T22 North, R63 East in White Pine County, NV.
Moriah Ranches Seeding Project	Implement a seeding program on 700 to 900 acres to improve forage for livestock and wildlife on public lands 16 miles north of McGill and immediately west of U.S. 93	Implement a seeding program on 700 to 900 acres to improve forage for livestock and wildlife on public lands 16 miles north of McGill and immediately west of U.S. 93
Best Management Practices and Mitigation Measures	Commitment to construct, operate, and maintain the various Station features in accordance with a series of best management practices and mitigation measures	Commitment to construct, operate, and maintain the various Station features in accordance with a series of best management practices and mitigation measures

ES.2.2 No Action Alternative

Under the No Action Alternative, Station-related ROWs would not be created, the land covered by the Power Plant ROW subsequently would not be sold to WPEA, and the Station power plant and related facilities would not be constructed or operated as described for the Proposed Action or Alternative 1.

ES.2.3 Preferred Alternative

BLM's Preferred Alternative is the Proposed Action.

ES.2.4 Alternatives Considered but Eliminated from Detailed Evaluation

A number of alternatives were considered but were eliminated from detailed evaluation because they failed to meet project purpose and need, were operationally infeasible, were economically infeasible, were environmentally unacceptable, and/or did not afford environmental advantages over the Proposed Action or Alternative 1.

Alternative power generating technologies and fuels were eliminated because they did not meet one or more of the following six detailed criteria that were developed to assess the degree to which potential alternatives would satisfy the purpose and need for the White Pine Energy Station, and would be "reasonable" for National Environmental Policy Act purposes (that is, economically and technically practical and feasible):

- Capable of providing approximately 1,590 MW of reliable baseload power generation capacity
- Environmentally permissible
- Cost effectiveness relative to pulverized coal

- Commercially proven and reliable
- Place water held by White Pine County for power production in Steptoe Valley to beneficial use for power production
- Provide traffic for the NNR

Alternative power plant locations were eliminated because they were infeasible from engineering (infrastructure needs versus availability) and economic (construction and operational costs) perspectives, would result in unacceptable environmental and socioeconomic impacts, and/or did not afford environmental advantages over the Proposed Action or Alternative 1.

Alternative power plant designs and site configurations, rail spur locations, bridge designs for crossing Duck Creek, and well field electric distribution lines alignment and design were considered but eliminated from detailed analysis primarily because of unacceptable environmental impacts to biological resources and potentially to cultural resources. Alternative air pollution control technologies were considered but eliminated from detailed analysis because of technical infeasibility, or environmental, energy, and economic impacts. An alternative power plant cooling technology was considered but eliminated from detailed analysis because of potential impacts to ground water. Alternative transmission line routes were eliminated because of engineering and environmental issues and concerns (inconsistent with land use plan, conflict with private property, need for multiple power lines, and viewshed impacts).

ES.3 Affected Environment and Environmental Consequences

ES.3.1 Proposed Action and Action Alternatives

Table ES-2 summarizes major impacts, including unavoidable adverse impacts, anticipated under the Proposed Action and Alternative 1 by resource. Unavoidable adverse impacts on resources are those residual impacts remaining after implementation of mitigation measures. These impacts would primarily be associated with lands that would be disturbed and/or included in construction ROWs. Under the Proposed Action, 1,907 acres would be temporarily disturbed by Station construction and 1,511 acres would be permanently (construction plus the life of the Station plus the life of any post-Station use) disturbed by Station operations. The power plant ROW that the BLM would subsequently sell to WPEA would make up 1,281 acres of the permanently disturbed acres under the Proposed Action. Under Alternative 1, 1,948 acres would be temporarily disturbed and 1,570 acres

would be permanently disturbed. The power plant ROW would make up 1,330 acres of the permanently disturbed acres under Alternative 1. Although the power plant parcels have been identified for disposal by the BLM, their transferal from public to private ownership would preclude the continuation of existing land uses (some recreation, grazing) on the fenced site.

Other affected or potentially affected resources would include soils; several special status plant and animal species; plant species and vegetative cover; and various wildlife species and their habitat. Under the Proposed Action, pumping ground water could result in localized ground water level declines between 2 and 6 feet in 12 nearby areas where springs are present on the floor of Steptoe Valley. Information from the ground water monitoring and mitigation program for the production wells will be used to modify the pumping strategy, if needed, to avoid impacts to springs in accordance with the ground water monitoring program documented in Appendix G. Pumping ground water under Alternative 1 would not affect springs.

TABLE ES-2

Summary of Impacts by Resource for the White Pine Energy Station Proposed Action, Alternative 1, and No Action Alternative

Proposed Action	Alternative 1	No Action Alternative
3.2 and 4.2*—Geology, Soils, and Minerals		
1,907 acres of soil disturbed during construction. 1,511 acres permanently disturbed.	1,948 acres of soil disturbed during construction. 1,570 acres permanently disturbed.	No Station-related impacts would occur.
3.3 and 4.3*—Surface Water Resources		
No effect to water resources. Effects to wetlands are described in Section 4.5.1, <i>Vegetation</i> .	No effect to water resources. Effects to wetlands are described in Section 4.5.1, <i>Vegetation</i> .	No Station-related impacts would occur.

TABLE ES-2

Summary of Impacts by Resource for the White Pine Energy Station Proposed Action, Alternative 1, and No Action Alternative

Proposed Action	Alternative 1	No Action Alternative
3.4 and 4.4*—Ground Water Resources		
Lowers ground water level near production wells. No effect on existing wells. Pumping ground water could result in localized ground water level declines between 2 and 6 feet in 12 nearby areas where springs are present on the floor of Steptoe Valley. A ground water monitoring and mitigation program will be implemented.	Lowers ground water level near production wells. No effect on existing wells or springs. A ground water monitoring and mitigation program will be implemented.	No Station-related impacts would occur.
3.5.1 and 4.5.1*—Biological Resources: Vegetation		
399 acres of vegetation, including 2 acres of wetlands, temporarily disturbed during construction. 1,517 acres of vegetation, including 4 acres of wetlands, permanently disturbed.	379 acres of vegetation, including 27 acres of wetlands, temporarily disturbed during construction. 1,535 acres of vegetation, including 6 acres of wetlands, permanently disturbed.	No Station-related impacts would occur.
3.5.2 and 4.5.2*—Biological Resources: Noxious and Invasive Weeds		
Potential for spread of noxious and invasive weeds but minimized by BMPs	Potential for spread of noxious and invasive weeds but minimized by BMPs	No Station-related impacts would occur.
3.5.3 and 4.5.3*—Biological Resources: Wildlife and Fisheries Resources		
399 acres of wildlife habitat disturbed during construction. 1,517 acres of wildlife habitat permanently disturbed. No effect on fisheries. The Moriah Ranches Seeding Project would enhance wildlife value on 700 to 900 acres of public land.	379 acres of wildlife habitat disturbed during construction. 1,535 acres of wildlife habitat permanently disturbed. No effect on fisheries. The Moriah Ranches Seeding Project would enhance wildlife value on 700 to 900 acres of public land.	No Station-related impacts would occur.
3.5.4 and 4.5.4*—Biological Resources: Threatened, Endangered, Candidate, and Sensitive Species		
Potential to affect special status species because of loss of habitat. Pumping ground water could result in localized ground water level declines between 2 and 6 feet in 12 nearby areas where springs are present on the floor of Steptoe Valley. A ground water monitoring and mitigation program will be implemented to prevent effects on special status species associated with springs.	Potential to affect special status species because of loss of habitat. No effect on springs or special status species associated with springs.	No Station-related impacts would occur.

TABLE ES-2

Summary of Impacts by Resource for the White Pine Energy Station Proposed Action, Alternative 1, and No Action Alternative

Proposed Action	Alternative 1	No Action Alternative
3.6.1 and 4.6.1*—Air Quality		
<p>Minimal impacts during construction; the primary issue would be fugitive dust, which would be controlled by water spray on disturbed areas. Emissions during Station operations have been demonstrated to meet the National Ambient Air Quality Standards (NAAQS). These standards have been set to protect public health, including the health of “sensitive” populations, and to protect public welfare, including protection against decreased visibility, damage to animals, crops, vegetation, and buildings. There would, however, be perceptible visibility impacts at Zion National Park and Jarbidge Wilderness Area (Class I areas) and Ruby Lake National Wildlife Refuge and Great Basin National Park (Class II areas). The visibility analysis predicts perceptible visibility changes for a small number of days at Zion National Park, Jarbidge Wilderness Area, and Ruby Lake National Wildlife Refuge, and for a moderate number of days at Great Basin National Park. These visibility impacts were not sufficient to cause the National Park Service to reach an “adverse impact determination,” which is a possible outcome for Class I areas as part of the PSD process. Sulfur and nitrogen deposition at Great Basin National Park and Ruby Lake National Wildlife Refuge exceed the deposition analysis thresholds, indicating the need for additional analysis to evaluate the impacts. This additional analysis was conducted as part of the NEPA cumulative analysis and shows that adverse effects due to sulfur and nitrogen deposition are not expected.</p>	<p>Minimal impacts during construction; the primary issue would be fugitive dust, which would be controlled by water spray on disturbed areas. Emissions during Station operations have been demonstrated to meet the NAAQS. These standards have been set to protect public health, including the health of “sensitive” populations, and to protect public welfare, including protection against decreased visibility, damage to animals, crops, vegetation, and buildings. There would, however, be perceptible visibility impacts at Zion National Park and Jarbidge Wilderness Area (Class I areas) and Ruby Lake National Wildlife Refuge and Great Basin National Park (Class II areas). The visibility analysis predicts perceptible visibility changes for a small number of days at Zion National Park, Jarbidge Wilderness Area, and Ruby Lake National Wildlife Refuge, and for a moderate number of days at Great Basin National Park. These visibility impacts were not sufficient to cause the National Park Service to reach an “adverse impact determination,” which is a possible outcome for Class I areas as part of the PSD process. Sulfur and nitrogen deposition at Great Basin National Park and Ruby Lake National Wildlife Refuge exceed the deposition analysis thresholds, indicating the need for additional analysis to evaluate the impacts. This additional analysis was conducted as part of the NEPA cumulative analysis and shows that adverse effects due to sulfur and nitrogen deposition are not expected.</p>	<p>No Station-related impacts would occur.</p>
3.6.2 and 4.6.2*—Climate Change		
<p>An estimated 12.88 million tons of carbon dioxide would be emitted from the Station per year, adding incrementally to the global total of anthropogenic greenhouse gases. No procedures have been established to predict the potential climate impacts of a single carbon dioxide emission source like the Station. Therefore, it is not possible to meaningfully predict potential climate impacts associated with the Project. See Appendix M for additional information.</p>	<p>An estimated 12.88 million tons of carbon dioxide would be emitted from the Station per year, adding incrementally to the global total of anthropogenic greenhouse gases. No procedures have been established to predict the potential climate impacts of a single carbon dioxide emission source like the Station. Therefore, it is not possible to meaningfully predict potential climate impacts associated with the Project. See Appendix M for additional information.</p>	<p>No Station-related impacts would occur.</p>

TABLE ES-2

Summary of Impacts by Resource for the White Pine Energy Station Proposed Action, Alternative 1, and No Action Alternative

Proposed Action	Alternative 1	No Action Alternative
3.6.3 and 4.6.3*—Noise		
Highest noise level during construction estimated at 74 dBA at nearest receptor. This level would be short term and result from steam blowouts. Noise from operations would be below background levels.	Lower potential noise impact than for Proposed Action because nearest receptor further away. Noise from operations would be below background levels.	No Station-related impacts would occur.
3.7 and 4.7*—Visual Resources		
The power plant, particularly the stacks and cooling towers, and transmission towers would be visible from much of Steptoe Valley. However, all features would meet Visual Resource Management (VRM) class objectives.	The power plant, particularly the stacks and cooling towers, and transmission towers would be visible from much of Steptoe Valley. However, all features would meet VRM class objectives.	No Station-related impacts would occur.
3.8 and 4.8*—Recreation Resources		
The increase in number of workers during construction and operation would increase the use of recreation resources in the Station project area.	The increase in number of workers during construction and operation would increase the use of recreation resources in the Station project area.	No Station-related impacts would occur.
3.9 and 4.9*—Land Use		
All facilities would be on BLM-administered land. Proposed ROWs would be shared with some other ROW holders. The proposed Station facilities comply with federal and local land use policies. The BLM would subsequently dispose of the land by sale where the power plant site ROW is authorized.	Nearly all facilities would be on BLM-administered land. Proposed ROWs would be shared with some other ROW holders. The proposed Station facilities comply with federal and local land use policies. The BLM would subsequently dispose of the land by sale where the power plant site ROW is authorized.	No Station-related impacts would occur.
3.10 and 4.10*—Rangeland Resources		
The Moriah Ranches Seeding Project would enhance grazing value on 700 to 900 acres.	The Moriah Ranches Seeding Project would enhance grazing value on 700 to 900 acres.	No Station-related impacts would occur.
3.11 and 4.11*—Special Designations		
No Wilderness or Areas of Critical Environmental Concern would be affected by the Station. The Pony Express Trail, a National Historic Trail, would be crossed by the well field pipeline and electric distribution line.	No Wilderness or Areas of Critical Environmental Concern would be affected by the Station.	No Station-related impacts would occur.
3.12 and 4.12*—Wastes, Hazardous and Solid		
The Station would result in a solid waste disposal area being constructed and operated at the power plant site and would be permanently located there. Some hazardous materials would be temporarily stored on the power plant site before being transported offsite to an appropriately permitted disposal facility.	The Station would result in a solid waste disposal area being constructed and operated at the power plant site and would be permanently located there. Some hazardous materials would be temporarily stored on the power plant site before being transported offsite to an appropriately permitted disposal facility.	No Station-related impacts would occur.

TABLE ES-2

Summary of Impacts by Resource for the White Pine Energy Station Proposed Action, Alternative 1, and No Action Alternative

Proposed Action	Alternative 1	No Action Alternative
3.13 and 4.13*—Cultural Resources		
<p>One prehistoric site and a segment of the NNR would be disturbed that are considered eligible for the National Register of Historical Places (NRHP). In addition, three prehistoric sites eligible for the NRHP are located in the Thirtymile Substation area. Up to six historic ranches, two points along the Lincoln Highway and two points along the NNR would be subject to high indirect visual impacts. The Pony Express Trail, a National Historic Trail, would be crossed by the well field pipeline and electric distribution line.</p>	<p>A segment of the NNR would be reconstructed that is considered eligible for the NRHP. Four prehistoric properties would be affected by project features in Steptoe Valley. In addition, three prehistoric sites eligible for the NRHP are located in the Thirtymile Substation area. One point along the Lincoln Highway and three points along the NNR would be subject to high indirect visual impacts.</p>	<p>No Station-related impacts would occur.</p>
3.15 and 4.15*—Native American Religious Concerns		
<p>None identified</p>	<p>None identified</p>	<p>No Station-related impacts would occur.</p>
3.14 and 4.14*—Environmental Justice		
<p>No impacts</p>	<p>No impacts</p>	<p>No Station-related impacts would occur.</p>
3.16 and 4.16*—Paleontological Resources		
<p>None identified</p>	<p>None identified</p>	<p>No Station-related impacts would occur.</p>
3.17 and 4.17*—Socioeconomics		
<p>Economic benefits to White Pine County would result from the Station. Local infrastructure would be stressed during construction but Station construction commitments, including provision of onsite housing for construction workers, would prevent most impacts.</p>	<p>Economic benefits to White Pine County would result from the Station. Local infrastructure would be stressed during construction but Station construction commitments, including provision of onsite housing for construction workers, would prevent most impacts.</p>	<p>No Station-related impacts would occur.</p>
3.18 and 4.18*—Transportation		
<p>Traffic on U.S. 93 would increase during Station construction but not reduce the Level of Service class. The NNR is to be upgraded to Class 3 status and accommodate 12 coal trains to and from the power plant per week.</p>	<p>Traffic on U.S. 93 would increase during Station construction but not reduce the Level of Service class. The NNR is to be upgraded to Class 3 status and accommodate 12 coal trains to and from the power plant per week.</p>	<p>No Station-related impacts would occur.</p>

*Refers to detailed resource discussions in EIS sections of Chapter 3 (*Affected Environment*) and Chapter 4 (*Environmental Consequences*).

Other Station-related effects would include the presence of construction vehicles, equipment, personnel, and activities, and associated fugitive dust

emissions during construction. Emissions during Station operations have been demonstrated to meet the National Ambient Air Quality Standards (NAAQS).

These standards have been set to protect public health, including the health of “sensitive” populations, and to protect public welfare, including protection against decreased visibility, damage to animals, crops, vegetation, and buildings. There would, however, be perceptible visibility impacts at Zion National Park and Jarbidge Wilderness Area (Class I areas) and Ruby Lake National Wildlife Refuge and Great Basin National Park (Class II areas). The visibility analysis predicts perceptible visibility changes for a small number of days at Zion National Park, Jarbidge Wilderness Area, and Ruby Lake National Wildlife Refuge, and for a moderate number of days at Great Basin National Park. These visibility impacts were not sufficient to cause the National Park Service to reach an “adverse impact determination,” which is a possible outcome for Class I areas as part of the PSD process. Sulfur and nitrogen deposition at Great Basin National Park and Ruby Lake National Wildlife Refuge exceed the deposition analysis thresholds, indicating the need for additional analysis to evaluate the impacts. This additional analysis was conducted as part of the NEPA cumulative analysis and shows that adverse effects resulting from sulfur and nitrogen deposition are not expected.

Also, constructed Station features would not comply with the BLM’s designated VRM Classes when viewed from one location each for the Proposed Action and Alternative 1.

Visual impacts of project features on the historic integrity of several historical resources (NNR, Magnuson Ranch rest stop, Whiteman Ranch, and Lincoln Highway) could be minimized but not entirely mitigated. Another possible unavoidable adverse impact on cultural resources would be their accidental

disturbance if inadvertently encountered during construction. The Cultural Resources Programmatic Agreement for the proposed Station would be followed to mitigate potential adverse impacts to cultural and historical resources. Station effects on transportation would include traffic increases during Station construction on highways that are considered potential access routes to the proposed power plant sites but no change in the Level of Service class for these highways during project construction.

Overall, development of the White Pine Energy Station would result in a range of economic benefits to White Pine County. These benefits include, but are not limited to, local income and job creation, generation of tax revenue, and the development of a reliable and affordable source of power. Also, the Station would help diversify the local economy, resulting in less dependence on the boom-and-bust cycle of the mining industry. Economic benefits would likely also extend outside of the county based on purchases of goods and services during Station construction and operations, as well as power-related benefits. These economic benefits would be derived, in part, from putting to beneficial use water rights held by White Pine County and re-establishment of the NNR.

Construction of the proposed White Pine Energy Station would result in the irreversible and irretrievable commitments of some resources. Irreversible impacts would include labor, capital, some construction materials, fuels, soils, and possibly cultural resources. Irretrievable impacts on environmental resources would generally not extend past the life of the Station. Affected resources would include biological resources, air quality and noise, soils, ground water, visual and recreation resources, land use, possibly cultural

resources, and socioeconomics. Irretrievable impacts would also include the potential to reduce the life of the City of Ely landfills if used for Station solid waste.

ES.3.2 No Action Alternative

If the No Action Alternative is selected for implementation, existing conditions and trends for the affected environment in the Station project area would continue. The purposes and needs that were identified for the proposed Station would not be met. Under the No Action Alternative, water rights held by White Pine County for energy production in Steptoe Valley may not be placed to a beneficial use and may be subject to forfeit by the Nevada State Engineer. Additional traffic on the NNR may be forgone, challenging the economic feasibility of rehabilitation of the line by the City of Ely.

ES.4 Consultation and Coordination

A Notice of Intent to Prepare an Environmental Impact Statement was published in the Federal Register on August 6, 2004 (Volume 69, Number 151, pages 47954-47955). Public scoping meetings for the White Pine Energy Station were held in Ely on August 23, 2004, and in Reno on August 24, 2004. Meeting objectives were to learn the concerns of individuals, organizations, and agencies regarding the proposed Station and to allow interested parties to participate in developing a list of issues to be addressed in the EIS.

The meetings were publicized through newspaper advertisements and individual mailings. On August 13 and August 20, 2004, advertisements were published in the *Ely Times* and the *Reno Gazette-Journal*. Mailings were sent to 210 addresses. The meetings were conducted using an open-

house format. At each meeting, WPEA, EIS contractor, and BLM representatives presented Station information on display boards and handouts, and discussed concerns with individuals. The Ely meeting was attended by 42 people, and the Reno meeting was attended by 11 people.

Individuals, public agencies, and non-profit organizations submitted written comments to the BLM after the meetings. Thirty-five letters containing 231 comments were received. Most commentors expressed concerns regarding potential impacts of the proposed power plant on local resources and suggested the following issues should be addressed in the EIS: air quality; water development, use, and ground water; wildlife, habitat, and ecological concerns; socioeconomics, visual resources, and recreation; transportation, roads, and railroad; power need and recipients; proposed site, alternatives, and transmission lines; energy efficiency, conservation, and alternative energy; waste and hazardous materials, and; power plant technology and noise.

Numerous federal, state, and county agencies, and Native American Tribes were consulted during the preparation of this FEIS. BLM representatives initiated formal and informal communication with Native American Tribal representatives in the Station project area to discuss the proposed White Pine Energy Station. This process provided Tribes the opportunity to identify potential effects of the Station on Native American interests. A Native American coordination meeting was conducted on December 8, 2004, in the BLM Ely Field Office with representatives from the Ely Shoshone Tribe, Duckwater Shoshone Tribe, WPEA, and the Ely Field Office. Station details were presented to the group by WPEA, followed by a discussion of issues and concerns. After

the December 2004 meeting, BLM Ely Field Office staff have remained in communication with the Tribes regarding the Station. The most recent meeting with the Tribes was in July 2006. At this point in the project, no issues or concerns have been raised by the Tribes regarding any religious or traditional cultural properties.

The DEIS was sent to, and comments requested from, the general public and entities including federal, state, and local governments; Tribal governments; other organizations; and Members of the U.S. Congress and the Governor of Nevada. The DEIS was made available at numerous public libraries and BLM offices.

The public comment period on the DEIS opened with the announcement of the availability of the *Draft EIS for the White Pine Energy Project* in the Federal Register on April 20, 2007. Public comments on the *Draft EIS for the White Pine Energy Project* were accepted until June 19, 2007. Two public meetings were held to receive comments on the DEIS. The first meeting, in Ely, Nevada on May 8, 2007, was attended by 66 people. The second meeting, in Reno, Nevada on May 9, 2007, attended by 34 people. People asked questions and were able to submit comments during the meetings.

The BLM also received correspondence containing comments on the DEIS during the comment period. Correspondence was received from four federal agencies, eight state or local agencies, eight interest groups, and 75 citizens. Each letter was closely reviewed to identify portions of text that addressed the DEIS content. Responses to each comment were then prepared. The responses also indicate, if deemed appropriate, that changes or additions to the text of this FEIS have been made and where they can be found.

All letters and their content (including those not designated as a comment on the DEIS) will be reviewed by the BLM and considered in their decision regarding this project and the federal action.

Chapter 1.0 Introduction

1.1 General Overview

The Proposed Action and alternatives evaluated in this document were developed in response to a proposal by White Pine Energy Associates, LLC, (WPEA) to construct, own, operate, and maintain an approximately 1,590-megawatt (MW) coal-fired electric power generating plant. The power plant and associated features (electric transmission facilities, water supply system, electric distribution line, rail spur, and access roads) would be located primarily on lands managed by the Ely Field Office of the U.S. Department of the Interior Bureau of Land Management (BLM). This document evaluates the BLM action and potential environmental effects that would result from the granting of rights-of-way (ROWs) for electric transmission lines and substations, wellfield and water pipeline, electric distribution line, railroad spur, access roads, and ancillary features, and the ultimate sale of the power plant site under the Federal Land Policy and Management Act of 1976 (FLPMA) for the construction, operation, and maintenance of the electric power generating plant.

This document was prepared in compliance with the Council on Environmental Quality regulations for implementing the National Environmental Policy Act (NEPA) (40 CFR Sec. 1500-1508); the *NEPA Handbook*, H-1790-1; and the Ely Field Office *Environmental Analysis Guidebook*: Sections 201, 202, and 206 of FLPMA of 1976 (43 CFR Sec. 1600). The Ely, Nevada, Field Office of the BLM is the federal lead agency in the NEPA process and development of this document. The National Park Service, Nevada Department of Wildlife, and White Pine County, Nevada, are cooperating agencies.

1.2 Purpose, Need, and Background

1.2.1 Introduction

The construction of new power generation facilities is required throughout the western United States to meet the increasing demand for power resulting from population growth, business expansion, and other factors.

The western United States is projected to have the largest percent change in population of any region with an estimated 45.8 percent growth between 2000 and 2030 (Census Bureau, 2005). Nevada has one of the fastest rates of population growth in the United States and the demand for power continues to increase. Population increases and economic growth in Nevada will result in a demand for electricity that cannot be met with existing power generation resources.

According to Executive Order 13212, May 18, 2001, "The increased production and transmission of energy in a safe and environmentally sound manner is essential to the well-being of the American people...agencies shall take appropriate actions, to the extent consistent with applicable law, to expedite projects that will increase the production, transmission, or conservation of energy."

WPEA is proposing the White Pine Energy Station in White Pine County, Nevada, to help meet baseload electricity demand in Nevada and the western United States. WPEA is proposing to locate the White Pine Energy Station on federally administered lands managed by the BLM.

WPEA is an independent power producer. Power from the White Pine Energy Station would be sold on a wholesale basis to

utilities, municipalities, cooperatives and/or other wholesale customers.

Customers of the White Pine Energy Station would be identified after the necessary approvals to construct the facility are obtained.

1.2.2 BLM Purpose and Need

The purpose of the action is to provide public land for the development of energy production by allowing for the construction of a power plant on public lands managed by the BLM. The multiple-use mission of the BLM includes authorizing and managing activities such as mineral development, energy production, recreation, and grazing, while conserving natural, historical, cultural, and other resources on public lands. The BLM's objective is to meet public needs for use authorizations such as ROWs, permits, leases, and easements while avoiding or minimizing adverse impacts to other resource values. The proposal to construct, operate, and maintain a coal-fired power plant on public lands would be in accordance with this objective.

The need for BLM action is established by FLPMA to respond to applications for ROW Grants and a request for land disposal. Section 2.2.1, *Description of BLM Actions*, describes in detail the BLM actions that would occur in response to the application for ROWs submitted by WPEA for the White Pine Energy Station.

1.2.3 Project Purpose

The purpose of the White Pine Energy Station is to supply reliable, low-cost electricity in an environmentally responsible manner to meet baseload energy needs in Nevada and the western United States, and to bring economic benefits to White Pine County, Nevada. To achieve this purpose, the Station must:

- Use commercially proven and reliable technology
- Be cost-effective
- Be located in proximity to infrastructure and water supplies in White Pine County needed to support the Station's operations
- Put water rights held by White Pine County for energy production in Steptoe Valley to a beneficial use in producing energy
- Provide traffic for the Nevada Northern Railway (NNR)

The purpose of WPEA's ROWs application to the BLM is to allow the White Pine Energy Station to be developed.

The phrase "environmentally responsible manner" is intended to mean that the White Pine Energy Station would meet or exceed all applicable environmental regulations and that environmental considerations were taken into account in the Station design and construction procedures.

"Commercially Proven and Reliable" refers to technologies that are operational at a commercial scale; can produce consistent, reoccurring results; are employed across numerous facilities; and do not require extended periods of testing and operational modifications to achieve the design performance.

1.2.4 Project Need

Adequate and reliable electricity supply is essential to the well-being of the American people and the economy. The construction of new power generation and transmission facilities is required to meet increasing demands for electricity.

Electricity demand varies on an instantaneous, daily, and seasonal basis as a function of the usage of electrical devices. Generally, the most economical and reliable means of supplying electric load is to have three types of generating facilities: baseload facilities; intermediate load facilities; and peaking load facilities. The White Pine Energy Station is being developed to serve baseload electric needs.

Baseload facilities operate near full capacity 24 hours per day and must be efficient, highly reliable, and economize fuel. Large-scale generating facilities fueled by coal, nuclear, or hydropower typically serve baseload energy needs in the most economical manner. Intermediate load facilities operate seasonally and in a cycling fashion, and typically have a higher operating cost than baseload facilities. Natural gas-fired combined-cycle generating facilities have become a predominant supplier of intermediate energy needs. Wind, hydropower, gas steam boilers, and smaller coal-fired plants also can serve intermediate energy needs. Peaking load facilities operate only during peak demand periods and during emergencies because of their higher operating costs relative to baseload and intermediate load facilities. Peaking facilities include quick-start natural gas and oil-fired combustion turbines, diesel generators, natural gas and oil-fired steam boilers, and hydropower.

The Energy Information Administration (EIA) forecasts that coal-fired plants will make up most of the capacity additions during the forecast period. Specifically, in the western United States, the EIA states that the choice to build mostly coal-fired plants is based on the region's lower-than-average coal prices and higher-than-average natural gas prices (EIA, 2007). The Western Electricity Coordinating

Council forecasts that "reported generating capacity additions in the region may not be sufficient to reliably supply the forecast firm peak demand and energy requirements throughout the [2005-2014] period" (Western Electricity Coordinating Council, 2005). The electric power forecasts by the EIA and Western Electricity Coordinating Council assume that a reasonable amount of achievable conservation/energy efficiency programs will occur and have factored them into projected power demands.

The EIA forecasts energy needs through 2030 based on cumulative additions to generation. The EIA's 2007 report forecast the need for approximately 20,500 MW of new power generation in the western United States by 2015 (72,500 MW by 2030) to meet growing energy needs and maintain reliable operation of the electric system. The EIA also estimates that new coal-fired generation facilities will supply 7,600 MW by 2015 (51,000 MW by 2030) of this need for new generation capacity. The report indicates that in the West the proportion coal generation contributes to total electric generation will increase from 23.2 percent in 2007 to 35.6 percent in 2015 and 59.0 percent in 2030.

The Public Utility Commission of Nevada has reported a projected capacity shortfall of 4,000 MW by 2020 in Nevada if new generation capacity is not added (Public Utility Commission of Nevada, 2007). Also, in Nevada, Nevada Power Company (2006) and Sierra Pacific Power Company (2006) have identified the need for approximately 5,500 MW of additional electric capacity beyond their existing generation capacity and secured purchases by 2015. The White Pine Energy Station would help fill part of the identified need for electricity by providing approximately

1,590 MW of new baseload coal-fired electric generation capacity.

Elsewhere in the West, future load growth is expected, even when conservation and energy efficiency programs are considered. For example, Tri-State Generation and Transmission Association, Inc. (Tri-State), which serves customers in New Mexico, Colorado, and Wyoming, has stated a need for additional baseload generating capacity in both the near-term and long-term. This need for additional capacity is in addition to the current and anticipated future energy conservation and efficiency programs sponsored by the company. Tri-State plans to pursue 700 MW of coal-fired baseload capacity to satisfy its near-term need for new generation (Tri-State Generation and Transmission Association, 2007). Also, PacifiCorp has stated a need for additional baseload generating capacity, particularly in its eastern system, which includes Idaho, Utah, and Wyoming. PacifiCorp reiterated its desire to add approximately 1,700 MW of baseload and intermediate load resources to its eastern system by 2016. This additional capacity would help offset projected deficiencies of 800 MW by 2010 and 3,000 MW by 2016 in the PacifiCorp system (PacifiCorp, 2007). Finally, in Arizona, the need for baseload power grows by approximately 100 MW annually (Arizona Public Service Co., 2006), despite multiple conservation and energy efficiency programs sponsored by the company.

Completion of the White Pine Energy Station also would help meet stated objectives of the Nevada State Office of Energy and Nevada electric utilities to increase fuel diversity in the State of Nevada. The addition of stable-priced, low-cost, coal-fired capacity would reduce the risk of reliance on volatile and more

expensive natural gas-fired generation and the impacts of droughts on hydropower.

WPEA's proposal to locate the Station in Steptoe Valley approximately 34 miles (proposed site) or 22 miles (alternative site) north of Ely is based on the following factors:

- The proposed site is near the NNR, which would be used to supply coal to the power plant that is needed in order to generate electricity.
- The proposed site is near a utility corridor that is permitted for a new 500,000-volt electric transmission line that would extend from Idaho to Clark County, Nevada. Access to this utility corridor provides a route to existing electric transmission facilities in White Pine County, specifically 345,000-volt and 230,000-volt transmission lines near Robinson Summit, and provides access to planned regional electric transmission facilities.
- The site is centrally located to the ground water source that would be used to supply the White Pine Energy Station's water needs. A reliable and economical water supply is central to a low-cost baseload, steam power plant and is available in the form of water rights held by White Pine County.
- The proposed site can be easily accessed via U.S. Highway 93 (U.S. 93) and is within a short driving distance to the population centers of Ely and McGill.
- The availability of a water supply was among the key factors in WPEA's decision to undertake the proposed project and to site it at the proposed location in White Pine County.

Siting the Station in White Pine County, Nevada, would meet long-held county objectives of attracting a coal-fired electric

generation facility to bring needed and desired economic benefits to the county, strengthening and stabilizing the county economy, and, therefore, improving the quality of life for county citizens.

White Pine County's active efforts to attract and participate in such a facility led to a 2004 agreement with WPEA which centered on WPEA's use of the county's water rights in the development of an electric generation plant in White Pine County, and related facilities including electric transmission and railroad facilities (see Appendix A). In 1983, to facilitate development of a planned coal fired power plant, the county secured 25,000 acre-feet of water rights for power generation purposes. Plans for that plant were eventually cancelled, but the county has since been maintaining these water rights with regular filings with the State Engineer of Nevada. If these rights are not put to beneficial use, White Pine County is at risk of having the rights withdrawn by the State Engineer. In February 2004, White Pine County entered into a Water supply Agreement granting WPEA the exclusive right to use these water rights for development and operation of the White Pine Energy Station. This agreement was updated in February 2008 (see Appendix B). The Station would use up to 5,000 acre-feet of water per year. The Proposed Action and the other action alternative (Alternative 1) would put a significant portion of the county's water rights to use, as envisioned under the Development Agreement.

The NNR, which is owned by the City of Ely, is deteriorated and is incapable of carrying commercial freight. The proposed Action and the other Action Alternative (Alternative 1) would help generate additional support for reactivating and upgrading the NNR, as envisioned in the Development Agreement. Upgrading the rail line would permit use of the NNR for

commercial freight service and allow for the expansion of tourist operations on the NNR north to Shafter. The importance of the railroad to the area's economic development is reflected in federal legislation enacted in 2006 which conveyed the land in the rail corridor from BLM to the City.

In a July 11, 2007, letter to the BLM confirming White Pine County's interest in and need for the project, the county states, "[t]he development of water resources for power generation in Steptoe Valley and the ability to reinstate rail freight service on Class III track are basic to White Pine County's long-term goals of strengthening and stabilizing the area's economy and improving the quality of life for all White Pine County residents."

White Pine County is approximately 93 percent public land and its economy has historically relied on the boom-bust cycles of the mining industry. This has resulted in significant fluctuations in population, employment, tax base, and revenues. Specifically, with the closing of the Robinson Copper Mine in 1999, White Pine County has seen its population decrease from 10,134 in 1996 to 8,842 in 2003 (Nevada State Demographer's Office, 2006b) and its labor force decrease from 4,337 in 1995 to 3,694 in 2003 (Nevada Department of Employment, Training & Rehabilitation, 2006). Likewise, White Pine County has seen the assessed valuation of its tax base decrease from \$173,614,000 in 1999 to 2000 to \$126,300,000 in 2003-2004. The county's median household income of \$36,622 in 2003 was the fourth lowest in Nevada and ranks below the state and national averages of \$45,249 and \$43,318, respectively. More recently, with the re-opening of the Robinson Copper Mine in 2004, the population has increased to 9,275 in 2005 and the labor force has increased to 4,300 in 2005. The construction and

operation of the White Pine Energy Station would provide a steady, long-term positive effect on employment opportunities, tax revenues, household incomes, and sales of local goods and services in the county.

1.3 Project Location

The White Pine Energy Station site is located in White Pine County in eastern Nevada primarily on public lands managed by the Ely Field Office of the BLM (see Figure 1-1). The power plant site for the Proposed Action is in the Steptoe Valley Hydrographic Basin, approximately 34 miles north of Ely, 22 miles north of McGill, and 1 mile west of U.S. 93. The Steptoe Valley is bordered on the east by the Schell Creek Range and on the west by the Egan Range (approximately 8 miles and 5 miles from the Proposed Action power plant site, respectively). The Utah border is approximately 43 miles east and the northern boundary of Great Basin National Park approximately 57 miles southeast of the Proposed Action power plant site. An alternative power plant site (Alternative 1), also in Steptoe Valley, is approximately 12 miles south of the Proposed Action power plant site and 1 mile west of U.S. 93.

1.4 Policies, Plans, and Programs

1.4.1 Relationships to BLM Policies, Plans, and Programs

The BLM is responsible for managing the lands requested for use by WPEA for the White Pine Energy Station. WPEA's proposed use of public land for the Station conforms to BLM's land management policies under the Egan Resource Management Plan involving the granting of ROWs (see discussion in Section 2.2.1.1, *Granting of ROWs*) and the disposal and sale of public lands, including the sale of public lands under the FLPMA (see

discussion in Section 2.2.1.4, *Sale of Power Plant ROW*). The Ely Field Office has prepared the Proposed Ely District Resource Management Plan/Final Environmental Impact Statement (BLM, 2007), which will consolidate and update management direction for all BLM-managed lands in the Ely District and replace three separate planning documents (the Egan Resource Management Plan and the Schell and Caliente Management Framework Plans) that have guided management of public lands in the Ely District for over 15 years. WPEA's proposed Station would also conform to the Proposed Ely District Resource Management Plan.

The BLM must review WPEA's development plans to ensure that adequate provisions are included to: (1) prevent unnecessary degradation of public lands and their resources; (2) ensure reclamation of disturbed areas; and (3) ensure compliance with applicable state and federal laws.

1.4.2 Relationships to Non-BLM Policies, Plans, and Programs

The Proposed Action and the other action alternative (Alternative 1) being evaluated in this document are consistent with approved resource-related policies and programs of other federal agencies, Indian Tribes, local governments, and the State of Nevada.

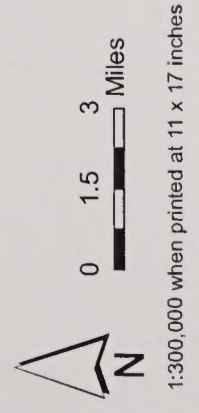
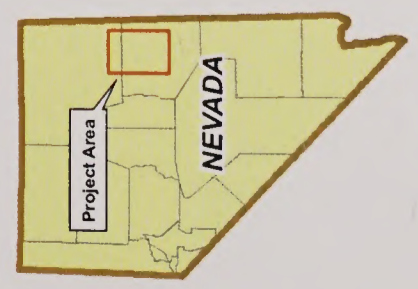
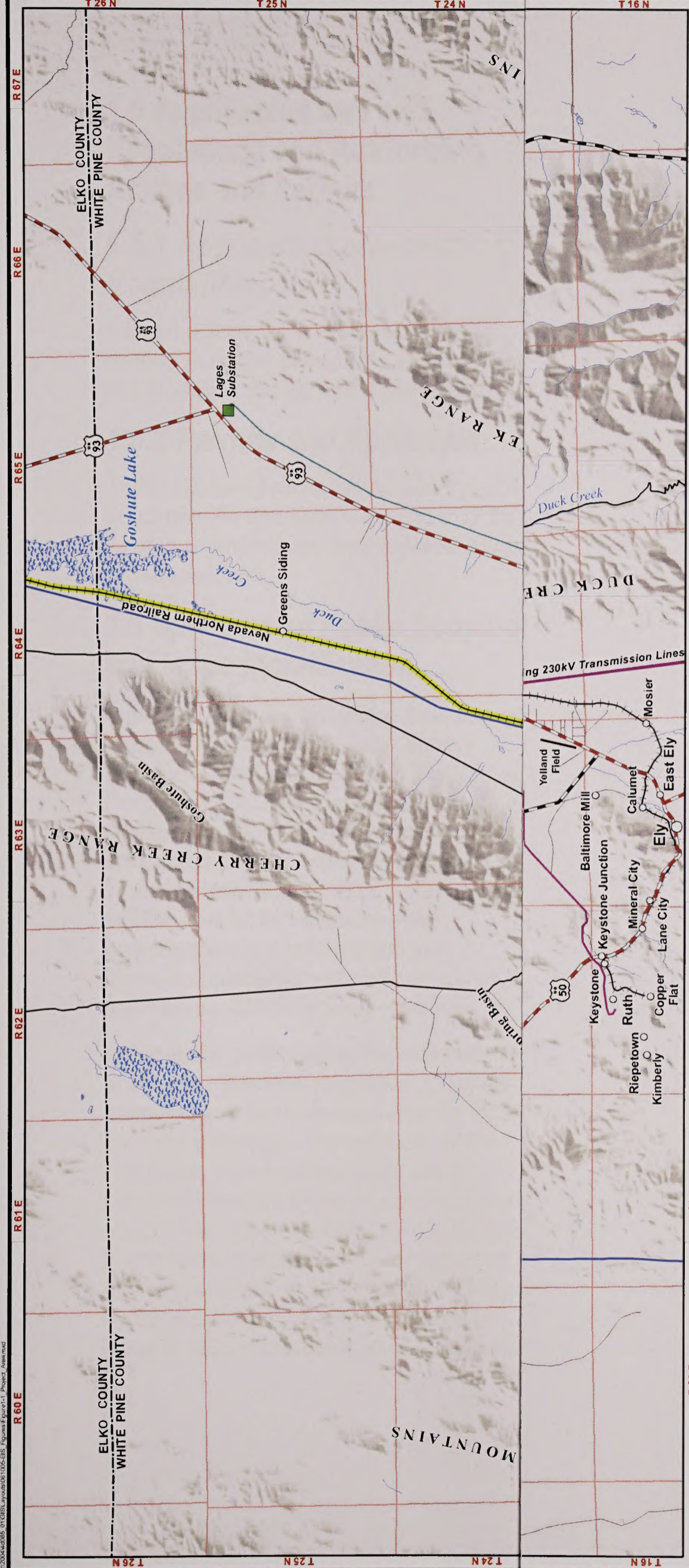

Existing Electrical Features

- Existing Substation
- Existing Transmission Line
- Existing Distribution Line

Surface Water

- Perennial Stream or River
- Wetland

Connected Action

- SWIP Transmission Line
- NNR Upgrade

Common Project Features

- Minerals Materials Sale Area
- Moriah Ranches
- Seeding Project

Proposed Action Project Features

- Proposed Well Site
- - - Proposed Water Pipeline/
Distribution Line
- + + + Proposed Rail Spur
- - - Proposed Transmission Line
- - - Proposed Electric Distribution Line
- Proposed Access Road
- Proposed Substation Site
- Proposed Power Plant Site

Alternative 1 Project Features

- Proposed Well Site
- - - Proposed Water Pipeline/
Distribution Line
- + + + Proposed Rail Spur
- - - Proposed Transmission Line
- - - Proposed Electric Distribution Line
- Proposed Access Road
- Proposed Substation Site
- Proposed Power Plant Site

**Project Area
White Pine Energy Station Project**

Figure 1-1

P:\2004\4085_01\GIS\Layouts\061005-ERS_Figures\Figure1-1_Project_Area.mxd

operation of the White Pine Energy Station would provide a steady, long-term positive effect on employment opportunities, tax revenues, household incomes, and sales of local goods and services in the county.

1.3 Project Location

The White Pine Energy Station site is located in White Pine County in eastern Nevada primarily on public lands managed by the Ely Field Office of the BLM (see Figure 1-1). The power plant site for the Proposed Action is in the Steptoe Valley Hydrographic Basin, approximately 34 miles north of Ely, 22 miles north of McGill, and 1 mile west of U.S. 93. The Steptoe Valley is bordered on the east by the Schell Creek Range and on the west by the Egan Range (approximately 8 miles and 5 miles from the Proposed Action power plant site, respectively). The Utah border is approximately 43 miles east and the northern boundary of Great Basin National Park approximately 57 miles southeast of the Proposed Action power plant site. An alternative power plant site (Alternative 1), also in Steptoe Valley, is approximately 12 miles south of the Proposed Action power plant site and 1 mile west of U.S. 93.

1.4 Policies, Plans, and Programs

1.4.1 Relationships to BLM Policies, Plans, and Programs

The BLM is responsible for managing the lands requested for use by WPEA for the White Pine Energy Station. WPEA's proposed use of public land for the Station conforms to BLM's land management policies under the Egan Resource Management Plan involving the granting of ROWs (see discussion in Section 2.2.1.1, *Granting of ROWs*) and the disposal and sale of public lands, including the sale of public lands under the FLPMA (see

discussion in Section 2.2.1.4, *Sale of Power Plant ROW*). The Ely Field Office has prepared the Proposed Ely District Resource Management Plan/Final Environmental Impact Statement (BLM, 2007), which will consolidate and update management direction for all BLM-managed lands in the Ely District and replace three separate planning documents (the Egan Resource Management Plan and the Schell and Caliente Management Framework Plans) that have guided management of public lands in the Ely District for over 15 years. WPEA's proposed Station would also conform to the Proposed Ely District Resource Management Plan.

The BLM must review WPEA's development plans to ensure that adequate provisions are included to: (1) prevent unnecessary degradation of public lands and their resources; (2) ensure reclamation of disturbed areas; and (3) ensure compliance with applicable state and federal laws.

1.4.2 Relationships to Non-BLM Policies, Plans, and Programs

The Proposed Action and the other action alternative (Alternative 1) being evaluated in this document are consistent with approved resource-related policies and programs of other federal agencies, Indian Tribes, local governments, and the State of Nevada.

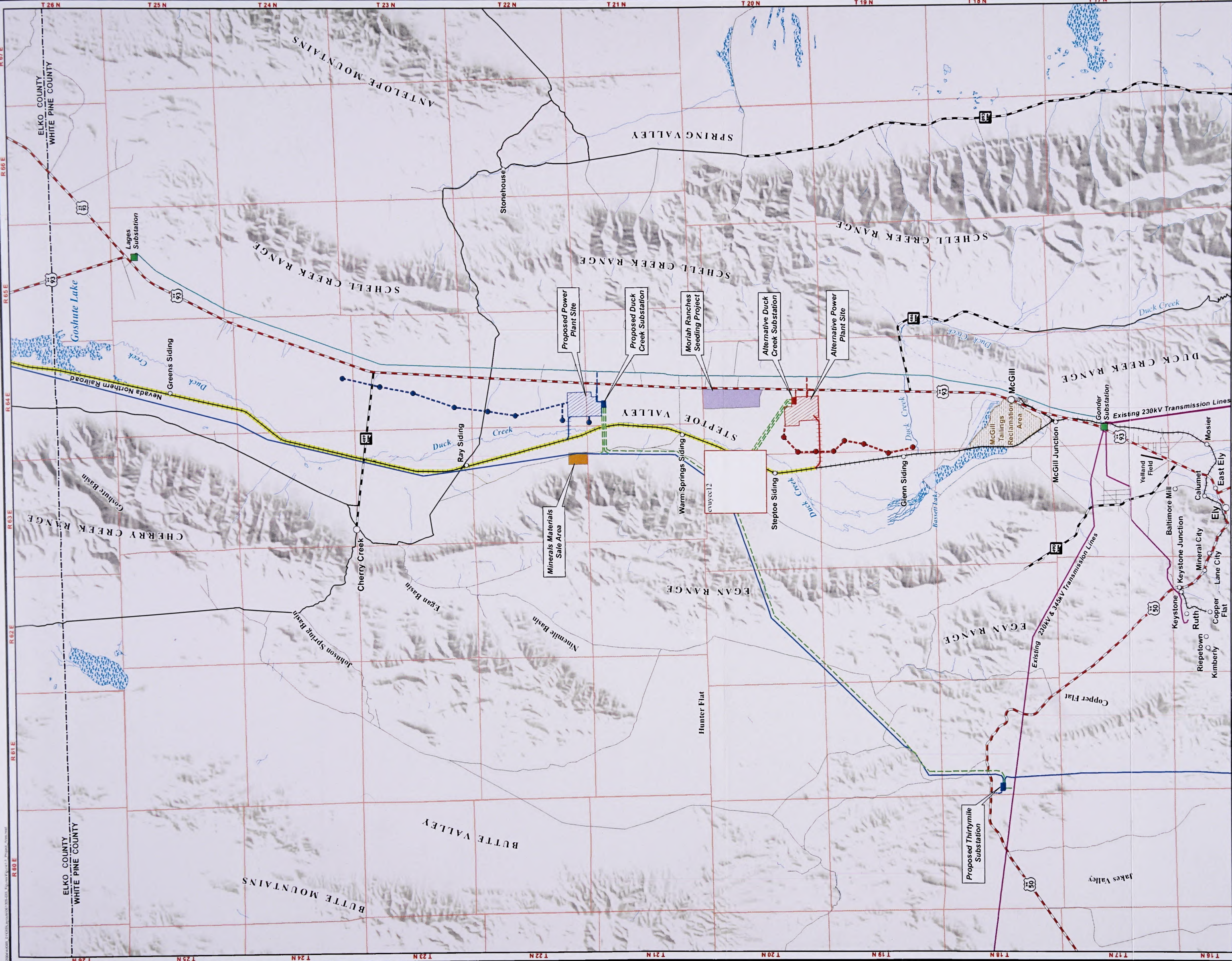

Project Area White Pine Energy Station Project

Existing Electrical Features

- Existing Substation
- Existing Transmission Line
- Existing Distribution Line

Surface Water

- Perennial Stream or River
- Wetland

Connected Action

- SWIP Transmission Line
- NNR Upgrade

Common Project Features

- Minerals Materials Sale Area
- Moriah Ranches
- Seeding Project

Proposed Action Project Features

- Proposed Well Site
- - - Proposed Water Pipeline/
Distribution Line
- + + + Proposed Rail Spur
- - - Proposed Transmission Line
- - - Proposed Electric Distribution Line
- Proposed Access Road
- Proposed Substation Site
- Proposed Power Plant Site

Alternative 1 Project Features

- Proposed Well Site
- - - Proposed Water Pipeline/
Distribution Line
- + + + Proposed Rail Spur
- - - Proposed Transmission Line
- - - Proposed Electric Distribution Line
- Proposed Access Road
- Proposed Substation Site
- Proposed Power Plant Site

NEVADA

Project Area

0 1.5 3 Miles

1:300,000 when printed at 11 x 17 inches

N

Figure 1-1

1.5 Applicable Laws and Regulations and Authorizing Actions and Permits

1.5.1 Applicable Laws and Regulations

Table 1-1 lists laws, regulations, and executive orders potentially applicable to the Proposed Action and Alternative 1.

1.5.2 Permits and Approvals

Table 1-2 lists federal, state, county, and other permits and approvals that may be needed to implement the Proposed Action or Alternative 1.

1.6 Summary of Public Scoping and Issue Identification

Public scoping for the *White Pine Energy Station Draft Environmental Impact Statement* (DEIS) occurred in Ely, Nevada on August 23, 2004, and Reno Nevada on August 24, 2004. Forty-two individuals attended the Ely meeting and 11 individuals attended the Reno meeting. WPEA and BLM representatives presented project information and discussed concerns with individuals in an open-house format at both meetings.

Individuals, public agencies, and non-profit organizations submitted 35 letters containing written comments to the BLM after the meetings. The majority of the comments expressed concern about potential impacts of the power plant to air quality and water development in the area. Numbers of comments (from highest to lowest) provided in each resource category by the public follow, and were used to identify issues addressed in the DEIS and

this Final Environmental Impact Statement (FEIS):

- Air quality: 44 comments
- Water development, use, and ground water impacts: 41 comments
- Wildlife, habitat, and ecological concerns: 33 comments
- Transmission: 15 comments
- Socioeconomics: 13 comments
- Visual resources: 13 comments
- Transportation, roads, and railroad: 12 comments
- Power need and recipients: 10 comments
- Proposed site and alternatives: 10 comments
- Waste and hazardous materials: 9 comments
- Energy efficiency, conservation, and alternative energy: 7 comments
- Power plant technology: 6 comments
- Noise: 6 comments
- Recreation: 2 comments
- Other: 10 comments

Public scoping and issue identification are discussed further in Chapter 5, *Consultation and Coordination*. Chapter 5 also discusses public meetings held and comments received on the DEIS that are addressed in this FEIS.

TABLE 1-1

Laws, Regulations, and Executive Orders That May Apply to the Proposed Action and Alternative 1 of the White Pine Energy Station

National Environmental Policy Act (NEPA) 42 USC 4321 et seq.
Council on Environmental Quality general regulations implementing NEPA (40 CFR Parts 1500-1508)
Department of the Interior's implementing procedures and proposed revisions (August 28, 2000, Federal Register)
National Historic Preservation Act and regulations implementing NHPA 16 USC 470 et seq.
Antiquities Act of 1906 16 USC 431 et seq.
Archaeological Resources Protection Act, as amended 16 USC 470aa et seq.
Native American Graves Protection and Repatriation Act of 1990
Clean Air Act 42 USC 7401 et seq.
Clean Water Act 33 USC 1251 et seq.
Disposition: Sales—43 CFR 2700
Endangered Species Act (ESA) 16 USC 1531 et seq.
Nevada Division of Forestry Critically Endangered Flora Law (NRS 5.27-5.33)
Noise Control Act of 1972, as amended 42 USC 4901 et seq.
Occupational Safety and Health Act 29 USC 651 et seq. (1970)
Mineral Leasing Act
Pollution Prevention Act of 1990 42 USC 13101 et seq.
Safe Drinking Water Act 42 USC s/s 300f et seq. (1974)
Migratory Bird Treaty Act (Migratory Bird Guidance) 16 USC 703–711 Executive Order January 1, 2001
NEPA, Protection and Enhancement of Environmental Quality Executive Order 11512
National Historic Preservation Executive Order 11593
Floodplain Management Executive Order 11988
Protection of Wetlands Executive Order 11990
Federal Compliance with Pollution Control Standards Executive Order 12088
Environmental Justice Executive Order 12898
Indian Sacred Sites Executive Order 13007
American Indian Religious Freedom Act of 1978 (42 USC 1996)
Memorandum on Government-to-Government Relations with Native American Tribal Governments of 1994
Indian Self-Determination and Educational Assistance Act of 1975, Title I
<http://www4.law.cornell.edu/uscode/25/450.html>
Indian Self-Determination and Educational Assistance Act of 1994, Title IV
Departmental Responsibilities for Indian Trust Resources, 512 DM 2.1
Sacred Sites, 512 DM 3
Consultation and Coordination with Indian Tribal Governments Executive Order 13175
Invasive Species Executive Order 13112
Responsibilities, and the Endangered Species Act, Secretarial Order 3206 (June 5, 1997)
Federal Land Policy and Management Act of 1976 (FLPMA) 43 USC 1701 et seq.
BLM right-of-way regulations 43 CFR 2800

TABLE 1-2

Federal, State, and County Permits and Approvals That May be Needed to Implement the Proposed Action or Alternative 1 of the White Pine Energy Station

Federal Permits and Approvals

Bureau of Land Management NEPA Record of Decision for Proposed Action

Bureau of Land Management Rights-of-Way for electric power generating plant, electric transmission lines and substations, wellfield and water pipeline, electric distribution line, access roads, railroad spur, and other ancillary approvals

U.S. Fish and Wildlife Service, Endangered Species Act Section 7 Consultation and Biological Opinion

Acid Rain (Title IV CAA) Permit

U.S. Environmental Protection Agency, Region IX, Title V (CAA) Operating Permit

U.S. Environmental Protection Agency, Section 402 National Pollutant Discharge Elimination System Notification for Stormwater Management during Construction

U.S. Environmental Protection Agency, Section 402 National Pollutant Discharge Elimination System Notification for Stormwater Management during Operation

U.S. Army Corps of Engineers, Section 404 Excavation or Discharge of Fill Material into Waters of the U.S., Including Wetlands

State of Nevada Permits and Approvals

Nevada State Historic Preservation Office (SHPO), Section 106 review and concurrence, per National Historic Preservation Act for BLM lands, per protocol between BLM and Nevada SHPO

Nevada Department of Wildlife Project Review: Wildlife and Habitat Consultation for Disturbance on BLM land

Temporary Discharge Permit—Nevada Division of Environmental Protection, Bureau of Water Pollution Control

Nevada Public Utilities Commission Utility Environmental Protection Act Permit

Nevada Division of Environmental Protection, Section 401 Water Quality Certification

Water Right Permit-State Engineer—Nevada Department of Water Resources

Prevention of Significant Deterioration Program Major Source Permit—Nevada Department of Environmental Quality

Dust Control Permit—Nevada Department of Environmental Quality

Ground Water Discharge Permit—Nevada Division of Environmental Protection, Bureau of Water Pollution Control

Industrial Artificial Pond Permit—Nevada Department of Wildlife

Nevada Department of Transportation Encroachment Permit

White Pine County Permits and Approvals

White Pine County Master Plan Amendment, Zone Change, and Special Use Permit

Grading permits

1.7 Actions Considered for Cumulative Analysis

Council on Environmental Quality guidelines for the preparation of EISs require that cumulative impacts be addressed in addition to direct and indirect impacts. Cumulative impacts are those incremental impacts that would result from the effects of the Proposed Action or Alternative 1 when added to the effects of other past, present, and reasonably foreseeable future actions. The BLM recognizes the need for a thorough analysis of potential cumulative effects, not only from power plant siting activities, but from other development activities and actions as well.

This section identifies 11 large actions whose cumulative impacts may extend across a broad range of the resource categories being assessed in this document (see Figure 1-2). Each action has been evaluated to determine if it is sufficiently defined (reasonably foreseeable) to be: (1) relevant to potential impacts; (2) within the project area of influence; and (3) of a magnitude that could potentially result in a cumulative impact. Descriptions and cumulative effects, if any, of the actions listed below are presented in Section 4.19, *Cumulative Impacts*, of Chapter 4, *Environmental Consequences*, together with any other actions not listed here whose effects would be very resource-specific. The 11 large actions considered in the cumulative impacts analysis are the following:

- Southwest Intertie Project (also a connected action as described in Section 2.2.3.7, *Connected Actions*)
- Nevada Northern Railway Upgrade (also a connected action)

- Nevada Northern Railway Operation (also a connected action)
- White Pine County Airport (Yelland Field) Expansion
- Basset Lake Expansion
- Egan Range Wind Generating Project
- Intermountain Power Project (Units 1, 2, and 3) (coal-fired power plant)
- Newmont Gold (coal-fired power plant)
- Clark, Lincoln, and White Pine Counties Groundwater Development Project (Southern Nevada Water Authority Project)
- Toquop Energy Project (coal-fired power plant)
- Ely Energy Center (coal-fired power plant)

In addition, Section 4.19.3 includes a discussion of global climate change with a focus on the cumulative nature of that phenomenon and the incremental contribution of greenhouse gases that would occur from operation of the White Pine Energy Station.

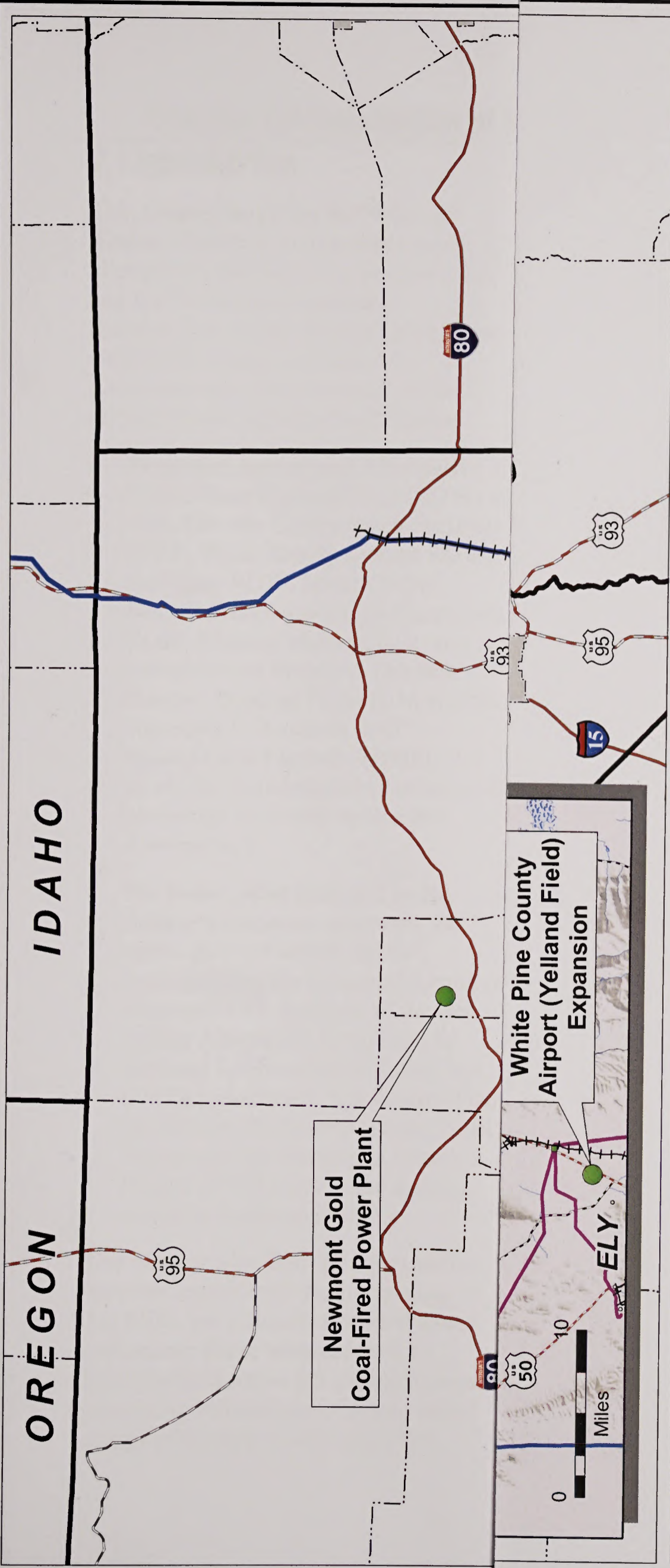

Projects Considered for Cumulative Analysis White Pine Energy Station Project

- Non-linear Cumulative Analysis Projects
- Existing Features**
- Existing Transmission Line
 - +— Nevada Northern Railway
- Project Features**
- ▨ Proposed Power Plant Site
 - ▨ Alternative Power Plant Site
- Proposed Features**
- Southwest Intertie Transmission Line
 - Clark, Lincoln, and White Pine Counties
 - Groundwater Development (GWD) Project

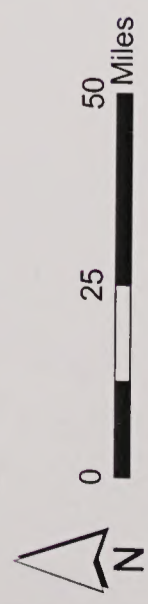

1:1,053,022 when printed at 22 x 34 inches

Figure 1-2

1.7 Actions Considered for Cumulative Analysis

Council on Environmental Quality guidelines for the preparation of EISs require that cumulative impacts be addressed in addition to direct and indirect impacts. Cumulative impacts are those incremental impacts that would result from the effects of the Proposed Action or Alternative 1 when added to the effects of other past, present, and reasonably foreseeable future actions. The BLM recognizes the need for a thorough analysis of potential cumulative effects, not only from power plant siting activities, but from other development activities and actions as well.

This section identifies 11 large actions whose cumulative impacts may extend across a broad range of the resource categories being assessed in this document (see Figure 1-2). Each action has been evaluated to determine if it is sufficiently defined (reasonably foreseeable) to be: (1) relevant to potential impacts; (2) within the project area of influence; and (3) of a magnitude that could potentially result in a cumulative impact. Descriptions and cumulative effects, if any, of the actions listed below are presented in Section 4.19, *Cumulative Impacts*, of Chapter 4, *Environmental Consequences*, together with any other actions not listed here whose effects would be very resource-specific. The 11 large actions considered in the cumulative impacts analysis are the following:

- Southwest Intertie Project (also a connected action as described in Section 2.2.3.7, *Connected Actions*)
- Nevada Northern Railway Upgrade (also a connected action)

- Nevada Northern Railway Operation (also a connected action)
- White Pine County Airport (Yelland Field) Expansion
- Basset Lake Expansion
- Egan Range Wind Generating Project
- Intermountain Power Project (Units 1, 2, and 3) (coal-fired power plant)
- Newmont Gold (coal-fired power plant)
- Clark, Lincoln, and White Pine Counties Groundwater Development Project (Southern Nevada Water Authority Project)
- Toquop Energy Project (coal-fired power plant)
- Ely Energy Center (coal-fired power plant)

In addition, Section 4.19.3 includes a discussion of global climate change with a focus on the cumulative nature of that phenomenon and the incremental contribution of greenhouse gases that would occur from operation of the White Pine Energy Station.

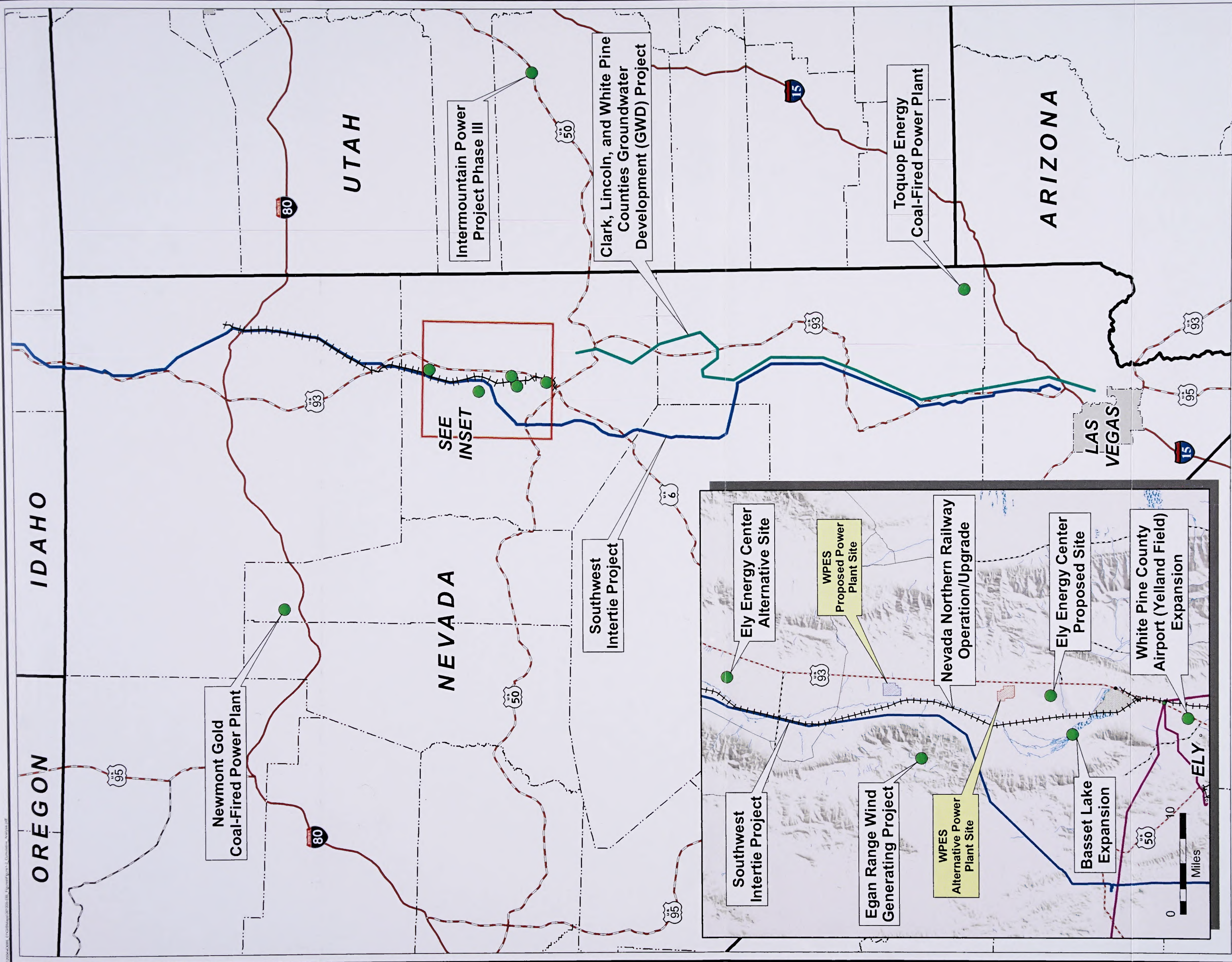

**Projects Considered for Cumulative Analysis
White Pine Energy Station Project**

- Non-linear Cumulative Analysis Projects
- Existing Features**
 - Existing Transmission Line
 - Nevada Northern Railway
- Project Features**
 - ▨ Proposed Power Plant Site
 - ▨ Alternative Power Plant Site
- Proposed Features**
 - Southwest Intertie Transmission Line
 - Clark, Lincoln, and White Pine Counties Groundwater Development (GWD) Project

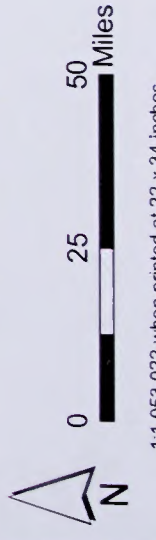

1:1,053,022 when printed at 22 x 34 inches

Figure 1-2

Handwritten notes in the top-left corner, possibly including a date or page number.

Handwritten notes in the top-middle section, appearing to be a list or series of entries.

Handwritten notes in the top-right section, possibly describing a process or method.

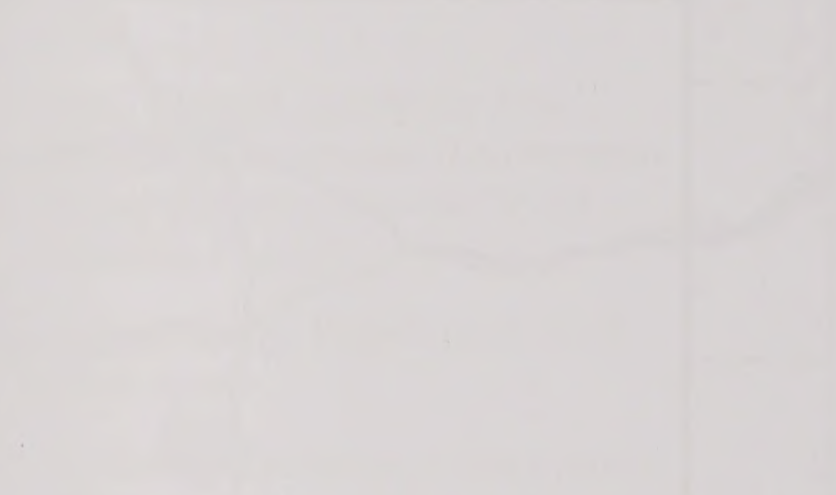

Large block of handwritten notes in the bottom-left section, containing several lines of text.

Large block of handwritten notes in the bottom-middle section, continuing the text from the left.

Vertical handwritten text in the bottom-right corner, possibly a signature or page reference.

Chapter 2.0 Description of Proposed Action and Alternatives

2.1 Introduction

This chapter describes the Proposed Action (Section 2.2), one other action alternative (Alternative 1, Section 2.3), and the No Action Alternative (Section 2.4) for the Station. Each action is analyzed in detail in Chapter 4, *Environmental Consequences*, of this document and includes the following:

- **Proposed Action and Alternative 1.** Power Plant Right-of-Way (ROW) and Sale, Electric Transmission Facilities ROW, Water Supply System ROW, Rail Spur ROW, Access ROW, Electric Distribution Line Construction ROW, Mineral Material Sale, and Enhancement Measures (Moriah Ranches Seeding Project). In addition, Appendix C describes Best Management Practices (BMPs) that would be implemented as an integral part of the Proposed Action and Alternative 1.
- **No Action Alternative.** The No Action Alternative represents the status quo (not approving or implementing the Proposed Action or Alternative 1). Analysis of the No Action Alternative is required by National Environmental Policy Act (NEPA) guidelines. It is assumed that the Nevada Northern Railway (NNR) Project and the Southwest Intertie Project (SWIP) connected actions would be implemented.

This chapter also describes alternatives that were considered during scoping of this FEIS, but eliminated from detailed evaluation. These alternatives are described in Section 2.5 and include power generating technologies, conservation/energy efficiency, power plant site

locations, air pollution control technologies, cooling technology, power plant site configuration, rail spur alignments, structure designs for rail-crossing of Duck Creek, well field electric distribution line alignments and design, and transmission line route.

The Proposed Action and Alternative 1 were developed for initial presentation at public scoping meetings in Ely, Nevada, on August 23, 2004, and Reno, Nevada, on August 24, 2004. Comments received during those meetings and during the public scoping comment period (August 6, 2004, to September 7, 2004) for the Station were considered in formulating the Proposed Action and Alternative 1 presented in this document. In addition, meetings were held with local and regional staff of the Bureau of Land Management (BLM) and technical staff of the project proponent (WPEA) to aid in further formulating the Proposed Action and Alternative 1.

As required for the granting of ROWs by the BLM, a Plan of Development would be finalized for the alternative selected for implementation. Prior to construction, a Construction, Operation, and Maintenance Plan would be prepared that details the methods and procedures to be used in the construction of the Station features. The Construction, Operation, and Maintenance Plan will incorporate site-specific stipulations, terms, and conditions in order to satisfy all ROW-related construction requirements, as well as operational, maintenance, and restoration requirements associated with lands administered by the Ely Field Office of the BLM where Station features would be located.

2.2 Proposed Action

2.2.1 Description of BLM Actions

2.2.1.1 Granting ROWs

BLM actions that would occur under the Proposed Action include granting ROWs necessary for construction and operation of the Station. The BLM is authorized to grant ROWs under Title V of the Federal Land Policy and Management Act (FLPMA) of 1976 (43 U.S.C. 1761-1771). Subsequent to the granting of ROWs, arrangements would be made for the sale of the power plant ROW to WPEA (see Section 2.2.1.4, *Sale of Power Plant ROW*). ROWs would be granted for the following activities:

- Construction and operation of the power plant including the power island; coal unloading, handling, and storage facilities; a solid waste disposal facility; an evaporation pond; an electric switchyard; and temporary construction worker housing (Power Plant ROW)
- Construction and operation of the water supply system to provide water for the power plant including ground water wells, underground water pipelines, electric distribution lines, communication lines, access roads, and ground water monitoring wells (Water Supply System ROW)
- Construction and operation of a rail spur from the existing Nevada Northern Railway (NNR) to the power plant for the supply of coal (Rail Spur ROW)
- Construction and operation of electric transmission facilities to interconnect the power plant with existing and planned transmission facilities including substations and transmission lines (Electric Transmission Facilities ROW)

- Construction and operation of road access and certain utility access to the power plant and other Station features (Access ROW)
- Construction and operation of certain components necessary during construction including a temporary electric distribution line (Electric Distribution Line Construction ROW) for the supply of power
- Long-term ROWs would be necessary for the operation and maintenance of all Station facilities located on BLM-managed public land. In addition, short-term ROWs would be required from the BLM to accommodate construction activities such as drilling, trenching, paving, and material/equipment staging

All ROWs would be granted to WPEA; however, after granting WPEA may request to assign interest to certain ROWs to other parties. Examples could include assigning ROW interest to a local communication company for communication lines to the Station, and assigning certain electrical facilities to local electric providers.

2.2.1.2 Mineral Material Sale

Authorize an offsite borrow area that would be constructed and operated by WPEA to supply earth and rock materials for project construction.

2.2.1.3 Moriah Ranches Seeding Project

Authorize a seeding project that would be implemented by WPEA to enhance grazing and wildlife value on 700 to 900 acres of public land in the Ely BLM District.

2.2.1.4 Sale of Power Plant ROW

Under BLM regulations and guidance, federal land identified for disposal in the

applicable BLM Resource Management Plan may be sold by competitive bid, modified competitive bid, or direct sale (for example, sold directly to a specified party without bidding). In all cases, the BLM must obtain not less than fair market value for land it sells. WPEA's proposed Station would be located within what is currently the Egan Resource Management Plan area, but which will soon become the Ely District Resource Management Plan area. The *Egan Resource Management Plan* (BLM, 1986a) identified 37,297 acres of public land remaining and available for disposal, including land in the area of the proposed power plant. The *Proposed Ely District Resource Management Plan* (BLM, 2007) states that public land in the Ely District may be disposed of under a variety of authorities administered by the BLM, including the Recreation and Public Purpose Act disposals, Desert Land Entry disposals, disposals under the Carey Act, Airport Conveyance disposals, Indian Allotment disposals, and land sales under the FLPMA. The Proposed Plan specifies that if rights-of-way are approved for power plants, BLM may dispose of up to 4,500 acres in White Pine County by direct sale. In addition, the White Pine County Conservation, Recreation, and Development Act of 2006 (Public Law 109-432), which was passed by Congress on December 20, 2006, allows the BLM to sell up to 45,000 acres consistent with its resource management plan.

Land disposal of the Power Plant ROW is consistent with the Egan Resource Management Plan and with the Proposed Ely District Resource Management Plan.

WPEA intends to operate an onsite non-hazardous, industrial solid waste disposal facility (primarily for disposal of coal combustion byproduct material such as fly

ash). BLM policy discourages such facilities on BLM-administered land.

If a Record of Decision is issued approving the Proposed Action or Alternative 1, the BLM would first grant the Power Plant ROW to WPEA to accommodate the Station's financing and construction schedule. The BLM would subsequently dispose of the land by sale where the power plant site ROW is authorized. Disposal by direct sale may be used when, in the opinion of the authorized official, a competitive sale is not appropriate and the public interest would be best served by a direct sale consistent with regulatory guidance (43 CFR 2711.3.3(a)(2) and (a)(3)). Timing of the land disposal action is at the discretion of the BLM and may be concluded prior to plant construction.

2.2.2 Description of Station Area

Figure 2-1 depicts the Power Plant ROW and locations of prominent Station features associated with the Proposed Action. The Power Plant ROW would be located entirely in White Pine County, Nevada, approximately 26 miles south of the White Pine County/Elko County line and approximately 40 miles west of the Nevada/Utah border. Prominent landmarks in the area of the Power Plant ROW include U.S. Highway 93 (U.S. 93) and the Schell Creek Range (in the Humboldt National Forest) to the east; Duck Creek and the Egan Range to the west; and Goshute Lake to the north. The communities of McGill and Ely are approximately 22 miles and 34 miles south of the Power Plant ROW, respectively, and Great Basin National Park is approximately 57 miles to the southeast.

The Station would primarily be located in the Steptoe Valley Hydrographic Basin. The electric transmission facilities would extend beyond the Steptoe Valley

Hydrographic Basin into the Butte Valley and Jakes Valley Hydrographic Basins. Duck Creek is the primary drainage in Steptoe Valley near the Power Plant ROW. The creek receives runoff from the western flank of the Schell Creek Range and the eastern flank of the Egan Range and flows north toward Goshute Lake.

Alternative power plant site locations were evaluated but, with the exception of Alternative 1, were rejected from detailed evaluation. The rationale for their rejection is described in Section 2.5.3.

2.2.3 Description of Project Features and Rights-of-Way

Project features and ROWs associated with the Proposed Action for the Station are described in the following text. ROWs that could be needed for the Station include the Power Plant ROW, Electric Transmission Facilities ROW, Water Supply System ROW, Rail Spur ROW, Access ROW, and Electric Distribution Line Construction ROW.

Table 2-1 summarizes the estimated acres that would be needed for each ROW and whether the ROWs would be short-term (ROW for construction only) or long-term (ROW for construction plus the life of the Station). Table 2-1 also summarizes the estimated acres of construction-related and permanent (during operations) land disturbances that would result from the construction and operation of the Station as well as acres of lands that would be reclaimed.

The Proposed Action would require approximately 2,475 acres of ROWs, including 2,414 acres of long-term ROWs and 61 acres of short-term, construction ROWs (Table 2-1). Subsequent to the granting of ROWs, arrangements would be made for the sale of the 1,281-acre Power

Plant ROW to WPEA. Sale of the Power Plant ROW would reduce the amount of long-term ROWs needed to 1,133 acres. Table 2-1 also shows estimated acres of temporary and permanent disturbed areas and acres reclaimed for the Proposed Action.

2.2.3.1 Power Plant ROW

The equipment and operations to be located on the Power Plant ROW would include the power island; coal unloading, handling, and storage facilities; a solid waste disposal facility for coal combustion byproducts; evaporation pond; construction worker housing; and, potentially, carbon capture equipment. Figure 2-2 shows the preliminary site plan for the Proposed Action Power Plant ROW. Figure 2-3 presents a conceptual rendering of the Station. Approximately 1,281 acres would be required for the Power Plant ROW (Table 2-1). The Power Plant ROW would be located within Sections 31 and 32, Township 22 North, Range 64 East and Sections 5 and 6, Township 21 North, Range 64 East of White Pine County.

Alternative types, locations, numbers, and/or sizes of power plant facilities or needs that were evaluated but rejected from detailed evaluation and the rationale for their rejection are described in Section 2.5. Alternative power generating technologies that were evaluated and the rationale for their rejection are described in Section 2.5.1. Alternatives to the generating units, cooling towers, evaporation pond, and total plant water usage described in the following text that were evaluated and the rationale for their rejection are described in Section 2.5.5 within the broader discussion of an alternative cooling technology that was evaluated. An alternative power plant site configuration that was evaluated but rejected from detailed evaluation and the rationale for its rejection are described in Section 2.5.6.

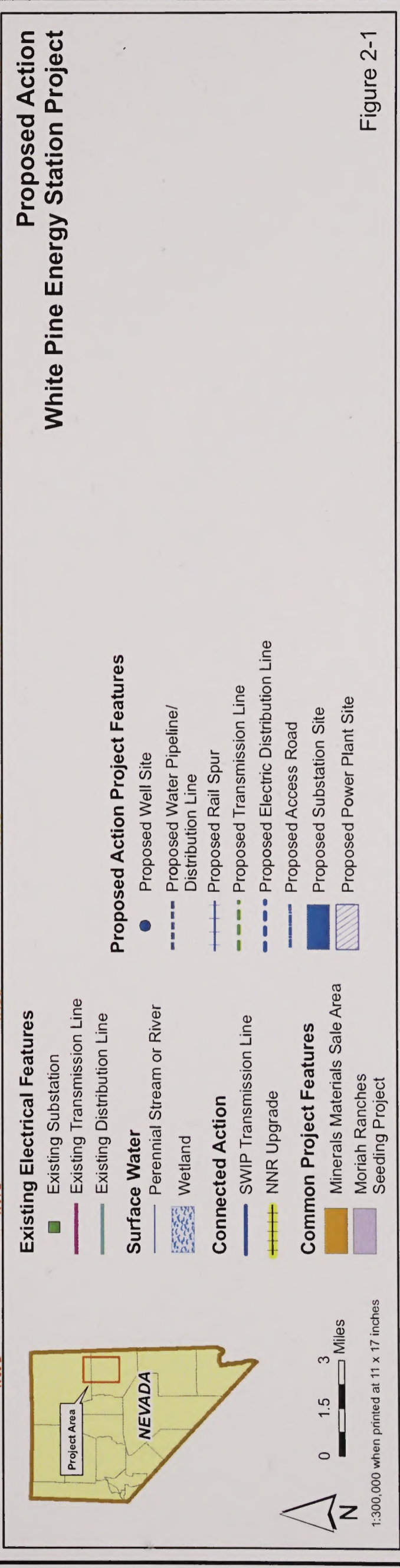
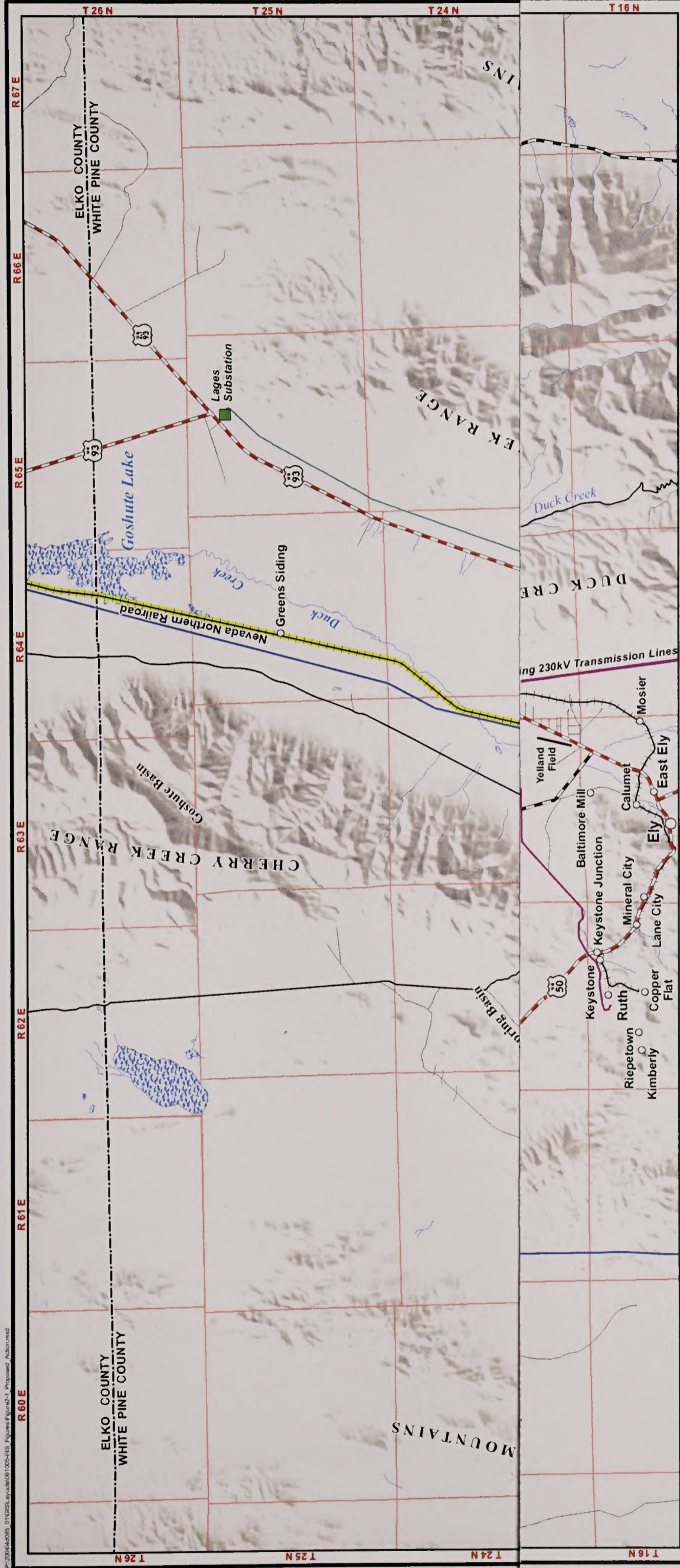

Hydrographic Basin into the Butte Valley and Jakes Valley Hydrographic Basins. Duck Creek is the primary drainage in Steptoe Valley near the Power Plant ROW. The creek receives runoff from the western flank of the Schell Creek Range and the eastern flank of the Egan Range and flows north toward Goshute Lake.

Alternative power plant site locations were evaluated but, with the exception of Alternative 1, were rejected from detailed evaluation. The rationale for their rejection is described in Section 2.5.3.

2.2.3 Description of Project Features and Rights-of-Way

Project features and ROWs associated with the Proposed Action for the Station are described in the following text. ROWs that could be needed for the Station include the Power Plant ROW, Electric Transmission Facilities ROW, Water Supply System ROW, Rail Spur ROW, Access ROW, and Electric Distribution Line Construction ROW.

Table 2-1 summarizes the estimated acres that would be needed for each ROW and whether the ROWs would be short-term (ROW for construction only) or long-term (ROW for construction plus the life of the Station). Table 2-1 also summarizes the estimated acres of construction-related and permanent (during operations) land disturbances that would result from the construction and operation of the Station as well as acres of lands that would be reclaimed.

The Proposed Action would require approximately 2,475 acres of ROWs, including 2,414 acres of long-term ROWs and 61 acres of short-term, construction ROWs (Table 2-1). Subsequent to the granting of ROWs, arrangements would be made for the sale of the 1,281-acre Power

Plant ROW to WPEA. Sale of the Power Plant ROW would reduce the amount of long-term ROWs needed to 1,133 acres. Table 2-1 also shows estimated acres of temporary and permanent disturbed areas and acres reclaimed for the Proposed Action.

2.2.3.1 Power Plant ROW

The equipment and operations to be located on the Power Plant ROW would include the power island; coal unloading, handling, and storage facilities; a solid waste disposal facility for coal combustion byproducts; evaporation pond; construction worker housing; and, potentially, carbon capture equipment. Figure 2-2 shows the preliminary site plan for the Proposed Action Power Plant ROW. Figure 2-3 presents a conceptual rendering of the Station. Approximately 1,281 acres would be required for the Power Plant ROW (Table 2-1). The Power Plant ROW would be located within Sections 31 and 32, Township 22 North, Range 64 East and Sections 5 and 6, Township 21 North, Range 64 East of White Pine County.

Alternative types, locations, numbers, and/or sizes of power plant facilities or needs that were evaluated but rejected from detailed evaluation and the rationale for their rejection are described in Section 2.5. Alternative power generating technologies that were evaluated and the rationale for their rejection are described in Section 2.5.1. Alternatives to the generating units, cooling towers, evaporation pond, and total plant water usage described in the following text that were evaluated and the rationale for their rejection are described in Section 2.5.5 within the broader discussion of an alternative cooling technology that was evaluated. An alternative power plant site configuration that was evaluated but rejected from detailed evaluation and the rationale for its rejection are described in Section 2.5.6.

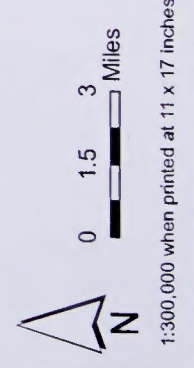
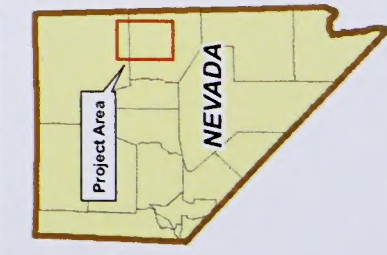

- Existing Electrical Features**
- Existing Substation
 - Existing Transmission Line
 - Existing Distribution Line
- Surface Water**
- Perennial Stream or River
 - Wetland
- Connected Action**
- SWIP Transmission Line
 - NNR Upgrade
- Common Project Features**
- Minerals Materials Sale Area
 - Moriah Ranches
 - Seeding Project

- Proposed Action Project Features**
- Proposed Well Site
 - Proposed Water Pipeline/Distribution Line
 - Proposed Rail Spur
 - Proposed Transmission Line
 - Proposed Electric Distribution Line
 - Proposed Access Road
 - Proposed Substation Site
 - Proposed Power Plant Site

**Proposed Action
White Pine Energy Station Project**

Figure 2-1



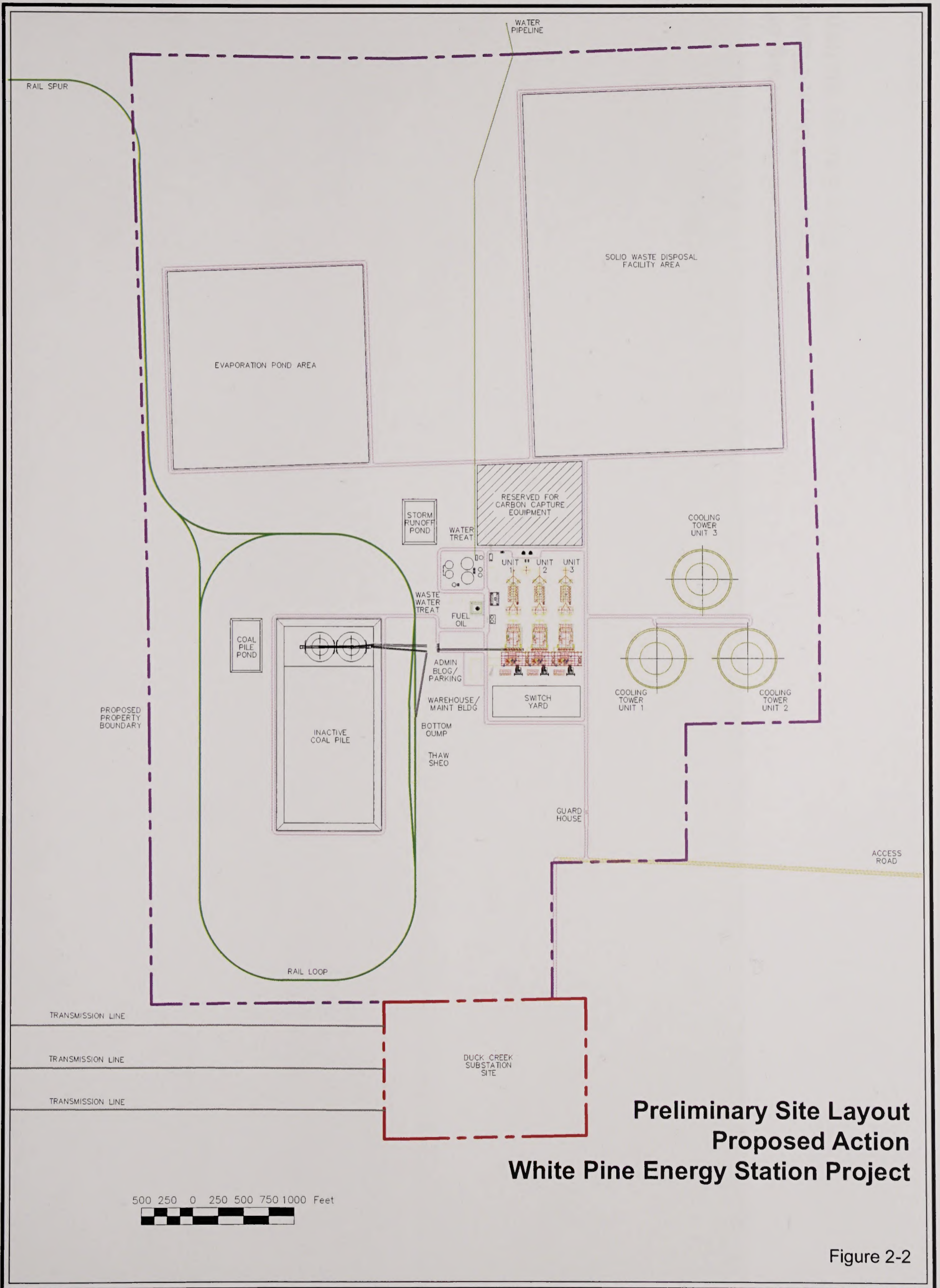

**Preliminary Site Layout
Proposed Action
White Pine Energy Station Project**

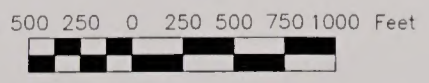
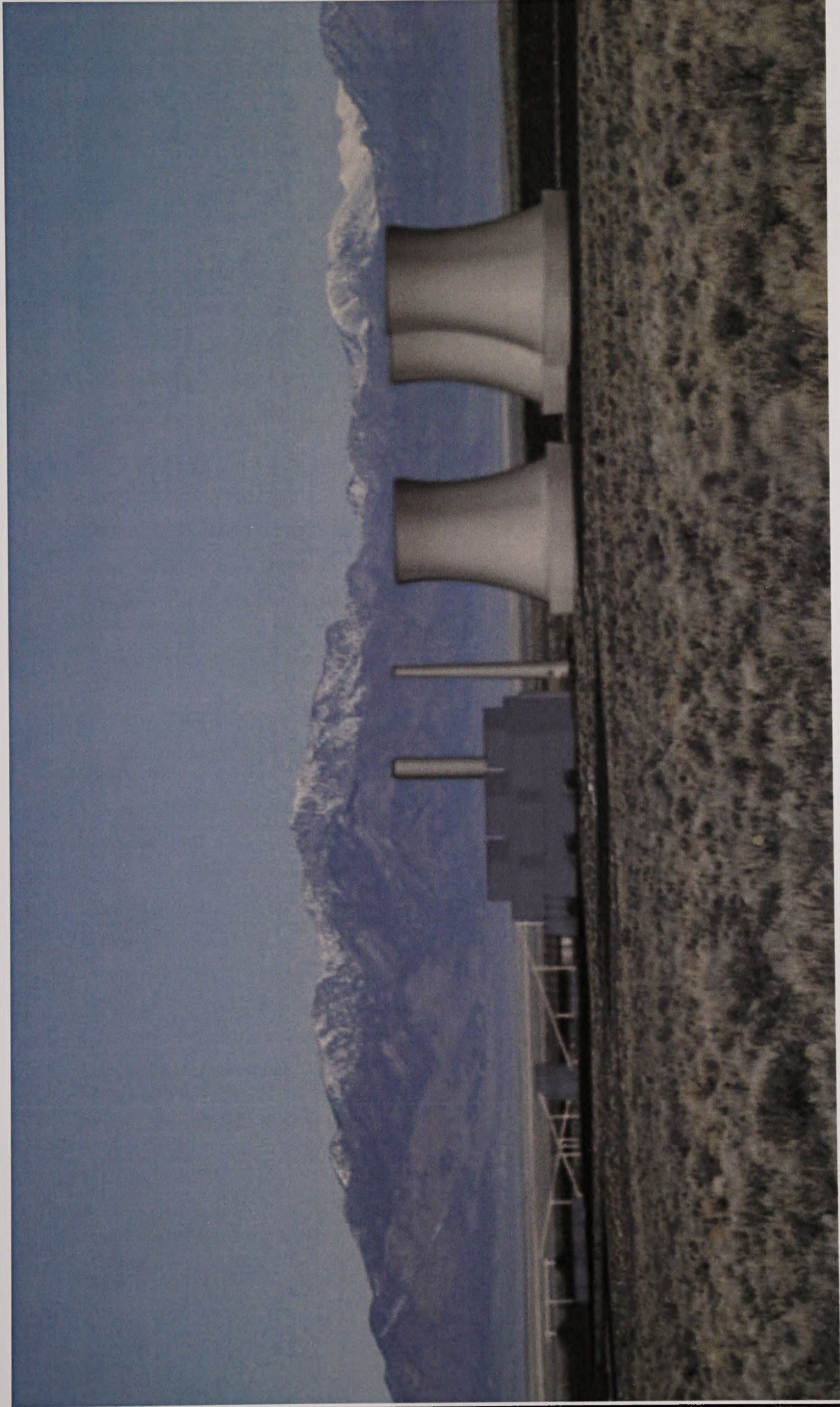

Figure 2-2



**Conceptual Rendering of
Proposed Power Plant
White Pine Energy Station**

Figure 2-3

TABLE 2-1

Estimated Acres of ROWs and Disturbed and Reclaimed Areas for the Proposed Action

	ROWs		Disturbed and Reclaimed Areas		
	Short-Term (acres) ^a	Long-Term (acres) ^b	Construction ^a (acres)	Reclaimed (acres)	Permanent ^c (acres)
Power Plant ROW/Power Plant Site	0	1,281 ^d	1,281	0	1,281
Electric Transmission Facilities ROW					
Duck Creek Substation ROW	0	60	60	0	60
Thirtymile Substation ROW	0	77	77	0	77
Duck Creek to Thirtymile 500-kV Line ROW	0	774	249	199	50
Falcon-Gonder 345-kV Interconnection ROW	0	9	8	7	1
SWIP 500 kV Interconnection ROW	0	122	40	34	6
Water Supply System ROW					
Linear Facilities ROW (30-foot-wide short-term)	48	0	48	48	0
Linear Facilities ROW (40-foot-wide long-term)	0	64	64	48	16
Ground Water Well ROW (8 wells)	0	4	4	3	1
Ground Water Monitoring Well ROW (10 wells)	0	5	5	4	1
Construction Staging Area ROW	2	0	2	2	0
Rail Spur ROW					
Short-Term ROW (30-foot-wide)	5	0	5	5	0
Long-Term ROW (35- to 70-foot-wide)	0	9	9	0	9
Access ROW					
Power Plant ROW Access	0	6	6	0	6
Duck Creek Substation ROW Access	0	1	1	0	1
Thirtymile Substation ROW Access	0	2	2	0	2
Electric Distribution Line Construction ROW	6	0	6	6	0
Mineral Material Sale (Offsite Borrow Area)	0	0	40	40	0
Total	61	2,414	1,907	396	1,511

^a Construction^b Construction plus life of Station^c Operations^d First a long-term ROW and then a sale

2.2.3.1.1 Power Island

The power island area would include the equipment and associated support facilities necessary to produce electricity. Major power island components are described below and depicted in Figures 2-4a, 2-4b, 2-4c, and 2-4d. Figure 2-4a shows a schematic of the proposed electric power production process in which water is heated in coal-fired boilers to produce steam and drive turbines and generate electricity. The rate of water use is described in Section 2.2.3.3, *Water Supply System ROW*. Figures 2-4b, 2-4c, and 2-4d show multiple diagrams of the major facility systems, including boiler emission controls, coal handling systems, and the hybrid cooling system, respectively. The major power island components are as follows:

- **Pulverized Coal-Fired Boiler(s).** Up to three supercritical, pulverized coal-fired boilers would be constructed at the power plant to produce steam for the steam turbine-generator(s). The boilers would be designed to maximize efficiency and minimize air pollution during the combustion process. The boilers would be fueled primarily by low-sulfur western coal and use ultra-low sulfur distillate oil as fuel for startup and flame stabilization. Each boiler could be up to 300 feet tall.
- **Steam Turbine-Generator(s).** Each pulverized coal-fired boiler would have a dedicated steam-turbine generator. The steam turbine-generators would use steam produced by the boilers to drive electric generators. Each steam turbine-generator is expected to have a nominal generating capacity of 500 megawatts (MW) to 800 MW. The maximum net generating capacity of the combined steam turbine generators

is expected to be no more than approximately 1,590 MW. The steam used in the steam turbine-generators would exhaust from the steam turbine-generator into a condenser.

- **Condenser(s).** A condenser would attach to each steam turbine to receive exhaust steam. Inside the condenser, the exhaust steam would condense to its liquid state for reuse in the boiler.
- **Cooling Towers.** Up to three cooling towers would be constructed at the power plant site for heat rejection. Natural draft cooling towers are planned for use. Each cooling tower would be approximately 550 feet tall with diameters of approximately 590 feet at the base, 330 feet at the throat, and 350 feet at the top of the structure.

The proposed Station cooling system is a hybrid system that will, on all but the warmest days of the year, operate as a dry system. The hybrid cooling system is a closed loop, indirect cooling system. Exhaust steam from the low pressure steam turbines is condensed in a direct contact jet condenser that allows direct contact between the condensing exhaust steam and the sprayed cooling water. The condensed steam and spray water are collected at the bottom of the spray condenser, from which a portion of the flow is pumped to a dry cooling tower. The dry tower is made up of water-to-air heat exchangers that use ambient air to cool the water flowing inside the heat exchangers. The dry cooling tower is expected to be arranged as a natural draft tower that would use the buoyancy of warm air to move air across the heat exchangers. Cooled water from the dry cooling tower would then be used as the spray water in the spray condenser.

The exhaust gases created by the combustion process are cleaned by routing them through various air emissions control equipment prior to being exhausted through the stack.

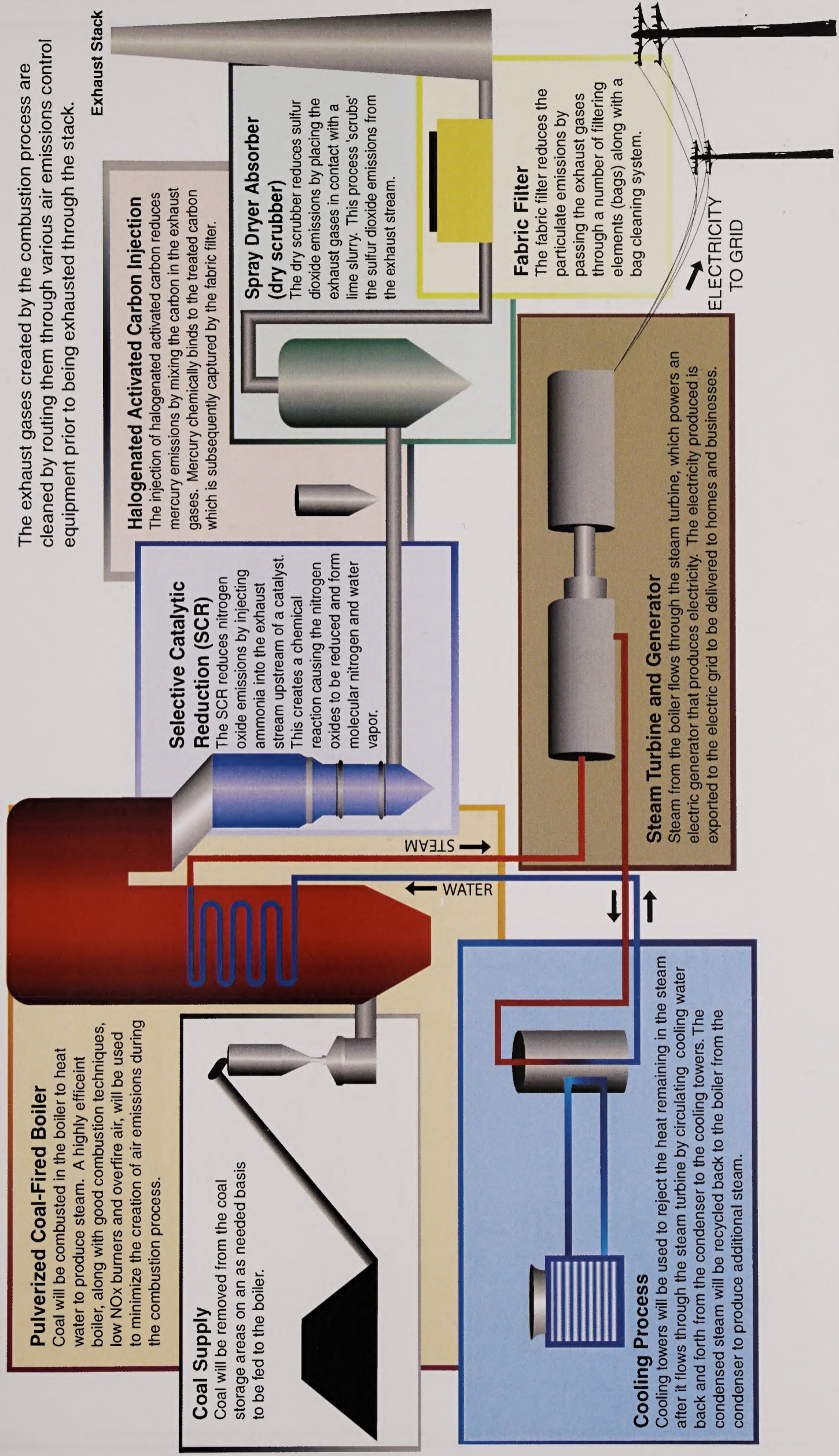

Schematic of the Production Process White Pine Energy Station Project

Figure 2-4a

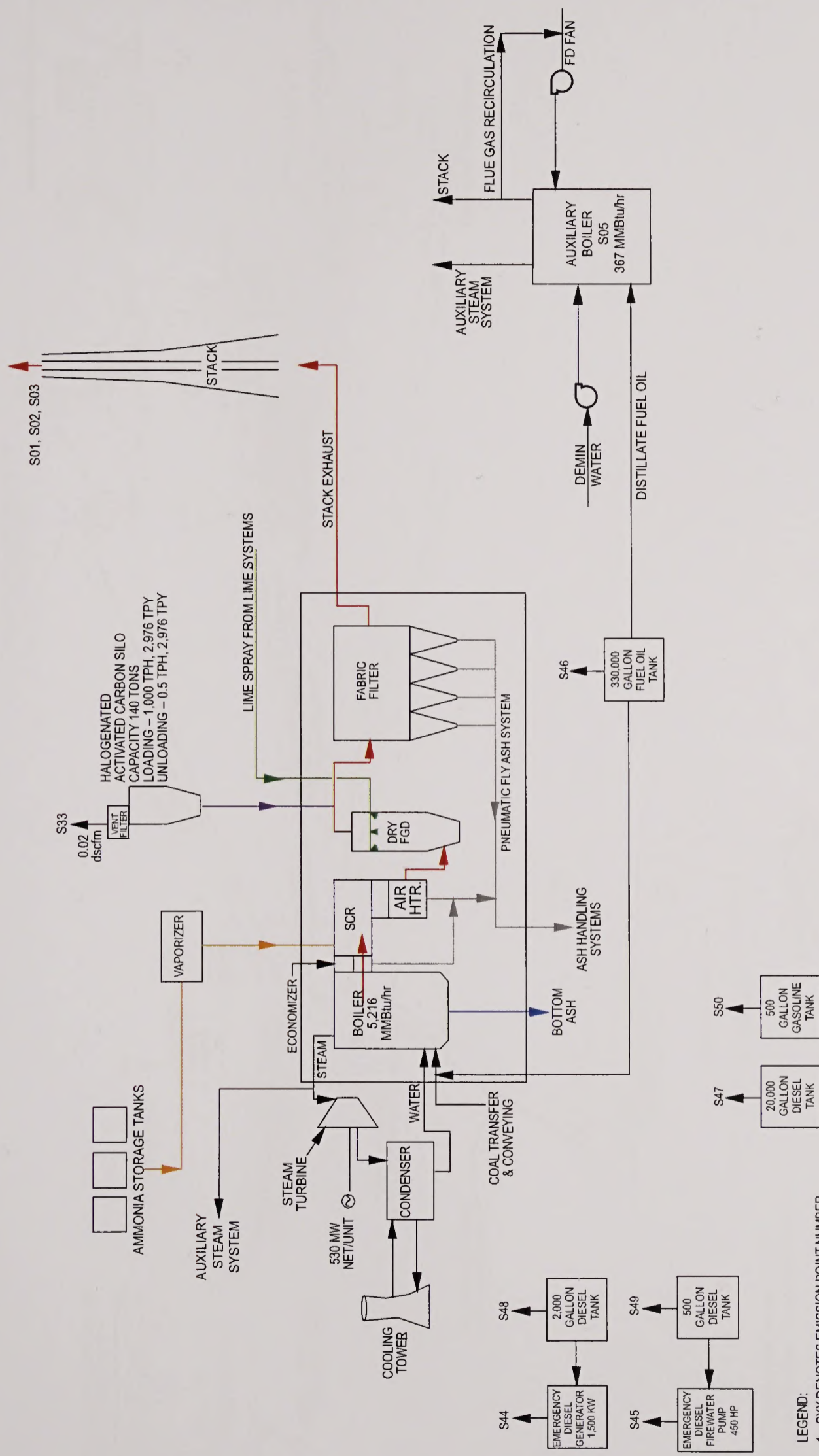

LEGEND:
 1. SXX DENOTES EMISSION POINT NUMBER

Boiler Emission Controls White Pine Energy Station Project

Figure 2-4b

Coal Handling Systems White Pine Energy Station Project

Figure 2-4c

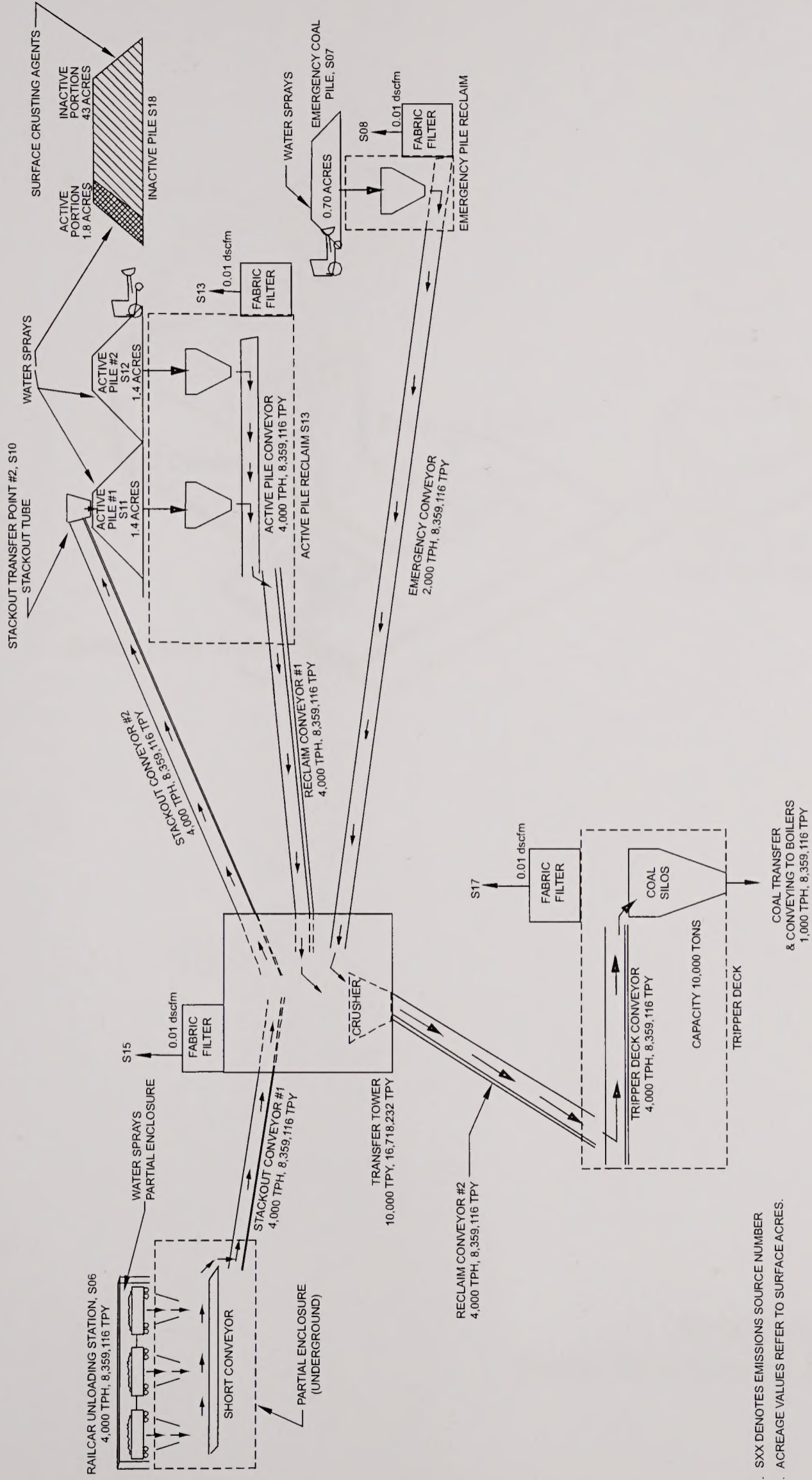

1. SXX DENOTES EMISSIONS SOURCE NUMBER
2. ACREAGE VALUES REFER TO SURFACE ACRES.

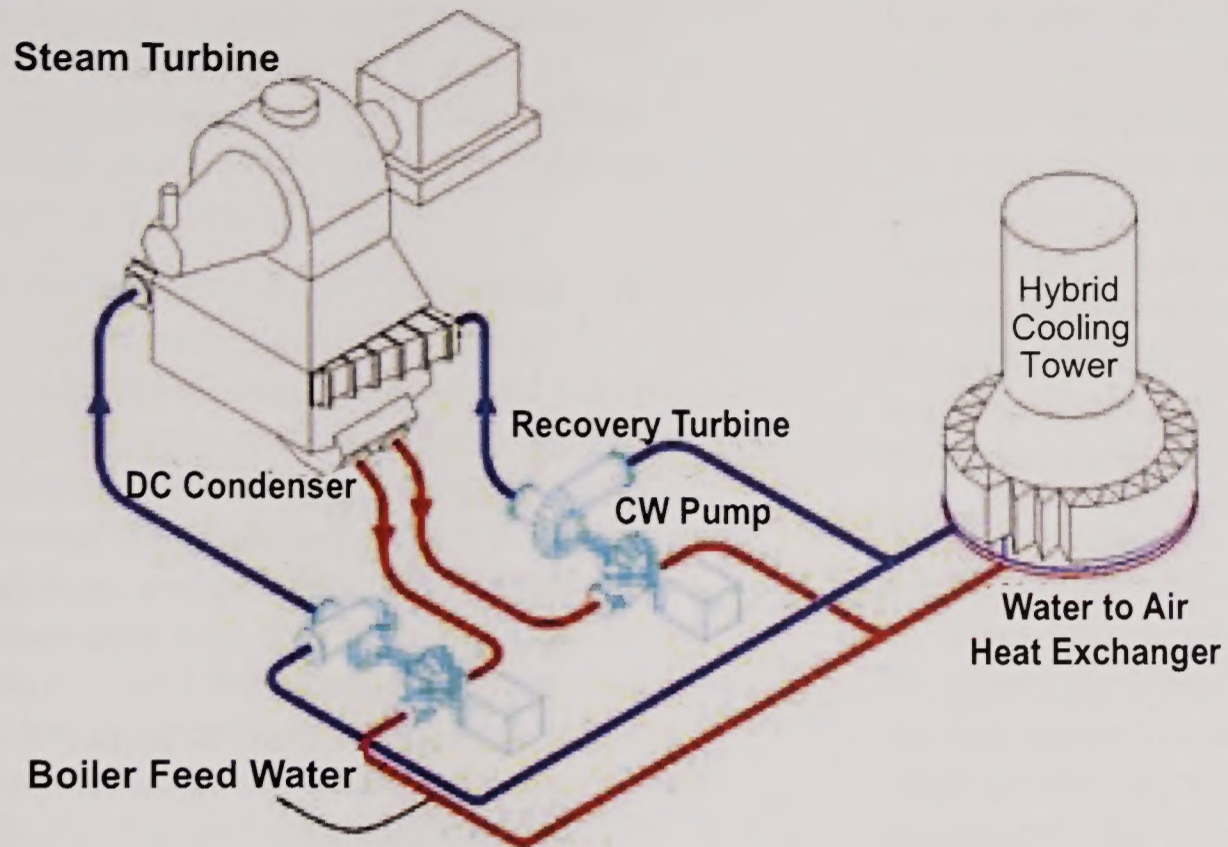

**Hybrid Cooling System
White Pine Energy Station Project**

Figure 2-4d

On the warmest days of the year, spray augmentation may be used. Water can be sprayed on the surface of a portion of the heat exchangers to augment heat transfer from the circulating water to the air. The supplementary spray results in colder spray water being returned to the jet condenser, which yields a lower turbine exhaust backpressure and greater turbine output and efficiency.

Air Pollution Control Equipment. The emissions control equipment for each pulverized coal-fired boiler would consist of low nitrogen oxide burners, overfire air, selective catalytic reduction, spray dryer absorber (dry scrubber), fabric filter baghouse, and halogenated activated carbon injection. Exhaust gases from the boilers would flow through the emissions control equipment, as applicable, before being discharged to the atmosphere via the pulverized coal-fired boiler stack(s). The emissions control equipment is effective in reducing nitrogen oxide, sulfur dioxide, particulate matter, and hazardous air pollutants, including mercury. The systems would be designed to meet or exceed the requirements of the power plant's air permit. Information on alternative air pollution control technologies that were evaluated but rejected from detailed evaluation and the rationale for their rejection are presented in Section 2.5.4 and Appendix D.

- **Pulverized Coal-Fired Boiler Stack(s).** The power plant would include up to two pulverized coal-fired boiler stacks, one for two pulverized coal-fired boilers and a second for the third pulverized coal-fired boiler. Each stack is expected to be approximately 600 feet tall.
- **Plant Electric Switchyard.** An electric switchyard would be located on the power plant site to increase the

voltage of the electricity produced to 500 kilovolts (kV). The switchyard may include circuit breakers, disconnect switches, generator step-up transformers, auxiliary power transformers, steel structures, and a control building. One or more 500-kV transmission lines would be built from the plant electric switchyard across the power plant site to the Duck Creek Substation. Lower voltage electric distribution lines would extend from the switchyard to provide power to water wells that would supply water to the power plant.

- **Water Treatment.** The power island would include water treatment facilities for raw water, feed water to the plant, condensate, and circulating cooling water in order to maintain water quality for the process equipment. The water treatment facilities would include a water treatment building, water storage tanks, chemical storage tanks and areas, clarifiers, and demineralizers.
- **Auxiliary Boiler.** The power island would include an auxiliary boiler to be used during startup of the pulverized coal-fired boilers and during periods when a pulverized coal-fired boiler is offline. The auxiliary boiler would be fueled by ultra-low sulfur distillate oil. The stack for the auxiliary boiler is anticipated to be 225 feet tall.
- **Additional Facilities.** The power island area may also include various buildings to house equipment and conduct administration, operations, and maintenance activities; warehouses; electrical switchgear buildings; various pumps, motors, and fans; fuel and chemical storage tanks/areas; lime/limestone, ammonia, and mercury sorbent storage and

handling equipment; fire protection, security, and safety systems; stormwater facilities; continuous emission monitoring systems; auxiliary boilers; and back-up electric generators.

2.2.3.1.2 Land Set-Aside for Future Carbon Capture Technology

A memorandum of understanding (MOU) between WPEA and the State of Nevada, signed on November 20, 2007, requires the facility to be designed and constructed in a manner to be “carbon capture ready” so that the facility can be retrofitted in the future with carbon dioxide capture and sequestration if that technology becomes technologically feasible and commercially viable in accordance with the MOU between WPEA and the State of Nevada (refer to Appendix F). As part of this requirement, approximately 7 acres of land would be set aside for each coal fired boiler within the power plant ROW area to allow for the installation of this technology. Refer to Figure 2-2 for the approximate location of the land set-aside.

Because of uncertainty regarding type, configuration, operational details, and timing of development, analysis of the environmental consequences of constructing and operating carbon capture and sequestration technology in conjunction with the proposed White Pine Energy Station is not included in this FEIS. If the capture and/or sequestration of carbon dioxide associated with the Station were to involve BLM-administered land or other federal permitting action, a separate NEPA analysis may be required in the future.

Additional information on carbon capture and sequestration can be found in Appendix E. A copy of the MOU can be found in Appendix F.

2.2.3.1.3 Coal Unloading, Storage, and Handling

Low-sulfur western coal from the Powder River Basin in Wyoming would be the primary fuel for the Station and would be delivered to the power plant site via trains. The estimated life of Powder River Basin coal reserves is approximately 300 to 500 years. The power plant would use approximately 22,500 tons of coal per day when the Station is at full load operation.

The following onsite facilities would be designed to accommodate the unloading, storage, and handling of coal.

- **Rail Loop.** A rail loop would be built onsite to accommodate coal train deliveries. The rail loop would be designed so that no public roads would be blocked while the train is being unloaded. The rail loop is expected to require approximately 11,000 linear feet of track.
- **Coal Unloading Station.** Each rail car would pass through a partially enclosed building for unloading. The unloading station would be designed with dust suppression systems to minimize dust emissions.
- **Coal Storage.** Coal would be stored outdoors in designated active and inactive coal storage areas. The coal storage piles would consist of approximately 45 acres of property onsite. The coal piles within the coal storage areas would be maintained using mobile equipment described under coal handling. Water sprays would be used for dust suppression.
- **Coal Handling.** Coal would be transported from various points on the power plant site by use of conveyor systems. The conveyors would be designed to minimize dust emissions.

At the coal storage areas, equipment such as stackers, reclaimers, bull dozers, and front-end loaders may be used to manage the coal piles.

- **Coal Preparation Equipment.** Before consumption in the power plant, coal would pass through preparation equipment such as crushers and pulverizers. These processes would take place in enclosed areas to minimize the release of dust.

2.2.3.1.4 Solid Waste Disposal

An onsite solid waste disposal facility would be constructed and operated for the disposal of coal combustion byproducts including fly ash, bottom ash, economizer ash, scrubber byproducts and coal rejects, and other inert, nonhazardous industrial wastes generated onsite including construction and maintenance debris. Certain wastes may be remarketed for beneficial reuse as practical. All other types of waste (for example, office wastes, oil, liquids, etc.) would be hauled to an offsite licensed disposal facility. Wastes generated during construction activities would be recycled to the extent practical.

The solid waste disposal facility would be designed in accordance with all applicable federal and state regulations. The facility would include environmental protection measures required by the Nevada Division of Environmental Protection (NDEP) to prevent the release of contaminants to the environment, including surface and ground water. These measures include a bottom liner and leachate collection and control system, a surface water runoff management system with a sediment retention basin, and a ground water quality monitoring program. The monitoring program will consist of three wells located upgradient of the solid waste disposal facility to obtain samples representative of

background water quality, and five wells located downgradient of the disposal facility to ensure the detection of potential contaminants. Samples will be collected quarterly at the eight wells during project operation and into the post-closure period and analyzed for a list of targeted elements of environmental concern associated with Powder River Basin coal. These data will be provided to the NDEP and the BLM. These environmental protection measures and the ground water quality monitoring program at the solid waste disposal facility are outlined in the Operations Plan, Closure Plan, and Post-Closure Plan (SRK Consulting, 2006b).

The solid waste disposal facility, together with associated stormwater control facilities, would be constructed in stages to meet the needs of the Station and may cover up to 200 acres and be approximately 100 feet tall by the end of the Station life. Waste handling systems would be designed to handle the various types of waste and may include storage/preparation areas, conveyors, silos, piping, trucks, and other mobile equipment.

2.2.3.1.5 Evaporation Pond

A zero-discharge evaporation pond with a surface area of up to 75 acres would be constructed on the power plant site. Berms and setbacks around the evaporation pond could cover approximately 15 additional acres for a total of up to 90 acres needed for the evaporation pond.

Wastewater from the power plant site and stormwater runoff that has been collected after coming into contact with potential pollution sources (for example, coal piles and active solid waste disposal facility cells) would be discharged to the evaporation pond in accordance with applicable federal and state regulations.

The evaporation pond would include environmental protection measures required by the NDEP, including an appropriate pond lining and leak detection system, additional liner protection at the discharge point for the inlet piping, specially engineered berms to ensure stability during operation, and ground water quality monitoring. The monitoring program will consist of two wells located upgradient of both the evaporation pond and the solid waste disposal facility to obtain samples representative of background water quality, and three wells located downgradient of the evaporation pond to ensure the detection of potential contaminants. Samples will be collected quarterly at the five wells during project operation and analyzed for a list of parameters specified in the evaporation pond permit issued by NDEP. These data will be provided to the NDEP and the BLM. These environmental protection measures and the ground water quality monitoring program at the evaporation pond are outlined in SRK Consulting (2006a). In addition, protective measures would be implemented and the pond would be monitored to minimize the potential for water quality or other pond-related impacts to wildlife (see Appendix C, *Best Management Practices*, Biological Resources, Item No. 4). Water stored in the evaporation pond would not be discharged from the power plant site.

Storm water runoff from other impervious areas of the power plant site that does not come in contact with potential pollution sources would be regulated under a general permit for storm water discharges associated with industrial activity. This industrial storm water permit is based on BMPs such as storm water diversion and detention, covered storage, spill response, and good housekeeping. Storm water runoff from the power plant site that does

not come in contact with potential pollution sources would be discharged offsite (potentially to Duck Creek) rather than the evaporation pond. These discharges to Duck Creek would be regulated by an NDEP permit applicable to industrial storm water designed to protect water quality in waters of the state.

2.2.3.1.6 Construction Worker Housing

Construction worker housing would include both onsite and offsite housing. The power plant site would include an onsite construction worker housing area with the facilities necessary to support the living accommodations of up to 1,000 workers during construction of the Station. The remaining 200 workers of the peak construction work force of approximately 1,200 workers would reside in offsite housing.

The onsite construction worker housing facilities would be located within the power plant site. Onsite community facilities would include housing, kitchen/dining facilities, water and fire protection facilities, sanitary facilities, medical facilities, security and administrative facilities, recreational facilities, and parking. Recreational facilities may include indoor facilities such as TV rooms, game rooms, and gym area and outdoor facilities such as basketball courts and ball fields. Medical facilities would be limited to first response and may include an ambulance station onsite and an area designated for helicopter landing.

Up to 20 modular, dormitory style community housing facilities would be used as the living quarters to accommodate as many as 800 workers onsite. Each dormitory would be prefabricated and erected on a concrete slab. Each dormitory would include private or communal wash/toilet areas and

laundry and mudroom facilities. An onsite recreational vehicle (RV) park would be established in addition to the dormitory housing to accommodate approximately 200 additional workers for a total capacity of approximately 1,000 workers onsite.

The primary infrastructure to support the construction worker housing would be potable water systems, sanitary wastewater treatment, and electric power and communication lines. Potable water would be provided using the water supply system for the Station. Sanitary wastewater would be collected and treated with an onsite package wastewater treatment plant. Electric power would be established via a temporary distribution line (see Section 2.2.3.6.1, *Electric Distribution Line Construction ROW*) and through the use of diesel generators, as required. Parking areas would be provided throughout the construction area and surfaced with crushed aggregate or gravels. Refuse materials would be collected regularly and transported to an offsite, licensed landfill.

Upon completion of Station construction, modular housing and buildings would be removed from the power plant site and use of the RV park would be limited to periods of major maintenance on the Station. Selected facilities used to support the onsite housing may be converted to permanent use to support the permanent operations and maintenance of the Station. Depending on the size of the power plant initially built, future expansion of the plant would require the re-establishment of the construction worker housing on the power plant site (see discussion in Section 2.2.4.2, *Construction Schedule and Work Force*, regarding construction scenarios and construction worker housing).

2.2.3.2 Electric Transmission Facilities ROW

The electric transmission facilities would consist of overhead 500-kV and 345-kV electric transmission lines and two electric substations (see Figure 2-1). The long-term ROW needed for the electric transmission facilities would total approximately 1,042 acres (see Table 2-1) and include the following:

- Approximately 60-acre electric Duck Creek Substation ROW
- Approximately 77-acre electric Thirtymile Substation ROW
- Approximately 32 mile-long, 200-foot-wide ROW (774 acres) for one 500-kV transmission line from the Duck Creek Substation to the Thirtymile Substation
- Two approximately 0.2 mile-long, 160-foot-wide ROWs (9 acres) for two 345-kV transmission lines to interconnect the Falcon-Gonder 345-kV transmission line to the Thirtymile Substation
- Two approximately 2.5 mile-long, 200-foot-wide ROWs (122 acres) for two 500-kV transmission lines to interconnect the planned SWIP 500-kV transmission line to the Duck Creek Substation

It is possible that the Thirtymile Substation or another substation at the same approximate location could be built as part of the SWIP transmission line or another transmission project. If that occurs and if the resulting substation is capable of serving as an interconnection point for the Station, WPEA may not need ROWs for the Thirtymile Substation and the lines interconnecting the substation to the existing 345-kV line. To ensure that all potential ROWs and impacts are considered, the Thirtymile Substation and

interconnection lines are evaluated in this FEIS as part of the Proposed Action and Alternative 1.

An alternative transmission line route that was evaluated but rejected from detailed evaluation and the rationale for its rejection are described in Section 2.5.10.

2.2.3.2.1 Duck Creek Substation ROW

The Duck Creek Substation would be located adjacent to and immediately south of the power plant site on approximately 60 acres of ROW (see Figures 2-1 and 2-2). The Duck Creek Substation would contain 500-kV electric equipment necessary to operate the substation, which may include circuit breakers, disconnect switches, coupling capacitor voltage transformers, surge arresters, current transformers, phase shifters, series compensators, communications equipment, steel structures, and a control building. Lower voltage equipment may also be included in the substation at a later date to meet the needs of the regional electric system. The substation would be fenced to restrict public access. Transmission towers and lines would also be placed within the Duck Creek Substation ROW.

2.2.3.2.2 Thirtymile Substation ROW

The Thirtymile Substation would be located on approximately 77 acres in Section 19, Township 18 North, Range 61 East (see Figure 2-1). The Thirtymile Substation would contain 500-kV and 345-kV equipment necessary to operate the substation, which may include transformers, circuit breakers, disconnect switches, coupling capacitor voltage transformers, surge arresters, current transformers, phase shifters, series compensators, communications equipment, steel structures, and a control building. The substation would be fenced to restrict public access. Transmission

towers and lines would also be placed within the Thirtymile Substation ROW.

2.2.3.2.3 Duck Creek to Thirtymile 500-kV Transmission Line ROW

One new aboveground 500-kV transmission line originating at the Duck Creek Substation would be constructed in a 200-foot-wide ROW and extend 32 miles southwest to the proposed Thirtymile Substation near Robinson Summit (see Figure 2-1). The type of transmission tower used for the Duck Creek to Thirtymile 500-kV transmission line would vary among steel pole H-frame (3-pole dead end) and single and double circuit self-supporting steel lattice towers to accommodate various mitigation, engineering, and maintenance needs. In Steptoe and Butte Valleys, the towers used would be steel pole H-frames with avian predator perch deterrents. Across the Egan Range, the towers used would be single-circuit self-supporting lattices to provide structural integrity and minimize construction and maintenance costs in this uneven terrain. Through the narrow canyon along Bothwick Road at the south end of Butte Valley, the towers used would be double-circuit self-supporting lattices to accommodate a potential second circuit associated with the SWIP. After passing through this canyon, the towers used would be single-circuit self-supporting lattices until reaching the Thirtymile Substation. These self-supporting lattice structures would not need avian predator deterrents because they are not in an area that is suitable habitat for greater sage-grouse. It is estimated that there would be approximately 21 miles of transmission line utilizing H-frame towers, approximately 10 miles of transmission line utilizing single-circuit self-supporting lattice towers, and approximately 1 mile of transmission line utilizing double-circuit self-supporting lattice towers.

Figures 2-5 through 2-9 contain typical representations of planned transmission towers. As noted on the figures, avian predator perch deterrents/nest construction barriers would be used on all electrical transmission support structures in all habitats except pinyon-juniper (which is not greater sage-grouse habitat). Angle suspension towers, which look essentially the same as tangent towers, would be required at turning points in the line.

The height of and spacing between each tower would be determined based on detailed engineering and be dependent on the type of tower used and the terrain. Typically, steel pole H-frame towers would be 120 to 150 feet tall; single-circuit lattice towers would typically be 125 to 155 feet tall; and double-circuit lattice towers would typically be 170 to 200 feet tall.

The spacing between tower structures would generally average between 1,300 and 1,600 feet, but could vary substantially in steep or uneven terrain. The spacing between double-circuit towers would generally be between 900 and 1,100 feet. The towers would generally be placed in tandem with tower locations for the SWIP transmission line. It is estimated that there would be approximately 86 H-frame towers, approximately 43 single-circuit self-supporting lattice towers, and approximately 6 double-circuit self-supporting lattice towers.

Footings for each tower are generally expected to occupy approximately 28 square feet for single-circuit lattice towers, approximately 64 square feet for double-circuit lattice towers, and approximately 127 square feet for steel pole H-frame towers.

Access roads would be constructed to allow for construction access and the long

term maintenance of the transmission line. The access roads would include spur roads to access the transmission line ROW and a centerline travel route that would generally run along the centerline of the transmission line ROW. Certain existing roads may be upgraded with new road construction utilizing overland construction techniques (crush and roll) with selective clearing of vegetation and avoidance of sensitive resources.

The average width of the new construction access roads would be approximately 15 feet; however, some areas may be widened up to 30 feet to allow for vehicle passing areas and other surface improvements. Widening beyond 30 feet is not expected; however, this may occur occasionally depending on field conditions. The average width of disturbance for upgrading existing roads is estimated to be 5 feet; however, this may vary considerably depending on field conditions. Following construction, the new construction access roads would be converted to a 10-foot-wide, two-track path that would be used for annual inspections, maintenance, and repair. An estimated 12 miles of existing roads would need to be upgraded and approximately 35 miles of new roads would have to be constructed.

2.2.3.2.4 Falcon-Gonder 345-kV Interconnection ROW

Two separate 160-foot-wide transmission line ROWs would be required to interconnect the existing Falcon-Gonder 345-kV line into the Thirtymile Substation. Each 160-foot ROW would be approximately 0.2 mile long. They would be parallel to each other with the centerline of each ROW separated by approximately 300 feet (see Figure 2-1).

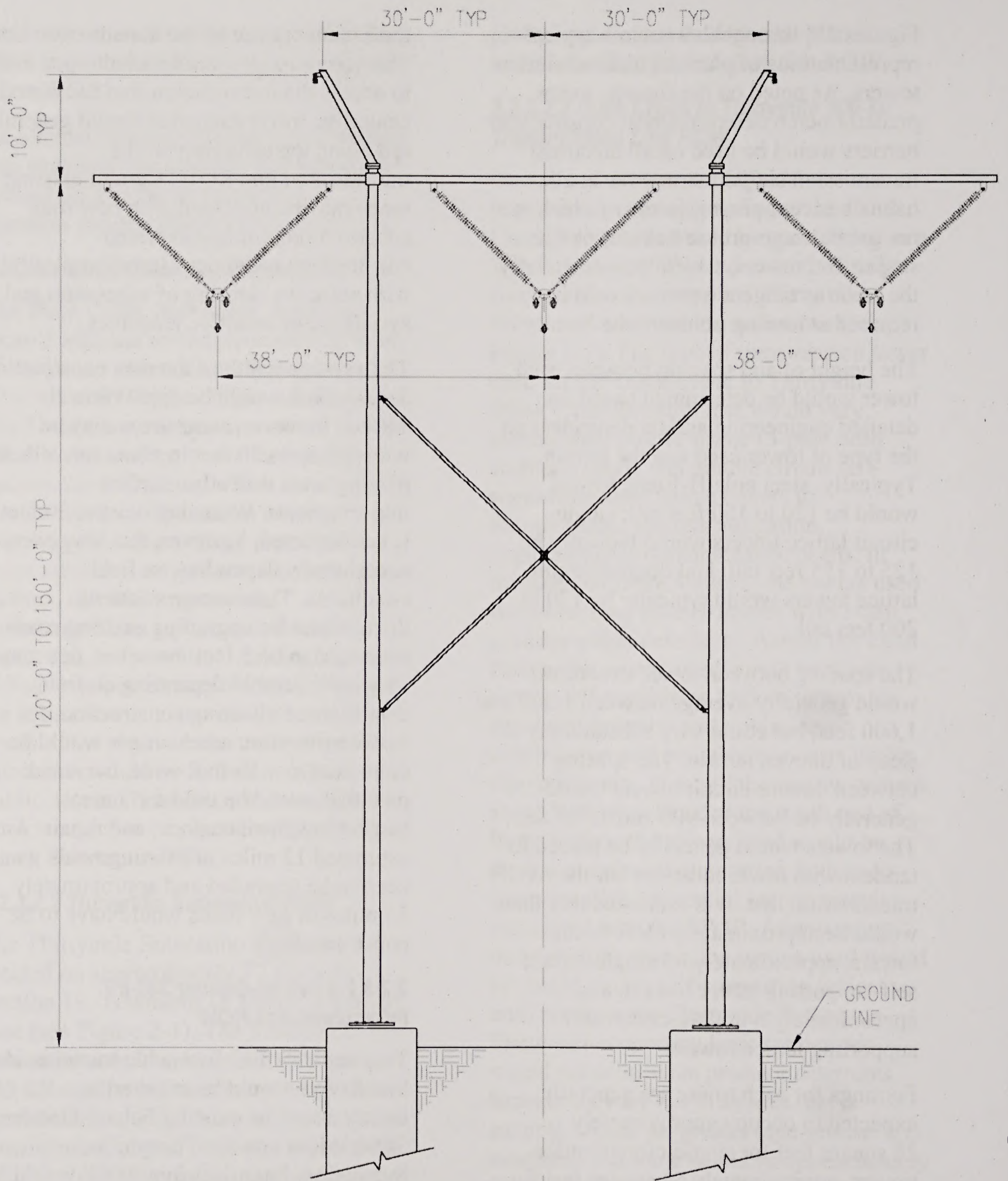

NOTE:

Perch deterrents/nest construction barriers will be utilized on all electrical transmission support structures in all habitats except pinyon-juniper.

**500-kV Transmission Line
Typical Tangent Steel Pole H-Frame
White Pine Energy Station Project**

Figure 2-5

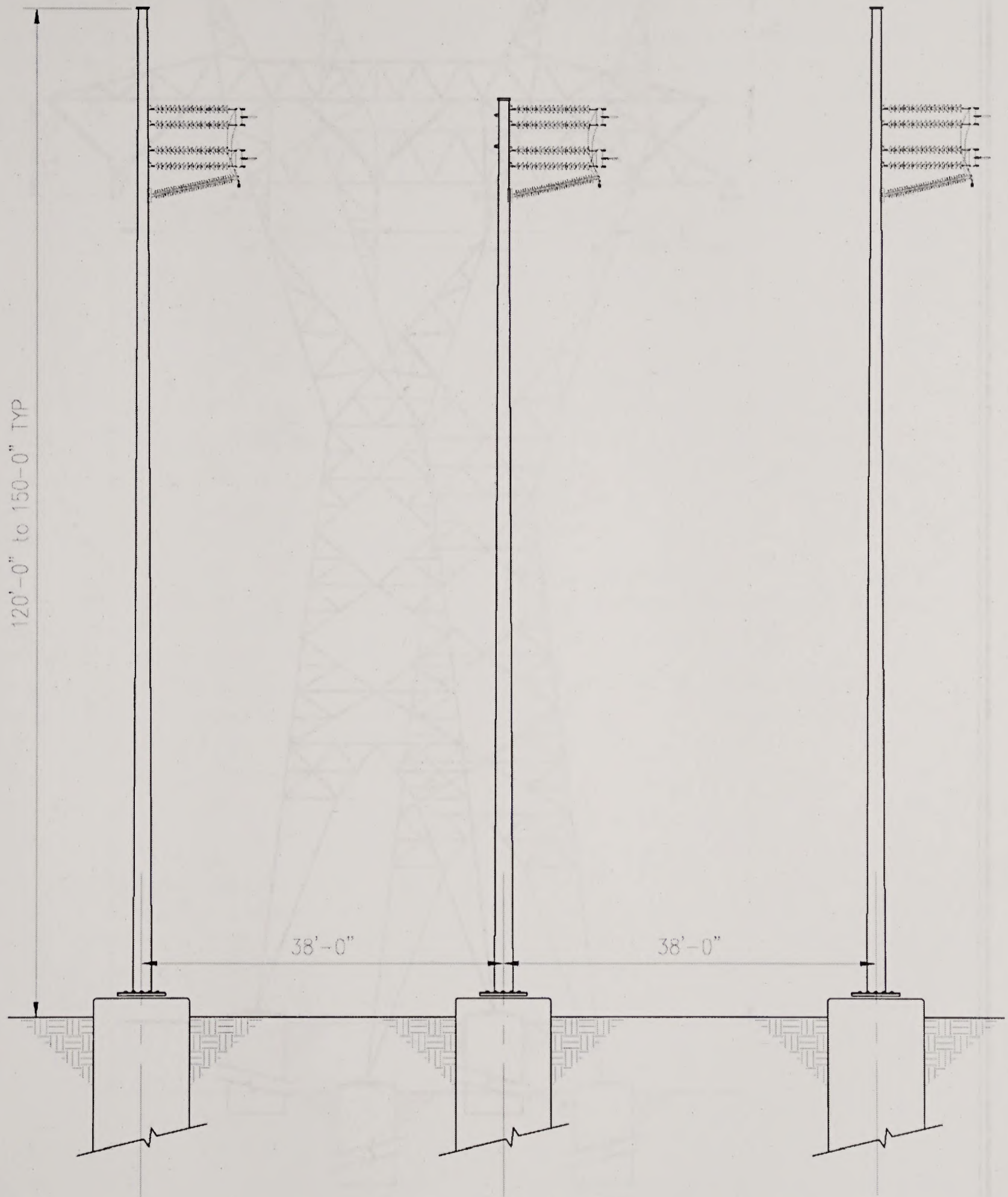

NOTE:

Perch deterrents/nest construction barriers will be utilized on all electrical transmission support structures in all habitats except pinyon-juniper.

**500-kV Transmission Line
Typical Dead End Steel Pole
White Pine Energy Station Project**

Figure 2-6

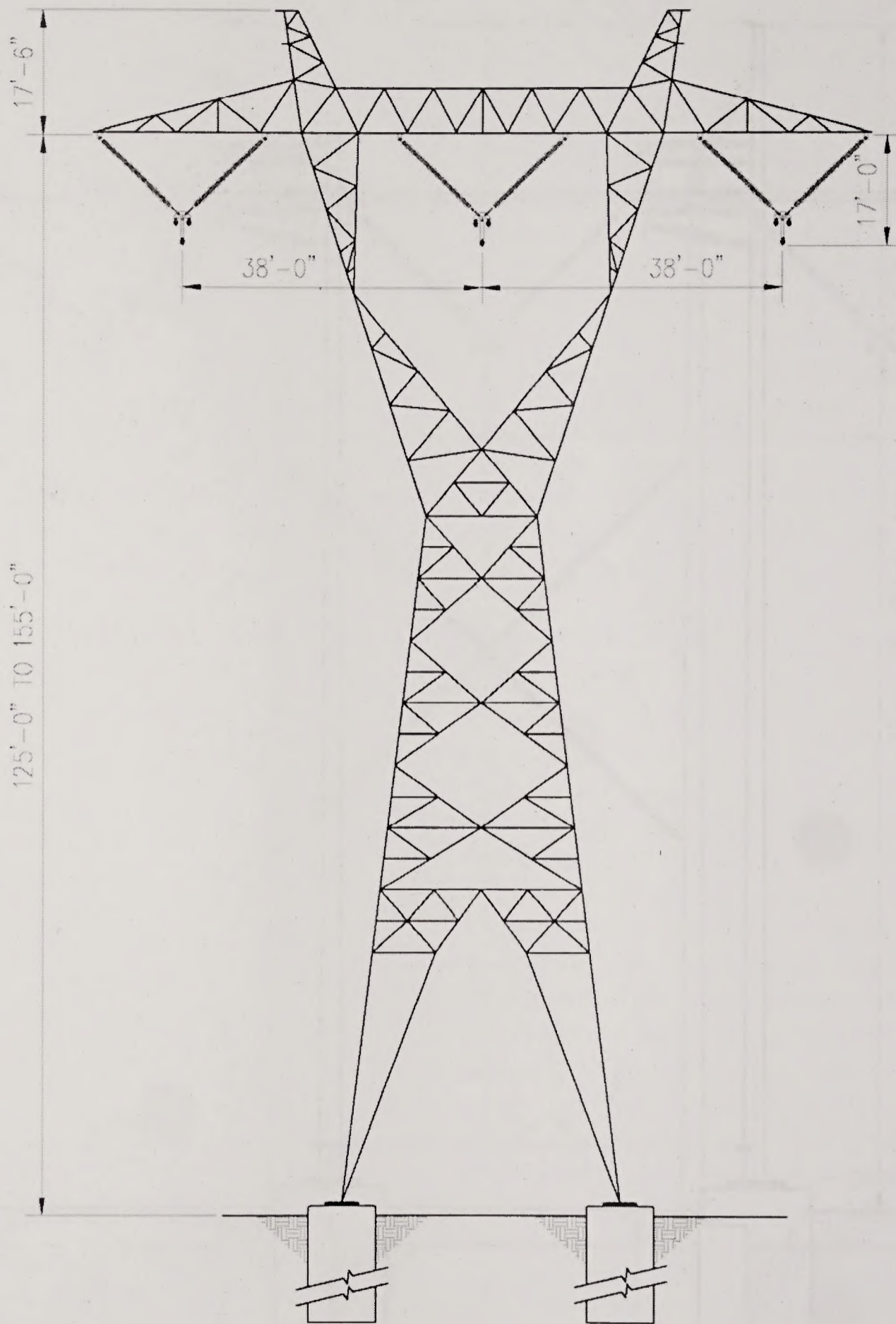

NOTE:

Perch deterrents/nest construction barriers will be utilized on all electrical transmission support structures in all habitats except pinyon-juniper.

**500-kV Transmission Line
Typical Single Circuit Tangent
White Pine Energy Station Project**

Figure 2-7

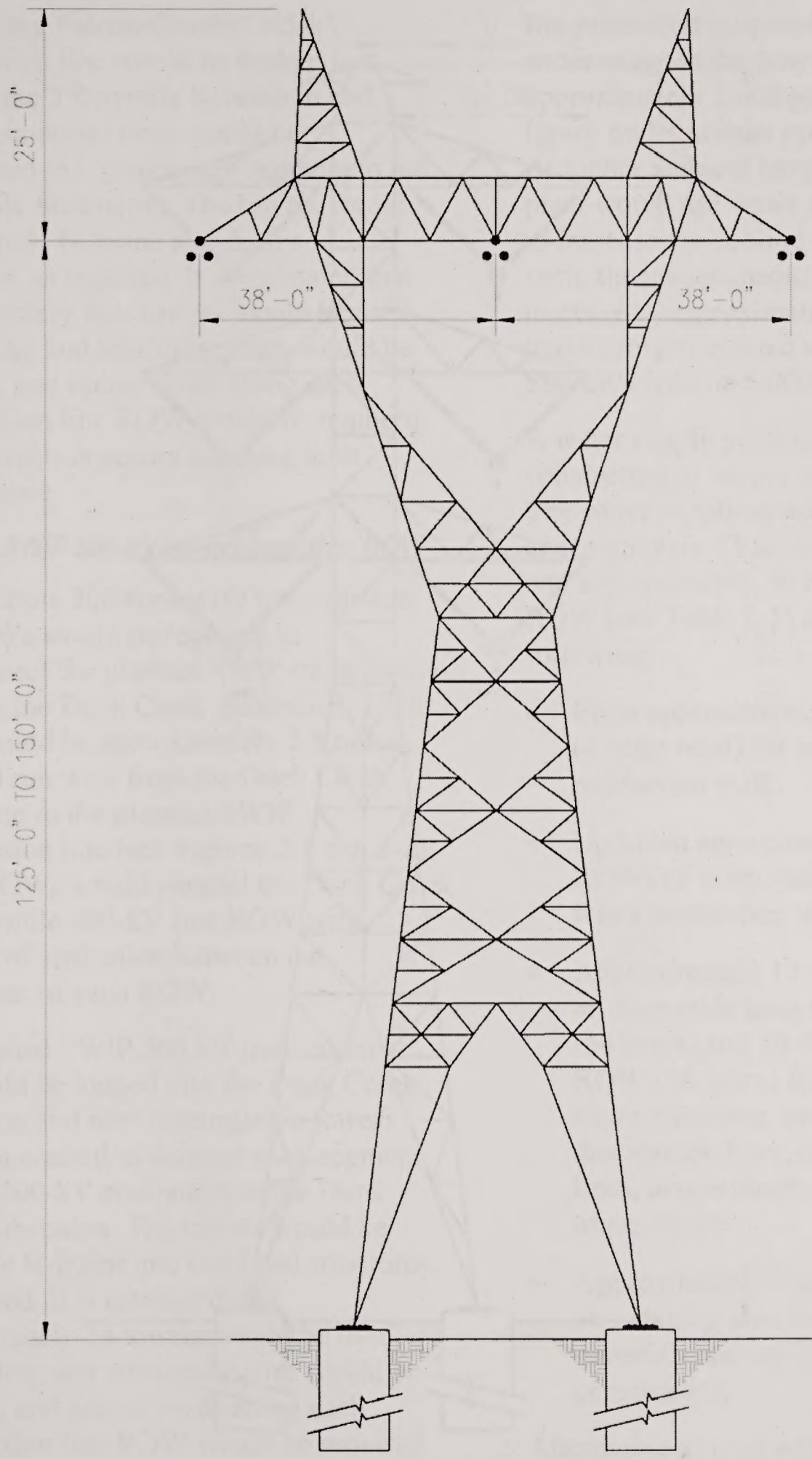

NOTE:

Perch deterrents/nest construction barriers will be utilized on all electrical transmission support structures in all habitats except pinyon-juniper.

**500-kV Transmission Line
Typical Single Circuit Dead End
White Pine Energy Station Project**

Figure 2-8

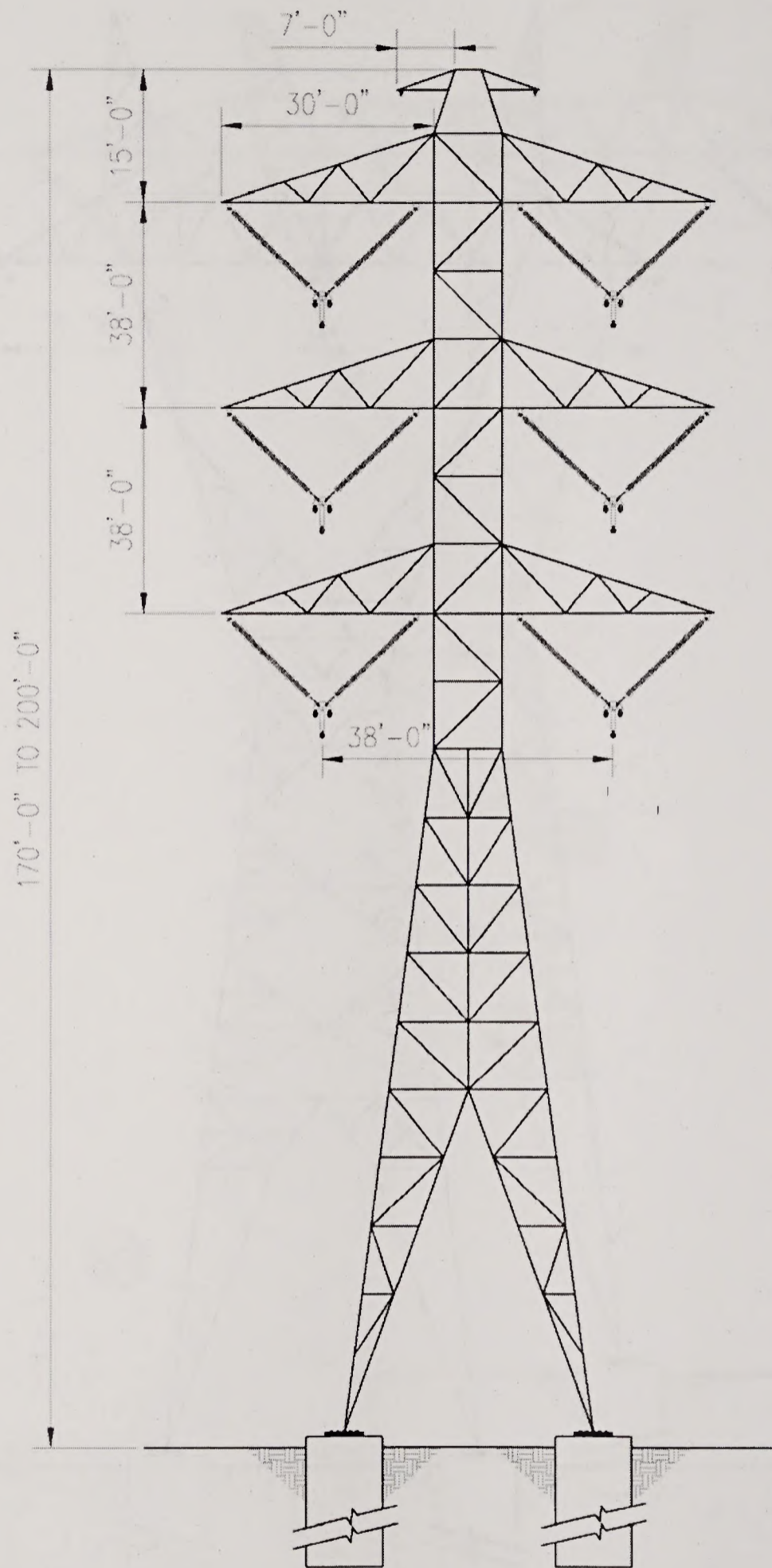

NOTE:

Perch deterrents/nest construction barriers will be utilized on all electrical transmission support structures in all habitats except pinyon-juniper.

**500-kV Transmission Line
Typical Tangent Tower Double Circuit
White Pine Energy Station Project**

The existing Falcon-Gonder 345-kV transmission line would be broken just south of the Thirtymile Substation and new transmission lines would be constructed to connect each segment to the Thirtymile Substation. The towers would be steel pole H-frame and dead end structures, as required. It is estimated that approximately four towers would be used, two pulling and tensioning sites would be required, and access roads along each transmission line ROW would be required for construction access and long term maintenance.

2.2.3.2.5 SWIP 500-kV Interconnection ROW

Two separate 200-foot-wide transmission line ROWs would be required to interconnect the planned SWIP transmission line with the Duck Creek Substation. Each ROW would be approximately 2.5 miles long and run west from the Duck Creek Substation to the planned SWIP transmission line (see Figures 2-1 and 2-2). These ROWs would parallel the Duck Creek to Thirtymile 500-kV line ROW with 500 feet of separation between the centerlines of each ROW.

The planned SWIP 500 kV transmission line would be looped into the Duck Creek Substation and new transmission towers would be erected to connect each segment into the 500-kV equipment at the Duck Creek Substation. The towers would be steel pole H-frame and dead end structures, as required. It is estimated that approximately 24 towers would be used, four pulling and tensioning sites would be required, and access roads along each transmission line ROW would be required for construction access and long term maintenance.

2.2.3.3 Water Supply System ROW

The Station would require water for construction, process, cooling, potable, and

fire protection purposes. Instantaneous water usage at the power plant would be approximately 2,000 gallons per minute (gpm) under normal operating conditions. At higher ambient temperatures, the power plant would use water spray augmentation to increase the cooling efficiency and, as such, the instantaneous water usage would increase to approximately 6,000 gpm. The maximum anticipated water usage at the Station would be 5,000 acre-feet annually.

A water supply system would be constructed to supply water to the Station. The water supply system would require approximately 73 acres of long-term ROW and approximately 50 acres of short-term ROW (see Table 2-1) and include the following:

- Eight approximately 1/2-acre ROWs (4 acres total) for each ground water production well
- Up to ten approximately 1/2-acre ROWs (5 acres total) for each ground water monitoring well
- Approximately 13 mile-long, 40-foot-wide long-term ROW (64 acres) and 30-foot-wide short-term ROW (48 acres) for underground water pipelines, overhead electric distribution lines, communications lines, access roads, and other facilities as necessary
- Approximately 2-acre short-term ROW as a staging area for the placement of materials and equipment during construction

Alternative ground water well and pipeline locations and numbers that were evaluated but rejected from detailed evaluation and the rationale for their rejection are described in Section 2.5.5 within the broader discussion of an alternative cooling technology that was evaluated.

Alternative well field electric distribution line alignments and design that were evaluated but rejected from detailed evaluation and the rationale for their rejection are described in Section 2.5.9.

2.2.3.3.1 Ground Water Production Well ROW

The Station would use up to eight ground water production wells for water supply. Construction and operation of the ground water wells would occupy approximately 0.2 acre total. The wells would be approximately 1,000 feet deep and withdraw water from the basin-fill aquifer. Each well is permitted to withdraw up to 3 cubic feet per second of water. The location for the ground water wells associated with the water supply system is constrained by defined well locations as specified under permits issued to White Pine County by the Nevada State Engineer's Office. Figure 2-1 depicts the locations where the eight water wells would be drilled.

An underground vault (approximately 8 feet by 8 feet by 8 feet) would be constructed at each well site to house the well and control equipment. The vault floor, walls, and roof would be constructed of concrete. A two-panel hinged metal door would be installed in the roof to provide access. Each well would have a 250- to 600-horsepower motor to accommodate the pumping requirements for the well. The ultimate motor size would be determined based on the pumping requirements of the well and its distance from the power plant. At the well site, the electrical feed for the motor and other electrical equipment would be buried underground from the electric distribution line to the well. Pipe bollards (pipes installed in the ground as a barrier) would be installed above ground around the vault for visibility and to protect the vault from vehicular traffic. A typical well site is depicted in Figure 2-10.

2.2.3.3.2 Ground Water Monitoring Well ROW

A network of up to ten ground water monitoring wells would be installed prior to Station start-up and monitored to document changes in ground water levels that could be caused by ground water withdrawals for the Station at the eight ground water production wells. The monitoring wells would be constructed with screen intervals sufficient to monitor both shallow (unconfined) ground water levels that could influence spring discharge, and deeper ground water that is more representative of existing water supply wells completed in the basin-fill aquifer system in Steptoe Valley. The ground water monitoring wells and monitoring program, together with mitigation actions, are described in detail in Appendix G.

The proposed locations of the ten monitoring wells are identified in Figure G-1 in Appendix G. The specific locations of the monitoring wells would be determined based on physical access limitations and the specific characteristics (for example, depth and screen interval) and performance of the eight production wells, which will not be known until they are installed and tested. All of the monitoring wells are anticipated to be located on public land or land sold by BLM to WPEA.

2.2.3.3.3 Water Supply System Linear Facilities ROW

One 40-foot-wide long-term ROW and one 30-foot-wide short-term ROW would extend from the power plant site approximately 13 miles generally north to each of the ground water wells (see Figure 2-1). The water supply system linear facilities would include the underground water pipelines, overhead electric distribution lines, access roads, and communication lines. They would generally run parallel to one another in the same ROW as depicted in Figure 2-11.

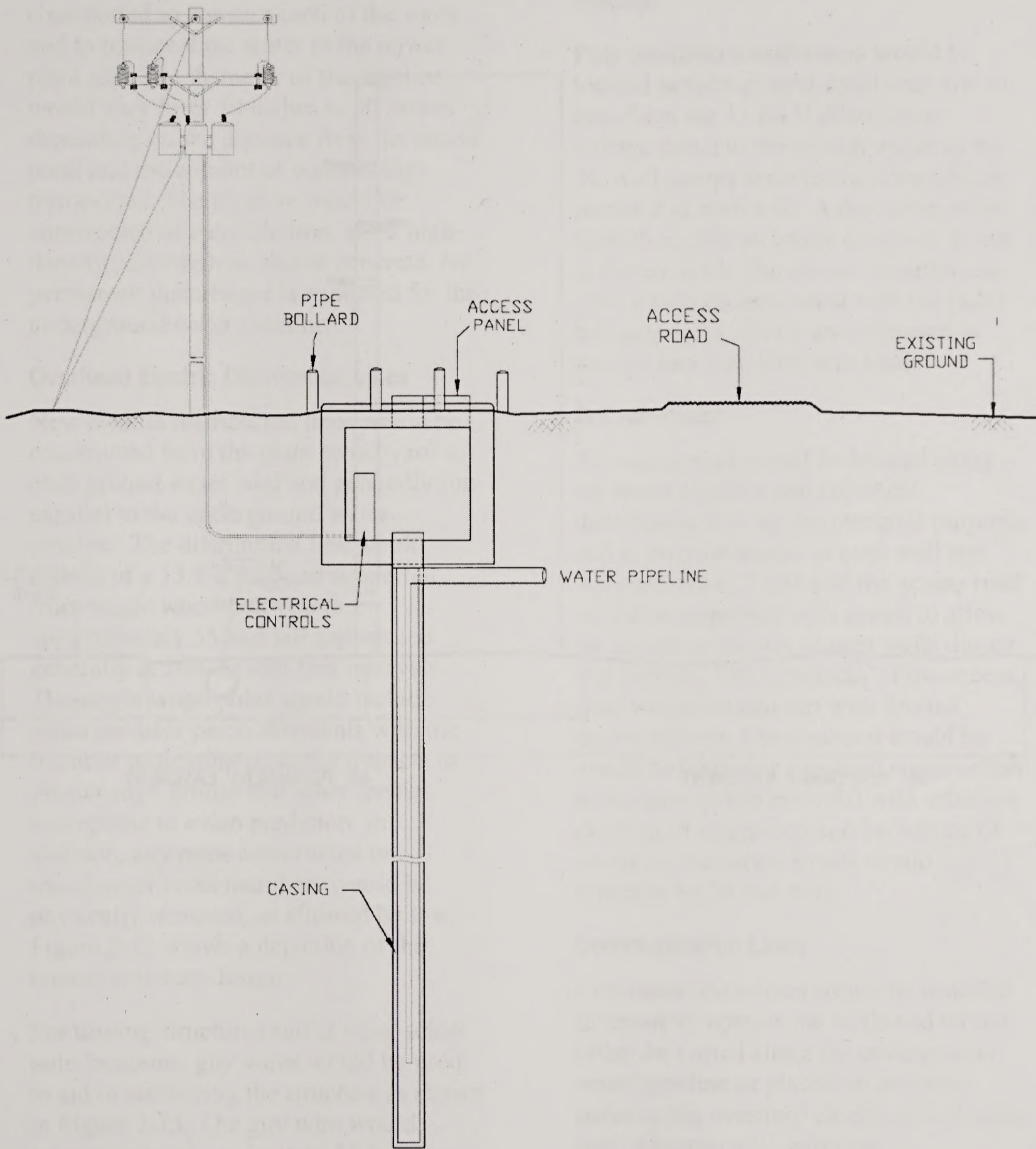

**Typical Groundwater Well Site
White Pine Energy Station Project**

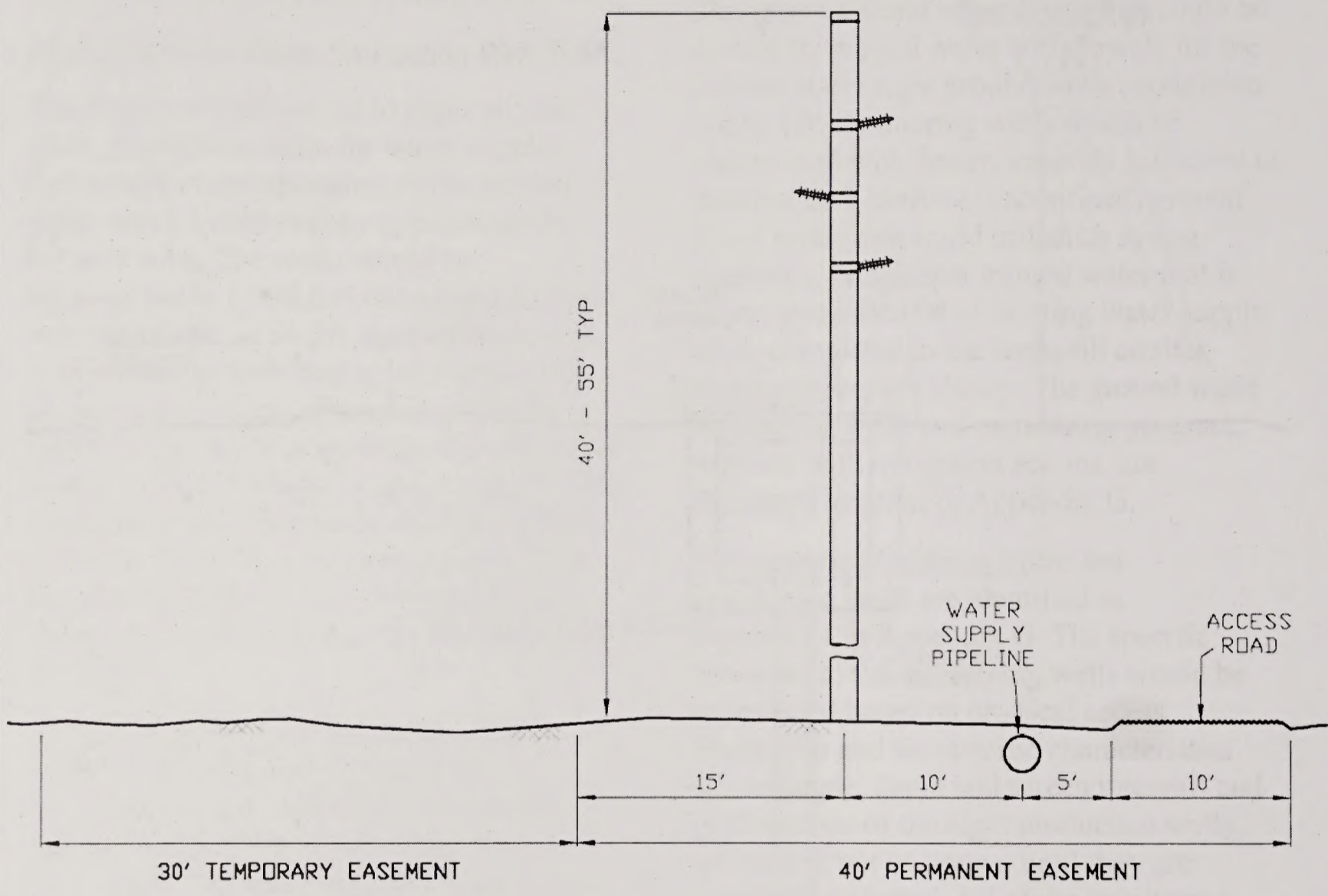

**Water Supply System
Linear Facilities
White Pine Energy Station Project**

Figure 2-11

Underground Water Pipelines

Underground water pipelines would be constructed to connect each of the wells and to transport the water to the power plant site. The diameter of the pipeline would vary from 10 inches to 30 inches depending on the distance from the power plant and the amount of water being transported. The pipeline would be constructed of a ductile iron, steel, high-density polyethylene and/or concrete. No permanent disturbance is expected for the underground water pipelines.

Overhead Electric Distribution Lines

New electric distribution lines would be constructed from the plant switchyard to each ground water well and generally run parallel to the underground water pipeline. The distribution line would consist of a 13.8-kV circuit supported from single wood poles up to approximately 55 feet tall and spaced generally at 200- to 300-foot intervals. The single wood poles would include avian predator perch deterrents with the intent of mitigating potential impacts to greater sage-grouse and other species susceptible to avian predation. In addition, any nests constructed on transformer cross members would be physically removed, as allowed by law. Figure 2-12 shows a depiction of the typical structure design.

For turning structures and at other select pole locations, guy wires would be used to aid in stabilizing the structure as shown in Figure 2-13. The guy wire would extend up to approximately 35 feet from the structure.

The base of the guy wire would be fenced and within the long-term ROW, and the first 10 feet of guy wire would be marked with safety reflectors, high-visibility tape

or plastic, or a similar material to make it highly visible to the public and wildlife species.

Pole-mounted transformers would be located at each ground water well site to transform the 13.8-kV distribution voltage down to the voltage required by the well pumps and electrical equipment installed at each well. A depiction of the typical on-pole structure design is shown in Figure 2-14. The electric distribution lines would be associated with the poles and guy wires, which are estimated to occupy less than 0.05 acre total.

Access Roads

An access road would be located along the water pipeline and electrical distribution line for maintenance purposes and to provide access to each well site. Approximately 2 miles of the access road would be improved with gravel to allow for access to the two closest wells during wet periods. The remainder of the access road would remain dirt with limited improvements. Construction would be conducted utilizing overland construction techniques (crush and roll) with selective clearing of vegetation and avoidance of sensitive resources. Roads would typically be 10 feet wide.

Communication Lines

Communication lines would be installed to remotely operate the wells and would either be buried along the underground water pipeline or placed on the same poles as the overhead electric distribution line. Alternatively, wireless communication systems would be used. No significant additional permanent disturbance is expected for the communication lines.

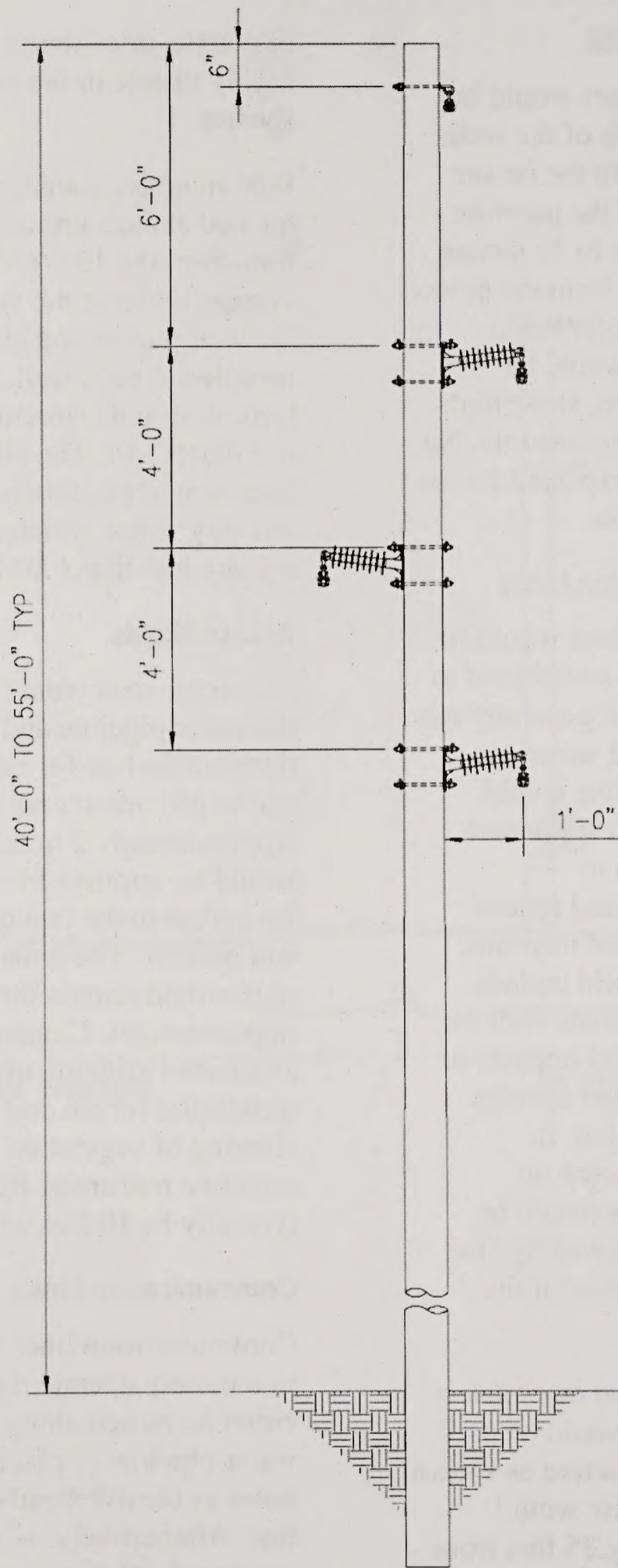

NOTE:

Perch deterrents/nest construction barriers will be utilized on all electrical transmission support structures in all habitats except pinyon-juniper.

**Typical Tangent Single Wood Pole
White Pine Energy Station Project**

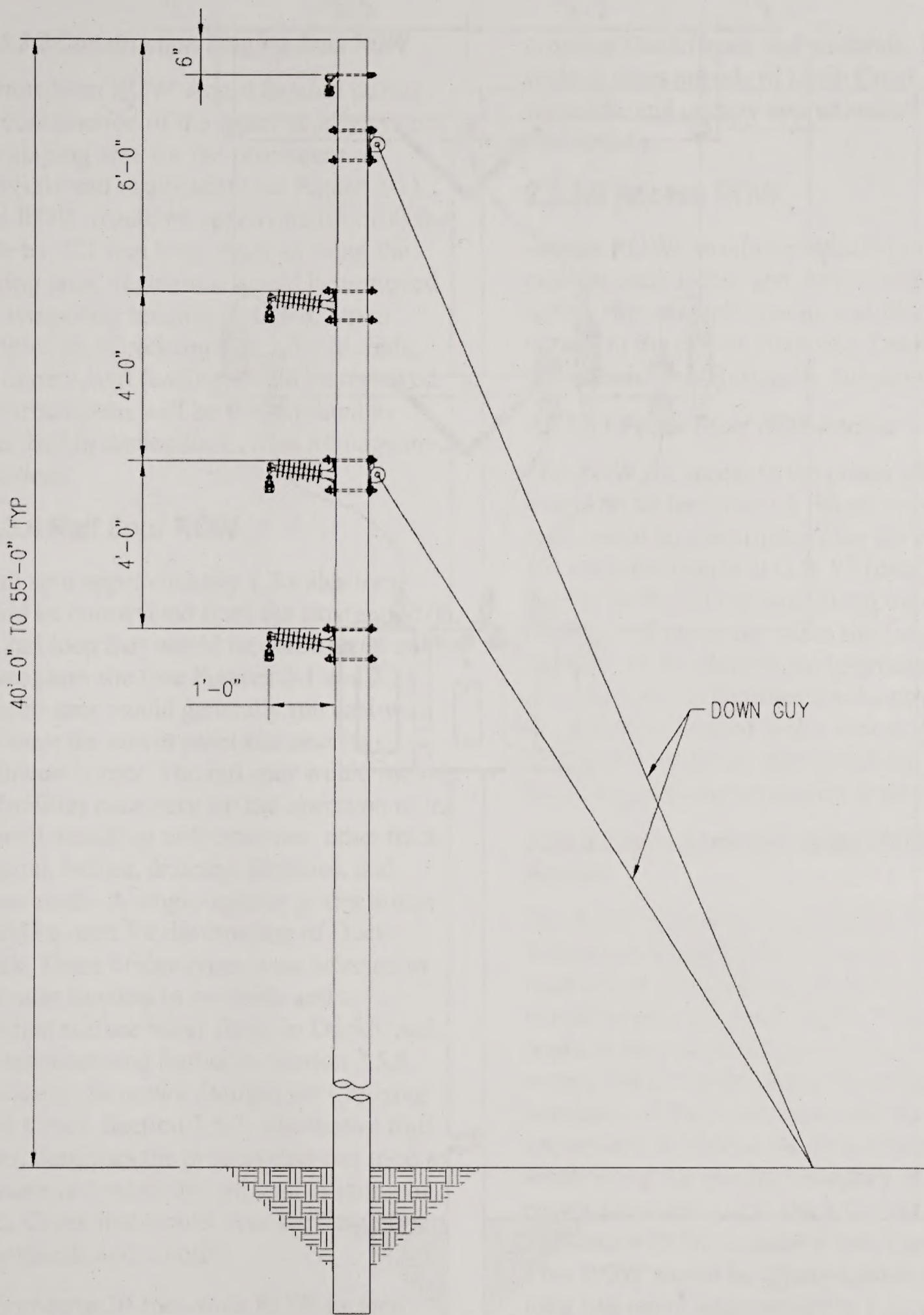

NOTE:

Perch deterrents/nest construction barriers will be utilized on all electrical transmission support structures in all habitats except pinyon-juniper.

**Typical Angle Single Wood Pole
White Pine Energy Station Project**

Figure 2-13

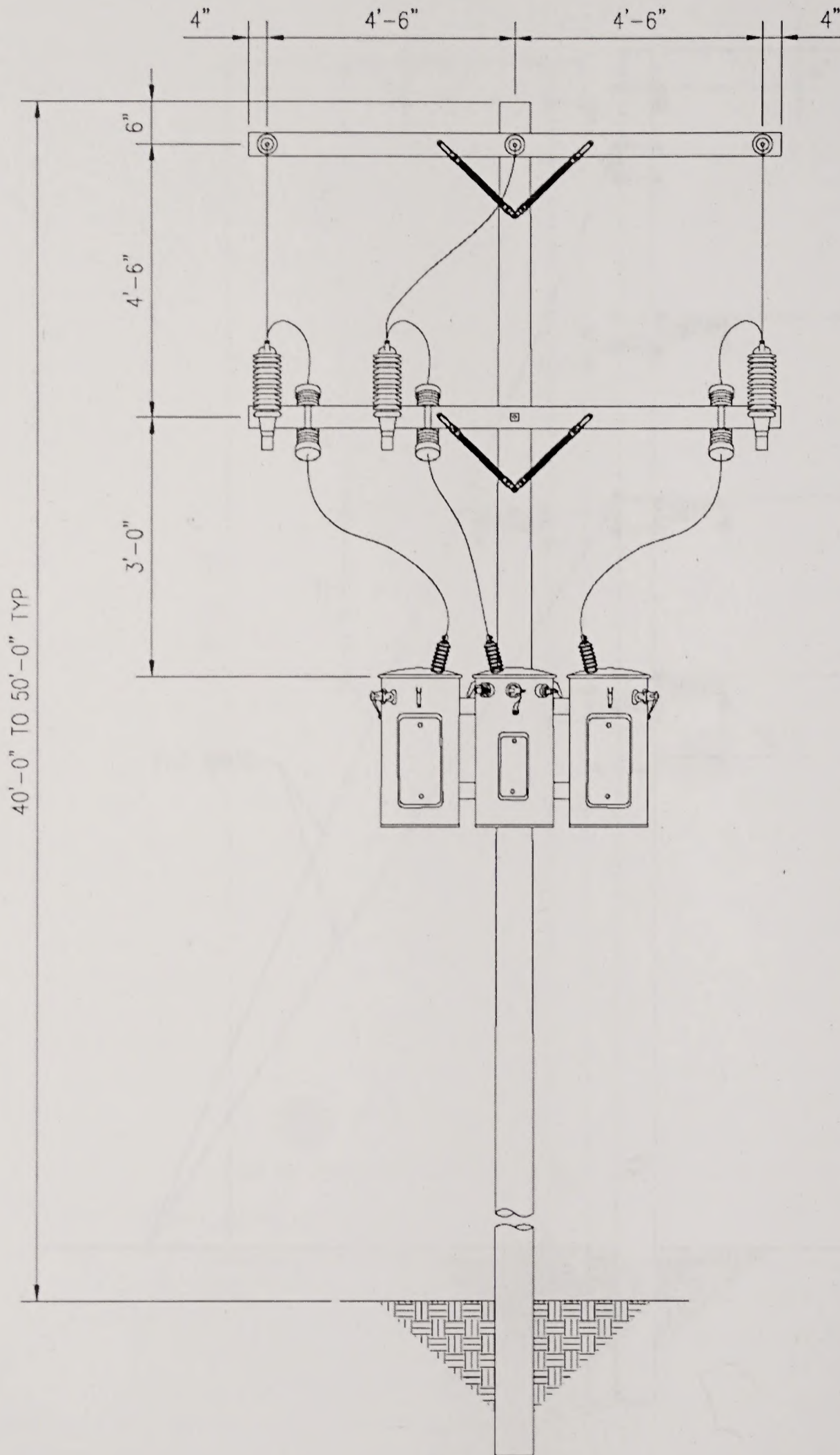

NOTE:
 Perch deterrents/nest construction
 barriers will be utilized on all electrical
 transmission support structures in all
 habitats except pinyon-juniper.

**Typical 13.8kV Three Phase
 Transformer Bank Wood Pole
 White Pine Energy Station Project**

2.2.3.3.3 Construction Staging Area ROW

A short-term ROW would be used during the construction of the water supply system as a staging area for the placement of materials and equipment (see Figure 2-1). This ROW would be approximately 100 feet wide by 871 feet long. Prior to using the staging area, vegetation would be removed and temporary fencing installed. Upon completion of construction, all materials, equipment, and fencing would be removed. Disturbed areas will be rehabilitated as described in Appendix C, *Best Management Practices*.

2.2.3.4 Rail Spur ROW

A rail spur approximately 1.3 miles long would be constructed from the existing NNR to a rail loop that would be constructed on the power plant site (see Figures 2-1 and 2-2). The rail spur would generally run east-west and enter the power plant site near its northwest corner. The rail spur would include all facilities necessary for the operation of the railroad including rail, cross ties, other track material, ballast, drainage facilities, and access roads. A single-span or girder bridge would be used for the crossing of Duck Creek. These bridge types were selected to minimize impacts to wetlands and to maintain surface water flows in Duck Creek, and are discussed further in Section 2.5.8, *Alternative Structure Designs for Crossing Duck Creek*. Section 2.5.7, *Alternative Rail Spurs*, describes the process that was used to evaluate and select the rail spur crossing of Duck Creek that would have the least effect on wetlands and wildlife.

A short-term 30-foot-wide ROW located adjacent to the long-term rail spur ROW would be required during construction. The short-term ROW would occupy approximately 5 acres and be reclaimed after construction is complete. The long-term rail spur ROW would be 35 feet wide at areas

crossing Duck Creek and wetlands, 70 feet wide at areas outside of Duck Creek and wetlands, and occupy approximately 9 acres (Table 2-1).

2.2.3.5 Access ROW

Access ROWs would be required to provide road access and certain utility access (for example, phone and fiber optics) to the power plant site, Duck Creek Substation, and Thirtymile Substation.

2.2.3.5.1 Power Plant ROW Access

The ROW for access to the power plant site would be 60 feet wide. A paved two-lane road would be constructed over the existing dirt road that begins at U.S. 93 (near mile marker 86.9) and run west along the southern boundary of the power plant site (see Figure 2-1). In addition, underground communications facilities for the power plant site would be located in this access ROW. This ROW would be approximately 1 mile long and cover approximately 6 acres.

2.2.3.5.2 Duck Creek Substation ROW Access

The ROW for access to the Duck Creek Substation would be 30 feet wide. A gravel road and underground communication lines would be located in this ROW. They would begin at the end of the power plant site access and run west along the southern boundary of the power plant site for approximately 0.05 mile, then continue south along the eastern boundary of the power plant site to the Duck Creek Substation ROW boundary (see Figure 2-1). This ROW would be approximately 0.3 mile long and cover approximately 1 acre.

2.2.3.5.3 Thirtymile Substation ROW Access

The ROW for access to the Thirtymile Substation would be 30 feet wide. An existing dirt road to the Substation Site would be upgraded to a gravel road. The

road begins at U.S. 50, runs in a southerly direction for approximately 0.5 mile and then proceeds easterly for approximately 0.1 mile to the Thirtymile Substation ROW boundary (see Figure 2-15). Underground communication lines to the Thirtymile Substation would also be located in this ROW. This ROW would be approximately 0.6 mile long and cover approximately 2 acres.

2.2.3.6 Electric Distribution Line Construction ROW and Mineral Material Sale

Offsite activities would be necessary to support construction of the Station, including the need for construction power and additional earth and rock materials.

2.2.3.6.1 Electric Distribution Line Construction ROW

A temporary 69-kV electric line would be constructed to provide power during the construction of the Station. This electric distribution line would be located in a short-term ROW that would extend from an existing 69-kV distribution line to the power plant site. This short-term ROW would be 40 feet wide.

The electric distribution line would be constructed from the existing distribution line, located approximately 0.6 mile east of U.S. 93, to the power plant site along the northern side of the existing dirt road that connects to U.S. 93 near mile marker 86.9 (see Figure 2-1). This ROW would be approximately 1.3 miles long, resulting in a short-term ROW grant of approximately 6 acres. Upon completion of construction, the poles and lines would be removed and the short-term ROW relinquished.

2.2.3.6.2 Mineral Material Sale

One or more borrow areas, via a mineral material sale, would be established to





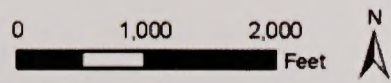
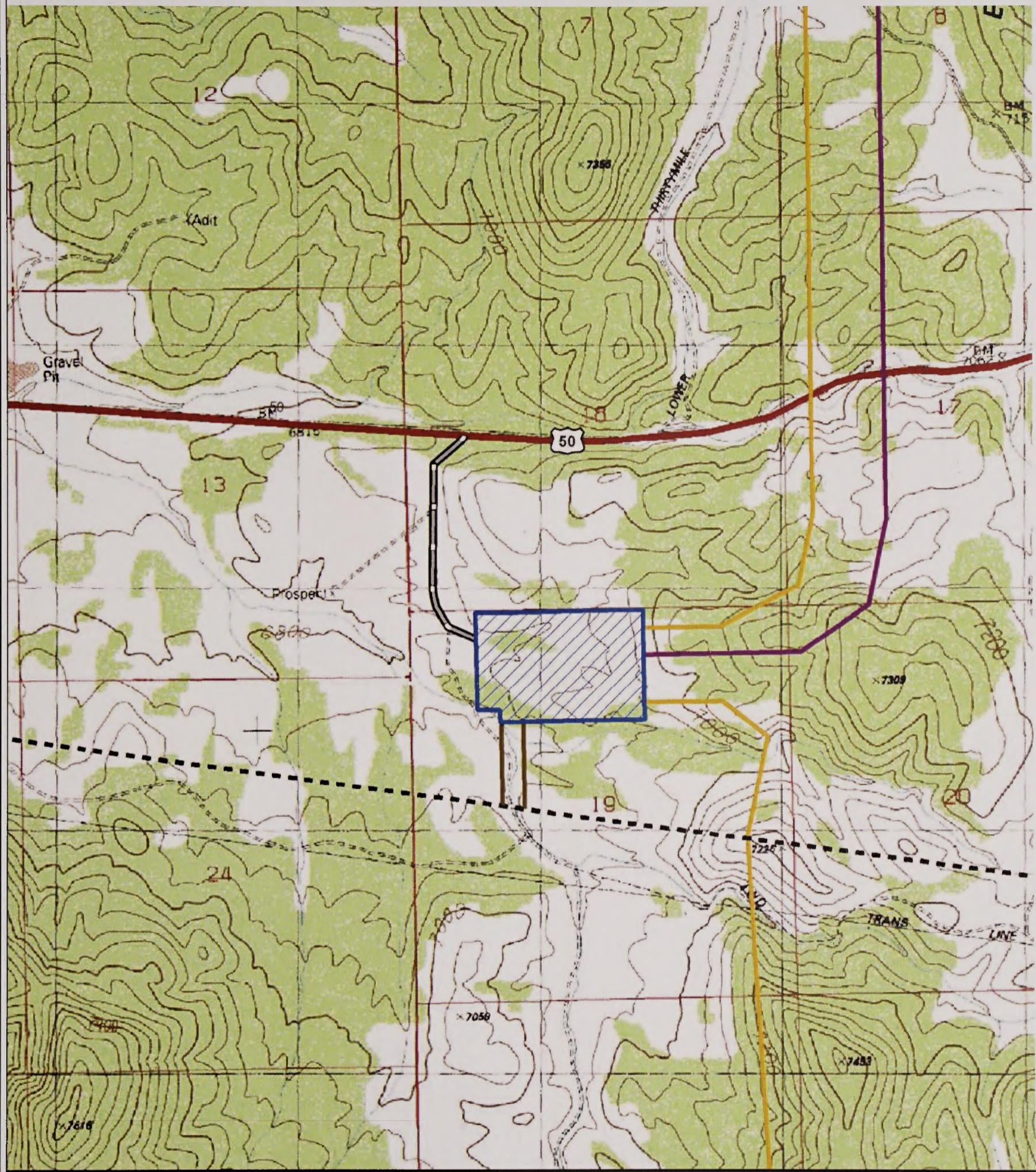

provide earth and rock materials during site preparation and throughout the construction process. The materials would be used for concrete and asphalt mixes, road base, lining of dikes, and rock surfaced areas. A mineral material sale area would cover approximately 40 acres within the area identified in Figure 2-1 and shown in detail in Figure 2-16. This borrow area would be located in Section 35, Township 22 North, Range 63 East. A fence, berm, or signs would be established at the borrow area entry to prevent public access. Upon completion of construction, the borrow area(s) would be recontoured and reclaimed in accordance with BLM regulations.

The mineral material sale area would be located immediately adjacent to White Pine County Road 27. Several routes may be used to transport mineral materials from this location to the plant site. The most likely of these routes are (1) either south along White Pine County Road 27 to White Pine County Road 24 (Monte Neva Road) to U.S. Highway 93 and north to the Proposed Action access road, or (2) north along White Pine County Road 27 to White Pine County Road 18 to U.S. Highway 93 and south to the Proposed Action access road.

2.2.3.7 Connected Actions

Certain third-party infrastructure projects are closely connected to the construction and operation of the Station, but they are not part of the Proposed Action. Two major infrastructure projects identified by WPEA that have been proposed or are being considered by other parties include upgrading and operating the NNR from the Union Pacific Railroad interchange at Shafter, Nevada, to the Rail Spur ROW, and constructing a portion or all of the SWIP 500-kV transmission line. Because of their independent nature, NNR upgrade and operation and the SWIP are also cumulative projects, which are analyzed in Chapter 4.



- Legend**
-  Thirtymile Substation ROW
 -  Thirtymile Substation ROW Access
 -  Existing Falcon-Gonder 345-kV Transmission Line
 -  Connected Action - SWIP Transmission Line
 -  Duck Creek to Thirtymile Transmission Line ROW
 -  Falcon-Gonder 345-kV Interconnection ROWs

Thirtymile Substation ROW White Pine Energy Station Project

Figure 2-15

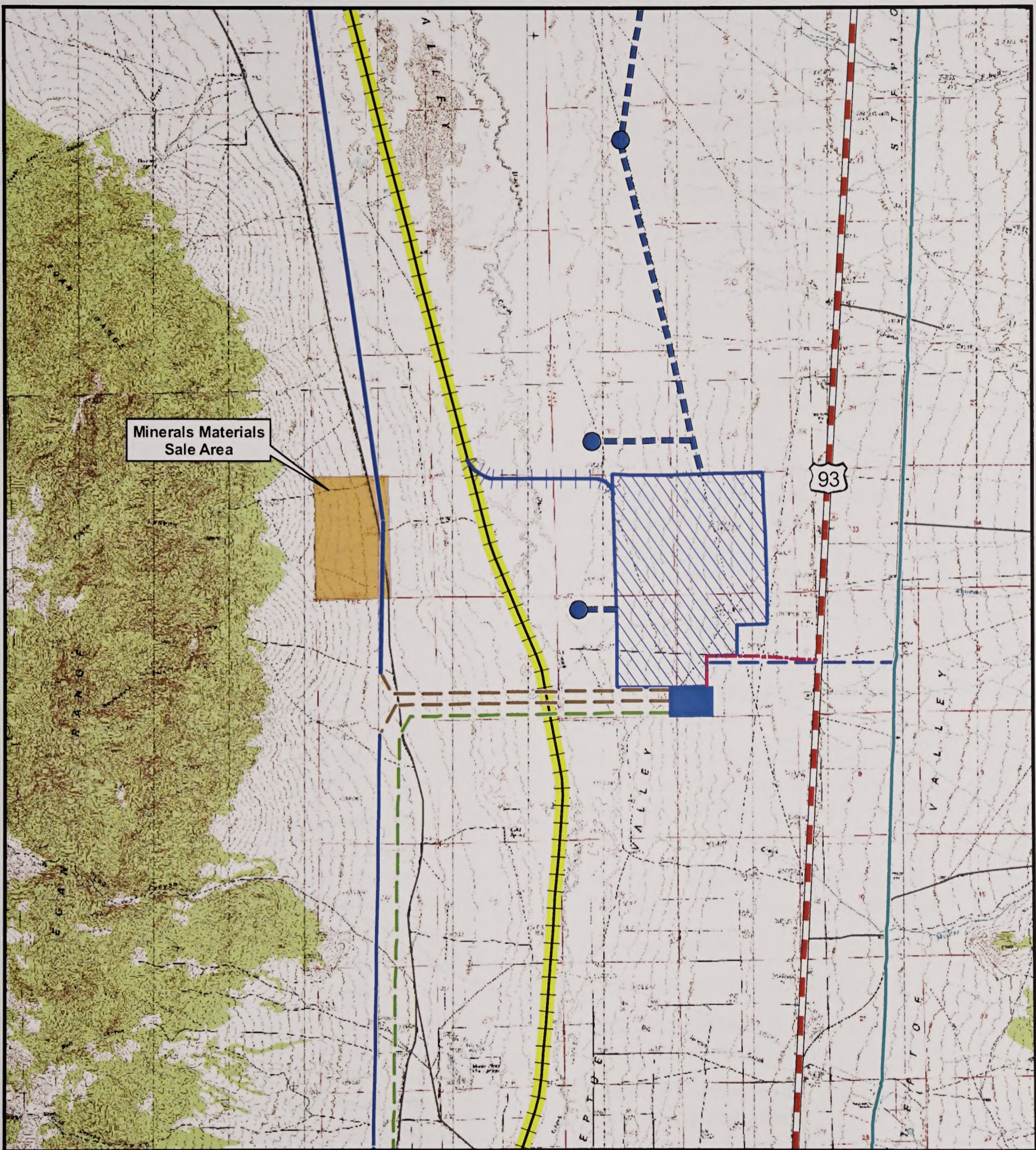





Minerals Materials Sale Area

93











Project Area

NEVADA

-  Minerals Materials Sale Area
-  Existing Distribution Line
- Connected Action**
-  SWIP Transmission Line
-  NNR Upgrade

Proposed Action Project Features

-  Proposed Well Site
-  Proposed Water Pipeline/Distribution Line
-  Proposed Rail Spur
-  Duck Creek to Thirtymile ROW
-  SWIP 500kV Interconnection ROWs
-  Proposed Electric Distribution Line
-  Proposed Access Road
-  Proposed Substation Site
-  Proposed Power Plant Site

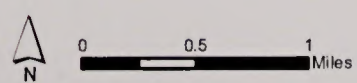

**Minerals Materials Sale Area
White Pine Energy Station Project**

Figure 2-16



[Faint, illegible text, likely a title or description of the diagram above.]



2.2.3.7.1 Rehabilitation and Operation of Nevada Northern Railway

The NNR is an existing railroad that runs from Cobre, Nevada, to Ely, Nevada, and is currently inactive from Cobre to a point near McGill, Nevada. The City of Ely and the White Pine Historical Railroad Foundation own and plan to rehabilitate the NNR. The City of Ely is proposing to upgrade approximately 109.9 miles of NNR track and corridor (collectively referred to as the NNR Rail Line in this discussion) from milepost (MP) 18.5 in Shafter at the Union Pacific mainline connection to MP 128.4 at McGill Junction.

The rail spur for the proposed White Pine Energy Station power plant would connect to the upgraded NNR at approximately MP 103 under the Proposed Action. The portion of the NNR south of the Alternative 1 rail spur (see Section 2.3.3.7, *Connected Actions*) is not considered part of the connected action because Station-related coal trains will not travel further south than the Alternative 1 rail spur.

Upgrading the rail line to Federal Railroad Administration Class 3 Track would permit use of the NNR for commercial freight service and allow for the expansion of tourist operations on the NNR north to Shafter (David Evans and Associates, Inc., 2002).

General and specific track restoration activities that would be required to upgrade the NNR Rail Line are described in detail in *Nevada Northern Railroad Project Engineering Study and Cost Estimate* (R. L. Banks & Associates, Inc., 2002). These activities would occur whether or not the White Pine Energy Station is constructed and would all take place within the existing NNR ROW owned in fee by the City of Ely, which is

generally 200 feet wide. General restoration activities include the following:

- Replace the existing 60-pound rails with 115-pound rails
- Replace approximately 42,000 crossties
- Dump and distribute ballast material
- Surface alignment of the entire NNR Rail Line
- Remove existing vegetation within the NNR Rail Line and treat chemically to retard future growth

Between Shafter and the Proposed Action rail spur site, 16 corrugated metal pipe culverts and 6 concrete box culverts would need to be replaced or repaired, 19 rail/road crossings would need reconstruction, and 12 sidings should be replaced with heavier rail.

It is anticipated that rehabilitation of the NNR would take one or two construction seasons to complete.

The purposes and needs identified by the City of Ely in their proposal to restore and operate the NNR Rail Line are as follows (David Evans and Associates, Inc., 2002):

- Reinststate freight rail operations and expand tourist excursions on the NNR
- Improve freight rail service in the region
- Generate revenue for the City of Ely
- Provide a connection to the Union Pacific mainline at Shafter
- Create job opportunities in the surrounding community
- Promote the economic diversification of the region

The City anticipates that the customer base will include the oil industry in northern Nye County, the mine at Ruth, local businesses, and the potential for tourist excursions and

special events. The upgraded NNR Rail Line also would provide access to the new rail spur and ROW for trains delivering coal to the proposed White Pine Energy Station power plant. WPEA would negotiate a lease with the City of Ely for the use of the upgraded section of track by coal trains. The projection includes formation of a Railroad Redevelopment District, renovation of the track to Class 3 status, hauling coal between Shafter and the Rail Spur ROW for the electrical power plant, and providing rail freight service for additional local clients as well as those industries attracted to the county because rail freight service is available.

Quadra Mining Ltd. also may consider using the upgraded NNR Rail Line rather than trucks to ship ore from the Robinson Mine, which is west-northwest of Ely. Quadra currently operates Robinson Mine (Quadra Mining Ltd., 2005b). They are the largest private employer in White Pine County. The mine produces copper and gold. Quadra is making capital investments to produce molybdenum as well. Concentrate from the mine is shipped by truck to Wendover and loaded onto Union Pacific trains for delivery to customers. In 2005, the mine produced 126 million pounds of copper and 85,000 ounces of gold, and in 2006, production was projected to decrease slightly to 115 million pounds of copper and 55,000-60,000 ounces of gold (Quadra Mining Ltd., 2005a).

2.2.3.7.2 Southwest Intertie Project

The Southwest Intertie Project is the construction, operation, maintenance, and termination of the Southwest Intertie 500-kV electrical transmission line project (SWIP). The BLM prepared and published an FEIS under the NEPA process for the SWIP in 1993. In December 1994, the BLM issued a Record of Decision and Idaho Power Company was granted a ROW for a 500-kV electric transmission line from the Midpoint

Substation in Idaho to a new electric substation to be located in Clark County, Nevada, commonly known as the SWIP. In 2005, LS Power Associates, L.P., which owns WPEA, secured an exclusive option to purchase the SWIP ROW from Idaho Power Company, and thereafter assigned that option to its affiliate Great Basin Transmission, LLC. The SWIP transmission line ROW passes through White Pine County near the sites that WPEA is considering for the Station and includes a new electric substation near Robinson Summit in White Pine County. (If constructed prior to the Station, this SWIP substation would likely preclude the need for construction of the Thirtymile Station as part of the project.)

The SWIP transmission line ROW on public land is 200 feet wide (100 feet on each side of center) and approximately 406 miles long. The SWIP also includes three 80-acre substation sites, two 15- to 20-acre series compensation station sites, and eight 0.25-acre microwave communication sites. Within the 200-foot-wide transmission line ROW, a fiber optic communication cable within the grounding shield wires would be installed on top of the transmission line towers.

The 406-mile-long ROW grant extends from the Midpoint Substation in Midpoint, Idaho, to the Harry Allen Substation in Clark County, Nevada and passes through the White Pine Energy Station project area. The Record of Decision recognized that the SWIP transmission line could be developed in segments or phases.

Depending on the ultimate capacity of the Station, the customers for the power produced by the Station, and other factors such as the development of wind generation projects in White Pine County, construction of a portion of the SWIP or a similar transmission project may be required. WPEA is not requesting approval for the

construction of transmission facilities other than those specifically described for the Station in Section 2.2.3.2, *Electric Transmission Facilities ROW*. Components of the SWIP and Station would be interconnected as described in Section 2.2.3.2, *Electric Transmission Facilities ROW*. Figure 1-2 shows the location of the SWIP in Idaho and Nevada, and Figure 2-1 shows the interconnection of the SWIP with the Proposed Action.

2.2.4 Construction Activities

2.2.4.1 Overview

The primary components of the Proposed Action that would be constructed include the power island, coal storage and handling, waste handling and disposal, evaporation pond, electric transmission facilities, water supply system, rail spur, and access roads. The Station would include up to three generating units, which may be constructed concurrently or in stages. Because WPEA wants to have the flexibility to construct the Station in up to three phases to align with and meet future market demands, the following text discusses several construction sequences and scenarios depending on the number of generating units constructed.

2.2.4.2 Construction Schedule and Work Force

Construction of the Station is expected to commence in late 2008, subject to receiving all regulatory approvals and securing financing. Table 2-2 depicts the estimated average number of construction workers per month to

construct the Station under three possible scenarios. These scenarios vary depending on the number of generating units to be constructed, as well as their construction sequence. For example, under Scenario 2, it is estimated to take approximately 46 months to complete the construction of the first generating unit and associated infrastructure. The work force required to construct the first generating unit and infrastructure is expected to average approximately 600 construction workers, with a peak employment of approximately 1,200 workers. Table 2-2 (Scenario 2) shows the estimated average number of construction workers per month, assuming construction of a single generating unit.

If a second generating unit is constructed concurrently with the first generating unit (see Table 2-2, Scenario 1), the peak work force number is expected to stay roughly the same (1,200 workers) but with the peak period of employment lasting for a longer period of time and the average work force increasing to approximately 760 workers. For example, construction of a second generating unit concurrently with the first unit would generally add another 6 to 9 months of construction activity on the site, for a total of approximately 52 to 55 months to construct the first and second units. On the other hand, if construction of the second generating unit were not started until after the first unit was complete (see Table 2-2, Scenario 2), construction of the second unit would likely require an additional 44 months of construction activity, average approximately 500 workers, and peak at the same (1,200 workers) work force as for the first unit.

TABLE 2-2

Estimated Average Number of Construction Workers per Month for Three Construction Scenarios

Month	Scenario 1		Scenario 2			Scenario 3
	Units 1 & 2 (concurrently)	Unit 3 (later)	Unit 1	Unit 2 (later)	Unit 3 (later)	Units 1, 2, & 3 (concurrently)
	Construction Employment		Construction Employment			Construction Employment
1	50	20	50	20	20	50
2	100	50	100	50	50	100
3	200	120	170	120	120	200
4	250	130	220	130	130	250
5	300	150	250	150	150	300
6	320	160	300	160	160	320
7	340	170	320	170	170	350
8	360	180	340	180	180	400
9	380	190	360	190	190	425
10	400	200	380	200	200	475
11	500	250	400	250	250	550
12	600	300	450	300	300	650
13	700	350	500	350	350	750
14	800	400	550	400	400	850
15	850	450	600	450	450	900
16	900	500	675	500	500	950
17	950	550	750	550	550	1000
18	1000	600	825	600	600	1100
19	1100	700	900	700	700	1140
20	1120	720	950	720	720	1180
21	1140	740	1000	740	740	1200
22	1160	760	1050	760	760	1200
23	1180	830	1075	830	830	1200
24	1200	950	1100	950	950	1200
25	1200	1050	1150	1050	1050	1200
26	1200	1150	1200	1150	1150	1200
27	1200	1200	1200	1200	1200	1200
28	1200	1200	1200	1200	1200	1200
29	1200	1200	1200	1200	1200	1200
30	1200	1100	1200	1100	1100	1200
31	1200	900	1150	900	900	1200

TABLE 2-2

Estimated Average Number of Construction Workers per Month for Three Construction Scenarios

Month	Scenario 1		Scenario 2			Scenario 3
	Units 1 & 2 (concurrently)	Unit 3 (later)	Unit 1	Unit 2 (later)	Unit 3 (later)	Units 1, 2, & 3 (concurrently)
	Construction Employment		Construction Employment			Construction Employment
32	1200	770	1100	770	770	1200
33	1200	750	900	750	750	1200
34	1150	730	770	730	730	1200
35	1100	710	750	710	710	1200
36	1050	510	730	510	510	1200
37	1000	330	710	330	330	1200
38	950	260	510	260	260	1200
39	930	230	330	230	230	1200
40	910	190	260	190	190	1200
41	890	140	230	140	140	1200
42	840	120	190	120	120	1200
43	790	70	140	70	70	1150
44	740	20	120	20	20	1125
45	640	—	70	—	—	1075
46	540	—	20	—	—	1025
47	440	—	—	—	—	975
48	340	—	—	—	—	950
49	240	—	—	—	—	925
50	140	—	—	—	—	900
51	90	—	—	—	—	850
52	40	—	—	—	—	800
53	—	—	—	—	—	750
54	—	—	—	—	—	700
55	—	—	—	—	—	600
56	—	—	—	—	—	450
57	—	—	—	—	—	350
58	—	—	—	—	—	250
59	—	—	—	—	—	150
60	—	—	—	—	—	100
61	—	—	—	—	—	50
Average Monthly	760	502	618	502	502	925
Peak	1,200	1,200	1,200	1,200	1,200	1,200

As noted previously, WPEA wants to have the flexibility to construct the Station in up to three phases. These potential construction scenarios are as follows:

- **Scenario 1.** Construct Units 1 and 2 concurrently, followed by some delay on Unit 3. Construction requirements and effects would be very similar if this scenario was reversed such that construction of Unit 1 occurred first, then a delay occurred and Units 2 and 3 are constructed concurrently. As such these two options are treated as a single scenario.
- **Scenario 2.** Construct Unit 1 followed by a delay, construct Unit 2 followed by a delay, then construct Unit 3.
- **Scenario 3.** Construct all three units concurrently with 6 to 9 months added to the schedule for the second and third units each.

For the purposes of analyzing the potential broad range of construction-related effects in this FEIS, it is assumed that the delay between construction phases in Scenarios 1 and 2 would be at least 3 years. Scenario 1 was selected as the worst-case analysis.

Normal construction hours are expected to fall between 6 a.m. and 6 p.m. on weekdays. However, these hours may require adjustment because of scheduling constraints and other time-sensitive matters.

2.2.4.2.1 Construction Worker Housing

Peak employment during construction of the Station would reach approximately 1,200 workers. In order to meet the anticipated housing demands associated with the construction work force, WPEA would implement the following housing strategies:

- Provide onsite construction worker housing for up to 1,000 workers within

the power plant site by utilizing a combination of modular dormitory style housing and RV hook-ups (see discussion in Section 2.2.3.1.6, *Construction Worker Housing*).

- Establish one or more temporary housing areas in Ely to accommodate up to 300 workers and their families utilizing modular apartments and/or modular homes.
- Encourage the employment of local residents and subcontractors.

Assuming that up to 300 construction workers would come from the local work force (that is, White Pine County or surrounding area), WPEA's proposed housing strategy would account for up to 1,600 workers (300 existing local families, 300 new families living in Ely, and 1,000 living onsite) versus the estimated peak work force of 1,200 workers. The reason for this "oversizing" in planning is because it is not possible to predict the exact make-up of the work force over the estimated 4- to 6-year construction period. The use of modular housing and the RV hook-ups would allow WPEA to install housing capacity as needed as the work force increases over the construction period.

WPEA plans to work closely with the City of Ely to identify one or more areas suitable for temporary housing in or adjacent to Ely. Selection of the site(s) would be based on the availability of large tracts of land and the availability of existing infrastructure to minimize the impact on the City's utilities. WPEA would develop (through a subcontractor) housing facilities to accommodate up to 300 construction workers who would generally: (1) be working on the Station over a prolonged period, and (2) have a family that relocates with them. WPEA expects that the housing

to be developed within Ely would be modular apartments and modular homes placed on concrete slabs. During the transition from construction to operations, permanent workers may live in the construction worker housing until permanent residences are established. Otherwise, upon the completion of construction, the modular facilities would be removed and the land could be used for future development in Ely.

2.2.4.3 Power Plant Construction

Construction activities at the power plant would include the following major phases:

- Surveying, site clearing, site preparation, and mobilization
- Foundation and below grade utilities construction
- Building and equipment installation
- Start-up, commissioning, and testing
- Site cleanup and project closeout

2.2.4.3.1 Surveying, Site Clearing, Site Preparation, and Mobilization

The first phase of construction would include surveying work, site clearing, site preparation, and mobilization. This work would include the use of heavy, diesel-powered equipment such as scrapers, bulldozers, dump trucks, and front-end loaders. The site preparation work would provide necessary grading for the plant facilities, establish access roads and parking areas for construction workers, and establish construction lay-down areas on the site. Site mobilization activities would include the delivery and setup of office trailers, warehouses, mechanic shops, onsite housing facilities, and installation of construction utilities (water, power, sewer, phone) and security facilities (guardhouse, fencing).

Earth and Rock Materials

Earth and rock materials would be used during site preparation and throughout the construction process. The potential offsite borrow area for sand, gravel, and aggregate materials was described in Section 2.2.3.6.2, *Mineral Material Sale*, and depicted in Figures 2-1 and 2-17. In addition, borrow areas may be established on the power plant site for the supply of earth and rock materials. The earth and rock materials would likely be transported to the place of use by truck.

Construction Utilities

An adequate and reliable source of construction water would be necessary to support construction activities, including the need for potable water, sanitary facilities, fire protection, concrete production, and dust control. The primary source of construction water would be provided through a partial construction of the water supply system. It is anticipated that two wells, and the associated ancillary facilities including pipelines, electric distribution lines, and water storage tanks, would be able to adequately provide the water needs during the construction period.

An adequate and reliable source of construction power would be necessary to support construction activities including the construction worker housing facilities, water supply system, construction trailers, and start-up, testing, and commissioning of the Station. The primary source of construction power would be through an interconnection to the 69-kV distribution line located just east of U.S. 93. A 69-kV distribution line would be constructed from the existing 69-kV distribution line to the power plant site as early as practical during the construction period. This electric distribution line would be

constructed in a similar fashion to the electric distribution line for the water supply system as described in Section 2.2.4.5, *Water Supply System Construction*. Prior to the availability of power from this interconnection, onsite construction power would be provided by diesel-driven generators. An estimated 10 MW of electric power would be required to meet peak demands during construction, excluding electric power requirements for the start-up, testing, and commissioning of the Station, which would be provided through the Station's interconnection to the high-voltage transmission system.

Security Facilities

Construction security would consist of a security office to provide space and facilities for security personnel, a guardhouse for security personnel at the entrance to the power plant site, security fencing around the power plant site, and security vehicles to patrol the site. Security personnel would be trained and uniformed with the primary responsibility of controlling access to the power plant site. All construction personnel would be issued identification badges that would be verified on entry and exit from the power plant site.

2.2.4.3.2 Foundation and Below Grade Utilities

The next major step would be to begin major foundation work and installation of below grade piping and electrical utilities. This work would involve heavy equipment such as excavators, dozers, loaders, concrete trucks, mixers, vibrators, pumps, trench digging equipment, and welding equipment. A batch plant would be located onsite for concrete production.

Underground piping and electrical installation would begin in areas at or near foundations prior to the foundations being

established. Foundations would be established including excavation, formwork, installation of rebar, anchor bolts and embeds, pouring of the concrete, and the concrete finish work.

2.2.4.3.3 Building and Equipment Installation

As foundation work is completed, erection of steel and equipment would begin. This would require the use of multiple cranes and equipment deliveries by trains and trucks.

2.2.4.3.4 Start-up and Commissioning

Upon completion of the major components of the power island, various subsystems would be tested, started up, commissioned, and prepared for operations. Initially, devices and pieces of equipment within a subsystem would undergo testing to verify they are in good condition and ready to be put in service. These tests may include insulation resistance, motor rotation checks, relay calibration, vibration readings, loop testing, functional testing, and instrument calibration. Upon completion of testing, the subsystem would be put into initial operations and closely monitored for any problems. Minor adjustments and subsystem flushes would be performed as necessary during initial operations including cleaning pump screens, checking and adding lubricants, tightening packing glands, etc. The Station would go through an extensive testing and commissioning regimen before becoming commercially operational.

Near the end of project construction, steam would be generated in the boiler and released to the atmosphere to clean the steam piping. This process typically occurs over several weeks and is called "steam blowout." Approximately 30 to 50 steam blowouts, each lasting several minutes, are required for a typical plant before the boiler is operated.

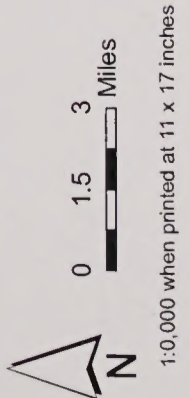
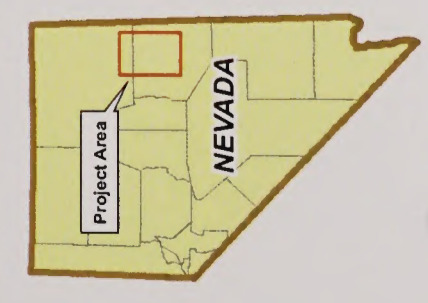
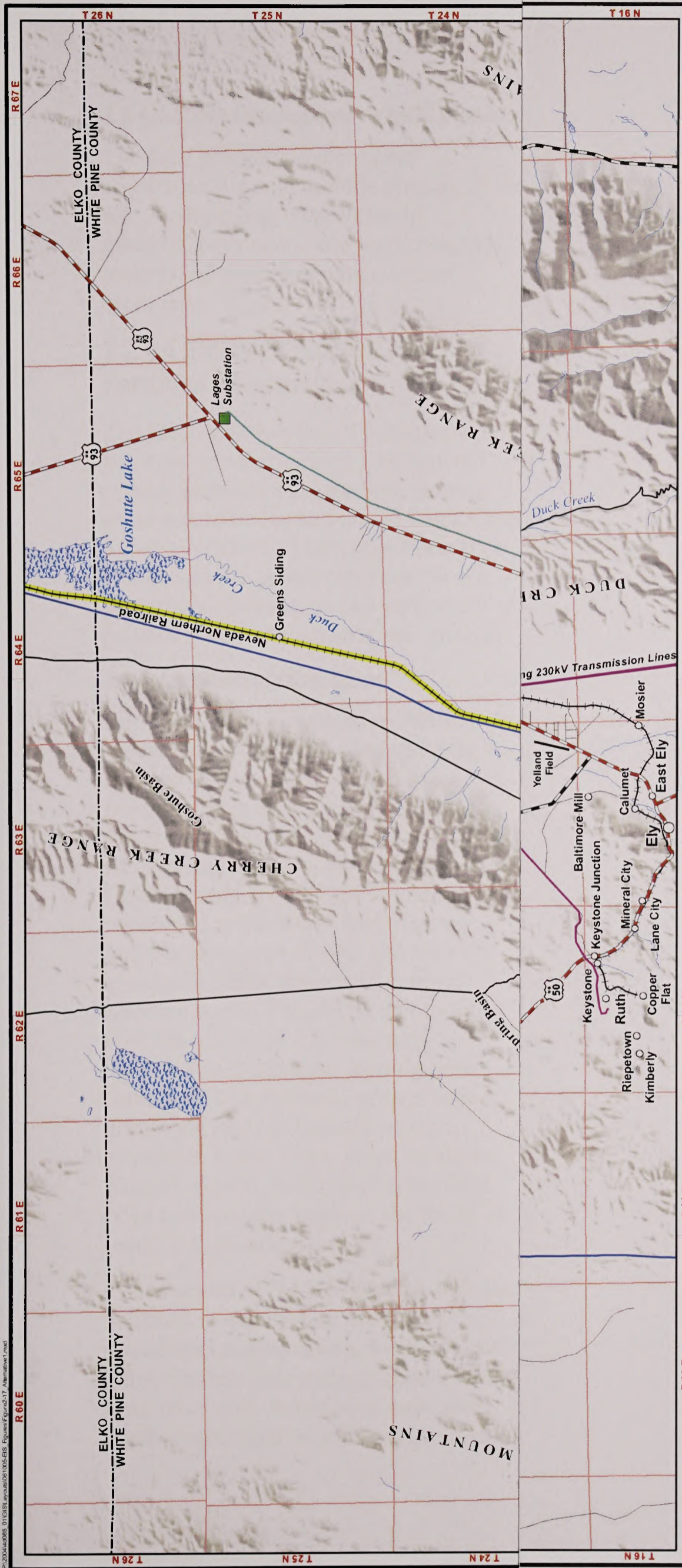

- Existing Electrical Features**
- Existing Substation
 - Existing Transmission Line
 - Existing Distribution Line
- Surface Water**
- Perennial Stream or River
 - Wetland
- Connected Action**
- SWIP Transmission Line
 - NNR Upgrade
- Common Project Features**
- Minerals Materials Sale Area
 - Moriah Ranches Seeding Project

- Alternative 1 Project Features**
- Proposed Well Site
 - Proposed Water Pipeline/Distribution Line
 - Proposed Rail Spur
 - Proposed Transmission Line
 - Proposed Electric Distribution Line
 - Proposed Access Road
 - Proposed Substation Site
 - Proposed Power Plant Site

Alternative 1 White Pine Energy Station Project

Figure 2-17

constructed in a similar fashion to the electric distribution line for the water supply system as described in Section 2.2.4.5, *Water Supply System Construction*. Prior to the availability of power from this interconnection, onsite construction power would be provided by diesel-driven generators. An estimated 10 MW of electric power would be required to meet peak demands during construction, excluding electric power requirements for the start-up, testing, and commissioning of the Station, which would be provided through the Station's interconnection to the high-voltage transmission system.

Security Facilities

Construction security would consist of a security office to provide space and facilities for security personnel, a guardhouse for security personnel at the entrance to the power plant site, security fencing around the power plant site, and security vehicles to patrol the site. Security personnel would be trained and uniformed with the primary responsibility of controlling access to the power plant site. All construction personnel would be issued identification badges that would be verified on entry and exit from the power plant site.

2.2.4.3.2 Foundation and Below Grade Utilities

The next major step would be to begin major foundation work and installation of below grade piping and electrical utilities. This work would involve heavy equipment such as excavators, dozers, loaders, concrete trucks, mixers, vibrators, pumps, trench digging equipment, and welding equipment. A batch plant would be located onsite for concrete production.

Underground piping and electrical installation would begin in areas at or near foundations prior to the foundations being

established. Foundations would be established including excavation, formwork, installation of rebar, anchor bolts and embeds, pouring of the concrete, and the concrete finish work.

2.2.4.3.3 Building and Equipment Installation

As foundation work is completed, erection of steel and equipment would begin. This would require the use of multiple cranes and equipment deliveries by trains and trucks.

2.2.4.3.4 Start-up and Commissioning

Upon completion of the major components of the power island, various subsystems would be tested, started up, commissioned, and prepared for operations. Initially, devices and pieces of equipment within a subsystem would undergo testing to verify they are in good condition and ready to be put in service. These tests may include insulation resistance, motor rotation checks, relay calibration, vibration readings, loop testing, functional testing, and instrument calibration. Upon completion of testing, the subsystem would be put into initial operations and closely monitored for any problems. Minor adjustments and subsystem flushes would be performed as necessary during initial operations including cleaning pump screens, checking and adding lubricants, tightening packing glands, etc. The Station would go through an extensive testing and commissioning regimen before becoming commercially operational.

Near the end of project construction, steam would be generated in the boiler and released to the atmosphere to clean the steam piping. This process typically occurs over several weeks and is called "steam blowout." Approximately 30 to 50 steam blowouts, each lasting several minutes, are required for a typical plant before the boiler is operated.

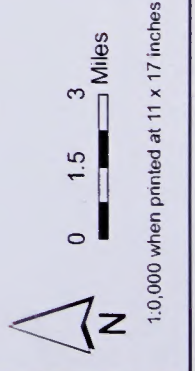
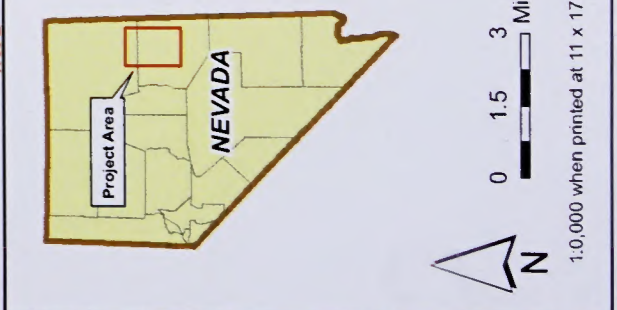

- Existing Electrical Features**
- Existing Substation
 - Existing Transmission Line
 - Existing Distribution Line
- Surface Water**
- Perennial Stream or River
 - Wetland
- Connected Action**
- SWIP Transmission Line
 - NNR Upgrade
- Common Project Features**
- Minerals Materials Sale Area
 - Moriah Ranches
 - Seeding Project

- Alternative 1 Project Features**
- Proposed Well Site
 - Proposed Water Pipeline/Distribution Line
 - Proposed Rail Spur
 - Proposed Transmission Line
 - Proposed Electric Distribution Line
 - Proposed Access Road
 - Proposed Substation Site
 - Proposed Power Plant Site

**Alternative 1
White Pine Energy Station Project**

Figure 2-17



2.2.4.3.5 Site Cleanup and Project Closeout

The final phase of power plant construction would include cleanup of the site, landscaping, completion of miscellaneous tasks, and teardown and removal of temporary construction facilities.

2.2.4.4 Electric Transmission Facilities Construction

The electric transmission facilities would be constructed prior to the startup and commissioning of the Station. Staging areas would be located on the Duck Creek Substation ROW, Thirtymile Substation ROW, and the power plant site for the placement of materials and equipment to be used during the construction process.

2.2.4.4.1 Transmission Lines

Prior to starting construction, WPEA would survey the ROW and stake the location of the electric transmission facilities. This would include marking tower locations, anchor sites, access roads, batch plant locations, and substation areas. Cultural resource surveys would then be conducted at the tower footprints to identify resources, if any, and resource avoidance plans. Results of cultural resource surveys would be incorporated with the results of other resource investigations that have already been conducted (for example, greater sage-grouse surveys) to identify resource avoidance areas. These areas would be flagged, signed, or marked in the field prior to beginning work on the ROW or roads in the marked area.

Construction of the electric transmission facilities would require the use of numerous existing access roads to transport materials and equipment to and from the ROW. In addition, new spur roads would need to be constructed along

with a new centerline travel route. Establishing access to and along the ROW would be the first construction activity and, in many cases, would occur simultaneously with vegetation removal and trimming. Vegetation removal and trimming procedures would be determined in consultation with the BLM based on specific site conditions and be consistent with BLM requirements on public land.

Batch plants occupying 3 acres each would be located within the transmission line ROW, on the Duck Creek Substation ROW, and on the Thirtymile Substation ROW. The plants would be used to produce concrete for foundations. After the tower locations have been identified and cleared for construction, foundations would be constructed. Assembly of the tower would be completed and the tower placed on its foundation. Helicopters may be used to install towers in areas with rough terrain. The conductor and shield wire would then be placed by installing wire pull ropes, pulling conductors and shield wires with ground-based equipment, sagging and tensioning the conductors and shield wires, and connecting them to the towers. The temporary construction area around each tower is generally expected to be 1 acre. Pulling and tensioning sites of approximately 1.8 acres each would be required at approximately 1.5-mile intervals. After construction, cleanup crews would remove surplus material, equipment, construction debris, etc. from the ROW. Access roads would be maintained or restored following construction in a manner approved by the BLM.

2.2.4.4.2 Substations

Each substation site would be graded and compacted to provide a construction surface for the new equipment. Appropriate drainage features (for

example, ditches, culverts) would be installed as necessary. Security fencing would be installed around the perimeter of each substation site. Concrete footings and foundations would be constructed to support the structures and equipment. Conduit and/or a trench system would be installed for electrical control cables. A ground grid would be installed to ensure that all equipment, structures, and fence additions are properly grounded. Gravel would be installed over the substation site.

An air conditioned control building would be installed to house the relay and control panels, AC and DC load centers, a battery bank, and communications equipment. Steel structures would be erected to support switches, electrical bus work, instrument transformers, lightning arrestors, and termination equipment for transmission lines. Oil spill containment basins would be installed around major oil-filled equipment (for example, around transformers). Control cables would be pulled from the panels in the control building to the appropriate equipment through the conduit and/or trench system.

2.2.4.5 Water Supply System Construction

Part of the water supply system would be constructed early in construction to support construction activities. The entire water supply system would be constructed prior to the start-up and commissioning of the Station.

Construction of the water supply system would involve the installation of production wells, underground pipeline, aboveground electric distribution lines, buried power feeds to each well, telecommunication lines to each well, and the installation of monitoring wells. Prior to starting construction, WPEA would survey the ROW and stake the location of

the water supply facilities. This would include marking well areas, electric distribution line pole locations, and access roads. Resource avoidance areas, if any, would be flagged, signed, or marked in the field prior to beginning work on the ROW or roads in the marked area. Staging areas would be located on the power plant site and the Staging Area ROW for the placement of materials and equipment during the construction process.

Construction of the water supply system would require the use of existing access roads to transport materials and equipment to and from the ROW. In addition, a new access road would be constructed utilizing overland construction techniques (crush and roll) generally following the centerline of the water supply system linear facilities. Establishing access to and along the ROW would be the first construction activity.

2.2.4.5.1 Production Wells

After access to the well area has been established and the well area has been cleared, the well would be drilled and cased. The hole for the well vault would be excavated and the vault would be put into place. Once the vault is in place, the electrical equipment and well pump would be installed and the piping connected. Equipment involved would include drilling rigs, excavators, dozers, loaders, and cranes. Mud and test-drilling water associated with and removed during ground water well drilling would be disposed of according to state and federal regulations.

2.2.4.5.2 Water Pipeline

Trenching (open-cut) construction methods would be used for placement of the water pipeline. The water pipeline would be buried to a sufficient depth to be below the frost line. Where crossing a stream, installation would be at a depth

well below potential streambed scour, erosion, and exposure. The water pipeline would not cross Duck Creek.

The water pipeline trench would be backfilled with soils removed to install the water pipeline, the original grade of the land restored, and disturbed areas reclaimed according to reclamation BMPs in Appendix C. Equipment used to install the pipeline may include excavators, dozers, loaders, and other vehicles to transport material and equipment.

2.2.4.5.3 Electric Distribution and Communication Lines

After the pole locations have been identified and cleared for construction, holes would be excavated for the placement of the poles. The pole components would be delivered and assembled at each pole site for installation. The pole would be set in the excavated hole and compacted native soil, imported backfill, or concrete would be used to backfill. Guy wires and anchors would be installed at certain pole locations as necessary. The conductor and shield wire would be strung from the poles using wire pull ropes and ground based equipment. The conductor and shield wire would then be tensioned and fastened to the poles with insulators. Communications lines would either be placed underground in the trench with the water pipeline or overhead on the electric distribution lines to provide for remote operation of each well. Wireless communication systems may also be used.

2.2.4.5.4 Monitoring Wells

After access to the well area has been established and the well area cleared, the monitoring well would be drilled and cased. The monitoring wells would be constructed with screen intervals sufficient to monitor both shallow (unconfined) ground water levels that could influence

spring discharge, and deeper ground water that is more representative of existing water supply wells completed in the basin-fill aquifer system in Steptoe Valley. Equipment involved would include drilling rigs, excavators, dozers, loaders, and cranes. Mud and test-drilling water associated with and removed during ground water well drilling would be disposed of according to state and federal regulations. Appendix G provides detail on the ground water monitoring program and mitigation actions, and depicts proposed monitoring well locations in Figure G-1.

2.2.4.6 Rail Spur Construction

Prior to starting construction, WPEA would survey the ROW and stake the location of the rail spur. Resource avoidance areas, if any, would be flagged, signed, or marked in the field prior to beginning work on the ROW. Access to the Rail Spur ROW would be from the existing NNR or the power plant site.

Initially, the ROW would be cleared and the maintenance/access road and rail bed, including subgrade, culverts, and drainage structures, would be constructed. The rail would be installed, including the placement of ballast, and installation of crossties, rail, and other track material. After construction, cleanup crews would remove surplus material, equipment, construction debris, etc. from the ROW.

Section 2.2.3.4, *Rail Spur ROW*, describes the bridge type that would be used to cross Duck Creek to minimize impacts to wetlands and to maintain creek flows. Section 2.5.6, *Alternative Rail Spurs*, describes the evaluation of alternatives and selection of the preferred rail spur crossing of Duck Creek that would have the least effect on wetlands and wildlife.

Section 2.5.7, *Alternative Structure*

Designs for Crossing Duck Creek, describes structures evaluated for crossing Duck Creek.

2.2.4.6.1 Wetland Mitigation

Wetland mitigation measures that will be implemented for wetland acreage filled in connection with construction of the rail spur under the Proposed Action are as follows:

- The wetland mitigation measures will consist of the enhancement or creation of wetlands at a 1.5:1 ratio for each acre of wetland filled.
- The enhancement or creation measures will produce a wetland environment with characteristics similar to other wetlands in the Steptoe Valley region.
- The mitigation will be performed at one or more locations within Steptoe Valley that are mutually agreed upon by the BLM and WPEA. The mitigation may be performed on BLM-administered land, or with consent, on lands controlled by other federal, state, or local governmental entities, or on privately held land.
- WPEA will be responsible for the initial costs of performing the wetland enhancement or creation measures.
- The agreed-upon mitigation measures must be performed within 1 year after the completion of construction of the Proposed Action.
- Once the mitigation measures have been implemented, the area will be revisited twice each year for 2 years to ensure that a majority of the mitigation area sustains the characteristics of a wetland environment.
- If any of the Steptoe Valley wetlands filled by the Proposed Action are

subject to permitting obligations under the federal Clean Water Act Section 404 permitting program, the permit conditions established by the U.S. Army Corps of Engineers will supersede and replace the above-referenced mitigations.

- The specific location in Steptoe Valley, design, and acreage of wetland mitigation will be a component of the (COM) Plan to be approved by BLM.

2.2.4.7 Waste Management

Wastes generated during construction activities would be recycled to the extent practical. Any non-recycled wastes would be collected and disposed of at the onsite solid waste disposal facility or transported to a regional licensed landfill, as applicable. Portable toilets would be provided for onsite sewage handling during construction. Sewage would be pumped out and removed regularly and disposed of in compliance with applicable federal and state pollution control regulations.

2.2.4.8 Safety, Fire Protection, and Contingency Planning Contacts

All applicable federal, state, and local safety regulations (for example, the Occupational Safety and Health Administration) would be observed to ensure safety of onsite personnel. Employees and contractors would be required to report all safety-related incidents, including accidents or injuries, to a designated Station representative. Corrective action would be taken as necessary based on the nature of the reported incident.

All applicable federal, state, and local regulations that pertain to prevention and suppression of fires would be strictly adhered to during Station construction.

Employees and contractors would be advised of their responsibilities under the applicable fire laws and regulations and be required to report any project-related fire to a designated Station representative. If a project-related fire were to occur, immediate actions would be taken by the contractor to respond to the fire. Contingency planning contacts would include the WPEA construction manager, the BLM authorized officer, and the local fire department.

2.2.5 Operation, Maintenance, and Abandonment

2.2.5.1 Power Plant Operation, Maintenance, and Abandonment

2.2.5.1.1 Operation and Maintenance Overview

The Station would be staffed 24 hours per day, 7 days per week, every day of the year. There would be up to approximately 135 full-time employees. Daily activities would include operation of the equipment to produce electricity, handling of coal, disposal of coal combustion byproducts, and routine maintenance of plant equipment. Water needs during operation (up to 5,000 acre-feet annually) would be supplied through water rights permits for eight wells that are held by White Pine County. Figures 2-4a, 2-4b, 2-4c, and 2-4d show a schematic of the coal-fired electric power production process and multiple diagrams of the major facility systems, including boiler emission controls, coal handling systems, and the hybrid cooling system, respectively.

The Station would be operated to serve baseload electric needs, rather than intermediate or peaking electric needs, and would provide approximately 1,590 MW of new baseload coal-fired electric generation

capacity. Baseload facilities typically operate near full capacity 24 hours per day.

Maintenance outages would be scheduled on occasion to inspect, overhaul, and/or replace major equipment and/or components. These outages are anticipated to last up to 8 weeks and may require deliveries of heavy equipment.

The power plant site would be maintained in a good and proper condition for the commercial life of the Station (expected to be 40 years or longer).

2.2.5.1.2 Access and Traffic

Access to the power plant site would be from U.S. 93 via an existing dirt and gravel road that would be widened and paved. Access roads would be constructed as needed on the power plant site to serve the Station's needs.

Vehicle traffic during power plant operations would include employee vehicles traveling to the site, deliveries to the site, and onsite vehicles handling coal and coal combustion byproducts. In addition, the power plant site would routinely receive coal deliveries via rail, lime deliveries via rail or truck, and chemical deliveries via truck.

2.2.5.1.3 Safety, Fire Control, and Contingency Planning Contacts

Public access to the power plant site would be restricted through the use of fencing and security gates. The site would be equipped with numerous fire suppression systems and WPEA would implement industry-recognized standard procedures to minimize fire risks at the site. Examples include:

- Fire water loop and hydrant system around the perimeter of the power island facilities

- Water storage dedicated for fire water purposes
- Chemical fire suppression systems for designated equipment
- Regular compaction of coal piles
- Routine maintenance and repair of equipment

Various fuels and chemicals would be stored and used onsite, including diesel fuel, gasoline, caustics, acids, and ammonia. The power plant site would be designed to include spill-containment dikes and collection systems around chemical storage areas and fuel tanks. Storage and use of chemicals would be in accordance with all applicable federal, state, and local regulations.

2.2.5.1.4 Fencing and Signage

The power plant site would be fenced to restrict public access for safety and security reasons. Signage would be kept to a minimum. During construction, informational signs would mark delivery routes and direct construction traffic. Permanent signage is expected to include a sign along U.S. 93 indicating the name of the Station and signage directing traffic on the power plant site. In addition, posting may be made along the perimeter of the power plant site noting that access to the Station is restricted.

2.2.5.1.5 Abandonment

The Station is anticipated to have a commercial life of 40 years or longer. At the end of its commercial life, decisions would be made regarding continuing to use the power plant site for electric generation purposes or another industrial use. Given that the property would have a significant infrastructure in place (water supply system, rail facilities, electric transmission facilities), WPEA expects that the property would be

ideal for continued use as a site for an electric generation facility or for another industrial use.

Upon determination to permanently cease operation of the Station, the power island would be razed with foundations left in place, and the power plant site restored to a condition suitable for future industrial use. Onsite rail, electric transmission, and water facilities would be left in place to support a future use of the property. The solid waste disposal facility would be capped and reclaimed in accordance with applicable regulations and the Station's solid waste permit.

2.2.5.2 Electric Transmission Facilities Operation, Maintenance, and Abandonment

2.2.5.2.1 Operation and Maintenance Overview

The electric transmission lines and electric substations would be operated 24 hours per day, 7 days per week, every day of the year. The electric substations would be visited regularly to perform routine maintenance and ensure they are functioning correctly. Vegetation would be trimmed on an as-needed basis under and along the Transmission Line ROW to minimize potential interference with the transmission lines.

2.2.5.2.2 Access and Traffic

The electric transmission lines would be inspected from the ground or the air on an annual basis. Ground inspections would be conducted generally following the centerline travel route used for construction. This path may also be used for required maintenance or repair.

Access to the Duck Creek Substation would be from U.S. 93 over an existing dirt road that would be widened and paved for access

to the power plant site. Access to the Thirtymile Substation would be from U.S. 50 over an existing dirt road that would be widened and improved and then a new dirt or gravel road that would extend to the substation site.

2.2.5.2.3 Safety, Fire Control, and Contingency Planning

The electric transmission lines would be designed, constructed, and operated to maintain an acceptable ground level clearance so that people or equipment would not come into contact with the lines. If for some reason an electric line were to contact the ground, a circuit breaker would open and take the line out of service. Repairs would be made as soon as practical to put the line safely back into service.

The electric substations would be fenced to restrict public access. Vegetation would be kept clear from the substation areas to prevent fires from occurring.

2.2.5.2.4 Fencing and Signage

The electric transmission towers/lines would not be fenced. Small signs may be placed at eye level on the towers providing information to the public (emergency contact information, warnings not to climb tower, etc.).

The electric substations would be fenced to restrict access for safety reasons and security. Signage would be minimal and may include a sign stating the substation name and emergency contact information and "no trespassing" postings along the perimeter fencing.

2.2.5.2.5 Abandonment

The electric transmission facilities would become integrated into the electric transmission system that serves Nevada and the Western Electric Coordinating Council.

The facilities would be operated and maintained for the foreseeable future. If at some point these facilities were no longer needed as part of the electric system, then the transmission towers and lines would be removed.

2.2.5.3 Water Supply System Operation, Maintenance, and Abandonment

2.2.5.3.1 Operation and Maintenance Overview

Water would be pumped from the eight production wells and transported to the power plant site via an underground water supply pipeline system. The water supply system would be operated remotely from a control station at the power plant site. The water supply system is expected to require minimal maintenance activities.

2.2.5.3.2 Access and Traffic

The wells would be accessed via existing roads and new access roads (see Section 2.2.4.5, *Water Supply System Construction*) that would be built within the Water Supply System ROW and along the water pipeline and electric distribution lines. Employees from the Station would visit the wells on occasion to ensure they are in good operating condition and secure.

Permanent access along the length of the underground water supply pipeline, electric distribution lines, and communication lines would be provided by a permanent two-track access road (the same road as used for construction but only 10 feet wide). Some maintenance of this road may be required during wet periods to mitigate muddy driving conditions.

2.2.5.3.3 Safety, Fire Control, and Contingency Planning

The wells would be enclosed to restrict public access to these facilities. The water

pipeline would be buried underground and the location would be marked along public roads and other appropriate locations. In the event the water pipeline ruptured, WPEA would isolate that part of the system as soon as possible and make the necessary repairs.

2.2.5.3.4 Fencing and Signage

Each well would be enclosed to restrict access to the well. A sign would be posted at each well, which would provide the well identification and contact information for WPEA. Pipe bollards would be installed above ground around the well vault to prevent vehicular collision with the vault.

The ROW for the water pipeline and electric distribution lines would not be fenced. However, markers would be placed at road crossings and other intervals to mark the location of the underground pipeline and associated facilities.

2.2.5.3.5 Mobile Diesel Generators

For reliability purposes, mobile diesel generators may be available to provide power at times when power cannot be sourced from the Station or through the transmission grid (for example, a fault in the distribution line).

2.2.5.3.6 Ground Water Monitoring Wells

Appendix G provides detail on the operation of the Ground Water Monitoring Program, with proposed monitoring well locations depicted on Figure G-1. The program describes the process for documenting the potential for changes in ground water levels and spring discharge at selected springs that could be caused by the ground water withdrawals for the Station. The program also identifies the reporting requirements and general mitigation actions that would be followed in response to changes in ground water

levels if they are anticipated to adversely affect spring discharge.

Ground water levels would be measured on a frequency that will be determined in coordination with appropriate agencies, using dedicated recording devices in selected monitoring wells. For those monitoring wells without continuous monitoring instruments, water levels would be measured quarterly initially to establish seasonal variations, followed by semiannual or annual measurements after seasonal trends have been established. Monitoring would commence as soon as possible in order to obtain baseline data prior to power plant operations-related ground water extraction.

Selected springs in Steptoe Valley identified in Figure G-1 in Appendix G would be monitored quarterly. Monitoring would consist of measuring flow rate and photo-documenting general site conditions. Monitoring frequency may be reduced later as appropriate to semi-annually or annually. Monitoring of springs would commence as soon as possible in order to obtain baseline data prior to ground water extraction.

Data gathered from ground water monitoring wells and spring monitoring would be provided to the BLM and the Nevada State Engineer quarterly (or semiannually/annually, as appropriate).

2.2.5.3.7 Abandonment

Wells would be maintained in good working condition throughout the Station's life. If, during the Station's life, one or more wells are unable to reliably yield the needed water, such wells may be retired and capped in accordance with all applicable regulations. At the end of the Station's life, WPEA would convey the water supply system to White Pine County and work with the Nevada State Water

Engineer and BLM to complete this process. If for some reason this approach is not viable, then the wells would be capped and abandoned in accordance with all applicable regulations. It is anticipated that the underground water pipeline facilities would be left in place underground if the water supply system were abandoned.

2.2.5.4 Rail Spur Operation, Maintenance, and Abandonment

2.2.5.4.1 Operation and Maintenance Overview

The rail spur would be used for deliveries of coal, other materials, and equipment to the power plant site. Coal trains would enter onto the rail spur and continue onto a rail loop at the power plant site. Each train would be entirely off of the NNR prior to commencement of unloading the train. Portions of the train may extend off the power plant site and onto the rail spur during the unloading process.

The rail spur would be operated and maintained in compliance with all federal, state, and local laws and regulations and vegetation would be controlled to minimize fire hazards.

2.2.5.4.2 Access and Traffic

Traffic on the Rail Spur ROW would be limited to train traffic for deliveries to the Station and occasional vehicular traffic to inspect and maintain the rail spur. Assuming normal operations and assuming the power plant is built to approximately 1,590 MW, approximately 12 trains of coal per week would be required to serve the Station.

2.2.5.4.3 Safety, Fire Control, and Contingency Planning

The rail spur would be maintained in good operational condition and vegetation

would be controlled near the tracks to minimize fire hazards.

2.2.5.4.4 Signage and Fencing

The rail spur would not be fenced, and there would be limited to no signage.

2.2.5.4.5 Abandonment

At the end of the Station's life, WPEA expects that the rail spur would add value to the power plant site for a future industrial use. However, if at some point in time the rail spur were no longer needed, WPEA expects that the rail tracks would be removed from the rail bed.

2.2.6 Enhancement Measure

The Moriah Ranches Seeding Project would be undertaken simultaneously with the start of construction on the White Pine Energy Station to restore an existing seeding on public land in the BLM's Ely District to better ecological condition and increase forage for livestock and cover for wildlife. The seeding project would create at least 200 Animal Unit Months (AUMs) of forage grazing capacity for livestock use once it becomes established and would exceed the AUMs lost because of power plant construction. The seeding project also would be designed to create a habitat mosaic that provides cover for greater sage-grouse and antelope. The project would be located on public land 16 miles north of McGill and immediately west of U.S. 93. The loss of habitat under the Proposed Action would be partially offset by the 700- to 900-acre Moriah Ranches Seeding Project.

The original seeding occurred in 1969 on 770 acres consisting of various soil types using crested wheatgrass. The site is fenced and has been used for spring and late fall grazing (May 1 to June 15 and November 1 to November 30). Because of

drought and other factors, this location has not been grazed for the past 4 years.

Islands of Wyoming big sagebrush cover would be identified for non-disturbance in the Yody-Dewar soil type. The remainder of the vegetation in this soil type would be mechanically treated to restore the understory component of the habitat. The proposed seed mix would include crested wheatgrass, Indian ricegrass, forage kochia (*Kochia prostrata*) (a desirable species as opposed to American kochia [*Kochia scoparia*], an invasive weed), globemallow, and phlox. A sterile annual rye, Ladac alfalfa, or sweet clover would be added to the mix to compete with halogeton until the more desirable seed mix species become established. Seed application would be at 8 to 10 pounds per acre. No more than 1,000 acres would be treated. It is estimated that the total area to be treated would be between 700 and 900 acres.

Treatment would occur in late fall or winter. No seeding or disturbance is anticipated for either the Kunzler-Pern or Hessing-Tulase soil types because of their sodic characteristics. A buffer zone would be established between the Yody-Dewar association and the Kunzler-Pern and Hessing-Tulase association types.

2.2.7 Best Management Practices

Activities under the Proposed Action would consist of two sets of actions that are a specifically directed and integral part of the Proposed Action. The first set of actions would be to comply with the terms and conditions of all ROWs granted by the BLM. The second set of actions would be to follow BMPs typically associated with the construction, operation, and maintenance of power plants, wellfields, pipelines, electric transmission facilities, railroad spurs, and other related facilities in this region of the western United States.

These BMPs would be followed to avoid or minimize the potential for adverse environmental effects resulting from project-related activities.

Appendix C, *Best Management Practices*, describes BMPs for the following:

- Air pollution prevention
- Landscape preservation and impact avoidance
- Erosion and sediment control
- Pipeline and utility corridor construction
- Biological resources
- Cultural resources
- Paleontological resources
- Noxious and invasive weed management
- Reclamation (site restoration and revegetation)
- Visual resources
- Water pollution prevention and monitoring
- Noise prevention
- Hazardous material storage, handling, and disposal, and safety measures
- Socioeconomics

The Construction, Operation, and Maintenance Plan will detail the methods and procedures to be used in the construction of the power plant, electric transmission facilities, water supply system, rail spur, access roads, and ancillary facilities. The Construction, Operation, and Maintenance Plan will incorporate site-specific stipulations, terms, and conditions in order to satisfy all Station-related construction requirements, as well as operational, maintenance, and abandonment/restoration requirements associated with lands administered by the Ely Field Office of the BLM where Station features would be located.

Mitigation measures specific to various resources present in the Station area are described in Chapter 4, *Environmental Consequences*.

Adaptive management plans will be prepared for the ground water and springs monitoring program, the Moriah Ranches Seeding Project, and any vegetation reclamation activities, including wetlands. These plans are referred to in Chapter 4 and will be incorporated in the Plan of Development (POD) or Construction, Operation, and Maintenance (COM) Plan that the BLM will require from WPEA before a Notice to Proceed with construction is granted. Adaptive management plans will describe the following:

- Implementation and effectiveness of monitoring programs
- How and when data will be reported
- What data trigger points or goals have been set
- What processes and actions will be taken if trigger points are reached
- How success will be determined and when goals are reached

2.3 Alternative 1

2.3.1 Description of BLM Actions

BLM actions that would occur under Alternative 1 include granting ROWs necessary for the construction and operation of the Station. The ROW granted by the BLM for the construction and operation of the power plant under Alternative 1 would be for an alternative location. ROWs for the rail spur, water supply system, and portions of the access roads and electric transmission facilities also would have alternative locations. Subsequent to the granting of ROWs, arrangements would be made for the sale of the Power Plant ROW to WPEA.

Reasons presented in Section 2.2.1.2 for the direct sale of the Proposed Action Power Plant ROW to WPEA also applies to the Alternative 1 Power Plant ROW.

It should be noted that approximately 80 acres within the Alternative 1 power plant site are lands that recently were designated (pursuant to the White Pine County Conservation, Recreation, and Development Act of 2006 [Public Law 109-432]) as lands held in trust for the Ely Shoshone Tribe. While the administrative procedures for that land have not yet been worked out, use of that land for Alternative 1 would require an agreement with or lease from the Tribe.

2.3.2 Description of Station Area

Figure 2-17 depicts the Power Plant ROW and locations of prominent Station features associated with Alternative 1. The Power Plant ROW would be located entirely in White Pine County, approximately 38 miles south of the White Pine County/Elko County line and approximately 40 miles west of the Nevada/Utah border. Prominent landmarks in the area of the Power Plant ROW include U.S. 93 and the Schell Creek Range to the east, Duck Creek and the Egan Range to the west, and Goshute Lake to the north. The communities of McGill and Ely are approximately 10 and 22 miles south of the Power Plant ROW, respectively, and Great Basin National Park is approximately 50 miles to the southeast.

The Station would primarily be located in the Steptoe Valley Hydrographic Basin. The electric transmission facilities would extend beyond the Steptoe Valley Hydrographic Basin into the Butte Valley and Jakes Valley Hydrographic Basins. Duck Creek is the primary drainage in Steptoe Valley near the Power Plant ROW. The creek receives runoff from the western flank of the Schell Creek Range

and the eastern flank of the Egan Range and flows north toward Goshute Lake.

Alternative power plant site locations that were evaluated but rejected from detailed evaluation and the rationale for their rejection are described in Section 2.5.3.

2.3.3 Description of Project Features and ROWs

Project features and ROWs associated with Alternative 1 for the Station are described in the following text. ROWs that would be needed for the Station include the Power Plant ROW, Electric Transmission Facilities ROW, Water Supply System ROW, Rail Spur ROW, Access Road ROW, Electric Distribution Line Construction ROW, and the Mineral Material Sale.

Table 2-3 summarizes the estimated acres that would be needed for each ROW and whether the ROWs would be short-term (construction only) or long-term (construction plus the life of the Station). Table 2-3 also summarizes the estimated acres of construction-related and permanent (during operations) land disturbances that would result from the construction and operation of the Station as well as acres of lands that would be reclaimed.

Alternative 1 would require approximately 2,567 acres of ROWs, including 2,521 acres of long-term ROWs for the life of the Station and 46 acres of short-term, construction ROWs (Table 2-3). Subsequent to the granting of ROWs, arrangements would be made for the sale of the 1,330-acre Power Plant ROW to WPEA. This sale would reduce the amount of long-term ROWs needed to 1,191 acres. Table 2-3 also shows estimated acres of temporary and permanent disturbed areas and acres reclaimed for Alternative 1.

2.3.3.1 Power Plant ROW

The equipment and operations to be located on the Power Plant ROW would be the same as described for the Proposed Action. They would include the power island; coal unloading, handling, and storage facilities; a solid waste disposal facility for coal combustion byproducts; an evaporation pond; and potentially carbon capture equipment. The preliminary site plan for the Alternative 1 Power Plant ROW, shown in Figure 2-18, would differ from that of the Proposed Action because of differences in land ownership configuration at the two sites. However, the conceptual rendering of the Station shown in Figure 2-3 and the schematic of the proposed power production process and diagrams of the major facility systems shown in Figures 2-4a, 2-4b, 2-4c, and 2-4d are the same for Alternative 1 as the Proposed Action.

Approximately 1,330 acres would be required for the Power Plant ROW (Table 2-3). Construction and operation of the Station would result in the permanent disturbance of the entire Power Plant ROW for a total of approximately 1,330 acres (Table 2-3). The Power Plant ROW would be located within Sections 28, 29, 32, and 33, Township 20 North, Range 64 East in White Pine County.

Alternative types, locations, numbers, and/or sizes of power plant facilities or needs that were evaluated but rejected from detailed evaluation and the rationale for their rejection are the same as for the Proposed Action and are described in Section 2.5. These include alternative power generating technologies (see Section 2.5.1); alternatives to the proposed generating units, cooling towers, evaporation pond, and total plant water usage (see discussion of an alternative cooling technology in Section 2.5.5); and an alternative power plant site configuration (see Section 2.5.6).

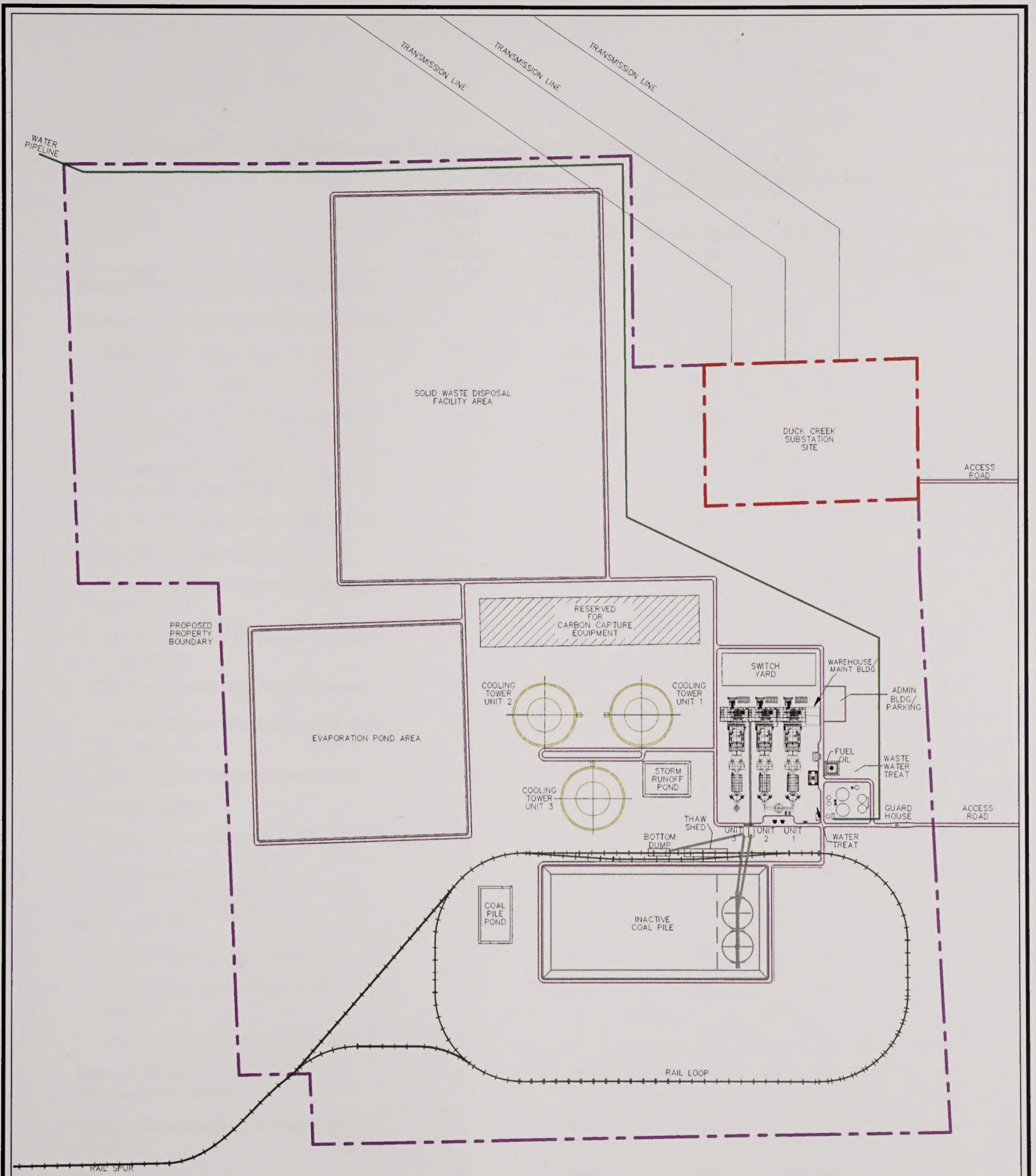

**Preliminary Site Layout
Alternative 1
White Pine Energy Station Project**

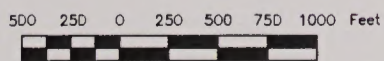

Figure 2-18

TABLE 2-3

Estimated Acres of ROWs and Disturbed and Reclaimed Areas for Alternative 1

	ROWs		Disturbed and Reclaimed Areas		
	Short-Term (acres) ^a	Long-Term (acres) ^b	Construction ^a (acres)	Reclaimed (acres)	Permanent ^c (acres)
Power Plant ROW/Power Plant Site	0	1,330 ^d	1,330	0	1,330
Electric Transmission Facilities ROW					
Duck Creek Substation ROW	0	60	60	0	60
Thirtymile Substation ROW	0	77	77	0	77
Duck Creek to Thirtymile 500-kV Line ROW	0	685	222	176	46
Falcon-Gonder 345-kV Interconnection ROW	0	9	8	7	1
SWIP 500 kV Interconnection ROW	0	285	90	76	14
Water Supply System ROW					
Linear Facilities ROW (30-foot-wide short-term)	29	0	29	29	0
Linear Facilities ROW (40-foot-wide long-term)	0	39	39	29	10
Ground Water Well ROW (8 wells)	0	4	4	3	1
Ground Water Monitoring Well ROW (4 wells)	0	2	2	1	1
Construction Staging Area ROW	2	0	2	2	0
Rail Spur ROW					
Short-Term ROW (30-foot-wide)	10	0	10	10	0
Long-Term ROW (35- to 70-foot-wide)	0	24	24	0	24
Access ROW					
Power Plant ROW Access	0	3	3	0	3
Duck Creek Substation ROW Access	0	1	1	0	1
Thirtymile Substation ROW Access	0	2	2	0	2
Electric Distribution Line Construction ROW	5	0	5	5	0
Mineral Material Sale (Offsite Borrow Area)	0	0	40	40	0
Total	46	2,521	1,948	378	1,570

^a Construction^b Construction plus life of Station^c Operations^d First a long-term ROW and then a sale

2.3.3.2 Electric Transmission Facilities ROW

The electric transmission facilities would consist of overhead 500-kV and 345-kV electric transmission lines and two electric substations (see Figure 2-18). The long-term ROW needed for the electric transmission facilities would total approximately 1,116 acres (see Table 2-3) and include the following:

- Approximately 60-acre electric Duck Creek Substation
- Approximately 77-acre electric Thirtymile Substation (this is the same feature for the Proposed Action)
- Approximately 28 mile-long, 200-foot-wide corridor (685 acres) for one 500-kV transmission line from the Duck Creek Substation to the Thirtymile Substation
- Two approximately 0.2 mile-long, 160-foot-wide ROWs (9 acres) for two 345-kV transmission lines to interconnect the Falcon-Gonder 345-kV transmission line to the Thirtymile Substation (this is the same feature for the Proposed Action)
- Two approximately 6 mile-long, 200-foot-wide ROWs (285 acres) for two 500-kV transmission lines to interconnect the planned SWIP 500-kV transmission line to the Duck Creek Substation

An alternative transmission line route that was evaluated but rejected from detailed evaluation and the rationale for its rejection are described in Section 2.5.10.

2.3.3.2.1 Duck Creek Substation ROW

The Duck Creek Substation would be located adjacent to and immediately northeast of the power plant site on approximately 60 acres (see Figures 2-17

and 2-18 and Table 2-3). Substation facilities would be the same as described for the Proposed Action.

2.3.3.2.2 Thirtymile Substation ROW

The Thirtymile Substation would be the same as described for the Proposed Action.

2.3.3.2.3 Duck Creek to Thirtymile 500 kV Transmission Line ROW

One 200-foot-wide transmission line ROW would extend from the Duck Creek Substation approximately 28 miles west to the Thirtymile Substation near Robinson Summit (see Figure 2-17). The types of transmission towers used would be the same as the Proposed Action. It is estimated that there would be approximately 17 miles of transmission line utilizing H-frame towers, approximately 10 miles of transmission line utilizing single-circuit self-supporting lattice towers, and approximately 1 mile of transmission line utilizing double-circuit self-supporting lattice towers.

The height and spacing between each tower would be similar to the Proposed Action. It is estimated that there would be approximately 71 H-frame towers, approximately 43 single-circuit self-supporting lattice towers, and approximately 6 double circuit self-supporting lattice towers.

The areas of disturbance associated with each tower, pulling and tensioning sites, batch plant, and spur roads and tangential roads would be similar to the Proposed Action. It is estimated that approximately 12 miles of existing roads would need to be upgraded and approximately 32 miles of new roads would have to be constructed.

2.3.3.2.4 Falcon-Gonder 345-kV Interconnection ROW

The Falcon-Gonder 345-kV Interconnection would be the same as described for the Proposed Action.

2.3.3.2.5 SWIP 500-kV Interconnection ROW

Two separate 200-foot-wide transmission line ROWs would extend from the Duck Creek Substation approximately 6 miles northwest to the planned SWIP transmission line (see Figures 2-17 and 2-18). The planned SWIP 500-kV transmission line would be looped into the Duck Creek Substation and new transmission towers would be erected to connect each segment into the 500-kV equipment at the Duck Creek Substation. The towers would be steel pole H-frame and dead end structures as required. It is estimated that approximately 50 towers would be used, 10 pulling and tensioning sites would be required, and access roads along each transmission line ROW would be required for construction access and long term maintenance.

2.3.3.3 Water Supply System ROW

The water requirements for the Station would be the same as the Proposed Action. The location of the production well field for Alternative 1 is shown in Figure 2-17 and is different from the production well field for the Proposed Action. The location of the monitoring well field for Alternative 1 is shown in Appendix G, Figure G-2 and is different from the monitoring well field for the Proposed Action. A water supply system would be constructed to supply water to the Station. The water supply system would require approximately 45 acres of long-term ROW and approximately 31 acres of short-term ROW (Table 2-3) and include the following:

- Eight approximately 0.5-acre ROWs (4 acres total) for each ground water production well
- Four approximately 0.5-acre ROWs (2 acres total) for each ground water monitoring well
- Approximately 8-mile-long, 40-foot-wide long-term ROW (39 acres) and

30-foot-wide short-term ROW (29 acres) for underground water pipelines, electric distribution lines, communications lines, access roads, and other facilities as necessary

- Approximately 2-acre short-term ROW as a staging area for the placement of materials and equipment during construction

Alternative ground water well and pipeline locations and numbers that were evaluated but rejected from detailed evaluation and the rationale for their rejection are described in Section 2.5.5 within the broader discussion of an alternative cooling technology that was evaluated. Alternative well field electric distribution line alignments and design that were evaluated but rejected from detailed evaluation and the rationale for their rejection are described in Section 2.5.9.

2.3.3.3.1 Ground Water Production Well ROW

The Station would use up to eight ground water production wells for water supply. Construction and operation of the ground water wells would occupy approximately 0.2 acre total. The wells would be approximately 1,000 feet deep and withdraw water from the basin-fill aquifer.

Each well is permitted to withdraw up to 3 cubic feet per second of water. The location for the ground water wells associated with the water supply system is constrained by defined well locations as specified under permits issued to White Pine County by the Nevada State Engineer's Office. Figure 2-17 depicts the locations where the eight water wells would be drilled.

The description of the wells would be the same as for the Proposed Action.

2.3.3.3.2 Ground Water Quality Monitoring Well ROW

A network of up to four ground water quality monitoring wells would be installed prior to Station start-up and monitored to document changes in ground water levels that could be caused by ground water withdrawals for the Station at the eight ground water production wells. The description of the wells would be the same as for the Proposed Action. The proposed locations of the monitoring wells for Alternative 1 and the monitoring program are described in Appendix G. All of the monitoring wells are anticipated to be located on public land or property owned by WPEA.

2.3.3.3.3 Water Supply System Linear Facilities ROW

One 40-foot-wide long-term ROW and one 30-foot-wide short-term ROW would extend from the power plant site approximately 8 miles generally west and south to each of the ground water wells (see Figure 2-17). The description of the water supply system linear facilities would be the same as for the Proposed Action except the permanent disturbance associated with the access roads is estimated to be approximately 10 acres for Alternative 1.

2.3.3.3.4 Construction Staging Area ROW

A short-term ROW would be used during the construction of the water supply system as a staging area for the placement of materials and equipment (see Figure 2-17). This ROW would be approximately 100 feet wide by 871 feet long.

2.3.3.3.5 Wetland Mitigation

Wetland mitigation measures that will be implemented for actual wetland acreage filled because of construction of the water supply system under Alternative 1 are the

same as described for the Proposed Action in Section 2.2.4.6.1, *Wetland Mitigation*.

2.3.3.4 Rail Spur

A rail spur approximately 3 miles long would be constructed from the existing NNR to a rail loop that would be constructed on the power plant site (see Figure 2-17). The rail spur would generally run east-west and enter the power plant site near its southwest corner. The rail spur would include all facilities necessary for the operation of the railroad including rail, cross ties, other track material, ballast, drainage facilities, and access roads.

A short-term 30-foot-wide ROW located adjacent to the long-term rail spur ROW would be required during construction. The short-term ROW would occupy approximately 10 acres and be reclaimed after construction is complete. The long-term rail spur ROW would be 35 to 70 feet wide and occupy approximately 24 acres. The rail spur would cross several small drainages to Duck Creek, but it would not cross mainstream Duck Creek.

2.3.3.4.1 Wetland Mitigation

Wetland mitigation measures that will be implemented for actual wetland acreage filled because of construction of the rail spur under Alternative 1 are the same as described for the Proposed Action in Section 2.2.4.6.1, *Wetland Mitigation*.

2.3.3.5 Access ROW

Access ROWs would be required to provide road access and certain utility access (for example, phone and fiber optics) to the Power Plant ROW, Duck Creek Substation, and Thirtymile Substation.

2.3.3.5.1 Power Plant ROW Access

The ROW for access to the power plant site would be 60 feet wide. The ROW would begin at U.S. 93 and continue directly west to the power plant site (see Figure 2-17). This ROW would be approximately 0.3 mile long and cover approximately 3 acres.

2.3.3.5.2 Duck Creek Substation ROW Access

The ROW for access to the Duck Creek Substation would be 30 feet wide. The ROW for the Duck Creek Substation would begin at U.S. 93 and continue directly west to the Duck Creek Substation ROW (see Figure 2-17). This ROW would be approximately 0.4 mile long and cover approximately 1 acre.

2.3.3.5.3 Thirtymile Substation ROW Access

The ROW for access to the Thirtymile Substation would be the same as the Proposed Action.

2.3.3.6 Electric Distribution Line Construction ROW and Mineral Material Sale

Offsite activities would be necessary to support construction of the Station, including the need for construction power and additional earth and rock materials.

2.3.3.6.1 Electric Distribution Line Construction ROW

A short-term ROW would be used to provide power during the construction of the Station. The short-term ROW for construction power from the existing 69-kV distribution line to the power plant site would be 40 feet wide.

The electric distribution line would be constructed from the existing distribution line, located approximately 0.7 mile east of U.S. 93, to the power plant site along

the northern side of the Power Plant ROW access (see Figure 2-17). This ROW would be approximately 1 mile long, resulting in a short-term ROW grant of approximately 5 acres.

2.3.3.6.2 Mineral Material Sale

This area would be the same as for the Proposed Action.

2.3.3.7 Connected Actions

The two third-party infrastructure projects described for the Proposed Action (NNR upgrade and operation and SWIP construction) also are closely related to but not part of Alternative 1.

Under Alternative 1, the rail spur for the proposed White Pine Energy Station power plant would connect to the upgraded NNR at approximately MP 115. The portion of the NNR south of the Alternative 1 rail spur is not considered part of the connected action because Station-related coal trains will not travel further south than the Alternative 1 rail spur.

Between the Proposed Action and Alternative 1 rail spur sites, 6 corrugated metal pipe culverts and 1 concrete box culvert would need replaced or repaired, 4 railroad crossings would need reconstructed, and 1 siding should be replaced with heavier rail.

2.3.4 Construction Activities

Construction activities associated with Alternative 1 would be the same as those described for the Proposed Action in Section 2.2.4, *Construction Activities*.

2.3.5 Operation, Maintenance, and Abandonment

Operation, maintenance, and abandonment activities associated with Alternative 1 would be the same as those described for the

Proposed Action in Section 2.2.5, *Operation, Maintenance, and Abandonment*.

2.3.6 Enhancement Measure

An enhancement measure associated with Alternative 1 would consist of the Moriah Ranches Seeding Project and would be the same as described for the Proposed Action in Section 2.2.6, *Enhancement Measure*.

2.3.7 Best Management Practices

BMPs associated with Alternative 1 would be the same as described for the Proposed Action in Section 2.2.7, *Best Management Practices* and contained in Appendix C, *Best Management Practices*. Mitigation measures specific to Alternative 1 for the various resources present in the Station area are described in Chapter 4, *Environmental Consequences*. Adaptive management plans associated with Alternative 1 would be the same as described for the Proposed Action in Section 2.2.7.

2.4 No Action Alternative

Section 1502.14(d) of NEPA regulations requires that the alternatives analysis in an EIS include a No Action Alternative. Under the No Action Alternative for this *FEIS for the White Pine Energy Station Project*, Station-related ROWs would not be created, the Power Plant ROW subsequently would not be sold to WPEA, and the power plant and related facilities would not be constructed or operated as described for the Proposed Action or Alternative 1. However, it is assumed that the NNR and SWIP connected actions would be implemented.

If the No Action Alternative is selected for implementation, existing conditions and trends that are described for the affected environment in Chapter 3, *Affected Environment*, of this document would continue. As a result, the project purposes

and needs that were described in Section 1.2, *Purpose, Need, and Background*, would not be met.

2.5 Alternatives Considered but Eliminated from Detailed Evaluation

NEPA requires that an EIS provide detailed evaluation of a no action alternative, a proposed action, and reasonable alternatives. NEPA requires detailed analysis only of those alternatives that are "reasonable" and that meet the stated purpose and need. Reasonable alternatives are those that are practicable or feasible from the technical and economic standpoint and using common sense. Alternatives that do not meet purpose and need are not considered reasonable. This section describes alternatives that were considered but not carried forward for detailed evaluation and the rationale for their rejection.

2.5.1 Alternative Power Generating Technologies

Alternative power generating technologies that were considered but eliminated from detailed evaluation are described in the following text together with the rationale for their elimination. To inform the reader, the power generating technology selected for the Station (pulverized coal power plant) also is described in the following text (see Section 2.5.1.4.4) for purposes of comparison to those alternatives that were eliminated. Appendix H provides more detail on the various alternative generating technologies.

Categories of technologies considered include renewable non-combustible energy resources (for example, wind, solar); renewable combustible energy resources (for example, biomass, biogas); non-renewable

combustible energy resources (for example, natural gas, various coal processes); and other (nuclear and conservation/energy efficiency). Six detailed criteria were designed to assess the degree to which potential alternatives would satisfy the purpose and need for the White Pine Energy Station, and would be “reasonable” for NEPA purposes (that is, economically and technically practical and feasible). These evaluation criteria are as follows:

- Capable of providing approximately 1,590 MW of reliable baseload power generation capacity
- Environmentally permissible
- Cost effectiveness relative to pulverized coal
- Commercially proven and reliable
- Place water held by White Pine County for power production in Steptoe Valley to beneficial use for power production
- Provide traffic for the NNR

Table 2-4 summarizes and compares results of the evaluation of alternative power generation technologies for meeting the evaluation criteria for the proposed project. All six criteria are discussed in the following text and compared among the alternative technologies in Table 2-4. As indicated in the following discussion and Table 2-4, only the pulverized coal and the circulating fluidized-bed (CFB) coal power plant technologies would meet all six of the evaluation criteria and project purpose and need. However, CFB does require a higher capital cost and offers no technical, operating economics, or environmental advantages over pulverized coal.

Information on alternative power generating technologies presented in Section 2.5.1 has been summarized from a

detailed study by CH2M HILL (2004). That study described, evaluated, and compared various aspects of energy alternatives, including estimated power costs. Power cost estimates presented in the CH2M HILL (2004) study are approximate order of magnitude values and are suitable for comparing the relative cost effectiveness of power generating technologies evaluated for the Station in the following text.

2.5.1.1 Renewable Non-Combustible Energy Resources

The renewable non-combustible energy resources evaluated in this section are wind, hydroelectric, solar, and geothermal.

2.5.1.1.1 Wind

The greatest advantage of wind power is its potential for large-scale, though intermittent, electricity generation without emissions of any kind. In addition, over the years, wind energy’s production cost has benefited from improvements in technology and increased reliability.

The development of wind power is increasing in many regions of the United States. Technological advances have improved the performance of wind turbines and driven down their cost. In locations where the wind blows steadily, wind power has been shown to compete favorably with coal and natural gas fired power plants based on receiving the federal Renewable Energy Production Incentive.

The outlook for wind energy remains favorable because of the technology’s economic competitiveness, growing demand for electricity, and effective renewable energy policies adopted in several markets.

TABLE 2-4

Comparison of Alternative Power Generating Technologies

	Evaluation Criteria						Capable of Meeting All Evaluation Criteria
	Capable of Providing Approximately 1,590 MW of Reliable Baseload Power Generation Capacity	Environmentally Permittable	Cost Effectiveness Relative to Pulverized Coal	Commercially Proven and Reliable	Place Water Held by White Pine County for Power Production in Steptoe Valley to Beneficial Use for Power Production*	Provide Traffic for the NNR*	
Renewable Non-combustible Energy Resources							
Wind	No	Yes	Yes	Yes	No	No	No
Solar	No	Yes	No	Yes	Yes	No	No
Hydroelectric	No	Difficult	Yes	Yes	No	No	No
Geothermal	No	Yes	No	Yes	No	No	No
Renewable Combustible Energy Resources							
Biomass	No	Yes	No	Yes	Unlikely but possible	Yes	No
Biogas	No	Yes	Yes	Yes	Unlikely but possible	No	No
Municipal Solid Waste (MSW)	No	Difficult	No	Yes	Unlikely but possible	Yes	No
Nuclear	Yes	Difficult	Yes	Yes	No	No	No
Non-renewable Combustible Energy Resources							
Natural Gas Combined Cycle (NGCC)	Yes	Yes	No	Yes	Yes	No	No
Circulating Fluidized-Bed (CFB) Coal	Yes	Yes	Yes	Yes	Yes	Yes	Yes
Integrated Gasification Combined Cycle (IGCC) Coal	No	Yes	No	No	Yes	Yes	No
Pulverized Coal (selected for the proposed White Pine Energy Station)	Yes	Yes	Yes	Yes	Yes	Yes	Yes

* These criteria are elements of the Development Agreement between White Pine Energy Associates and White Pine County (see Appendix A)

Wind turbines are mounted on a tower to capture the most energy. At 100 feet (30 meters) or more aboveground, they can take advantage of the faster and less turbulent wind. Turbines catch the wind's energy with their propeller-like blades. Usually, two or three blades are mounted on a shaft to form a rotor.

Wind turbines can be used in off-grid applications, or they can be connected to a utility power grid. For utility-scale sources of wind energy, a large number of turbines are usually built close together to form a wind farm. These turbines each require about a quarter-acre of land, which includes land for the turbine and any access roads. As a result, turbines fit well onto agricultural land without taking the land out of production, simply making way for the turbine's base. All of the land in between the turbines is available for agricultural activities.

Capable of Providing Approximately 1,590 MW of Reliable Baseload Power Generation Capacity

The greatest advantage of wind power is its potential for large-scale, though intermittent, electricity generation without emissions of any kind. Nevada has excellent wind resources in portions of the state. However, because of the intermittent nature of wind, estimates of capacity factors range from only 25 to 35 percent. Another major issue regarding wind intermittence is that wind power can offer energy, but not on-demand capacity. Therefore, wind power cannot always be reliably dispatched at the time it is needed and cannot be considered for baseload operation.

Environmentally Permittable

While wind power has no air emissions or water use, it does have other impacts on the environment. These include visual

obstruction, bird kills, and noise pollution, among others. Mitigation measures are frequently taken to resolve these problems. This technology should be permittable in Nevada.

Cost Effectiveness Relative to Pulverized Coal

Within the limits of its intermittent nature, the cost of power generated by large wind turbine farms is competitive with power generated from a pulverized coal plant, based on the current energy tax incentives provided by the federal government. The total levelized cost to construct, operate, and maintain a wind power plant over its economic life converted to equal annual payments is approximately \$47 per MWh (megawatt-hour) for the life of the project compared to approximately \$50 per MWh for a pulverized coal plant.

Commercially Proven and Reliable

Wind power is commercially proven and reliable. Installed wind electric generating capacity now exceeds 6,000 MW in the United States, 28,000 MW in Europe, and 39,000 MW worldwide.

Place Water Held by White Pine County for Power Production in Steptoe Valley to Beneficial Use for Power Production

A wind power project would not place the use of water held by White Pine County for power production in Steptoe Valley to beneficial use for power production.

Provide Traffic for the NNR

Construction and operation of a wind power project would be expected to provide little, if any, traffic for the NNR.

Capable of Meeting Purpose and Need

Wind power is cost effective, within the limits of its intermittent nature, with tax incentives provided by the federal

government. Wind power should be environmentally permissible in Nevada. However, because of its intermittent nature, wind power cannot offer high reliability consistently and it cannot offer baseload operation. Wind power would not result in the beneficial use of water held by White Pine County for power production in Steptoe Valley, and it would provide little, if any, traffic for the NNR. Therefore, wind power does not meet three of the six project evaluation criteria, and it does not meet the overall purpose and need of the proposed Station.

2.5.1.1.2 Solar

The sun is a direct source of energy. Using renewable energy technologies can convert solar energy into electricity. However, solar energy varies by location and time of year. Solar resources are expressed in watt-hours per square meter per day. This is roughly a measure of how much energy falls on a square yard over the course of an average day.

Capable of Providing Approximately 1,590 MW of Reliable Baseload Power Generation Capacity

Because of the intermittent nature of solar power, estimates of capacity factors range from only 20 to 35 percent. Another major issue regarding solar power intermittence is that solar power can offer energy, but not on-demand capacity. Related to intermittence is solar power's unpredictable nature because of weather. Thermal storage technologies that would allow power generation from concentrated solar to continue for a period of time when the sun is obscured or at night are being developed, but are not yet commercial and would still not ensure a constant supply of power. Therefore, solar power cannot always be reliably dispatched at the time it

is needed and cannot be relied upon for baseload operation.

Environmentally Permittable

In general, solar resources have relatively less impact on the environment compared to other generation technologies, except possibly for aesthetics and the large area required for the facilities. As an example of a solar facility's size, CH2M HILL (2004) reported that the footprint of a 300 MW solar farm would encompass approximately 4,200 acres. By extrapolation, the footprint of a solar facility capable of providing approximately 1,590 MW of power, the same as the proposed Station, would exceed 20,000 acres. In another example, a concentrated solar facility that is now operating in southern Nevada is the Nevada Solar One facility. This is a peak 64-MW thermal solar facility utilizing a 350-acre solar collection grid (NDEP, 2007). Scaling these values to an output of 1,590 MW would result in a collection grid area of approximately 8,700 acres. Additional footprint would be expected to be required for support activities such as administration, maintenance, and evaporation ponds. No major direct air emissions are related to the installation of a solar facility, and there would be no major water discharge issues. This technology should be permissible in Nevada.

Cost Effectiveness Relative to Pulverized Coal

The cost of power generated by solar facilities is three to four times greater than power generated from a pulverized coal plant. The total levelized cost to construct, operate, and maintain a solar facility over its economic life converted to equal annual payments ranges from approximately \$157 per MWh for photovoltaic solar

power to \$168 per MWh for solar thermal power.

Commercially Proven and Reliable

Solar concentrators and flat-plate collector types are both used in each of the solar-based technologies—photovoltaic and solar thermal.

The largest use of photovoltaic has been in the off-grid market, which takes advantage of photovoltaic's ability to be a complete stand-alone electrical system.

Telecommunications and transportation construction signage are the two largest segments of the off-grid market. Most of the off-grid market is associated with remote locations and inaccessibility to the utility grid of applications, such as water pumping and highway lighting. However, in many instances, the grid may be near a well developed area, but it is still more cost-effective to install a modular photovoltaic system rather than cross roadways or sidewalks.

In the southwestern United States, solar thermal power is being considered primarily as an important technology resource. California, Nevada, Arizona, and New Mexico are each exploring policies that would further the development of their solar-based industries.

Place Water Held by White Pine County for Power Production in Steptoe Valley to Beneficial Use for Power Production

Cooling requirements for a concentrated thermal solar facility could place water held by White Pine County in Steptoe Valley to beneficial use for power production.

Provide Traffic for the NNR

Construction and operation of a solar facility would be expected to provide little, if any, traffic for the NNR.

Capable of Meeting Purpose and Need

Neither photovoltaic nor thermal types of solar power can offer baseload operation. Neither are considered cost effective, and both require large land areas compared to a pulverized coal plant. Solar power would potentially result in the beneficial use of water held by White Pine County for power production in Steptoe Valley, but it would provide little, if any, traffic for the NNR. Therefore, solar power does not meet four of the six project evaluation criteria, and it does not meet the overall purpose and need of the proposed Station

2.5.1.1.3 Hydroelectric

Flowing water creates energy that can be captured and turned into electricity. This is called hydroelectric power or hydropower.

The most common type of hydroelectric power plant uses a dam on a river to store water in a reservoir or a run of the river approach, which does not result in the construction of a large reservoir. Water released from the reservoir flows through a turbine, which in turn activates a generator to produce electricity.

Another type of hydroelectric power plant, referred to as a pumped storage plant, has the capacity to store energy. The power is sent from a power grid into the electric generators. The generators then turn the turbines backward, which causes the turbines to pump water from a river or lower reservoir to an upper reservoir, where the energy is stored. To use the energy, the water is released from the upper reservoir back down into the river or lower reservoir. This turns the turbines forward, activating the generators to produce electricity.

Capable of Providing Approximately 1,590 MW of Reliable Baseload Power Generation Capacity

Beyond Hoover Dam, no other sites in Nevada are available for a large-scale hydroelectric project, like an approximately 1,590-MW plant. Therefore, hydroelectric power cannot be considered for baseload operation.

Environmentally Permittable

Environmental impacts would vary depending on the type and number of hydroelectric projects proposed: run of river, reservoir storage, or pumped storage. While there would be no major water discharge issues compared with typical thermal power plants, the construction of an impoundment or reservoir could have various adverse impacts on water quality, wetlands, flooding of uplands, and aquatic as well as terrestrial biota. The permitting of a new hydroelectric facility is typically a complex and time-consuming process requiring multiple federal and state permits and approvals. Development of a hydroelectric facility can experience significant public and agency opposition.

Cost Effectiveness Relative to Pulverized Coal

The cost of power generated by a large hydroelectric project would be approximately half that of power generated from a pulverized coal plant. The total levelized cost to construct, operate, and maintain a hydroelectric project over its economic life converted to equal annual payments is approximately \$24 per MWh.

Commercially Proven and Reliable

Hydroelectric power is commercially proven and reliable and is responsible for a significant portion of the generation

capacity in various regions of the United States and abroad. However, as noted previously, because of the seasonal nature of hydropower, the average annual capacity factor for most facilities is approximately only 30 to 40 percent.

Place Water Held by White Pine County for Power Production in Steptoe Valley to Beneficial Use for Power Production

A hydroelectric project would not place the use of water (ground water rights) held by White Pine County for power production in Steptoe Valley to beneficial use for power production.

Provide Traffic for the NNR

Construction and operation of a hydroelectric facility would be expected to provide little, if any, traffic for the NNR.

Capable of Meeting Purpose and Need

Hydroelectric power cannot fulfill the need for approximately 1,590 MW of highly reliable baseload capacity because no such sites exist in Nevada beyond Hoover Dam. Although cost effective once in operation, development of a hydroelectric facility can experience significant public and agency opposition and be difficult to permit environmentally. A hydroelectric project would not result in the beneficial use of ground water held by White Pine County for power production in Steptoe Valley, and it would provide little, if any, traffic for the NNR. Therefore, hydroelectric power does not meet four of the six project evaluation criteria, and it does not meet the overall purpose and need of the proposed Station.

2.5.1.1.4 Geothermal

Geothermal energy is contained in underground reservoirs of steam, hot water, and hot dry rocks. Electric generating facilities use hot water or steam

extracted from geothermal reservoirs in the earth's crust to drive steam turbine generators to produce electricity. Moderate-to-low temperature geothermal resources are used for direct-use applications such as district and space heating. Lower temperature, shallow ground, geothermal resources are used by geothermal heat pumps to heat and cool buildings. Hence, the only geothermal resources that may be considered for use in generating power are the high temperature sources. Nevada has high-temperature resources that are suitable for electricity generation.

The time from which a site is confirmed as having sufficient water or steam at temperatures high enough to drive turbines using either a binary or flash system to the time a facility can produce electricity is typically less than 3 years. However, because of the remote locations of many geothermal resources, the cost of transmission may make the venture more expensive than a facility that is closer to an identified injection point.

The Western Governors Task Force (2006) estimated that Nevada has the potential for an additional 1,488 MW of geothermal energy by 2015 and up to 2,895 MW by 2025. However, the report shows that most geothermal resource sites are located in western Nevada and none are shown for White Pine County. In addition, the Public Utilities Commission of Nevada projects that the total planned geothermal capacity additions over the next decade will only be 310 MW (Public Utilities Commission of Nevada, 2007).

Capable of Providing Approximately 1,590 MW of Reliable Baseload Power Generation Capacity

Geothermal energy consists of a dispersed resource base and is not available in

sufficient capacity in White Pine County to meet the project purpose and need. Therefore, geothermal power cannot be considered for baseload operation.

Environmentally Permittable

Geothermal energy is generally one of the cleaner forms of energy available for commercial applications. Large geothermal resources used for electrical generation have had issues with air emissions (primarily hydrogen sulfide) and water discharges and would need additional controls to minimize emissions. The high flow rates of steam and water from geothermal wells can result in the precipitation of various compounds, primarily silica. Land disposal of precipitates would be required. This technology should be permittable in Nevada.

Cost Effectiveness Relative to Pulverized Coal

The cost of power generated by geothermal projects would typically be higher than power generated from a pulverized coal plant. The total levelized cost for a geothermal power project over its economic life converted to equal annual payments ranges from approximately \$50 to \$80 per MWh.

Commercially Proven and Reliable

Producing electricity from geothermal resources involves a mature technology. About 8,000 MW of geothermal electricity are currently produced around the world, including about 2,200 MW of capacity in the United States. All of the geothermal power in the United States is generated in California, Nevada, Utah, and Hawaii, with California accounting for over 90 percent of installed capacity. A considerable amount of the power (1,137 MW) is generated at The Geysers in northern

California. The Geysers is a fairly unusual (and ideal) resource because its wells produce virtually pure steam with no water.

Place Water Held by White Pine County for Power Production in Steptoe Valley to Beneficial Use for Power Production

A geothermal project would not place the use of water (non-thermal ground water rights) held by White Pine County for power production in Steptoe Valley to beneficial use for power production.

Provide Traffic for the NNR

Construction and operation of a geothermal facility would be expected to provide little, if any, industrial or demand-related traffic for the NNR.

Capable of Meeting Purpose and Need

Geothermal power is not available in White Pine County in sufficient capacity to meet project purpose and need.

Although environmentally permissible, geothermal power typically has a higher cost than power from a pulverized coal plant. A geothermal power project would not result in the beneficial use of water (non-thermal ground water rights) held by White Pine County for power production in Steptoe Valley, and it would provide little, if any, traffic for the NNR.

Therefore, geothermal power does not meet five of the six project evaluation criteria, and it does not meet the overall purpose and need of the proposed Station.

2.5.1.2 Renewable Combustible Energy Resources

The renewable combustible energy resources evaluated in this section are biomass, biogas, and municipal solid waste.

2.5.1.2.1 Biomass

For heating applications or electricity generation, biomass can be directly burned in its solid form, or first converted into liquid or gaseous fuels by thermal decomposition. Biomass power technologies convert renewable biomass fuels into heat and electricity using modern boilers, gasifiers, turbines, generators, fuel cells, and other methods.

Forest fires in the past several years in western states have generated increased stimulus to initiate forest thinning programs. Several biomass plants are being proposed in the West to use forest thinnings as a major fuel source.

In addition to the potential for traditional forest product companies to participate in electric generation, the degree of success that nontraditional participants in the national fiber market will experience must be evaluated. The principal nontraditional participant would likely be an electric utility considering co-firing biomass with coal. Scenarios for large increases in biomass-based power generation usually assume that some fraction of this electricity will come from co-firing. About 15 percent of a co-firing fuel mix can be biomass in theory. In practice, however, workable proportions may be closer to 5 percent. At the utility sector level, this scenario might imply that a big increase in biomass electricity encompasses participation by many buyers making relatively small, scheduled fiber purchases.

The viability of the utility co-firing scenario, at first glimpse, does not appear favorable. Forest product industries are usually located near timber resources. In contrast, utility generating facilities are located according to a number of considerations: water availability, land

acquisition capability and costs, environmental and safety issues, transmission and distribution costs, and proximity to population centers, among others. These considerations often do not put utility plants within an economically feasible range (generally 50 miles) of biomass resources; the amount of wood required to satisfy only 5 percent of fuel requirements is far too small to transport wood in a manner similar to that of coal. Thus, some utilities that might wish to co-fire with wood are faced with difficulties accessing fuel resources in a cost-effective manner.

Capable of Providing Approximately 1,590 MW of Reliable Baseload Power Generation Capacity

Recent studies indicate that Nevada has a fair biomass resource potential (DOE, 2007). These studies are based on estimates for five general categories of biomass: urban residues, mill residues, forest residues, agricultural residues, and energy crops. However, it is unknown whether enough biomass would be available within or near White Pine County to fuel approximately 1,590 MW of baseload power generation.

Environmentally Permittable

This technology should be permittable in Nevada.

Cost Effectiveness Relative to Pulverized Coal

The cost to generate electricity from biomass varies depending on the type of technology used, size of the power plant, and cost of the biomass fuel supply; however, it is typically significantly higher than generating power from a pulverized coal plant. The total levelized cost for a direct-fired biomass power plant over its economic life converted to equal annual payments is approximately \$90 per MWh

compared to \$50 per MWh for a pulverized coal plant.

Most forest residues, agricultural residues, and energy crops are not presently economic for energy use. New tax credits or incentives, increased monetary valuation of environmental benefits, or sustained high prices for fossil fuels could make these fuel sources more economic in the future. Currently, the most economically attractive technology for biomass is co-firing. Co-firing systems range in size from 1 MW to 30 MW of biopower capacity.

For biomass to be economical as a fuel for electricity, the source of biomass must be located near to where it is used for power generation. This reduces transportation costs—the preferred system has transportation distances less than 100 miles. The most economical conditions exist when the energy use is located at the site where biomass residues are generated (that is, at a paper mill or sawmill).

Commercially Proven and Reliable

Generating electricity from biomass residues is a proven and commercially available technology. Although many people envision substantial increases in biomass power for the future with “energy crop” plantations forming a primary supply base, this is not commercially feasible or reliable in the near term. Presently, “closed-loop” (that is, sustainably supplied) biomass power projects are at the research and demonstration phase.

Place Water Held by White Pine County for Power Production in Steptoe Valley to Beneficial Use for Power Production

A biomass project in White Pine County could place the use of water held by White

Pine County for power production in Steptoe Valley to beneficial use for power production.

Provide Traffic for the NNR

Construction and operation of a biomass plant would potentially provide some traffic for the NNR, depending on the source and location of the biomass fuel and whether rail would be a practical method of transport to the plant site.

Capable of Meeting Purpose and Need

Generating electricity from biomass residues is a proven and commercially available technology, although not a commercially feasible and reliable technology in the near term. Biomass power cannot meet purpose and need because of its higher cost and limitations on fuel availability at a large enough scale for baseload operation. A biomass project could result in the beneficial use of water held by White Pine County for power production in Steptoe Valley, and it could conceivably provide some NNR industrial traffic through the conveyance of fuel to a plant site. Biomass power does not meet two of the six project evaluation criteria, and it does not meet the overall purpose and need of the proposed Station.

2.5.1.2.2 Biogas

The same types of anaerobic bacteria that produced natural gas also produce methane rich biogas today. Anaerobic bacteria break down or “digest” organic material in the absence of oxygen and produce “biogas” as a waste product. (Aerobic decomposition, or composting, requires large amounts of oxygen and produces heat.) Anaerobic processes can be managed in a “digester” (an airtight tank) or a covered lagoon (a pond used to store manure) for waste treatment. The primary benefits of anaerobic digestion are

nutrient recycling, waste treatment, and odor control. Except in very large systems, biogas production is a highly useful but secondary benefit.

Digester biogas produced in anaerobic digesters consists of methane (50 to 80 percent), carbon dioxide (20 to 50 percent), and trace levels of other gases such as hydrogen, carbon monoxide, nitrogen, oxygen, and hydrogen sulfide. The relative percentage of these gases in biogas depends on the feed material and management of the process. Anaerobic digesters are used in municipal wastewater treatment plants and on large farm, dairy, and ranch operations for disposal of animal waste.

Landfill biogas is created when organic waste in a landfill naturally decomposes. This gas consists of about 50 percent methane, about 50 percent carbon dioxide, and a small amount of non-methane organic compounds. Instead of allowing landfill biogas to escape into the air, it can be captured, converted, and used as an energy source. Using landfill biogas helps reduce odors and other hazards associated with landfill biogas emissions, and it helps prevent methane from migrating into the atmosphere and contributing to local smog and global climate change.

The various types of biogas can be collected and used as a fuel source to generate electricity using conventional generating technology.

Capable of Providing Approximately 1,590 MW of Reliable Baseload Power Generation Capacity

Biogas power cannot fulfill the need for approximately 1,590 MW of highly reliable baseload capacity. The amount of digester gas and landfill gas resources is limited in the region and could only provide a small percentage of the fuel

needed to generate power for the proposed project.

Environmentally Permittable

Environmental permitting would be fairly straightforward for a biogas power plant. This technology should be permittable in Nevada.

Cost Effectiveness Relative to Pulverized Coal

The total levelized cost over the life of a project to generate electricity from biogas (approximately \$46 per MWh) is similar to the cost of power generated from a pulverized coal plant (approximately \$50 per MWh).

Commercially Proven and Reliable

Production of electric power from both digester gas and landfill gas has been demonstrated commercially for many years. Digester or landfill gas can be used as fuel in reciprocating engines or in gas turbines to generate electricity.

Place Water Held by White Pine County for Power Production in Steptoe Valley to Beneficial Use for Power Production

A biogas project could place water held by White Pine County for power production in Steptoe Valley to beneficial use for power production.

Provide Traffic for the NNR

Construction and operation of a biogas plant would be expected to provide little, if any, traffic for the NNR.

Capable of Meeting Purpose and Need

Generating electricity from biogas is a proven, commercially reliable, cost effective, and environmentally permittable technology. However, biogas power cannot fulfill the need for approximately 1,590 MW of baseload capacity because

the amount of digester gas and landfill gas resources is limited in the region. Also, a biogas project could probably result in the beneficial use of water held by White Pine County for power production in Steptoe Valley. It would provide little, if any, traffic for the NNR. Therefore, biogas power does not meet two of the six project evaluation criteria, and it does not meet the overall purpose and need of the proposed Station.

2.5.1.2.3 Municipal Solid Waste (MSW)

Municipal solid waste (MSW) typically uses a refuse derived fuel technology in waste-to-energy facilities to combust trash, garbage, and other combustible refuse. The material is received in its as-discarded form and subjected to segregation of some of the recyclables and shredding prior to being fed into the boilers for combustion. MSW provides energy for power production and at the same time provides waste volume reduction.

The plants range upward to 90 MW in size using multiple boilers to provide steam to a single condensing steam turbine generator. There also are a number of mass burn units in operation that burn the MSW directly in its as-discarded form with only the larger non-combustibles removed. Mass burn technology has largely given way to refuse derived fuel in response to pressure to recycle materials, and because the boilers designed to handle refuse derived fuel are more economical to build.

There is the potential for the production of toxic trace metals such as lead, mercury, and beryllium during the combustion process. This can be controlled somewhat by source separation (small batteries are a source of mercury) and by using selenium filters, which are effective in removing mercury from flue gas. However, the

potential exists to require special disposal precautions because of the presence of these materials in the solid waste. The production of dioxins from the combustion of plastics has been an emissions concern. Dioxin production is controlled by maintaining sufficiently high combustion temperatures in the furnace with supplemental fuel, if required, to incinerate them.

Capable of Providing Approximately 1,590 MW of Reliable Baseload Power Generation Capacity

MSW power cannot fulfill the need for approximately 1,590 MW of highly reliable baseload capacity. The amount of MSW resources is limited in the region and could only provide a small percentage of the power to be generated by the Proposed Action.

Environmentally Permittable

Permitting a large MSW electric-generation facility would be a long and complicated process. The primary environmental disadvantage is related to emissions of hazardous air pollutants. This issue has made the permitting of MSW electric generation facilities a difficult process in many areas of the country and there is substantial public opposition to siting these facilities. The probability of obtaining a permit to operate is marginal.

Cost Effectiveness Relative to Pulverized Coal

New MSW to energy plants are not currently cost competitive with pulverized coal plants. The total levelized cost for a MSW power plant over its economic life converted to equal annual payments is approximately \$85 per MWh compared to \$50 per MWh for a pulverized coal plant. Typically, MSW power plants become economical only for congested areas in the

eastern United States when landfills for MSW disposal are not available near the collection area and hauling costs become excessive.

Commercially Proven and Reliable

MSW technology is commercially proven and reliable, with operating facilities in multiple states.

Place Water Held by White Pine County for Power Production in Steptoe Valley to Beneficial Use for Power Production

Because the feasibility of a MSW project in White Pine County is unlikely, it is doubtful but possible that water held by White Pine County for power production in Steptoe Valley would be put to beneficial use for power production.

Provide Traffic for the NNR

Construction and operation of a MSW plant would be expected to provide traffic for the NNR through the conveyance of refuse-derived fuel to a plant site.

Capable of Meeting Purpose and Need

MSW power cannot fulfill the need for approximately 1,590 MW of long term, cost effective, and competitive generation of baseload capacity because of its high cost, low reliability (limited MSW resources in the region), and difficulty in obtaining a permit. A MSW project would probably not result in the beneficial use of water held by White Pine County for power production in Steptoe Valley, but it could conceivably provide some NNR traffic through the conveyance of fuel from outside the region to a plant site. MSW power does not meet four of the six project evaluation criteria, and it does not meet the overall purpose and need of the proposed Station Project.

2.5.1.3 Nuclear

Capable of Providing Approximately 1,590 MW of Reliable Baseload Power Generation Capacity

A nuclear power plant would be capable of fulfilling the need for approximately 1,590 MW of new, highly reliable, cost effective baseload capacity.

Environmentally Permittable

The permitting and licensing process for a nuclear power plant is more complex and difficult than for a pulverized coal plant.

Cost Effectiveness Relative to Other Energy Technologies

The total levelized cost of a nuclear power plant over its economic life would be comparable to that of a pulverized coal power plant (approximately \$50 per MWh).

Commercially Proven and Reliable

Nuclear power is commercially proven and reliable, with a history of providing dependable baseload generation.

Place Water Held by White Pine County for Power Production in Steptoe Valley to Beneficial Use for Power Production

A nuclear power plant requires a large amount of water for facility operation and cooling purposes. Approximately 35,000 to 40,000 acre-feet of water per year would be required for a nuclear power plant capable of producing the same number of megawatts as would be produced by the White Pine Energy Station. Existing nuclear plants in the United States use surface water resources for water intake and discharge. There is insufficient surface water in White Pine County for the operation of a nuclear power plant. No U.S.-licensed nuclear power plants use ground water for cooling;

therefore, it is considered highly unlikely that the Nuclear Regulatory Commission would approve the use of ground water for plant operation. Therefore, a nuclear power plant would not be expected to be allowed to place the use of water held by White Pine County for power production in Steptoe Valley to beneficial use for power production.

Provide Traffic for the NNR

Construction and operation of a nuclear power plant would be expected to provide little, if any, traffic for the NNR.

Capable of Meeting Purpose and Need

A nuclear power plant is capable of meeting the purpose and need of approximately 1,590 MW of cost effective, highly reliable baseload generation. However, a nuclear power plant would not result in the beneficial use of water held by White Pine County for power production in Steptoe Valley, would be difficult to permit and license, and would contribute little, if any, to traffic on the NNR. A nuclear power plant does not meet three of the six project evaluation criteria, and it does not meet the overall purpose and need of the proposed Station.

2.5.1.4 Non-Renewable Combustible Energy Resources

The non-renewable combustible energy resources evaluated in this section are natural gas combined cycle (NGCC), circulating fluidized bed (CFB) coal, integrated gasification combined cycle (IGCC) coal, and, last, pulverized coal (pulverized coal—the power generating technology selected for the proposed project). As noted in the introduction to this discussion of alternative power generating technologies, pulverized coal technology is described here to inform the

reader and to compare pulverized coal technology to those alternative technologies that were eliminated from detailed evaluation.

2.5.1.4.1 Natural Gas Combined Cycle (NGCC)

Combustion turbine generators are used for simple cycle and combined cycle applications. In simple cycle operation, gas turbines are operated alone, without any recovery of the energy in the hot exhaust gases. Simple cycle gas turbine generators are typically used for peaking or reserve utility power applications, which primarily are operated during the peak summer months (June through September) at less than a total of 2,000 hours per year. Simple cycle applications are rarely used in baseload applications because of the lower heat rate efficiencies compared to a combined cycle configuration.

Combined cycle operation consists of one or more combustion turbine generators exhausting to one or more heat recovery steam generators. The resulting steam generated by the heat recovery steam generators is then used to power a steam turbine generator.

There is a wide range of gas turbine sizes from approximately 1 MW output up to "G" and "H" class machines, which are rated at 240 MW and higher. Gas turbines for electric utility services generally range from a minimum of 20 MW for peaking service up to the largest machines for use in combined cycle mode.

Heat recovery steam generators extract energy from the combustion turbine exhaust gases in order to produce steam. On larger systems, steam is produced at several pressures and temperatures to most efficiently use the energy available. Reheat cycles are incorporated to take

advantage of the higher exhaust temperatures available on the larger advanced technology combustion turbines.

The STG converts the energy produced by the HRSG in the form of steam into electrical energy. Larger STG units generally are pedestal mounted with the condenser located underneath the STG.

The condenser condenses the steam leaving the steam turbine generator and collects the condensate for return to the de-aerator. Condensation is accomplished by dissipating the energy into cooling or circulating water piped to and from a cooling tower (or intake and discharge from a waterway in the case of once-through cooling). Alternatively, an air-cooled condenser may be used on a site that has lack of water availability, cooling tower blowdown disposal problems, cooling tower freeze-up, cooling tower vapor plume problems, or circulating water pollution restrictions (in the case of once-through cooling). Air-cooled condensers present a set of disadvantages: lower cycle efficiency, higher first cost, bigger site, higher noise levels, and higher operation costs.

Capable of Providing Approximately 1,590 MW of Reliable Baseload Power Generation Capacity

NGCC plants have demonstrated high reliability and could supply baseload power generation capacity for the proposed project. Natural gas is not locally available and would require several hundred miles of new pipelines to deliver a sufficient quantity of gas to the plant site for the project. An adequate supply of fuel oil for back-up fuel would be required in order to have the same reliability as a coal-fired plant (WPEA, 2008).

Environmentally Permittable

A natural gas combined cycle facility has lower hazardous air pollutant and carbon dioxide emissions than a comparable coal-fired alternative. There are no major water discharge issues or solid waste/hazardous waste generation issues. Permitting of a NGCC power plant would be achievable.

Cost Effectiveness Relative to Pulverized Coal

NGCC plants have demonstrated high reliability and low maintenance costs. However, the electric power generation cost for a NGCC plant is higher than a pulverized coal plant because of the current high cost of the natural gas fuel. The total levelized cost for a NGCC plant over its economic life converted to equal annual payments is approximately \$57 per MWh compared to \$50 per MWh for a pulverized coal plant. Natural gas cost is highly variable and strongly affected by the economy, production and supply, demand, weather, and storage levels.

White Pine County would not be a favorable location for a NGCC plant because of its high elevations. A plant using NGCC technology at the proposed WPES site would generate approximately 20 percent less capacity than a plant using the same equipment at sea level. To generate the desired capacity, additional generating equipment (in the form of additional combustion and/or steam turbines) would be required, which would result in a significant incremental cost premium for NGCC technology located in White Pine County relative to other potential sites for such a plant.

Further, the supply of natural gas in the U.S. is expected to increase only 1.3 percent by 2030 (EIA, 2008). Increased reliance on natural gas for

energy generation in the future would significantly increase the overall demand for natural gas, resulting in significant upward pricing pressure on natural gas, possibly creating market instability, with higher volatility and potential supply shortages. The pricing pressure and volatility would not only impact the price of electricity, but also the supply and cost of natural gas to residential and industrial consumers (DOE, 2008).

Based on the above information, electricity generated with NGCC would not be expected to be cost effective relative to pulverized coal and could result in higher electricity and natural gas prices for residential and industrial customers.

Commercially Proven and Reliable

NGCC power plants are commercially proven and reliable. Most new baseload power plant facilities built in the United States in the past 10 years have used NGCC technology.

Place Water Held by White Pine County for Power Production in Steptoe Valley to Beneficial Use for Power Production

A NGCC power plant would put to beneficial use water held by White Pine County for power production in Steptoe Valley.

Provide Traffic for the NNR

Construction and operation of a NGCC plant would be expected to provide little, if any, traffic for the NNR.

Capable of Meeting Purpose and Need

A NGCC power plant is a proven and commercially reliable technology for use in baseload power generation capacity and is environmentally permittable. However, natural gas is not locally available for the proposed project, has a higher cost than pulverized coal and a highly variable cost,

and would require the construction of several hundred miles of new pipeline for gas delivery to the proposed plant. An NGCC plant would result in the beneficial use of water held by White Pine County for power production in Steptoe Valley, but it would provide little, if any, traffic for the NNR. NGCC power does not meet two of the six project evaluation criteria, and it does not meet the overall purpose and need of the proposed Station.

2.5.1.4.2 Circulating Fluid-Bed (CFB)

In the mid 1980s, an alternative to the standard pulverized coal fired plant emerged called CFB combustion. The fuel delivery system is similar, although somewhat simplified, to that of a pulverized coal unit, but it has a greater fuel cost advantage because a wider range and lesser quality of fuels can be used (coal, coke, biomass, etc.). The bed material is composed of fuel, ash, sand, and sorbent (typically limestone). CFB units compete in the marketplace in sizes up to 300 MW with larger sizes available soon.

CFB combustion temperatures (1,500 to 1,600°F) are significantly lower than a conventional boiler (3,000°F), which results in lower uncontrolled nitrogen oxide emissions and reduced slagging and fouling that are characteristic of pulverized coal units. In contrast to a pulverized coal plant, sulfur dioxide can be partially removed during the combustion process by adding limestone to the fluidized bed.

The plant fuel handling system unloads and stacks out the fuel, crushes or otherwise prepares the fuel for combustion, and reclaims the fuel as required. The fuel is usually fed into the CFB by gravimetric feeders. In the CFB, the fuel is combusted and steam is produced. Steam is conveyed to the steam

turbine generator, which converts the steam thermal energy into mechanical energy. The turbine then drives the generator to produce electricity.

The CFB produces combustion gases, which must be treated before exiting the exhaust stack to remove fly ash and sulfur dioxide. Nitrogen oxide emissions can be mitigated through use of selective non-catalytic reduction using ammonia injection, usually in the upper area of the combustor. The pollution control equipment external to the CFB includes either a fabric filter (baghouse) or electrostatic precipitator for particulate control (fly ash), and a polishing FGD system for additional removal of sulfur dioxide to achieve similar levels to pulverized coal units. Limestone is required for the most common wet FGD process (limestone forced oxidation desulfurization) and also as sorbent for the fluidized bed.

Similar to a pulverized coal plant, a CFB power plant produces several forms of liquid and solid waste. Liquid wastes include cooling tower blowdown, chemicals associated with water treatment, ash conveying water, and FGD wastewater. Solid wastes include bed and fly ash and FGD solid wastes. As with pulverized coal fired units, disposal of these wastes is a major factor in plant design and cost considerations.

Capable of Providing Approximately 1,590 MW of Reliable Baseload Power Generation Capacity

CFB units are generally installed to burn poor quality or waste coals, but offer no advantage for commercial coal, which would be used in the Station pulverized coal power plant. The CFB technology is capable of fulfilling the need for approximately 1,590 MW of new, highly

reliable baseload generation in eastern Nevada.

Environmentally Permittable

Environmental impacts associated with a CFB coal resource include air emissions, water/wastewater discharge issues, and solid waste disposal. Impacts are minimized by utilizing air pollution control equipment, wastewater pretreatment controls, and the potential reuse of ash. A CFB design has the advantage of being capable of burning a wider range of fuels, including waste materials such as coke or renewable biomass. Because of lower overall efficiency versus pulverized coal-fired technology, regardless of fuel type, a CFB plant would consume more fuel than an identically-sized pulverized coal-fired unit, increasing air emissions, coal deliveries, and solid waste generation as compared to the Proposed Action.

Permitting of a CFB coal power plant is similar to permitting a pulverized coal power plant, described previously.

Cost Effectiveness Relative to Pulverized Coal

The electric power generation cost for a approximately 1,590 MW CFB plant would be slightly higher than a pulverized coal plant because the unit size of a circulating fluid boiler is currently limited to approximately 300 to 350 MW compared to 800 to 900 MW for a pulverized coal unit. As an example, the capital cost of an approximately 1,590-MW 2-unit pulverized coal plant would be lower than a 5-unit CFB power plant because of the economy of scale for equipment cost. The total levelized cost for a CFB plant over its economic life converted to equal annual payments is approximately \$50 per MWh, about the same as a pulverized coal plant.

As discussed in Appendix H, *Alternative Coal-Fueled Generating Technologies*, five or six circulating fluidized bed units (versus a maximum of three pulverized coal units) would be needed in order to generate the steam flows required to generate 1,600 MW, the maximum proposed capacity for the Proposed Action. The use of additional boilers to achieve a given steam flow is more costly because of the increased physical size of the facility, the incremental ancillary equipment to support additional boilers, (for example, conveyors and control systems), and the incremental staff to operate and maintain the additional boilers. Therefore, using CFB technology for the Station would require incremental costs that would not be present with pulverized coal-fired technology.

Commercially Proven and Reliable

The CFB technology is commercially proven and reliable, having demonstrated technical feasibility in commercial utility applications for about 20 years. The largest CFB units in operation are about 300 MW in size.

Place Water Held by White Pine County for Power Production in Steptoe Valley to Beneficial Use for Power Production

A CFB power plant would put to beneficial use water held by White Pine County for power production in Steptoe Valley.

Provide Traffic for the NNR

Construction and operation of a CFB plant would result in traffic for the NNR, primarily through the conveyance of fuel to the power plant.

Capable of Meeting Purpose and Need

A CFB power plant would be capable of providing approximately 1,590 MW of reliable, environmentally permittable,

baseload power generation. It also would result in the beneficial use of water held by White Pine County for power production in Steptoe Valley, would contribute to traffic for the NNR, and would have approximately the same levelized cost as a pulverized coal power plant. A CFB power plant meets all six of the project evaluation criteria. However, CFB does require a higher capital cost and offers no technical, operating economics, or environmental advantages over pulverized coal.

2.5.1.4.3 Integrated Gasification Combined Cycle (IGCC)

Coal gasification for use in power generation reacts coal with steam and oxygen under high pressure and at high temperature to produce a gaseous mixture consisting primarily of hydrogen and carbon monoxide. The gaseous mixture requires cooling and cleanup to remove contaminants and pollutants to produce a synthesis gas suitable for use in the combustion turbine portion of a combined cycle unit. The combined cycle portion of the plant is similar to a conventional combined cycle. The most significant differences in the combined cycle are modifications to the combustion turbine. These modifications allow use of a 250 to 300 Btu/SCF gas and steam production via heat recovery from the raw gas in addition to the combustion turbine exhaust. Specifics of a plant design are influenced by the gasification process, degree of heat recovery, and methods to clean up the gas.

IGCC has been demonstrated in a few commercial-scale facilities. A variety of coals have been gasified, the resulting gases have been cleaned up to allow use in combustion turbines, and electricity has been generated. However, the capital cost and performance in a number of areas have not been as attractive as expected.

The troublesome areas for IGCC have included high-temperature heat recovery and hot gas cleanup. An important part of achieving an attractive heat rate is generation of high pressure and temperature steam from the high-temperature raw gas generated by gasifying coal.

The temperature of the raw gas is dependent on the gasification process and the coal. Slagging gasifiers, such as the Texaco process, typically generate gases in the 2,500 to 2,800°F range. These high-temperature gases contain corrosive compounds, such as hydrogen sulfide, that create a very demanding environment for the generation of high pressure and temperature steam. The reliable generation of steam under these conditions has not been demonstrated in a commercial application.

Alternatives of not recovering the heat in the raw gas, such as direct quenching of the gas, result in lower efficiencies. It also is attractive from an efficiency perspective to provide clean gas to the combustion turbine at an elevated temperature without cooling and reheating, hence the desire to use hot gas cleanup. Again, this demanding service has not been reliably demonstrated in a commercial application, resulting in less efficient approaches being used for current plants.

Of the approximately 20 recently proposed IGCC projects, 15 have been canceled or put on hold. In addition, most of the IGCC projects have been proposed at lower elevations (less than 2,000 feet above sea level). Only 4 have also proposed the incorporation of carbon capture as a control for carbon dioxide, and all of these projects have been delayed or cancelled. Additional information on IGCC has been provided in Appendix H, *Alternative Coal-Fueled Generating Technologies*.

As relevant to the discussion of alternatives evaluation criteria, information from Appendix H has been added to the various IGCC discussions in the following text.

Capable of Providing Approximately 1,590 MW of Reliable Baseload Power Generation Capacity

The IGCC technology is not capable of providing approximately 1,590 MW of reliable baseload power generation for the proposed project. IGCC has problem areas that have not demonstrated acceptable reliability. The current approaches to improving reliability in these areas result in less efficient facilities. The U.S. Department of Energy has a program, Vision 21, with the goal of providing clean coal power-generation alternatives, which includes improving the cost-competitiveness of IGCC. However, the current U.S. Department of Energy time frame (by 2015) does not support the proposed project's schedule needs.

IGCC is still a developing technology. Current IGCC plants are small scale (300 MW or less) and were funded in part with government subsidies. New IGCC plants are being proposed at up to 600 MW in size, but larger plants are not being considered because of the uncertainties associated with the technology. As discussed in Appendix H, *Alternative Coal-Fueled Generating Technologies*, the availability histories of the six successful IGCC demonstration projects show that most were able to reach 70 percent to 80 percent availability but only after at least 5 years of operation. In comparison, pulverized coal-fired generation has been shown to have an expected minimum availability of 90 percent generally achievable within the first year of commercial operation.

Environmentally Permittable

The overall environmental impacts from an IGCC design would be between those of a natural gas combined cycle turbine resource and a coal resource.

Environmental impacts would include air emissions, water/wastewater discharge, and solid waste disposal. This technology should be permittable in Nevada

Cost Effectiveness Relative to Pulverized Coal

IGCC has the potential to generate electricity using coal with a higher thermal efficiency relative to pulverized coal technology and with lower emissions of some criteria pollutants (and higher emissions of others) than conventional coal power plants. The combined cycle portion of the process is attractive from a capital cost perspective compared to a conventional coal plant, but the addition of gasification, coal feeding, gas cooling, gas cleanup, and oxygen plant results in an overall cost that is higher than a conventional coal plant. The total levelized cost for a IGCC plant over its economic life converted to equal annual payments is approximately \$62 per MWh compared to \$50 for a pulverized coal plant. Until national legislation requiring carbon dioxide capture and sequestration is passed, IGCC will likely continue to have a cost disadvantage.

Higher efficiency than a conventional coal plant could justify higher capital costs. However, the currently demonstrated capital cost is approximately 20 to 30 percent higher and efficiency is about 5 percent better than a conventional coal plant. This cost and performance does not result in a cost of electricity that is competitive with a conventional coal plant. An effort to design an IGCC plant in northern Nevada using western coals was

unsuccessful and was converted into an NGCC plant. For IGCC facilities operating on eastern coal, a significant issue has been the poor reliability of the gasifier.

Existing IGCC plants have efficiency values that are similar to or lower than modern pulverized coal plants. Thus, based on the demonstrated performance of IGCC technology, the use of IGCC would not be expected to create any fuel cost savings compared to a modern pulverized coal plant.

New IGCC plants are acknowledged to be substantially more expensive to construct, and represent significant commercial risks associated with actual performance (reliability, efficiency, and environmental).

Performance of an IGCC plant at a location in White Pine County would be hindered by the high elevations found in White Pine County, resulting in reduced power production capability of the combustion turbines. Additional equipment would be needed to produce the desired amount of power, representing additional costs compared to an identical facility constructed at a lower-elevation location.

If the gasifier at an IGCC plant located in White Pine County failed, no back-up fuel supply would be available to make the project useful because natural gas is not available in White Pine County. To provide a back-up natural gas fuel supply, one or more natural gas pipelines would need to be constructed, each more than 200 miles long. Construction of the pipelines would represent a significant additional cost associated with IGCC.

Commercially Proven and Reliable

IGCC has been demonstrated in a few commercial-scale facilities. The current IGCC plants are providing good information about the technology. However, they are not demonstrating the necessary performance to expect the technology to be commercially proven, reliable, and available in a time frame to support the proposed project.

IGCC is still a developing technology. Current IGCC plants are small scale (300 MW or less) and were funded in part with government subsidies. New IGCC plants are proposed at up to 600 MW in size, but larger plants are not being considered because of the uncertainties associated with the technology. As a result, the feasibility of constructing and operating a 1,600-MW IGCC plant remains unproven.

Existing IGCC plants have not achieved the reliability needed for a large, baseload generation facility. Existing coal-fueled IGCC plants have required operating experience of 8 years or more to approach 80 percent equivalent availability, a value that is expected to be surpassed in the first year of operation with a pulverized coal plant.

IGCC has not been proven capable to operate solely on Powder River Basin coal, and concerns with this issue remain on the new generation of IGCC. In addition, the location of the Proposed Action is not well located with regard to other fuel supplies that have been demonstrated feasible with IGCC technology (petcoke, natural gas, or large reserves of bituminous coal).

Place Water Held by White Pine County for Power Production in Steptoe Valley to Beneficial Use for Power Production

An IGCC power plant, if and when commercially available, could use water held by White Pine County for power production in Steptoe Valley to beneficial use for power production.

Provide Traffic for the NNR

Construction and operation of an IGCC plant, if and when commercially available, would result in traffic for the NNR, primarily through the conveyance of fuel to the power plant.

Capable of Meeting Purpose and Need

The IGCC technology is not capable of meeting purpose and need for new baseload power generation because it has not demonstrated acceptable reliability. It also has a higher cost than a pulverized coal power plant. An IGCC power plant does not meet three (baseload generation, cost-effectiveness, and commercially proven and reliable) of the six project evaluation criteria, and it does not meet the overall purpose and need of the proposed Station.

2.5.1.4.4 Pulverized Coal

A pulverized coal power plant was proposed and selected as the power generating technology for the proposed Station. It is described in the following text for purposes of comparison to those alternative energy technologies that were eliminated.

Modern pulverized coal power plants generally range in size from 80 MW to more than 1,600 MW and can use coal from various sources. Coal is most often delivered by unit train to the site, although barges or trucks are also used. Many plants are situated adjacent to the coal source

where coal can be delivered by conveyor. Coal can have various characteristics with varying Btu heating values, sulfur content, and ash constituents. The source of coal and coal characteristics can have a significant effect on the plant design in terms of coal-handling facilities and types of pollution control equipment required.

Regardless of the source, the plant coal-handling system unloads the coal, stacks out the coal, reclaims the coal as required, and crushes the coal for storage in silos. The coal is then fed from the silos to the pulverizers and blown into the steam generator. The steam generator mixes the pulverized coal with air, which is combusted, and in the process produces heat to generate steam. Steam is conveyed to the steam turbine generator, which converts the steam thermal energy into mechanical energy. The turbine then drives the generator to product electricity.

The steam generator produces combustion gases, which must be treated before exiting the exhaust stack to remove fly ash, nitrogen oxide, and sulfur dioxide. The pollution control equipment includes either a fabric filter (baghouse) or electrostatic precipitator for particulate control (fly ash), selective catalytic reduction for removal of nitrogen oxide, and flue gas desulfurization (FGD) system for removal of sulfur dioxide. Limestone is required as the reagent for the most common wet FGD process, known as limestone forced oxidation desulfurization. A limestone storage and handling system is a required design consideration with this system.

Pulverized coal plants produce several forms of liquid and solid waste. Liquid wastes include cooling tower blowdown, coal pile runoff, chemicals associated with water treatment, ash conveying water, and FGD wastewater. Solid wastes include

bottom and fly ash and FGD solid wastes. Disposal of these wastes is a major factor in plant design and cost considerations.

Capable of Providing Approximately 1,590 MW of Reliable Baseload Power Generation Capacity

A pulverized coal power plant is capable of fulfilling the need for approximately 1,590 MW of new, highly reliable baseload generation in eastern Nevada.

Environmentally Permittable

Environmental impacts associated with pulverized coal resources include air emissions, water/wastewater discharge issues, and solid waste disposal. Impacts are minimized by utilizing air pollution control equipment, wastewater pretreatment controls, and the potential reuse of ash.

Permitting of a pulverized coal power plant typically requires numerous permits and approvals from federal, state, and local regulatory agencies. A major source Prevention of Significant Deterioration air construction permit would be required. The permit application, agency review and follow-up, and public comment process can be extensive for a new coal-fired resource.

Cost Effectiveness Relative to Other Energy Technologies

Pulverized coal plants, although having a high capital cost relative to some alternatives, have an advantage over other non-renewable combustible energy source technologies because of the relatively low and stable cost of coal. The relatively low fuel cost for coal results in a low cost of electricity. Over half of the electricity generated in the United States comes from coal-fired units, and almost all of it from pulverized coal units. There have not been many new pulverized coal units in recent

years, but current fuel costs result in coal being the economical choice for large additions of new generation in areas with reasonable access to coal. The total levelized cost for a pulverized coal power plant over its economic life converted to equal annual payments is approximately \$50 per MWh.

Commercially Proven and Reliable

Pulverized coal is commercially proven and reliable, with a long history of being the technology of choice for large baseload utility units. Pulverized coal plants represent the most mature of technologies considered in this analysis.

Place Water Held by White Pine County for Power Production in Steptoe Valley to Beneficial Use for Power Production

A pulverized coal power plant would put to beneficial use water held by White Pine County for power production in Steptoe Valley.

Provide Traffic for the NNR

Construction and operation of a pulverized coal plant would result in traffic for the NNR, primarily through the conveyance of commercial coal to the power plant.

Capable of Meeting Purpose and Need

A pulverized coal power plant is capable of meeting the purpose and need of approximately 1,590 MW of cost effective, highly reliable baseload generation. A pulverized coal plant would result in the beneficial use of water held by White Pine County for power production in Steptoe Valley, is environmentally permittable, and would contribute to traffic for the NNR. A pulverized coal power plant meets all six of the project evaluation criteria and the overall purpose and need of the proposed station.

2.5.2 Conservation/Energy Efficiency

The need for additional electric power forecasted by the Energy Information Agency and the Western Electricity Coordinating Council was described in Section 1.2, *Purpose, Need, and Background*. Those forecasts assume a reasonable amount of conservation will occur and is factored into the demand.

Energy efficiency and conservation programs, either alone or in combination with other programs and energy sources (renewables), are not expected to eliminate the current and future need for new baseload generation. These programs may be a part of the solution to future energy needs, but they are not reasonably expected to supplant the need for additional baseload generation and so are not alternatives to the proposed project.

The projections for future load growth described in the purpose and need discussion in Section 1.2, *Purpose, Need, and Background*, of this FEIS include consideration of reasonably expected conservation/energy efficiency programs. In addition, the Public Utility Commission of Nevada has recently reported a projected capacity shortfall of 4,000 MW by 2020 if new generation capacity is not added (Public Utilities Commission of Nevada, 2007). The Public Utilities Commission of Nevada has supported utility-sponsored conservation and energy efficiency programs since 1984, and utilities have greatly increased spending to fund demand-side reduction programs. Additionally, Nevada's Renewable Portfolio Standard provides incentive for additional conservation and energy efficiency; however, demand for electricity in Nevada is expected to continue to grow, regardless of the range

of reasonably expected conservation and energy efficiency programs.

Elsewhere in the West, future load growth is expected, even when conservation and energy efficiency programs are considered. For example, Tri-State Generation and Transmission Association, Inc. (Tri-State), which serves customers in New Mexico, Colorado, and Wyoming, has stated a need for additional baseload generating capacity in both the near-term and long-term. This need for additional capacity is in addition to the current and anticipated future energy conservation and efficiency programs sponsored by the company. Tri-State plans to pursue 700 MW of coal-fired baseload capacity to satisfy its near-term need for new generation (Tri-State, 2007). Also, PacifiCorp has stated a need for additional baseload generating capacity, particularly in its eastern system, which includes Idaho, Utah, and Wyoming. PacifiCorp reiterated its desire to add approximately 1,700 MW of baseload and intermediate load resources to its eastern system by 2016. This additional capacity would help offset projected deficiencies of 800 MW by 2010 and 3,000 MW by 2016 in the PacifiCorp system (PacifiCorp, 2007). Finally, in Arizona, the need for baseload power grows by approximately 100 MW annually (Arizona Public Service Co., 2006), despite multiple conservation and energy efficiency programs sponsored by the company.

Based on the information in the previous text, while conservation and energy efficiency programs will reduce the rate of load growth in the Western United States, load growth is expected to occur under any reasonably foreseeable scenario. Baseload generation will be needed to satisfy this growing demand.

To provide additional conservation to offset the amount of electric generation proposed for the White Pine Energy Station is not a reasonable alternative to the action alternatives. Further, it is uncertain if any entities have the ability to enforce or require the amount of conservation needed to offset projected baseload demand, but it clearly is not within the BLM's or WPEA's ability to require that conservation. Conservation/energy efficiency, while important, cannot meet the purpose and need of the project and therefore cannot be considered as an alternative.

2.5.3 Alternative Power Plant Site Locations

WPEA undertook a study of potential plant site locations in the early planning stages of the project. Results of the site selection study for the proposed Station are summarized in the following text. Siting study tasks included delineation of the study area boundary, identification of specific study regions and associated constraints in each region, identification of potential site areas by region for the Station, and comparison, evaluation, and selection of sites for detailed evaluation in this FEIS. Sites that were considered but eliminated from detailed evaluation are described in the following text together with the rationale for their elimination. The Proposed Action and Alternative 1, which were selected for detailed evaluation in this FEIS based on the comparison of alternative power plant sites, also are described in the following text. The full siting study report, together with supporting figures, is presented in *Siting Study for the Proposed White Pine Energy Station* (WPEA, 2005).

Steptoe Valley in White Pine County from Ely north to the White Pine/Elko county line was evaluated for potential sites for the

construction of the Station. This study area boundary was selected for the following reasons:

- It meets project purpose and need.
- The Station must be located in White Pine County to utilize the water available from White Pine County in a locally beneficial manner.
- This part of Steptoe Valley is the only area in White Pine County that has ready access to all required infrastructure components for the Station (that is, rail, SWIP corridor, water resources, and highway access).

No other locations in White Pine County have ready access to all of the required infrastructure components and were therefore eliminated from detailed evaluation. The study area east of U.S. 93 (north of McGill) was eliminated from detailed evaluation because it would require construction of more infrastructure, which would result in greater environmental impacts and additional costs, than the study area west of U.S. 93.

The remaining study area was divided into the northern, central, southern, and Ely-McGill study regions, which are depicted in Figure 2-19. Each of the four regions extends approximately 15 miles north to south. Constraints were then identified in each region in an attempt to avoid impacts on certain natural resources and avoid engineering feasibility issues. The siting analysis focused on ensuring engineering feasibility, minimizing environmental and socioeconomic impacts, and minimizing construction and operation costs of the Station.

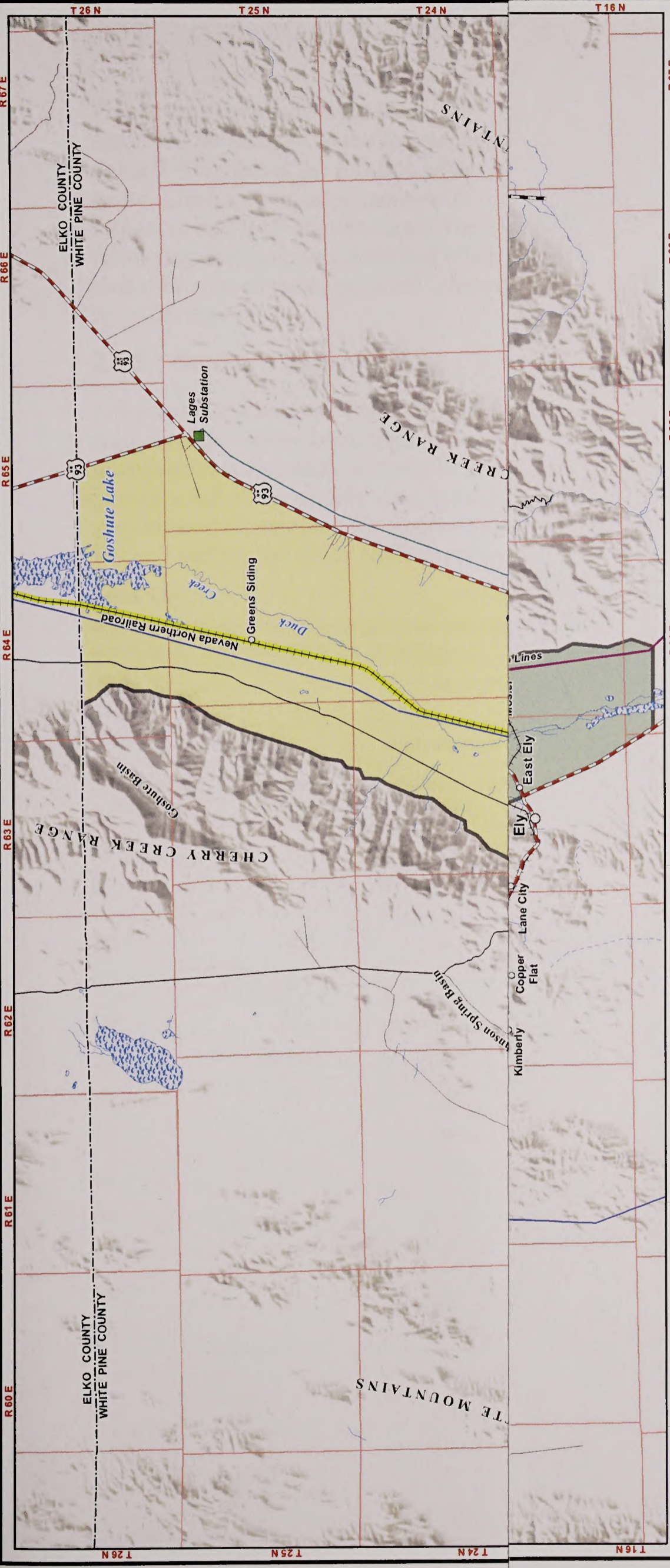

Areas Assessed for Power Plant Siting White Pine Energy Station Project

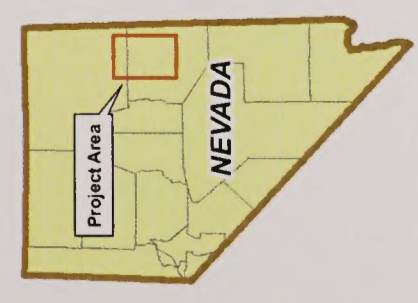

NEVADA

0 1.5 3 Miles

1:320,000 when printed at 11 x 17 inches

<p>Existing Electrical Features</p> <ul style="list-style-type: none"> Existing Substation Existing Transmission Line Existing Distribution Line 	<p>Surface Water</p> <ul style="list-style-type: none"> Perennial Stream or River Wetland 	<p>Connected Action</p> <ul style="list-style-type: none"> SWIP Transmission Line NNR Upgrade 	<p>Common Project Features</p> <ul style="list-style-type: none"> Minerals Materials Sale Area Moriah Ranches Seeding Project
<p>Proposed Action Project Features</p> <ul style="list-style-type: none"> Proposed Well Site Proposed Water Pipeline/ Distribution Line Proposed Rail Spur Proposed Transmission Line Proposed Electric Distribution Line Proposed Access Road Proposed Substation Site Proposed Power Plant Site 	<p>Alternative 1 Project Features</p> <ul style="list-style-type: none"> Proposed Well Site Proposed Water Pipeline/ Distribution Line Proposed Rail Spur Proposed Transmission Line Proposed Electric Distribution Line Proposed Access Road Proposed Substation Site Proposed Power Plant Site 	<p>Study Areas</p> <ul style="list-style-type: none"> Northern Study Area Central Study Area Southern Study Area Ely-McGill Study Area 	

Figure 2-19

To provide additional conservation to offset the amount of electric generation proposed for the White Pine Energy Station is not a reasonable alternative to the action alternatives. Further, it is uncertain if any entities have the ability to enforce or require the amount of conservation needed to offset projected baseload demand, but it clearly is not within the BLM's or WPEA's ability to require that conservation. Conservation/energy efficiency, while important, cannot meet the purpose and need of the project and therefore cannot be considered as an alternative.

2.5.3 Alternative Power Plant Site Locations

WPEA undertook a study of potential plant site locations in the early planning stages of the project. Results of the site selection study for the proposed Station are summarized in the following text. Siting study tasks included delineation of the study area boundary, identification of specific study regions and associated constraints in each region, identification of potential site areas by region for the Station, and comparison, evaluation, and selection of sites for detailed evaluation in this FEIS. Sites that were considered but eliminated from detailed evaluation are described in the following text together with the rationale for their elimination. The Proposed Action and Alternative 1, which were selected for detailed evaluation in this FEIS based on the comparison of alternative power plant sites, also are described in the following text. The full siting study report, together with supporting figures, is presented in *Siting Study for the Proposed White Pine Energy Station* (WPEA, 2005).

Steptoe Valley in White Pine County from Ely north to the White Pine/Elko county line was evaluated for potential sites for the

construction of the Station. This study area boundary was selected for the following reasons:

- It meets project purpose and need.
- The Station must be located in White Pine County to utilize the water available from White Pine County in a locally beneficial manner.
- This part of Steptoe Valley is the only area in White Pine County that has ready access to all required infrastructure components for the Station (that is, rail, SWIP corridor, water resources, and highway access).

No other locations in White Pine County have ready access to all of the required infrastructure components and were therefore eliminated from detailed evaluation. The study area east of U.S. 93 (north of McGill) was eliminated from detailed evaluation because it would require construction of more infrastructure, which would result in greater environmental impacts and additional costs, than the study area west of U.S. 93.

The remaining study area was divided into the northern, central, southern, and Ely-McGill study regions, which are depicted in Figure 2-19. Each of the four regions extends approximately 15 miles north to south. Constraints were then identified in each region in an attempt to avoid impacts on certain natural resources and avoid engineering feasibility issues. The siting analysis focused on ensuring engineering feasibility, minimizing environmental and socioeconomic impacts, and minimizing construction and operation costs of the Station.

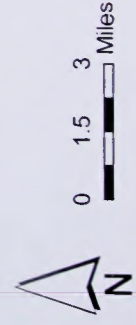
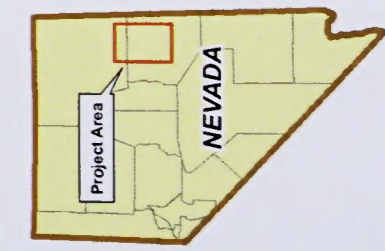
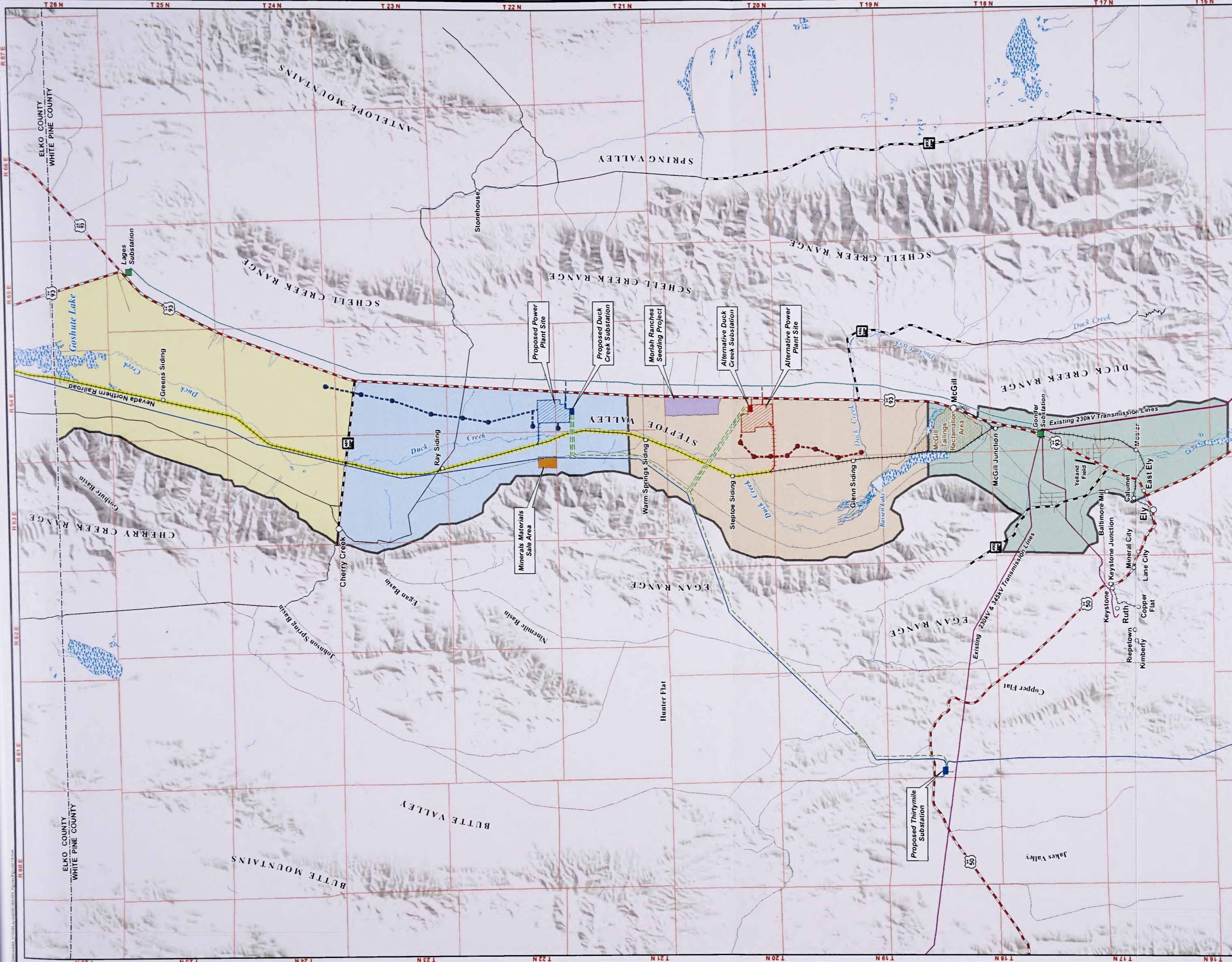

- Existing Electrical Features**
- Existing Substation
 - Existing Transmission Line
 - Existing Distribution Line
- Surface Water**
- Perennial Stream or River
 - Wetland
- Connected Action**
- SWIP Transmission Line
 - NNR Upgrade
- Common Project Features**
- Minerals Materials Sale Area
 - Moriah Ranches Seeding Project

- Proposed Action Project Features**
- Proposed Well Site
 - Proposed Water Pipeline/Distribution Line
 - Proposed Rail Spur
 - Proposed Transmission Line
 - Proposed Electric Distribution Line
 - Proposed Access Road
 - Proposed Substation Site
 - Proposed Power Plant Site

- Alternative 1 Project Features**
- Proposed Well Site
 - Proposed Water Pipeline/Distribution Line
 - Proposed Rail Spur
 - Proposed Transmission Line
 - Proposed Electric Distribution Line
 - Proposed Access Road
 - Proposed Substation Site
 - Proposed Power Plant Site

- Study Areas**
- Northern Study Area
 - Central Study Area
 - Southern Study Area
 - Ely-McGill Study Area

Areas Assessed for Power Plant Siting
White Pine Energy Station Siting

Figure 2-19

Thirteen potential site areas were identified for analysis in the four regions. Table 2-5 compares the location of the major infrastructure components with respect to each potential site area. The following text compares these and other characteristics of the 13 potential site areas by study region.

2.5.3.1 Northern Study Region

Site areas in the northern region would require longer transmission lines to interconnect at Robinson Summit, longer pipelines and a less reliable water supply system, longer commutes for laborers from Ely and McGill, but fewer NNR upgrades

than site areas in the other regions (Table 2-5).

Site area N1 has numerous disadvantages compared to sites N2 and N3, including but not limited to: (1) an additional transmission line would be constructed that would have environmental impacts, which could be avoided with selection of other sites, (2) greater commute distance from the Ely-McGill area, (3) additional impacts to Duck Creek because of a rail crossing, and (4) greater impacts to private lands and residences. Site area N1 was therefore eliminated from detailed evaluation.

TABLE 2-5

Approximate Distance to Major Infrastructure Components for Potential Site Areas in the Northern (N), Central (C), Southern (S), and Ely-McGill (E-M) Study Regions

Potential Site Area	Approximate Distance to Major Infrastructure (miles)				
	Nevada Northern Railway	High-Voltage Transmission System		Water Supply System	Road Access to U.S. 93
		Outside of SWIP Corridor	Total Length to Robinson Summit		
N1	4	5	62	0	0
N2	2	2	48	6	7 (U.S. 93) 3 (SR-489)
N3	4	4	52	0	0
C1	3	3	46	0	0
C2	1	2	33	0	0
S1	1	0	26	3	5
S2	2	4	30	0	0
S3	3	6	30	0	0
S4	1	7	30	2	4
S5	2	12	36	2	0
EM1	0	0	21	10	0
EM2	2	3	29	21	0
EM3	1	0	26	18	3

Site area N2 is relatively small, constrained by topography (some parts are steep while others are low-lying near Duck Creek), and is bisected by an existing north to south county road. Also, this site is near the community of Cherry Creek with an estimated population ranging seasonally between 15 and 40 people. Site area N3 has generally similar characteristics to site area N2, but without the previously mentioned constraints. Site area N2 was therefore eliminated from detailed evaluation.

Site area N3 includes the potential power plant site identified in NEPA documentation completed in 1984 for the White Pine Power Project proposed by the Los Angeles Department of Water and Power. Site area N3 was carried forward for comparison with site areas identified in the other study regions.

2.5.3.2 Central Study Region

This region has little population with only scattered residences. The Pony Express Trail is in the northern half of the region and the area surrounding it is sensitive from a viewshed perspective. Infrastructure needs at sites in this region would be balanced between NNR upgrades and the potential to minimize new transmission line construction (Table 2-5).

Site area C1 is approximately 10 miles north of site area C2 (see Figure 2-19). Both areas have similar access to U.S. 93 and the water supply system. Site area C2 would require less transmission line construction outside of the SWIP corridor, and substantially less transmission line construction in general because it is closer to Robinson Summit. In addition, the transmission line for site area C1 would pass within 2 miles of two additional greater sage-grouse leks compared to site area C2.

Site area C2 is closer to the NNR, requiring a shorter rail spur. Site area C2 also is closer, and a shorter commute, to Ely-McGill. Site area C1 offers no significant advantages over site area C2 and was therefore eliminated from detailed evaluation. Site area C2 was carried forward for comparison with site areas identified in the other study regions.

2.5.3.3 Southern Study Region

Site areas in the southern region would require more upgrades to the NNR than site areas in the central and northern regions but fewer upgrades than in the Ely-McGill region (Table 2-5).

Site areas in the northern portion of this region generally would require fewer infrastructure improvements than site areas in the southern portion. Site areas S3, S4, and S5 are similar in that none require crossing Duck Creek with the rail spur or water pipeline; however, the transmission line would cross Duck Creek (see Figure 2-19). Site area S5 is the farthest removed from the infrastructure and is also the closest to Bassett Lake, Steptoe Slough, McGill, and the Duck Creek pass. It has a shorter rail spur, but longer transmission line, water pipeline, and road improvements than site area S3. Site area S5 does not appear to offer any significant advantages over site area S3 and was therefore eliminated from detailed evaluation.

Site area S4 is 4 miles from U.S. 93, directly west of the Duck Creek pass, and in the direct line of sight of traffic coming out of Duck Creek Basin. In addition, an electric transmission line from site area S4 to the SWIP corridor has a higher likelihood of impacting greater sage-grouse leks than site area S3. Site area S4 does not appear to offer any significant advantages over site area S3 and was therefore eliminated from detailed evaluation.

The primary difference between site areas S3 and S2 is that the rail spur within site area S2 would require crossing private property and Duck Creek (see Figure 2-19). These impacts could be avoided with the selection of site area S3. Site area S2 was therefore eliminated from detailed evaluation.

Site area S1 would potentially have the least amount of transmission line built and not cross Duck Creek, and the rail spur would cross private property but not Duck Creek (see Figure 2-19). However, an existing rural gravel road would need to be upgraded, causing increased traffic past nearby residences. Also, the water pipeline would cross Duck Creek. The area west of the gravel road was eliminated as a potential Station site because of construction challenges and costs associated with the 5 to 8 percent grade of the terrain. The area east of the gravel road is comprised of approximately 1,500 acres, about half of which is private property. A Station site in the eastern area would be within 2 miles of existing residences and require that fee rights to private property be obtained. For the reasons stated in previous text, site area S1 was eliminated from detailed evaluation. Site area S3 was carried forward for comparison with site areas identified in the other study regions.

2.5.3.4 Ely-McGill Study Region

Site areas in this region would require more upgrades to the NNR and longer lengths of water supply system pipelines than in any other study region because it is farthest south (Table 2-5). In addition, the increased train traffic from the project would have a greater impact on residences and delaying road traffic in the Ely-McGill region than other regions. Site areas within

this region would offer the benefit of shorter commute distances for employees and better access to local services.

Each site area in the Ely-McGill study region poses construction feasibility issues, significant increases in project costs, and potential conflicts with surrounding land use. Site areas EM1 and EM3 present construction challenges because of the steep terrain, plus these areas would require rail sidings to unload coal trains and likely cause roads to be rerouted or closed. Locating the Station at site EM2 would conflict with the residential development pattern in this area. Generally, a site in the Ely-McGill region has the greatest potential to adversely affect the greatest percentage of people in White Pine County through potential traffic delays because of increased train traffic, noise impacts, and visual impacts. In addition, a significant amount of rail upgrades and water pipeline construction would be needed to service these sites. These impacts would be significant and could be avoided with the selection of sites in other study regions. Site areas EM1, EM2, and EM3 were therefore eliminated from detailed evaluation.

2.5.3.5 Comparison and Evaluation of Remaining Sites (N3, C2, and S3)

Site areas N3, C2, and S3 were identified from among the 13 site areas in the four study regions for additional comparison. Specific station locations were identified in each site area to aid in the evaluation and comparison of the three sites. Table 2-6 compares infrastructure and environmental items of interest at the three alternative Station sites.

TABLE 2-6

Comparison of Infrastructure and Environmental Items of Interest at Station Sites for the Central, Southern, and Northern Alternatives

Item of Interest		Central Alternative	Southern Alternative	Northern Alternative			
Infrastructure							
Rail Spur	Length (feet)	5,500	15,000	24,200			
Transmission Line	Length to Robinson Summit (miles)	34	29	55			
Nevada Northern Railroad Upgrade	Length to Shafter (miles)	85	98	66			
Environmental							
Project Site	Estimated ROW acreage	1,280	1,330	1,560			
Transmission Line	Estimated ROW acreage	1,015	910	1,355			
Rail Spur	Estimated ROW acreage	15	37	56			
	Riparian Area	8	0	7			
	Sand Dunes (based on topography maps)	0	0	2			
Water Pipeline	Estimated ROW acreage	241	241	0			
Access Road(s)	Estimated ROW acreage	14	9	5			
Total ROW acreage		2,565	2,527	2,975			
Distance		1 Mile	2 Miles	1 Mile	2 Miles	1 Mile	2 Miles
Greater Sage-Grouse Leks	Project Site	0	1	0	0	0	0
	Transmission Line	5	7	3	6	6	10
	Rail Spur	0	0	0	0	0	0
	Water Pipeline	0	0	0	0	0	0
	NNR (in White Pine County)	0	4	1	8	0	2
	Total Greater Sage-Grouse Leks	5	12	4	14	6	12
Sensitive Species (within 1 mile)	Project Site	0	0	0	0	0	0
	Transmission Line	1	0	0	0	0	1
	Rail Spur	0	0	0	0	0	0
	Water Pipeline	0	0	0	0	0	0
	NNR (in White Pine County)	2	7	0	0	0	1
Total Sensitive Species (within 1 mile)	3	7	0	0	0	2	
Socioeconomic	Approximate Distance from Ely (road miles)	32	21	49			

Comparison of the three sites shows that the Central and Southern Alternatives have a distinct advantage over the Northern Alternative. The Central and Southern Sites would require less construction of new

infrastructure and are closer to the communities of McGill and Ely, which is consistent with the purpose and need statement for the proposed project (see Section 1.2, *Purpose, Need, and*

Background). Specifically, the Northern Alternative Site would require more transmission line, a longer rail spur, larger ROW acreages, and be farther from McGill and Ely than either the Central or Southern Alternative Sites. All three sites have comparable potential impacts to greater sage-grouse leks. More sensitive species occur within 1 mile of the Southern Alternative Site than the two other sites. However, these species occurrences are related to the NNR, which is an existing facility to be upgraded (rather than a new facility to be constructed).

The primary advantage of the Northern Alternative Site is that fewer NNR upgrades would be required because coal trains would not travel as far south into Steptoe Valley. However, the cost of railroad upgrades would be less than the cost of constructing new transmission line on a per mile basis. In addition, the environmental impacts of upgrading an existing rail line would likely be less than constructing a new transmission line and would result in less public and private lands used for the project.

The *White Pine Power Project Final EIS* (BLM, 1984a) identified the Northern Alternative Site area as having a high potential for cultural resources, especially in and around the sand dunes where intact resources likely occur. Portions of the sand dunes would be disturbed during construction of the rail spur and electric line. These impacts could be avoided at the Central Alternative and Southern Alternative Sites. In addition, while the rail spur on the Northern Alternative Site could avoid the main bed of Duck Creek, it would still need to cross a wide low-lying area that contains several other drainage fingers of Duck Creek. The Southern Alternative Site provides the ability to build a rail spur without crossing Duck Creek and its related drainage features, so carrying the Northern

Alternative Site forward for this reason alone is not justified. Other potential detriments of the Northern Alternative Site include the less reliable water supply system, impact to considerably more grazing permittees, and the shallow ground water table on portions of the site, as identified in the *White Pine Power Project Final EIS* (BLM, 1984a). A shallow ground water table at the Northern Alternative Site could substantially increase construction costs and result in greater environmental impacts from having to perform construction dewatering activities.

The only apparent potential advantage of the Northern Alternative Site is fewer upgrades to the NNR. The increased environmental and land impacts for other aspects of this site could be avoided and/or minimized by selecting the Central and/or Southern Alternative Sites. It is noteworthy that when the *White Pine Power Project Final EIS* was being prepared, potential sites in the Central and Southern study regions were classified as non-attainment status for sulfur dioxide air emissions. Thus, there was an incentive and need at that time to locate the White Pine Power Project farther north in Steptoe Valley. Based on the reasons stated in the previous text, the Northern Alternative Site is not considered a site to be carried forward for detailed evaluation in this FEIS and was therefore eliminated from detailed evaluation.

The Central and Southern Alternative Sites are the most suitable sites to be consistent with project purpose and need and to minimize environmental impacts and construction costs of the Station. These sites were carried forward for further environmental analysis in this FEIS and are referred to as the Proposed Action (Central Alternative Site) and Alternative 1 (Southern Alternative Site).

2.5.4 Alternative Air Pollution Control Technologies

Air pollution control technologies proposed for use at the White Pine Energy Station were selected through Best Available Control Technology (BACT) analysis as part of the air quality permitting process. This analysis was reviewed and approved by the Nevada Division of Environmental Protection-Bureau of Air Pollution Control (NDEP-BAPC) as meeting the requirements of 40 CFR Part 52.21 Prevention of Significant Deterioration (PSD) of Air Quality. A detailed summary of the BACT process and WPEA's BACT analysis is provided in Appendix D, *Evaluation of Alternative Control Strategies*.

The PSD rules require applicants to evaluate all available control alternatives for PSD pollutants that exceed the PSD significance thresholds and select the best available alternative, considering the associated environmental, energy, and economic impacts. In evaluating pollution control technologies, tradeoffs may be associated with environment impacts. The lowest air emission does not necessarily have the lowest environmental impact. It is possible to produce more of one pollutant while trying to control another. Examples include the potential increase of ammonia emissions when controlling for nitrogen oxides or the increase sulfuric acid when controlling for sulfur dioxide. Other environmental tradeoffs could include electrical efficiency and conservation, conservation of water resources, and the minimization of wastes that are generated in the pollution control process.

The EPA BACT Process includes a five-step "top-down" process for considering all

available control technologies from most stringent to least stringent. The most stringent control technology is considered BACT unless the applicant demonstrates, and the permitting authority agrees, that technical considerations (or energy, environmental or economic impacts) justify elimination of the most stringent technology and selection of a less stringent technology. The BACT process is as follows:

1. Identify all control technologies
2. Eliminate technically infeasible options
3. Rank remaining control technologies by control effectiveness
4. Evaluate most effective controls and document results
5. Select BACT

Table 2-7 lists the controls that were evaluated and selected based on the BACT analysis that was prepared as part of the WPEA PSD permit application for a new Class 1 Operating Permit to Construct (OPTC).

Because carbon dioxide is not currently a regulated pollutant, it was not required to be evaluated in the BACT analyses; however, an MOU has been signed between WPEA and the State of Nevada that would require the facility to be designed and constructed in a manner to be "carbon capture ready" so that the facility can be retrofitted in the future with carbon dioxide capture and sequestration when the technology becomes technically feasible and commercially viable. Additional information on carbon capture and sequestration can be found in Appendix E, Carbon Capture and Sequestration.

TABLE 2-7

Alternative Air Pollution Control Technologies

Pollutant	Control Technologies Selected	Control Technologies Rejected
Nitrogen oxides	Low nitrogen oxides burners, overfire air, and selective catalytic reduction	Coal selection Rotating opposed fire air (ROFA) Induced flue gas recirculation (IFRG) Natural gas reburning (NGR) + selective catalytic reduction (SCR) Fuel-lean gas reburning (FLGR) + selective catalytic Reduction (SCR) Advanced gas reburning (AGR) + selective catalytic reduction (SCR) Amine enhanced gas injection (AEGI) + selective Catalytic reduction (SCR) Hybrid selective reduction (HSR) SCONOX THERMALONOX Electro-Catalytic Oxidation (ECO) Pahlman process
Carbon monoxide	Combustion controls	Flares Afterburning Catalytic oxidation External thermal oxidation
Sulfur dioxide	Dry scrubber (in conjunction with low-sulfur coal)	Coal selection Coal cleaning/coal refining Wet scrubber Regenerable wet scrubber Limestone injection dry scrubbing (LIDS) Furnace sorbent injection + wet scrubber Duct sorbent injection + wet scrubber
Volatile organic compounds	Combustion controls	Same as CO
Fluorides (as HF)	Dry scrubber and Fabric filter baghouse	Coal selection Coal cleaning Wet scrubber Regenerable wet scrubber Spray dryer absorber (dry scrubber) Circulating dry scrubber (CDS) Furnace sorbent injection / duct sorbent injection
Sulfuric acid mist	Dry scrubber and Fabric filter baghouse (in conjunction with low-sulfur coal)	Coal cleaning Wet scrubber Regenerable wet scrubber Spray dryer absorber (dry scrubber) Circulating dry scrubber (CDS) Furnace sorbent injection / duct sorbent injection
PM ₁₀ and non-volatile metals	Fabric filter baghouse	Coal selection Coal cleaning Electrostatic precipitator (ESP) Wet electrostatic precipitator (WESP).
Volatile metals (mercury)	Halogenated activated carbon and fabric filter baghouse	Coal selection Coal cleaning/coal refining Co-benefit control

2.5.5 Alternative Cooling Technology

The original Proposed Action and Alternative 1 as described in the public scoping meetings were based on the use of up to two generating units and conventional, mechanical draft wet cooling towers with a total water usage of up to 25,000 acre-feet annually. Several scoping comments were received that expressed concern regarding the effects of using up to 25,000 acre-feet annually of ground water for cooling purposes and suggested that the action alternatives incorporate other cooling technologies. Subsequently, WPEA modified the action alternatives so that both the Proposed Action and the Alternative 1 that are analyzed in detail in this FEIS would use up to three generating units and a hybrid cooling system with a maximum water usage of up to 5,000 acre-feet annually. Table 2-8 compares specifics of the original power plant design described during scoping and the presently proposed power plant design. The advantages of using a hybrid cooling system would be as follows:

- Water usage would be reduced by approximately 80 percent.
- Short-term and long-term ROW acreage would be reduced by 75 to 85 percent.
- Electric distribution lines to the wells would be approximately 60 miles shorter.
- The surface area of the evaporation pond would be reduced by approximately 245 acres.
- No steam plumes would be issued by the natural draft cooling towers.

In contrast, a hybrid cooling system would have the following drawbacks:

- Capital costs would be higher.
- Overall plant efficiency would be lower.
- The natural draft cooling towers are larger and would be more visible than the mechanical draft cooling towers.

Figure 2-20 shows the original well field configuration of the 22 wells.

TABLE 2-8
Comparison of Original and Revised Power Plant Design Alternatives

	Original Power Plant Design	Revised Power Plant Design
Generating Units	Up to two (500 to 800 MW each), approximately 1,590 MW total	Up to three (approximately 530 MW each), approximately 1,590 MW total
Cooling Towers	Up to two sets of mechanical draft cooling towers (rectangular, approximately 60 feet tall)	Up to three sets of natural draft, dry cooling towers with spray augmentation (approximately 590-foot diameter at the base; approximately 550 feet tall)
Evaporation Pond	320 acres (maximum)	75 acres (maximum)
Total Plant Water Usage	25,000 acre-feet per year (maximum)	5,000 acre-feet per year (maximum)
Wells And Water Pipeline	22 wells; approximately 55 miles of pipeline; 278 acres of long-term ROW	8 wells; approximately 13 miles of pipeline (8 miles for Alternative 1); 68 acres of long-term ROW (43 acres for Alternative 1)
Electric Distribution Lines	More than 70 miles for the wells	Approximately 13 miles (8 miles for Alternative 1) for the wells

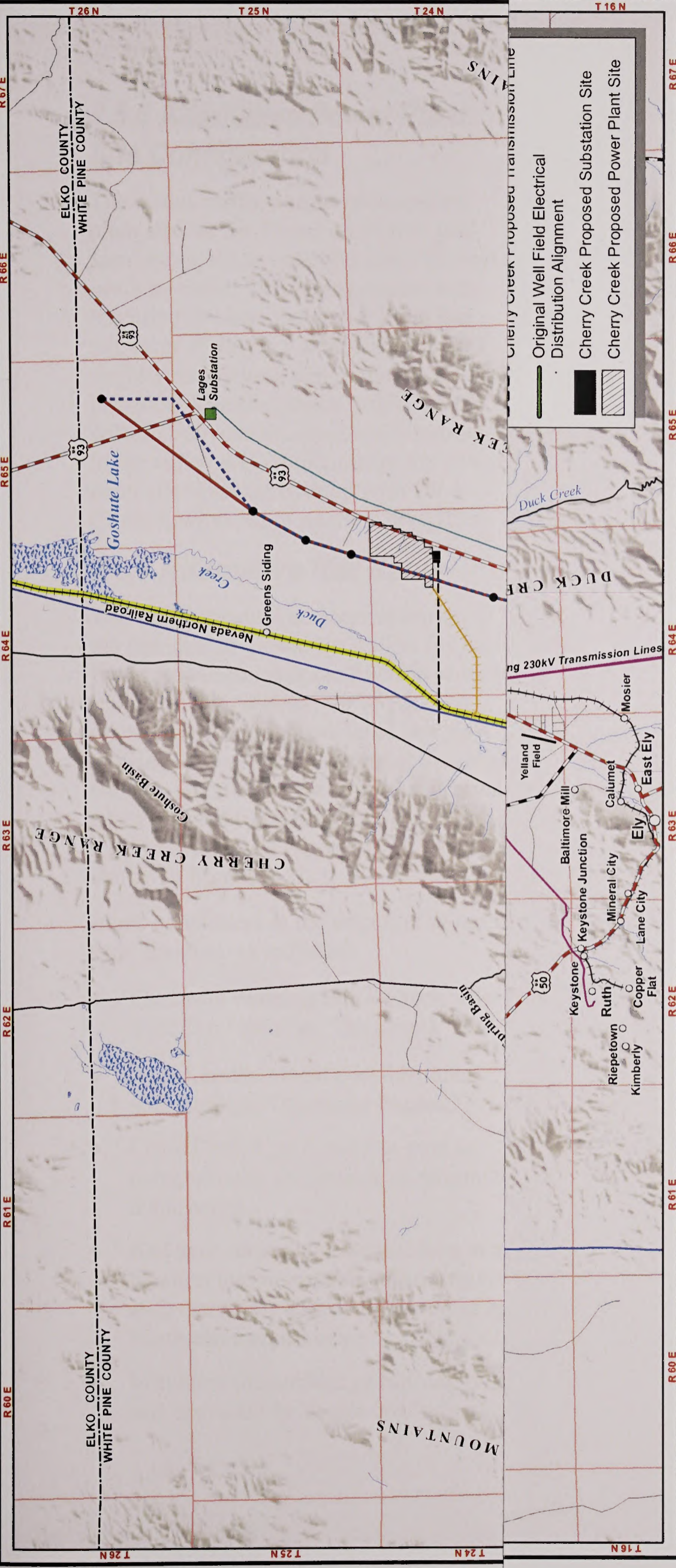

Project Feature Configurations Considered But Eliminated White Pine Energy Station Project

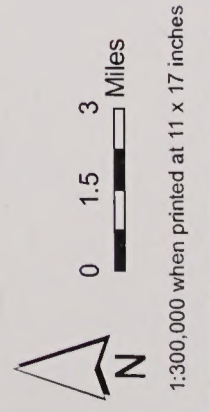
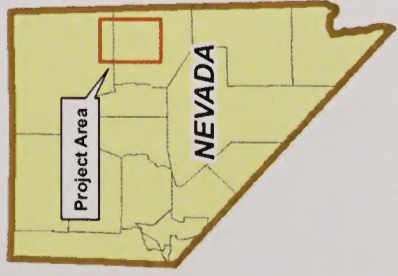
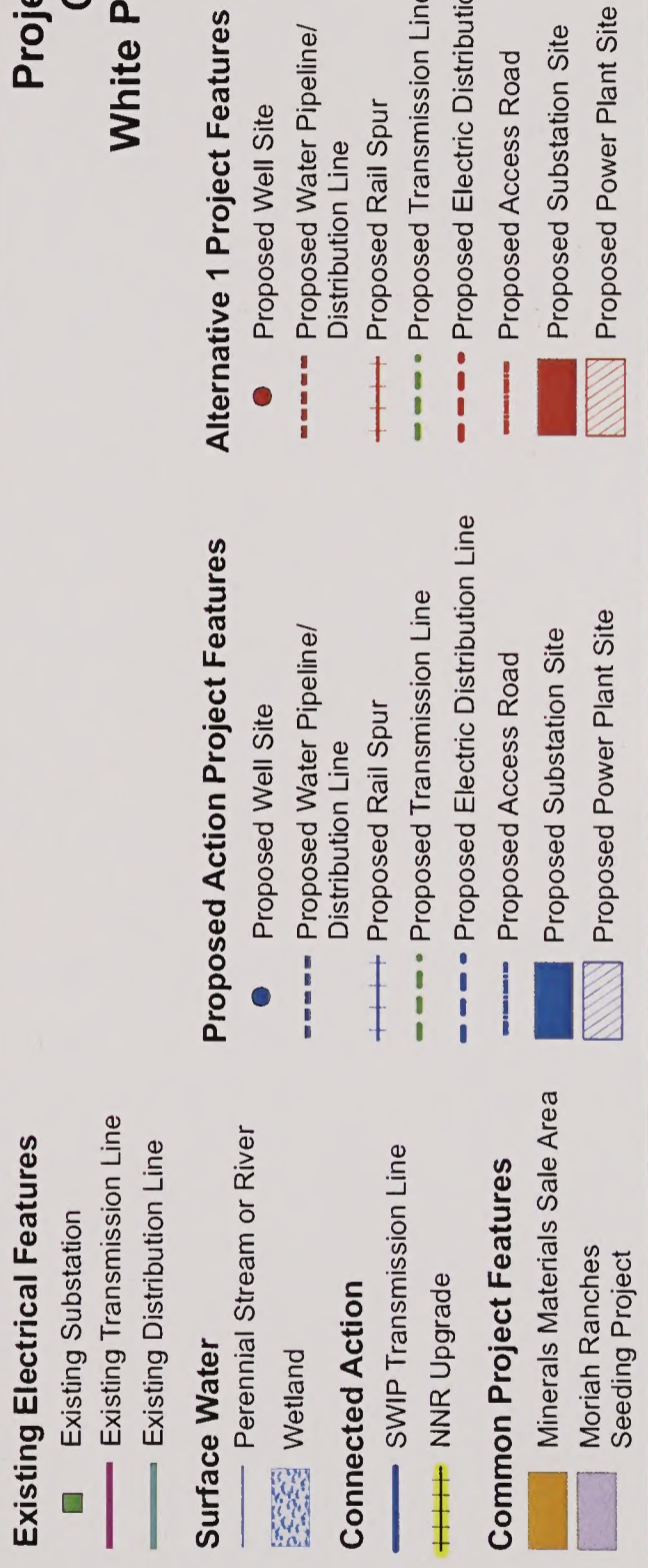

Figure 2-20

2.5.5 Alternative Cooling Technology

The original Proposed Action and Alternative 1 as described in the public scoping meetings were based on the use of up to two generating units and conventional, mechanical draft wet cooling towers with a total water usage of up to 25,000 acre-feet annually. Several scoping comments were received that expressed concern regarding the effects of using up to 25,000 acre-feet annually of ground water for cooling purposes and suggested that the action alternatives incorporate other cooling technologies. Subsequently, WPEA modified the action alternatives so that both the Proposed Action and the Alternative 1 that are analyzed in detail in this FEIS would use up to three generating units and a hybrid cooling system with a maximum water usage of up to 5,000 acre-feet annually. Table 2-8 compares specifics of the original power plant design described during scoping and the presently proposed power plant design. The advantages of using a hybrid cooling system would be as follows:

- Water usage would be reduced by approximately 80 percent.
- Short-term and long-term ROW acreage would be reduced by 75 to 85 percent.
- Electric distribution lines to the wells would be approximately 60 miles shorter.
- The surface area of the evaporation pond would be reduced by approximately 245 acres.
- No steam plumes would be issued by the natural draft cooling towers.

In contrast, a hybrid cooling system would have the following drawbacks:

- Capital costs would be higher.
- Overall plant efficiency would be lower.
- The natural draft cooling towers are larger and would be more visible than the mechanical draft cooling towers.

Figure 2-20 shows the original well field configuration of the 22 wells.

TABLE 2-8

Comparison of Original and Revised Power Plant Design Alternatives

	Original Power Plant Design	Revised Power Plant Design
Generating Units	Up to two (500 to 800 MW each), approximately 1,590 MW total	Up to three (approximately 530 MW each), approximately 1,590 MW total
Cooling Towers	Up to two sets of mechanical draft cooling towers (rectangular, approximately 60 feet tall)	Up to three sets of natural draft, dry cooling towers with spray augmentation (approximately 590-foot diameter at the base; approximately 550 feet tall)
Evaporation Pond	320 acres (maximum)	75 acres (maximum)
Total Plant Water Usage	25,000 acre-feet per year (maximum)	5,000 acre-feet per year (maximum)
Wells And Water Pipeline	22 wells; approximately 55 miles of pipeline; 278 acres of long-term ROW	8 wells; approximately 13 miles of pipeline (8 miles for Alternative 1); 68 acres of long-term ROW (43 acres for Alternative 1)
Electric Distribution Lines	More than 70 miles for the wells	Approximately 13 miles (8 miles for Alternative 1) for the wells

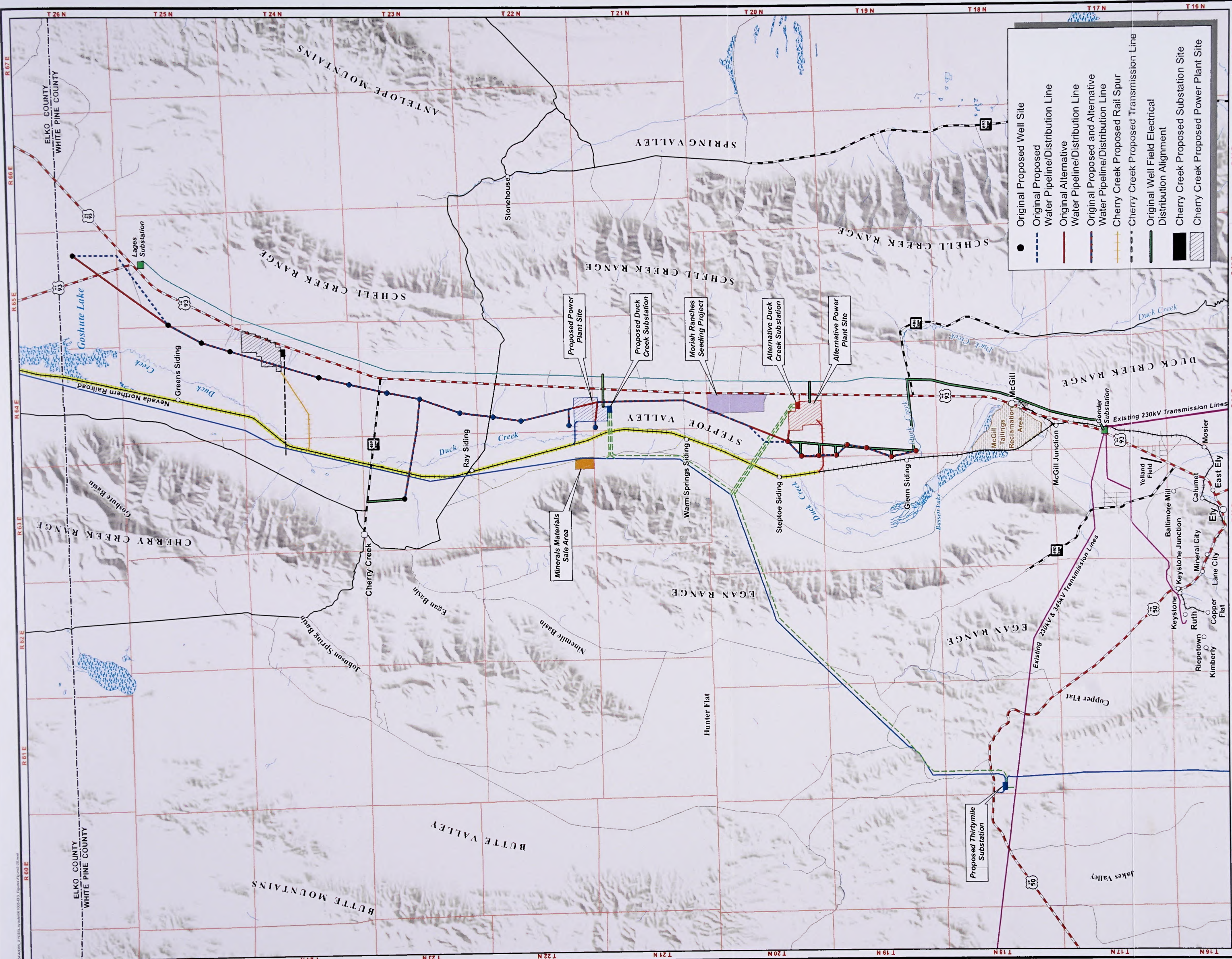

Project Feature Configurations Considered But Eliminated White Pine Energy Station Project

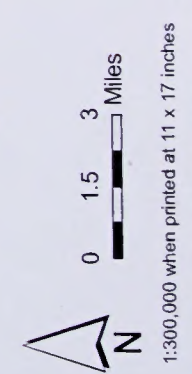
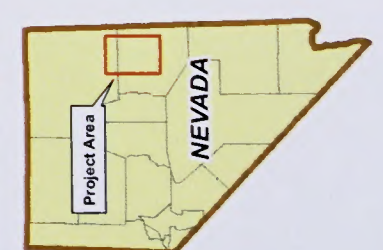
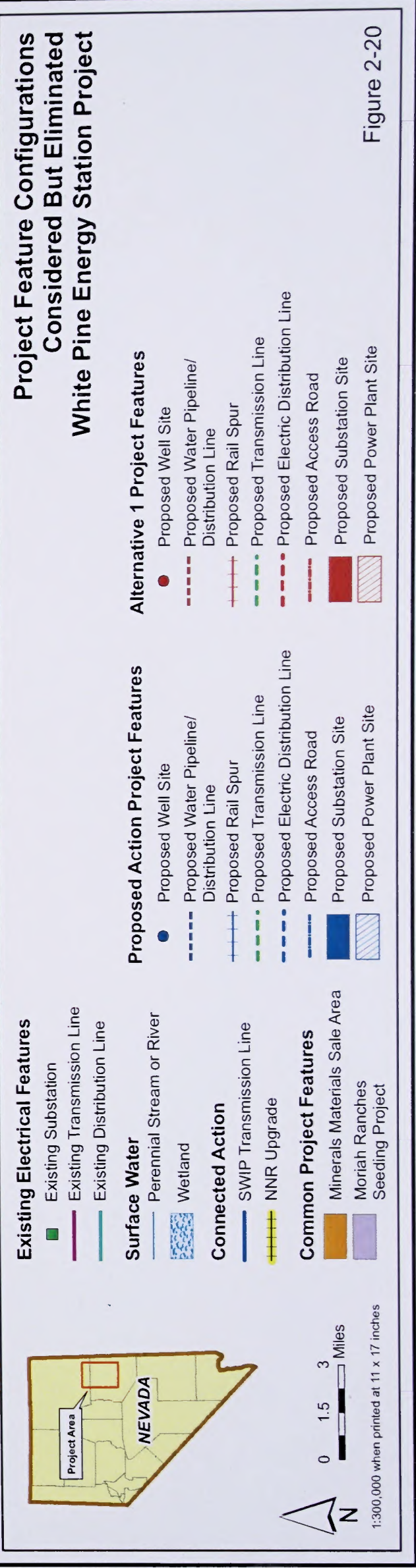

Figure 2-20

2.5.6 Alternative Power Plant Site Configuration

The initial configuration of the power plant site for the Proposed Action was approximately as wide from east to west as north to south. This configuration was modified to make the power plant site narrower in the east-west direction and slightly more elongated in the north-south direction. These changes would benefit wildlife movement, specifically antelope, in the valley and would ensure the power plant site does not overlap with Duck Creek riparian areas on the valley floor.

2.5.7 Alternative Rail Spurs

The initial location and configuration of the rail spur proposed by WPEA for the Proposed Action was modified in order to minimize the potential for impacts on Duck Creek and its associated wetlands. WPEA proposed three potential locations for consideration of the rail spur location (then referred to as Alternative A, Alternative B, and Alternative C) as shown in Figure 2-21.

Items considered in the selection of the rail spur alternatives included:

- Eliminate crossing Duck Creek where there is a “split” or “dual creek” bed.
- Avoid, to the extent possible, areas with multiple “drainage fingers.”
- Cross Duck Creek riparian area as perpendicular as possible to minimize disturbance.
- Rail spur must enter the rail loop at a location that minimizes unloading time and, therefore, lessens onsite noise and locomotive emissions.
- Minimize the amount of railroad built and upgraded to handle coal trains.

Examination of aerial photographs, mapping of the rail spur routes, and field investigations showed that Alternatives A and C would avoid the high quality ponds and wetland complex that would be crossed by Alternative B and which may provide habitat for wildlife such as migratory birds, resident avian species, and big game.

Alternative A would provide a greater buffer for the large wetland complex located along Alternative B than would Alternative C, which would be a short distance south of this better quality wetland. Overall, Alternative A would reduce direct impacts and minimize hydrological impacts to the wetland complex located between Alternatives A and C. Alternative A was therefore selected as the preferred rail spur to be analyzed in detail in the FEIS, while Alternatives B and C were eliminated from detailed evaluation.

2.5.8 Alternative Structure Designs for Crossing Duck Creek

Traditionally four main types of bridges exist: trestle, box culvert, span or girder, and truss spans. Each commonly used bridge types can be built with a single-span or multiple spans. Single-span bridges are often preferred where environmental sensitivity is high and creek disturbance must be kept to a minimum. Multiple span bridges often have more impacts on creeks, but these impacts can often be mitigated by the bridge configuration and the placement of bridge supports and abutments.

In selecting the bridge for the Duck Creek crossing the following criteria were used:

- Minimize impacts on the creek
- Consider the height of the bridge to avoid flood water impacts
- Minimize the railroad embankment approach impacts

- Minimize cost as much as is feasible considering the other factors

The three-span trestle bridge would minimize cost while being mindful of environmental impacts. The box culvert bridge, which is typically used in road applications, is not the most economical and would have more impacts on the creek than other bridge types. The single-span or girder bridge would be more expensive than a trestle bridge; however, it would result in the least impacts on the creek.

The truss span bridge would not be appropriate for the Duck Creek crossing because of the relatively short crossing width.

A single-span or girder bridge is the preferred choice for the Duck Creek. It would have minimum impact on the creek because it would not require any piles in the creek bed. The single-span or girder bridge has flexibility in length (up to approximately 65 feet for a single span) and would be less costly than some other designs. For these reasons, the other bridge structures described above were not carried forward for detailed evaluation.

2.5.9 Alternative Well Field Electric Distribution Line Alignments and Design

Two alternative alignments to the wellfield electric distribution lines presently proposed by WPEA were initially considered, principally to avoid or minimize potential impacts to avian species. Figure 2-20 shows the alternative alignments. Both alternatives were eliminated from further analysis because WPEA's presently proposed electric distribution line is shorter, would originate at the SWIP line where it interconnects with the new substation adjacent to the Proposed Action and Alternative 1 power plants, and would have a greater potential for avoiding

or minimizing impacts to avian species than either of the alternatives. The first eliminated alternative alignment would have paralleled the existing power lines east of U.S. 93, while the second eliminated alternative alignment would have located the lines just west of the U.S. 93 Nevada Department of Transportation ROW. Both alternatives included new electric distribution lines that would have paralleled or replaced existing lines from a substation near McGill to just north of McGill, crossed U.S. 93 to the west, then intersected the water pipeline alignment and followed it to the northern-most well site. Based on the potential for impacts to the viewshed, avian predation, and cultural resources, together with increased construction and maintenance costs, the BLM Ely Field Office decided to eliminate the two alignment alternatives depicted in Figure 2-20 from detailed evaluation and analyze the alignment proposed by WPEA in detail in this FEIS. That alignment originates at the SWIP line where it interconnects with the new substation adjacent to the Proposed Action and Alternative 1 power plants.

WPEA's proposed design of the electric distribution lines includes constructing overhead lines to serve the well fields. An alternative design that was initially considered was placing the electric distribution lines underground rather than overhead to avoid or minimize potential impacts to avian species. At that time, representatives of Mt. Wheeler Power Company expressed concerns with the reliability of service of buried lines, even if only segments of the main electric distribution line were buried in areas most sensitive to wildlife. In addition, BLM Ely Field Office archaeologists expressed concerns regarding potential added impacts to cultural resources from widening the zone of disturbance needed to bury the power line adjacent to the water pipeline.

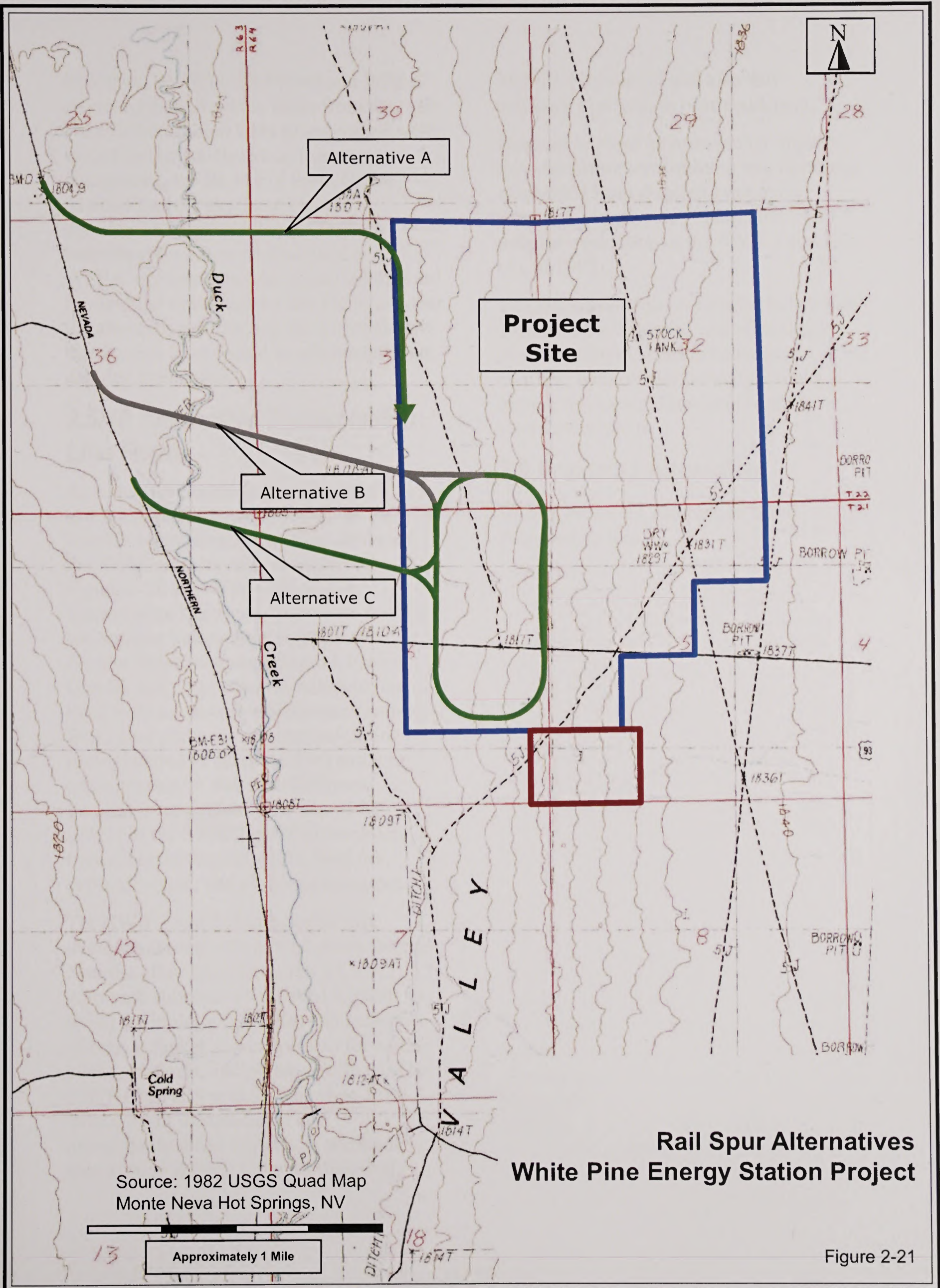

**Rail Spur Alternatives
White Pine Energy Station Project**

Figure 2-21

However, Mt. Wheeler Power and WPEA proposed that all power feeds from the main electric distribution lines to individual wells would be buried. Based on these discussions, the BLM Ely Field Office decided that the overhead electric distribution lines with buried feeds to individual well sites as described in WPEA's proposal would be carried forward for detailed evaluation in this FEIS, and that the alternative of burying the entire electric distribution lines would be eliminated from detailed evaluation.

2.5.10 Alternative Transmission Line Route

An alternative transmission line route extending to Robinson Summit via the Gonder Substation, rather than following the SWIP corridor, was considered. Figure 2-20 shows this alternative transmission line route. This route follows the Steptoe Valley floor south to the Gonder Substation, and then the Falcon-Gonder and other existing transmission lines west-northwest to Robinson Summit. This same alternative transmission line route (labeled as subroute 11e) and four other alternative routes to Robinson Summit were evaluated by the BLM (1993) in the SWIP Final EIS for potential impacts on biological, earth, land use, cultural, visual, and planning resources.

The SWIP Final EIS concluded that, overall, subroute 11e ranked much lower than the other four routes (BLM, 1993). Although subroute 11e ranked highest (best) for biology (wildlife) and cultural effects, it ranked lowest (worst) for earth, visual, land use, and planning effects. The SWIP Final EIS stated, "Subroute 11e would result in significant and unavoidable direct impacts to wetlands area around Bassett Lake northwest of

McGill, Nevada..." and also that subroute 11e "passes near residences."

Because of these environmental impacts, this alternative transmission line route was eliminated from detailed evaluation. Subroute 11e also was eliminated from detailed evaluation in the SWIP Final EIS (BLM 1993).

The alternative Falcon-Gondor Substation/Transmission Line site was eliminated from detailed evaluation because it conflicts with private property, would require two power lines, and result in viewshed impacts.

2.6 Preferred Alternative

BLM's Preferred Alternative is the Proposed Action.

Chapter 3.0 Affected Environment

3.1 Introduction

This chapter describes the affected environment associated with the Proposed Action and Alternative 1 for the White Pine Energy Station (the Station). The discussions describe existing conditions for those resources comprising the physical, biological, cultural, and human and socioeconomic environments within the project area. Figures 2-1 and 2-17 in Chapter 2 depict the project area and project features for the Proposed Action and Alternative 1, respectively. The project areas and project features for the Proposed Action and Alternative 1 are described in detail in Chapter 2, Sections 2.1 through 2.3.

3.2 Geology, Soils, and Minerals

This section provides context for the subsequent evaluation in Chapter 4, *Environmental Consequences*, of potential project-induced environmental consequences to geological, soils, and mineral resources in the White Pine Energy Station project area. Additional geologic related information is presented in Section 3.4, *Ground Water Resources*, as context for evaluating potential impacts to ground water resources.

3.2.1 Geology

3.2.1.1 Regional Geologic History and Setting

The project area is located within the Basin and Range Physiographic Province, which primarily comprises the State of Nevada, western Utah, and southeastern Idaho and Oregon (see Figure 3.2-1). The Basin and Range Physiographic Province owes its descriptive name to the general geologic history common to this part of

the country that has given rise to the present-day landscape of alternating generally north-south trending mountains separated by intervening valleys or basins (BLM, 2003).

Although the current landscape formed only during the past 10 to 20 million years, the geologic history of the region is much longer with important features dating to the Precambrian Era (more than 550 million years before present). The metamorphic rocks (quartzites and schist) of Precambrian age are the oldest and lowest unit in the regional stratigraphic column and are therefore commonly referred to as "basement." Early Cambrian age formations (approximately 500 million years before present) principally consisting of quartzite and shale are also typically considered basement, primarily because of their relatively impermeable nature with respect to ground water flow (BLM, 2003) (see Section 3.4, *Ground Water Resources*).

Throughout the Paleozoic Era, beginning in the early Cambrian time and continuing into the Permian Period (approximately 250 million years before present), present-day eastern Nevada formed the continental shelf off of what was then the west coast of North America (the ancient shoreline ran through present-day western Utah). This shallow marine environment gave rise to the deposition of massive sequences of carbonate rocks (such as limestone and dolomites) that accumulated to thicknesses of as much as 30,000 feet. The area that formed the ancient continental shelf stretched from present-day southern Idaho, across western Nevada to southeastern California. The resulting carbonate deposits are exposed in the many mountain ranges, and form a thick wedge, generally thinning eastward, that

constitutes an extensive regional feature commonly referred to as the Carbonate Rock Province (see Section 3.4.1.2, *Fractured-Rock Ground Water Systems*). The thickness and lithology (composition) of the Paleozoic carbonate rocks are notable in their homogeneity over large areas in the province (BLM, 2003).

The Permian Period (between 240 and 290 million years before present) generally marked the end of the environment that produced the thick deposits of carbonate rock and by the middle Triassic (225 million years before present) the continental margin began to shift westward so that present-day eastern Nevada was an area of continental deposition. Rocks of middle Triassic to Early Jurassic age in eastern Nevada, therefore, largely consist of sandstone, shale, and freshwater limestone (BLM, 2003).

It was also during the late Mesozoic that the Sevier orogeny (period of mountain building) occurred that coincided with extensive regional compression of the earth's crust generally along the same belt that formed the ancient continental shelf during Paleozoic time (from southern Idaho through western Utah and southeastern California).

The geologic structure of the region became even more complex in the middle and late Tertiary (starting around 20 million years before present) when the tectonic forces reversed, resulting in crustal extension (stretching). The entire region underlying present-day eastern Nevada was essentially pulled apart by tensional forces. Large-scale normal (vertical offset) faulting caused huge blocks to be dropped, tilted, or rotated in response to being pulled apart or thinned. In addition to extensive normal faulting, nearly vertical strike-slip (lateral offset) faulting also occurred during the middle and late Tertiary times. The overall

result of the east-west extensional tectonics was that north-south oriented mountain ranges were raised and tilted, and basins formed in the intervening depressed areas. Erosion of the mountain ranges and the subsequent deposition of the erosional debris filled the valleys with several hundred to several thousand feet of sediment. The resulting parallel sequence of mountain ranges and intervening basins, interspersed with mountains of volcanic origin, combine to give the region its characteristic basin-range topography seen today (BLM, 2003).

3.2.1.2 Local Geology

All of the components of the Station Proposed Action and Alternative 1 sites would be located in White Pine County. Although specific aspects of the geology of White Pine County are described in several reports and publications, the principal source of geological information for this Environmental Impact Statement (EIS) is Hose and Blake (1976). A geologic map of the area of the Station Proposed Action and Alternative 1, from Hose and Blake (1976), is shown in Figure 3.2-2.

The locations of the access roads for both the Proposed Action and Alternative 1 are near the center (in an east-west direction) of Steptoe Valley. Structurally, Steptoe Valley consists of a tectonic basin that was created by vertical offset along the principal north-south trending range-front geologic faults at the base of the Schell Creek Range to the east, and the Egan Range and Cherry Creek Mountains to the west. Crustal extension during the Tertiary Period caused the block between these faults to drop, creating a deep basin that subsequently filled with several thousand feet of alluvial sediments generically referred to collectively as basin-fill deposits.

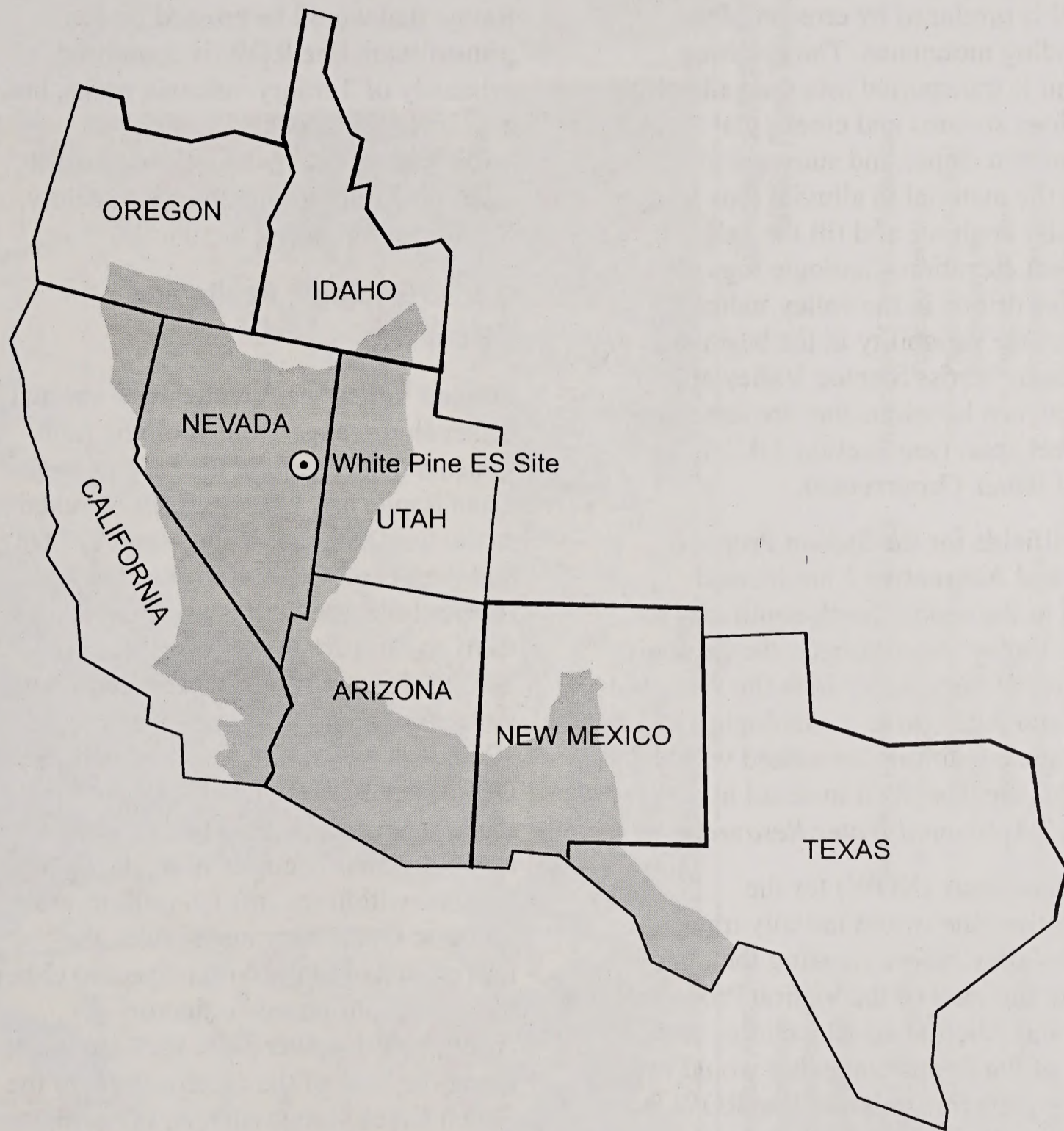

**Location and General Extent
of the Basin and Range Province
White Pine Energy Station Project**

Source:
Fenneman's 1:7,000,000 Physical Divisions Of The United States - USGS

Figure 3.2-1

The basin-fill deposits generally include the entire spectrum of unconsolidated sediment textures from clay and silt to sand and gravel, deposited in interbedded layers of various mixtures. The basin-fill material is produced by erosion of the surrounding mountains. The resulting sediment is transported into the valley by the various streams and creeks that drain the mountain slopes and subsequently deposit the material in alluvial fans that eventually coalesce and fill the valley to its present elevation. Geologic logs of boreholes drilled in the valley indicate considerable variability in the basin-fill stratigraphy across Steptoe Valley and even between locations that are less than 1,000 feet apart (see Section 3.4.2.3, *Local Ground Water Occurrence*).

The wellfields for the Station Proposed Action and Alternative 1 are located parallel to the central north-south axis of Steptoe Valley. Accordingly, the geologic setting is the same as for both the Proposed Action and Alternative 1. Geologic and hydrologic conditions associated with the wellfields are described in detail in Section 3.4, *Ground Water Resources*.

The right-of-way (ROW) for the transmission line would initially traverse Steptoe Valley before crossing the Egan Range to the west of the Station Proposed Action and Alternative 1 locations. The portion of the Egan Range that would be crossed by the transmission line ROW is a 4-mile strip (approximately) composed primarily of Paleozoic carbonate rocks that include both relatively older (Devonian, 350 million years before present) limestone of the Guilmette Formation, and relatively younger (Permian, 250 million years before present) calcareous sandstone (Rib Hill Sandstone) and limestone (Arcturus Formation). After descending down the western flank of the Egan Range, the

transmission line ROW would cross the basin-fill deposits of Butte Valley before climbing up the western arm of the Egan Range south of Butte Valley at Robinson Summit. This western portion of the Egan Range that would be crossed by the transmission line ROW is composed primarily of Tertiary volcanic rocks, but it also includes a pocket of younger sedimentary rocks where the easement takes an abrupt turn to the south below Robinson Summit.

3.2.1.3 Geologic Faults and Seismicity

Steptoe Valley was created by a vertical offset along range-front geologic fault systems that run along the base of the Egan Range and Cherry Creek Mountains to the west (Steptoe Valley fault system), and the Schell Creek Range to the East (Central Steptoe fault zone and Connors Canyon fault zone) (see also Section 3.2.2, *Soils*). These north-south trending fault systems are mapped over lengths up to 100 miles, and are included in the U.S. Geological Survey (USGS) Quaternary Fault Database, indicating that some movement has occurred along these fault systems within the last 1.6 million years. Of these Quaternary aged faults, the nearest active faults with respect to either the Station Proposed Action or Alternative 1 power plant sites are located along the base of the eastern flank of the Schell Creek Range (that is, in Spring Valley), and along the base of the western flank of the Egan Range, south of Ely (<http://quake.wr.USGS.gov/info>). Active faults are typically considered to have had movement within the last 10,000 years (within the Holocene) (Yeats et al., 1997).

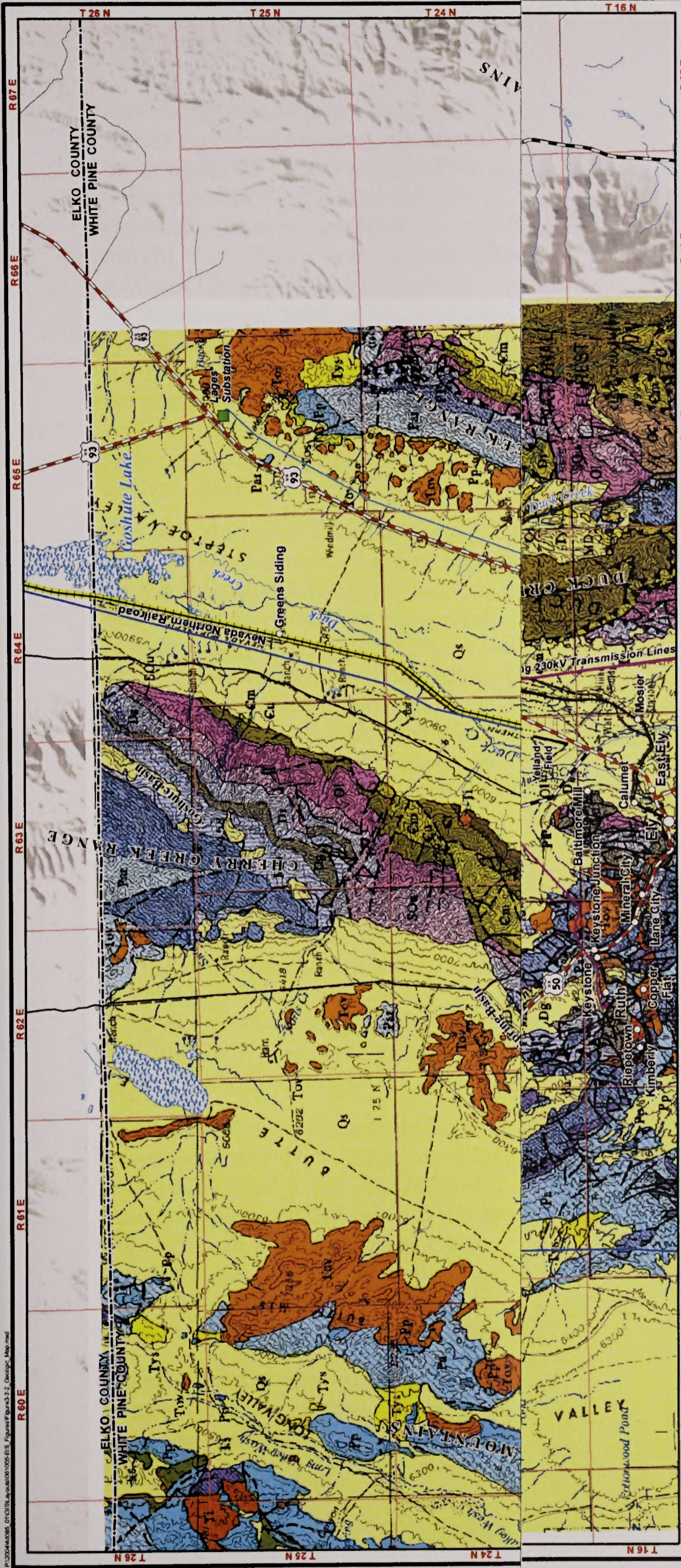

Geologic Map of White Pine County White Pine Energy Station Project

Project Area

NEVADA

<p>Existing Electrical Features</p> <ul style="list-style-type: none"> ■ Existing Substation — Existing Transmission Line — Existing Distribution Line <p>Surface Water</p> <ul style="list-style-type: none"> — Perennial Stream or River ■ Wetland <p>Connected Action</p> <ul style="list-style-type: none"> — SWIP Transmission Line — NNR Upgrade <p>Common Project Features</p> <ul style="list-style-type: none"> ■ Minerals Materials Sale Area ■ Moriah Ranches ■ Seeding Project 	<p>Proposed Action Project Features</p> <ul style="list-style-type: none"> ● Proposed Well Site - - - Proposed Water Pipeline/ Distribution Line + + + Proposed Rail Spur - - - Proposed Transmission Line - - - Proposed Electric Distribution Line — Proposed Access Road ■ Proposed Substation Site ■ Proposed Power Plant Site 	<p>Alternative 1 Project Features</p> <ul style="list-style-type: none"> ● Proposed Well Site - - - Proposed Water Pipeline/ Distribution Line + + + Proposed Rail Spur - - - Proposed Transmission Line - - - Proposed Electric Distribution Line — Proposed Access Road ■ Proposed Substation Site ■ Proposed Power Plant Site
---	---	---

0 1.5 3 Miles

1:300,000 when printed at 11 x 17 inches

Figure 3.2-2

The basin-fill deposits generally include the entire spectrum of unconsolidated sediment textures from clay and silt to sand and gravel, deposited in interbedded layers of various mixtures. The basin-fill material is produced by erosion of the surrounding mountains. The resulting sediment is transported into the valley by the various streams and creeks that drain the mountain slopes and subsequently deposit the material in alluvial fans that eventually coalesce and fill the valley to its present elevation. Geologic logs of boreholes drilled in the valley indicate considerable variability in the basin-fill stratigraphy across Steptoe Valley and even between locations that are less than 1,000 feet apart (see Section 3.4.2.3, *Local Ground Water Occurrence*).

The wellfields for the Station Proposed Action and Alternative 1 are located parallel to the central north-south axis of Steptoe Valley. Accordingly, the geologic setting is the same as for both the Proposed Action and Alternative 1. Geologic and hydrologic conditions associated with the wellfields are described in detail in Section 3.4, *Ground Water Resources*.

The right-of-way (ROW) for the transmission line would initially traverse Steptoe Valley before crossing the Egan Range to the west of the Station Proposed Action and Alternative 1 locations. The portion of the Egan Range that would be crossed by the transmission line ROW is a 4-mile strip (approximately) composed primarily of Paleozoic carbonate rocks that include both relatively older (Devonian, 350 million years before present) limestone of the Guilmette Formation, and relatively younger (Permian, 250 million years before present) calcareous sandstone (Rib Hill Sandstone) and limestone (Arcturus Formation). After descending down the western flank of the Egan Range, the

transmission line ROW would cross the basin-fill deposits of Butte Valley before climbing up the western arm of the Egan Range south of Butte Valley at Robinson Summit. This western portion of the Egan Range that would be crossed by the transmission line ROW is composed primarily of Tertiary volcanic rocks, but it also includes a pocket of younger sedimentary rocks where the easement takes an abrupt turn to the south below Robinson Summit.

3.2.1.3 Geologic Faults and Seismicity

Steptoe Valley was created by a vertical offset along range-front geologic fault systems that run along the base of the Egan Range and Cherry Creek Mountains to the west (Steptoe Valley fault system), and the Schell Creek Range to the East (Central Steptoe fault zone and Connors Canyon fault zone) (see also Section 3.2.2, *Soils*). These north-south trending fault systems are mapped over lengths up to 100 miles, and are included in the U.S. Geological Survey (USGS) Quaternary Fault Database, indicating that some movement has occurred along these fault systems within the last 1.6 million years. Of these Quaternary aged faults, the nearest active faults with respect to either the Station Proposed Action or Alternative 1 power plant sites are located along the base of the eastern flank of the Schell Creek Range (that is, in Spring Valley), and along the base of the western flank of the Egan Range, south of Ely (<http://quake.wr.USGS.gov/info>). Active faults are typically considered to have had movement within the last 10,000 years (within the Holocene) (Yeats et al., 1997).

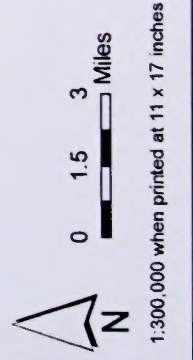
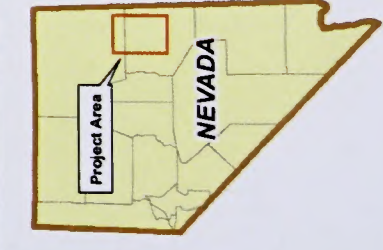
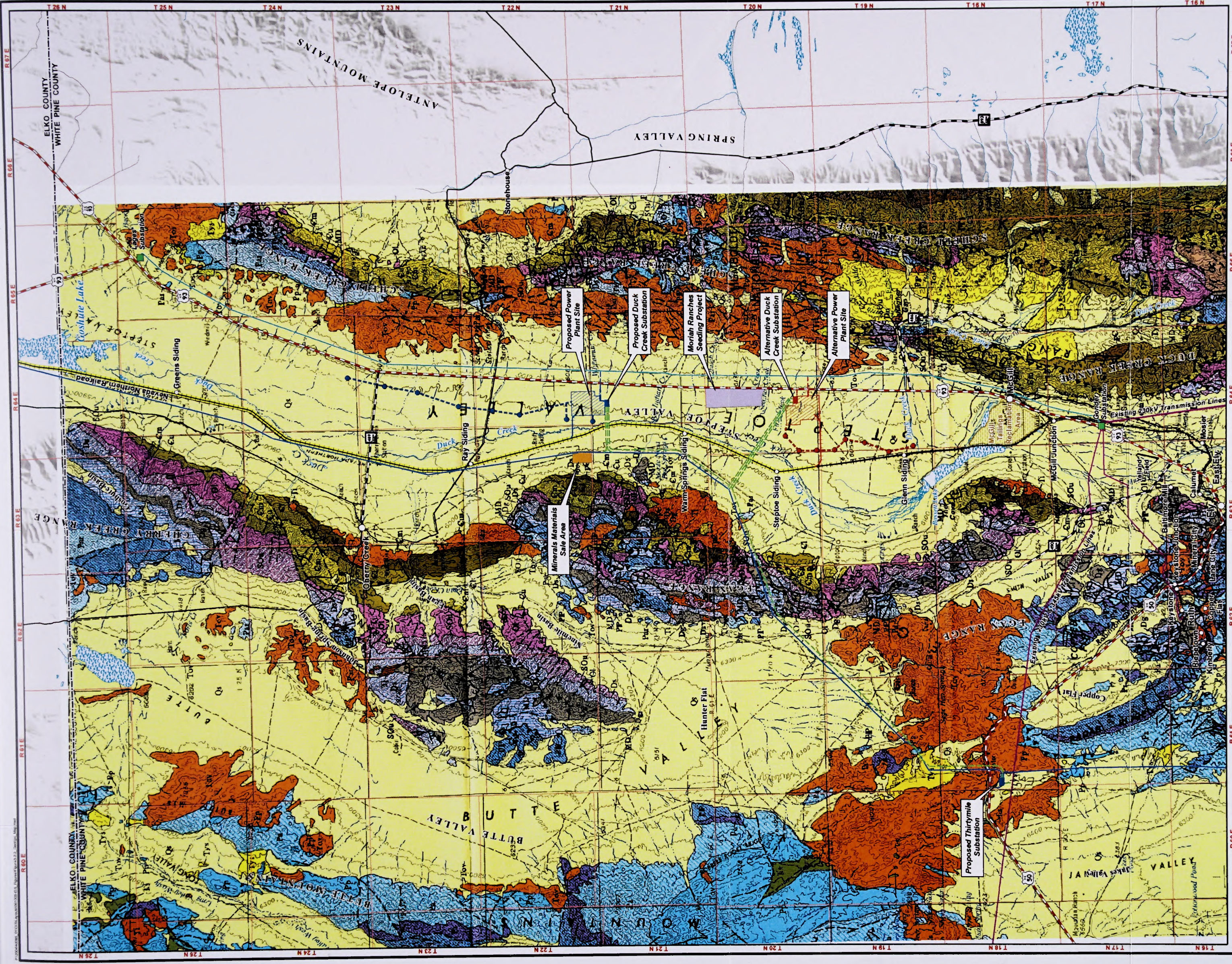

- Existing Electrical Features**
- Existing Substation
 - Existing Transmission Line
 - Existing Distribution Line
- Surface Water**
- Perennial Stream or River
 - Wetland
- Connected Action**
- SWP Transmission Line
 - NNR Upgrade
- Common Project Features**
- Minerals Materials Sale Area
 - Moriah Ranches
 - Seeding Project

- Proposed Action Project Features**
- Proposed Well Site
 - Proposed Water Pipeline/Distribution Line
 - Proposed Rail Spur
 - Proposed Transmission Line
 - Proposed Electric Distribution Line
 - Proposed Access Road
 - Proposed Substation Site
 - Proposed Power Plant Site

- Alternative 1 Project Features**
- Proposed Well Site
 - Proposed Water Pipeline/Distribution Line
 - Proposed Rail Spur
 - Proposed Transmission Line
 - Proposed Electric Distribution Line
 - Proposed Access Road
 - Proposed Substation Site
 - Proposed Power Plant Site

**Geologic Map of White Pine County
White Pine Energy Station Project**

Figure 3.2-2



Specifically, the Steptoe Valley fault system is primarily a series of vertical faults where the offset has been down and to the east. The fault system runs along essentially the entire length of the eastern margin of the Cherry Creek Mountains and southern Egan Range (approximately 150 kilometers). South of Ely, the fault system curves to the southeast into the southern part of Steptoe Valley. Based on the age of basin-fill deposits at the ground surface that have been displaced, the most recent movement along this fault is within the last 130,000 years.

The central Steptoe Valley fault zone is a linear series of down-to-the-west normal (vertical) faults that forms the western margin of the Schell Creek Range and extends into southern Steptoe Valley south of Ely. Based on the age of the sediments that have been offset by this fault zone, the most recent movement occurred within the last 130,000 years. East of the southern extent of the central Steptoe Valley fault zone is the Connors Canyon fault zone. This zone continues for 20 kilometers along the western front of the Schell Creek Range where the central Steptoe Valley fault zone leaves off and defines the eastern margin of Steptoe Valley with the Schell Creek Range south of Ely. The most recent offset along this fault zone is only known to have occurred sometime in the last 1.6 million years.

In addition to these range-front faults a group of unnamed Quaternary aged faults has been mapped within the center of Steptoe Valley east and south of Ely along the alignment of Steptoe Creek (see Section 3.3, *Surface Water Resources*). The specific age of the last historical movement along these faults is unknown.

None of these aforementioned fault systems coincide with the proposed power plant sites, the wellfields, or the access roads or

rail spurs under either the Station Proposed Action or Alternative 1. The transmission line ROW would cross the fault system along the eastern edge of the Egan Range as well as fault traces associated with a series of faults in the Western Egan Range fault zone. Similar to the fault zones of Steptoe Valley, the Western Egan Range fault zone is identified as being of Quaternary age with no specific offset dated within the last 1.6 million years.

The risk of adverse ground acceleration (shaking) as a result of seismic events is perceived to be very low throughout the project area for the Station Proposed Action. According to the USGS (USGS peak acceleration return frequency maps), all of the components of the Station Proposed Action as well as Alternative 1 sites are located within an area where the probability is 10 percent that within the next 50 years an earthquake capable of generating a ground acceleration of only 0.08 g (g is the force of gravity) will occur. A ground acceleration of 0.08 g falls in between the range for a Level VI and Level VII earthquake as measured on the Modified Mercalli Scale (Bolt, 1993). A Level VI event represents an earthquake that would cause "slight" damage (for example, a few instances of falling plaster, and damaged chimneys) (USGS, 2008). A Level VII earthquakes would cause only slight damage to well-built buildings, but would cause considerable damage to poorly built structures (USGS, 2008).

3.2.2 Soils

The source of information for soils within the Station project area is the Natural Resources Conservation Service (NRCS, formerly the Soil Conservation Service, 1998).

The components of the Station Proposed Action and Alternative 1 cover five general

soil map units (NRCS, 1998):

(1) Equis-Kunzler-Duffer, (2) Wintermute-Kunzler-Sycomat, (3) Palinor-Shabliss-Blimo, (4) Cowgil-Cassiro-Yody, and (5) Pookaloo-Hyzen-Cavehill.

The locations of the wellfields, access roads, rail spurs, and power plants for both the Proposed Action and Alternative 1 would be within the Equis-Kunzler-Duffer soil unit. The Station transmission line ROW would cross all five soil map units.

The **Equis-Kunzler-Duffer** unit is principally composed of soils associated with flood plains, fan piedmonts, and stream terraces. This soil unit is primarily found in the low-lying regions of central Steptoe Valley. Equis soils are poorly drained, are found on nearly level flood plains adjacent to areas of springs and seeps, and have a fine textured surface layer and subsoil. Kunzler soils are well drained and occur on nearly level and gently sloping stream terraces. They have a medium textured surface layer and a medium to moderately coarse textured subsoil. Duffer soils are poorly drained and occur on nearly level, axial-stream flood plains. They have a medium textured surface layer and a moderately fine textured subsoil. Land use on this soil unit is mainly livestock grazing and wildlife habitat (NRCS, 1998).

The **Wintermute-Kunzler-Sycomat** unit borders the flood plain and low-lying regions in Steptoe Valley, including gently sloping fan piedmonts. These soils are typically very deep and well drained. Wintermute soils occur on nearly level and gently sloping fan piedmont remnants. They are gravelly and moderately coarse textured in the surface layer and very gravelly and moderately coarse textured in the subsoil. Kunzler soils occur on gently sloping fan piedmonts, and have a medium textured surface layer and a moderately

coarse textured subsoil. Sycomat soils occur on nearly level and gently sloping fan piedmonts, and are moderately coarse textured throughout. Land use on this soil unit is mainly livestock grazing and rangeland wildlife habitat (NRCS, 1998).

The **Palinor-Shabliss-Blimo** unit occurs on gently sloping and moderately sloping fan piedmont remnants. These soils are typically well drained and can be either shallow or very deep. Palinor soils, in particular, are shallow and occur over a hardpan substrate (duripan) typically on gently sloping and moderately sloping fan piedmont remnants. The texture of these units is gravelly. Shabliss soils are also shallow and occur over a duripan, but one that is much more cemented, on gently sloping and moderately sloping fan piedmont remnants. Their texture is gravelly. Blimo soils are very deep and occur on nearly level and gently sloping fan skirts. These soils have a medium textured surface layer and a moderately coarse textured subsoil. Land use on this soil unit is mainly livestock grazing and rangeland wildlife habitat (NRCS, 1998).

The **Cowgil-Cassiro-Yody** unit consists of gently sloping to strongly sloping, well drained soils that are moderately deep over a duripan or are very deep. Cowgil soils are very deep and occur on fan piedmont remnants. They are very gravelly and moderately coarse textured on the surface layer, very gravelly and moderately fined textured in the subsoil, and very cobbly and coarse textured in the substratum. Cassiro soils are very deep and occur on fan piedmont remnants. They are stony and medium textured in the surface layer and very gravelly and fine textured in the subsoil. Yody soils are moderately deep over a duripan. They occur on fan piedmont remnants, are gravelly and moderately coarse textured in the surface

layer, and gravelly and moderately fine textured in the subsoil and underlain by a duripan. Land use on this soil unit is mainly livestock grazing and rangeland wildlife habitat (NRCS, 1998).

The **Pookaloo-Hyzen-Cavehill** unit consists of well-drained soils that range from very shallow to moderately deep that occur on moderately steep to very steep terrains on mountain sides. This unit is mainly mapped in the Egan Range.

Pookaloo soils, in particular, are shallow, and occur on steep to very steep mountain slopes. Their texture is very gravelly and underlain by shallow bedrock. Hyzen soils are also very shallow and occur on steep to very steep mountain slopes. They, too, are underlain by shallow bedrock but have a more coarse, extremely stony texture, compared to Pookaloo soils. Cavehill soils are moderately deep and occur on less (moderately) steep to steep side slopes. Their texture is very gravelly in the surface layer and very gravelly to very cobbly in the subsoil. Land use on this soil unit is mainly woodland, livestock grazing, and wildlife habitat (NRCS, 1998).

3.2.3 Minerals

Steptoe Valley contains ten mining districts, which are summarized in Table 3.2-1. Seven of these mining districts are in the immediate vicinity of the Station project area and are shown on Figure 3.2-3. The Nevada, Taylor, and Ward Mining Districts are outside the immediate vicinity of the Station project area and, therefore, are not shown on Figure 3.2-3. None of these ten districts coincides with the proposed sites for the power plants, wellfields, access roads, or

rail spurs for either the Station Proposed Action or Alternative 1.

The proposed transmission line ROW crosses a portion of three separate mining districts (see Figure 3.2-3: the Telegraph District, Hunter District, and Granite District). There are no active mines within these districts and no known active mining claims within the proposed transmission line ROW.

The presence and value of minerals under the power plant site of both the Station Proposed Action and Alternative 1 are unknown. Because one of these sites will be selected as the Preferred Alternative and sold by BLM to WPEA, a minerals report on the selected site will be included in the Final EIS.

Geothermal resources are known to exist within Steptoe Valley, particularly Monte Neva and Lackawana Hot Springs located on the west side of the valley. These springs are described in more detail in Section 3.4.2.5.2, *Geothermal Springs*; however, none have been developed for geothermal energy.

The potential for oil and gas leases and sand and gravel operations in Steptoe Valley is moderate to high. In addition, the potential for development of geothermal resources is considered moderate. There are no currently active leases for oil and gas or geothermal resources at the Station Proposed Action or Alternative 1 power plant sites. However, there are active leases for either oil or gas at the location of the proposed Thirtymile Substation (T18N/R61E).

TABLE 3.2-1*

Mining Districts in Steptoe Valley

District Name	Mines	Status of Mine(s)	Primary Commodities
Cherry Creek District	Teacup (Biscuit) Mine	Not active	Silver, gold, lead, copper, zinc, tungsten, antimony, coal, fluorspar, beryllium
	Mary Ann Mine	Not active	
	Additional Mines: Chance, Only Chance, Fillmore (Scheelite King), Gypsy, Calcite, Happy, and Shoestring Mines.	Not active	
Telegraph District	No current mines exist in the Telegraph District	None present	Gold, tungsten
Hunter District	Hunter Lead-Copper-Silver Mine (formerly known as the Vulcan Mine)	Not active	Lead, copper, silver, gold, uranium
Granite District	Cuba Lead-Silver Mine	Not active	Lead, silver, gold, tungsten, copper
	Stinson Gold Mine		
	Valley View Mine		
San Francisco District	Mammoth, Confidence, Ida, Empire, Hercules, and Excelsior Claims	Not active	Silver, lead
Duck Creek District	Success Mine	Not active	Lead, silver, copper, zinc, gold, limestone, fire clay
	Cuba Mine	Not active	
Nevada District	Steptoe Group Mine	Not active	Manganese, silver, gold, lead, copper
	Argus Mill Mine site (Comins Lake)	Not active	
	Monitor Mill Mine site (Steptoe Creek)		
	Vietti Mine	Not active	
Robinson District	Wedge Pit (proposed)	Not active	Copper. Other commodities include: gold, silver, zinc, lead, iron, manganese, tungsten, molybdenum, rhenium, platinum, palladium, nickel
	Kimbley Pit	Not active	
	Ruth Mine	Not active	
	Ruth Pit	Active	
	Deep Ruth Mine (proposed)	Not active	
	Morris-Brooks Pit	Not active	
	Tripp Pit	Not active	
	Tripp-Veteran Pit	Not active	
Taylor District	Monitor Mine	Not active	Silver, lead, antimony, copper, zinc, gold, arsenic
	Enterprise Mine	Not active	
	Argus Mine	Not active	
	Alameda Mine	Not active	
	Bishop Mine	Not active	
Ward District	Ward Mine	Not active	Silver, lead, zinc, copper and gold

Source: Nevada Bureau of Mines and Geology, 1998

*Seven of these mining districts are in the immediate vicinity of the Station project area and are shown on Figure 3.2-3. The Nevada, Taylor, and Ward Mining Districts are outside the immediate vicinity of the Station project area and, therefore, are not shown on Figure 3.2-3.

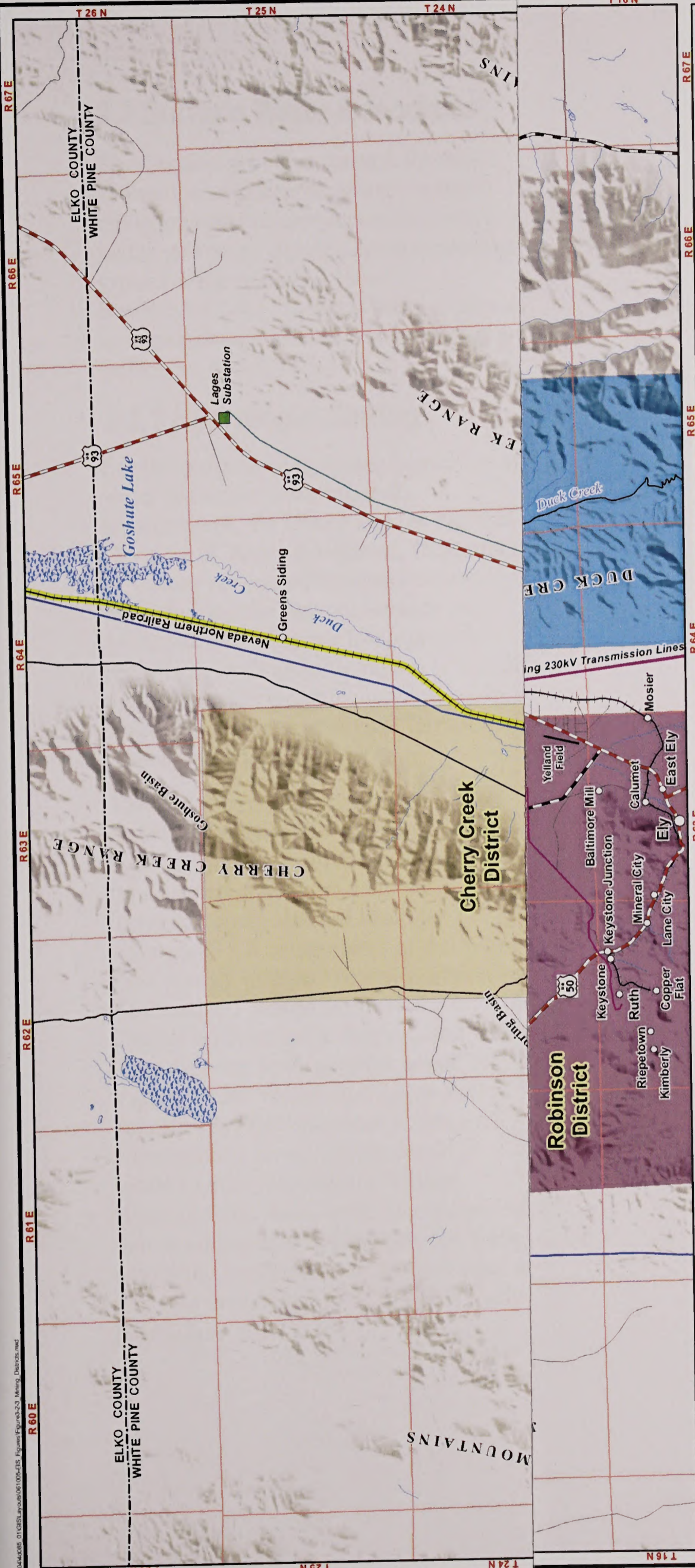

Mining Districts in the Steptoe Valley White Pine Energy Station Project

Existing Electrical Features

- Existing Substation
- Existing Transmission Line
- Existing Distribution Line

Surface Water

- Perennial Stream or River
- Wetland

Connected Action

- SWIP Transmission Line
- NNR Upgrade

Common Project Features

- Minerals Materials Sale Area
- Moriah Ranches
- Seeding Project

Proposed Action Project Features

- Proposed Well Site
- Proposed Water Pipeline/Distribution Line
- Proposed Rail Spur
- Proposed Transmission Line
- Proposed Electric Distribution Line
- Proposed Access Road
- Proposed Substation Site
- Proposed Power Plant Site

Alternative 1 Project Features

- Proposed Well Site
- Proposed Water Pipeline/Distribution Line
- Proposed Rail Spur
- Proposed Transmission Line
- Proposed Electric Distribution Line
- Proposed Access Road
- Proposed Substation Site
- Proposed Power Plant Site

Mining Districts

- Cherry Creek District
- Duck Creek District
- Granite District
- Hunter District
- Robinson District
- San Francisco District
- Telegraph District

NEVADA

0 1.5 3 Miles

1:300,000 when printed at 11 x 17 inches

Figure 3.2-3

TABLE 3.2-1*

Mining Districts in Steptoe Valley

District Name	Mines	Status of Mine(s)	Primary Commodities	
Cherry Creek District	Teacup (Biscuit) Mine	Not active	Silver, gold, lead, copper, zinc, tungsten, antimony, coal, fluorspar, beryllium	
	Mary Ann Mine	Not active		
	Additional Mines: Chance, Only Chance, Fillmore (Scheelite King), Gypsy, Calcite, Happy, and Shoestring Mines.			Not active
Telegraph District	No current mines exist in the Telegraph District	None present	Gold, tungsten	
Hunter District	Hunter Lead-Copper-Silver Mine (formerly known as the Vulcan Mine)	Not active	Lead, copper, silver, gold, uranium	
Granite District	Cuba Lead-Silver Mine	Not active	Lead, silver, gold, tungsten, copper	
	Stinson Gold Mine			
	Valley View Mine			
San Francisco District	Mammoth, Confidence, Ida, Empire, Hercules, and Excelsior Claims	Not active	Silver, lead	
Duck Creek District	Success Mine	Not active	Lead, silver, copper, zinc, gold, limestone, fire clay	
	Cuba Mine	Not active		
Nevada District	Steptoe Group Mine	Not active	Manganese, silver, gold, lead, copper	
	Argus Mill Mine site (Comins Lake)	Not active		
	Monitor Mill Mine site (Steptoe Creek)	Not active		
Robinson District	Wedge Pit (proposed)	Not active	Copper. Other commodities include: gold, silver, zinc, lead, iron, manganese, tungsten, molybdenum, rhenium, platinum, palladium, nickel	
	Kimbley Pit	Not active		
	Ruth Mine	Not active		
	Ruth Pit	Active		
	Deep Ruth Mine (proposed)	Not active		
	Morris-Brooks Pit	Not active		
	Tripp Pit	Not active		
	Tripp-Veteran Pit	Not active		
Taylor District	Monitor Mine	Not active	Silver, lead, antimony, copper, zinc, gold, arsenic	
	Enterprise Mine	Not active		
	Argus Mine	Not active		
	Alameda Mine	Not active		
	Bishop Mine	Not active		
Ward District	Ward Mine	Not active	Silver, lead, zinc, copper and gold	

Source: Nevada Bureau of Mines and Geology, 1998

*Seven of these mining districts are in the immediate vicinity of the Station project area and are shown on Figure 3.2-3. The Nevada, Taylor, and Ward Mining Districts are outside the immediate vicinity of the Station project area and, therefore, are not shown on Figure 3.2-3.

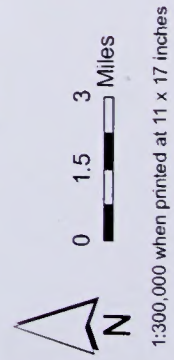
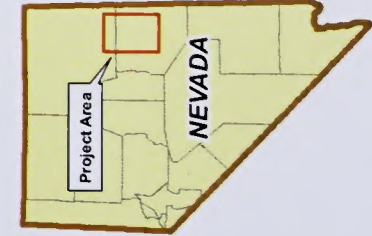

- Existing Electrical Features**
- Existing Substation
 - Existing Transmission Line
 - Existing Distribution Line
- Surface Water**
- Perennial Stream or River
 - Wetland
- Connected Action**
- SWIP Transmission Line
 - NNR Upgrade
- Common Project Features**
- Minerals Materials Sale Area
 - Moriah Ranches
 - Seeding Project

- Proposed Action Project Features**
- Proposed Well Site
 - Proposed Water Pipeline/Distribution Line
 - Proposed Rail Spur
 - Proposed Transmission Line
 - Proposed Electric Distribution Line
 - Proposed Access Road
 - Proposed Substation Site
 - Proposed Power Plant Site

- Alternative 1 Project Features**
- Proposed Well Site
 - Proposed Water Pipeline/Distribution Line
 - Proposed Rail Spur
 - Proposed Transmission Line
 - Proposed Electric Distribution Line
 - Proposed Access Road
 - Proposed Substation Site
 - Proposed Power Plant Site

- Mining Districts**
- Cherry Creek District
 - Duck Creek District
 - Granite District
 - Hunter District
 - Robinson District
 - San Francisco District
 - Telegraph District

Figure 3.2-3



3.3 Surface Water Resources

This section provides context for the evaluation of potential project-induced environmental consequences to surface water resources. Springs are discussed under ground water resources (see Section 3.4.2.5.1, *Springs*) because they are an expression of ground water function and influence.

3.3.1 Hydrologic Setting

For the purpose of hydrologic analysis and water resources planning and management, the USGS and the Nevada Division of Water Resources, Department of Conservation and Natural Resources, have divided the State of Nevada into 14 distinct and discrete hydrographic regions. A hydrographic region is broadly defined as a geographic area drained by a single major stream (Nevada Division of Water Resources, 2006).

These hydrographic regions have been further segregated into 232 distinct hydrographic areas in Nevada that typically coincide with a single topographically defined basin or watershed. All components of the White Pine Energy Station Proposed Action and Alternative 1 would be located within the Central Hydrographic Region, and within three separate hydrographic areas: Steptoe Valley, Butte Valley, and Jakes Valley. Specifically, the Proposed Action and Alternative 1 power plants would be located within the Steptoe Valley Hydrographic Area, while the transmission line would extend beyond Steptoe Valley across the southern tip of Butte Valley and just into the northern end of Jakes Valley (see Figure 3.3-1).

3.3.2 Local Climate/Past Flooding Events

The local climate is influenced by topography and is, therefore, quite variable across the Steptoe Valley Hydrographic Area. Across the basin, precipitation falls as both rain and snow. In the higher elevations of the flanking Schell Creek and Egan Ranges, where elevations exceed 10,000 feet above mean sea level, the climate is alpine and precipitation averages over 20 inches per year. Locally, precipitation may average over 30 inches per year (Eakin et al., 1967). Conversely, on the valley floor conditions are more arid. Ely Airport, at an elevation of 6257 feet, averages 9.52 inches of precipitation annually. McGill, at a slightly higher elevation of 6,340 feet, has an average annual precipitation of 8.79 inches.

Monthly averages of temperature and precipitation for both Ely and McGill are summarized in Table 3.3-1. These data indicate similar conditions at roughly the same elevation approximately 13 miles apart, and these conditions are considered to be representative of the Proposed Action and Alternative 1 feature sites. The considerable variation in seasonal temperatures on the valley floor is reflected in the more than 40 degrees Fahrenheit (°F) swing in average monthly maximum temperatures between January and July at Ely Airport and McGill. Precipitation is more constant from month to month with the lowest amounts falling in November and December (monthly averages ranging from 0.55 inch [McGill] to 0.68 inch [Ely Airport]) and highest in April and May (monthly averages ranging from 0.7 inch [McGill] to 1.1 inches [Ely]).

TABLE 3.3-1

Average Monthly Climatic Data Ely and McGill, Nevada

	Jan	Feb	Mar	Apr	May	Jun	Jul	Aug	Sep	Oct	Nov	Dec	Annual
Ely, Nevada^a													
Average Maximum Temperature (°F)	39.1	42.2	48.5	57.4	67.3	78.1	87.1	84.6	75.7	63.0	49.0	40.7	61.1
Average Minimum Temperature (°F)	10.5	15.0	20.7	26.8	33.8	40.5	48.1	46.9	37.5	28.3	18.9	11.9	28.2
Average Total Precipitation (inches)	0.75	0.72	0.96	1.01	1.09	0.70	0.59	0.81	0.75	0.84	0.68	0.62	9.52
Average Total Snowfall (inches)	8.8	7.3	8.9	6.2	2.7	0.1	0.0	0.0	0.3	2.5	5.3	7.9	50.1
Average Monthly Climatic Data McGill, Nevada (264950)^b													
Average Maximum Temperature (°F)	39.0	42.4	49.0	57.4	67.4	77.9	86.7	84.6	76.1	63.8	49.7	41.1	61.3
Average Minimum Temperature (°F)	15.7	19.3	24.4	30.9	38.6	47.0	55.2	53.3	43.9	33.8	23.9	17.4	33.6
Average Total Precipitation (inches)	0.62	0.63	0.70	0.95	1.03	0.80	0.66	0.79	0.71	0.79	0.55	0.57	8.79
Average Total Snowfall (inches)	4.0	4.3	3.3	2.0	0.3	0.1	0.0	0.0	0.0	0.5	1.6	3.1	19.2

^a Period of Record: 1/1/1897 to 9/30/2004

^b Period of Record: 1/1/1914 to 9/30/2004

Source: <http://www.wrcc.dri.edu/summary/climsmnv.html>

These average values, however, do not reflect the timing or amounts of the most extreme precipitation events. Specifically, the highest monthly precipitation total on record at Ely Airport is 4.99 inches in June 1982, the same month in which the highest 24-hour precipitation total was recorded (2.87 inches) (Federal Emergency Management Agency, 1983). These and other locally heavy short-duration events have led to local flooding in the Ely area, as have periods of high spring snowmelt runoff. Historically, however, winter rain storms have not usually caused local flooding. For the water year between October 1, 2004, and October 1, 2005, the annual precipitation of 13.82 inches recorded at the Ely airport was approximately 45 percent above the annual average.

Floodplain delineations have not been mapped in Steptoe Valley north of Ely.

The Federal Emergency Management Agency classifies unmapped areas as being Zone D, which is defined as an area of undetermined, but possible, flood hazard (Map Index Community Panel Numbers 3200220925 and 3200220725). Consequently, the components of the White Pine Energy Station Proposed Action and Alternative 1 sites are not located within a specified floodplain.

3.3.3 Surface Water Features

Surface water features in Steptoe Valley consist of the various streams and creeks that drain the surrounding mountains, two small lakes (Comins and Bassett Lakes), and the ephemeral Goshute Lake, which is a playa or "dry" lake. These features are shown in Figure 3.3-1.

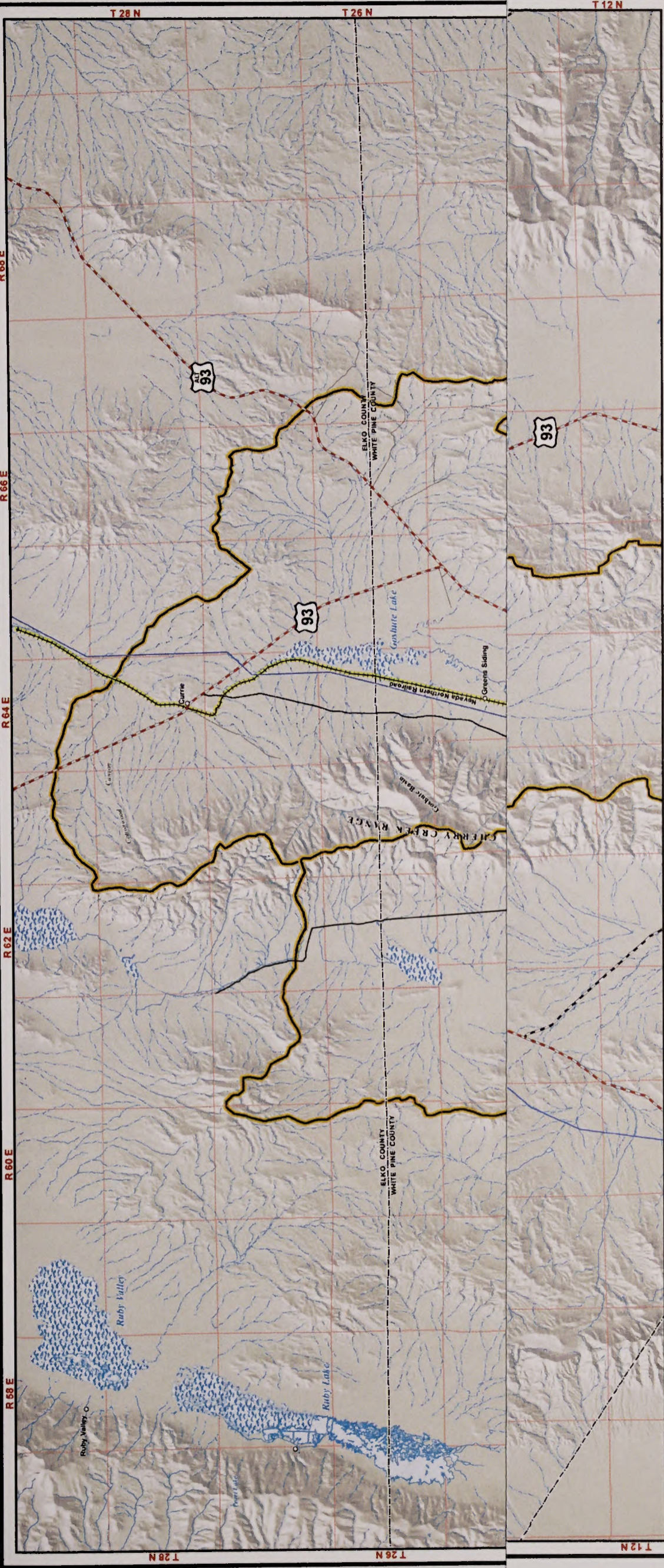

Hydrologic Setting of the Proposed Action and Alternative 1 White Pine Energy Station Project

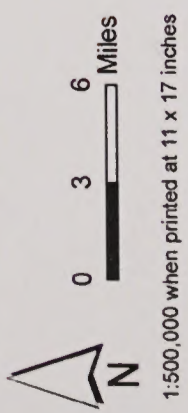
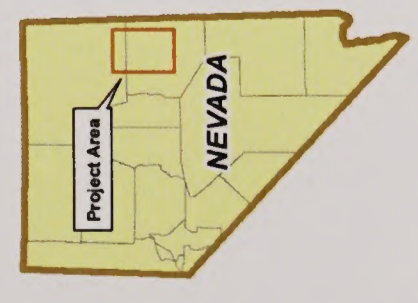

- | | | | |
|--------------------------------|---|---|---|
| Hydrobasin Boundary | Proposed Well Site | Proposed Water Pipeline/
Distribution Line | Proposed Water Pipeline/
Distribution Line |
| Surface Water | Proposed Water Pipeline/
Distribution Line | Proposed Rail Spur | Proposed Rail Spur |
| Perennial Stream or River | Proposed Rail Spur | Proposed Transmission Line | Proposed Transmission Line |
| Intermittent Stream or River | Proposed Transmission Line | Proposed Electric Distribution Line | Proposed Electric Distribution Line |
| Wetland | Proposed Electric Distribution Line | Proposed Access Road | Proposed Access Road |
| Connected Action | Proposed Access Road | Proposed Substation Site | Proposed Substation Site |
| SWIP Transmission Line | Proposed Substation Site | Proposed Power Plant Site | Proposed Power Plant Site |
| NNR Upgrade | Proposed Power Plant Site | | |
| Common Project Features | | | |
| Minerals Materials Sale Area | | | |
| Moriah Ranches | | | |
| Seeding Project | | | |

Figure 3.3-1

TABLE 3.3-1

Average Monthly Climatic Data Ely and McGill, Nevada

	Jan	Feb	Mar	Apr	May	Jun	Jul	Aug	Sep	Oct	Nov	Dec	Annual
Ely, Nevada ^a													
Average Maximum Temperature (°F)	39.1	42.2	48.5	57.4	67.3	78.1	87.1	84.6	75.7	63.0	49.0	40.7	61.1
Average Minimum Temperature (°F)	10.5	15.0	20.7	26.8	33.8	40.5	48.1	46.9	37.5	28.3	18.9	11.9	28.2
Average Total Precipitation (inches)	0.75	0.72	0.96	1.01	1.09	0.70	0.59	0.81	0.75	0.84	0.68	0.62	9.52
Average Total Snowfall (inches)	8.8	7.3	8.9	6.2	2.7	0.1	0.0	0.0	0.3	2.5	5.3	7.9	50.1
Average Monthly Climatic Data McGill, Nevada (264950) ^b													
Average Maximum Temperature (°F)	39.0	42.4	49.0	57.4	67.4	77.9	86.7	84.6	76.1	63.8	49.7	41.1	61.3
Average Minimum Temperature (°F)	15.7	19.3	24.4	30.9	38.6	47.0	55.2	53.3	43.9	33.8	23.9	17.4	33.6
Average Total Precipitation (inches)	0.62	0.63	0.70	0.95	1.03	0.80	0.66	0.79	0.71	0.79	0.55	0.57	8.79
Average Total Snowfall (inches)	4.0	4.3	3.3	2.0	0.3	0.1	0.0	0.0	0.0	0.5	1.6	3.1	19.2

^a Period of Record: 1/1/1897 to 9/30/2004

^b Period of Record: 1/1/1914 to 9/30/2004

Source: <http://www.wrcc.dri.edu/summary/climsmnv.html>

These average values, however, do not reflect the timing or amounts of the most extreme precipitation events. Specifically, the highest monthly precipitation total on record at Ely Airport is 4.99 inches in June 1982, the same month in which the highest 24-hour precipitation total was recorded (2.87 inches) (Federal Emergency Management Agency, 1983). These and other locally heavy short-duration events have led to local flooding in the Ely area, as have periods of high spring snowmelt runoff. Historically, however, winter rain storms have not usually caused local flooding. For the water year between October 1, 2004, and October 1, 2005, the annual precipitation of 13.82 inches recorded at the Ely airport was approximately 45 percent above the annual average.

Floodplain delineations have not been mapped in Steptoe Valley north of Ely.

The Federal Emergency Management Agency classifies unmapped areas as being Zone D, which is defined as an area of undetermined, but possible, flood hazard (Map Index Community Panel Numbers 3200220925 and 3200220725). Consequently, the components of the White Pine Energy Station Proposed Action and Alternative 1 sites are not located within a specified floodplain.

3.3.3 Surface Water Features

Surface water features in Steptoe Valley consist of the various streams and creeks that drain the surrounding mountains, two small lakes (Comins and Bassett Lakes), and the ephemeral Goshute Lake, which is a playa or "dry" lake. These features are shown in Figure 3.3-1.

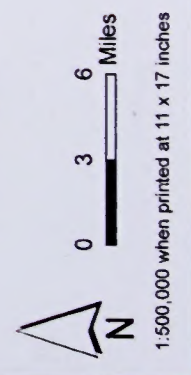
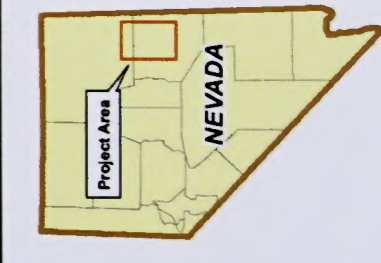
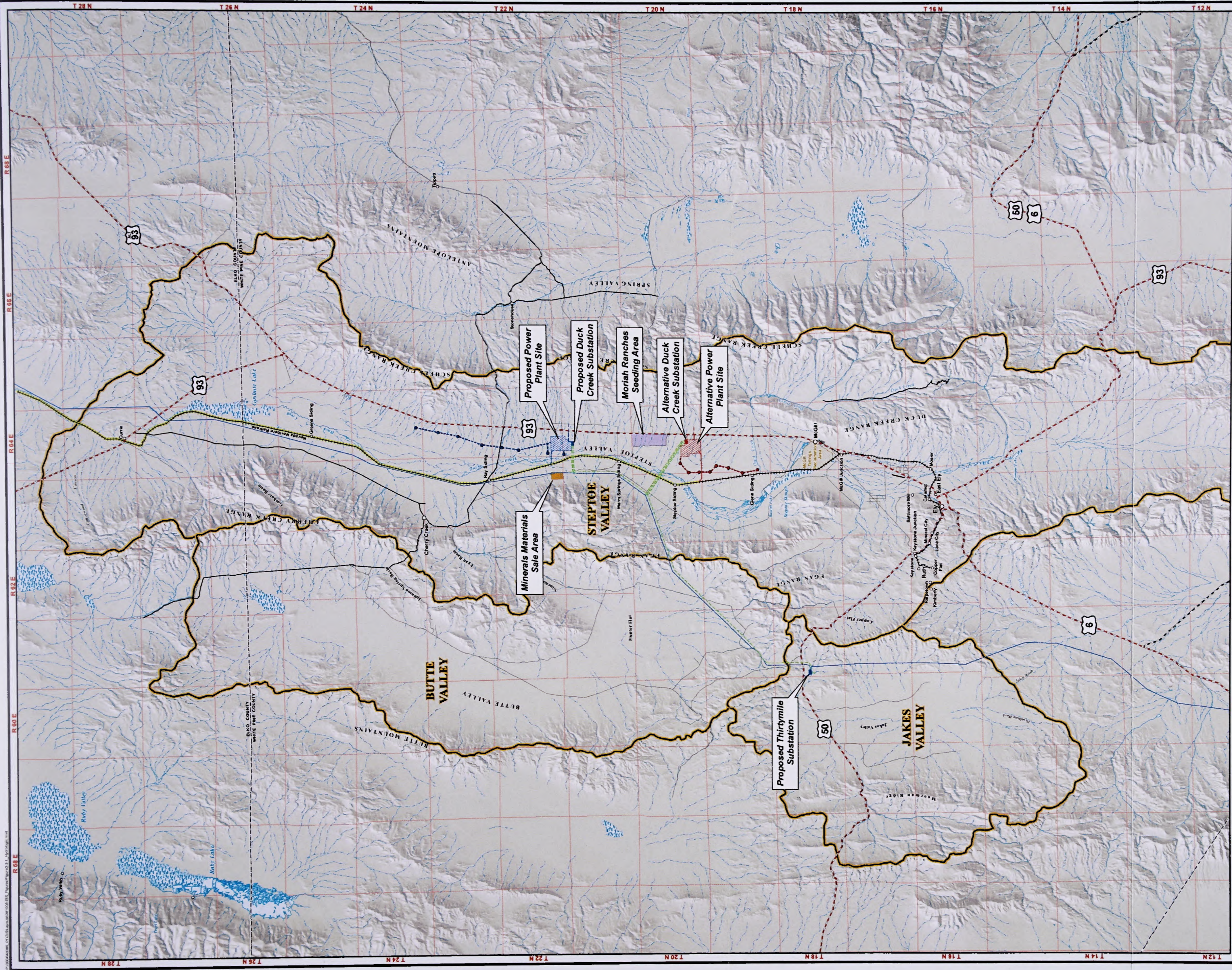

Hydrologic Setting of the Proposed Action and Alternative 1 White Pine Energy Station Project

- | | | |
|--------------------------------|---|---|
| Hydrobasin Boundary | Proposed Action Project Features | Alternative 1 Project Features |
| Surface Water | Proposed Well Site | Proposed Well Site |
| Perennial Stream or River | Proposed Water Pipeline/Distribution Line | Proposed Water Pipeline/Distribution Line |
| Intermittent Stream or River | Proposed Rail Spur | Proposed Rail Spur |
| Wetland | Proposed Transmission Line | Proposed Transmission Line |
| Connected Action | Proposed Electric Distribution Line | Proposed Electric Distribution Line |
| SWP Transmission Line | Proposed Access Road | Proposed Access Road |
| NNR Upgrade | Proposed Substation Site | Proposed Substation Site |
| Common Project Features | Proposed Power Plant Site | Proposed Power Plant Site |
| Minerals Materials Sale Area | | |
| Moriah Ranches | | |
| Seeding Project | | |

Figure 3.3-1



3.3.3.1 Streams

The principal streams in Steptoe Valley originate in the higher mountains surrounding the valley (the Egan Range, Schell Creek Range and Cherry Creek Mountains), and are identified in Figure 3.3-1. Of these streams, only two, Duck Creek and Steptoe Creek, flow perennially onto the valley floor. Other streams in the basin only reach the valley floor when runoff from either snowmelt or precipitation is sufficiently high. The remainder of the time, either the sources of these smaller streams naturally cease to flow, and/or the streams terminate where and when they infiltrate into their stream beds upon leaving the mountain canyons. The source of many of the streams is spring discharge in the higher mountains that flank the valley to the east and west.

While many of the springs may flow perennially, their discharge alone is not high enough to sustain flow for any appreciable distance onto the valley floor, apart from the springs that feed Duck Creek and Steptoe Creek (see Section 3.4.2.5, *Ground Water Discharge from Steptoe Valley*, and Section 3.4.2.5.1, *Springs*).

Although no significant streams flow from the relatively low lying hills that rim the northeastern portion of the basin (for example, the Antelope Range, Currie Hills), the ephemeral Nelson Creek drains the area north of the settlement of Currie toward Goshute Valley. A topographic divide within the Steptoe Valley Hydrographic Area near Currie enables surface water north of this divide to flow via Nelson Creek into the Goshute Valley Hydrographic Area (see Figure 3.3-2). However, both sides of this divide are enclosed basins with respect to surface water resources (surface water flows terminate at

Goshute Lake south of the divide and within the Goshute Valley north of this divide).

The two largest streams in Steptoe Valley are Steptoe Creek and Duck Creek (see Figure 3.3-1). Steptoe Creek, which flows northward along the axis of the main valley primarily south of Ely, and its principal tributary, Cave Creek, both flow from the western flank of the Schell Creek Range. Data from a gauging station 0.8 mile upstream of the confluence with Cave Creek show that average annual flows in Steptoe Creek range from 2.8 to 18.8 cubic feet per second (cfs) (Table 3.3-2). Inasmuch as these values represent average annual flows, the range between the maximum and the minimum flows could vary considerably over a given year.

Typical of the streams on the valley floor, Steptoe Creek is considered to be a "losing" stream throughout its entire length. The source of water to the creek is runoff from precipitation rather than ground water. Water in Steptoe Creek is therefore continually "lost" to the subsurface as it infiltrates through the streambed. Clark and Riddell (1920) measured the decrease in flow with distance from the base of the mountains and reported that Steptoe Creek loses 0.27 cfs per mile across the valley. More recent studies in this regard are not known to have been conducted. Flow in Steptoe Creek typically terminates north of the Ely airport; however, during wet years it has been known to flow as far north as the Bassett Lake area and actually flow into Duck Creek during very wet years (Frick, 1985). Streams that receive inflow from ground water are referred to as "gaining" streams. Such streams, which are not known to occur on the floor of Steptoe Valley, are therefore perennial throughout their length because they are sustained by a base level of ground water discharge.

TABLE 3.3-2

Average Annual Flow in Steptoe Creek 1966 -2002

Year	Average Discharge (cfs)	Year	Average Discharge (cfs)
1966	2.9	1985	8.1
1967	8.1	1986	9.6
1968	6.1	1987	5.3
1969	11.0	1988	5.4
1970	5.0	1989	3.3
1971	7.9	1990	2.8
1972	4.8	1991	3.6
1973	9.1	1992	2.8
1974	4.8	1993	5.7
1975	9.0	1994	3.3
1976	4.6	1995	10.0
1977	3.7	1996	4.3
1978	9.4	1997	5.0
1979	6.6	1998	9.5
1980	9.4	1999	6.5
1981	5.6	2000	4.2
1982	9.3	2001	4.2
1983	18.8	2002	2.8
1984	13.1		

Source: Savard and Crompton (1993); Waterdata.usgs.gov/nv/nwis/discharge (2 May 2005)

Location: 0.1 mile downstream of Clear Creek; 0.8 mile upstream from Cave Creek; 11 miles east of Ely.

Latitude: 39.1205, Longitude: 114.4115

The principal stream in the vicinity of the Proposed Action and Alternative 1 power plant sites is Duck Creek, which originates in Duck Creek Valley east of the Duck Creek Range in the east central part of the basin (see Figure 3.3-1). The principal

tributaries to Duck Creek drain the Schell Creek Range east of Duck Creek Valley, and include Berry Creek, Timber Creek, Bird Creek, East Creek, and North Creek. Historically, Duck Creek was the principal source of water for the Town of McGill and the smelter that operated in that town.

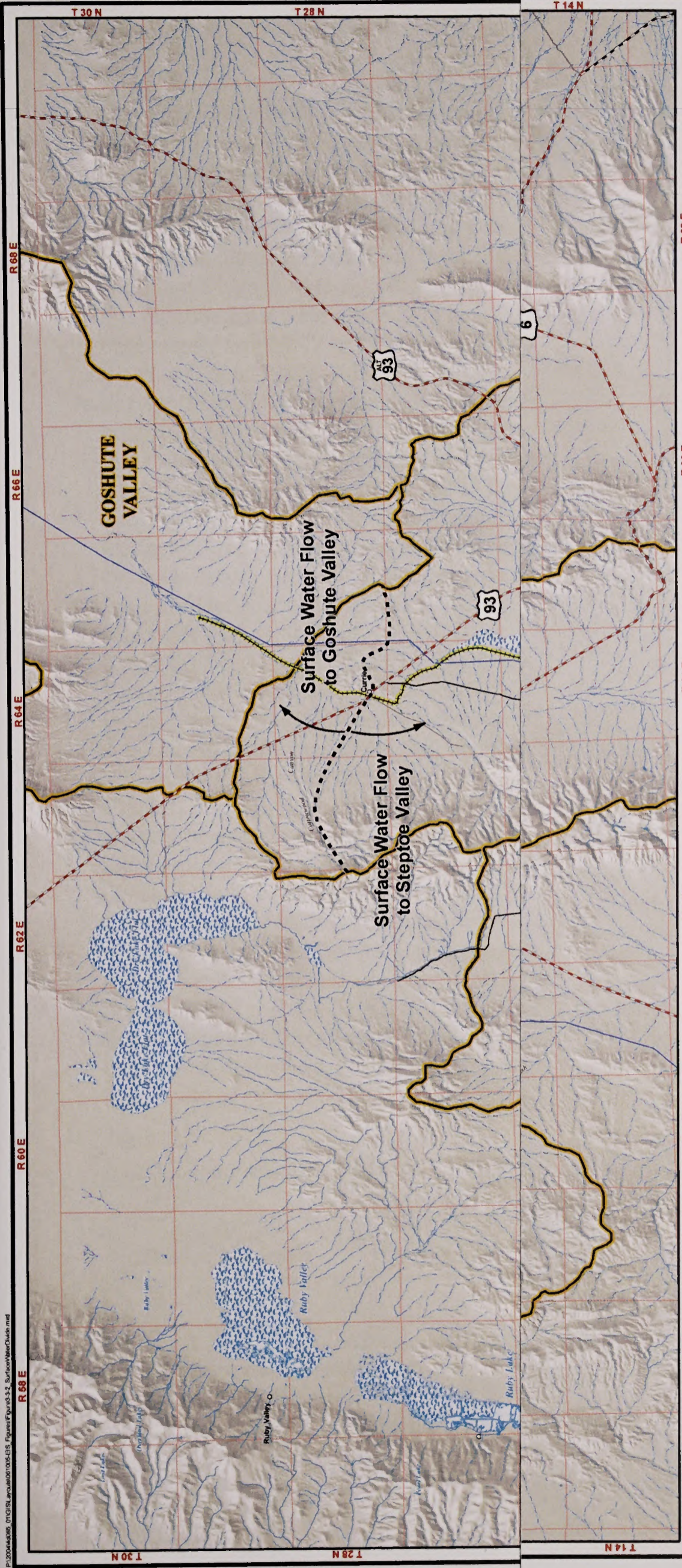

Location of Surface Water Divide Within Steptoe Hydrographic Region White Pine Energy Station Project

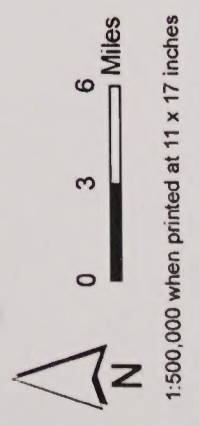
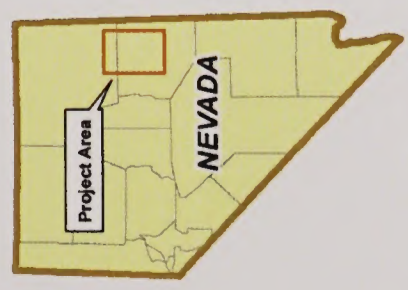

- Surface Water Divide**
- Hydrobasin Boundary**
- Surface Water**
 - Perennial Stream or River
 - Intermittent Stream or River
 - Wetland
- Connected Action**
 - SWIP Transmission Line
 - NNR Upgrade
- Common Project Features**
 - Minerals Materials Sale Area
 - Moriah Ranches
 - Seeding Project

- ### Proposed Action Project Features
- Proposed Well Site
 - Proposed Water Pipeline/
Distribution Line
 - Proposed Rail Spur
 - Proposed Transmission Line
 - Proposed Electric Distribution Line
 - Proposed Access Road
 - Proposed Substation Site
 - Proposed Power Plant Site

- ### Alternative 1 Project Features
- Proposed Well Site
 - Proposed Water Pipeline/
Distribution Line
 - Proposed Rail Spur
 - Proposed Transmission Line
 - Proposed Electric Distribution Line
 - Proposed Access Road
 - Proposed Substation Site
 - Proposed Power Plant Site

Figure 3.3-2

TABLE 3.3-2

Average Annual Flow in Steptoe Creek 1966 -2002

Year	Average Discharge (cfs)	Year	Average Discharge (cfs)
1966	2.9	1985	8.1
1967	8.1	1986	9.6
1968	6.1	1987	5.3
1969	11.0	1988	5.4
1970	5.0	1989	3.3
1971	7.9	1990	2.8
1972	4.8	1991	3.6
1973	9.1	1992	2.8
1974	4.8	1993	5.7
1975	9.0	1994	3.3
1976	4.6	1995	10.0
1977	3.7	1996	4.3
1978	9.4	1997	5.0
1979	6.6	1998	9.5
1980	9.4	1999	6.5
1981	5.6	2000	4.2
1982	9.3	2001	4.2
1983	18.8	2002	2.8
1984	13.1		

Source: Savard and Crompton (1993); Waterdata.usgs.gov/nv/nwis/discharge (2 May 2005)

Location: 0.1 mile downstream of Clear Creek; 0.8 mile upstream from Cave Creek; 11 miles east of Ely.

Latitude: 39.1205, Longitude: 114.4115

The principal stream in the vicinity of the Proposed Action and Alternative 1 power plant sites is Duck Creek, which originates in Duck Creek Valley east of the Duck Creek Range in the east central part of the basin (see Figure 3.3-1). The principal

tributaries to Duck Creek drain the Schell Creek Range east of Duck Creek Valley, and include Berry Creek, Timber Creek, Bird Creek, East Creek, and North Creek. Historically, Duck Creek was the principal source of water for the Town of McGill and the smelter that operated in that town.

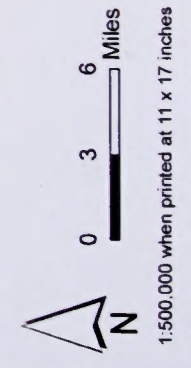
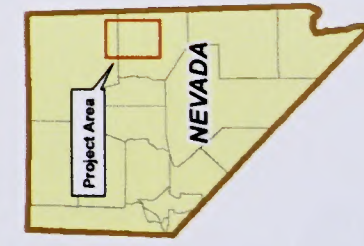
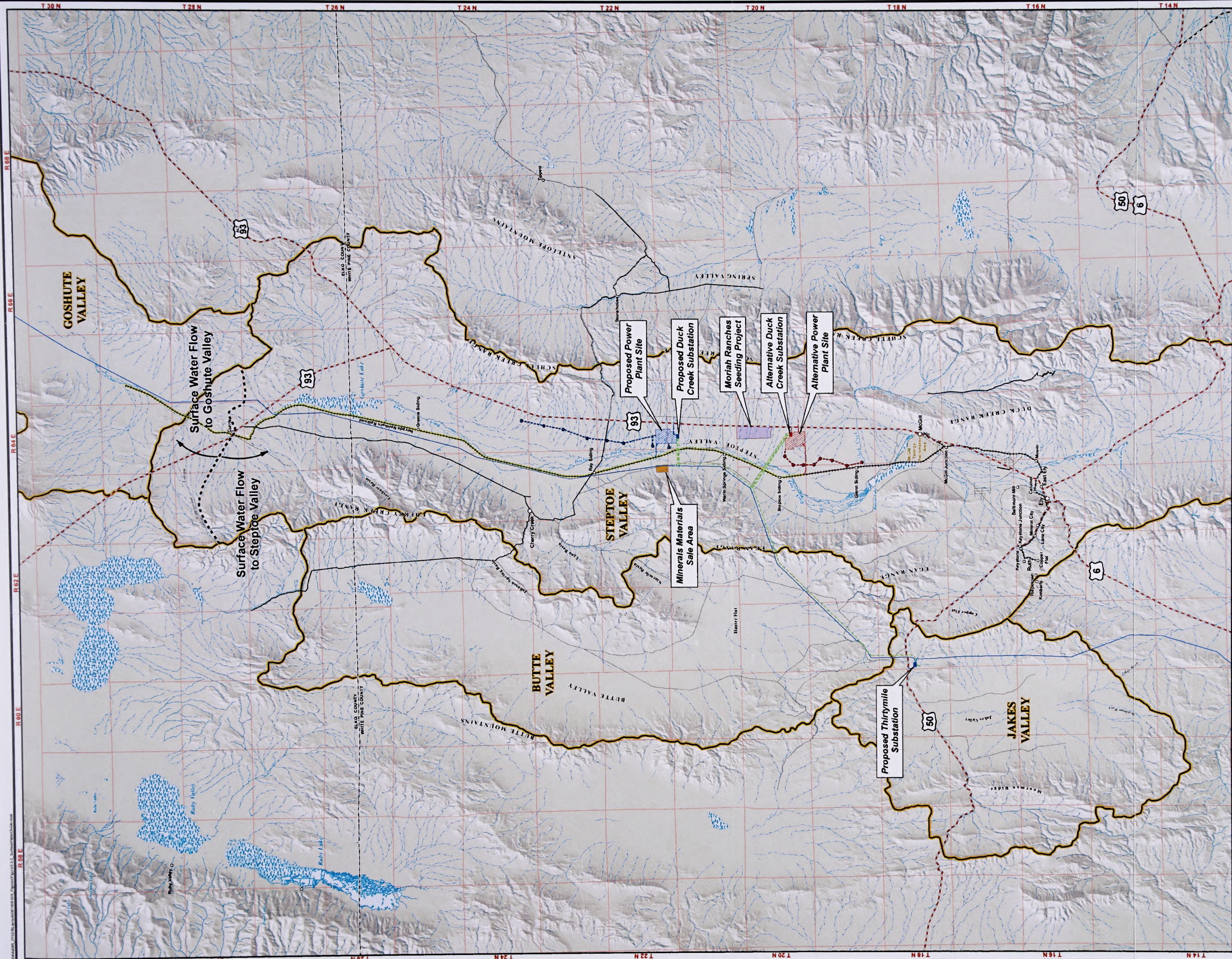

- Surface Water Divide
- ▭ Hydrobasin Boundary
- Surface Water**
 - Perennial Stream or River
 - Intermittent Stream or River
 - ▨ Wetland
- Connected Action**
 - SWIP Transmission Line
 - NNR Upgrade
- Common Project Features**
 - ▭ Minerals Materials Sale Area
 - ▭ Moriah Ranches
 - ▭ Seeding Project

- Proposed Action Project Features**
 - Proposed Well Site
 - Proposed Water Pipeline/Distribution Line
 - Proposed Rail Spur
 - Proposed Transmission Line
 - Proposed Electric Distribution Line
 - Proposed Access Road
 - ▭ Proposed Substation Site
 - ▭ Proposed Power Plant Site

- Alternative 1 Project Features**
 - Proposed Well Site
 - Proposed Water Pipeline/Distribution Line
 - Proposed Rail Spur
 - Proposed Transmission Line
 - Proposed Electric Distribution Line
 - Proposed Access Road
 - ▭ Proposed Substation Site
 - ▭ Proposed Power Plant Site

**Location of Surface Water Divide
Within Steptoe Hydrographic Region
White Pine Energy Station Project**

Figure 3.3-2



Currently, water from Duck Creek continues to be used for dust mitigation on the tailings piles located immediately west of McGill. The water is conveyed to these piles via a 32-inch pipeline, which originates at a small reservoir located on Duck Creek near the confluence with Bird Creek. Flows through this pipeline have been reported to be consistently around 12 to 13 cfs throughout the year (Frick, 1985). However, these values of flow through the pipeline do not represent high runoff conditions when portions of the flow bypass the pipeline intake. Under these conditions of higher flow, the water in Duck Creek follows its natural channel through Gallagher Gap and then divides into several channels before typically infiltrating into the large alluvial fan north of McGill. During extremely high flows, this reach of Duck Creek has been known to reach Bassett Lake. Bassett Lake gives new life to Duck Creek, which reappears as outflow from the lake and subsequently meanders along the central axis of the valley. Like Steptoe Creek, Duck Creek continually loses water through infiltration as it flows across the valley floor. During normal to dry years, the flow in Duck Creek is too low to sustain flow north of Cherry Creek Road throughout the year (Frick, 1985). The only data from a gauging station 8 miles southeast of Cherry Creek are presented in Table 3.3-3. While the data in this table indicate that the average flow is over 40 cfs, this average takes into account high flows of over 100 cfs, which occurred in

February and March, and low flows of less than 1 cfs, which occurred in July and August during these particular years. The implication is that even when flows in Duck Creek were as high as 130 cfs in the spring, by summer the flows were very low (less than 1 cfs) at the same location, which is at least 20 miles upstream of Goshute Lake. In addition, during the preparation of this document, no flow was observed to be present in Duck Creek at the gauging station 8 miles south of Cherry Creek on 9 August, 2005. This observation was noted during a year when the annual precipitation at Ely in 2005 was 45 percent higher than normal (see Section 3.3.2).

A few small ephemeral creeks run through the footprints of the Proposed Action and Alternative 1 power plant sites. Specifically, Whiteman Creek flows through the Proposed Action site, and First Creek and the Kinsey Canyon drainage flow through the Alternative 1 power plant site. All of these creeks originate from the Schell Creek Range, but only convey water seasonally for short durations in wet years, and typically do not carry water all the way to Duck Creek. Additionally, all surface drainage from the Proposed Action and Alternative 1 power plant sites flows toward Duck Creek; however, unless the source of water is considerable, surface drainage from these sites will infiltrate prior to reaching Duck Creek.

TABLE 3.3-3
Duck Creek Discharge South of Cherry Creek Road

Water Year (October-September)	Discharge (cfs)		
	Mean	Maximum	Minimum
1986	45.1	130	0.7
1987	44.9	115	1.6

Source: Savard and Crompton (1993)
Location: 8 miles south of Cherry Creek; Latitude = 39.4815; Longitude = 114.3804 (only data available)

Natural ephemeral washes and intermittent streams perform a diversity of hydrologic and biogeochemical functions that affect the integrity and condition of higher-order waters downstream. Healthy ephemeral waters with characteristic plant communities control rates of sediment deposition and dissipate the energy associated with flood flows. Ephemeral washes also provide habitat for breeding, shelter, foraging, and movement of wildlife. Many plant populations are dependent on these aquatic ecosystems and are adapted to the unique conditions of these systems.

The route of the proposed water pipeline linking the Proposed Action well field to the Proposed Action power plant site crosses the ephemeral drainages of Whiteman Creek, Tehama Creek, and Schell Creek, and numerous other unnamed ephemeral washes that originate on the eastern side of the basin. The proposed water pipeline linking the Alternative 1 well field to the Alternative 1 power plant site does not cross any specifically identified surface water drainages, either named or unnamed.

Section 3.5.1.1.10, *Wetlands*, discusses drainages within the Station project area that are potentially under the jurisdiction of the U.S. Army Corps of Engineers as “waters of the United States” and “other potential waters of the United States.”

3.3.3.2 Lakes

Within the Steptoe Valley Hydrographic Area there are three principal lake features: Comins Lake, Bassett Lake, and Goshute Lake (see Figure 3.3-1). Comins Lake is primarily spring fed, but also receives water from local small creeks. Bassett Lake, which is a man-made feature, is principally fed by runoff from the dust mitigation irrigation system on the tailings piles west of McGill. In addition, Bassett

Lake receives inflow from springs and periodically receives water from Duck Creek and Steptoe Creek during high runoff periods. Goshute Lake is a playa, or “dry” lake, that receives discharge from a few local springs, adjacent ephemeral creeks, and water from Duck Creek during high flow periods.

3.3.4 Water Quality

Nevada’s 2004 Section 303(d) list of impaired waters, which was approved by EPA as a final list in November 2005, shows no Clean Water Act Section 303(d) impaired waters in the project area. The Nevada Division of Environmental Protection (NDEP) has recently released a draft 2006 303(d) list. Comins Lake, which is just south of Ely, is included on the list. Data from other streams in Steptoe Valley indicate that the surface water quality is characterized by moderate concentrations (less than 400 milligrams per liter of total dissolved solids (Eakin et al., 1967), and a chemical composition of mainly calcium and magnesium bicarbonate. The total dissolved solids concentrations are typically influenced by the flow rate of the streams (total dissolved solids concentrations decrease when flow rate increases and tend to increase during times of low flow). When and where its flow ceases, Duck Creek is reduced to small pockets or isolated pools of standing water based on observations made during the preparation of this document. These small isolated pools of standing water are likely to become progressively more concentrated in total dissolved solids during the course of a given year as their volume is reduced through evaporation. Furthermore, inasmuch as livestock ranching is common along and adjacent to much of Duck Creek along the bottom of Steptoe Valley, the water quality of Duck Creek is heavily influenced by cattle grazing adjacent to and/or within Duck Creek.

3.4 Ground Water Resources

This section provides context for the evaluation of potential environmental consequences as a result of pumping local ground water resources in Steptoe Valley to meet the water demand for the proposed White Pine Energy Station. Springs are discussed under ground water resources (see Section 3.4.2.5.1, *Springs*) because they are an expression of ground water function and influence.

3.4.1 Regional Conditions and Basic Concepts

The proposed Station is located within the Basin and Range Physiographic Province, a name that refers to the general pattern of alternating valleys (basins) and mountain ranges that characterize the landscape of the southwestern United States (see Section 3.2, *Geology, Soils, and Mineral Resources*).

Within the Basin and Range Province, ground water occurs within two different subsurface geologic environments: 1) the sediments that have filled the basins to their current elevations (basin-fill deposits), and 2) the rock, where sufficiently fractured, that underlies these sediments and comprises the surrounding mountains.

3.4.1.1 Ground Water within the Basin-Fill Deposits

The basin-fill deposits consist of unconsolidated sediments (for example, gravel, sand, silt, and clay), which are produced by the erosion of the mountains and hills that surround the valleys. Streams and creeks flow from the mountains transporting, and eventually depositing, these sediments within the adjacent valleys. The resulting basin-fill deposits are, therefore, typically discontinuous layers of sand and gravel mixtures that alternate with layers of silt and clay mixtures.

The relative abundance of coarse- or fine-grained sediments at a given location within these basin-fill deposits depends on the physical conditions at the time these sediments were deposited. Coarse-grained sediments, such as sand and gravel, require more energy to transport relative to fine-grained silt and clay. Accordingly, coarser sediments are found in those areas where past stream flows were relatively high: for example, adjacent to the mountain fronts or along the banks of the larger streams. Conversely, with smaller creeks, or where the flows in larger streams slowed as they entered the flatter valley floor from the adjacent mountains, less energy is available for sediment transport resulting in deposits of finer-textured silt and clay.

Coarser sediments are better at storing and conveying ground water through the subsurface and yielding water to wells. When saturated, layers of coarser sediments are referred to as aquifers. The interbedded layers of finer-textured silt and clay tend to be relatively impermeable and act to confine deeper basin-fill aquifers under pressure.

Ground water in basin-fill aquifers generally flows in directions that coincide with decreasing ground surface elevations (“downhill”). Basin-fill aquifers, which are the principal source of water to wells in the Basin and Range Province, are typically localized within the boundaries of a given basin. However, where basin-fill deposits of two adjacent basins merge, ground water can flow between basins within aquifers that are common to both basins.

3.4.1.2 Fractured-Rock Ground Water Systems

In addition to the basin-fill deposits, the rock that underlies these sediments can also be considered as an aquifer and store and

convey ground water where the rock is sufficiently fractured. Because the fractured-rock aquifers typically underlie the basin-fill deposits, ground water in fractured rock is deeper and represents regional aquifer systems where ground water flows irrespective of the local topography and basin boundaries. Ground water in deep fractured-rock aquifers flows in response to regionally controlled hydraulic gradients that link regional recharge and discharge areas, and is generally not significantly influenced by conditions in the overlying basin-fill aquifers.

The most important regional fractured-rock aquifer in eastern Nevada coincides with the Carbonate Rock Province, which derives its name from the consistent presence of massive sequences of carbonate rocks (limestone and dolomite) that extend over a large area of present-day eastern Nevada, western Utah, and southwestern Idaho. The proposed Station is located within the Carbonate Rock Province, near its eastern boundary.

The carbonate rocks in this region are brittle and subject to fracturing. Under ideal geochemical conditions, these underlying rocks can dissolve and form cavities that further enhance the ability of the rock to store and transmit ground water.

3.4.2 Local Conditions

The physical components of the Station Proposed Action and Alternative 1 (for example, the power plant and associated infrastructure) would be located within three separate hydrographic areas as defined by the USGS and the Nevada Division of Water Resources (see Figure 3.3-1). Specifically, the Proposed Action and Alternative 1 power plant sites, rail spurs, well fields and associated water pipelines, and the initial segments (approximately 17 miles) of the high voltage transmission line easement

would be located within the Steptoe Valley Hydrographic Area (Basin 179). The middle segments of the transmission line easement would cross approximately 15 miles of the Butte Valley Hydrographic Area (Basin 178), and approximately 2 miles of the remaining transmission line easement would cross into the northern part of the Jakes Valley Hydrographic Area (Basin 174).

Accordingly, this discussion of the ground water resources affected environment focuses on the Steptoe Valley Hydrographic Area. In addition to most of the physical components of the proposed Station being located in Steptoe Valley, the source of water to the Proposed Action and Alternative 1 well fields is ground water that naturally originates and discharges through the basin-fill deposits of Steptoe Valley.

The U.S. Geological Survey's (2007) recent determination that the ground water between certain valleys in Nevada is connected is from the *Basin and Range Carbonate Aquifer System (BARCAS) Study*, which currently is in draft form. This conclusion of interconnectivity of ground water across hydrographic areas in White Pine County pertains to ground water in deep fractured rock. As noted previously, the water supply for either the Proposed Action or Alternative 1 would be ground water from the basin-fill deposits of Steptoe Valley that are not directly connected hydrologically to adjacent hydrographic areas. Therefore, ground water used for the Proposed Action or Alternative 1 would not be connected hydrologically to the amount or rate of groundwater flow from Steptoe Valley to adjacent valleys, such as Goshute Valley, Snake Valley, or Spring Valley.

3.4.2.1 Steptoe Valley Physical Setting

Elongated in a generally north-south direction, Steptoe Valley is sandwiched between the Schell Creek and Duck Creek

Ranges to the east and the Cherry Creek and Egan Ranges to the west (see Figure 3.3-1). The ridges of these east and west flanking mountains generally rise between 3,000 and 5,000 feet above the valley floor, with the elevations of highest peaks in each of the four principal ranges exceeding 10,000 feet above mean sea level. North Schell Peak, which is located immediately southeast of McGill at an elevation of over 11,880 feet, is the highest point within the hydrographic area.

To the north, the boundary between the Steptoe Valley and Goshute Valley Hydrographic Areas consists of a series of northwest-southeast trending hills including Boone Spring Hills, Antelope Range, Currie Hills, and the Palomino Ridge (see Figure 3.3-1). These hills, which rise no more than 1,500 feet above the valley floor, are relatively low compared with the mountains that flank the main valley to the east and west. Although the valley is essentially encircled by the surrounding hills and mountains, a narrow gap along Nelson Creek north of the settlement of Currie is not separated from surrounding basins by a topographic divide (see Section 3.3, *Surface Water Resources*).

The total area of the Steptoe Valley Hydrographic Area covers approximately 1,942 square miles. Stretching approximately 110 miles from north to south, it has a maximum width of only 28 miles. The floor of Steptoe Valley slopes generally toward Goshute Lake at the northern end of the valley. The highest elevation of the valley floor, therefore, occurs at the southernmost end where it is approximately 7,200 feet above sea level. Conversely, the lowest point of the valley floor is at an elevation of 5,740 feet along the northern boundary of the basin where the ephemeral Nelson Creek flows into

Goshute Valley to the north (Frick, 1985) (see Section 3.3, *Surface Water Resources*).

3.4.2.2 Ground Water Movement and Storage Characteristics in Steptoe Valley

Ground water in Steptoe Valley is stored and conveyed principally through the saturated unconsolidated basin-fill deposits. Although regionally significant, the fractured-rock aquifer in the carbonate rocks, which directly underlie the basin-fill deposits in Steptoe Valley, does not directly yield ground water either to local wells or to the wells proposed for the Proposed Action or Alternative 1 (wells that withdraw ground water from the carbonate rocks in Steptoe Valley are not known to exist, and the wells proposed for either the Proposed Action or Alternative 1 would tap into ground water in the overlying basin-fill deposits and not in the deep carbonate rocks). Accordingly, this discussion and the subsequent impact analysis in Section 4.4, *Drinking Water Quality and Ground Water Resources*, focuses on ground water within the basin-fill aquifers of Steptoe Valley.

The underground movement and storage of ground water are defined by the hydraulic conductivity and storage coefficient of the aquifer. The implications of different values of these parameters are discussed in Section 4.4, *Ground Water Resources*. Hydraulic conductivity refers to the ability of geologic material to transmit water, and it is an important factor in determining:

- 1) the average linear rate, or velocity, of ground water flow;
- 2) the hydraulic gradient or "slope" of the water table;
- 3) the potential amount a well is capable of pumping (well yield); and
- 4) the resulting spatial pattern of ground water decline that results from pumping a well.

Values of hydraulic conductivity within the Steptoe Valley basin-fill aquifers vary

primarily with depth as a result of alternating layers of coarse- and fine-textured sediments. In addition, values of hydraulic conductivity also tend to vary across the valley, with coarser (higher hydraulic conductivity) sediments located closer to the mountain fronts where past surface water flows have been high enough to transport larger-grained sediments (for example, sand and gravel). In Steptoe Valley, these coarser sediments occur where the two perennial creeks, Steptoe Creek and Duck Creek (see Section 3.3, *Surface Water Resources*), have flowed historically, and where ephemeral streams and creeks flowing from the surrounding highland areas enter the valley.

The other important aquifer parameter to understand for the impact analysis presented in Section 4.4, *Ground Water Resources*, is the storage coefficient. The storage coefficient of the aquifer is the volume of water that is stored within a given volume of the aquifer. This parameter is important in understanding the resulting spatial pattern of ground water decline that results from pumping a well, and whether or not the ground water in an aquifer is under pressure (whether the aquifer is considered to be

“confined” or “unconfined”). Specifically, low values of storage coefficient (typically less than 0.001) indicate that ground water within an aquifer is confined under pressure, and that the water level in an associated well rises above the top of the aquifer. Higher values (typically greater than 0.001) signify that ground water is not confined under pressure and that the ground water surface forms a water table within the aquifer.

Values of hydraulic conductivity and specific yield in Steptoe Valley have been determined through a number of field measurements and have also been developed as a result of calibrating computer models of ground water flow in Steptoe Valley. The reported values of hydraulic conductivity and storage coefficient are summarized in Table 3.4-1. These values are representative of average conditions over variable depths within approximately 1,000 feet of the water table and do not necessarily represent conditions in the shallowest ground water within 50 feet of the ground water table. The data for storage coefficient in Table 3.4-1 suggest that ground water in the basin-fill deposits in Steptoe Valley is confined.

TABLE 3.4-1

Values of Hydraulic Conductivity and Storage Coefficient for Basin-Fill Aquifers in Steptoe Valley

Hydraulic Conductivity (feet/day)	Storage Coefficient	Source of Information
2.4 to 5.8	1.7×10^{-4} to 2.5×10^{-4}	Aquifer test, Steptoe Valley (Leeds, Hill, and Jewett, Inc., 1983)
5.8 ^a	1.0×10^{-4} to 2.0×10^{-4}	Calibrated ground water model, Steptoe Valley (Leeds, Hill, and Jewett, Inc., 1983)
0.09 to 432	1.0×10^{-4} ^b	Calibrated ground water model, Steptoe Valley (Frick, 1985)

^aThis value is calculated from a value of aquifer transmissivity (T, where T = hydraulic conductivity times aquifer thickness) of 94,000 gallons per day per foot (gpd/ft) based on stated aquifer thickness of 2,180 feet (Leeds, Hill, and Jewett, Inc., 1983). This value was the highest for T used in the model. The lowest value of T used was 24,000 gpd/ft, but this lower value could not be converted to an equivalent value of hydraulic conductivity because a corresponding value of aquifer thickness is unknown.

^bAssumed value used to calculate values of hydraulic conductivity from numerous pump and bailer tests using the method of Walton (1962) as reported by Frick (1985, page 93).

3.4.2.3 Local Ground Water Occurrence

Despite the data for storage coefficient in Table 3.4-1 that suggest all ground water in Steptoe Valley is confined under pressure, ground water likely occurs in both confined and unconfined aquifers within the basin-fill deposits in Steptoe Valley. Logs recording the geologic formations encountered in boreholes drilled in Steptoe Valley indicate that typical water-yielding deposits are layers of sand and gravel that range up to several hundred feet in thickness, but typically are on the order of approximately 20 feet thick. These water-yielding layers are confined by relatively impermeable layers of finer texture silt and clay that range from less than 5 feet to more than 100 feet in thickness. The specific nature and spatial variability of the local basin-fill aquifer units are illustrated through geologic logs of boreholes shown on Figures 3.4-1A and 3.4-1B for USGS wells 1, 2, and 3, and summarized in Table 3.4-2 for test wells 1A, 1B, and 1C. The locations of these boreholes are shown in Figure 3.4-2.

As indicated by the geologic descriptions in these logs, there is considerable variability in the stratigraphy across the basin and even between locations that are less than 1,000 feet apart. These geologic descriptions also indicate that multiple water-yielding layers or zones are potentially present. Previous investigations have grouped these multiple water-yielding zones into two separate principal aquifer units (Leeds, Hill, and Jewett, Inc., 1983; Frick, 1985). The upper unit is relatively shallow (with a depth to the water table of less than 50 feet below the ground surface), and is not likely to be a reliable source of sustained yield to wells for all but individual residential use. The deeper unit is considerably thicker and confined under pressure, and is a more

reliable source of ground water to wells. Accordingly, the wells for the Station would tap this deeper unit. The base of the basin-fill deposits within Steptoe Valley has been estimated to be more than 11,000 feet deep at a location northwest of McGill (Frick, 1985). Data from four petroleum exploration wells, ranging in depth between 3,900 and 7,030 feet below the ground surface within the valley, confirm that the thickness of the basin fill deposits is at least several thousand feet (Tumbusch and Schaefer, 1996). The tremendous thickness of these sediments implies that a considerable volume of ground water is stored within the basin. Typically, however, ground water wells in the valley are no deeper than 1,000 feet; therefore, much of the ground water in storage remains undeveloped. According to Eakin et al. (1967), the volume of ground water in storage within 100 feet of the water table over an area of 143,000 acres (approximately 223 square miles) is estimated to be approximate 2.1 million acre-feet. An acre-foot is the volume of water that covers an acre to a depth of 1 foot and is roughly equivalent to the average annual domestic water demand for two households (assuming four people per household; 100 gallons per day per person; Dunn and Leopold [1978]). The estimate by Eakin et al. (1967) is less than half of the estimate of 5 million acre-feet developed by the Nevada Department of Conservation and Natural Resources (1971), which reports the volume of ground water in storage within Steptoe Valley is 50,000 acre-feet per foot of aquifer thickness.

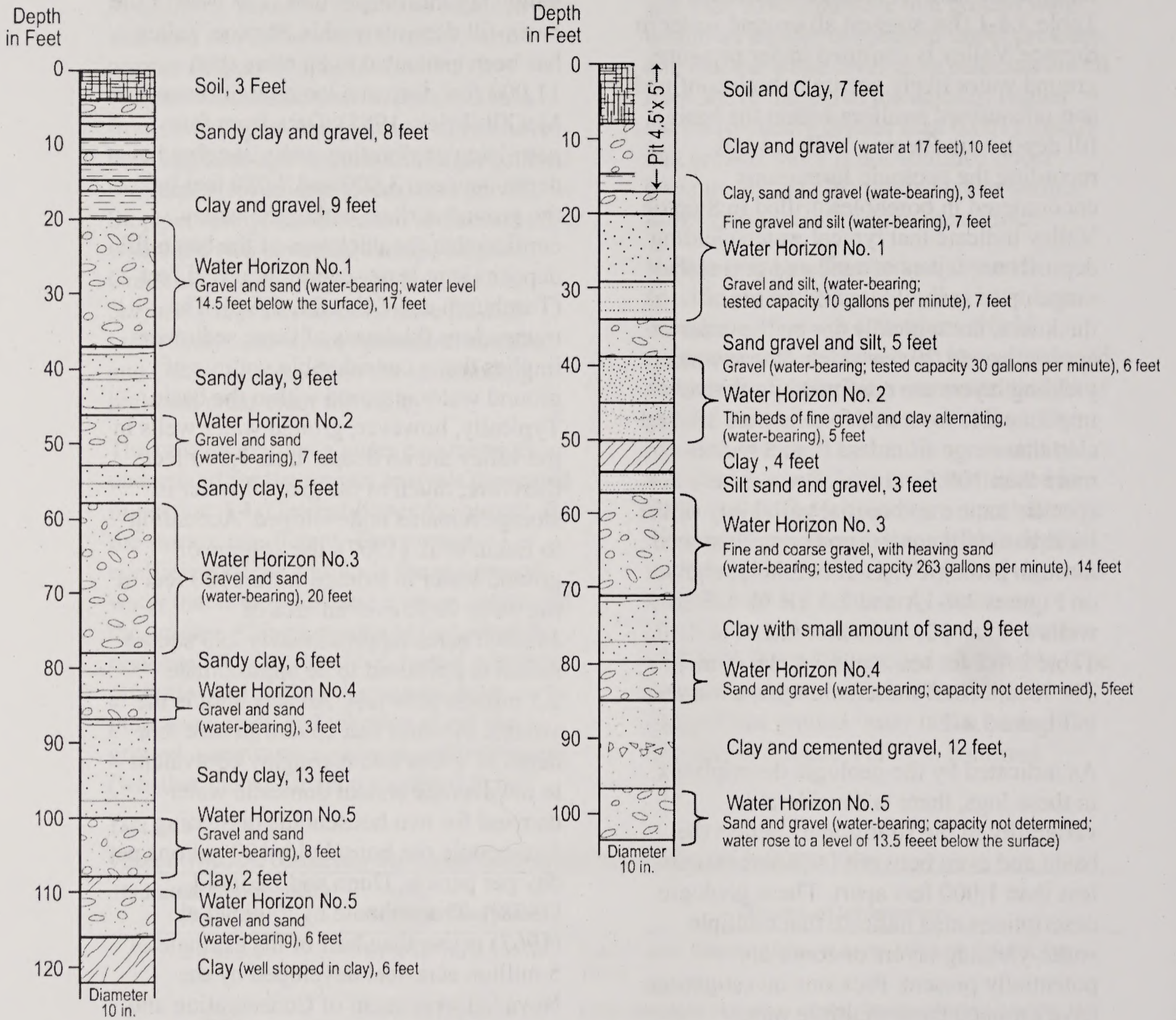

Figure 3.4-1A
Geologic Log of
USGS Steptoe Wells 1&3

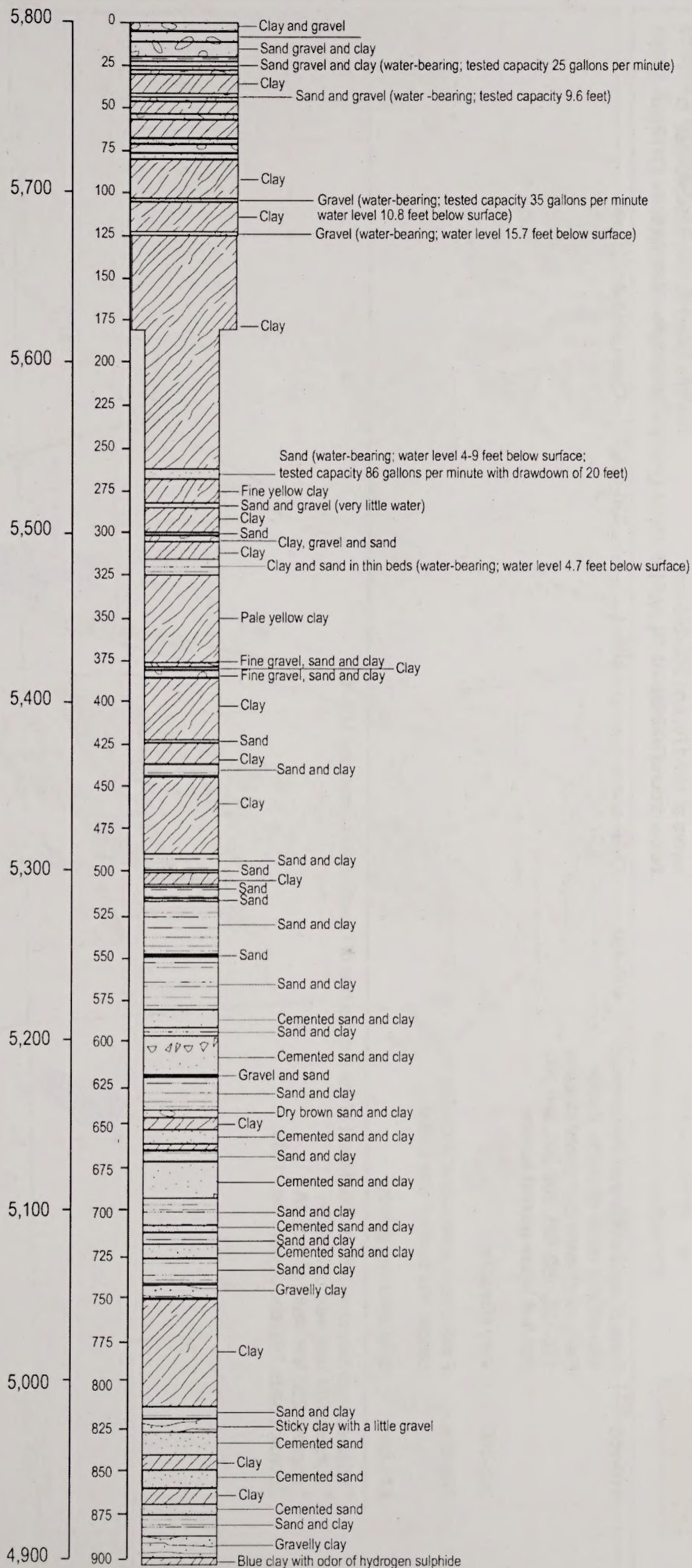

Figure 3.4-1B
Geologic Log of
USGS Steptoe Well 2

TABLE 3.4-2

General Geologic Description of Basin-Fill in Steptoe Valley

Well 1A ^a		Well 1B ^b		Well 1C ^c	
Depth Interval (feet below ground surface)	Geologic Description	Depth Interval (feet below ground surface)	Geologic Description	Depth Interval (feet below ground surface)	Geologic Description
0-110	Moderately to very silty sand and gravel	0-400	Silty to very silty sand and gravel layering. Clean sand and gravel layers at 160-170, and 230-245 feet below ground surface.	0-320	Silty sand and gravel. Clean sand and gravel layers at 115-120, 160-178, 208-215, and 225-245 feet below ground surface.
110-265	Zone of sand and gravel, interbedded with silt and minor amounts of clay. Fairly clean sand and gravel strata at 112-122, 160-195, 202-240, and 260-265 feet below ground surface	400-460	Clean coarse sand and gravel	320-455	Clean sand and gravel
265-360	Very silty sand				
360-675	Fairly clean gravel zone (includes cobble and boulder size rocks)				
675-995	Silty sand and gravel				

^a Located approximately 2 miles southwest of the intersection of Cherry Creek Road and U.S. 93

^b Located 924 feet west of Well 1A

^c Located 250 feet south of Well 1A

Source: Leeds, Hill, and Jewett, Inc., 1983

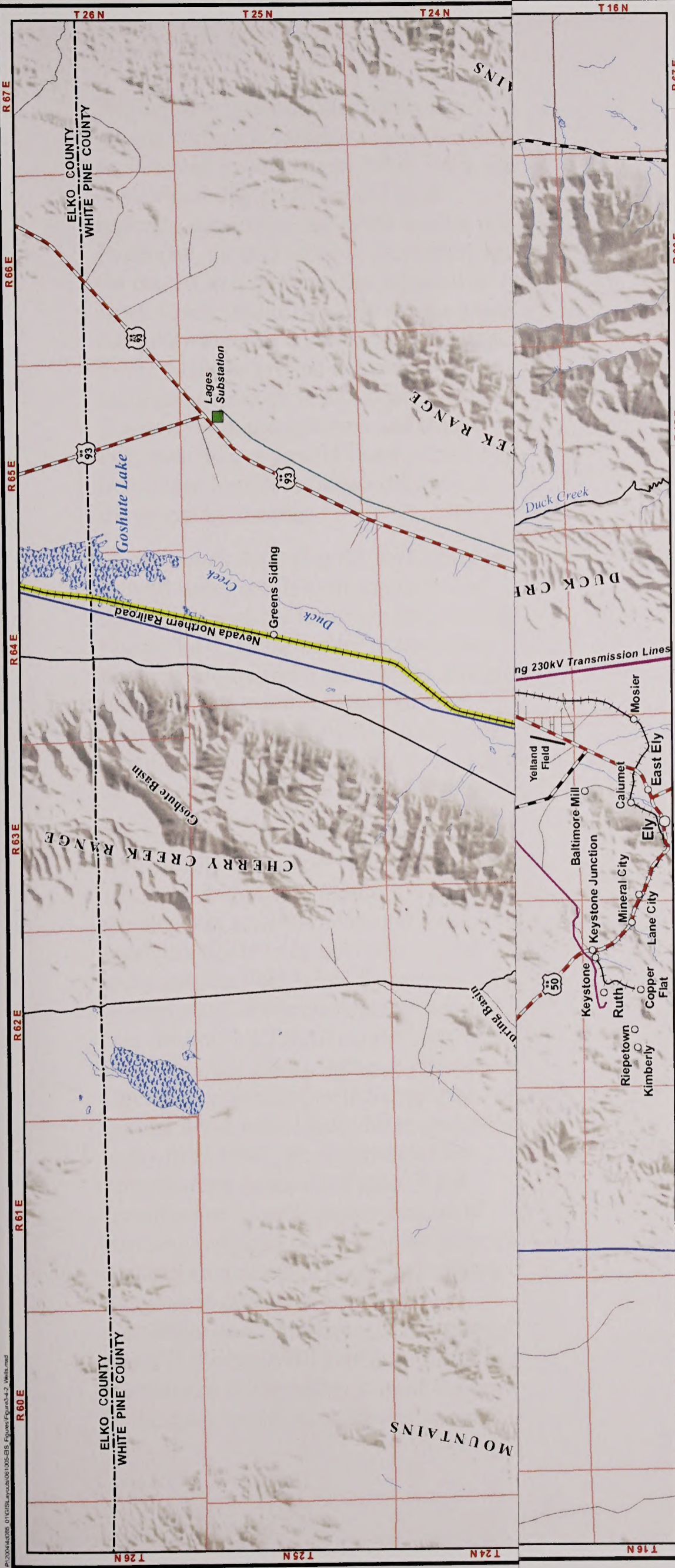

Location of Wells with Geologic Logs and Water Quality Data White Pine Energy Station Project

Existing Electrical Features

- Existing Substation
- Existing Transmission Line
- Existing Distribution Line

Surface Water

- Perennial Stream or River
- Wetland

Connected Action

- SWIP Transmission Line
- NNR Upgrade

Common Project Features

- Minerals Materials Sale Area
- Moriah Ranches Seeding Project

Proposed Action Project Features

- Well with Geologic Log
- Proposed Well Site
- Proposed Water Pipeline/Distribution Line
- Proposed Rail Spur
- Proposed Transmission Line
- Proposed Electric Distribution Line
- Proposed Access Road
- Proposed Substation Site
- Proposed Power Plant Site

Alternative 1 Project Features

- Proposed Well Site
- Proposed Water Pipeline/Distribution Line
- Proposed Rail Spur
- Proposed Transmission Line
- Proposed Electric Distribution Line
- Proposed Access Road
- Proposed Substation Site
- Proposed Power Plant Site



0 1.5 3 Miles

1:300,000 when printed at 11 x 17 inches

Figure 3.4-2

TABLE 3.4-2

General Geologic Description of Basin-Fill in Steptoe Valley

Well 1A ^a		Well 1B ^b		Well 1C ^c	
Depth Interval (feet below ground surface)	Geologic Description	Depth Interval (feet below ground surface)	Geologic Description	Depth Interval (feet below ground surface)	Geologic Description
0-110	Moderately to very silty sand and gravel	0-400	Silty to very silty sand and gravel layering. Clean sand and gravel layers at 160-170, and 230-245 feet below ground surface.	0-320	Silty sand and gravel. Clean sand and gravel layers at 115-120, 160-178, 208-215, and 225-245 feet below ground surface.
110-265	Zone of sand and gravel, interbedded with silt and minor amounts of clay. Fairly clean sand and gravel strata at 112-122, 160-195, 202-240, and 260-265 feet below ground surface	400-460	Clean coarse sand and gravel	320-455	Clean sand and gravel
265-360	Very silty sand				
360-675	Fairly clean gravel zone (includes cobble and boulder size rocks)				
675-995	Silty sand and gravel				

^a Located approximately 2 miles southwest of the intersection of Cherry Creek Road and U.S. 93

^b Located 924 feet west of Well 1A

^c Located 250 feet south of Well 1A

Source: Leeds, Hill, and Jewett, Inc., 1983

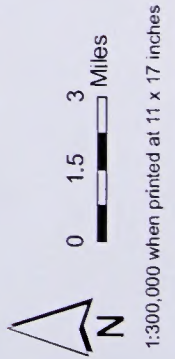
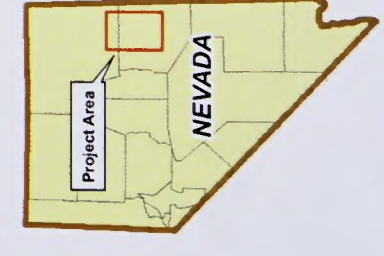
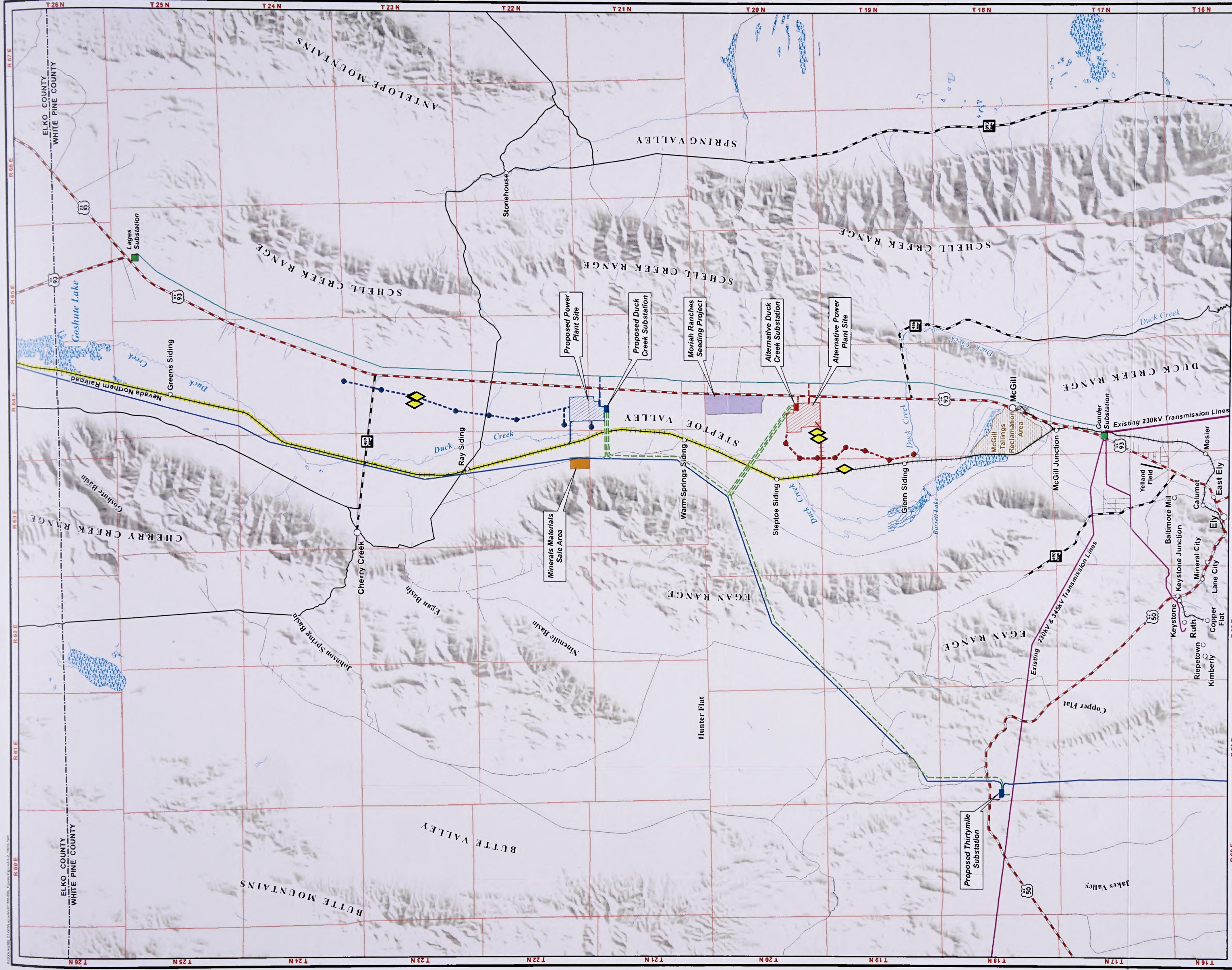

- Existing Electrical Features**
- Existing Substation
 - Existing Transmission Line
 - Existing Distribution Line
- Surface Water**
- Perennial Stream or River
 - Wetland
- Connected Action**
- SWIP Transmission Line
 - NNR Upgrade
- Common Project Features**
- Minerals Materials Sale Area
 - Moriah Ranches Seeding Project

- Proposed Action Project Features**
- Proposed Well Site
 - Proposed Water Pipeline/Distribution Line
 - Proposed Rail Spur
 - Proposed Transmission Line
 - Proposed Electric Distribution Line
 - Proposed Access Road
 - Proposed Substation Site
 - Proposed Power Plant Site
- Well with Geologic Log**
- Well with Geologic Log

- Alternative 1 Project Features**
- Proposed Well Site
 - Proposed Water Pipeline/Distribution Line
 - Proposed Rail Spur
 - Proposed Transmission Line
 - Proposed Electric Distribution Line
 - Proposed Access Road
 - Proposed Substation Site
 - Proposed Power Plant Site

Location of Wells with Geologic Logs and Water Quality Data
White Pine Energy Station Project

Figure 3.4-2

The depth to ground water below the ground surface is variable across the basin as indicated by the data in Table 3.4-3, with more variability on an annual basis typically seen in the shallower aquifer unit. In general, ground water is shallowest near the central axis of the valley adjacent to Duck Creek, and is typically deeper toward the valley margins adjacent to the mountain fronts. Shallow ground water tends to be more influenced by seasonal and annual fluctuations in precipitation and stream flow than deeper ground water, which tends to be more heavily influenced locally by the pumping of wells.

Hydrographs depicting the variability in ground water levels both annually and spatially across the basin are presented in Figure 3.4-3. In the center of the valley near the Alternative 1 site for the power plant, ground water levels from well N20 E64 32C2 typically fluctuate up or down between approximately 1 and 2 feet on an annual basis (see Figure 3.4-3).

The most recent published map of ground water levels in Steptoe Valley was drawn in 1985 and is shown in Figure 3.4-4 (Bedinger et al., 1984). Ground water levels are likely to be generally higher today than in 1985 primarily because less ground water is currently being pumped (see Section 3.4.2.8, *Ground Water Use and Perennial Yield*). Although the specific elevations associated with the contours of ground water level likely differ somewhat today from 1985, the depiction of the ground water surface in Figure 3.4-4 remains a reasonable representation of current conditions because of the scale that the data are presented in the map. Based on the general pattern of ground water elevations shown in Figure 3.4-4, ground water in the basin-fill generally flows from the margins of the valley toward the center of the basin and then northward toward

Goshute Lake, with some flow exiting the basin under the gap where Nelson Creek flows north into Goshute Valley.

3.4.2.4 Ground Water Recharge to Steptoe Valley

The only known source of water to the basin-fill aquifers in Steptoe Valley is precipitation that falls as either rain or snow within the boundaries of the basin. However, according to Nichols (2000), potentially as much as 2,000 acre-feet per year of ground water could flow into Steptoe Valley from Butte Valley, which is the basin west of Steptoe Valley (see Figure 3.3-1). This hypothesis is contrary to the conclusions in Eakin et al. (1967). Although considerable uncertainty surrounds the notion of ground water inflow from Butte Valley, the underlying regional fractured-rock aquifers most likely contribute to the discharge of some of the springs in Steptoe Valley (see discussion in Section 3.4.2.5). Nonetheless, the regional fractured-rock aquifers are considered to be independent of the overlying basin-fill aquifers in Steptoe Valley (Eakin et al., 1967; Frick, 1985).

The pathways that precipitation follows to reach ground water are both the infiltration of direct precipitation and the infiltration of stream flow. The remainder of the precipitation that does not reach ground water runs off as surface water, evaporates (either from standing water or from soil), or it is taken up by plant roots and is transpired to the atmosphere before it can reach the ground water.

TABLE 3.4-3

Depth to Ground Water in Selected Wells in Steptoe Valley

Well Locator	Well ID	Well Depth (feet below ground surface)	Minimum Depth to Ground Water (feet)/Date	Maximum Depth to Ground Water (feet)/Date	Range (feet)	Period of Record
N15 E64 07A	Unnamed irrigation well	200	30.25 /June 1984	41.83 /March 1961	11.58	1948-1984
N19 E63 12BDAC	Boudy and Forman well 30W-A	915	11.84 /June 1985	19.41 /August 1983	7.57	1945-1984
N16 E63 01B	Unnamed well	--	55.91 /April 1969	76.10 /July 1965	20.19	1949-1973
N20 E64 32C2	USGS Steptoe monitoring well	110	7.47 /April 1985	17.87 /December 1946	10.4	1918-1984
N16 E64 DCBD	USGS East Ely monitoring well	306	224.24 /July 1985	270 /July 1951	46	1965-1985
N21 E64 29BCDB	Boudy and Forman well 28W-a	--	35.38 /May 1985	43.88 /March 1983	8.50	1983-1985
N17 E63 36 AD	Boudy and Forman well 3W	--	60.95 /May 1985	86.40 /December 1982	25.45	1983-1985
N17 E63 22BACB	Boudy and Forman well 4W	102	81.29 /June 1985	98.65 /July 1983	17.36	1983-1985
N18 E63 25DCCC	Boudy and Forman well 6W	130	1.86 /March 1985	11.4 /November 1981	9.5	1945-1985
N25 E65 31BA	Boudy and Forman well 22W-A	235	104.8 /August 1985	120 /April 1978	15	1978-1985
N26 E65 34DDDD	Boudy and Forman well 21W	327	45.0 /June 1967	55.9 /November 1983	10.9	1967-1985
N21 E64 17DCBB	USGS Big Indian monitoring well	300	58.14 /May 1985	61.82 /April 1983	3.68	1972-1985
N26 E65 34DABA	Boudy and Forman well 21W-A	894	54.03 /March 1984	158.31 /August 1983	104.28	1981-1985
N19 E63 28CD	Boudy and Forman well 7W	122	6.03 /March 1983	29.74 /August 1983	23.71	1963-1985
N19 E63 20DB	Boudy and Forman well 9W-A	200	13.6 /November 1984	69.07 /July 1983	55.5	1977-1985
N19 E63 20DBD	Boudy and Forman well 9W-B	175	3.06 /April 1985	43.90 /July 1983	40.84	1981-1985

Source: Frick (1985)

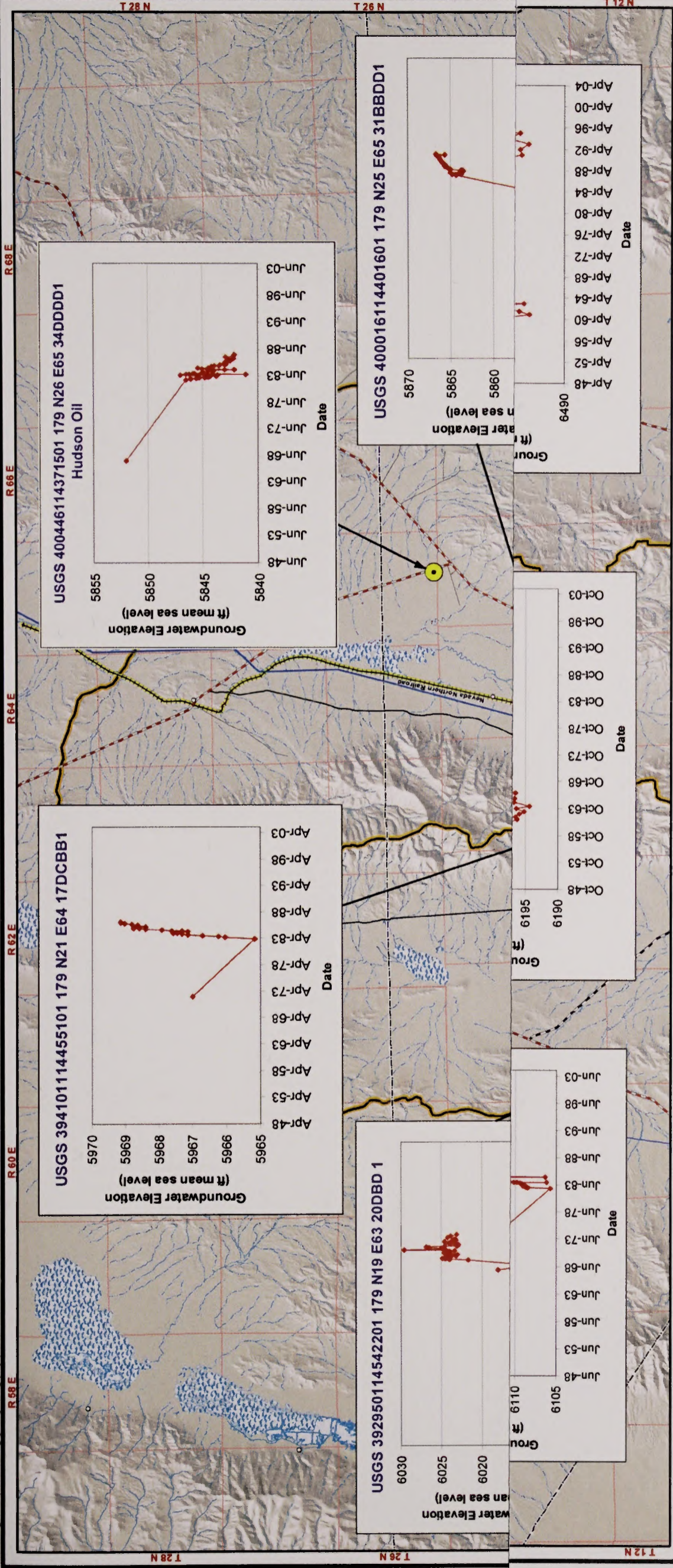

Hydrographs for Selected Wells in Steptoe Valley White Pine Energy Station Project

Surface Water

- Hydrobasin Boundary
- Perennial Stream or River
- Intermittent Stream or River
- Wetland

Connected Action

- SWIP Transmission Line
- NNR Upgrade

Common Project Features

- Minerals Materials Sale Area
- Moriah Ranches
- Seeding Project

Proposed Action Project Features

- Proposed Well Site
- Proposed Water Pipeline/Distribution Line
- Proposed Rail Spur
- Proposed Transmission Line
- Proposed Electric Distribution Line
- Proposed Access Road
- Proposed Substation Site
- Proposed Power Plant Site

0 3 6 Miles

1:500,000 when printed at 11 x 17 inches

Alternative 1 Project Features

- Proposed Well Site
- Proposed Water Pipeline/Distribution Line
- Proposed Rail Spur
- Proposed Transmission Line
- Proposed Electric Distribution Line
- Proposed Access Road
- Proposed Substation Site
- Proposed Power Plant Site

Figure 3.4-3

TABLE 3.4-3

Depth to Ground Water in Selected Wells in Steptoe Valley

Well Locator	Well ID	Well Depth (feet below ground surface)	Minimum Depth to Ground Water (feet)/Date	Maximum Depth to Ground Water (feet)/Date	Range (feet)	Period of Record
N15 E64 07A	Unnamed irrigation well	200	30.25 /June 1984	41.83 /March 1961	11.58	1948-1984
N19 E63 12BDAC	Boundy and Forman well 30W-A	915	11.84 /June 1985	19.41 /August 1983	7.57	1945-1984
N16 E63 01B	Unnamed well	--	55.91 /April 1969	76.10 /July 1965	20.19	1949-1973
N20 E64 32C2	USGS Steptoe monitoring well	110	7.47 /April 1985	17.87 /December 1946	10.4	1918-1984
N16 E64 DCBD	USGS East Ely monitoring well	306	224.24 /July 1985	270 /July 1951	46	1965-1985
N21 E64 29BCDB	Boundy and Forman well 28W-a	--	35.38 /May 1985	43.88 /March 1983	8.50	1983-1985
N17 E63 36 AD	Boundy and Forman well 3W	--	60.95 /May 1985	86.40 /December 1982	25.45	1983-1985
N17 E63 22BACB	Boundy and Forman well 4W	102	81.29 /June 1985	98.65 /July 1983	17.36	1983-1985
N18 E63 25DCCC	Boundy and Forman well 6W	130	1.86 /March 1985	11.4 /November 1981	9.5	1945-1985
N25 E65 31BA	Boundy and Forman well 22W-A	235	104.8 /August 1985	120 /April 1978	15	1978-1985
N26 E65 34DDDD	Boundy and Forman well 21W	327	45.0 /June 1967	55.9 /November 1983	10.9	1967-1985
N21 E64 17DCBB	USGS Big Indian monitoring well	300	58.14 /May 1985	61.82 /April 1983	3.68	1972-1985
N26 E65 34DABA	Boundy and Forman well 21W-A	894	54.03 /March 1984	158.31 /August 1983	104.28	1981-1985
N19 E63 28CD	Boundy and Forman well 7W	122	6.03 /March 1983	29.74 /August 1983	23.71	1963-1985
N19 E63 20DB	Boundy and Forman well 9W-A	200	13.6 /November 1984	69.07 /July 1983	55.5	1977-1985
N19 E63 20DBD	Boundy and Forman well 9W-B	175	3.06 /April 1985	43.90 /July 1983	40.84	1981-1985

Source: Frick (1985)

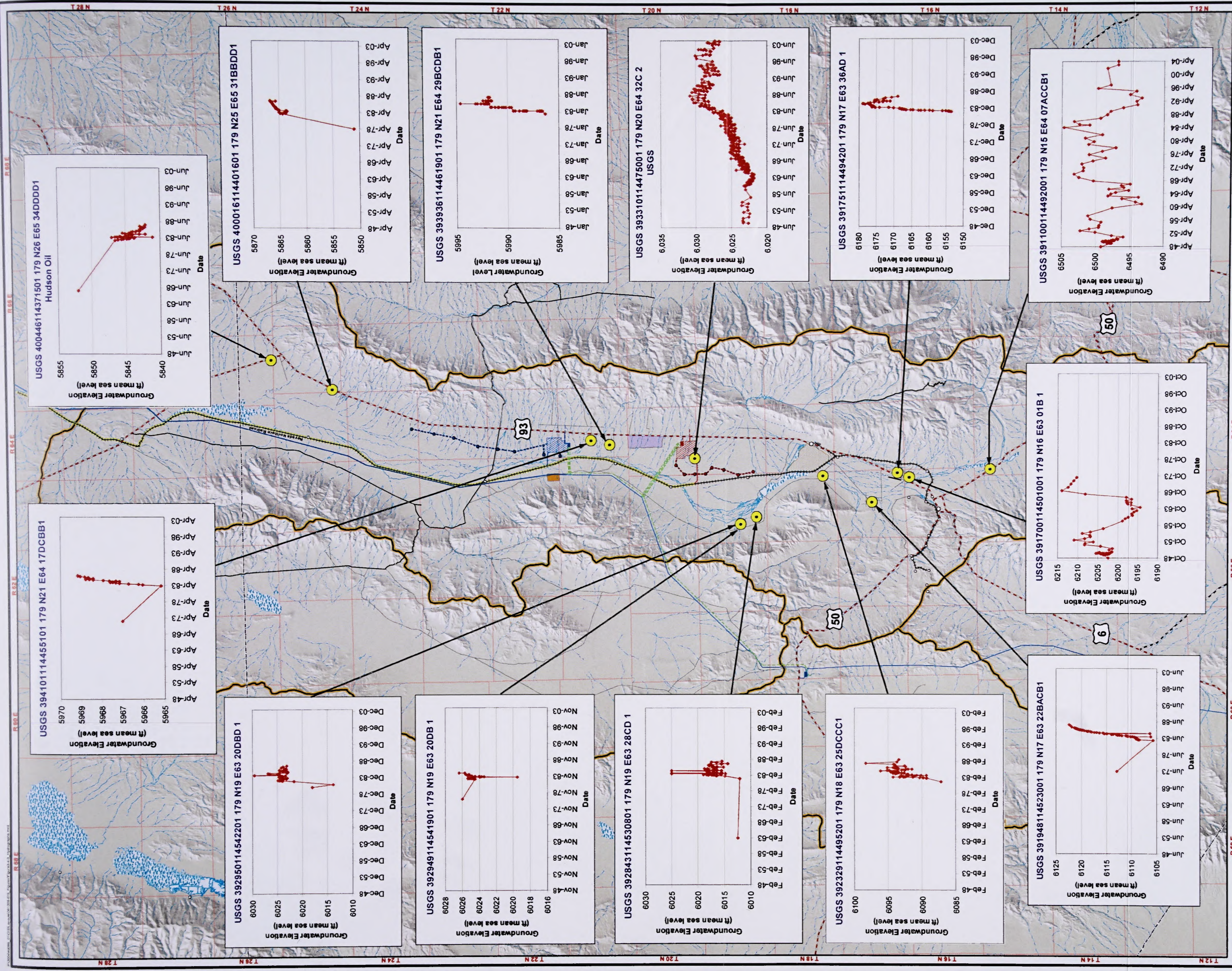

Hydrographs for Selected Wells in Steptoe Valley White Pine Energy Station Project

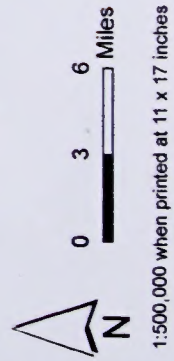
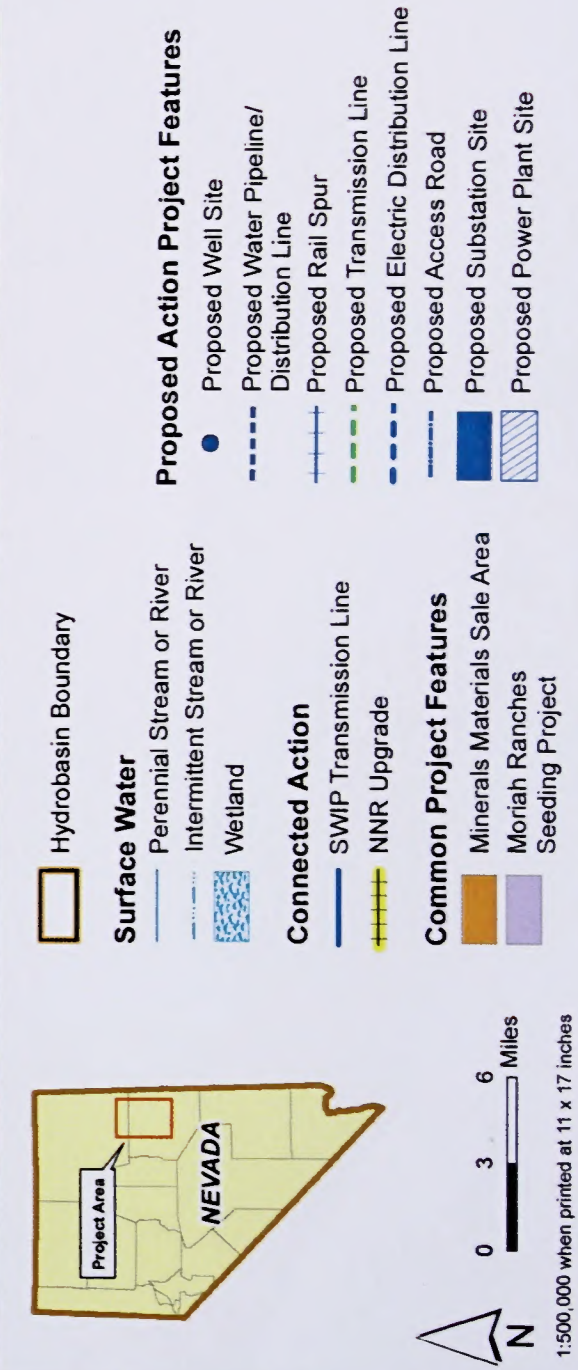
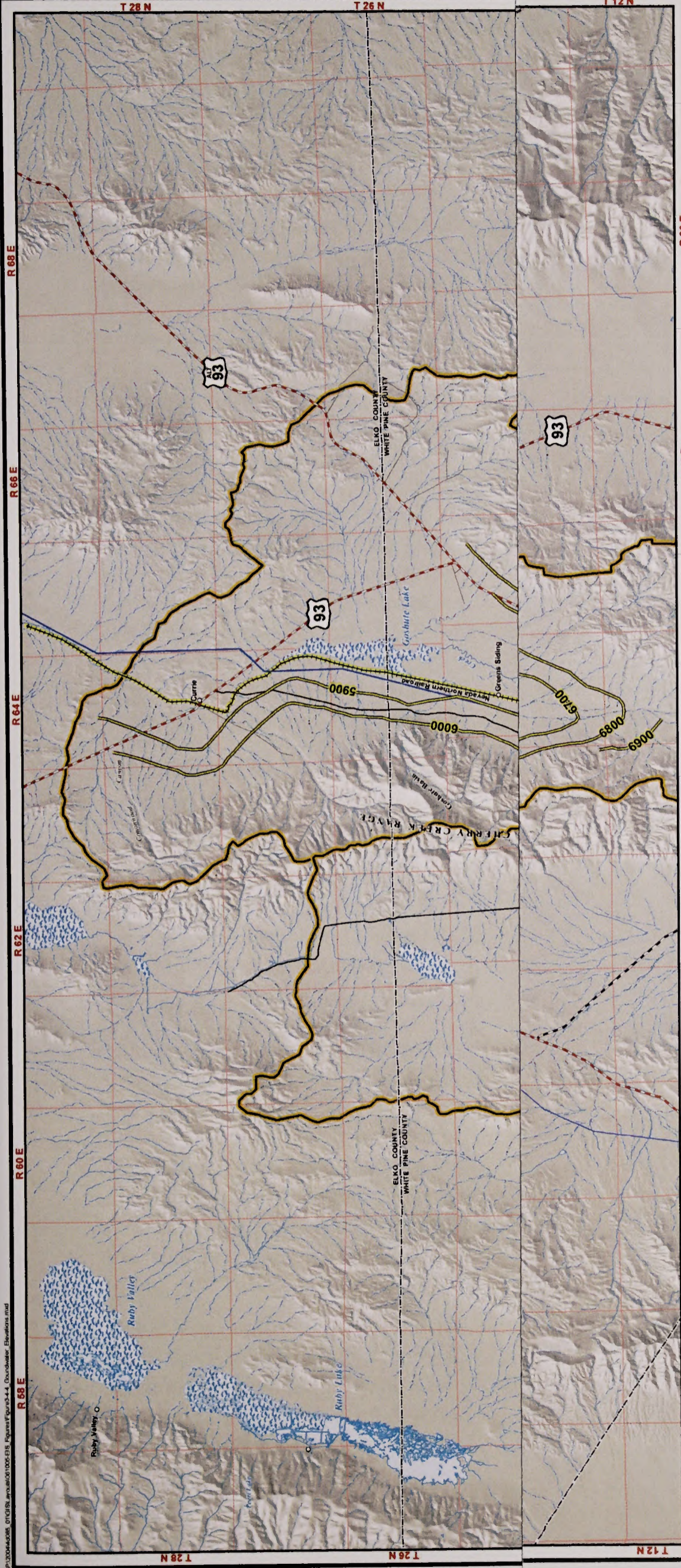
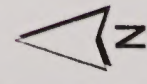
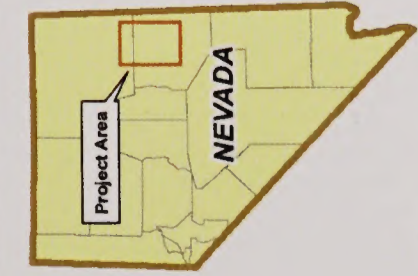

Figure 3.4-3



Groundwater Elevations in Steptoe Valley, 1985 White Pine Energy Station Project



0 3 6 Miles

1:500,000 when printed at 11 x 17 inches

- Groundwater Contour Line Interval = 100ft
- Hydrobasin Boundary
- Surface Water**
 - Perennial Stream or River
 - Intermittent Stream or River
 - Wetland
- Connected Action**
 - SWP Transmission Line
 - NNR Upgrade
- Common Project Features**
 - Minerals Materials Sale Area
 - Moriah Ranches
 - Seeding Project

Proposed Action Project Features

- Proposed Well Site
- Proposed Water Pipeline/ Distribution Line
- Proposed Rail Spur
- Proposed Transmission Line
- Proposed Electric Distribution Line
- Proposed Access Road
- Proposed Substation Site
- Proposed Power Plant Site

Alternative 1 Project Features

- Proposed Well Site
- Proposed Water Pipeline/ Distribution Line
- Proposed Rail Spur
- Proposed Transmission Line
- Proposed Electric Distribution Line
- Proposed Access Road
- Proposed Substation Site
- Proposed Power Plant Site

Figure 3.4-4

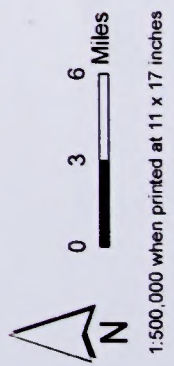
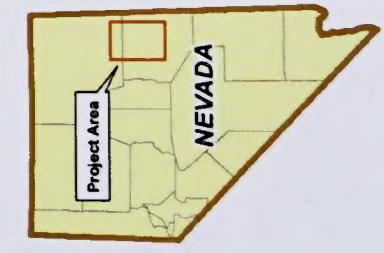

- Groundwater Contour Line
Interval = 100ft
- Hydrobasin Boundary
- Surface Water**
- Perennial Stream or River
- Intermittent Stream or River
- Wetland
- Connected Action**
- SWIP Transmission Line
- NNR Upgrade
- Common Project Features**
- Minerals Materials Sale Area
- Moriah Ranches
- Seeding Project

- Proposed Well Site
- Proposed Water Pipeline/
Distribution Line
- Proposed Rail Spur
- Proposed Transmission Line
- Proposed Electric Distribution Line
- Proposed Access Road
- Proposed Substation Site
- Proposed Power Plant Site

- Alternative 1 Project Features
- Proposed Water Pipeline/
Distribution Line
- Proposed Rail Spur
- Proposed Transmission Line
- Proposed Electric Distribution Line
- Proposed Access Road
- Proposed Substation Site
- Proposed Power Plant Site

Groundwater Elevations in Steptoe Valley, 1985
White Pine Energy Station Project

Figure 3.4-4

Annual precipitation at specific locations within Steptoe Valley is discussed in Section 3.3, *Surface Water Resources*). Collectively, the estimates of the total amount of precipitation that falls across the entire Steptoe Valley watershed vary from approximately 810,000 acre-feet per year (Lopes and Evetts, 2004), to as much as 1,344,191 acre-feet per year (Nichols, 2000). Corresponding estimates of the total annual ground water recharge to the basin-fill aquifers in Steptoe Valley range from 83,600 acre-feet per year (Frick, 1985) and 85,000 acre-feet per year (Eakin et al., 1967; Lopes and Evetts, 2004) up to 132,000 acre-feet per year (Nichols, 2000). It should be noted that Frick (1985) also estimated that the leakage of water from streams contributed an additional 15,300 acre-feet per year for a total average annual rate of inflow to the ground water within Steptoe Valley of 98,900 acre-feet per year.

3.4.2.5 Ground Water Discharge from Steptoe Valley

Ground water leaves (discharges from) the basin-fill aquifers of Steptoe Valley through springs, evapotranspiration, ground water flow into Goshute Valley, and pumping from water wells.

3.4.2.5.1 Springs

Numerous springs discharge ground water within the Steptoe Valley Hydrographic Area (see Figure 3.4-5). The amount of water that discharges from these springs varies from small seeps that are too small to be accurately measured (essentially little more than perennially damp soil), to flows of over 5,000 gallons per minute (gpm) (see Table 3.4-4).

While some springs may contribute minor flows to various ephemeral creeks in the surrounding mountains, almost all spring discharge that has not been diverted to storage (reservoirs for livestock) is

consumed by evapotranspiration. Only a very small and insignificant percentage of spring discharge is believed to infiltrate back into the subsurface and actually reach ground water again (Eakin et al., 1967).

The springs in the surrounding mountains represent discharge points for precipitation (rain and/or snow) that has infiltrated through the rocks at the higher elevations of the mountains within the Steptoe Valley Hydrographic Area. Ground water that discharges from springs located in the mountains or along the mountain front, therefore, is not hydrologically connected to ground water in the basin-fill aquifers downgradient ("downstream") of these springs. However, those springs that discharge within the basin fill are generally hydraulically connected to, and, therefore, provide information about, the basin-fill aquifers.

The springs that discharge within the basin-fill of Steptoe Valley generally occur as a result of one of the following three mechanisms:

- **Geologic Faults.** Spring locations are controlled by geologic faults either where these faults act as barriers to ground water flow or where they cause a natural break in the topography that exposes the water table.
- **Leading Edge (Toe) of Alluvial Fans.** Alluvial fans are deposits of relatively coarse sediments that form fan-like structures where stream channels from the mountains meet the valley floor. At the fan toe, the contact between the coarser-grained fan material and the finer-grained basin-fill deposits of the valley floor causes ground water flowing through the fan to rise to the surface at the contact. In addition, the break in slope at the toe of alluvial fans also enables ground water to intercept the ground surface.

TABLE 3.4-4

Discharge Information on Selected Springs in Steptoe Valley

Name	Latitude	Longitude	Township/Range	Elevation (feet amsl)*	Discharge (gpm)	Data Source
Currie Spring	40.1548	114.4509	N28 E64 33A	--	Ave = 2,334 (5.2 cfs) Max = 5,386 (12 cfs) Min = 1,032 (2.3 cfs)	Savard and Crompton (1993) data from June 1982 - Sept 1985
Murray Springs	39.1400	114.5345	N16 E63 21	--	Ave = 3,366 (7.5 cfs) Ave = 3,882 (8.7 cfs)	Frick (1985) 1970-1982 Savard and Crompton (1993) data from 1985-1988
McGill Springs	39.2502	114.4649	N18 E64 21BDDC1	--	Ave = 4,793 (10.68 cfs) Ave = 5,251 (11.7 cfs)	Frick (1985) data from 10/65-11/85 Savard and Crompton (1993) data from 2/86-2-88
Cambells Embayment Spring	--	--	N19 E63 05CDC1	6100	Max = 4,800 (10.7 cfs) Min = 390 (0.9 cfs) Ave = 4,355 (9.7 cfs)	Pupacko et al. (1989) Savard and Crompton (1993) 5 records from 1/82-2/22
Willow Creek			N14 E63 35A1	7500	685-620	Pupacko et al. (1989) 2 records 1965-1966

gpm—gallons per minute
cfs—cubic feet per second

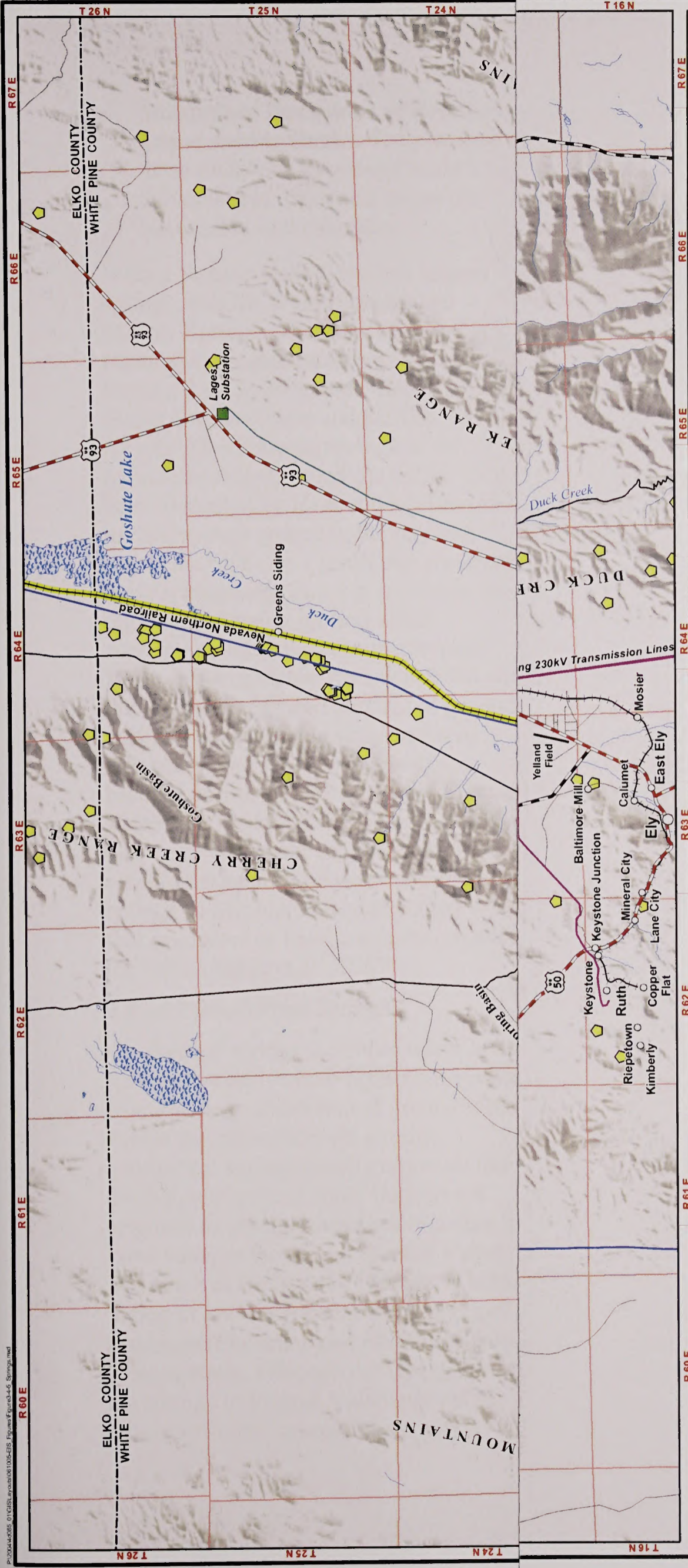

Location of Springs in Steptoe Valley White Pine Energy Station Project

Existing Electrical Features

- Existing Substation
- Existing Transmission Line
- Existing Distribution Line

Surface Water

- Spring (Source: BLM, EDAAW)
- Perennial Stream or River
- Wetland

Connected Action

- SWIP Transmission Line
- NNR Upgrade

Common Project Features

- Minerals Materials Sale Area
- Moriah Ranches Seeding Project

Proposed Action Project Features

- Proposed Well Site
- Proposed Water Pipeline/Distribution Line
- Proposed Rail Spur
- Proposed Transmission Line
- Proposed Electric Distribution Line
- Proposed Access Road
- Proposed Substation Site
- Proposed Power Plant Site

Alternative 1 Project Features

- Proposed Well Site
- Proposed Water Pipeline/Distribution Line
- Proposed Rail Spur
- Proposed Transmission Line
- Proposed Electric Distribution Line
- Proposed Access Road
- Proposed Substation Site
- Proposed Power Plant Site

NEVADA

0 1.5 3 Miles

1:300,000 when printed at 11 x 17 inches

Figure 3.4-5

TABLE 3.4-4

Discharge Information on Selected Springs in Steptoe Valley

Name	Latitude	Longitude	Township/Range	Elevation (feet amsl)*	Discharge (gpm)	Data Source
Currie Spring	40.1548	114.4509	N28 E64 33A	--	Ave = 2,334 (5.2 cfs) Max = 5,386 (12 cfs) Min = 1,032 (2.3 cfs)	Savard and Crompton (1993) data from June 1982 - Sept 1985
Murray Springs	39.1400	114.5345	N16 E63 21	--	Ave = 3,366 (7.5 cfs) Ave = 3,882 (8.7 cfs)	Frick (1985) 1970-1982 Savard and Crompton (1993) data from 1985-1988
McGill Springs	39.2502	114.4649	N18 E64 21BDDC1	--	Ave = 4,793 (10.68 cfs) Ave = 5,251 (11.7 cfs)	Frick (1985) data from 10/65-11/85 Savard and Crompton (1993) data from 2/86-2-88
Cambells Embayment Spring	--	--	N19 E63 05CDC1	6100	Max = 4,800 (10.7 cfs) Min = 390 (0.9 cfs) Ave = 4,355 (9.7 cfs)	Pupacko et al. (1989) Savard and Crompton (1993) 5 records from 1/82-2/22
Willow Creek			N14 E63 35A1	7500	685-620	Pupacko et al. (1989) 2 records 1965-1966

gpm—gallons per minute
cfs—cubic feet per second

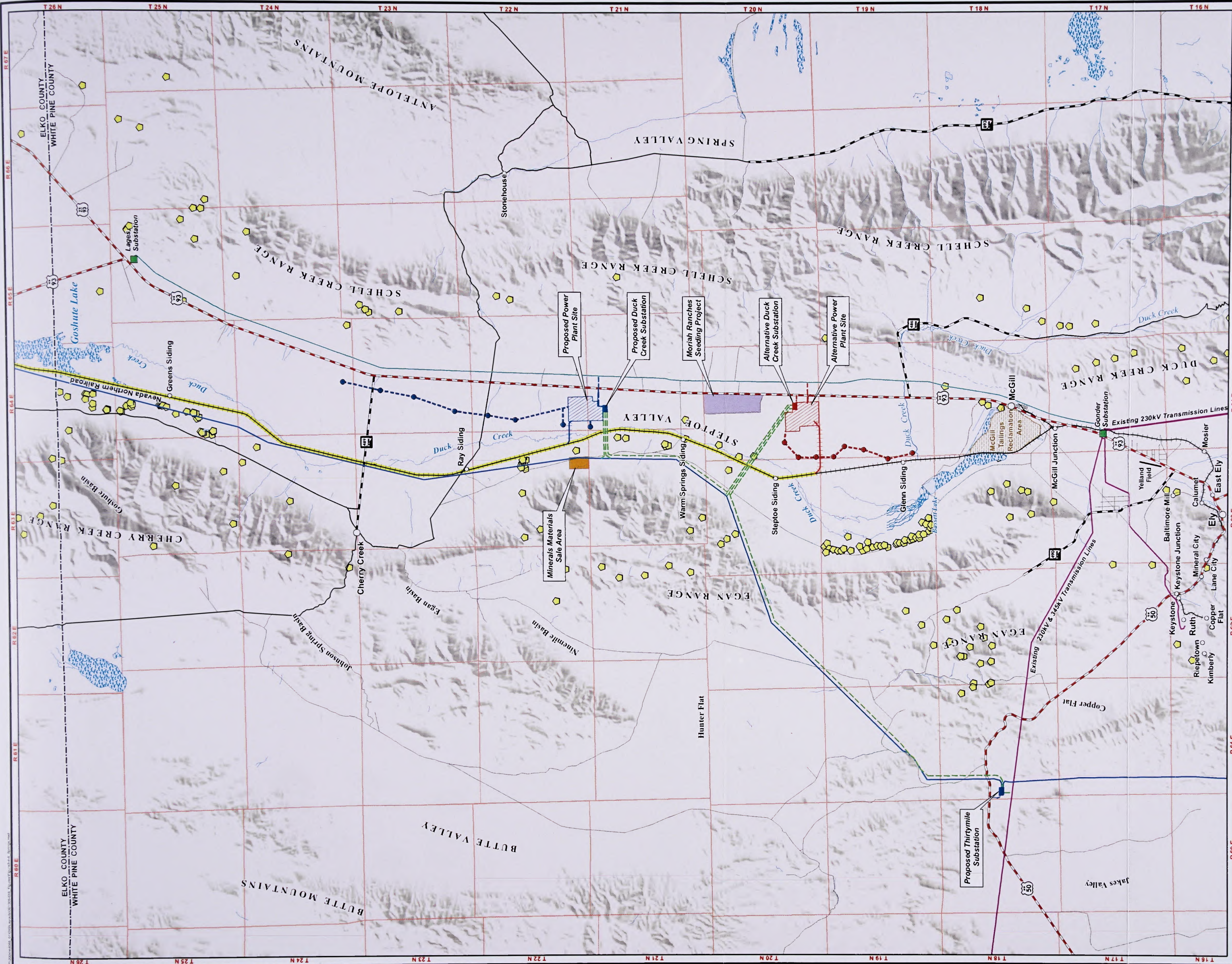

**Location of Springs in Steptoe Valley
White Pine Energy Station Project**

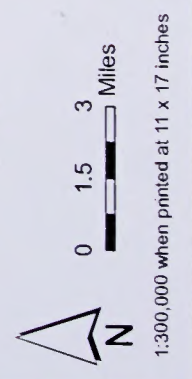
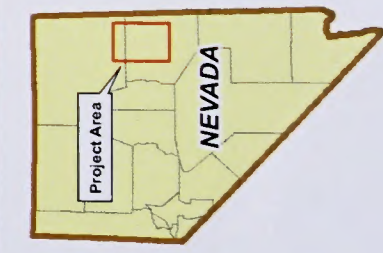

Existing Electrical Features

- Existing Substation
- Existing Transmission Line
- Existing Distribution Line

Surface Water

- Spring (Source: BLM, EDAAW)
- Perennial Stream or River
- Wetland

Connected Action

- SWIP Transmission Line
- NNR Upgrade

Common Project Features

- Minerals Materials Sale Area
- Moriah Ranches
- Seeding Project

Proposed Action Project Features

- Proposed Well Site
- Proposed Water Pipeline/
Distribution Line
- Proposed Rail Spur
- Proposed Transmission Line
- Proposed Electric Distribution Line
- Proposed Access Road
- Proposed Substation Site
- Proposed Power Plant Site

Alternative 1 Project Features

- Proposed Well Site
- Proposed Water Pipeline/
Distribution Line
- Proposed Rail Spur
- Proposed Transmission Line
- Proposed Electric Distribution Line
- Proposed Access Road
- Proposed Substation Site
- Proposed Power Plant Site

Figure 3.4-5

- **Subsurface Intrusions of Relatively Impermeable Rocks.** The presence of these rocks blocks ground water movement at depth and forces the water table to the surface.

Within Steptoe Valley, the two largest springs, McGill Warm Springs and Murray Springs, discharge from the regional carbonate rock units discussed in Section 3.4.1.2, *Fractured-Rock Ground Water Systems* (Hess and Mifflin, 1978). At least 28 additional springs in the mountains that surround the valley have been identified by Hess and Mifflin (1978) as having their source in the regional carbonate rock. As a result, the presence of these springs suggests that relatively deep regionally flowing ground water contributes some water to the Steptoe Valley Hydrographic Area consistent with the widely recognized concept of ground water flow between basins in eastern Nevada. However, only a few of the literally dozens of springs within Steptoe Valley are thought to have the potential to discharge water that originates from outside the basin. The vast majority of the springs in Steptoe Valley discharge water that originates as local precipitation within the basin (Eakin et al., 1967).

3.4.2.5.2 Geothermal Springs

Geothermal springs are either warm or hot springs that derive their higher temperatures from the deep circulation of ground water within the subsurface. As a result, geothermal springs usually represent the discharge of ground water that did not originate as precipitation locally within the same basin as the spring. Steptoe Valley, like much of the State of Nevada, is within a region of known or potential geothermal resources (Shevenell and Garside, 2004). Consequently, although the vast majority of the springs in Steptoe Valley discharge relatively “cool” ground water with a

temperature typically between approximately 52 and 64°F, the water temperature of a few of the springs is above 73°F, which puts them in the category of “warm” springs. Additionally, Monte Neva, Cherry Creek, and Lackawanna Springs are considered to be hot springs because their average temperature is above 85°F.

The various warm and hot springs in Steptoe Valley are listed in Table 3.4-5 and their locations are shown in Figure 3.4-5. The total discharge from these geothermal springs is approximately 10,700 acre-feet per year (or approximately 14.8 cfs).

With the exception of Collar and Elbow Spring, all warm springs in Steptoe Valley are within approximately 2 miles of known geologic fronts. These springs indicate zones of hydrothermal circulation that are probably formed and maintained by range-front faulting (Eaton, 1982). Collar and Elbow Spring, located southeast of Goshute Lake, is anomalous among the warm springs because it is near the center of a wide part of the valley.

3.4.2.5.3 Evapotranspiration

Evapotranspiration, which is the combined process of evaporation and the transpiration of water through plant tissue, occurs throughout Steptoe Valley. Most of the evapotranspiration, however, is limited to the valley floor adjacent to Comins, Bassett, and Goshute Lakes, and Steptoe and Duck Creeks (see Section 3.3, *Surface Water Resources*, and Figure 3.3-1).

TABLE 3.4-5

Information on Selected Geothermal Springs in Steptoe Valley

Name	Latitude	Longitude	Township/Range	Elevation (feet amsl)	Discharge (gpm)	Temperature (°F)	Data Source/Comments
Monte Neva Hot Springs ^a	39.665	114.807	N21 E63 25BA1	6030	630	176	1 record of discharge pre-1968 Pupacko et al., 1989)
Cherry Creek Hot Springs	39.883	114.893	N23 E63	—	60	124 to 188	Clark and Riddell (1920)
Collar and Elbow Spring	40.087	114.647	N26 E65	—	257	95	Clark and Riddell (1920)
Schellbourne Warm Springs (lower and upper) ^a	39.8	114.653	N22 E64 12 N22 E65 08BD1	7000	100 to 450 > 528	74	Variable discharges associated with different springs. Measured in 1966; Mifflin (1968)
McGill Warm Spring ^b	—	—	N18 E6503AD1	6640	4,578 4,490	84 76	1 record of discharge 1965 (Pupacko et al., 1989) 1 measurement in 1918; Hardman and Miller (1934)
Schoolhouse	39.453875	114.756462	N18 E64 03DB1	6280	450	84	1 record of discharge 1966 (Pupacko et al., 1989)
Lackawanna ^a	39.283	114.866	N16 E63 03A1	6300	135	95 70 to 95	1 record of discharge 1965 (Pupacko et al., 1989)

^aMultiple individual springs associated with this spring name.^bDifferent spring from the "McGill Spring" listed in Table 3.4-4, above.

Estimates of the total amount of evapotranspiration from the Steptoe Valley Hydrographic Area vary. According to Eakin et al. (1967) roughly 70,000 acre-feet per year of ground water is lost through evapotranspiration from approximately 143,000 acres of surface area and vegetation. Other investigators report higher estimates. Specifically, using a computer model to simulate the ground water flow in the Steptoe Valley basin-fill aquifers, Frick (1985) estimated that the amount of evapotranspiration was approximately 76,200 acre-feet per year. More recent work by Nichols (2000) concluded that the average annual rate of evapotranspiration is 128,000 acre-feet per year, and presented specific estimates for 1985 and 1989 of 118,000 acre-feet per year and 137,00 acre-feet per year, respectively.

3.4.2.5.4 Ground Water Flow to Goshute Valley

Inasmuch as the basin-fill aquifers of Steptoe Valley and Goshute Valley are widely understood to merge, some amount of ground water flows from Steptoe Valley to Goshute Valley, which is located hydraulically downgradient ("downhill"). The area through which ground water flows, however, is relatively small because of the presence of impermeable rocks. The amount of ground water flowing out of Steptoe Valley is estimated to be approximately 4,000 acre-feet per year (Nichols, 2000; Lopes and Evetts, 2004). Other investigators report somewhat lower

estimates. Specifically, Eakin et al. (1967) report 1,000 acre-feet per year, and the computer model developed by Frick (1985) estimated 2,510 acre-feet per year of ground water flows from Steptoe Valley into Goshute Valley.

3.4.2.5.5 Ground Water Pumping

Numerous wells tap the ground water in the Steptoe Valley basin-fill aquifers for agricultural, municipal, industrial, and private domestic use. As most water wells are less than 1,000 feet deep, no local wells are known to tap ground water in the fractured rock either underlying the basin fill or in the adjacent mountains.

A summary of the historical amounts of ground water withdrawals from wells in Steptoe Valley is presented in Table 3.4-6.

3.4.2.6 Summary of Ground Water Budget for Steptoe Valley

Under natural conditions, over time, the amount of ground water inflow or recharge to the Steptoe Valley basin-fill aquifers will be balanced by the amount of ground water discharge. The inflow components of the ground water budget for Steptoe Valley consist of recharge and the infiltration from stream flows. The outflow components consist of spring discharge, evapotranspiration, ground water outflow to Goshute Valley, and pumping. The corresponding estimates of these ground water budget components are summarized in Table 3.4-7.

TABLE 3.4-6
Ground Water Pumping History in Steptoe Valley

Year	Estimated Pumping (acre-feet per year)	Data Source
1918	Minimal	Clark and Riddell (1920)
1960	1,000	Loeltz and Malmberg (1961)
1965	3,000	Eakin et al., 1967
1975	7,000	Bedinger et al., 1984
1981	32,000	Leeds, Hill, and Jewett, Inc. (1981 and 1983)
1981	17,388 ^a	Nevada Department of Water Resources
1982	18,734 ^a	Nevada Department of Water Resources
1983	17,606	Nevada Department of Water Resources
1984	15,490	Nevada Department of Water Resources
1985	20,289	Frick (1985)
	17,468 ^a	Nevada Department of Water Resources
2000	6,360 ^b	Lopes and Evetts (2004)

^aEstimate of pumping for irrigation only developed based on crop and water surveys by the Nevada Department of Water Resources. Ground water pumping for other uses (for example, municipal, industrial, domestic) would add to this total.

^bOf this total, approximately 3,560 acre-feet per year is for irrigation and stock watering, and 2,800 acre-feet per year is for municipal use.

TABLE 3.4-7
Summary of Ground Water Budget for Steptoe Valley

Budget Component	Amount (acre-feet per year)
Inflow	
Recharge from Precipitation	83,600 (Frick, 1985) 85,000 (Eakin et al., 1967) 85,000 (Nevada Department of Conservation and Natural Resources, 1971) 85,000 (Nichols, 2000) 85,000 to 132,000 (Lopes and Evetts, 2004)
Infiltration of Stream Flow	15,300 (Frick, 1985)
Total Ground Water Inflow	85,000 (minimum) 132,000 (maximum)
Outflow	
Spring Discharge	Included in estimates of evapotranspiration
Evapotranspiration	70,000 (Eakin et al., 1967) 70,000 (Nevada Department of Conservation and Natural Resources, 1971) 76,200 (Frick, 1985) 128,000 (Nichols, 2000)
Ground Water Flow to Goshute Valley	1,000 (Eakin et al., 1967) 2,510 (Frick, 1985) 4,000 (Nichols, 2000; Lopes and Evetts, 2004)
Pumping (2000)	6,360 (Lopes and Evetts, 2004)
Total Ground Water Outflow	86,360 (minimum) 138,360 (maximum)

3.4.2.7 Ground Water Quality

In the Basin and Range Province, ground water is typically fresh and of very good quality along the margins of the basins where much of the ground water recharge occurs. As ground water flows from these recharge areas toward the center of the basins, and passes through sediments containing soluble salts, ground water quality typically degrades. At the center of the basins where the water table is relatively close to the ground surface (within approximately 10 feet), particularly in areas with dry lakes or playas, evaporation rates are high and salts become concentrated in

the soil and shallow ground water. These general processes occur in Steptoe Valley.

Based on water samples from selected wells and springs in Steptoe Valley, shown in Figure 3.4-2, the water quality of the basin-fill aquifers is generally good, even in the central portions of the valley (see Table 3.4-8). This is likely the result of recharge occurring across the basin, particularly through the infiltration of water from water courses such as Duck Creek (see Section 3.3, *Surface Water Resources*). Available water chemistry data also indicate that the general character of the ground water is consistently calcium bicarbonate, which indicates the ground water tends to be "hard."

TABLE 3.4-8
Water Quality Data From Selected Wells and Springs in Steptoe Valley

	Wells			Springs			
	USGS Steptoe MX Well			Murray Spring	McGill Spring		
Location	N12 E63 12AB1	N20 E64 6A1	N23 E63 2B1	Lat: 39.1345 Long: 114.5355	Lat: 39.2431 Long: 114.3828	N19 E63 5C1	N20 E65 20C1
Date	16 June 03	31 July 65	29 July 65	14 June 83	24 August 78	16 May 66	17 October 65
Temperature (°Celsius)	12.2	13.9	—	12.5	18	—	6
pH	7.5	7.8	8.1	7.7	7.3	7.8	7.9
Specific Conductance (µS/cm)	432	590	452	360	650	432	207
Dissolved Oxygen	5.9	—	—	—	—	—	—
Bicarbonate	248	281	212	—	—	214	89
Nitrate (as N)	<0.008	—	—	—	—	—	—
Organic Carbon	1.0	—	—	—	—	—	—
Calcium	67.5	61	42	46	73	53	31
Magnesium	13.4	31	26	18	27	20	2.8
Sodium	8.22	29*	21*	3.6	18	11	17*
Potassium	2.0	—	—	0.7	4.1	3.7	—
Chloride	5.81	13	14	2.6	17	3.4	4.4
Sulfate	19.9	50	28	11	140	19	29
Fluoride	0.2	—	—	0.1	0.2	—	—
Silica	19.1	—	—	8.9	19	—	—
Iron	58	—	—	—	—	—	—

All units in milligrams per liter (mg/L)

* Includes potassium

3.4.2.8 Ground Water Use and Perennial Yield

Ground water is currently pumped from the basin-fill aquifers in Steptoe Valley for municipal, private domestic, and agricultural use. As presented above in Table 3.4-6, the USGS has estimated that the total amount of ground water pumped from the Steptoe Valley Hydrographic Area in 2000 was 6,360 acre-feet per year. This is the most recent date for which a published estimate is available. Of this total of 6,360 acre-feet per year, approximately 3,560 acre-feet per year went to irrigation and stock watering uses, and 2,800 acre-feet per year went for municipal use. Estimates of historical use exceed 20,000 acre-feet per year (Frick, 1985).

The perennial yield of a ground water basin is defined as the maximum amount of ground water that can be pumped each year for an indefinite period of time without depleting the ground water in storage or causing deterioration of water quality beyond the limits of economic recovery. The perennial yield of the Steptoe Valley Hydrographic Basin has been established by the Nevada Department of Conservation and Natural Resources to be 70,000 acre-feet per year (Nevada Department of Conservation and Natural Resources, 1971).

According to the Office of the Nevada State Engineer, the ground water in the basin-fill deposits of Steptoe Valley is fully allocated by the Nevada Division of Water Resources. According to a BLM, internal planning document, the amount of committed resources is 78,531 acre-feet per year, which exceeds the currently established perennial yield by 8,531 acre-feet per year. As a result, the Nevada Department of Water Resources has

designated the Steptoe Valley Hydrographic Area as being a basin where permitted ground water rights exceed the estimated perennial yield and the water resources require additional administration.

The rights to the 5,000 acre-feet per year of ground water that would be pumped for the proposed Station (see Chapter 2.0, *Description of Proposed Action and Alternatives*) were granted in 1983 when the total amount of water appropriated in Steptoe Valley was less than 48,000 acre-feet per year (Nevada Department of Conservation and Natural Resources, 1983). Therefore, the water rights that would be used for the proposed Station were appropriated before the basin became overcommitted.

The locations of all applications and existing permits for ground water in Steptoe Valley are shown in Figure 3.4-6.

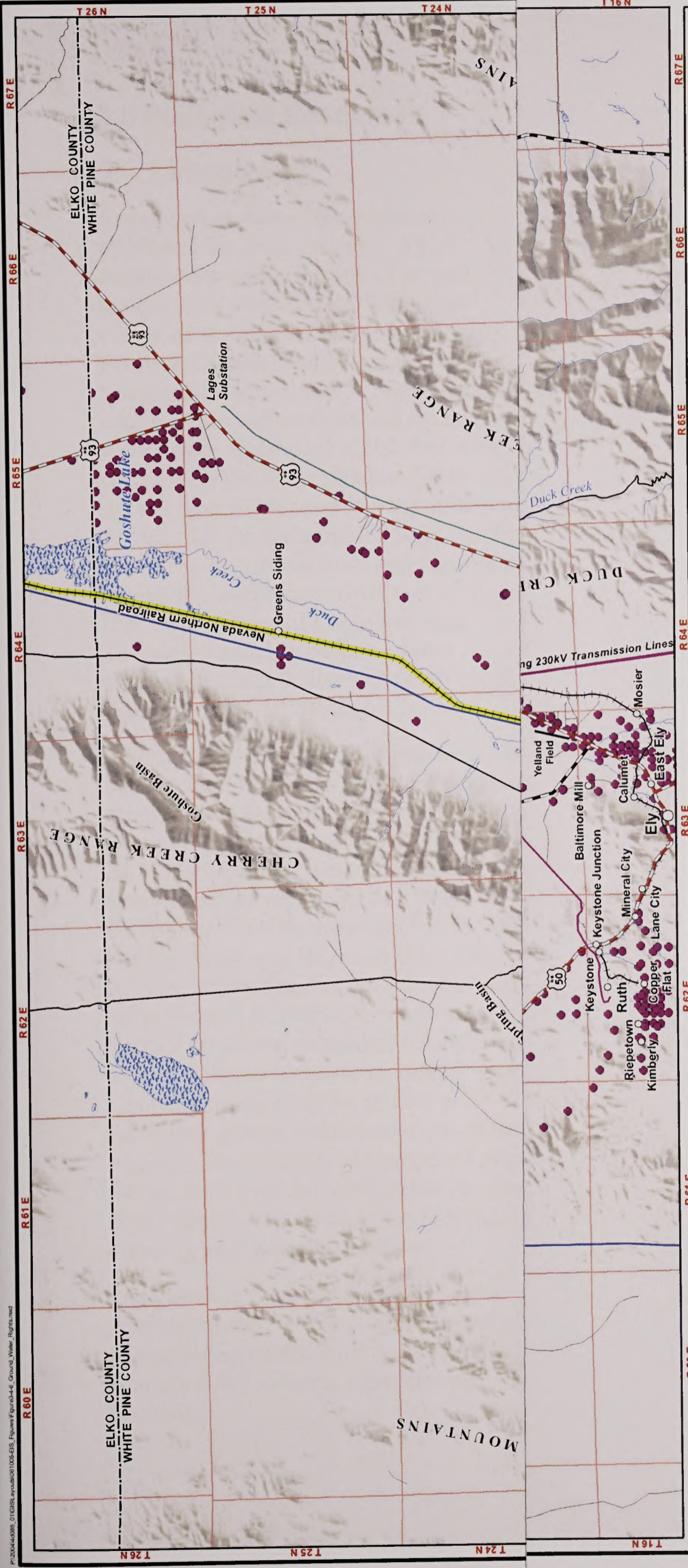

Locations of Ground Water Permits and Pending Applications White Pine Energy Station Project

Existing Electrical Features

- Existing Substation
- Existing Transmission Line
- Existing Distribution Line

Surface Water

- Perennial Stream or River
- Wetland

Connected Action

- SWIP Transmission Line
- NNR Upgrade

Common Project Features

- Minerals Materials Sale Area
- Moriah Ranches
- Seeding Project

Proposed Action Project Features

- Proposed Well Site
- Proposed Water Pipeline/Distribution Line
- Proposed Rail Spur
- Proposed Transmission Line
- Proposed Electric Distribution Line
- Proposed Access Road
- Proposed Substation Site
- Proposed Power Plant Site

0 1.5 3 Miles

1:300,000 when printed at 11 x 17 inches

Ground Water Permit or Pending Application

- Ground Water Permit or Pending Application

Alternative 1 Project Features

- Proposed Well Site
- Proposed Water Pipeline/Distribution Line
- Proposed Rail Spur
- Proposed Transmission Line
- Proposed Electric Distribution Line
- Proposed Access Road
- Proposed Substation Site
- Proposed Power Plant Site

Figure 3.4-6

3.4.2.8 Ground Water Use and Perennial Yield

Ground water is currently pumped from the basin-fill aquifers in Steptoe Valley for municipal, private domestic, and agricultural use. As presented above in Table 3.4-6, the USGS has estimated that the total amount of ground water pumped from the Steptoe Valley Hydrographic Area in 2000 was 6,360 acre-feet per year. This is the most recent date for which a published estimate is available. Of this total of 6,360 acre-feet per year, approximately 3,560 acre-feet per year went to irrigation and stock watering uses, and 2,800 acre-feet per year went for municipal use. Estimates of historical use exceed 20,000 acre-feet per year (Frick, 1985).

The perennial yield of a ground water basin is defined as the maximum amount of ground water that can be pumped each year for an indefinite period of time without depleting the ground water in storage or causing deterioration of water quality beyond the limits of economic recovery. The perennial yield of the Steptoe Valley Hydrographic Basin has been established by the Nevada Department of Conservation and Natural Resources to be 70,000 acre-feet per year (Nevada Department of Conservation and Natural Resources, 1971).

According to the Office of the Nevada State Engineer, the ground water in the basin-fill deposits of Steptoe Valley is fully allocated by the Nevada Division of Water Resources. According to a BLM, internal planning document, the amount of committed resources is 78,531 acre-feet per year, which exceeds the currently established perennial yield by 8,531 acre-feet per year. As a result, the Nevada Department of Water Resources has

designated the Steptoe Valley Hydrographic Area as being a basin where permitted ground water rights exceed the estimated perennial yield and the water resources require additional administration.

The rights to the 5,000 acre-feet per year of ground water that would be pumped for the proposed Station (see Chapter 2.0, *Description of Proposed Action and Alternatives*) were granted in 1983 when the total amount of water appropriated in Steptoe Valley was less than 48,000 acre-feet per year (Nevada Department of Conservation and Natural Resources, 1983). Therefore, the water rights that would be used for the proposed Station were appropriated before the basin became overcommitted.

The locations of all applications and existing permits for ground water in Steptoe Valley are shown in Figure 3.4-6.

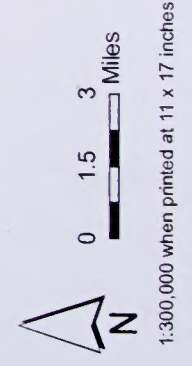
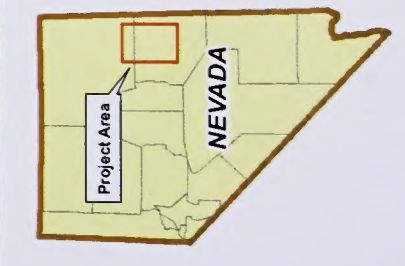
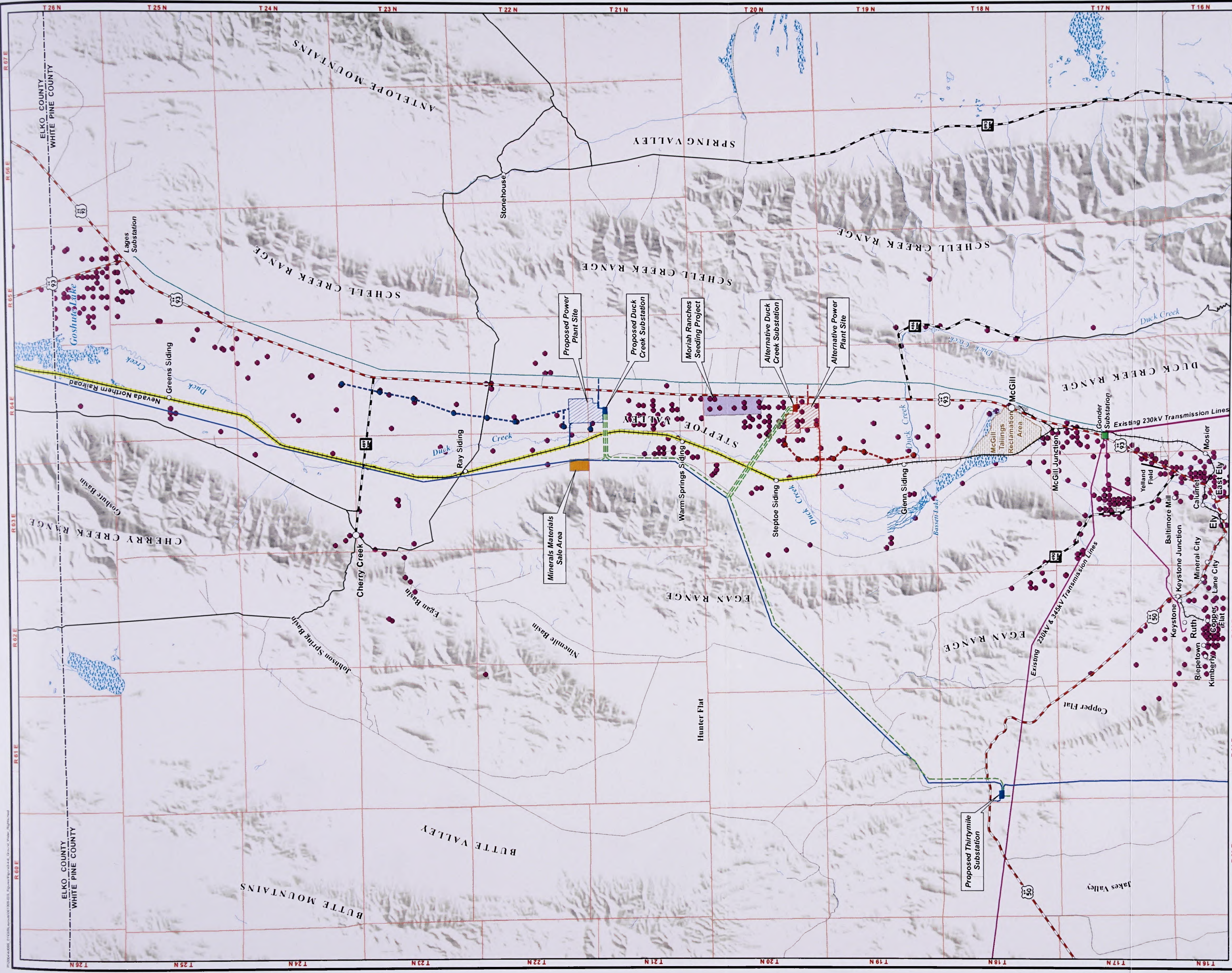

- Existing Electrical Features**
- Existing Substation
 - Existing Transmission Line
 - Existing Distribution Line
- Surface Water**
- Perennial Stream or River
 - Wetland
- Connected Action**
- SWIP Transmission Line
 - NRR Upgrade
- Common Project Features**
- Minerals Materials Sale Area
 - Morian Ranches
 - Seeding Project

- Proposed Action Project Features**
- Proposed Well Site
 - Proposed Water Pipeline/Distribution Line
 - Proposed Rail Spur
 - Proposed Transmission Line
 - Proposed Electric Distribution Line
 - Proposed Access Road
 - Proposed Substation Site
 - Proposed Power Plant Site
- Ground Water Permit or Pending Application**
- Proposed Well Site

- Alternative 1 Project Features**
- Proposed Well Site
 - Proposed Water Pipeline/Distribution Line
 - Proposed Rail Spur
 - Proposed Transmission Line
 - Proposed Electric Distribution Line
 - Proposed Access Road
 - Proposed Substation Site
 - Proposed Power Plant Site

Locations of Ground Water Permits and Pending Applications
White Pine Energy Station Project

Figure 3.4-6

3.5 Biological Resources

3.5.1 Vegetation

Vegetation resource investigations addressed the areas proposed for construction and operation of project features and proposed ROWs for the Proposed Action (see Section 2.2, *Proposed Action*) and Alternative 1 (see Section 2.3, *Alternative 1*). Vegetation communities and noxious and invasive weeds were assessed in a 200-foot-wide corridor for the water pipeline ROWs and the rail spur ROWs and in a 0.5-mile-wide corridor for the transmission lines ROWs. Issues relating to wetlands and drainages potentially under the jurisdiction of the U.S. Army Corps of Engineers were assessed in specific buffers around proposed project features as described in Section 3.5.1.1.10, *Wetlands*.

Preliminary information for vegetation and other natural resources in the project area was gathered from the Nevada Natural Heritage Program, communication with BLM staff, Natural Resources Conservation Service soil surveys (NRCS, 1998), Ecological Site Descriptions (NRCS, 1987), and the Southwest Regional GAP data (USGS, 2004). Landsat data were evaluated using Natural Resources Conservation Service rangeland suitability information and ER Mapper software to identify general plant communities in the project area. Biologists ground-truthed portions of the mapped area closest to the proposed project feature locations and used global positioning system unit to record plot data to refine the mapping and increase accuracy.

Field surveys were conducted between April and June 2005 to confirm boundaries of vegetation community types and conduct a noxious and invasive plant species inventory.

Vegetation communities present in the project area, including wetlands, are discussed in the following text. Noxious and invasive plant species are discussed separately in Section 3.5.2, *Noxious and Invasive Weeds*.

3.5.1.1 Vegetation Communities

The project area lies in the Great Basin Desert floristic region, which is dominated by sagebrush shrublands and pinyon-juniper highlands. The basin and range topography is characterized by high mountain ranges interspersed with valleys. The project area is in Steptoe Valley, Butte Valley, and the Egan Mountain Range, which separates the two basins. The Schell Creek Range forms the eastern border of Steptoe Valley. Elevations in the project area range from approximately 5,800 feet at the proposed pipeline location to 7,600 feet at the proposed transmission corridor in the Egan Range.

Precipitation in nearby Ely averages 9.27 inches per year. Daytime temperatures range between 85°F and 90°F, and decline to 50°F to 60°F at night in the summer. July, the hottest month of the year, has a mean temperature of 67.3°F. January, the coldest month of the year, has a mean temperature of 24.0°F (WPHAS, 2005).

Various land uses including surface mining, irrigated agriculture, and livestock grazing, together with wildfire and grazing by wild horses and wildlife, have disturbed or affected vegetation resources in the project area. As a result of these land uses, the vegetative communities have been altered in many areas. Section 3.5.2, *Noxious and Invasive Weeds*, describes changes to vegetation communities as affected by weeds in more detail.

Elevation, soils, and land uses determine which plant communities are dominant in various locations in the project area. Based on the Landsat analysis, 10 main vegetation communities exist in the project area (see Figure 3.5-1) and are discussed in the following text. This section closes with a brief discussion of disturbed areas.

3.5.1.1.1 Big Sagebrush Shrubland

The Big Sagebrush Shrubland community is common on the lower foothills of the Egan Range, in Butte Valley, and in Steptoe Valley at elevations from 6,000 to 7,000 feet. The dominant sagebrush species is usually Wyoming big sagebrush (*Artemisia tridentata* var. *wyomingensis*), except in some areas of deep permeable soils, usually associated with drainage bottoms. These bottom areas often are co-dominated by basin big sagebrush (*A. tridentata* var. *tridentata*) with Great Basin wildrye (*Leymus cinereus*), and extend to elevations above 7,000 feet in Dry Canyon on the slope of the Egan Range. The more common Wyoming big sagebrush communities often form pure shrub communities with few other shrub and herb layer species. At lower elevations in Steptoe Valley, big sagebrush grades into the Salt Desert Scrub, Low Scrub and Grassland, and Greasewood communities, but remains the sole dominant shrub species. Other shrub species in the Big Sagebrush Shrubland include shadscale (*Atriplex confertifolia*), spiny hopsage (*Grayia spinosa*), snakeweed (*Gutierrezia sarothrae*), budsage (*Artemisia spinescens*), black sagebrush (*Artemisia nova*), winterfat (*Krascheninnikovia lanata*), and gray rabbitbrush (*Chrysothamnus nauseosus*). Understory may consist of Indian ricegrass (*Achnatherum hymenoides*), western tansymustard (*Descurainia pinnata*), squirreltail (*Elymus elymoides*), Sandberg bluegrass (*Poa secunda*), and the

non-native invasive cheatgrass (*Bromus tectorum*).

3.5.1.1.2 Montane Sagebrush Shrubland

The Montane Sagebrush Shrubland community occurs in the Egan Range generally at elevations above 7,000 feet. This vegetation type occurs primarily in small basins with deeper soils and is frequently interwoven with Pinyon-Juniper Woodland and low sagebrush (*Artemisia arbuscula*), which grow on shallow, rocky soils. Mountain big sagebrush (*Artemisia tridentata* ssp. *vaseyana*) is the dominant shrub but other shrubs may include curl-leaf mountain mahogany (*Cercocarpus ledifolius*), antelope bitterbrush (*Purshia tridentata*), Utah serviceberry (*Amelanchier utahensis*), snowberry (*Symphoricarpos* sp.), snakeweed, gray rabbitbrush, and Mormon tea (*Ephedra viridis*). Understory grasses and forbs include squirreltail, Sandberg bluegrass, Indian ricegrass, lupine (*Lupinus argenteus*), and wavyleaf paintbrush (*Castilleja chromosa*).

3.5.1.1.3 Mixed Great Basin Shrubland

The Mixed Great Basin Shrubland occurs primarily in Steptoe Valley in a transitional habitat between Big Sagebrush Shrubland and Greasewood vegetation communities. The Mixed Great Basin Shrubland habitat shows little evidence of seasonal flooding similar to Greasewood communities, but possibly has a shallower water table than the often interwoven Salt Desert Scrub and Big Sagebrush Shrubland communities. This Mixed Great Basin Scrub community is co-dominated by big sagebrush and greasewood (*Sarcobatus vermiculatus*), but often includes shrub species of the Salt Desert Scrub vegetation community. Herb layer species include squirreltail and Indian ricegrass.

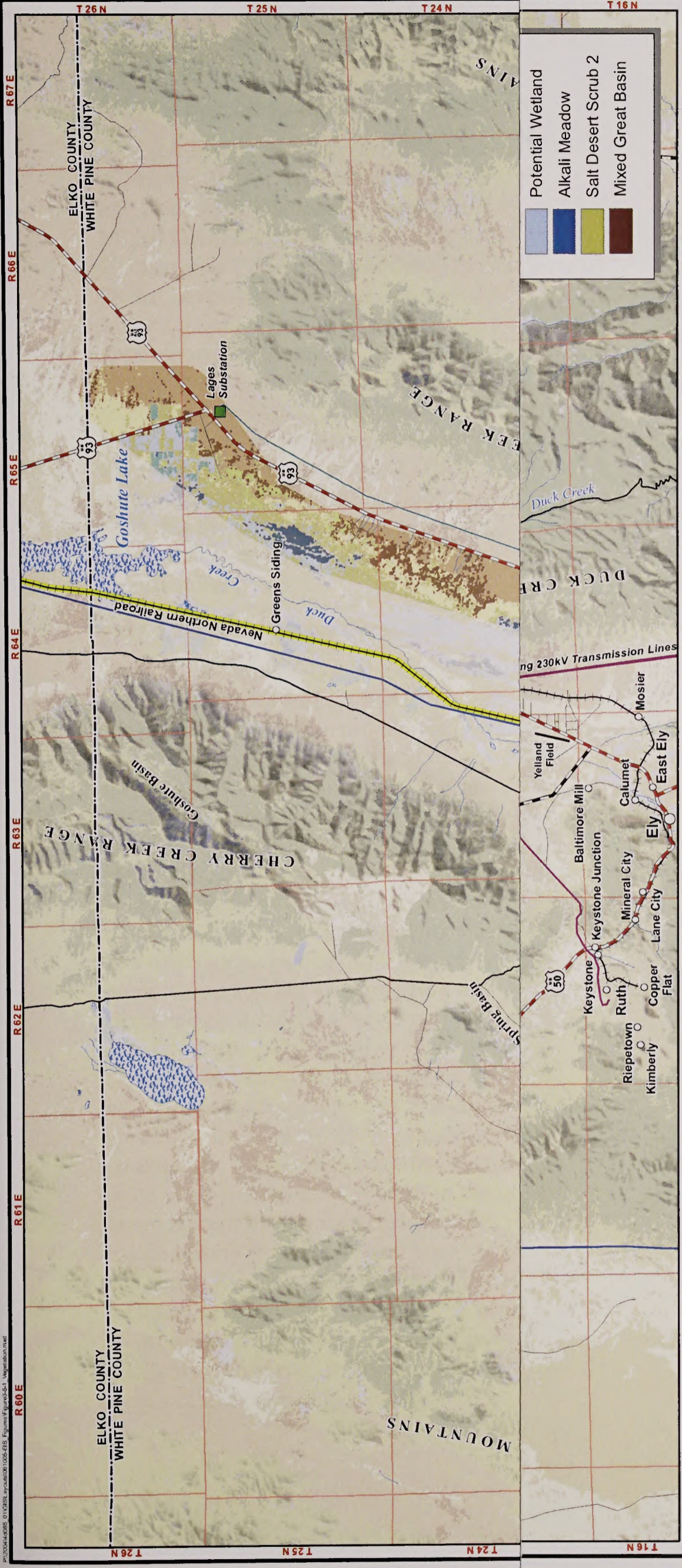

Vegetation Communities White Pine Energy Station Project

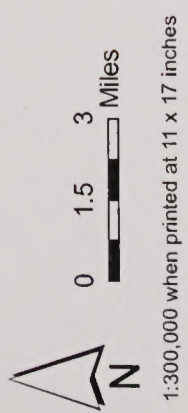
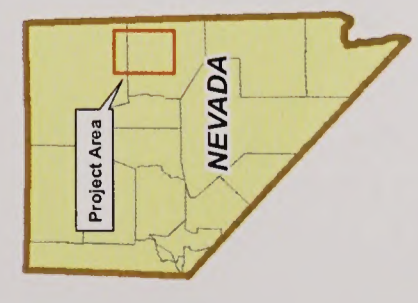

- Existing Electrical Features**
 - Existing Substation
 - Existing Transmission Line
 - Existing Distribution Line
- Surface Water**
 - Perennial Stream or River
 - Wetland
- Connected Action**
 - SWIP Transmission Line
 - NNR Upgrade
- Common Project Features**
 - Minerals Materials Sale Area
 - Moriah Ranches
 - Seeding Project

- Proposed Action Project Features**
 - Proposed Well Site
 - Proposed Water Pipeline/
Distribution Line
 - Proposed Rail Spur
 - Proposed Transmission Line
 - Proposed Electric Distribution Line
 - Proposed Access Road
 - Proposed Substation Site
 - Proposed Power Plant Site

- Alternative 1 Project Features**
 - Proposed Well Site
 - Proposed Water Pipeline/
Distribution Line
 - Proposed Rail Spur
 - Proposed Transmission Line
 - Proposed Electric Distribution Line
 - Proposed Access Road
 - Proposed Substation Site
 - Proposed Power Plant Site

Figure 3.5-1

Elevation, soils, and land uses determine which plant communities are dominant in various locations in the project area. Based on the Landsat analysis, 10 main vegetation communities exist in the project area (see Figure 3.5-1) and are discussed in the following text. This section closes with a brief discussion of disturbed areas.

3.5.1.1.1 Big Sagebrush Shrubland

The Big Sagebrush Shrubland community is common on the lower foothills of the Egan Range, in Butte Valley, and in Steptoe Valley at elevations from 6,000 to 7,000 feet. The dominant sagebrush species is usually Wyoming big sagebrush (*Artemisia tridentata* var. *wyomingensis*), except in some areas of deep permeable soils, usually associated with drainage bottoms. These bottom areas often are co-dominated by basin big sagebrush (*A. tridentata* var. *tridentata*) with Great Basin wildrye (*Leymus cinereus*), and extend to elevations above 7,000 feet in Dry Canyon on the slope of the Egan Range. The more common Wyoming big sagebrush communities often form pure shrub communities with few other shrub and herb layer species. At lower elevations in Steptoe Valley, big sagebrush grades into the Salt Desert Scrub, Low Scrub and Grassland, and Greasewood communities, but remains the sole dominant shrub species. Other shrub species in the Big Sagebrush Shrubland include shadscale (*Atriplex confertifolia*), spiny hopsage (*Grayia spinosa*), snakeweed (*Gutierrezia sarothrae*), budsage (*Artemisia spinescens*), black sagebrush (*Artemisia nova*), winterfat (*Krascheninnikovia lanata*), and gray rabbitbrush (*Chrysothamnus nauseosus*). Understory may consist of Indian ricegrass (*Achnatherum hymenoides*), western tansymustard (*Descurainia pinnata*), squirreltail (*Elymus elymoides*), Sandberg bluegrass (*Poa secunda*), and the

non-native invasive cheatgrass (*Bromus tectorum*).

3.5.1.1.2 Montane Sagebrush Shrubland

The Montane Sagebrush Shrubland community occurs in the Egan Range generally at elevations above 7,000 feet. This vegetation type occurs primarily in small basins with deeper soils and is frequently interwoven with Pinyon-Juniper Woodland and low sagebrush (*Artemisia arbuscula*), which grow on shallow, rocky soils. Mountain big sagebrush (*Artemisia tridentata* ssp. *vaseyana*) is the dominant shrub but other shrubs may include curl-leaf mountain mahogany (*Cercocarpus ledifolius*), antelope bitterbrush (*Purshia tridentata*), Utah serviceberry (*Amelanchier utahensis*), snowberry (*Symphoricarpos* sp.), snakeweed, gray rabbitbrush, and Mormon tea (*Ephedra viridis*). Understory grasses and forbs include squirreltail, Sandberg bluegrass, Indian ricegrass, lupine (*Lupinus argenteus*), and wavyleaf paintbrush (*Castilleja chromosa*).

3.5.1.1.3 Mixed Great Basin Shrubland

The Mixed Great Basin Shrubland occurs primarily in Steptoe Valley in a transitional habitat between Big Sagebrush Shrubland and Greasewood vegetation communities. The Mixed Great Basin Shrubland habitat shows little evidence of seasonal flooding similar to Greasewood communities, but possibly has a shallower water table than the often interwoven Salt Desert Scrub and Big Sagebrush Shrubland communities. This Mixed Great Basin Scrub community is co-dominated by big sagebrush and greasewood (*Sarcobatus vermiculatus*), but often includes shrub species of the Salt Desert Scrub vegetation community. Herb layer species include squirreltail and Indian ricegrass.

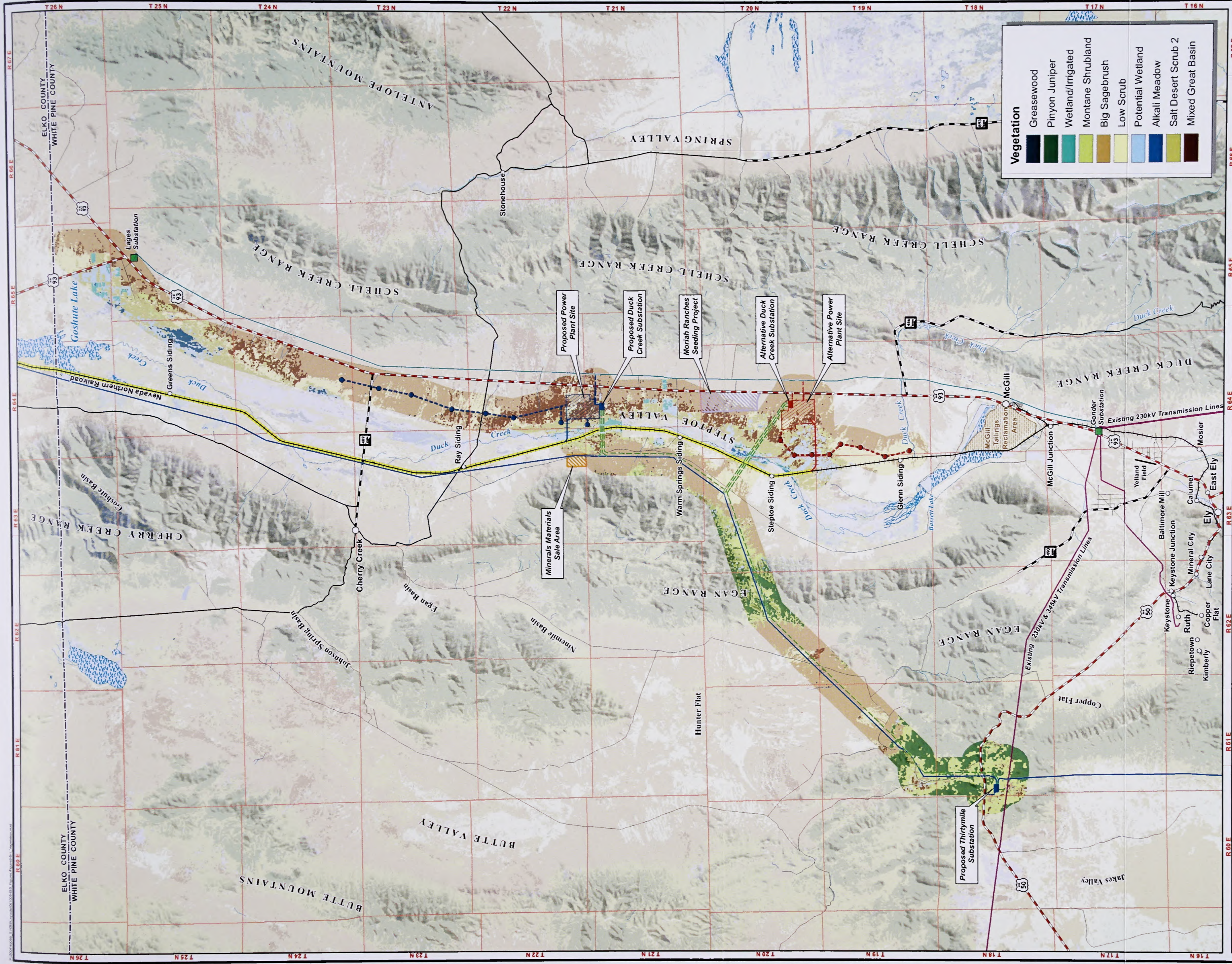

Vegetation

- Greasewood
- Pinyon Juniper
- Wetland/Irrigated
- Montane Shrubland
- Big Sagebrush
- Low Scrub
- Potential Wetland
- Alkali Meadow
- Salt Desert Scrub 2
- Mixed Great Basin

Vegetation Communities

White Pine Energy Station Project

Existing Electrical Features

- Existing Substation
- Existing Transmission Line
- Existing Distribution Line

Surface Water

- Perennial Stream or River
- Wetland

Connected Action

- SWIP Transmission Line
- NNR Upgrade

Common Project Features

- Minerals Materials Sale Area
- Moriah Ranches
- Seeding Project

Proposed Action Project Features

- Proposed Well Site
- Proposed Water Pipeline/Distribution Line
- Proposed Rail Spur
- Proposed Transmission Line
- Proposed Electric Distribution Line
- Proposed Access Road
- Proposed Substation Site
- Proposed Power Plant Site

Alternative 1 Project Features

- Proposed Well Site
- Proposed Water Pipeline/Distribution Line
- Proposed Rail Spur
- Proposed Transmission Line
- Proposed Electric Distribution Line
- Proposed Access Road
- Proposed Substation Site
- Proposed Power Plant Site

NEVADA

0 1.5 3 Miles

1:300,000 when printed at 11 x 17 inches

Figure 3.5-1

3.5.1.1.4 Salt Desert Scrub

The Salt Desert Scrub community occurs in Steptoe Valley in locations adjacent to and possibly transitional between the Mixed Great Basin Shrubland and Greasewood Playa communities. The Salt Desert Scrub community is composed of saline tolerant shrubs including greasewood, shadscale, budsage, four-wing saltbrush (*Atriplex canescens*), snakeweed, winterfat, and green rabbitbrush (*Chrysothamnus viscidiflorus*) but typically no big sagebrush. This community occurs on valley floors in clay soils that are presumed to be generally seasonally inundated but less than the Greasewood Playa.

3.5.1.1.5 Low Scrub and Grassland

The Low Scrub and Grassland community occurs in Steptoe Valley, particularly at the southern end of the project area. This vegetation type is characterized by a mosaic of low-growing shrubs and grass species whereby one or more shrub or grass species dominate. Winterfat, snakeweed, and shadscale occur as the sole dominant shrub species or are co-dominant in a mix of low growing shrubs that often includes bud sage. Typically, greasewood and big sagebrush are absent. Black sagebrush forms very small patches in a few areas. Squirreltail or Sandberg bluegrass are consistently present and can be abundant and sometimes the dominant species in the Low Scrub and Grassland community. Cheatgrass is a consistent and often abundant invasive species in the herb layer. Recent evidence of disturbance includes only occasional wild horse prints and dung. Evidence of past cattle grazing includes very old dung and small barren feeding areas. Long-dead big sagebrush plants were observed in some areas but were not widespread in this vegetation

type. No clear indication of what killed these plants was evident.

3.5.1.1.6 Greasewood Playa

The Greasewood Playa community occurs in flat areas on the floor of Steptoe Valley. Shrub species are present at the fringes of the playas. The most common shrub species is greasewood. Another commonly observed shrub in this community is rabbitbrush. Other species associated with the Greasewood Playa/Dunes community include bush sinkweed (*Suaeda moquinii*), basin wildrye, milkvetch (*Astragalus* spp.), and nodding thelypody (*Thelypodium flexuosum*).

3.5.1.1.7 Greasewood Dunes

The northern portion of the proposed water pipeline route traverses the edge of an area dominated by sand dunes. The dune systems in Steptoe Valley are associated with open playa and pans. The dunes are partially stabilized by salt-encrusted soils formed when water that is wicked from nearby seasonally inundated playa pans dries out. Loose sand substrates typically only occur on the leeward side of the dunes. Greasewood often grows along the dune crests and, along with salt grass (*Distichlis spicata*), basin wildrye, and rabbitbrush, helps stabilize the dunes.

3.5.1.1.8 Rabbitbrush

The Rabbitbrush community dominates in some previously disturbed areas in Steptoe Valley and the Egan Range where rabbitbrush is the dominant shrub species. Rabbitbrush is also associated with disturbed areas in Greasewood Playa/Dune, Big Sagebrush Shrubland, and Montane Sagebrush Shrubland vegetation communities and frequently shares herb layer species associated with these communities. The Rabbitbrush community is not mapped as a separate

community because of its tendency to mix with other cover types.

3.5.1.1.9 Pinyon-Juniper Woodland

Pinyon (*Pinus monophylla*) and Utah juniper (*Juniperus osteosperma*) are dominant in the Pinyon-Juniper Woodland. This community generally occurs above 7,000 feet in elevation in the Egan Range on both the Steptoe Valley and Butte Valley sides. Understory composition in this community varies with elevation, aspect, and soil conditions. The most frequently occurring shrub species are mountain big sagebrush and low sagebrush. Mountain mahogany (*Cercocarpus montanus*), curl-leaf mountain mahogany, grey rabbitbrush, and antelope bitterbrush are less abundant shrub layer species. Herb layer species include Sandberg bluegrass, Indian ricegrass, Thurber's needlegrass (*Achnatherum thurberiana*), caespitose buckwheat (*Eriogonum caespitosum*), cushion buckwheat (*Eriogonum ovalifolium*), wavy-leaf paintbrush, dusty maidens (*Chaenactis douglasii*), and cushion stenotus (*Stenotus acaulis*).

3.5.1.1.10 Wetlands

Landsat imagery analyses and field surveys conducted through May and June 2005 were used to identify wetland communities based on vegetative and general landforms. A formal wetland delineation was conducted in July and October 2006 to assess the extent of wetlands and potential "waters of the United States" that would be under United States Army Corps of Engineers (USACE) jurisdiction and require permits under Section 404 of the Clean Water Act. The following two subsections describe the general wetland community types and the wetland delineation results.

Wetland Communities

The largest areas of wetlands are associated with the Duck Creek floodplain and tributaries to Duck Creek near the power plant site associated with Alternative 1. All wetland vegetation in the project area is dominated by herbaceous vegetation. The nearest willow- (*Salix* spp.) dominated wetland vegetation was observed near Bassett Lake and the McGill Tailings Reclamation Area more than 1 mile from the alternative water pipeline route. Other shrub-dominated wetlands include those areas supporting greasewood growing in association with playa pan habitats. The Greasewood Playa vegetation community is mapped where extensive examples were encountered during surveys. Other small inclusions occur throughout the Salt Desert Scrub vegetation community and were not mapped.

Smaller areas of wetlands, some of which are too small to be identified on Landsat imagery, are supported by the more than 100 springs in Steptoe Valley and at Dry Spring in the Egan Range. Dry Spring is located in the SWIP corridor near the summit of the Egan Range just west of Steptoe Valley. This spring is highly disturbed by livestock and wild horses, access roads, and development of the spring for livestock watering. Vegetation at the spring is primarily herbaceous and heavily cropped. The remaining springs occur throughout Steptoe Valley in areas outside the project area and do not directly overlap the proposed and alternative project footprints. A number of the springs visited along the western side of Steptoe Valley were found to support narrow bands of wetland vegetation such as clustered field sedge (*Carex praegracilis*), rushes (*Juncus* spp.), and spikerushes (*Eleocharis* spp.). However, some of the

larger springs, and particularly those that have been developed for livestock watering, have larger areas of ponded water and emergent wetland plant species such as cattail (*Typha latifolia*), sedges, rushes, and spikerushes. In some cases, springs have dense coverage of watercress (*Rorippa nasturtium aquatica*).

The floodplain of Duck Creek is composed of diverse wet meadow vegetation and an adjacent upland band of alkali salt-crust meadows (alkali meadow) that are interspersed primarily with Salt Desert Scrub vegetation. The project features that would intersect the Duck Creek drainage are as follows:

- Proposed Action transmission line segments from the power plant site to the SWIP corridor
- Proposed and alternative railroad spurs
- Water pipeline spurs southeast of Cherry Creek, Nevada, and just west of the Proposed Action power plant site
- Alternative 1 transmission line segments from the power plant site to the SWIP corridor

A tributary to Duck Creek west of the Alternative 1 power plant site forms a wide alluvial fan with multiple swales that have wet meadow vegetation interspersed with patches of Salt Desert Scrub vegetation and alkali meadow. The project features that cross these wet meadows include the proposed water pipeline, distribution lines west of the Alternative 1 power plant site, and Alternative 1 railroad spur. Another tributary consisting of four wet swale areas with wet meadow vegetation occurs north of the Alternative 1 power plant site, but would not be crossed by project features. Agricultural land use in this area has reduced the extent of wetland vegetation.

Most of the wet meadow vegetation appears to be at least seasonally or intermittently flooded based on the plant species composition and evidence of surface inundation noted during the field surveys. The wet meadow vegetation is typically dense, but it thins out near the transition with alkali meadow where wetland species often grade into the adjacent shrub-dominated communities. Common wet meadow species include Baltic rush (*Juncus balticus*), silverweed (*Potentilla anserina*), clustered field sedge (*Carex praegracilis*), alkali bluegrass (*Poa juncifolia*), straight-leaf rush (*Juncus* cf. *orthophyllus*), alkali cordgrass (*Spartina gracilis*), alkali sacaton (*Sporobolus airoides*), inland saltgrass (*Distichlis spicata*), and creeping spikerush (*Eleocharis* cf. *palustris*). The alkali meadow vegetation in some places appears to be seasonally flooded or at least has water close enough to the surface to saturate the salt-crust soils. The alkali meadow vegetation is often sparse and includes salt grass, thickspike wheatgrass (*Elymus lanceolatus*), Lemmon's rubberweed (*Hymenoxys lemmonii*), poverty weed (*Iva axillaris*), and fiddleneck hawkweed (*Crepis runcinata*).

Wetland Delineation

A delineation of potential "waters of the United States" under the jurisdiction of Section 404 of the Clean Water Act, including potentially jurisdictional wetlands and streams that have an ordinary high water mark (OHWM) and have a direct connection with Duck Creek, was conducted in the White Pine Energy Station project area during the summer of 2006 using the U.S. Army Corps of Engineers' (USACE) *Wetlands Delineation Manual* (USACE, 1987). Wetlands and drainages were also evaluated to determine whether the

potential for water quality impairment from construction-related ground disturbances exists. If such potential exists, work around the “NDEP-sensitive” features would require a Nevada NDEP temporary permit for working in waterways (“Rolling Stock Permit”). According to current NDEP management, NDEP-sensitive drainages include USACE jurisdictional drainages as well as the drainages that are not under USACE jurisdiction but meet one or more of the following criteria:

- Perennial drainages and their tributaries
- Drainages with no OHWM connected to waterbodies with interstate commerce use(s)

- Swales, ephemeral, and intermittent drainages with associated wetland or riparian habitat
- Disjunct drainages at least 1 foot deep ending within 0.5 mile of another waterbody with potential water quality impairment
- Any drainage that could potentially convey flows directly to Duck Creek or its associated wetland and riparian areas during even brief periods of high runoff (Mulligan, 2006).

The field delineation addressed the area within the Proposed Action and Alternative 1 project ROWs and buffer zones (Table 3.5-1).

TABLE 3.5-1

Areas Addressed During the White Pine Energy Station Wetland Delineation for the Proposed Action and Alternative 1 Project Components

Project Components	Buffer Width
Proposed Action	
SWIP/WPES ROW	1,500 feet on centerline
SWIP access roads	200 feet on centerline
SWIP ROW	1,350 feet (450 south, 900 north of centerline)
Rail spur ROW	500 feet on centerline
Water pipeline ROW	275 feet on centerline
Power plant including substation	100 feet on perimeter
Access road power plant ROW	200 feet on centerline
Alternative 1	
SWIP/WPES ROW	1,500 feet on centerline
Access road SWIP ROW	200 feet on centerline
Rail spur ROW	500 feet on centerline
Water pipeline ROW	275 feet on centerline
Power plant including substation	100 feet on perimeter
Access road power plant ROW	200 feet on centerline

The following is a summary of the wetland delineation findings (see Appendix I, *Wetlands*). For purposes of this summary, the following calculations include all potential "waters of the U.S." (including wetlands) inventoried within the White Pine Energy Station study area including the buffer widths as outlined in Table 3.5-1. These numbers do not reflect the actual area of temporary or permanent impact to potential wetlands and other waters of the U.S. The actual area of impact is addressed in Chapter 4 and was based on the construction ROW for each project feature. A total of 441.7 acres in the combined study area for the Proposed Action and Alternative 1 were determined to be wetlands or other potential waters of the United States. Of these, 240.3 acres are potentially jurisdictional wetlands, 19.3 acres are potentially jurisdictional other waters of the United States, and 182.1 acres are non-jurisdictional wetlands. The final jurisdiction determination is the responsibility of the USACE and their decision is not yet available. Approximately 126.5 acres of potentially jurisdictional wetlands were associated with the Proposed Action ROWs and buffers while 113.8 acres of potentially jurisdictional wetlands were associated with the Alternative 1 ROWs and buffers (Appendix I, *Wetlands*).

The potentially jurisdictional wetlands documented in the vicinity of the Proposed Action and Alternative 1 project features were of three basic types: wet meadow, alkali meadow, and rabbitbrush meadow. Approximately 168.5 acres (70 percent) of the wetlands were alkali meadows and 2.1 acres (1 percent) were rabbitbrush meadows. Approximately 69.7 acres of wet meadow (29 percent of the wetlands) were documented in the various ROWs and buffers, particularly near Duck Creek.

In total, 122 drainages were identified in the field and assessed for their potential jurisdictional status with USACE and NDEP. The drainages included 61 ephemeral, 54 swales, 6 intermittent, and one perennial. The one perennial creek, Schell Creek, connects to Duck Creek. An intermittent stream that was found within the buffer but would not be crossed by the proposed or alternative ROWs is a stream in Water Canyon in the Egan Range along the SWIP/White Pine Energy Station transmission line ROW.

The six potential USACE jurisdictional stream segments included: the perennial Schell Creek mainstem and one intermittent tributary to Schell Creek, three intermittent Duck Creek mainstem segments, and one intermittent Duck Creek side channel. Section 3.3.3.1 provides general descriptions of the major streams in the project vicinity. Appendix I provides additional information on the potential waters of the United States. More than 98 percent of the 19.3 acres of other potential "waters of the United States" crossed by the proposed and alternative ROWs and buffers are associated with three segments of the main channel and one side channel of Duck Creek with OHWM channel widths of between 30 and 250 inches; the two other potential "waters of the United States" are associated with Schell Creek and its tributary. The Schell Creek segments have 18-32 inch-wide OHWM channels.

Duck Creek was observed to have slowly flowing water at all three locations where it is crossed by the proposed and alternative ROWs. Observations of Duck Creek approximately 5 miles south of Goshute Lake revealed a dry Duck Creek channel with a distinct bank and a bed having a high ground cover of hydrophytic vegetation.

It is highly probable that most of the 61 ephemeral drainages are not ordinarily connected to Duck Creek based on field observations and aerial photographic interpretation. Most of these drainages either percolate into the ground or are intercepted by irrigation ditches. It is unlikely that these diverted streams would be ordinarily connected to Duck Creek even if flows were not intercepted. There were no field observations of ephemeral tributary channels that cut through the broad alkali meadows along Duck Creek to ordinarily connect to the Duck Creek channel. Field observations in 2006 indicate that in many places along County Road 27 and the Nevada Northern Railway (NNR) water is intercepted and pools upstream of these development features. Most of the pooled water sinks into the ground. Typically, only a portion of the upstream flow is allowed to flow downstream of water diversions and frequently it is re-directed to a different, newer channel that is not as “broken-in” and does not convey water as efficiently nor as far downslope as the channel that received those flows for many years prior to the various developments. Dirt access roads in Steptoe Valley also were observed to have similar effects on flows in ephemeral streams.

In terms of NDEP-sensitive surface waters, the Proposed Action and Alternative 1 ROWs and buffers contain 8 wetlands (441.7 acres) and 61 drainages with potential for water quality impairment related to project construction. NDEP-sensitive surface waters include 61 additional drainages that are not expected to be subject to USACE jurisdiction because they are not ordinarily connected to Duck Creek. There are a total of 22 other ephemeral drainages in the project area that have no associated wetland or riparian habitat, are disjunct or are considered to have no potential to support flows into sensitive resources downstream, and are therefore not NDEP-sensitive.

3.5.1.1.11 Disturbed Areas

Areas previously disturbed by human or natural causes such as fire, mining, past or current agricultural use, or grazing are often weedy and may support large populations of halogeton (*Halogeton glomeratus*), Russian thistle (*Salsola kali*), mustards (*Descurainia* spp.), cheatgrass (*Bromus tectorum*), or other weedy species. These areas are described further in Section 3.5.2, *Noxious and Invasive Weeds*, together with several native plant species that may occur in disturbed areas. In addition, agricultural areas on private land may be irrigated and support non-native grass or hay species. Disturbed areas are not mapped on the vegetation communities map (Figure 3.5-1) because of limitations of the mapping software.

3.5.2 Noxious and Invasive Weeds

Noxious weeds are invasive, non-native species that are listed on state or federal noxious weed lists. Nevada state law defines noxious weeds as “any species of plant which is likely to be detrimental, or destructive, and difficult to destroy or eradicate.” Because of their invasive nature, noxious weeds have the ability to become established and spread rapidly in an area, crowding out preexisting plants. Noxious weeds generally cause harm to production of agriculture, range, forestry, or other commodities. The risk of fire is also increased.

Analysis of weeds for purposes of this EIS includes species in the following categories:

- Plant species listed or considered federal noxious weeds by the U.S. Department of Agriculture
- Plant species listed as noxious weeds by the State of Nevada Department of Agriculture (Nevada Revised Statutes 555)
- Noxious weeds of concern to the BLM

Distributions of noxious and invasive weed species were recorded using a scale of density provided by the BLM. The scale for percent cover of weeds in a given area was recorded as follows: none (zero); light (1 to 5 percent); moderate (6 to 25 percent); heavy (25 to 50 percent); and very heavy (more than 50 percent). The terms light, moderate, heavy, and very heavy are used in the following sections to describe the general percent cover of weeds.

3.5.2.1 Regulatory Framework

Federal Executive Order 13112, *Prevention and Control of Invasive Species* (February 3, 1999), defines invasive species as “alien species whose introduction does or is likely to cause economic or environmental harm or harm to human health.” This order mandates that any federal agency whose actions may affect the status of invasive species shall, to the extent practicable and permitted by law, identify such actions; prevent the introduction and spread of invasive species; detect and respond rapidly to and control populations of such species in a cost-effective and environmentally sound manner; monitor invasive species and habitat conditions in ecosystems that have been invaded; and provide for restoration of native species and habitat conditions in ecosystems that have been invaded.

3.5.2.1.1 Federal Noxious and Invasive Weed Laws

A number of additional federal laws address invasive species and legislate the identification, treatment, and monitoring of the spread of invasive species. These are as follows:

- Lacey Act as amended (18 U.S.C. 42)
- Nuisance Prevention and Control Act of 1990 as amended (16 U.S.C. 4701 et seq.)
- Federal Noxious Weed Act of 1974 as amended by the Food, Agriculture,

Conservation, and Trade Act of 1990 (Section 1453 “Management of Undesirable Plants on Federal Lands” U.S.C. 2801 et. seq.)

- Federal Plant Pest Act (7 U.S.C. 150aa et seq.)
- Carlson-Fogey Act of 1968 (Public Law 90-583).

The BLM, U.S. Department of Agriculture, and State of Nevada continually update noxious and invasive species lists in order to monitor invasive weed impacts on the economy and ecology of both private and public lands.

3.5.2.1.2 Nevada Noxious Weed Laws

The Nevada Department of Agriculture has the authority and responsibility under Chapter 555 of the Nevada Revised Statutes to enforce the State’s noxious weed law. The function of the noxious weed program is to control noxious weeds to protect the crops, livestock, public health, wildlife, water quality, and beneficial uses of Nevada land. It is the responsibility of the landowner (public and private) to control and eradicate all plants designated as “noxious” on the State of Nevada list. This statute also created county weed control districts that are responsible for the control and eradication of noxious weeds within their boundaries. No designated Weed Control District covers the project area. Weed management in Nevada is facilitated by the Nevada Weed Action Committee under Nevada’s Coordinated Invasive Weed Strategy (NDOA, 2002).

Tri-County Weed Program’s office was contacted at the start of the White Pine Energy Station studies to acquire a weed species list for the county. White Pine County uses the State Noxious Weed list, which is provided in Table 3.5-2. In addition to the listed noxious weeds, BLM identified invasive species of concern as listed in Table 3.5-3.

TABLE 3.5-2

Nevada Department of Agriculture Noxious Weed List

Common Name	Scientific Name	Common Name	Scientific Name
Category A Weeds^a			
African rue	<i>Peganum harmala</i>	Leafy spurge	<i>Euphorbia esula</i>
Austrian fieldcress	<i>Rorippa austriaca</i>	Malta star thistle	<i>Centaurea melitensis</i>
Austrian peaweed	<i>Sphaerophysa salsula</i> / <i>Swainsona salsula</i>	Mayweed chamomile	<i>Anthemis cotula</i>
Camelthorn	<i>Alhagi camelorum</i>	Mediterranean sage	<i>Salvia aethiopsis</i>
Common crupina	<i>Crupina vulgaris</i>	Purple loosestrife	<i>Lythrum salicaria</i> , <i>L. virgatum</i> , and their cultivars
Dalmation toadflax	<i>Linaria dalmatica</i>	Purple star thistle	<i>Centaurea calcitrapa</i>
Dyer's woad	<i>Isatis tinctoria</i>	Rush skeletonweed	<i>Chondrilla juncea</i>
Eurasian water-milfoil	<i>Myriophyllum spicatum</i>	Sow thistle	<i>Sonchus arvensis</i>
Giant reed	<i>Arundo donax</i>	Spotted knapweed	<i>Centaurea masculosa</i>
Giant salvinia	<i>Salvinia molesta</i>	Squarrose star thistle	<i>Centaurea virgata</i> Lam. var. <i>squarrose</i>
Goats rue	<i>Galega officinalis</i>	Sulfur cinquefoil	<i>Potentilla recta</i>
Houndstongue	<i>Cynoglossum officinale</i>	Syrian bean caper	<i>Zygophyllum fabago</i>
Hydrilla	<i>Hydrilla verticillata</i>	Yellow star thistle	<i>Centaurea solstitialis</i>
Iberian star thistle	<i>Centaurea iberica</i>	Yellow toadflax	<i>Linaria vulgaris</i>
Klamath weed	<i>Hypericum perforatum</i>		
Category B Weeds^b			
Carolina horse-nettle	<i>Solanum carolinense</i>	Russian knapweed	<i>Acroptilon repens</i>
Diffuse knapweed	<i>Centaurea diffusa</i>	Scotch thistle	<i>Onopordum acanthium</i>
Medusahead	<i>Taeniatherum caput-medusae</i>	White horse-nettle	<i>Solanum elaeagnifolium</i>
Musk thistle	<i>Carduus nutans</i>		
Category C Weeds^c			
Black henbane	<i>Hyoscyamus niger</i>	Perennial pepperweed	<i>Lepidium latifolium</i>
Canada thistle	<i>Cirsium arvense</i>	Poison hemlock	<i>Conium maculatum</i>
Green fountain grass	<i>Pennisetum setaceum</i>	Puncture vine	<i>Tribulus terrestris</i>
Hoary cress	<i>Cardaria draba</i>	Salt cedar (tamarisk)	<i>Tamarix</i> spp.
Johnson grass	<i>Sorghum halepense</i>	Water hemlock	<i>Cicuta maculata</i>

Source: http://agri.nv.gov/nwac/PLANT_NoXWeedList.htm

^a Weeds not found or limited in distribution throughout the state; actively excluded from the state and actively eradicated wherever found; actively eradicated from nursery stock dealer premises; control required by the state in all infestations

^b Weeds established in scattered populations in some counties of the state; actively excluded where possible; actively eradicated from nursery stock dealer premises; control required by the state in areas where populations are not well established or previously unknown to occur

^c Weeds currently established and generally widespread in many counties of the state; actively eradicated from nursery stock dealer premises; abatement at the discretion of the state quarantine officer

TABLE 3.5-3

Invasive Plants Identified in Project Area

Common Name	Scientific Name
Bur buttercup	<i>Ranunculus testiculatus</i>
Cheatgrass	<i>Bromus tectorum</i>
Common dandelion	<i>Taraxacum officinale</i>
Field bindweed	<i>Convolvulus arvensis</i>
Flixweed	<i>Descurainia sophia</i>
Halogeton	<i>Halogeton glomeratus</i>
American kochia	<i>Kochia scoparia</i>
Pepperweed	<i>Lepidium perfoliatum</i>
Prickly lettuce	<i>Lactuca serriola</i>
Russian thistle	<i>Salsola iberica</i>
Tumble mustard	<i>Sisymbrium altissimum</i>

3.5.2.2 Analysis Area and Methodology

Identifying the weeds in a project area allows land managers to determine the potential for further infestations based on a plant's phenology, distribution, and current site conditions. Invasive and noxious weeds were identified in the project area using a protocol developed by the BLM. During weed sampling inventories, vegetation mapping, and habitat assessment surveys conducted in June 2005, weed presence was documented at 0.25-mile intervals along the centerline of the proposed water pipeline and rail spur ROWs, and at each of the proposed power plant locations, substations, well sites, predetermined access roads, power distribution lines, and all other ancillary facilities associated with the development of the proposed project. Weed documentation also occurred at random locations along the proposed transmission (SWIP corridor) and distribution line ROWs.

3.5.2.3 Noxious Weeds in the Project Area

Field surveys conducted in June 2005 documented 11 invasive weed species and two noxious weed species in or alongside project feature sites for the Proposed Action and Alternative 1 (Table 3.5-4).

Noxious weed species found in the project area include hoary cress (*Cardaria draba*) and sulphur cinquefoil (*Potentilla recta*). Hoary cress was documented in moderate to heavy patches east of U.S. 93 and along some roads in the project area. Hoary cress populations were also observed within the Alternative 1 power plant footprint. The density of this species is heavy in some areas and very heavy along the road leading west up to the mouth of Duck Creek. Hoary cress grows in a wide range of soil types but is best adapted to alkaline soils that are wet during late spring (Sheley and Stivers, 1999). Therefore, sites most susceptible to invasion by this species are subirrigated pastures, rangeland, ditches, roadsides, and waste areas.

TABLE 3.5-4

Weed Populations Present in or Along Project Feature Sites for the Proposed Action and Alternative 1

Scientific Name	Common Name	Noxious or Invasive	Transmission Lines	Water Supply System	Rail Spur	Power Plant Site	Existing Roads
Proposed Action							
<i>Cardaria draba</i>	Hoary Cress	Noxious	—	—	A1	A1	PA, A1
<i>Bromus tectorum</i>	Cheatgrass	Invasive	PA, A1	PA, A1	PA, A1	PA, A1	PA, A1
<i>Descurainia sophia</i>	Flixweed	Invasive	PA, A1	PA, A1	—	PA, A1	PA, A1
<i>Sisymbrium altissimum</i>	Tumble mustard	Invasive	—	PA, A1	—	—	PA, A1
<i>Salsola iberica</i>	Russian thistle	Invasive	PA, A1	PA, A1	—	—	PA, A1
<i>Halogeton glomeratus</i>	Halogeton	Invasive	PA, A1	PA, A1	—	—	PA, A1
<i>Lepidium perfoliatum</i>	Pepperweed	Invasive	PA, A1	—	—	—	—
<i>Ranunculus testiculatus</i>	Bur buttercup	Invasive	PA, A1	—	—	—	PA, A1
<i>Convolvulus arvensis</i>	Field bindweed	Invasive	—	—	—	—	—
<i>Kochia scoparia</i>	American kochia	Invasive	—	—	PA	—	—
<i>Potentilla recta</i>	Sulphur cinquefoil	Noxious	PA, A1	—	—	—	—
<i>Taraxacum officinale</i>	Common dandelion	Invasive	PA, A1	—	—	—	—
<i>Lactuca serriola</i>	Prickly lettuce	Invasive	—	PA, A1	—	—	PA, A1

PA = Proposed Action; A1 = Alternative 1
 Source: June 2005 field surveys.

Sulphur cinquefoil was documented along the transmission line corridor for both the Proposed Action and Alternative 1. This is a very aggressive species and susceptible locations include disturbed areas, waste places, roadsides, trails, ditches, abandoned lots and fields, pastures, and clear cuts (University of Nevada Cooperative Extension, 2005).

Populations of one other noxious weed species, musk thistle (*Carduus nutans*), were observed outside of the project area off of County Road 19 in Butte Valley. Because of the spreading nature of noxious weeds, this species is included in the impacts analysis and weed risk assessment even though it is currently outside of the project area. Musk thistle thrives in heavily

grazed pastures but is rare in the absence of grazing (Beck, 1999).

The dominant invasive weed species found during surveys were cheatgrass, halogeton, flixweed (*Descurainia sophia*), and Russian thistle. Halogeton and cheatgrass were frequently observed along access roads throughout the project area. Halogeton is the common invasive in upland shadscale and saltbush communities throughout the Great Basin (Nachlinger et al., 2001). Heavy infestations of both cheatgrass and flixweed were recorded in the Proposed Action power plant site.

In some areas, cheatgrass extends for hundreds of acres at varying levels of infestation. Other invasives documented in the area are populations of tumble mustard (*Sisymbrium altissimum*), field bindweed (*Convolvulus arvensis*), common dandelion (*Taraxacum officinale*), bur buttercup (*Ranunculus testiculatus*), pepperweed (*Lepidium perfoliatum*), prickly lettuce (*Lactuca serriola*), and American kochia (*Kochia scoparia*). American kochia was observed at the very western end of the proposed rail spur alignment along the existing railroad tracks, into which the rail spur would connect.

Several native plant species were often observed in dense populations in disturbed areas in portions of the project area. The most prevalent of these is the pinnate tansymustard (*Descurainia pinnata*). This species was found near all of the major proposed project feature sites and was often found growing adjacent to flixweed populations. Poverty sumpweed (*Iva axillaries*) and bushy blazingstar (*Mentzelia dispersa*) are other native species that often occurred in and adjacent to disturbed areas.

A variety of land uses and disturbances has led to the proliferation of noxious and invasive weeds. BLM recreational trails and roads, particularly along the Egan Range, have created disturbances and introduced noxious/invasive species. The project area has been historically and is currently extensively grazed by domestic cattle and sheep, wild horses, pronghorn, and mule deer. The combination of long-term grazing and human access has resulted in very few areas having an undisturbed understory that is dominated by native herbaceous species. Invasive species have taken the place of native grass and forb species in many areas throughout Steptoe Valley and Butte Valley.

In addition to human-caused disturbances, a number of wildfires have occurred in and near the project area. At the southern end of the proposed transmission alignments within the SWIP corridor, BLM GIS data files show the Cruesoe fire burned 1,654.7 acres in 2000. Many native perennial grasses have revegetated the burned area, although cheatgrass is prevalent in portions of the transmission line corridor that intersect the burn. Evidence of several other wildfires not mapped by BLM was noted in the project area during biological field surveys in 2005. Cheatgrass, halogeton, and flixweed dominated in the vicinity of a large burn west of County Road 19 along a portion of the SWIP corridor in Butte Valley. Other areas on the eastern side of the Egan Range in Steptoe Valley that are now dominated by weeds may also have been previously burned.

Although many areas are now infested by weed populations, several of the surveyed areas currently have relatively low weed coverage. One such area is a portion of the proposed water pipeline ROW that

contains stands of very large, mature basin big sagebrush with minimal weed cover. This area was also unique in that it supported pygmy rabbits (see Section 3.5.4.3, *Descriptions of Special Status Species*). Much of the wetland area near Duck Creek along both the Proposed Action and Alternative 1 rail spur ROWs is also characterized by low densities of noxious or invasive weeds.

The proposed ROW for the transmission lines contains dense populations of invasive weed species because of past wildfires, mining activities, the presence of multiple access roads, and grazing use. However, the portion of the proposed transmission line corridor that crosses the Egan Range does not have a high density of noxious or invasive weeds, except for some areas along roads or trails that exhibit some level of infestation. Cheatgrass was the dominant invasive species seen within this portion of the transmission line ROW.

Further detail on the location and density of noxious and invasive weed species is provided in Chapter 4 as well as in the BLM Noxious and Invasive Weed Risk Assessment (Appendix J, *Biological Resources Supplemental Information*).

3.5.3 Wildlife and Fisheries Resources

The Great Basin is a cold, semi-arid desert where the stratification of land forms creates a uniquely diverse landscape. The habitats formed from the lowest valley playas to the highest alpine mountains provide distinct niches for wildlife. According to the Nevada Department of Wildlife (NDOW), Nevada is home to 161 species of mammals, 173 fish species, 24 species of amphibians, 78 species of reptiles, and 456 bird species (NDOW, 2004a). Most of the proposed project area

is located in Steptoe Valley, which is home to a diverse assemblage of wildlife and wildlife habitat. This section addresses wildlife and wildlife habitats that occur or have the potential to occur in the project area. Species with Special Status (listed as Threatened, Endangered, Candidate, or Sensitive by government agencies) are addressed in Section 3.5.4, *Threatened, Endangered, Candidate, and Sensitive Species*.

3.5.3.1 Regulatory Framework

3.5.3.1.1 Nevada Wildlife Management

Wildlife management in Nevada is under the jurisdiction of NDOW. Regulations regarding protected and unprotected wildlife species are established under Nevada Administrative Code Chapter 503. NAC Chapter 504 describes the Wildlife Management Areas (WMAs) managed by NDOW throughout the state. The closest WMA to the project area is the Steptoe Valley WMA, located south of Ely. NDOW also regulates activities that would “alter stream system or watershed to detriment of wildlife habitat” (Nevada Administrative Code 504.520). Any activity that would “obstruct, damage, diminish, destroy, change, modify or vary the natural shape and form of a stream system or its banks by any type of construction or other activity that is detrimental to the wildlife habitat” requires an NDOW permit (Nevada Administrative Code 504.520).

3.5.3.1.2 Migratory Bird Treaty Act (MBTA) of 1918 (as amended)

The Migratory Bird Treaty Act of 1918 (MBTA) (16 USC 703) established a federal prohibition, unless permitted by regulations, “to pursue, hunt, take, capture, kill, attempt to take, capture or kill, possess any migratory bird, or part, nest, egg of such bird listed in wildlife

protection treaties among the United States and Great Britain (on behalf of Canada), Mexico, Japan, and the former U.S.S.R.” Baiting and poisoning these species is also prohibited under this legislation. Species protected under the MBTA that may potentially occur in the project area are included in the impact assessment in Chapter 4.

As required by Executive Order 13186 (Protection of Migratory Birds, January 2001), the BLM developed a draft Memorandum of Understanding with the U.S. Fish and Wildlife Service (FWS) in 2001, which emphasizes a collaborative approach to migratory bird conservation, in cooperation with other agencies and organizations. This was further reinforced by the FWS Director’s Order 146 of September 12, 2002.

3.5.3.1.3 Federal Land Policy and Management Act (FLPMA)

As amended, FLPMA provides direction to the BLM relative to managing for the conservation of biological diversity on public lands. According to the BLM and Office of the Solicitor (2001), this act mandates that public lands are managed in a manner that will:

- Protect the quality of scientific, scenic, historical, ecological, environmental, air and atmospheric, water resource, and archaeological values
- Where appropriate, will preserve and protect certain public lands in their natural condition
- Provide food and habitat for fish and wildlife and domestic animals
- Provide for outdoor recreation and human occupancy and use

In addition, the Principles of Biodiversity Conservation (Council on Environmental

Quality, 1993) directs the BLM to “minimize fragmentation, promote native species, and avoid introducing non-native species, and to protect rare and ecologically important species.”

The BLM works with NDOW to monitor, protect, and enhance wildlife habitat on federally managed lands in the project area. The BLM’s Proposed Ely District Resource Management Plan (BLM, 2007) provides guidelines and standards for habitat management. The BLM Proposed Ely District Resource Management Plan includes habitat management plans for the following:

- Management of crucial habitat for Threatened, Endangered, or Sensitive species where present
- Management of big game ranges to provide habitat for reasonable numbers of animals over the long term
- Improvement of riparian, wetland, and aquatic habitats
- Management of other habitats to meet needs of upland game and non-game animals

3.5.3.2 Analysis Area and Methodology

This section addresses methods used to describe common wildlife with the potential to occur in the project area for the proposed transmission lines, distribution lines, water pipelines, well sites, substations, power plant sites, rail spur ROWs and connection to the NNR north to Shafter, and all other ancillary facilities that would be constructed as part of the proposed project. Identification of species that have the potential to occur in the project area came from a variety of sources, including BLM and NDOW species lists; animals of Nevada fact sheets

online; Nevada Natural Heritage Program (NNHP); BLM and NDOW data for raptors, greater sage-grouse, big game, springs (BLM only), and wildfire (BLM only); the FWS; and observations made during biological field surveys conducted in 2005 and 2006.

Habitat assessments for wildlife species in this EIS focus on the ability of a landscape to provide cover, forage, water, and space requirements. Habitat assessments were based on field observations, vegetation community mapping, BLM fire data, and other existing resource information provided by NDOW, FWS, and BLM. Signs and occurrences of common wildlife species were recorded during vegetation community field studies and weed inventories. Species lists provided by the NDOW were examined prior to field surveys to familiarize field staff with wildlife species that may occur in the proposed project area.

During surveys conducted in the project area in May, June, and September 2005 and incidental to all other surveys described below, specialists recorded the occurrence of all wildlife species and sign within the proposed project area.

Surveys for specific wildlife were conducted for greater sage-grouse (*Centrocercus urophasianus*) in April 2005 and ferruginous hawks (*Buteo regalis*) in May 2005. Surveys conducted for noxious weeds in June 2005 also recorded areas with potential pygmy rabbit habitat. Surveys were also conducted in aquatic habitats that have the potential to be impacted by the proposed project. These surveys focused on the identification of endemic springsnails, relict dace, and the northern leopard frog. These surveys are discussed further in Section 3.5.4, *Threatened, Endangered, Candidate, and Sensitive Species*.

3.5.3.3 Wildlife Habitats

The 10 different vegetation cover types found in the project area (see Section 3.5.1.1, *Vegetation Communities*) were combined into five general wildlife habitat types for the purpose of describing the affected environment for wildlife. Wildlife habitat types include Sagebrush and Mixed Shrublands, Greasewood and Salt Desert Scrub, Wetlands/Aquatic, Disturbance/Agriculture, and Pinyon-Juniper Woodlands. Appendix J, *Biological Resources Supplemental Information*, lists wildlife observed or likely to occur within the various habitat types in the project area. Appendix J is not a comprehensive list of potentially occurring species, but includes the species observed or most likely to occur on a regular basis in the project area. The following text describes the five wildlife habitat types and commonly associated wildlife species.

3.5.3.3.1 Sagebrush and Mixed Shrublands Habitat Type

The Sagebrush and Mixed Shrublands habitat type provides habitat for approximately 100 bird species and 70 mammal species (Braun et al., 1976; Trimble, 1989). Sagebrush habitat is considered a Priority A habitat under the *Coordinated Implementation Plan for Bird Conservation in Nevada* (Nevada Steering Committee Intermountain Joint Venture, 2005). The Sagebrush and Mixed Shrublands habitat type includes the Big Sagebrush Shrubland, Mixed Great Basin Shrubland, Low Scrub, and Montane Sagebrush Shrubland communities.

These habitats may be dominated by sagebrush, but other shrub species such as spiny hopsage, shadscale, budsage, snakeweed, or winterfat may also be present. Species that require sagebrush for

some part of their life cycle are “sagebrush obligates.” At least eight vertebrate species are considered sagebrush obligates: the greater sage-grouse, pygmy rabbit (*Brachylagus idahoensis*), pronghorn antelope (*Antilocapra Americana*), sage thrasher (*Oreoscoptes montanus*), sage sparrow (*Amphispiza bellii*), Brewer’s sparrow (*Spizella breweri*), sagebrush lizard (*Sceloporus graciosus*), and sagebrush vole (*Lagurus curtatus*) (Paige and Ritter, 1999). All but the sagebrush vole were identified in the project area during biological field surveys. Suitable habitat exists for the vole and other small mammals associated with the Sagebrush and Mixed Shrublands habitat type.

Species such as pronghorn, pygmy rabbit, and greater sage-grouse feed exclusively on sagebrush in the winter when it is the only green forage available. Mule deer (*Odocoileus hemionus*) and greater sage-grouse use taller sagebrush for cover during the winter months (Dealy et. al., 1981). Sagebrush also provides cover for mule deer, fawns, antelope kids, elk calves, greater sage-grouse, and nesting cover for a variety of shrub-nesting species (Paige and Ritter, 1999).

Sagebrush habitats and their associated flora and fauna have been impacted and fragmented over time because of agricultural conversion, development, invasion of non-native plant species, extensive grazing, changes in fire regimes, and sagebrush eradication programs (Paige and Ritter, 1999). These impacts have altered the ecology, vegetation communities, and natural disturbance patterns of the sagebrush ecosystem.

Sagebrush habitat is the dominant habitat in much of Steptoe Valley and Butte Valley. This habitat is present along the alternatives for the proposed transmission

line corridor, water pipeline alignment, distribution lines, portions of the rail spur development, substation locations, well sites, and power plant sites. Several areas of especially high-quality sagebrush habitat (with little invasive weed cover) occur on and near the water pipeline ROW just west of the Alternative 1 power plant site and along the rail spur location.

3.5.3.3.2. Greasewood and Salt Desert Scrub Habitat Type

The primary shrub species in the Greasewood and Salt Desert Scrub habitat type are greasewood, shadscale, winterfat, budsage, horsebrush, fourwing saltbrush, and Mormon tea. Associated grasses include Indian ricegrass and salt grass (NNHP, 2004). Vegetation communities in this habitat type include Greasewood Dunes, Greasewood Playa, and Salt Desert Scrub. The Salt Desert Scrub habitat can support some or all of the habitat requirements of sagebrush breeders like sage thrashers, sage sparrow, and Brewer’s sparrow. This cover type provides habitat for ground squirrels (*Spermophilus* spp.), cottontails (*Sylvilagus nuttallii*), horned lizards (*Phrynosoma platyrhinos*), dark and pale kangaroo rats (*Dipodomys* spp.), and other wildlife species. Salt Desert Scrub habitat provides winter cover habitat for a variety of wildlife species. Pronghorn were observed in this cover type during biological field investigations in 2005.

This habitat type is primarily found in Steptoe Valley along the proposed water pipeline alignment, distribution lines, well, and pumping sites. Salt Desert Scrub habitat in the project area often coincides with the floodplain of Duck Creek and other drainages in Steptoe Valley and lies on the boundary of some wetlands along the Alternative 1 rail spur route.

3.5.3.3.3 Pinyon-Juniper Woodlands Habitat Type

The Pinyon-Juniper Woodlands habitat type provides cover for a variety of raptor species, including ferruginous hawk, golden eagle (*Aquila chrysaetos*), red-tailed hawk (*Buteo jamaicensis*), prairie falcon (*Falco mexicanus*), turkey vultures (*Cathartes aura*), kestrels (*Falco sparverius*), and Swainson's hawk (*Buteo swainsoni*), among others. The Pinyon-Juniper Woodlands habitat type also provides forage and cover for mule deer, pronghorn, bushy-tailed woodrats (*Neotoma cinerea*), western fence lizards (*Sceloporus occidentalis*), spotted towhees (*Pipilo maculatus*), black-throated gray warblers (*Dendroica nigrescens*), mountain chickadees (*Poecile gambeli*), black-billed magpies (*Pica hudsonia*), and a number of other avian and small mammalian species.

The project area encompasses Pinyon-Juniper Woodlands habitat along portions of the proposed transmission line ROW and substation alternatives. This habitat type dominates portions of the SWIP corridor in the Egan Range.

3.5.3.3.4 Wetlands/Aquatic Habitat Type

The Wetlands/Aquatic habitat type includes the Alkali Meadow and Wetland vegetation communities associated with the floodplain of Duck Creek between Bassett Lake and Goshute Valley and numerous springs in Steptoe Valley and portions of the Egan Range. Wetlands are important habitats for waterfowl and numerous other wildlife species in Nevada (NDOW, 2005b). Wetlands provide a water source for big game such as pronghorn and mule deer, as well as other species like the greater sage-grouse. Wetlands associated with rivers or ephemeral and perennial alkaline lakes

concentrate colonies of gulls (*Larus* spp.), Wilson's phalarope (*Phalaropus tricolor*), white-faced ibis (*Plegadis chihi*), eared grebe (*Podiceps nigricollis*), and American avocet (*Recurvirostra Americana*). Wetlands are very important for migrants (for example, western snowy plover [*Charadrius alexandrinus*] and long-billed curlew [*Numenius americanus*]), and for breeding species such as the least bittern (*Ixobrychus exilis*) (Nachlinger et al., 2001). Wetlands are considered a Priority A habitat under the *Coordinated Implementation Plan for Bird Conservation in Nevada* (Nevada Steering Committee Intermountain Joint Venture, 2005).

Field observations during May and June 2005 revealed use of the wetlands by several pairs of waterfowl, waterbirds, and shorebirds. Additional species may be found in these areas during spring and fall migration. During the May-June 2005 fieldwork, the Duck Creek floodplain in the vicinity of the proposed rail spur had a substantial amount of surface water that provided a diversity of wetland habitat. The area provided the largest amount of open water wildlife habitat north of Bassett Lake in Steptoe Valley. The primary wildlife species identified in wetlands in the project area during biological surveys were the long-billed curlew, American avocet, northern pintail (*Anas acuta*), mallard (*Anas platyrhynchos*), sandhill cranes (*Grus Canadensis*), and red-winged blackbirds (*Agelaius phoeniceus*). Steptoe Valley provides a corridor for migratory species. The wetlands located in these areas provide habitat for migratory species (Williams, 2005; Crookshanks, 2005).

The primary perennial aquatic habitat in the vicinity of the project area is Duck Creek, which flows out of the Schell Creek Range near the Alternative 1 power

plant site and then north through Steptoe Valley (see Section 3.3.3, *Surface Water Features*). Portions of Duck Creek, especially those north of the Cherry Creek Road, do not have surface water most summers. Many other intermittent/ephemeral streams drain the Egan Range and Schell Mountain Range.

Approximately 45 natural springs are located in Steptoe Valley in the general region of the proposed project. Most of the springs are located along the western edge of Steptoe Valley and appear to provide permanent or seasonal surface water for wildlife. In addition, several small intermittent or seasonally inundated springs and drainages exist in the Egan Range and southern Butte Valley. In many cases, these springs support associated wetland vegetation communities. These springs contain potential habitat for a number of springsnails that are often endemic to the State of Nevada or Steptoe Valley. Signs of greater sage-grouse were noted near several of the springs along the western edge of Steptoe Valley. Some of the perennial springs provide critical habitat for species like the BLM-Sensitive and state-protected relict dace (*Relictus solitarius*) and amphibian species such as the northern leopard frog (*Rana pipiens*), along with numerous wildlife species. Additional details on aquatic biota associated with the springs are presented in Section 3.5.4, *Threatened, Endangered, Candidate, and Sensitive Species*.

3.5.3.3.5 Disturbance/Agriculture Habitat Type

This habitat type includes areas that have been altered by human use and/or development along with natural disturbance such as wildfire. Habitats disturbed by development, agriculture, heavy grazing, gravel pits, or wildfire are included under this category. Lands used

for agricultural purposes are located entirely on private lands within the project area. Areas that have been disturbed by wildfire have revegetated either naturally or by seeding, and may be dominated by a variety of weeds or native low-growing shrub species representative of the Low Scrub vegetation community type, including winterfat and snakeweed. These shrubs may be co-dominant in a mix that often also includes grasses such as squirreltail or cheatgrass. Sagebrush is largely missing from areas previously burned or heavily grazed. Some wildlife have adapted to use these areas for basic cover and transition habitat. Sandhill cranes, other avian species, and small mammals are commonly found foraging in agricultural fields.

3.5.3.4 Common Wildlife

Common wildlife includes species that are relatively abundant or have not been designated as species of special concern by the BLM, NDOW, or FWS. Species listed as Threatened, Endangered, Candidate, or Sensitive by the BLM, FWS, and NDOW are described in Section 3.5.4, *Threatened, Endangered, Candidate, and Sensitive Species*.

3.5.3.4.1 Mammals

The primary predator observed in the project area was the coyote (*Canis latrans*). Coyotes were observed along various sections of the proposed water supply system alignment. Coyote sign was observed throughout the project area in all cover types. Coyotes are known to inhabit all community types and have adapted to human development (NDOW, 2005c). Kit fox (*Vulpes macrotis*) and gray fox (*Urocyon cinereoargenteus*) are also known to inhabit the project area. The portion of the proposed transmission line that spans the Egan Range contains rocky

terrain suitable for bobcat (*Lynx rufus*) foraging and denning habitat.

Mountain lions (*Felis concolor*) are a predatory Nevada big game species that can be found in a wide variety of habitat types but prefer dense cover on rocky, rugged terrain (NDOW, 2005d). In the project area, the Egan Range/Butte Valley portion of the proposed transmission line corridor provides suitable habitat for the lion. Mountain lion scat was found along County Road 17 on the west entrance to Butte Valley. The presence of mule deer, antelope, and small mammals in the project area provides prey for mountain lions. Rocky cliffs and ledges in the Egan Range provide potential denning habitat for this species.

The project area contains suitable habitat for lagomorphs such as the black-tailed jackrabbit (*Lepus californicus*), mountain cottontails, and pygmy rabbits (the latter species is addressed in Section 3.5.4.3, *Descriptions of Special Status Species*). All three of these species were observed during biological field surveys. Black-tailed jackrabbits and cottontails were observed in the Pinyon-Juniper, Sagebrush Shrublands, and Salt Desert Scrub cover types. Pygmy rabbits prefer sandy deep soils in big basin sagebrush stands. Several pygmy rabbits were observed on the southern end of the Alternative 1 proposed water pipeline route.

A number of other small mammals occur or have the potential to occur in the project area. Small mammals that occur in mountainous or rocky areas include the rock squirrel (*Spermophilus variegates*), least chipmunk (*Tamias minimus*), and Richardson's ground squirrel (*Spermophilus elegans nevadensis*). Richardson's ground squirrel can also be found in Sagebrush and Mixed Shrublands habitats along with the white-tailed

antelope squirrel (*Ammospermophilus leucurus*), golden-mantled ground squirrel (*Spermophilus lateralis*), Piute (Great Basin) ground squirrel (*Spermophilus mollis*), and Townsend's ground squirrel (*Spermophilus townsendii*). The project area contains potential habitat for badgers (*Taxidea taxus*) and pygmy shrews (*Sorex minutus*). No badgers were observed during field surveys. According to NNHP records, the project area contains potential habitat for a minimum of eight species of bats, which are discussed in Section 3.5.4.3, *Descriptions of Special Status Species*.

Mule deer and pronghorn are the two primary big game species that occur in the project area. Steptoe and Butte Valleys act as migration corridors for big game. Migration/movement corridors are also found where the proposed distribution line crosses U.S. 93.

According to NDOW, the project area contains crucial winter range, winter range, overall range, and intermediate range for mule deer. Crucial winter range lies along most of the proposed transmission line corridor, the distribution lines, the Alternative 1 power plant site, and the southern end of the Alternative 1 water pipeline route. Winter range lies east of U.S. 93. A portion of the transmission ROW in Butte Valley is mapped as winter range. Crucial summer range mapped by NDOW occurs east of County Road 29 in the Schell Creek range well outside of the project area. Mule deer were observed in both Steptoe Valley and Butte Valley during field surveys. Mule deer sign was present along the Egan Range portions of the transmission lines ROW and near all other project feature sites.

The project area is considered year-round range for pronghorn. Multiple herds of pronghorn were observed during

biological site visits in May, June, and July 2005. Pronghorn were observed in Butte Valley, Steptoe Valley, and at the base of the Egan Range. One newborn fawn was observed along the western toe slope of the Egan Range in Sagebrush and Pinyon-Juniper habitats. Data were not available that delineate pronghorn fawning grounds, but it is assumed these areas exist within the project area based on the fore-mentioned sighting and the presence of suitable habitat. According to Einarsen (1948), traditional pronghorn fawning areas are described in terms of terrain characteristics and vegetation height. Optimal fawning grounds were characterized as being situated in a basin, surrounded by a low ridge of hills, where standing vegetation averaged 9 to 18 inches in height.

The pronghorn fawning period is May through June. The greatest densities of pronghorn in the Great Basin occur between 4,000 and 6,000 feet elevation (Yoakum, et al., 1996). Characteristics common to preferred pronghorn ranges in the Great Basin include: ground cover averaging 50 percent live vegetation; a variety of upland species including grasses, forbs, and shrub species; and succulent plants for spring and wet summers (USFS, 2006).

Elk (*Cervus elaphus*) were not observed during biological field investigations. Elk habitat mapped by NDOW is located north of the project area towards Goshute Lake. BLM has mapped elk habitat in the northern end of White Pine County in portions of Butte Valley, the Egan Range, and an area east of U.S. 93 near the county line. Conversations with NDOW biologists indicated that elk are known to migrate and forage in the project area (Foree, 2006). Crucial habitats for elk are not found within the project area. No elk were

seen during field surveys and no existing data from BLM and NDOW have recorded occurrences of elk in the proposed project area.

3.5.3.4.2 Birds

Raptors

The project area contains suitable habitat for a number of raptor species.

Hawkwatch International (2005) conducted raptor surveys at 36 stations in the Egan and Schell Ranges surrounding Steptoe Valley during fall 2004 and spring 2005. Raptor flight-lines were documented in the Egan Range, particularly near the ridgelines. During fall migration, 12 raptor species were detected in the Ely area studied by Hawkwatch International (2005). The fall migration volume through the Ely area is much less than in the Goshute area (by far the largest volume site in the interior West). At 3.9 birds per hour, the Ely area is also less than at other Hawkwatch International monitoring sites in the western U.S. that range from 4.9 to 22.2 birds per hour. Consistent with other western migration-monitoring sites, sharp-shinned hawks, Cooper's hawks, red-tailed hawks, and American kestrels were the most commonly detected species during the fall. Golden eagles were also represented in relatively high numbers.

The spring survey yielded a total combined species tally of 436 migrating raptors of 17 species (an overall passage rate of 2.4 birds per hour). Similar to the fall, turkey vultures, sharp-shinned hawks, Cooper's hawks, red-tailed hawks, golden eagles, and American kestrels were the most abundant and ubiquitous species. Total spring counts of sharp-shinned hawks, Cooper's hawks, and American kestrels were all more than 50 percent less than in the fall, whereas spring counts of turkey vultures, red-tailed hawks, and

golden eagles were all substantially higher than in the fall.

During biological field surveys conducted by EDAW in 2005, five raptor species were observed in the area of analysis. A pair of northern harriers (*Circus cyaneus*) was observed near wetland areas, agricultural areas, and mixed shrublands in Steptoe Valley. No northern harrier nests were found during any of the field visits in the project area. Several turkey vultures were seen throughout all portions and habitat types in the project area. A prairie falcon was observed perching on a juniper tree in Butte Valley just south of the proposed transmission line corridor. A golden eagle pair was also seen on multiple occasions in both Steptoe Valley and Butte Valley. This pair of golden eagles is likely nesting in the Egan Range; however, no eagle nests were found in any portion of the project area. American kestrels were seen throughout Butte Valley and at the base of the west side of the Egan Range. Ferruginous hawk habitat exists along the Pinyon-Juniper to Sagebrush Shrublands transition zone. This species is of special concern for the BLM and NDOW and is discussed further in Section 3.5.4.3, *Descriptions of Special Status Species*. No ferruginous hawks were observed in or adjacent to the project area; however, suitable habitat exists within the project area.

The Egan Range contains large cliffs, rocky outcrops, and pinyon juniper woodlands that could provide nesting opportunities for raptor species listed above as well as red-tailed hawk, Swainson's hawk, Cooper's hawk (*Accipiter cooperi*), peregrine falcon (*Falco peregrinus*), and others. Three abandoned nests were observed in juniper trees at the transition zone between Sagebrush and Pinyon-Juniper cover types

on the west side of the Egan Range. One of the nests was unidentified and the other two were potentially ferruginous hawk nests based on size and location (juniper stringers). The Egan Resource Management Plan (BLM, 1984b) states that active raptor nests adjacent to areas proposed for vegetation conversion will be protected.

Shorebirds and Waterfowl

The project area contains a large wetland complex composed of wet meadow and multiple ponds that are associated with a branch of Duck Creek. This wetland complex is at its greatest extent and isolation at a location south of the Proposed Action rail spur site. The wetlands at the rail spur site are narrower and not as complex and do not include open ponds. The wetland complex hosts migratory species as well as resident avian and mammal species (Crookshanks, 2005). Duck Creek and the natural springs in the Steptoe Basin provide habitat for waterfowl and shorebirds during migration and year-round, particularly in wet years such as 2005. Some of the species observed during field surveys included sandhill cranes, mallards, American avocets, Northern pintails, and long-billed curlews.

Upland Game Birds

Upland game birds identified in the project area included mourning dove (*Zenaida macroura*) and greater sage-grouse. The greater sage-grouse is discussed in more detail in Section 3.5.4.3, *Descriptions of Special Status Species*. Mourning doves were observed in various portions of the project area along roadsides, and calls were heard near agricultural properties outside of the project area.

Other Birds

The project area contains habitats for a number of avian species. Common nighthawks (*Chordeiles minor*) were heard and observed on the east side of Butte Valley just east of County Road 19.

Common ravens (*Corvus corax*) were observed throughout the project area and, together with western meadowlark (*Sturnella neglecta*), were the most frequently observed birds in the project area. Based on the diversity of habitats present, the project area likely supports many of the 140 bird species that are reported from the Steptoe Valley WMA, located south of Ely.

3.5.3.4.3 Amphibians

Because of the above-average precipitation that fell in Steptoe Valley in 2005, a number of the intermittent streams that drain the surrounding mountains combined surface water during the spring and early summer and thus provided habitat for native amphibians. The only amphibian species observed in 2005 were the northern leopard frog (*Rana pipiens*) and spadefoot toad (*Scaphiopus hammondi*). Spadefoot toads were observed at one spring in Steptoe Valley, while northern leopard frogs were documented at five springs, along an irrigation ditch flowing from Grass Spring, and in a small stream drainage south of the Alternative 1 power plant site. One other species, the Pacific tree frog (*Pseudacris regilla*), occurs in the project area but none were observed during field surveys.

3.5.3.4.4 Reptiles

Five reptile species were seen in the project area. A Great Basin gopher snake (*Pituophis catenifer deserticola*) was observed near a spring outside of the project area. Several western rattlesnakes (*Crotalus viridis lotus*) were observed off

of County Road 19 in Butte Valley. A large number of western fence lizards, sagebrush lizards (*Sceloporus graciosus*), and northern short-horned lizards were observed throughout the project area. The western fence lizards, short-horned lizards, and sagebrush lizards were found primarily in sagebrush, but were also seen in snakeweed, greasewood, and sagebrush mix.

3.5.3.4.5 Fish

Based on information provided by NDOW, the only native species of fish in the project area is the relict dace (Crookshanks, 2005). Relict dace are discussed further in Section 3.5.4.3, *Descriptions of Special Status Species*. Non-native fish species known to occur in Duck Creek or the other aquatic habitats in the project area include northern pike (*Esox lucius*), largemouth bass (*Micropterus salmoides*), and a species of chub (likely the non-native Utah chub [*Gila atraria*]). Until approximately 5 years ago, NDOW released rainbow trout (*Oncorhynchus mykiss*), brook trout (*Salvelinus fontinalis*), and tiger trout (*Salmo trutta x Salvelinus fontinalis*) in Tailings Creek (Crookshanks, 2005). This practice was ended because of water management changes and invasion by northern pike.

During May through June 2005, Duck Creek in the vicinity of the Proposed Action rail spur was overflowing its banks and flooding the nearby wetlands. During the September 22, 2005, aquatic surveys, the wetted channel of Duck Creek in the general vicinity of the proposed rail spur crossing was about 8 feet wide and held water that was primarily 8 to 12 inches deep but had pools that were over 24 inches deep. During drier years, the channel may have substantially less aquatic habitat available. The channel has

dense submerged vegetation including *Ceratophyllum* sp. and *Potamogeton* spp. During the September survey, several 4- to 8-inch-long northern pike were observed in Duck Creek near the proposed rail spur site. Relict dace were noted at two springs during surveys of 45 different springs in Steptoe Valley; one was at a previously known site and one was unknown previously. Neither relict dace site was near proposed project facilities or within the well-fields. Carp, goldfish, and sunfish were documented in the Collar and Elbow Spring east of Goshute Lake.

3.5.3.4.6 Invertebrates

During the 1990s, surveys at several Steptoe Valley springs found several endemic species of the family Hydrobiidae. These springsnails are gill-breathing aquatic or semi-aquatic snails restricted to waters of unquestioned permanence and stability. Aquatic snails of all taxa combined were documented in 39 of 45 springs in Steptoe Valley surveyed in 2005. They included several species of pulmonates (*Physa* sp., *Lymnaea* sp., *Gyraulus* sp., and *Frasseria* sp.) and one species of springsnail (*Pyrgulopsis serrata*). Springsnails, which are of greatest concern because of their endemism and reliance on specific spring habitat conditions, were documented in 10 of the springs in the western portion of Steptoe Valley during the 2005 surveys (Sada, 2006). These springs were generally larger (longer springbrooks and greater discharge) than the average size of springs surveyed within Steptoe Valley, but springbrooks were comparatively narrow. These springsnail populations were previously undocumented. Prior to these surveys, *Pyrgulopsis serrata* was previously known to occur only in three springs, all of which occur along the west side of Steptoe Valley and within 15 miles

of the northernmost spring (Collar and Elbow Spring) sampled during 2005 (Hershler, 1998).

3.5.4 Threatened, Endangered, Candidate, and Sensitive Species

This section addresses special status wildlife and plant species that occur or have suitable or potential habitat in the White Pine Energy Station project area. The FWS, NDOW, and NNHP were contacted to obtain information on local populations or potential habitat that could occur in the project area. BLM databases were examined for special status species occurrence data. Data adequacy reviews showed that recent data within the project area were not available for some species. As a result, species-specific surveys were conducted in summer 2005. These surveys included aerial surveys for the greater sage-grouse; ground-based surveys for the ferruginous hawk; aquatic surveys for springsnails, northern leopard frog, and relict dace; and habitat assessments for the pygmy rabbit and special status plants.

The term “special status species” as used in this EIS includes any species that is federally listed as Endangered, Threatened, or Proposed to be listed or is a Candidate for listing under the ESA; Nevada BLM-Sensitive Species; and State Threatened, Endangered, or Species of Concern. These wildlife, fish, and plant species are protected under the regulations and policies described in the following text.

3.5.4.1 Regulatory Framework

3.5.4.1.1 Federal Endangered Species Act

The Federal ESA gives the FWS authorization to protect those species that are listed as threatened, endangered, and

proposed for listing on both private and public lands. The FWS has authority over any endangered, threatened, or proposed species or designated critical habitat occurring within the project area. Any time a proposed project may affect a federally listed species, federal consultation is required under Section 7 of the ESA. The ESA prohibits the "take" of any federally listed species. "Take" includes killing, harming, or harassing any federally listed species. The FWS interprets "harm" to include significant habitat modification.

3.5.4.1.2 The Federal Land Policy and Management Act (FLPMA)

FLPMA direction to the BLM relative to managing for the conservation of biological diversity on public lands was described in Section 3.5.3.1.3, *Federal Land Policy and Management Act (FLPMA)*.

3.5.4.1.3 Bald and Golden Eagle Protection Act of 1940

This act prohibits the take; possession; selling; purchasing; bartering; offer to sell, purchase, or barter; transport; export or import; at any time or in any manner any bald eagle commonly known as the American eagle or any golden eagle, alive or dead, or any part, nest, or egg thereof of the foregoing eagles. The term "take," as defined by this act, includes pursue, shoot, shoot at, poison, wound, kill, capture, trap, collect, molest, or disturb.

3.5.4.1.4 Migratory Bird Treaty Act (MBTA) of 1918 (as amended)

The MBTA was described in Section 3.5.3.1.2, *Migratory Bird Treaty Act*.

3.5.4.1.5 BLM Policies

As part of their efforts to protect ecological values, including the protection and enhancement of wildlife forage and habitat, the BLM confers special status to species designated by the State as Threatened or Endangered, BLM-Sensitive Species, and those species listed under the ESA. It is BLM policy to use all methods and procedures necessary to improve the condition of Special Status Species and their habitats to a point where their special status recognition is no longer warranted. Sensitive species are taxa that are not already included as BLM Special Status Species under the ESA or State regulations. BLM's Nevada Sensitive Species list identifies 246 species of concern, including 31 mammals, 33 birds, 25 fish, 26 snails, 25 fish, and 106 plants. The Sensitive species designation is normally used for species that occur on BLM-administered lands for which the BLM has the capability to significantly affect the conservation status of the species through management. The BLM 6840 manual provides for BLM to implement management plans that conserve candidate and Bureau-sensitive species and their habitats, and to ensure that actions authorized, funded, or carried out by the BLM do not contribute to the need for the species to become listed under the provisions of the Endangered Species Act. The manual also provides factors by which a native species may be listed as "sensitive." Sensitive species are afforded the same level of protection as federal Candidate species (BLM Manual 6840.06 C, that is "to ensure that actions authorized, funded, or carried out do not contribute to the need for the species to become listed").

3.5.4.1.6 State of Nevada

The State of Nevada provides protection under the authority of NRS 527.260-527.300 for 24 plant species listed as critically endangered and threatened with extinction as well as all species of cacti and yucca. The state list of plants maintained under NRS 527 is administered by the Nevada Division of Forestry. NDOW has a list of "protected" wildlife species, which are designated because of a reduction in all or portions of their range within the State of Nevada. These species are designated and protected under the authority of NAC 501.100-503.104. The State of Nevada has listed 33 wildlife species as either Protected or Sensitive. State-listed species are treated as federal Candidate species whenever found on BLM property.

3.5.4.2 Analysis Area and Methodology

The area of analysis consists of those locations where special status species may potentially occur within the proposed project areas for the transmission lines, distribution lines, water pipelines, well sites, substations, power plant sites, rail spur ROWs, NNR upgrade to Shafter, and all other ancillary facilities that may be constructed as part of the proposed project. Species with the potential to occur within the project area were identified from various sources, including BLM and NDOW species lists, Animals of Nevada fact sheets online, NNHP data requests, the FWS letter received on July 19, 2004 (Appendix K, *U.S. Fish and Wildlife Service Correspondence*), and observations made during biological field surveys in 2005.

Surveys for special status species were as follows:

- Greater sage-grouse (*Centrocercus urophasianus*). Aerial surveys were conducted in April 2005.
- Ferruginous hawks. Nest surveys were conducted in May 2005.
- Aquatic species (springsnails, northern leopard frogs, relict dace). Surveys were conducted the last 2 weeks of September 2005.

Survey and habitat assessment results were used to evaluate potential direct and indirect effects to all special status species that potentially occur in the project area.

Ground water modeling was used to predict the extent of drawdown resulting from the Proposed Action and Alternative 1 pumping and to evaluate potential indirect effects of project operations on aquatic spring habitats. Approximately 45 springs in Steptoe Valley were identified as occurring in the analysis area and were investigated (see Sections 3.4 and 4.4, *Ground Water Resources*). These springs were examined to determine if endemic springsnail species of concern were present. Habitats of special status species that may not lie within the project area, but which may be indirectly impacted or impacted as a result of cumulative effects, are also included in this analysis.

In addition to special status species surveys, habitat assessments were conducted for BLM special status plant species and for the BLM and State Sensitive pygmy rabbit. Habitat assessments focused on the ability of a landscape to provide cover, forage, water, and space requirements. Habitat assessments were based on field observations, vegetation community mapping, presence and extent of existing disturbance, BLM fire data, and other existing resource information provided by NDOW, FWS, and BLM. Signs and

occurrences of special status species were recorded during vegetation community field studies and weed inventories. Species lists provided by NDOW, BLM, and FWS were examined prior to field surveys to familiarize field staff with species of special concern that may occur within the project area.

3.5.4.3 Descriptions of Special Status Species

3.5.4.3.1 Federally Listed Species in the Project Area

The FWS was contacted to obtain information on Threatened, Endangered, Proposed, and Candidate species listed or proposed for listing under the ESA that have the potential to occur in the project area. In correspondence dated July 19, 2004, the FWS named two federal species of concern, the Threatened bald eagle (*Haliaeetus leucocephalus*) and the Candidate yellow-billed cuckoo (*Coccyzus americanus*), as having the potential to occur in the project area. The bald eagle has full protection under the ESA and is also protected under the Bald and Golden Eagle Protection Act of 1940 and the MBTA. The yellow-billed cuckoo is a Candidate species and, therefore, does not receive legal protection under the ESA. However, it is protected under the MBTA. A Biological Assessment (BA) was prepared to address the bald eagle and yellow-billed cuckoo and was submitted to the FWS as part of the ESA Section 7 consultation process.

The FWS also named the State Threatened Monte Neva paintbrush (*Castilleja salsuginosa*), the BLM and NDOW sensitive greater sage-grouse (*Centrocercus urophasianus*), and the pygmy rabbit (*Brachylagus idahoensis*), which is currently being petitioned for listing on the ESA, as species of special concern that have the potential to occur in the project area. The FWS scoping letter, received in 2004, also

expressed concerns for macroinvertebrates that may occur in springs and springbrooks (springsnails, caddisflies, beetles, true bugs, and crustaceans).

Bald Eagle

At the time the Draft Environmental Impact Statement (DEIS) was published, the bald eagle was listed as a Threatened species under the ESA. The FWS published the final rule to delist the bald eagle on July 9, 2007 (72 FR 37346-37372). On August 9, 2007, following a 30-day public comment period, the FWS removed the bald eagle from the federal list of Threatened and Endangered species. While the bald eagle is no longer listed under the ESA, it continues to be protected under the Bald and Golden Eagle Protection Act of 1940 and the MBTA. Given its status as a listed species at the time of the DEIS, and its continued protection under these other laws the bald eagle discussion was modified but retained in this section of the FEIS.

White Pine County, Nevada, is located in what was Recovery Unit 36 (Antelope Valley) of the Pacific States Bald Eagle Recovery Region (FWS, 1986). There were no breeding recovery goals for nesting bald eagles in Unit 36. The primary management direction identified in the Pacific States Bald Eagle Recovery Plan for Unit 36 was to identify and protect wintering areas (FWS, 1986). Prior to 1985, the last documented nesting activity in Nevada was in 1866 at Pyramid Lake (Linsdale, 1936 as cited in FWS, 1986). During 1985, a nesting attempt occurred on BLM land along Salmon Falls Creek in Elko County (FWS, 1986). No nesting territories are known to occur in White Pine County, Nevada (Williams, 2006).

The majority of bald eagle use in Nevada occurs during the winter. As of 1985, the

wintering population in Unit 36 was estimated to be 15 eagles (FWS, 1986).

The majority of the 85 bald eagle observations reported from White Pine County between 1970 and 2004 were of one to two birds. The maximum number of eagles detected at any one location was five (NDOW, unpublished data). Detections have been reported in virtually all months of the year but most have been made from December to March. These bald eagle sightings occurred at and adjacent to Basset Lake, the Ely airport, Butte Valley, Jakes Valley, near Cherry Creek, around McGill, and in Steptoe Valley. The project area does not contain suitable breeding or winter roosting habitat for this species. No known occurrences of bald eagle nesting or roosting sites exist within the immediate project area.

Appendix J, *Biological Resources Supplemental Information*, contains additional life history information on the bald eagle.

The FWS concurred with the assessment presented in the BA. However, based on the recent delisting of the bald eagle, the FWS determined that consultation with the FWS on the bald eagle was no longer required (see the FWS letter dated August 29, 2007, in Appendix K).

Yellow-Billed Cuckoo

The yellow-billed cuckoo is a Candidate for listing as Threatened or Endangered in its range west of the Rocky Mountains (66 FR 38611). Nevada has listed the yellow-billed cuckoo as State Rank S1 Nevada State Protected because it is considered critically imperiled because of extreme rarity, imminent threats, and/or biological factors. Under such a designation, the protected species may not be killed, captured, shot at, trapped, wounded, possessed, collected, seined, or netted, nor can a person attempt to do any of these activities. NDOW estimated

the summer population of yellow-billed cuckoo is between 20 and 30 birds statewide.

No occurrences of yellow-billed cuckoos have been recorded within the project area and it is highly unlikely that this species occurs in White Pine County.

Appendix J, *Biological Resources Supplemental Information*, contains additional life history information on the yellow-billed cuckoo.

3.5.4.3.2 Federally Listed Species Based on Climate Change

At least four species have been listed as Threatened or Endangered based in part on the effects of climate change. These species are not present in the project area, but are included in this FEIS as part of the discussion on the effects of climate change and in response to comments.

Polar Bear

The polar bear (*Ursus maritimus*) was listed as a Threatened species by the FWS in May 2008 (73 Fed. Reg. 28212 (May 15, 2008)). No critical habitat has been designated. The polar bear's range includes the East Siberian, Laptev, Kara, and Barents Seas of Russia; Fram Strait; Greenland and Barents Sea of northern Europe; Baffin Bay; through most of the Canadian Arctic archipelago and the Canadian Beaufort Sea; and in the Chukchi and Beaufort Seas located west and north of Alaska. Over most of its range, the polar bear remains on sea ice year-round or spends only short periods on land. A primary factor in the decision to list the polar bear was the observed and projected decline in polar sea ice, which is generally attributed to three interrelated factors: warming, atmospheric changes (including circulation and clouds), and changes in oceanic circulation. Relying primarily on the results of the Atmosphere-Ocean General Circulation

Models reported in the Inter-governmental Panel on Climate Change's (IPCC's) Fourth Assessment Report (IPCC, 2007), the FWS concluded that due primarily to climate change, polar bear habitat—principally sea ice—is declining throughout the species range, that this decline is expected to continue for the foreseeable future, and that this loss threatens the species throughout all of its range.

Elkhorn and Staghorn Corals

The elkhorn coral (*Acropora palmata*) and the staghorn coral (*Acropora cervicornis*) were listed as Threatened species by the National Oceanic and Atmospheric Administration (NOAA) in a single listing decision in May 2006 (70 Fed. Reg. 26852 (May 9, 2006)). In February 2008, NOAA proposed critical habitat comprised of three units (Florida Unit, Puerto Rico Unit, and St. Thomas/St. Johns Unit) totaling approximately 4,758 square miles of marine habitat in the Caribbean and off the coast of Florida (73 Fed. Reg. 6895 (Feb. 6, 2008)). The critical habitat designation has not been finalized. The two corals are widely distributed throughout the wider Caribbean and are found in waters off Florida, and Puerto Rico, U.S. Virgin Islands, Navassa, and the wider Caribbean (Belize, Colombia, Costa Rica, Guatemala, Honduras, Mexico, Nicaragua, Panama, Venezuela, and all the islands of the West Indies). Both elkhorn and staghorn corals were historically (pre-1980s) the most abundant and most important species on Caribbean coral reefs in terms of accretion of reef structure. The NOAA listing documents described seven threats to the coral—elevated temperature, competition, elevated nutrients, sedimentation, sea level rise, abrasion and breakage, contaminants, loss of genetic diversity, African dust, elevated carbon dioxide, and sponge boring.

Quino Checkerspot Butterfly

The Quino checkerspot butterfly (*Euphydryas editha quino*) was listed as an Endangered species in 1997 (62 Fed. Reg. 2313 January 16, 1997). Critical habitat was designated in 2002. (67 Fed. Reg. 18355 (April 15, 2002)). The range of the Quino checkerspot butterfly is limited to Riverside and San Diego Counties, California; designated critical habitat consists of a total of 171,605 acres in those two counties. The listing decision described the threats to the butterfly as one or more of the following factors: loss and degradation and fragmentation of habitat due to grazing, urban development, and fire management practices; over-collection and other human disturbance; and naturally occurring events such as fire or weather extremes (62 Fed. Reg. 2313). The critical habitat designation documents provide that in addition to these factors, the Quino checkerspot butterfly population decline likely has been, and will continue to be, caused in part by enhanced nitrogen deposition, elevated atmospheric carbon dioxide concentrations, and climate change, although urban development poses the greatest threat and exacerbates the other threats (67 Fed. Reg. 18359).

3.5.4.3.3 State Protected Wildlife Species

The NDOW is the state agency responsible for the restoration and management of fish and wildlife resources and the protection of species designated as Protected or Threatened under the authority of NRS 501.100-503.104 for wildlife and NRS 527.260-527.300 for plants. Table 3.5-5 lists state-protected wildlife species that occur or have the potential to occur in the project area.

Bats

Seven species of bats are protected under Nevada State Law or are BLM-Sensitive species. Six of the seven Sensitive species have the potential to occur in the project area

and three of these six species have recorded occurrences in the project area, according to NNHP elemental occurrence records. Bat species of State concern are also species of special concern for the FWS and the BLM. The exact locations of all bat records are considered to be sensitive information and were not provided by NNHP for analysis. The spotted bat, a former Candidate species, has been recorded once within the project vicinity in 1982, according to the NNHP database. There was one recorded occurrence of Townsend's big-eared bat in 1992, and another in 1993. The pallid bat was observed in the project area in 1992. Three additional bat species (fringed myotis, California myotis, and western small-footed myotis) are known to have suitable habitat in the project area, as documented by the NNHP.

Breeding and roosting habitat exists for bat species within portions of the project area. Such habitat occurs primarily in the Egan

Range portion of the transmission line ROW where rocky cliffs and outcroppings, small crevices, caves, and pinyon-juniper stands are found. Wetland habitats along Duck Creek, aquatic sites associated with springs, and the extensive sagebrush shrubland provide foraging habitat for bat species within the project area.

Appendix J, *Biological Resources Supplemental Information*, contains additional life history information on bats.

Birds

In addition to having special status, the avian species listed in Table 3.5-5 are protected under state law as well as federal law as dictated under the MBTA. With the exception of the European starling (*Sturnus vulgaris*) and the house sparrow (*Passer domesticus*), all other avian species that occur within the project area are protected under the MBTA.

TABLE 3.5-5

BLM and State (NDOW) Wildlife Species of Concern Potentially Occurring in the White Pine Energy Station Project Area

Scientific Name	Common Name	Status	Preferred Habitat	Recorded Occurrence in Project Area or Vicinity	Suitable Habitat in Project Area
Mammals					
<i>Brachylagus idahoensis</i>	Pygmy rabbit	NDOW-SSC BLM-S	Old growth sagebrush in sandy soils	Yes	Yes
<i>Microdipodops megacephalus</i>	Dark kangaroo mouse	NDOW-P	Sagebrush and alkali habitats, sandy soils	No	Yes
<i>Sorex preblei</i>	Preble's shrew	BLM-S	Sagebrush	No	Yes
Bats					
<i>Myotis thysanodes</i>	Fringed myotis	NDOW-P BLM-S	Caves, rocks, cliffs, riparian areas	No	Yes
<i>Corynorhinus townsendii</i>	Townsend's big-eared bat	NDOW-P/S BLM-S	Caves and crevices in rocks	Yes	Yes
<i>Antrozous pallidus</i>	Pallid bat	NDOW-P BLM-S	Rocky outcrops and ledges near water	Yes	Yes
<i>Euderma maculatum</i>	Spotted bat	NDOW-P/S BLM-S	Crevices, ledges, near water	Yes	Yes

TABLE 3.5-5

BLM and State (NDOW) Wildlife Species of Concern Potentially Occurring in the White Pine Energy Station Project Area

Scientific Name	Common Name	Status	Preferred Habitat	Recorded Occurrence in Project Area or Vicinity	Suitable Habitat in Project Area
<i>Myotis californicus</i>	California myotis	BLM-S	Rocky outcrop, snags, crevices, near water	No	Yes
<i>Myotis ciliolabrum</i>	Western small-footed myotis	BLM-S	Cracks and crevices	No	Yes
Birds					
<i>Centrocercus urophasianus</i>	Greater sage-grouse	NDOW-SSC BLM-SSC	Sagebrush	Yes	Yes
<i>Aquila chrysaetos</i>	Golden eagle	NDOW-P BLM-S	Shrub steppe, native grassland, riparian areas	Yes	Yes
<i>Accipiter gentiles</i>	Northern goshawk	NDOW-P BLM-S	Forest habitat generalists	No (migrants in south Schell Range)	Yes
<i>Buteo regalis</i>	Ferruginous hawk	NDOW-P BLM-S	Plains, prairies, pinyon-juniper stringers in sagebrush communities	No current (1 migrant observation in north Egan Range)	Yes
<i>Buteo swainsoni</i>	Swainson's hawk	NDOW-P BLM-S	Plains, range, hills, sparse trees	No (migrants in south Schell Range and south Egan Range)	Yes
<i>Athene cunicularia</i>	Burrowing owl	BLM-S	Salt desert scrub, agricultural lands	No	Yes
<i>Agelaius tricolor</i>	Tricolored blackbird	BLM-S	Wetlands with cattails/marshes	No	Yes
<i>Lanius ludovicianus</i>	Loggerhead shrike	NDOW-S BLM-S	Open country, savannas, desert scrub, and occasionally in open juniper woodlands	No	Yes
<i>Spizella breweri</i>	Brewer's sparrow	NDOW-S	Sagebrush/Montane pinyon-juniper woodland	No	Yes
<i>Oreoscoptes montanus</i>	Sage thrasher	NDOW-S	Sagebrush	Yes	Yes
<i>Asio otus</i>	Long-eared owl	NDOW-P BLM-S	Woodlands, coniferous forests	No	Yes
<i>Asio flammeus</i>	Short-eared owl	BLM-S	Prairie, sagebrush shrubland	No	Yes
<i>Baeolophus griseus</i>	Juniper titmouse	BLM-S	Mature pinyon-juniper woodlands	No	Yes
<i>Falco mexicanus</i>	Prairie falcon	NDOW-P BLM-S	Mountainous grasslands, open hills	Yes	Yes

TABLE 3.5-5

BLM and State (NDOW) Wildlife Species of Concern Potentially Occurring in the White Pine Energy Station Project Area

Scientific Name	Common Name	Status	Preferred Habitat	Recorded Occurrence in Project Area or Vicinity	Suitable Habitat in Project Area
<i>Falco peregrinus</i>	Peregrine falcon	NDOW-P BLM-S	Open country, cliffs	No	Yes
<i>Grus canadensis</i>	Sandhill crane	BLM-S	Prairies, fields, marshes	Yes	Yes
<i>Icteria virens</i>	Yellow-breasted chat	BLM-S	Brushy tangles, stream sides	No	Yes-migrant
<i>Ixobrychus exilis</i>	Least bittern	BLM-S	Freshwater marshes, ponds	No	Yes
<i>Gymnorhinus cyanocephalus</i>	Pinyon jay	BLM-S	Pinyon-juniper, sagebrush	Yes	Yes
<i>Numenius americanus</i>	Long-billed curlew	BLM-S	Salt marsh, rangeland, high plains	Yes	Yes
<i>Poocetes gramineus</i>	Vesper sparrow	BLM-S	Meadows, fields, prairies, roadsides	No	Yes
<i>Vireo vicinior</i>	Gray vireo	BLM-S	Brushy mountain slopes, mesas, scrub oak, junipers	No	Yes
<i>Dolichonyx oryzivorus</i>	Bobolink	BLM-S	Hayfields, meadows, marshes	No	Yes
Reptiles					
<i>Phrynosoma douglassii</i>	Short-horned lizard	BLM-S	Basin shrub habitats on loose soils	Yes	Yes
Amphibians					
<i>Rana pipiens</i>	Northern leopard frog	NDOW-P BLM-S	Heavily vegetated freshwater, brackish marshes, and moist fields from desert to mountain meadow	Yes	Yes
<i>Rana luteiventris</i>	Columbia spotted frog	NDOW-P	Mountains near cold streams and lakes	No	Yes
Insects					
<i>Polites sabuleti nigrescens</i>	Dark sandhill skipper	BLM-S	Alkali meadows, sand dunes, sagebrush flats, wet meadows	Yes	Yes
<i>Cercyonis pegala pluvialis</i>	White River wood nymph	BLM-S	Wetland	Yes	Yes
<i>Euphydryas editha koreti</i>	Koret's checkerspot	BLM-S	Occurs above approximately 12,000 feet elevation; oviposits exclusively on <i>Castilleja lapidicola</i>	No	Unknown

TABLE 3.5-5

BLM and State (NDOW) Wildlife Species of Concern Potentially Occurring in the White Pine Energy Station Project Area

Scientific Name	Common Name	Status	Preferred Habitat	Recorded Occurrence in Project Area or Vicinity	Suitable Habitat in Project Area
<i>Phyciodes pascoensis arenacolor</i>	Steptoe Valley crescent-spot	BLM-S	Wetland	Yes	Yes
<i>Euphilotes bernadino minuta</i>	Baking powder flat blue	BLM-S	Unknown	No	Unknown
Fish					
<i>Relictus solitarius</i>	Relict dace	NDOW-P/S BLM-S	Isolated springs within four intermountain valleys in northeastern Nevada	Yes (3 sites within hydrologic basin)	Yes
Springsnails					
<i>Pyrgulopsis serrata</i>	Northern Steptoe springsnail	NNHP-S1	Springs	Yes (10 sites within hydrologic basin)	Yes
<i>Pyrgulopsis sulcata</i>	Southern Steptoe pyrg	NNHP-S1	Springs	No	Yes

BLM-S = BLM-Sensitive; P/S = State (NDOW) Protected; SSC = State Species of Special Concern; NNHP-S1=Nevada Natural Heritage Program-Critically imperiled because of extreme rarity, imminent threats, and and/or biological factors.

Sources: NDOW 2005 Protected Species List and the Nevada BLM-Sensitive Species List; Vigg (1982); Hawkwatch International (2005) spring and fall migration surveys; Britten et al. (1992)

One of the major vegetation community types within the project area is sagebrush shrublands. Sagebrush habitat is of high maintenance importance because several Special Status avian species, including Brewer's sparrow, greater sage-grouse, and sage thrasher, are dependent on it. Sage thrasher and greater sage-grouse were documented in the project area in the western portion of Steptoe Valley and in Butte Valley. The pinyon-juniper woodlands along the proposed transmission line ROW in the Egan Range and Butte Valley provide habitat for species such as loggerhead shrike, pinyon jay, juniper titmouse, gray vireo, long-eared owls, and ferruginous hawk. The loggerhead shrike and pinyon jay were

documented during surveys conducted within the project area in summer 2005.

The project area contains wetland habitats and borders patches of agricultural land irrigated for cattle/horse grazing. These areas could provide habitat for species that prefer mesic habitats such as sandhill crane, bobolink, short-eared owl, vesper sparrow, long-billed curlew, and yellow-breasted chat.

Sandhill cranes were observed within the project area along portions of Duck Creek. The large wetland complex located immediately south of the proposed rail spur alignment associated with Duck Creek contains habitat for waterfowl and other migratory species of concern. The large number of springs within Steptoe

Valley have also created wetlands throughout and adjacent to the project area. These habitats could support species such as the least bittern.

Ferruginous Hawk

The ferruginous hawk is a BLM and state species of concern. BLM and NDOW are concerned about the survival of this species because of the continued increase in seismic and geophysical (energy and mineral) exploration within the Ely District (Perkins and Lindsey, 1983). BLM surveys conducted in 1982 recorded 27 total ferruginous hawks within the entire Ely District.

Appendix J, *Biological Resources Supplemental Information*, contains additional life history information on ferruginous hawks.

BLM reports that ferruginous hawk nesting and habitat areas occur west of the project area in Butte Valley and east of U.S. 93. Within the BLM Ely District, the greatest percentages of ferruginous hawk nest sites are within juniper stringers on big sagebrush or black sagebrush knolls and within 2 miles of white sage (Perkins and Lindsey, 1983). No ferruginous hawk nests have been previously recorded in the project area.

Existing data sets for ferruginous hawks were deemed incomplete, so the project area was surveyed for nesting sites in May 2005. Surveys were conducted on May 17, 18, 19, and 20, 2005, between 7:00 a.m. and 12:00 to 12:30 p.m. The only project feature that contained suitable ferruginous hawk nesting habitat was the proposed transmission line corridor. Surveyors walked suitable habitat within the transmission line corridor (including the 0.5-mile buffer) and searched for raptors, nests, or raptor sign such as whitewash. Hawkwatch International (2005)

documented one ferruginous hawk in the northern portion of the Egan Range during fall migration and one in the same region during spring migration.

No ferruginous hawks were detected in or near the project area in 2005. However, a single ferruginous hawk was observed perched on a fence post along Alternate Highway 93 north and east of the proposed project area. The project area contains suitable foraging and nesting habitat for the ferruginous hawk. In the vicinity of the proposed transmission lines, the western side of the Egan Range in Butte Valley has what appeared to be highly suitable habitat for ferruginous hawk nesting because of the presence of multiple juniper stringers and the expanse of sagebrush communities. During surveys, three stick-nests located in juniper trees were noted in this portion of the proposed transmission line alignments. All three of these nests were inactive and had no evidence of recent use. Two of the nests were 2 to 3 feet in diameter and could have potentially been ferruginous hawk nests. The third nest, which was approximately 16 to 18 inches in diameter, most likely belonged to an owl or magpie. The two potential ferruginous hawk nests had fallen apart and appeared to have been inactive for at least the past year.

Other Raptor Species of Concern

The western portion of the project area, which includes the Egan Range, contains pinyon-juniper woodlands that could provide nesting habitat for northern goshawks, Cooper's hawks, sharp-shinned hawks, golden eagles, and Swainson's hawks. The BLM has mapped cliff nesting habitat in the Egan Range near the crossing of the proposed transmission lines. Spring and fall migration surveys conducted by Hawkwatch International (2005) in the Egan and Schell Ranges surrounding Steptoe Valley documented

northern goshawks, Swainson's hawks, and ferruginous hawks among the 17 species of raptors observed.

The raptor species observed during surveys for ferruginous hawks included one pair of golden eagles, a number of kestrels, a pair of northern harriers, ravens, and several turkey vultures.

A pair of golden eagles, believed to be nesting on the east side of the Egan Range, was observed on several occasions soaring over and adjacent to the project area in Steptoe Valley, Butte Valley, and the Egan Range. Nearby rock ledges were examined with binoculars but no nest was found. It is possible that the pair nests south of the project area beyond the area covered by the surveys. A pair of northern harriers was also seen during biological surveys in May 2005. This pair was observed in Steptoe Valley along the proposed transmission line ROW, distribution line alignments, and water supply system. The pair was observed soaring above agricultural fields, sagebrush habitats, and salt desert scrub habitats, but no nests were found. A prairie falcon was observed perching on a juniper tree on the west side of the Egan Range in Butte Valley during the special status plant habitat assessment in June 2005.

Northern goshawks and peregrine falcons were not observed nor were any nests/eyrie found during biological survey work. BLM data show a number of northern goshawk nests and occurrences to the west in Butte Valley and east of U.S. 93 but none near the project area. A goshawk was previously documented by the BLM 1 to 1.5 miles to the west of the proposed transmission lines and southwest of the proposed plant site. Hawkwatch International (2005) recorded three northern goshawks during fall migration and one during spring migration in the Steptoe Valley region.

In Nevada, sparsely vegetated habitats preferred by burrowing owls are predominantly found in the salt desert scrub habitat type, which occupies roughly 8.9 million hectares of valley bottoms within the Great Basin physiographic region (FWS, 2003). Sagebrush habitat is also used when artificial burrows are placed in moderately dense sagebrush communities. Burrowing owls will also breed around the fringes of agricultural lands and use crop and pasture lands for foraging during the breeding season (FWS, 2003). This species rarely winters in northern Nevada and sparingly in the southern part of the state. According to the Nevada Breeding Bird Atlas, burrowing owls have been confirmed or suspected breeding in nearly every county in Nevada. The species winters most frequently in the southern half of Nevada, but has been recorded throughout the state during all months (FWS, 2003). The project area contains salt desert scrub habitat, however, there have been no previous occurrences of this species in the project area, and no burrowing owls were observed in the project area during biological field surveys conducted in 2005. The MBTA was described in Section 3.5.3.1.2, *Migratory Bird Treaty Act*.

Greater Sage-Grouse

The greater sage-grouse inhabits sagebrush ecosystems in the western U.S. Because of the greater sage-grouse's reliance on sagebrush communities for nesting, brooding, foraging, and winter/fall cover habitat requirements, this species is considered sagebrush obligate. Obligate species are defined in the Greater Sage-Grouse Conservation Plan for Nevada and Eastern California 2004 (NDOW, 2004b), as those species that are restricted to certain habitats or to limited conditions during one or more seasons of the year to fulfill their life requirements. The greater

sage-grouse was denied listing under the ESA on January 7, 2005. Under court order, the FWS is currently reconsidering its decision not to list. The greater sage-grouse is still a species of concern for the FWS, the State of Nevada, and the BLM. It is now under state and federal land management agencies' jurisdictions to manage this species to prevent the need for future listing.

Appendix J, *Biological Resources Supplemental Information*, contains additional life history information on greater sage-grouse.

Greater Sage-Grouse Occurrence in Project Area

The White Pine County Sage Grouse Conservation Plan divides the county into four Population Management Units (PMUs). The White Pine Energy Station Project would occur entirely in the Butte Valley/Buck Mountain/White Pine Range PMU. Within the project area, this PMU encompasses parts of Steptoe (north of Ely), and all of Butte and Jakes Valleys. There are 137 known leks within the overall PMU (WPC, 2004). The primary threats to greater sage-grouse in this PMU are climate/weather (drought), predation, laws/policies, regulations, and expansion of pinyon-juniper (WPC, 2004).

Aerial and ground-based greater sage-grouse surveys were conducted in the project area and vicinity in spring of 2005 by EDAW, BLM, and NDOW. Aerial surveys were conducted on April 2 and 3, 2005. The survey team consisted of a biologist from NDOW, an experienced greater sage-grouse survey pilot from El Aero Services, and a natural resource specialist with EDAW, Inc. Surveys began at approximately 5:15 to 5:20 a.m. and concluded by 8:30 to 8:45 a.m. both days. Surveys were conducted in suitable habitat

areas within the SWIP corridor (a 2-mile-wide corridor), the proposed water pipeline and distribution line corridors (a 2-mile-wide buffer), east of U.S. 93 and within Steptoe Valley, the power plant proposed and alternative sites, well sites, and rail spur ROWs. To ensure that all project features were covered, Steptoe Valley was surveyed from east to west in areas with suitable habitat to achieve maximum coverage of potential habitat areas. Historic lek (sites where males strut for females) locations were examined to determine if any greater sage-grouse were active in portions of Butte Valley and Steptoe Valley. Data from the BLM and NDOW indicated that as of 2005, there were 21 lek sites in Steptoe and Butte Valleys (Table 3.5-6). However, no greater sage-grouse leks or individual greater sage-grouse were identified in any portion of the project area during aerial surveys. An active lek was identified approximately 3 to 5 miles west of the SWIP corridor within Butte Valley and is labeled as Red Pepper Butte East lek. Ground-based surveys conducted by the BLM during March, April, and May 2005 positively identified seven active leks that were not seen during aerial surveys (Table 3.5-6). Six of the active leks were within 2 miles of a Proposed Action or Alternative 1 project feature.

Surveys were conducted again in spring 2006 by BLM and NDOW biologists. Five of the seven leks found active in 2005, were active again in 2006. Log Canyon North lek (within the ROW) and Red Pepper Butte East (outside the ROW) were active in 2005, but were not active in 2006.

Based on ground-based surveys by the BLM and observations made in the project area incidental to biological surveys in 2005 and 2006, Steptoe and Butte Valleys provide winter, summer, breeding, and

nesting habitat for the greater sage-grouse. Historical data also indicate use of the area. A grouse brood was found in the wet meadows of Cold Spring in 1995 (Haskins, 1995). Grouse sign was noted near several

of the small isolated springs along the western edge of Steptoe Valley. Figure 3.5-2 displays potential greater sage-grouse habitat.

TABLE 3.5-6

Greater Sage-grouse Leks Within the Survey Corridor (2-mile-wide-buffer) of the Project Area in Steptoe and Butte Valleys

Lek Name	Active/Not Active in 2006	Active/Not Active in 2005	Within 2-Mile-Wide Project Buffer? (Yes/No)	Approximate Distance from 2-Mile-Wide Project Buffer (if not found in buffer zone)
Log Canyon North	Not active	Active	Yes-2,085 feet from proposed centerline	0
Mud Spring North	Unknown	Not active	Yes	0
Raiff Siding	Not active	Not active	Yes	0
Glenn Siding	Not active	Not active	Yes	0
Butte Valley 2	Not active	Not active	Yes	0
Butte Valley 3	Not active	Not active	Yes	0
Madelina Springs	Active	Active	No-6.1 miles to proposed well site	4.2 miles
Cherry Creek South	Active	Active	No-6.7 miles to proposed water pipeline	5.7 miles
Borchert Creek North	Active	Active	No-4.3 miles to proposed pipeline	3.3 miles
Whiteman Creek	Active	Active	No	1.5 miles from proposed distribution line
Water Canyon Bench	Not active	Not active	No	Less than 0.25 mile from transmission line ROW
Dry Canyon Road	Not active	Not active	No	1.75 miles
Dry Canyon	Not active	Not active	No	0.5 mile
Dry Canyon 2	Active	Active	No-2.2 miles from proposed plant site	1 mile
Dry Canyon 3	Not active	Not active	No	Less than 1/4 mile
Steptoe	Not active	Not active	No	2.75 miles
Butte Valley South	Not active	Not active (unknown)	No	1.5 to 2 miles
Currie Canyon	Not active	Not active	No	2 miles
Tehama Creek North	Not active	Not active	No	1.75 to 2 miles
Timber Creek	Not active	Unknown	No	2 miles east of U.S. 93
Red Pepper Butte East	Not active	Active	No	4.5 miles

Historical data provided by the BLM and NDOW show no leks immediately adjacent to the NNR, but do indicate leks on the western side of Goshute Valley. Separate environmental documentation has been prepared by White Pine County for the NNR action.

Pygmy Rabbit

The pygmy rabbit is the smallest native rabbit in North America and is a BLM-Sensitive species and a State species of special concern. This species is also a former Category 2 Candidate Species.

Pygmy rabbit habitat was assessed in the project area during 2005 to evaluate potential impacts to this species and their habitat. Data requests from the NNHP showed three occurrences of pygmy rabbits in the project area in 2003. NNHP-recorded occurrences were in Steptoe Valley, Butte Valley, and in a draw in the Egan Range. Following data collection activities, habitat assessment surveys were completed using the protocol created in part by a member of the BLM Boise, Idaho District (Ulmschneider, 2004). Suitable pygmy rabbit habitat was identified along various portions of the proposed water pipeline alignments. Stands of big sagebrush coupled with sandy soils along the alternative water pipeline ROW provide the highest quality habitat for pygmy rabbits in the project area. Several pygmy rabbits were observed along the southern end of the proposed water pipeline alignment during habitat assessment surveys conducted in 2005.

Appendix J, *Biological Resources Supplemental Information*, contains additional life history information on pygmy rabbits.

Small Mammals

Suitable habitat exists in the project area for the dark kangaroo mouse. There are no recorded occurrences of this species within the project area or White Pine County. This mouse can be found in loose sands and gravels in shadscale scrub, sagebrush scrub, and sand dunes. Portions of the proposed water pipeline alignments are just west of dune habitat, and areas along the southern portion of the proposed pipeline corridor contain the sandy soils and big sagebrush habitat that this species, as well as the Preble's shrew, require. These species are nocturnal so there were no observances of them during biological field surveys. There are no recorded occurrences of these species in the project area, although suitable habitat is present.

Amphibians

Northern leopard frogs inhabit heavily vegetated freshwater, brackish marshes, and moist fields from desert to mountain meadows. Northern leopard frogs have sensitive status as a result of habitat loss, fungal infections, and competition with non-native fish and amphibians throughout their range. The Columbia spotted frog is also a BLM-Sensitive species that is known to occur in White Pine County (NNHP, 2005b). This frog typically inhabits springs, seeps, meadows, marshes, ponds, and streams where there is abundant vegetation (FWS, 2005). Populations of the Great Basin Columbia spotted frog have declined in recent years because of grazing, spring development, water diversion, trail construction, and fires in riparian corridors (FWS, 2005).

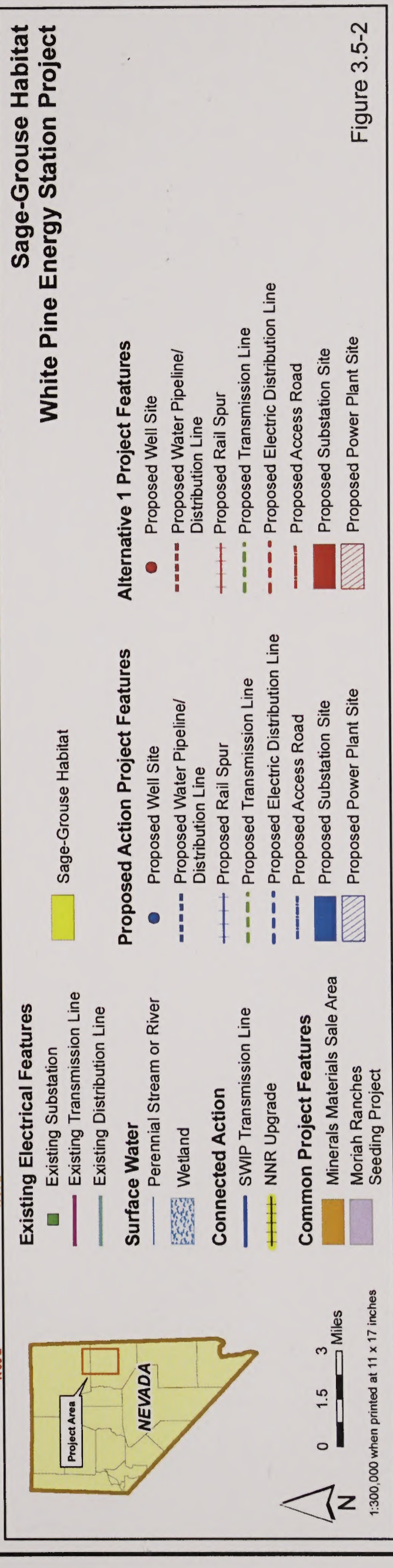
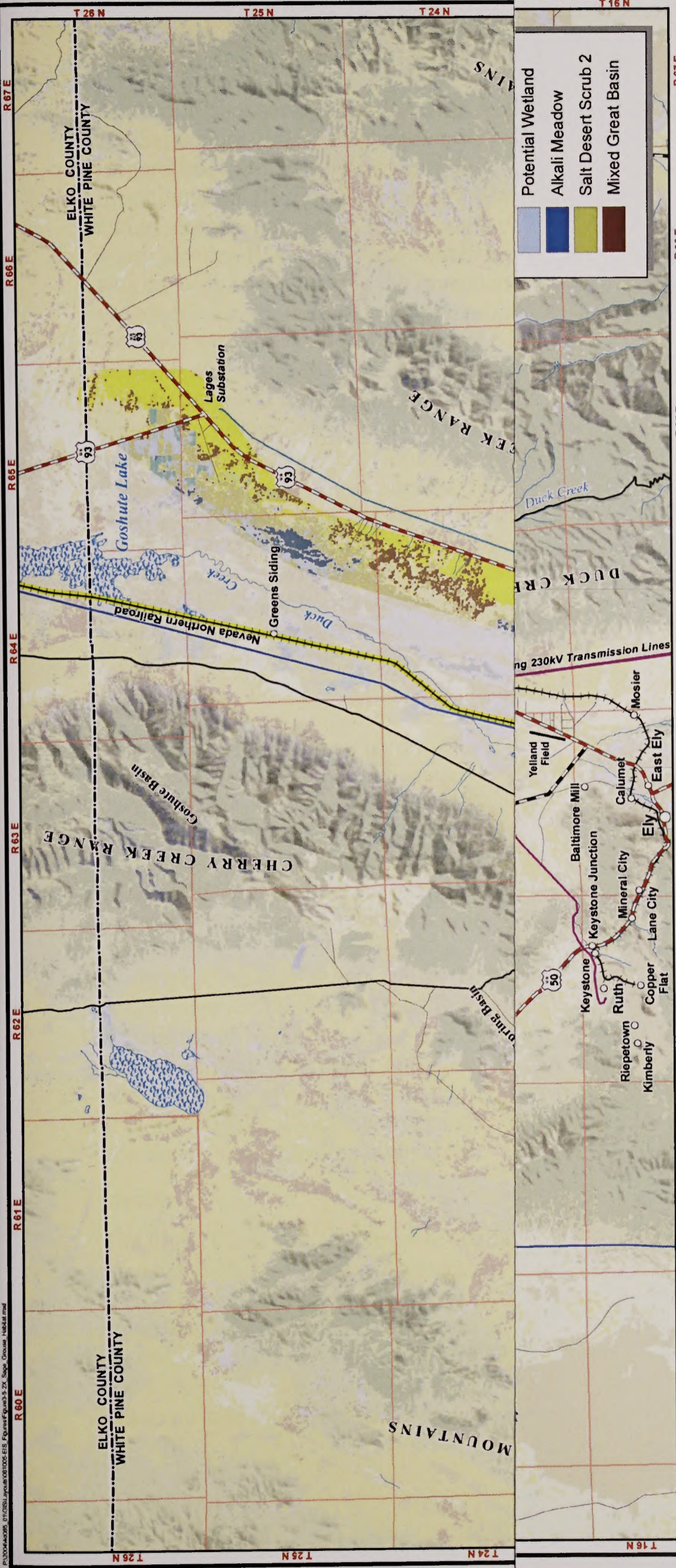

Figure 3.5-2

Historical data provided by the BLM and NDOW show no leks immediately adjacent to the NNR, but do indicate leks on the western side of Goshute Valley. Separate environmental documentation has been prepared by White Pine County for the NNR action.

Pygmy Rabbit

The pygmy rabbit is the smallest native rabbit in North America and is a BLM-Sensitive species and a State species of special concern. This species is also a former Category 2 Candidate Species.

Pygmy rabbit habitat was assessed in the project area during 2005 to evaluate potential impacts to this species and their habitat. Data requests from the NNHP showed three occurrences of pygmy rabbits in the project area in 2003. NNHP-recorded occurrences were in Steptoe Valley, Butte Valley, and in a draw in the Egan Range. Following data collection activities, habitat assessment surveys were completed using the protocol created in part by a member of the BLM Boise, Idaho District (Ulmschneider, 2004). Suitable pygmy rabbit habitat was identified along various portions of the proposed water pipeline alignments. Stands of big sagebrush coupled with sandy soils along the alternative water pipeline ROW provide the highest quality habitat for pygmy rabbits in the project area. Several pygmy rabbits were observed along the southern end of the proposed water pipeline alignment during habitat assessment surveys conducted in 2005.

Appendix J, *Biological Resources Supplemental Information*, contains additional life history information on pygmy rabbits.

Small Mammals

Suitable habitat exists in the project area for the dark kangaroo mouse. There are no recorded occurrences of this species within the project area or White Pine County. This mouse can be found in loose sands and gravels in shadscale scrub, sagebrush scrub, and sand dunes. Portions of the proposed water pipeline alignments are just west of dune habitat, and areas along the southern portion of the proposed pipeline corridor contain the sandy soils and big sagebrush habitat that this species, as well as the Preble's shrew, require. These species are nocturnal so there were no observances of them during biological field surveys. There are no recorded occurrences of these species in the project area, although suitable habitat is present.

Amphibians

Northern leopard frogs inhabit heavily vegetated freshwater, brackish marshes, and moist fields from desert to mountain meadows. Northern leopard frogs have sensitive status as a result of habitat loss, fungal infections, and competition with non-native fish and amphibians throughout their range. The Columbia spotted frog is also a BLM-Sensitive species that is known to occur in White Pine County (NNHP, 2005b). This frog typically inhabits springs, seeps, meadows, marshes, ponds, and streams where there is abundant vegetation (FWS, 2005). Populations of the Great Basin Columbia spotted frog have declined in recent years because of grazing, spring development, water diversion, trail construction, and fires in riparian corridors (FWS, 2005).

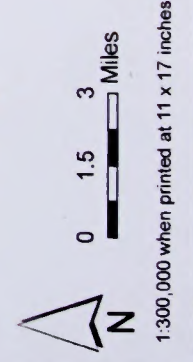
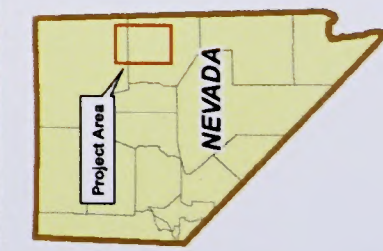
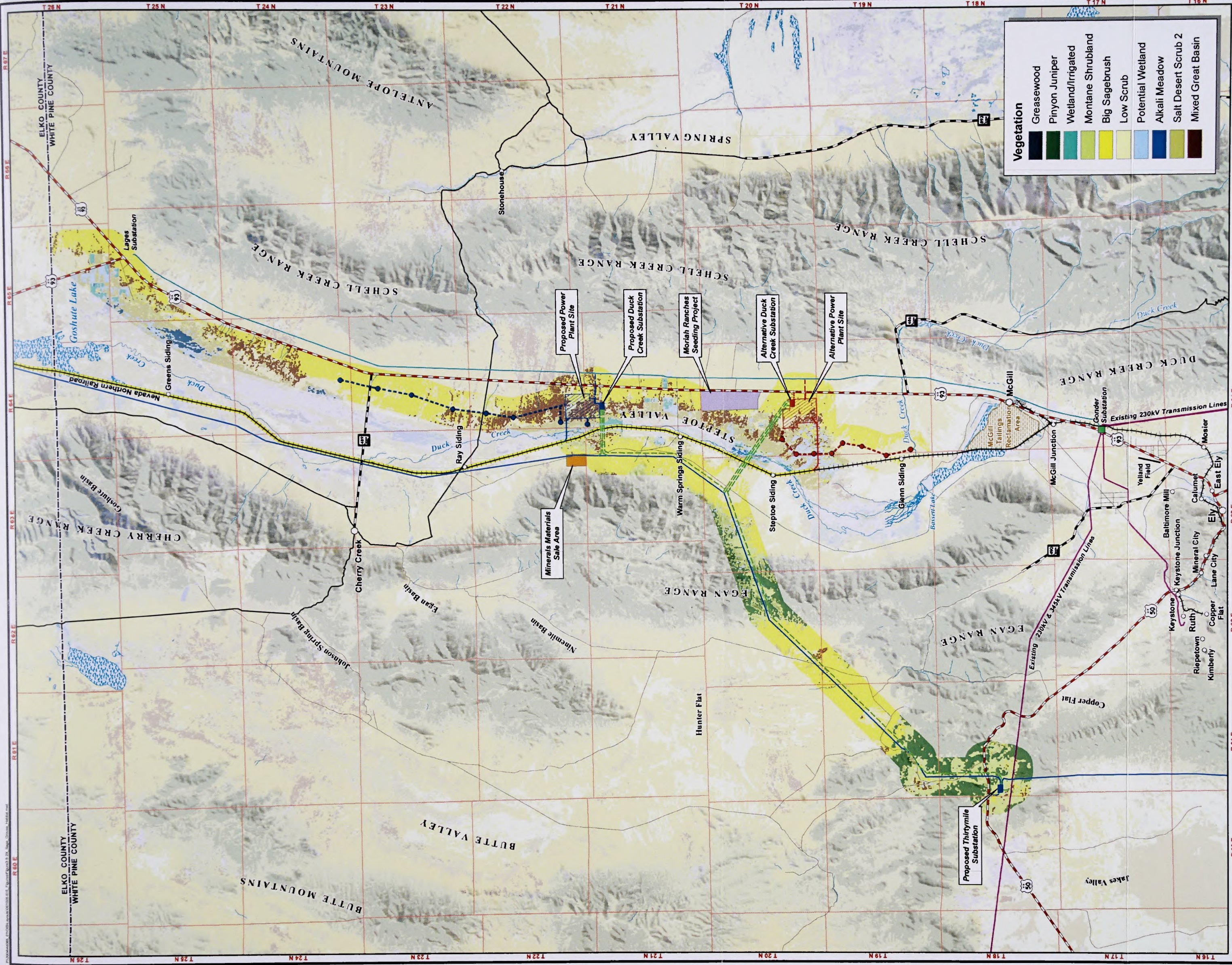

- Existing Electrical Features**
- Existing Substation
 - Existing Transmission Line
 - Existing Distribution Line
- Surface Water**
- Perennial Stream or River
 - Wetland
- Connected Action**
- SWIP Transmission Line
 - NNR Upgrade
- Common Project Features**
- Minerals Materials Sale Area
 - Moriah Ranches
 - Seeding Project

- Proposed Action Project Features**
- Proposed Well Site
 - Proposed Water Pipeline/Distribution Line
 - Proposed Rail Spur
 - Proposed Transmission Line
 - Proposed Electric Distribution Line
 - Proposed Access Road
 - Proposed Substation Site
 - Proposed Power Plant Site
- Sage-Grouse Habitat**

- Alternative 1 Project Features**
- Proposed Well Site
 - Proposed Water Pipeline/Distribution Line
 - Proposed Rail Spur
 - Proposed Transmission Line
 - Proposed Electric Distribution Line
 - Proposed Access Road
 - Proposed Substation Site
 - Proposed Power Plant Site

**Sage-Grouse Habitat
White Pine Energy Station Project**

Figure 3.5-2

Aquatic habitat surveys conducted in April and September 2005 documented northern leopard frogs at four springs along an irrigation ditch flowing from Grass Spring, and in a small stream near the alternative water pipeline ROW. The latter observation was the only one located in the immediate vicinity of a proposed or alternative project facility. Duck Creek and its associated wetlands and many of the 45 Steptoe Valley springs examined during aquatic habitat surveys in 2005 provide potential habitat for northern leopard frogs and Columbia spotted frogs. Both of these frog species require water bodies that persist through the spring and early summer for breeding and tadpole development. Because of the ephemeral nature of the majority of surface waters in Steptoe and Butte Valleys, suitable breeding habitat is limited for either species.

Reptiles

A number of lizards were identified and observed throughout the project area during surveys for noxious/invasive weeds and special status plant habitat. The short-horned lizard was the only reptile species of concern identified during biological surveys. Short-horned lizards occur in diverse habitats over their broad geographic range. Habitats within the project area include Short-Grass Prairie, Sagebrush, Semi-Desert Shrubland, and Pinyon-Juniper Woodland. This species was commonly observed within the project area, particularly along the proposed and alternative water pipeline alignments.

Insects

The project area contains suitable habitat for several BLM-designated insects of special concern. There are five species of butterflies with the potential to occur in the project area, according to the NNHP 2005 species list for White Pine County. These include the White River wood

nymph, baking powder flat blue, dark sandhill skipper, Koret's checkerspot, and Steptoe Valley crescent spot. These species are endemic to the Great Basin and are a high conservation priority for the BLM. The NNHP databases show three occurrences of sensitive butterfly species in the project area. These include four occurrences of the White River wood nymph, two occurrences of the dark sandhill skipper, and three occurrences of the Steptoe Valley crescent spot. These occurrences are at least 5 years old or more in some cases. There are no records for other Sensitive species of butterflies within the project area.

The White River wood nymph, dark sandhill skipper, and Steptoe Valley crescent spot occurrences were near or adjacent to Duck Creek, Basset Lake, and Steptoe Slough in Steptoe Valley. The majority of occurrences were within 1 to 6 miles of the proposed water pipeline ROW and transmission line ROW east of the Egan Range. Suitable habitat may exist for these species along the proposed water pipeline alignment, rail spur, and distribution line in the southern end of the project area.

Aquatic Species of Special Concern

Existing information and field surveys were used to describe the occurrence of sensitive fish and aquatic springsnails. Aquatic surveys were conducted at 45 springs in Steptoe Valley and along segments of Duck Creek within 200 feet of the Proposed Action and Alternative 1 project features to determine the presence of relict dace and springsnails (see Figure 3.4-5). The surveys were conducted by an aquatic expert from the Desert Research Institute with assistance from EDAW ecologists in September 2005 and consisted of visual searches of the aquatic habitat for fish and amphibians, and straining vegetation and substrate samples

for invertebrates. Survey methods are summarized in the “Northern Steptoe Valley Springsnail Surveys, White Pine County, Nevada” (Sada, 2006).

The only fish species listed in Table 3.5-5 with suitable habitat in the project area is the relict dace. The relict dace is an NDOW Protected Species and a BLM-Sensitive species. The species naturally occurs in isolated springs in Steptoe, Butte, Ruby, and Goshute Valleys, and as an introduced species in Spring Valley in northern Nevada (Vigg, 1982; Stein and Salisbury, 1994). Sites supporting relict dace have water temperatures that do not vary substantially; the maximum water temperature recorded at a relict dace site is 25 degrees Celsius (°C) (Vigg, 1982). The primary threats to this species are degradation of habitat, exotic species introductions, and localized extirpation. The most recent previous surveys in the analysis area were conducted in 1994 (Stein and Salisbury, 1994) and 1995 (Haskins, 1995). NDOW summarized relict dace sites from surveys conducted in 1994 and 1995 by NDOW and in previous years by other investigators and determined that populations of relict dace occurred at 20 sites within Steptoe Valley and seven springs in northern Butte Valley near the White Pine-Elko County line (Table 3.5-7). Historical relict dace sites in Steptoe Valley are on the western side of the valley between Basset Lake and the Steptoe-Goshute Valley boundary. Duck Creek has suitable habitat for this species, but introductions of northern pike (predator) and carp (compete for habitat) make their occurrence unlikely (Haskins, 1995; Crookshanks, 2005). Potential relict dace occurrences were observed north of the project area on private property. No relict dace were observed in Duck Creek during field surveys conducted in 2005.

One species of endemic springsnail (the Northern Steptoe springsnail [*Pyrgulopsis serrata*]) was documented at 10 springs in the western portion of Steptoe Valley during the aquatic surveys. All of the springs with springsnails occurrence were generally larger (longer springbrooks and greater discharge) than the average size springs surveyed within the project area. These populations of *Pyrgulopsis serrata* were previously unrecorded. Prior to these surveys, this species was known to occur only in three springs, all occurring on the west side of Steptoe Valley.

3.5.4.3.4 Special Status Plant Species

Plant Species of Special Concern in White Pine County

The area of analysis for special status plant species is the same as that used for special status wildlife species. Regulations applicable to special status plants are discussed in Section 3.5.4.1, *Regulatory Framework*. The species included for analysis include federally listed and species proposed for listing as Threatened or Endangered, Candidate, Nevada State Protected Species, and Nevada BLM-Sensitive Species. Also included are plant species that have “special status” designations (for example, those designated by NNHP) other than state or federal status as Threatened, Endangered, or Candidate species. Special status designations indicate species rarity, population declines, or threats to populations that may warrant special consideration or protection, which include federal species, NNHP at-risk plant species, and also cactus, yucca, and Christmas trees, which are protected by Nevada state law. Christmas tree is defined in the Nevada Revised Statutes (NRS 527.062) as “any evergreen tree or part thereof cut and removed from the place where grown without the foliage being removed.”

TABLE 3.5-7

Historical Relict Dace Occurrence in Steptoe and Butte Valleys

Site	Site Name (NDOW 1994/1995)	Year Relict Dace Documented
Steptoe Valley		
RD1	3-C Ranch / Steptoe Valley WMA	1938, 1969, 1972
RD2	Georgetown Ranch	1938, 1991-1992, 1994
RD2A	Murray Creek	1991, 1994
RD3	Dairy Ranch Springs / McGill Pool	1938, 1979, 1991-1992, 1994
RD3A	McGill Springs Road Crossing Below Dairy	1994
RD3B	Midpoint of McGill Springs Outflow	1994
RD3C	Spring West of McGill Pool	1994
RD3D	West End McGill Springs Outflow	1994
RD4	Tailings Creek at Pumphouse	1994
RD5B	Lusetti Ranch / Grass Springs 3	1994
RD5C	Lusetti Ranch / Grass Springs 4	1962, 1977, 1979, 1980, 1994
RD6	Steptoe Ranch 1	1991
RD6B	Steptoe Ranch 3	1938, 1962, 1979, 1980, 1991, 1994
RD6C	Steptoe Ranch 4	1938, 1962, 1979, 1980, 1994
RD6D	Steptoe Ranch 5	1938, 1962, 1979, 1980
RD7	Cordano / Murphy / Dolan Ranch 1	1938, 1979, 1980
RD7A	Cordano / Murphy / Dolan Ranch 2	1938, 1979, 1980, 1995
ND1	Ruth Pond	1965, 1979
ND3D	Duck Creek—Warm Springs	1962, 1980
ND10	Lookout Springs	1981
Butte Valley		
RD30	Odgers Creek Spring source	1942, 1979, 1980
RD30A	Odgers Creek	1942, 1979, 1980, 1991-1992, 1994
RD31	Spring northeast of Odgers Creek	1994
RD32	Quilici / Delker Spring	1934, 1979, 1980, 1991-1992, 1994
RD33	Atwood/Kirkpatrick Ranch	1938, 1942, 1962, 1979, 1980, 1991, 1994
ND30	Owens Ranch Springs	1942
ND31	Stratton / Paris / West Ranch	1942, 1962, 1979

Source: NDOW unpublished data.

This section provides information on special status plant species known or suspected to occur in the vicinity of the project area. It also includes an assessment of potential habitat and likelihood of occurrence of special status species within the project area.

A pre-field investigation for information on special status plant species occurrences in the study corridor was obtained from the FWS and the NNHP, which included BLM information to identify known occurrences and potential habitat of Threatened, Endangered, Candidate, and other special status plants that might occur in the project area. Additional information on plant species' habitat requirements and blooming periods was obtained from state (Kartesz, 1983; NNHP, 2005a) and regional (Cronquist et al., 1986-1997; Abrams, 1981) flora guides. In addition, soils were identified for the study area using the Natural Resources Conservation Service Soil Survey for White Pine County (USDA, 1998) to determine the presence of soils capable of supporting special status plants. A reconnaissance-level survey was conducted from June 11 through 17, 2005, by an EDAW botanist to assess potential habitat for special status species in the project area. No special status plant surveys were conducted as part of the potential habitat assessment. Rare plant surveys would be conducted prior to construction in suitable habitats.

The pre-field reconnaissance investigation identified 31 special status plants with the potential to occur in the project area. The list includes all species in White Pine County considered at-risk by the NNHP (NNHP, 2005b). The NNHP defines at-risk species as follows:

Taxa considered at-risk and actively inventoried by NNHP typically include those with federal

or other Nevada agency status of Endangered, Threatened, or Sensitive, and those with Global ranks (Grank 1-3) or declining trends indicating some level of range-wide imperilment. In general, an at-risk species is any taxon whose long-term viability has been identified as a concern.

The status and habitat requirements for special status plant species is provided in Table 3.5-8. Six of the 31 special status plant species have been documented to occur in the general vicinity of the project area, but not directly in the proposed or alternative project feature areas. The six species that have documented occurrence in the project vicinity include the following:

- Broad-pod freckled milkvetch (*Astragalus lentiginosus* var. *latus*)—two occurrences in Schell Creek Range approximately 6.6 miles east of proposed water pipeline (NNHP data)
- Monte Neva paintbrush (*Castilleja salsuginosa*)—one occurrence 1 mile east of proposed transmission line ROW
- Stalked whitlow cress (*Draba pedicellata*)—one occurrence in Egan Range 9 miles west of proposed water pipeline and 20 miles north of proposed transmission line ROW
- Pennell draba (*Draba pennellii*)—one occurrence in Egan Range and one in Schell Creek Range (both more than 7 miles from project)
- Watson goldenbush (*Ericameria watsonii*)—one occurrence in Schell Creek Range 6 miles southeast of proposed power plant site
- Nachlinger catchfly (*Silene nachlingerae*)—three occurrences in Egan Range, with nearest 4 miles from proposed transmission line ROW

Monte Neva paintbrush is a species listed by the State of Nevada as Endangered and known from just two locations in Nevada, one of which is located in the project vicinity at Monte Neva Hot Springs approximately 0.6 mile from the SWIP corridor in Steptoe Valley. As reported in Podborny (2007), a U.S. Fish and Wildlife Service botanist visited the Monte Neva Hot Springs area and determined that the Monte Neva paintbrush is supported by shallow ground water resulting from snowmelt during the spring, and is not dependent on ground water flows from the Monte Neva Hot Springs or any other springs. There are nine occurrences of the other five special status plant species in the Schell Range and the Egan Range; the

closest of these nine occurrences to any project feature is approximately 4.5 miles in the Egan Range and 4.3 miles in the Schell Range.

Ute ladies'-tresses orchid (*Spiranthes diluvialis*) is federally listed as Threatened and state listed as Endangered. Sunnyside green gentian (*Frasera gypsicola*) and Monte Neva paintbrush are state listed as Endangered. Twelve of the 31 species are BLM-Sensitive species, and 12 of the 31 species are only at-risk species with the NNHP and have no other state or federal designation (Table 3.5-8). Sand cholla is a cactus species protected by Nevada state law, as are any other cactus species that potentially occur in the project area.

TABLE 3.5-8

Known Habitat Requirements and Status of Species with Special FWS, BLM, State of Nevada, or NNHP Status Evaluated for Potential Habitat in the White Pine Energy Station Project Area

Scientific Name	Common Name	Known Habitat and Flowering Period (FP)	FWS ^a	BLM ^b	State of Nevada ^c	NNHP ^d
<i>Arenaria congesta</i> v. <i>wheelerensis</i>	Mount Wheeler sandwort	Spruce-Aspen belt ca. 8,690 to 12,000 feet. Flowering Period (FP): July to August				T2?G5S2?
<i>Asclepias eastwoodiana</i>	Eastwood milkweed	Open areas on a wide variety of basic soils, including calcareous clay knolls, sand, carbonate or basaltic gravels, or shale outcrops, generally barren and lacking competition, often in moisture-accumulating microsites; shadscale, mixed-shrub, sagebrush, and lower pinyon-juniper zones. Elevation: 4,680 to 7,080 feet. FP: May to June		S		G2QS2
<i>Astragalus diversifolius</i>	Meadow milkvetch	Prefers alkali meadows, ditch banks, and swales in sagebrush. Edge of an alkaline seepage area with <i>Chrysothamnus</i> . Elevation: 4,400 to 6,300 feet. FP: June to July				G3S1
<i>Astragalus lentiginosus</i> v. <i>latus</i>	Broad-pod freckled milkvetch	Gravelly or sandy calcareous soils, generally on moderate to steep slopes, associated with the zonal vegetation. Elevation: 5,700 to 9,900 feet. FP: June to August				T2G5S2
<i>Botrychium crenulatum</i>	Dainty moonwort	Wetland-dependent in Nevada. Elevation: 8,202 to 11,150 feet. FP: July to August		S		G3S1?

TABLE 3.5-8

Known Habitat Requirements and Status of Species with Special FWS, BLM, State of Nevada, or NNHP Status Evaluated for Potential Habitat in the White Pine Energy Station Project Area

Scientific Name	Common Name	Known Habitat and Flowering Period (FP)	FWS ^a	BLM ^b	State of Nevada ^c	NNHP ^d
<i>Castilleja salsuginosa</i>	Monte Neva paintbrush	Alkaline meadows in damp, saline clay soils on hummocks and drainages of travertine hot springs with greasewood, gray rabbitbrush, and <i>Sporobolus airoides</i> . Elevation: 5,965 to 6,130 feet FP: June		S	CE	G1QS1
<i>Cryptantha welshii</i>	White River catseye	Dry, open, sparsely vegetated outcrops, and derived sandy to silty or clay soils, of whitish calcareous or carbonate deposits, often forming knolls or gravelly hills, and on soils adjacent to such habitats, mostly in <i>Juniperus - Artemisia - Chrysothamnus</i> vegetation. Elevation: 4,540 to 6,660 feet FP: May to June		S		G3S3
<i>Cymopterus basalticus</i>	Shadscale spring parsley	Bare basaltic rocks, barren clays, and (in Utah) gravelly hills and alluvial fans, mostly on dolomite. In the pinyon-juniper, sagebrush, and shadscale zones. Elevation: 5,800 to 6,900 feet FP: May to June				G2S1
<i>Draba oreibata</i> v. <i>serpentina</i>	Snake range whitlow cress	Gravelly or sandy calcareous soils, generally on moderate to steep slopes, associated with the zonal vegetation. Elevation: 5,700 to 9,900 feet FP: June to August			CE	T1G4S1
<i>Draba pedicellata</i>	Stalked whitlow cress	Carbonate crevices, scree and rocky soils, sometimes in litter under pine trees, usually on steep slopes, ridges in the pinyon-juniper, mountain mahogany, subalpine conifer, and alpine zones. Elevation: 4,800 to 10,200 feet FP: June to August				G3?S3?
<i>Draba pennellii</i>	Pennel draba	Crevices and ledges of carbonate or quartzite cliffs, outcrop faces, and ridges in the pinyon-juniper, subalpine, and alpine zones. Elevation: 6,200 to 11,800 feet FP: June to July				G2S2
<i>Ericameria watsonii</i>	Watson's goldenbush	Cliffs, rock outcrops, generally dry sites across a wide elevational range. Elevation: 4,500 to 10,400 feet FP: July to Sept.				G3G3S3
<i>Eriogonum holmgrenii</i>	Holmgren buckwheat	Crevices, talus, or rocky soils of limestone, quartzite, or granitic ridges and outcrops in the alpine zone. Elevation: 10,400 to 11,200 feet FP: July to August				G1S1

TABLE 3.5-8

Known Habitat Requirements and Status of Species with Special FWS, BLM, State of Nevada, or NNHP Status Evaluated for Potential Habitat in the White Pine Energy Station Project Area

Scientific Name	Common Name	Known Habitat and Flowering Period (FP)	FWS ^a	BLM ^b	State of Nevada ^c	NNHP ^d
<i>Frasera gypsicola</i>	Sunnyside green gentian	Open, dry, whitish, alkaline, often salt-crusted and spongy silty-clay soils on calcareous flats and barrens, with little if any gypsum content, in cushion-plant associations surrounded by sagebrush, greasewood vegetation. Elevation: 5,180 to 5,510 feet FP: May to July		S	CE	G1S1
<i>Jamesia tetrapetala</i>	Waxflower	Crevices in limestone cliffs. Elevation: 7,000 to 10,720 feet FP: June to August		S		G2S2
<i>Lesquerella pendula</i>	Hanging bladderpod	Gravelly carbonate (and possibly quartzite) ridge lines at high elevations. Growing on a gravel outwash fan of limestone origin. With <i>Juniperus</i> . Elevation: 10,500 feet FP: July				G2?S2?
<i>Opuntia pulchella</i>	Sand cholla	Sand of dunes, dry-lake borders, river bottoms, washes, valleys, and plains in the desert. Dependent on sand dunes or deep sand. Elevation: 3,950 to 6,300 feet FP: May to June			CY	G4S2S3
<i>Penstemon concinnus</i>	Tunnel Springs beardtongue	Gravelly alluvial soils in pinyon-juniper woodland. Elevation: 5,200 to 6,600 feet FP: May to June		S		G3S2
<i>Penstemon leiophyllus</i> v. <i>francisci-pennellii</i>	Pennel beardtongue	Rocky calcareous slopes, shaded banks. Occurs in dry, rocky alpine and subalpine slopes, alpine meadows, and associated with middle and upper elevation aspen stands. Elevation: more than 7,000 FP: July to August				T2G3S2
<i>Penstemon moriahensis</i>	Mount Moriah beardtongue	Open, gravelly, and/or silty carbonate soils in drainages, on gentle slopes, and on road banks or other recovering disturbances with enhanced runoff, in the subalpine conifer, subalpine sagebrush, mountain mahogany, and upper pinyon-juniper zones. Elevation: 7,100 to 10,800 feet FP: June to July				G1G2S1S2
<i>Penstemon palmeri</i> var. <i>micranthus</i>	Lahontan beardtongue	Along washes, roadsides, and canyon floors, particularly on carbonate-containing substrates, usually where subsurface moisture is available throughout most of the summer. Unknown if restricted to calcareous substrates. Elevation: 3,428 to 4,550 feet FP: May to June		S		T2?G4G5S2?

TABLE 3.5-8

Known Habitat Requirements and Status of Species with Special FWS, BLM, State of Nevada, or NNHP Status Evaluated for Potential Habitat in the White Pine Energy Station Project Area

Scientific Name	Common Name	Known Habitat and Flowering Period (FP)	FWS ^a	BLM ^b	State of Nevada ^c	NNHP ^d
<i>Penstemon patricus</i>	Dad's penstemon	In cracks and crevices in granitic cliffs and rocky slopes in pinyon-juniper, mountain mahogany, and spruce associations. Elevation: 6,500 to 10,500 feet FP: July				G2QS1
<i>Penstemon rhizomatosus</i>	Rhizome beardtongue	Crevice of cliffs and outcrops, or silty loam soil pockets in talus or scree, of carbonate rocks on steep slopes of various aspects in the subalpine conifer zone. Elevation: 10,000 to 11,250 feet FP: June to August				G1S1
<i>Phacelia parishii</i>	Parish phacelia	Moist to superficially dry, open, flat to hummocky, mostly barren, often salt-crusted silty-clay soils on valley bottom flats, lake deposits, and playa edges, often near seepage areas, sometimes on gypsum deposits, surrounded by saltbush scrub vegetation. Elevation: 2,190 to 5,922 feet FP: April to August		S		G2G3S2S3
<i>Poa abbreviata</i> ssp. <i>marshii</i>	Marsh bluegrass	Soil pockets in alpine scree and talus. Elevation: 11,600 feet FP: July				T2G5S1
<i>Primula cusickiana</i> v. <i>nevadensis</i>	Nevada primrose	Dry to moist, often sheltered carbonate cliffs, crevices, scree, and gravelly soils or soil pockets on gentle to vertical slopes, often on north to east aspects or in leeward snow-accumulation areas, sometimes in litter of bristlecone pines or in meadow or riparian areas, in the subalpine conifer and lower alpine zones. Elevation: 10,200 to 11,590 feet FP: June to August				T2G4S2
<i>Silene nachlingerae</i>	Nachlinger catchfly	Generally dry, exposed, or somewhat sheltered carbonate (rarely quartzite) crevices in ridgeline outcrops, talus, or very rocky soils on or at the bases of steep slopes or cliffs, on all aspects but predominantly on northwesterly to northeasterly exposures, mainly in the subalpine conifer zone. Elevation: 7,160 to 11,250 feet FP: July to August		S		G2S2

TABLE 3.5-8

Known Habitat Requirements and Status of Species with Special FWS, BLM, State of Nevada, or NNHP Status Evaluated for Potential Habitat in the White Pine Energy Station Project Area

Scientific Name	Common Name	Known Habitat and Flowering Period (FP)	FWS ^a	BLM ^b	State of Nevada ^c	NNHP ^d
<i>Smelowskia holmgrenii</i>	Holmgren smelowskia	Crevices, ledges, rubble, or small soils pockets on rock outcrops and cliffs, from high-elevation ridges to north-facing walls at lower elevations, on various rock types in the lower alpine, subalpine conifer, mountain sagebrush, and upper pinyon-juniper zones. Elevation: 6,500 to 11,350 feet FP: June to July				G2G3S2S3
<i>Spiranthes diluvialis</i>	Ute ladies'-tresses orchid	Moist to very wet, somewhat alkaline or calcareous native meadows near streams, springs, seeps, lake shores, or in abandoned stream meanders that still retain ample ground water, global elevation range. Elevation: 4,200 to 5,300 feet FP: July	LT	S	CE	G2SH
<i>Trifolium eriocephalum</i> v. <i>villiferum</i>	Woolly-head clover	Marches and alkaline meadows. Elevation: 4,000 to 7,400 feet FP: July				T2?G5S1S2
<i>Viola lithion</i>	Rock violet	Seasonally wet crevices in steep carbonate or quartzite outcrops in shaded northeast-facing avalanche chutes and cirque headwalls in the subalpine conifer zone. Elevation: 7,840 to 10,480 feet FP: June to July		S		G1S1

^a FWS: LT - Listed Threatened = likely to be classified as Endangered in the foreseeable future if present trends continue.

^b BLM: S - sensitive = FWS listed, proposed or Candidate for listing, or protected by Nevada state law.

^c State of Nevada: CE = Critically endangered - species threatened with extinction, whose survival requires assistance because of overexploitation, disease, or other factors, or because their habitat is threatened with destruction, drastic modification, or severe curtailment (N.R.S. 527.260-.300); CY = Protected as a cactus, yucca, or Christmas tree (N.R.S. 527.060-.120).

^d NNHP: G = Global rank indicator, based on worldwide distribution at the species level; T = Global trinomial rank indicator, based on worldwide distribution at the infraspecific level; S = State rank indicator, based on distribution within the state at the lowest taxonomic level; "1" = Critically imperiled because of extreme rarity, imminent threats, and/or biological factors; "2" = Imperiled because of rarity and/or other demonstrable factors; "3" = Rare and local throughout its range, or with very restricted range, or otherwise vulnerable to extinction; "4" = Apparently secure, although frequently quite rare in parts of its range, especially at its periphery; "5" = Demonstrably secure, though frequently quite rare in parts of its range, especially at its periphery; H = Historical occurrence(s) only, presumed still extant and could be rediscovered; "?" = Not yet ranked at the scale indicated (G, T, or S)

Potential Habitat for Special Status Plant Species

Potential habitat for 27 of the 31 special status plant species occurs in the project area. Four species were determined to have no potential to occur because they

grow at elevations well above those found in the project area or there is no potential habitat in the area. The potential habitat for special status species observed in the project area during surveys is described in Table 3.5-9.

Habitats in Steptoe Valley that have potential to support special status plant species include wet meadows, alkaline salt-crust meadows, greasewood playa pans, and sand dunes. The dominant plant species associated with these habitats are described in Section 3.5.1, *Vegetation*. The probability of occurrence for each species was evaluated and designated as no, low, medium, or high potential. This was assessed qualitatively based on reconnaissance-level surveys conducted for special status plant species habitat in the project area and review of soil survey mapping to determine where appropriate substrate might occur (USDA, 1998). Species range maps provided online by NNHP were examined to determine the distribution within the state (NNHP web site 2005). Probability of occurrence is defined in the following text.

High Probability. Species within or very near White Pine County and the Calcareous Mountains of eastern Nevada were assumed to have a higher probability of occurring in the project area if the species' habitat was also present in the project area. A species that occurred

farther away from White Pine County was assumed to have a significant range extension and thus have a lower likelihood of occurrence.

Medium Probability. A species was determined to have a medium potential to occur in the project area if its known distribution was outside White Pine County but suitable habitat was observed in the project area.

Low Probability. A species that occurred both farther away from White Pine County and had poor quality habitat in the project area was determined to have a low potential to occur in the project.

No Probability. Species for which no potential habitat was observed in the project area were considered to have no potential to occur in the project area.

The qualitative assessment of potential to occur resulted in 14 species with high potential, five species with medium potential, eight species with low potential, and four species with no potential to occur in the project area (Table 3.5-9).

TABLE 3.5-9

Potential Habitat and Potential For Occurrence of Special Status Plant Species in the White Pine Energy Station Project Area *

Scientific Name	Common Name	Potential For Occurrence	Observed Potential Habitat
<i>Arenaria congesta</i> <i>v. wheelerensis</i>	Mount Wheeler sandwort	No potential	The Egan Range impinges on the known lower elevation range for this species but there is no spruce-aspen habitat in the project area.
<i>Asclepias</i> <i>eastwoodiana</i>	Eastwood milkweed	Medium—range extension but habitat good	Some relatively barren areas with carbonate/andesitic/basaltic gravel and small washes and moisture accumulation areas occur throughout the Egan Range although only the southern SWIP both south and east of the corner on Bothwick Road were mapped as potential habitat because of the prevalence of barren gravel soils under pinyon-juniper woodland (Figure 3.5-1). Other potential habitat in the Egan Range in more dispersed and was not individually mapped.
<i>Astragalus</i> <i>diversifolius</i>	Meadow milkvetch	High—range and habitat good	Wet meadows and alkaline salt-crusted meadow habitat along Duck Creek drainage and tributary drainages near the Alternative 1 power plant site.
<i>Astragalus</i> <i>lentiginosus v.</i> <i>latus</i>	Broad-pod freckled milkvetch	High—range and habitat good	The Egan Range has shallow to steep slopes with limestone/dolomite (calcareous) gravel.
<i>Botrychium</i> <i>crenulatum</i>	Dainty moonwort	Low—range extension and habitat limiting	Steptoe Valley wet meadow habitats provide some potential habitat but the elevation is low and it was not determined if this species grows in alkaline soils.
<i>Castilleja</i> <i>salsuginosa</i>	Monte Neva paintbrush	High—range and habitat good	Alkaline salt-crusted meadow habitat along Duck Creek drainage and tributary drainages near the Alternative 1 power plant site. Habitats are similar to habitat at nearby known locations for this species at Monte Neva hot springs.
<i>Cryptantha welshii</i>	White River cats eye	High—range and habitat good	White stabilized salt-crusted sand dunes associated with Greasewood Playa occur along the Proposed Action water pipeline route in Steptoe Valley.
<i>Cymopterus</i> <i>basalticus</i>	Shadscale spring parsley	Medium—range good but good Nevada habitat not observed	The Egan Range has an array of andesitic/basaltic alluvial gravel and dolomitic gravel although basaltic rock and barren clay are not obvious in the project area. However, some appropriate substrates may still be present.
<i>Draba pedicellata</i>	Stalked whitlow cress	High—range and habitat good	The Egan Range has an array of limestone/dolomite (calcareous) gravelly, rocky soils, and outcrops on steep slopes.
<i>Draba oreibata v.</i> <i>serpentina</i>	Snake range whitlow cress	High—range and habitat good	The Egan Range has an array of limestone/dolomite (calcareous) gravelly, rocky soils and outcrops on steep slopes.
<i>Draba pennellii</i>	Pennel draba	High—range and habitat good	The Egan Range has shallow to steep slopes with limestone/dolomite (including some carbonate and quartzite rock) soils and rocky outcrops.

TABLE 3.5-9

Potential Habitat and Potential For Occurrence of Special Status Plant Species in the White Pine Energy Station Project Area *

Scientific Name	Common Name	Potential For Occurrence	Observed Potential Habitat
<i>Ericameria watsonii</i>	Watson's goldenbush	High—range and habitat good	The Egan Range both east and west of Butte Valley has gravelly dry soils that may support this species. No information was found on whether this species has affinities to specific parent material/soils. Therefore, this species can potentially occur over a greater range of conditions than most species on this list.
<i>Eriogonum holmgrenii</i>	Holmgren buckwheat	Low—range good but elevation too low	The Egan Range has shallow to steep slopes with limestone/dolomite (including some carbonate and quartzite rock) rocky soils, talus and outcrops. However, the Egan Range elevations are perhaps too low for this species. There is a very low potential for this species to occur in the project area.
<i>Frasera gypsicola</i>	Sunnyside green gentian	High—range and habitat good	Alkaline salt-crusted meadow habitat along Duck Creek drainage and tributary drainages near the Alternative 1 power plant site.
<i>Jamesia tetrapetala</i>	Waxflower	High—range and habitat good	The Egan Range has numerous small limestone/dolomite outcrops that potentially can support this species.
<i>Lesquerella pendula</i>	Hanging bladderpod	Low—range unknown and elevations too low	The Egan Range provides gravelly carbonate rock in somewhat narrow seasonal drainages lined with juniper but these occur at elevations well below the known elevation range for this species.
<i>Opuntia pulchella</i>	Sand cholla	Medium—range extension and habitat is limited	White stabilized salt-crusted sand dunes associated with Greasewood Playa occur along the Proposed Action water pipeline route in Steptoe Valley. The leeward slopes of dune are often destabilized into loose sand that could support this species. Loose sand infrequently observed.
<i>Penstemon concinnus</i>	Tunnel Springs beardtongue	Medium—range and habitat good	The Egan Range both east and west of Butte Valley has gravelly alluvial soils supporting Pinyon-Juniper Woodland although most of these woodlands occur above 6,800 feet elevation. No information was found on whether this species has affinities to specific parent material/soils. Therefore, this species could potentially occur over a greater range of conditions than most species on this list.
<i>Penstemon leiophyllus</i> v. <i>francisci-pennellii</i>	Pennel beardtongue	Low—range extension and habitat limiting	The Egan Range does not have wetland habitats with the exception of the thoroughly disturbed Dry Springs. Aspen stands and subalpine habitats are not present even though rocky calcareous slopes are abundant. Low to no potential.
<i>Penstemon moriahensis</i>	Mount Moriah beardtongue	High—range and habitat good	The Egan Range has gravelly carbonitic substrates in seasonal drainages.

TABLE 3.5-9

Potential Habitat and Potential For Occurrence of Special Status Plant Species in the White Pine Energy Station Project Area *

Scientific Name	Common Name	Potential For Occurrence	Observed Potential Habitat
<i>Penstemon palmeri</i> v. <i>micranthus</i>	Lahontan beardtongue	Low—range extension and elevation too high	Steptoe Valley wet meadow and salt-crustured meadows provide suitable subsurface moisture although elevations in Steptoe Valley are roughly 1,500 feet higher than the known elevation range for this species.
<i>Penstemon patricus</i>	Dad's penstemon	No potential	No granitic parent material exists in the project area based on the White Pine County soil survey. No potential exists for this species to occur in the project area.
<i>Penstemon rhizomatosus</i>	Rhizome beardtongue	Low—range good but elevation too low	The Egan Range has shallow to steep slopes with limestone/dolomite (including some carbonate and quartzite rock) rocky soils, talus, and outcrops. However, the Egan Range elevations are perhaps too low for this species, so there likely is low potential.
<i>Phacelia parishii</i>	Parish phacelia	High—range and habitat good	Near Duck Creek and the Proposed Action water pipeline with low areas, including some hummocky loess areas, having a shallow water table (<i>Agropyron</i> , <i>Juncus</i> , <i>Distichlis</i>) interspersed with <i>Sarcobatus</i> , <i>Atriplex</i> , <i>Chrysothamnus</i> . Transitional between salt-crustured silty alkali meadow and Greasewood Scrub. Playa edge/ Greasewood scrub habitat is widespread but not particularly abundant along the Proposed Action water pipeline route. Elevations in the project area are far too low for this species.
<i>Poa abbreviata</i> ssp. <i>marshii</i>	Marsh bluegrass	No potential	Elevations in the project area are far too low for this species.
<i>Primula cusickiana</i> v. <i>nevadensis</i>	Nevada primrose	No potential	The Egan Range has limestone/dolomite substrates and outcrop habitats but elevation of the Egan Range is perhaps too low for this species.
<i>Silene nachlingerae</i>	Nachlinger catchfly	High—range and habitat good	The Egan Range has limestone-dolomite outcrops and talus slopes that may support this species.
<i>Smelowskia holmgrenii</i>	Holmgren smelowskia	Medium—range extension but habitat good	The Egan Range has outcrop habitats of limestone bedrock at appropriate elevations and associated vegetation.
<i>Spiranthes diluvialis</i>	Ute ladies'-tresses orchid	Low—range extension and soils probably limiting	Steptoe Valley has wet meadows and salt-crustured wetland habitats. Portions of Duck Creek have multiple side channels and a variety of moisture regimes. The wet habitats may be too saline or too alkaline for this species.
<i>Trifolium eriocephalum</i> v. <i>villiferum</i>	Woolly-head clover	High—good habitat, known range uncertain	Steptoe Valley has wet meadows and salt-crustured wetland habitats.
<i>Viola lithion</i>	Rock violet	Low—range good but habitat is limited	Egan Range has limestone outcrops but only in one location (just outside the SWIP corridor) was seasonal wetness associated with limestone outcrop.

* See text for discussion of how potential for occurrence was determined

3.6 Air Quality, Climate Change, and Noise

3.6.1 Air Quality

This section describes the existing meteorological and air quality conditions in and around the proposed White Pine Energy Station and existing emission sources. The area around the proposed project incorporates portions of White Pine County in Nevada, approximately 30 miles north of Ely. The primary factors that determine air quality of a region are the locations of the air pollution emission sources, amounts of pollutants emitted, types of pollutants emitted, and local meteorological conditions over a period of time.

3.6.1.1 Background Data

The Clean Air Act requires the EPA to set National Ambient Air Quality Standards (NAAQS) for pollutants considered harmful to public health and the environment. The Clean Air Act established two types of national air quality standards. Primary standards set limits to protect public health, including the health of "sensitive" populations (for example, asthmatics, children, and the elderly) against the effects of the pollutants noted below. Secondary standards set limits to protect public welfare, including protection against decreased visibility, damage to animals, crops, vegetation, and buildings. The EPA has established NAAQS for six principal pollutants, which are called "criteria" pollutants. They are particulate matter, carbon monoxide, ozone, sulfur dioxide, nitrogen dioxide, and lead. The existing air quality in the region of the proposed White Pine Energy Station is in attainment for all NAAQS. Figure 3.6-1 shows the non-attainment and Class I areas in Nevada and Utah. In addition, two Class II areas of interest (Ruby Lake National Wildlife Area

and Great Basin National Park) have also been included. (The Clean Air Act designated certain regions of the country as Federal Mandatory Class I areas (Class I areas). These Class I areas are to be afforded the highest level of air-quality protection. Congress designated 158 areas as Class I areas, which include national parks larger than 6,000 acres and Wilderness Areas larger than 5,000 acres, in existence on August 7, 1977. Class II areas are essentially all areas that are not designated Class I by Congress. Class II areas could include rural and urban areas, lands managed by cities or state agencies (for example city or state parks), land managed by the federal government (for example, National Parks, Forest Service and BLM lands, Wilderness Areas, and Roadless Areas) that have not been designated as Class I.)

The following subsections provide baseline data with respect to criteria pollutant concentrations, hazardous air pollutant concentrations, and existing emission sources in the area of the Proposed Action.

3.6.1.1.1 Particulate Matter

Particulate Matter Less than or Equal to 10 Microns in Diameter (PM₁₀)

EPA has adopted NAAQS for particulate matter of 10 microns or less (PM₁₀). Sources of PM₁₀ include the following:

- Stationary point sources, such as fuel combustion and industrial processes
- Fugitive sources, such as roadway dust from paved and unpaved roads
- Wind erosion from open land
- Transportation sources, such as automobiles

PM₁₀ is monitored in Ely and Elko. None of the annual averages at these locations have exceeded the annual standard. WPEA has collected 1 year of onsite ambient air quality

data. The ambient air quality data show a maximum PM₁₀ 24-hour average concentration of 30 micrograms per cubic meter ($\mu\text{g}/\text{m}^3$) and an annual average concentration of $10 \mu\text{g}/\text{m}^3$.

Ambient PM₁₀ has also been monitored in Great Basin National Park since 1993. The most recent 3 years of available data (collected in 2002 through 2004) show maximum recorded 24-hour values for each year of $104.62 \mu\text{g}/\text{m}^3$, $17.48 \mu\text{g}/\text{m}^3$, and $17.05 \mu\text{g}/\text{m}^3$, respectively. In contrast, the NAAQS for PM₁₀ is $150 \mu\text{g}/\text{m}^3$ on a 24-hour average basis, not to be exceeded more than once per year on average over 3 years. For the same period, the highest annual average PM₁₀ concentration was $7.25 \mu\text{g}/\text{m}^3$, the annual average for 2002. In contrast, the NAAQS for PM₁₀ is $50 \mu\text{g}/\text{m}^3$ on an annual averaging period, calculated as the annual arithmetic mean. It should be noted that for the annual averaging period, the federal PM₁₀ standard has been revoked and only the Nevada state PM₁₀ standard, which is identical to the federal standard, is applicable.

Fine Particulate Matter (PM_{2.5})

Particles less than 2.5 micrometers in diameter (PM_{2.5}) are referred to as "fine" particles and are regulated under the Clean Air Act. Sources of fine particles include all types of combustion activities (motor vehicles, power plants, wood burning, etc.) and certain industrial processes.

Ambient concentrations of PM_{2.5} are monitored in Great Basin National Park. The most recent 3 years of available, quality-assured data from this monitoring station (2002 through 2004) show a 24-hour PM_{2.5} concentration of $7.3 \mu\text{g}/\text{m}^3$, based on the 3-year average of the 98th percentile impact in accordance with the 24-hour NAAQS standard. The highest annual averaging period impact for the same time period is

$3.0 \mu\text{g}/\text{m}^3$. For comparison, the NAAQS for PM_{2.5} are $35 \mu\text{g}/\text{m}^3$ on a 24-hour average basis, and $15 \mu\text{g}/\text{m}^3$ on an annual basis.

3.6.1.1.2 Ozone

Ozone is not emitted directly into the atmosphere, but rather is produced through a reaction involving volatile organic compounds (VOCs) and nitrogen oxides, known as precursors, and sunlight. Because ozone formation results from the mixing of precursors and generally occurs downwind from the emission sources, ozone is more of a regional concern than that associated with more localized sources of pollution such as PM₁₀. Ozone can be "beneficial" or "harmful," depending on its location in the atmosphere. In the earth's lower atmosphere, ground-level ozone is considered "harmful." "Beneficial" ozone occurs naturally in the stratosphere approximately 10 to 30 miles above the earth's surface and forms a layer that protects life on earth from the sun's harmful rays.

Motor vehicle exhaust and industrial emissions, gasoline vapors, and chemical solvents as well as natural sources emit nitrogen oxides and VOCs that help form ozone. Sunlight and hot weather cause ground-level ozone to form in harmful concentrations in the air. As a result, it is known as a summertime air pollutant. The primary sources of ground-level ozone precursors are motor vehicles (EPA, 1993). Secondary sources include gasoline marketing and storage areas for VOC, and power plants and industrial boilers for nitrogen oxides.

All areas within the region around the Station project area are designated as "attainment" for the ozone NAAQS. Table 3.6-1 lists ozone values measured at Great Basin National Park, which is approximately 57 miles southeast of the Station project area.

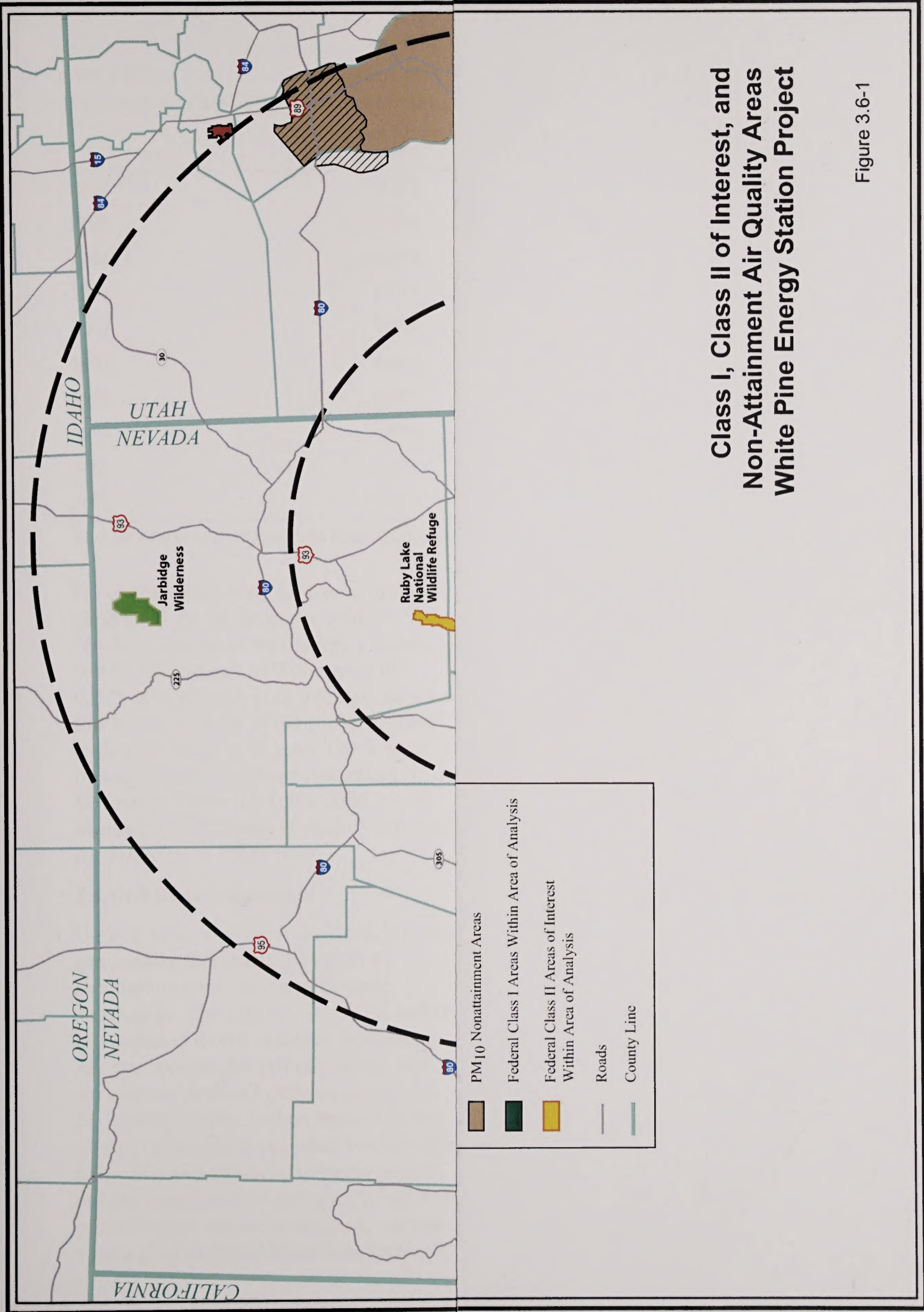

Class I, Class II of Interest, and Non-Attainment Air Quality Areas White Pine Energy Station Project

Figure 3.6-1

data. The ambient air quality data show a maximum PM₁₀ 24-hour average concentration of 30 micrograms per cubic meter ($\mu\text{g}/\text{m}^3$) and an annual average concentration of $10 \mu\text{g}/\text{m}^3$.

Ambient PM₁₀ has also been monitored in Great Basin National Park since 1993. The most recent 3 years of available data (collected in 2002 through 2004) show maximum recorded 24-hour values for each year of $104.62 \mu\text{g}/\text{m}^3$, $17.48 \mu\text{g}/\text{m}^3$, and $17.05 \mu\text{g}/\text{m}^3$, respectively. In contrast, the NAAQS for PM₁₀ is $150 \mu\text{g}/\text{m}^3$ on a 24-hour average basis, not to be exceeded more than once per year on average over 3 years. For the same period, the highest annual average PM₁₀ concentration was $7.25 \mu\text{g}/\text{m}^3$, the annual average for 2002. In contrast, the NAAQS for PM₁₀ is $50 \mu\text{g}/\text{m}^3$ on an annual averaging period, calculated as the annual arithmetic mean. It should be noted that for the annual averaging period, the federal PM₁₀ standard has been revoked and only the Nevada state PM₁₀ standard, which is identical to the federal standard, is applicable.

Fine Particulate Matter (PM_{2.5})

Particles less than 2.5 micrometers in diameter (PM_{2.5}) are referred to as "fine" particles and are regulated under the Clean Air Act. Sources of fine particles include all types of combustion activities (motor vehicles, power plants, wood burning, etc.) and certain industrial processes.

Ambient concentrations of PM_{2.5} are monitored in Great Basin National Park. The most recent 3 years of available, quality-assured data from this monitoring station (2002 through 2004) show a 24-hour PM_{2.5} concentration of $7.3 \mu\text{g}/\text{m}^3$, based on the 3-year average of the 98th percentile impact in accordance with the 24-hour NAAQS standard. The highest annual averaging period impact for the same time period is

$3.0 \mu\text{g}/\text{m}^3$. For comparison, the NAAQS for PM_{2.5} are $35 \mu\text{g}/\text{m}^3$ on a 24-hour average basis, and $15 \mu\text{g}/\text{m}^3$ on an annual basis.

3.6.1.1.2 Ozone

Ozone is not emitted directly into the atmosphere, but rather is produced through a reaction involving volatile organic compounds (VOCs) and nitrogen oxides, known as precursors, and sunlight. Because ozone formation results from the mixing of precursors and generally occurs downwind from the emission sources, ozone is more of a regional concern than that associated with more localized sources of pollution such as PM₁₀. Ozone can be "beneficial" or "harmful," depending on its location in the atmosphere. In the earth's lower atmosphere, ground-level ozone is considered "harmful." "Beneficial" ozone occurs naturally in the stratosphere approximately 10 to 30 miles above the earth's surface and forms a layer that protects life on earth from the sun's harmful rays.

Motor vehicle exhaust and industrial emissions, gasoline vapors, and chemical solvents as well as natural sources emit nitrogen oxides and VOCs that help form ozone. Sunlight and hot weather cause ground-level ozone to form in harmful concentrations in the air. As a result, it is known as a summertime air pollutant. The primary sources of ground-level ozone precursors are motor vehicles (EPA, 1993). Secondary sources include gasoline marketing and storage areas for VOC, and power plants and industrial boilers for nitrogen oxides.

All areas within the region around the Station project area are designated as "attainment" for the ozone NAAQS. Table 3.6-1 lists ozone values measured at Great Basin National Park, which is approximately 57 miles southeast of the Station project area.

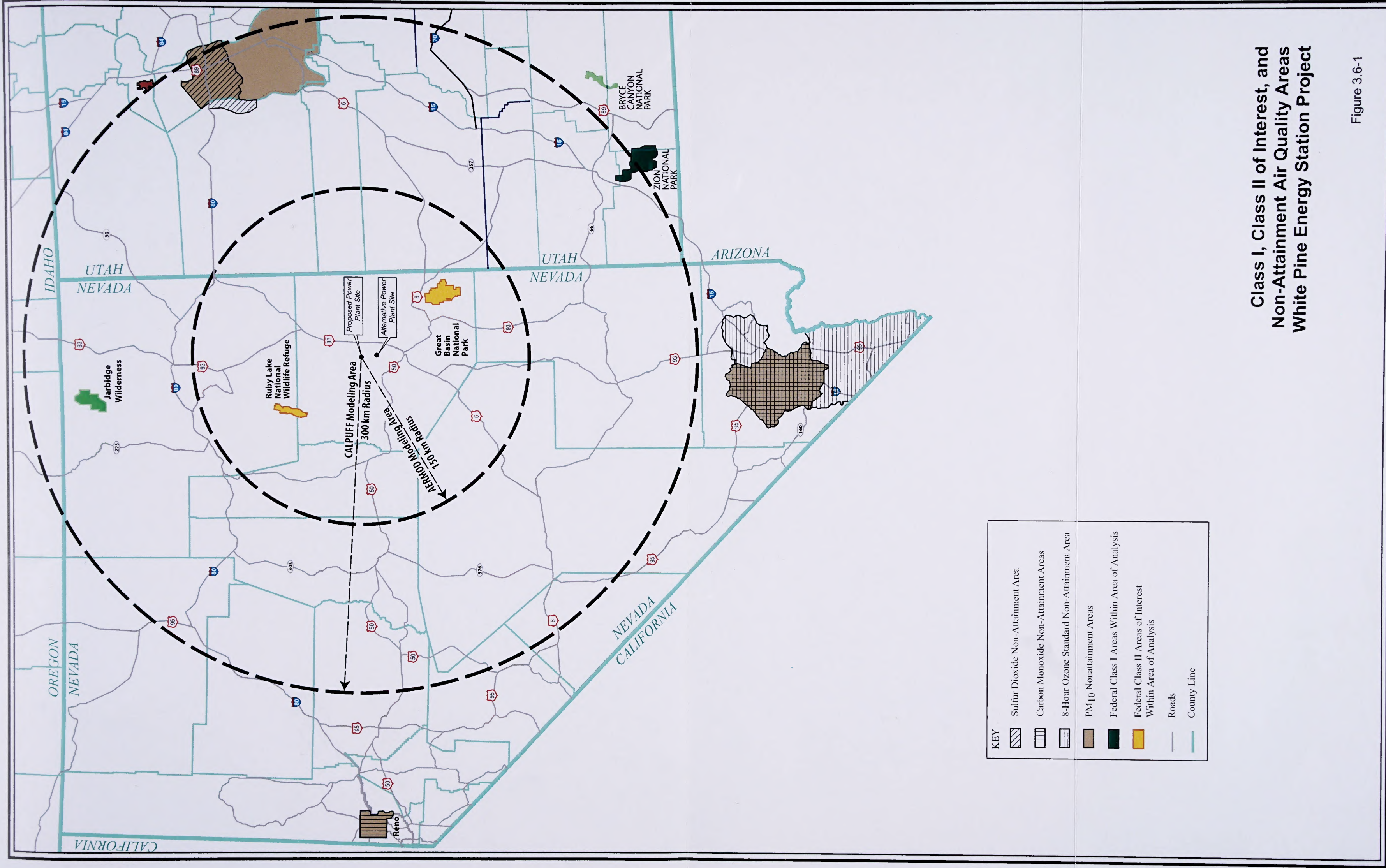

KEY	
	Sulfur Dioxide Non-Attainment Area
	Carbon Monoxide Non-Attainment Areas
	8-Hour Ozone Standard Non-Attainment Area
	PM10 Nonattainment Areas
	Federal Class I Areas Within Area of Analysis
	Federal Class II Areas of Interest Within Area of Analysis
	Roads
	County Line

Class I, Class II of Interest, and Non-Attainment Air Quality Areas White Pine Energy Station Project

TABLE 3.6-1

Great Basin National Park CASTNet Ozone Monitoring Data

Year	4th Highest 8-Hour Ozone (ppm)	3-Year Average (ppm)
2006	0.072	0.072
2005	0.073	0.072
2004	0.072	0.072
2003	0.071	0.071
2002	0.074	0.073
2001	0.067	0.072
2000	0.077	0.073
1999	0.072	0.072
1998	0.070	
1997	0.074	

Source: EPA's AIRDATA website (<http://iaspub.epa.gov/>), Monitoring Station 320330101

No onsite monitoring for ozone has been conducted for the proposed Station. The NAAQS for ozone was recently lowered from 0.08 part per million (ppm) to 0.075 ppm on an 8-hour average, based on the 3-year average of the fourth highest daily maximum each year. The 1-hour ozone NAAQS has been rescinded. As can be seen in Table 3.6-1, the 2006 3-year average of 0.072 ppm is slightly less than the NAAQS of 0.075 ppm.

3.6.1.1.3 Carbon Monoxide

Carbon monoxide is an odorless, invisible gas usually formed as the result of incomplete combustion of organic substances. The primary source of carbon monoxide is motor vehicles. Secondary sources include aircraft emissions, and agricultural and/or forest burning. As is particulate matter, carbon monoxide is more of a localized pollutant because of its buoyancy and ability to disperse under normal conditions. However, during those periods when the air is stagnant, such as with a ground-based inversion, levels of

carbon monoxide can increase. Levels of carbon monoxide are usually highest during the winter when inversions are more frequent.

All areas within the region around the Station project area are designated as "attainment" for the carbon monoxide NAAQS. No onsite monitoring of carbon monoxide was conducted. The NAAQS for carbon monoxide are 9 parts per million (ppm) on an 8-hour average and 35 ppm on a 1-hour average, both not to be exceeded more than once per year.

3.6.1.1.4 Sulfur Dioxide

Sulfur dioxide is formed during the combustion of sulfur bearing materials, such as sulfur ores or fossil fuels. Sources that emit large quantities of sulfur contribute to ambient concentrations of sulfur dioxide. The primary sources of sulfur dioxide are electrical generation, fossil fuel combustion, and industrial process (EPA, 2008a). Levels of sulfur dioxide in the project area can be expected

to be very low because of the lack of major sources. WPEA has collected 1 year of onsite ambient air quality data. The ambient air quality data for sulfur dioxide show a maximum 3-hour average concentration of 0.0163 parts per million (ppm) ($42.6 \mu\text{g}/\text{m}^3$), a 24-hour average concentration of 0.003 ppm ($8.0 \mu\text{g}/\text{m}^3$), and an annual average concentration of 0.001 ppm ($2.7 \mu\text{g}/\text{m}^3$). The NAAQS for sulfur dioxide are 0.5 ppm 3-hour average not to be exceeded more than once per year, 0.14 ppm 24-hour average not to be exceeded more than once per year, and 0.03 ppm annual arithmetic mean.

3.6.1.1.5 Nitrogen Dioxide

As is the case with carbon monoxide and sulfur dioxide, levels of nitrogen dioxide can be expected to be well below the NAAQS. All areas within the region around the Station project area are designated as "attainment" for the NAAQS established for nitrogen dioxide.

WPEA has collected onsite ambient air quality data for nitrogen dioxide. The ambient air quality data from the onsite monitoring show a maximum nitrogen dioxide annual average concentration of $1.9 \mu\text{g}/\text{m}^3$. The NAAQS is $100 \mu\text{g}/\text{m}^3$ (0.053 ppm) annual arithmetic mean. Note that measurements of emission rates are stated as oxides of nitrogen because other oxides convert to nitrogen dioxide in the atmosphere.

3.6.1.1.6 Lead

The main sources of lead emissions are vehicles fueled with leaded gasoline and/or lead smelters. Because no lead smelters and very few vehicles using leaded fuel operate in the region, levels of lead can be expected to be well below the NAAQS.

NDEP has not required WPEA to monitor for lead prior to submitting an air permit application because predicted concentrations from the power plant are below the significant monitoring level of $0.1 \mu\text{g}/\text{m}^3$. NDEP monitored for lead from 1982 to 1987 at Lehman Cave (located in Great Basin National Park). Monitored values were well below $0.1 \mu\text{g}/\text{m}^3$. Since 1987, no increase in ambient lead would be expected because of the lack of population growth in the area and the phasing out of leaded gasoline.

3.6.1.1.7 Mercury

Mercury is a naturally occurring element found in the earth's crust. Mercury can be released to the environment through any mechanism that exposes crustal material to the surface. Such mechanisms are both natural and anthropogenic (human-caused) in origin and may include mercury mining and processing (primary mercury production), mining of other metals where mercury is produced as a byproduct (secondary mercury production), coal combustion, forest fires, soil or rock weathering, soil/air interface, and ocean/air interface. Additionally, mercury may be released to the environment through spills of mercury-containing chemicals or through improper disposal of mercury-containing equipment such as thermometers or mercury switches.

Mercury emissions and subsequent deposition rates are a global issue. Approximately one-third of global mercury emissions are natural in origin (for example, from oceans or volcanoes) and are not caused by human activities (EPA, 2007a). EPA estimates that about one-third of U.S. emissions are deposited within the contiguous U.S., and the remainder enters the global cycle (EPA, 2007c). Therefore, mercury deposited in a given area may originate from natural

sources, local anthropogenic sources, or other anthropogenic sources comprising the global mercury emissions pool.

Mercury Emissions Trends in Nevada

Mercury is geologically concentrated in regions associated with volcanic activity, high heat flow, and plate tectonic boundaries, and is commonly found associated with gold deposits (Jones and Miller, 2005). All of these conditions exist in Nevada.

Nevada is home to a broad “mercury belt” that consists of numerous mercury deposits scattered throughout several tens of thousands of square kilometers, primarily in western and central Nevada (Gray et al., 1999). Because of the presence of this mercury belt, mercury mining in Nevada has historically been an important industry in the state. The last mercury mine in the U.S. where mercury was produced as the primary product was the McDermitt mine in northern Nevada. That mine shut down in 1990 after providing 448 metric tons of mercury that year (Jones and Miller, 2005). The dominant environmental concern associated with these mercury mines is inorganic mercury in cinnabar ore and elemental mercury remaining at the mine sites that may potentially erode into streams and rivers (Gray et al., 1999).

Additionally, mercury has long been associated with gold mining, and in 2003, over 80 percent of gold production in the U.S. came from Nevada mines.

Historically, mercury was used to extract gold from ore. Currently, mercury is a byproduct of gold production and is sold to companies who may further purify the mercury for sale to customers. Mercury may be released to the environment from several points in the gold production

process, such as mining, roasting, activated carbon regeneration, retorting, waste rock dumps, and tailings facilities (Jones and Miller, 2005).

Mining companies in Nevada were first required to report mercury emissions to the EPA in 1999. Motivated by the high reported emission rates, EPA Region 9, Nevada Division of Environmental Protection (NDEP), and Nevada mining companies worked together to implement a Voluntary Mercury Reduction Program (VMRP), which ultimately reduced mercury emissions from the mines from a baseline of over 21,000 pounds per year in 2001 to less than 3,800 pounds per year in 2004 (NDEP, 2005). Further statewide mercury emissions reductions are expected in the future because of multiple new regulations in effect, including Nevada’s Mercury Air Emissions Control Program (NMCP) for the mining industry. The NMCP will require additional controls and reporting for Nevada’s mining industry.

Existing Mercury Levels in Nevada

No ambient air monitoring for mercury has been conducted at the proposed White Pine Energy Station project site or in White Pine County. Mercury concentrations and dry deposition rates at Gibbs Ranch (approximately 215 kilometers north of the proposed Station site) were measured in a recent study and are summarized in Table 3.6-2.

NDOW conducts monitoring for mercury in fish tissue around the state. The most recent available NDOW fish tissue monitoring results for water bodies in White Pine County are provided in Table 3.6-3. NDOW’s monthly fish consumption limits based on methylmercury content are provided in Table 3.6-4.

TABLE 3.6-2

Mercury (Hg) Concentrations and Dry Deposition Rates at Gibbs Ranch (24-Hour Averaging Period)

Month and Year	Elemental Hg ($\mu\text{g}/\text{m}^3$)	Oxidized Hg ($\mu\text{g}/\text{m}^3$)	Particulate Hg ($\mu\text{g}/\text{m}^3$)	Total Hg ($\mu\text{g}/\text{m}^3$)	Dry Hg Deposition on Soil (kg/ha/yr)
March 2005	0.0022	0.002	0.027	0.031	0.000002
July 2005	0.0035	0.012	0.012	0.028	Not measured
August 2005 *	0.0024	0.009	0.012	0.023	-0.000041
October 2005	0.0020	0.004	0.003	0.009	0.000019
Maximum	0.0035	0.012	0.027	0.031	0.000019

Source: Lyman, et al., 2007.

* For August 2005, the measured direction of mercury flux was from the soil to the air.

TABLE 3.6-3

Mercury Fish Tissue Test Results in White Pine County from NDOW for 2006*

Waterbody	Fish Species	Methylmercury Content (ppm wet)
Bassett Lake	Northern pike	0.03
	Largemouth bass	0.02
	Carp	0.03
Comins Lake	Northern pike	1.20
	Largemouth bass	1.25
	Rainbow trout	0.85
Snake Creek	Brown trout	0.08

* Source: NDOW website at http://ndow.org/fish/health/Mercury_Results_05_06.pdf

TABLE 3.6-4

NDOW Suggested Monthly Fish Consumption Limits

Methylmercury in Fish Tissue (ppm wet)	Fish Consumption Limit (meals per month)
0 - 0.029	Unrestricted (>16)
>0.029 - 0.059	16
>0.059 - 0.078	12
>0.078 - 0.12	8
>0.12 - 0.23	4
>0.23 - 0.31	3
>0.31 - 0.47	2
>0.47 - 0.94	1
>0.94 - 1.9	0.5
>1.9	None (<0.5)

Source: NDOW, 2007

As shown in the tables, methylmercury levels in fish tissue in White Pine County range from low concentrations corresponding to a suggested consumption limit of 16 or more meals per month for Bassett Lake to comparatively high concentrations corresponding to a suggested consumption limit of 0.5 meal per month for Comins Lake, which is just south of Ely. The relatively high methylmercury levels in fish at Comins Lake have been preliminarily determined by NDOW, EPA, and NDEP to be the result of mercury contamination from two abandoned mining sites in the lake's drainage area. An EPA report on this issue is expected to be published in the near future. The NDEP has recently released a draft 2006 303(d) list of Clean Water Act impaired waters. Comins Lake is included on the list.

3.6.1.1.8 Volatile Organic Compounds

The term "volatile organic compound" (VOC) means any compound of carbon, excluding carbon monoxide, carbon dioxide, carbonic acid, metallic carbides or carbonates, and ammonium carbonate, which participates in atmospheric photochemical reactions (see 40 CFR §51.100(s) for a complete definition, including a list of compounds excluded from the definition). VOCs include a variety of chemicals, some of which may have short-term and/or long-term adverse health effects. Concentrations of many VOCs are consistently higher indoors (up to ten times higher) than outdoors. VOCs are emitted by combustion as well as a wide array of products including paints and lacquers, paint strippers, cleaning supplies, petroleum fuels such as gasoline, pesticides, and building materials. Some VOC compounds are also listed as

hazardous air pollutants (HAPs) under Section 112 of the Clean Air Act.

3.6.1.1.9 Hazardous Air Pollutants

Hazardous air pollutants (HAPs), also known as toxic air pollutants or air toxics, are those pollutants that cause or may cause cancer or other serious health effects, such as reproductive effects or birth defects, or adverse environmental and ecological effects.

Most HAPs originate from human-made sources, including factories, refineries, power plants, cars, trucks, and buses.

3.6.1.1.10 VOC and Hazardous Pollutants Monitoring Data

No ambient air monitoring data for VOCs, mercury, or HAPs are available in the vicinity of the proposed Station site. Background air concentrations for these compounds are assumed to be negligible based on the geographic disbursement of other emission sources in the region.

3.6.1.1.11 Other Background Data

In addition to data collected by WPEA, visibility and deposition data are also available as part of the Interagency Monitoring of Protected Visual Environments (IMPROVE) network. Visual air quality in Great Basin National Park, Zion National Park, and Jarbidge Wilderness Area has been monitored using aerosol samplers. The visibility and deposition data collected at Great Basin National Park would be representative of existing conditions of visibility and deposition in Steptoe Valley. A summary of data from these three monitoring locations is shown in Table 3.6-5.

The visibility data can be obtained from VIEWS (2008).

TABLE 3.6-5

Summary of IMPROVE Data

Class I Area	Years	Period Averages			Percent Contributions of the Major Aerosol Components					
		Total Beta Extinction (Mm-1)	Standard Visual Range (km)	Deciviews	Ammonium Sulfate	Ammonium Nitrate	Organic Matter	Light Absorbing Carbon	Soil	Coarse Mass
Great Basin NP	1998 - 2004	20.1	198.4	6.6	10.9%	2.9%	20.9%	2.2%	10.3%	52.6%
Jarbridge WA	1998 - 2004	21.7	205.4	7.0	7.4%	1.8%	16.9%	1.3%	12.8%	59.6%
Zion NP	2001 - 2003	16.5	239.3	5.0	10.7%	4.2%	13.1%	3.3%	10.3%	58.3%

3.6.1.2 Meteorological Conditions

In accordance with the approved Nevada Bureau of Air Pollution Control protocol, WPEA collected 1 year of site-specific meteorological surface data near the Station Proposed Action site for use in the air quality impact analysis. The onsite data collection began January 6, 2005, and ended January 5, 2006. WPEA's year of site-specific meteorological data has been reviewed and approved by the NDEP.

The AERMOD Meteorological Preprocessor (AERMET, version 04300) was used to generate AERMOD compatible hourly surface and profile meteorological files. Data were processed with the upper air data from the National Weather Services station located in Elko, Nevada (WBAN 04105), and the surface data from the National Weather Services station located at the Ely Regional Airport (Yelland Field) (WBAN 23154).

The Station site has an arid to semi-arid continental climate with mild winters and mild summers (Table 3.6-6). The regional topography of the area tends to channel winds in a south-to-north direction. The

mountains to the east and southwest also tend to affect the regional climate. The average annual temperature in the area is approximately 46°F. The average maximum temperature in July is approximately 87°F with maximum readings occasionally over 100°F. The average minimum temperature in January is approximately 9°F with minimum readings generally below 30°F. Average annual precipitation is approximately 10 inches (Table 3.6-6).

Surface winds in the region are characterized by prevailing south-north winds with an average annual speed of approximately 2.2 to 2.5 miles per hour. Wind speeds are lowest in the third quarter of the year with an average of approximately 1.8 miles per hour. October to December is typically the windiest season with an average wind speed of approximately 2.7 miles per hour. Figure 3.6-2 shows a wind rose for the Station project area based on collected onsite data. The wind rose graphically depicts a plot of 1 year of hourly wind speed and vector recordings collected at a 10-meter height.

TABLE 3.6-6
Average Minimum and Maximum Temperature and Precipitation

	Temperature (°F)		Precipitation (inches)	
	Ely	Elko	Ely	Elko
Monthly Mean				
January	9 to 40	13 to 37	0.70	0.98
February	15 to 44	20 to 43	0.65	0.80
March	20 to 48	25 to 50	0.96	0.96
April	26 to 57	30 to 59	1.00	0.82
May	34 to 67	37 to 69	1.15	1.00
June	41 to 79	45 to 80	0.88	0.91
July	48 to 87	50 to 91	0.69	0.33
August	47 to 84	49 to 89	0.83	0.65
September	37 to 75	39 to 78	1.01	0.62
October	28 to 64	30 to 66	0.89	0.65
November	19 to 49	23 to 49	0.67	1.11
December	11 to 41	14 to 37	0.7	1.10
Annual Mean				
	28.0 to 61.2	31.1 to 62.4	10.13	9.93

Source: Based on 1961-1990 period of record from website www.climate-zone.com.

3.6.1.3 Existing Emission Sources

For the NAAQS and Class II PSD increment evaluations, the nearby source inventory was created from data provided by the NDEP and the Utah Department of Environmental Quality-Division of Air Quality (UDEQ-DAQ). The PSD air permitting process required WPEA to include in its model those emission sources (“nearby sources”) which are located within an area extending 50 kilometers beyond the most distant “PSD significant impact” from the White Pine Energy Station. (The “PSD significant impact” is the pollutant concentration level that is sufficiently high to require a cumulative PSD analysis to

demonstrate compliance with the NAAQS and PSD increments.) The most distant “PSD significant impact” was 67 kilometers from the Station. Therefore, the required radius for evaluating nearby sources was 117 kilometers (67 kilometers plus 50 kilometers).

WPEA requested and modeled a complete source inventory of PM10, nitrogen dioxide, and sulfur dioxide sources, from the NDEP-BAPC and the UDEQ-DAQ, within a 150-kilometer radius of the project site, an area larger than the required 117 kilometers. These agencies provided all sources within 150 kilometers, plus one source in Nevada that was 155 kilometers distant.

TABLE 3.6-7

Source Inventory for Class II Increment and NAAQS Modeling

ID	State	Facility	Oxides of Nitrogen	PM ₁₀	Sulfur Dioxide		
			(tons per year)	(pounds per hour)	(tons per year)	(pounds per hour)	(tons per year)
373	Nevada	Robinson Nevada Mining Company	28.31	104.43	107.37	5.47	4.24
405	Nevada	Newmont Gold Company	--	7.96	23.4	--	--
543	Nevada	J&M Trucking - Ely	--	0.83	0.66	--	--
713	Nevada	Homestake Mining Company	--	0.01	0.06	--	--
835	Nevada	Reck Brothers	10.28	3.57	3.57	0.92	0.93
1065	Nevada	Nevada Slag	10.69	6.91	3.84	7.42	6.97
1124	Nevada	Reed Distributing	--	0.002	0.01	--	--
1177	Nevada	J&M Trucking - Eureka	--	0.57	0.92	--	--
1336	Nevada	Bald Mountain Mine - Mooney	--	0.20	0.83	--	--
1362	Nevada	Bald Mountain Mine - Huntington	2.56	0.35	1.49	0.0006	0.003
1377	Nevada	Cooper & Sons	14.11	5.85	4.61	4.95	4.45
1417	Nevada	Country Construction	--	3.30	1.2	--	--
1466	Nevada	White Pine County Schools	1.44	2.1	3.27	0.11	0.16
1594	Nevada	Chevron Environmental Mgt Co.	1.83				
10706	Utah	U.S. Army - Dugway Proving Ground	--	--	--	5.24	22.94
		Total	68.2	136	151	24.1	39.7

The NDEP provided 223 records of information for major sources (sources subject to PSD permitting) and minor sources (sources not subject to PSD permitting). The UDEQ provided 11 records of information. Note that multiple records are provided for various facilities, as some facilities include multiple emission sources. Records from the source inventories with identical coordinates and stack characteristics were grouped together to provide 28 unique sources (and 15 unique facilities) for modeling. The 15 facilities are listed in Table 3.6-7 and shown in Figure 3.6-3.

These stationary sources were all assumed to be increment consuming (those sources that would cause deterioration of air

quality after certain federally-designated trigger dates). Increment consumption from area and mobile source emissions was assumed to be negligible because of the decrease in population in White Pine County since the PM₁₀ and sulfur dioxide minor source baseline dates. The concept of increment consumption is explained more fully in Appendix L.

For the Class I PSD increment analysis, the modeling inventory included all PSD major sources within the modeling domain and all minor sources within 50 km of a Class I receptor. For additional information on the Class I PSD increment modeling inventory, including a detailed list of emission sources in the region and emission rates, refer to Appendix L.

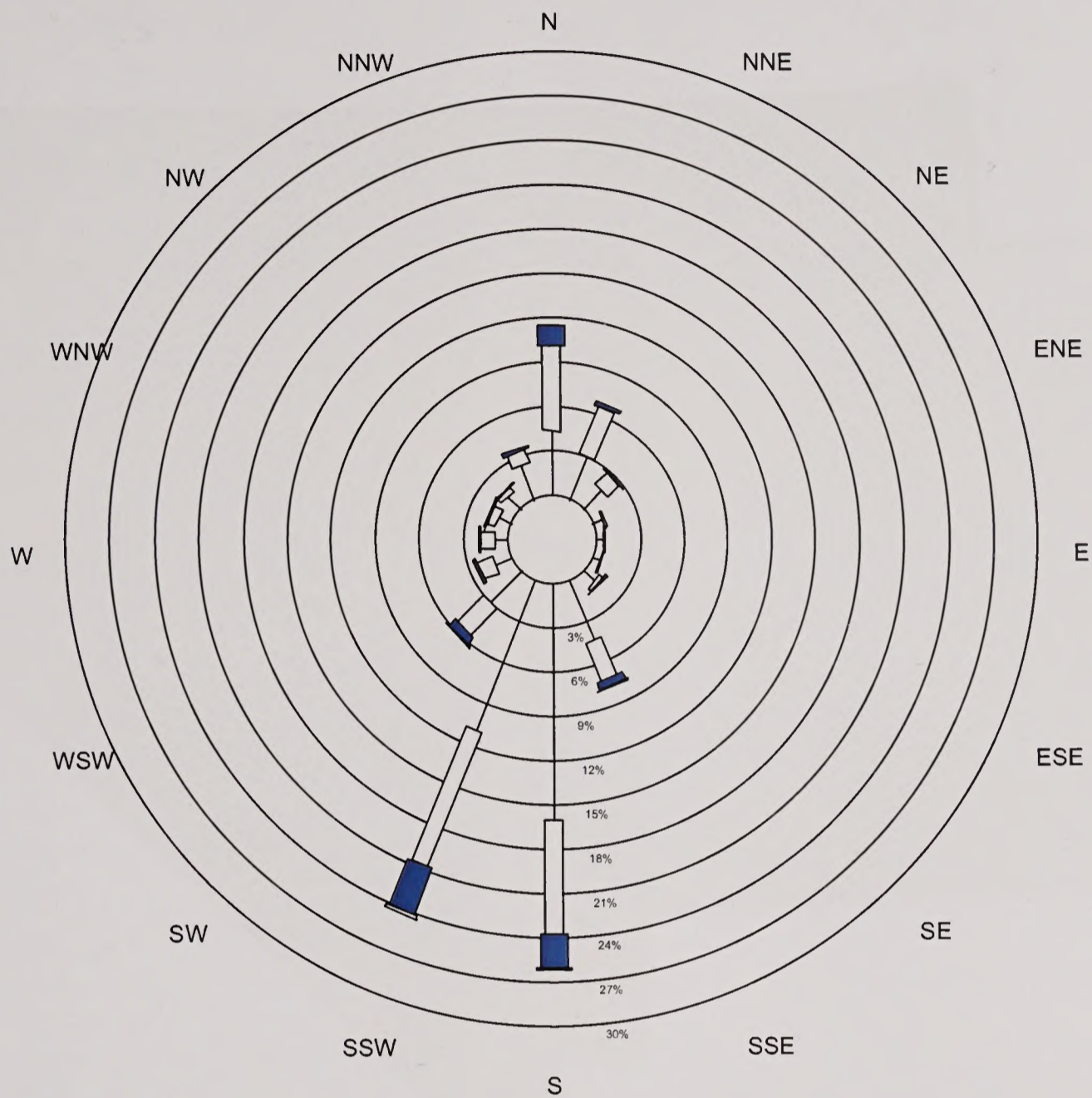

LS Power 10-meter Wind Frequency Distribution
 2005 Data
 Calm hours = 359 Missing hours = 2
 Number of non-calm/missing hours = 8399

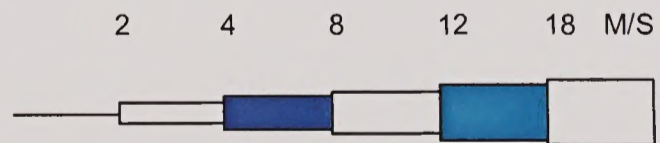

Wind Rose
White Pine Energy Station Project

Figure 3.6-2

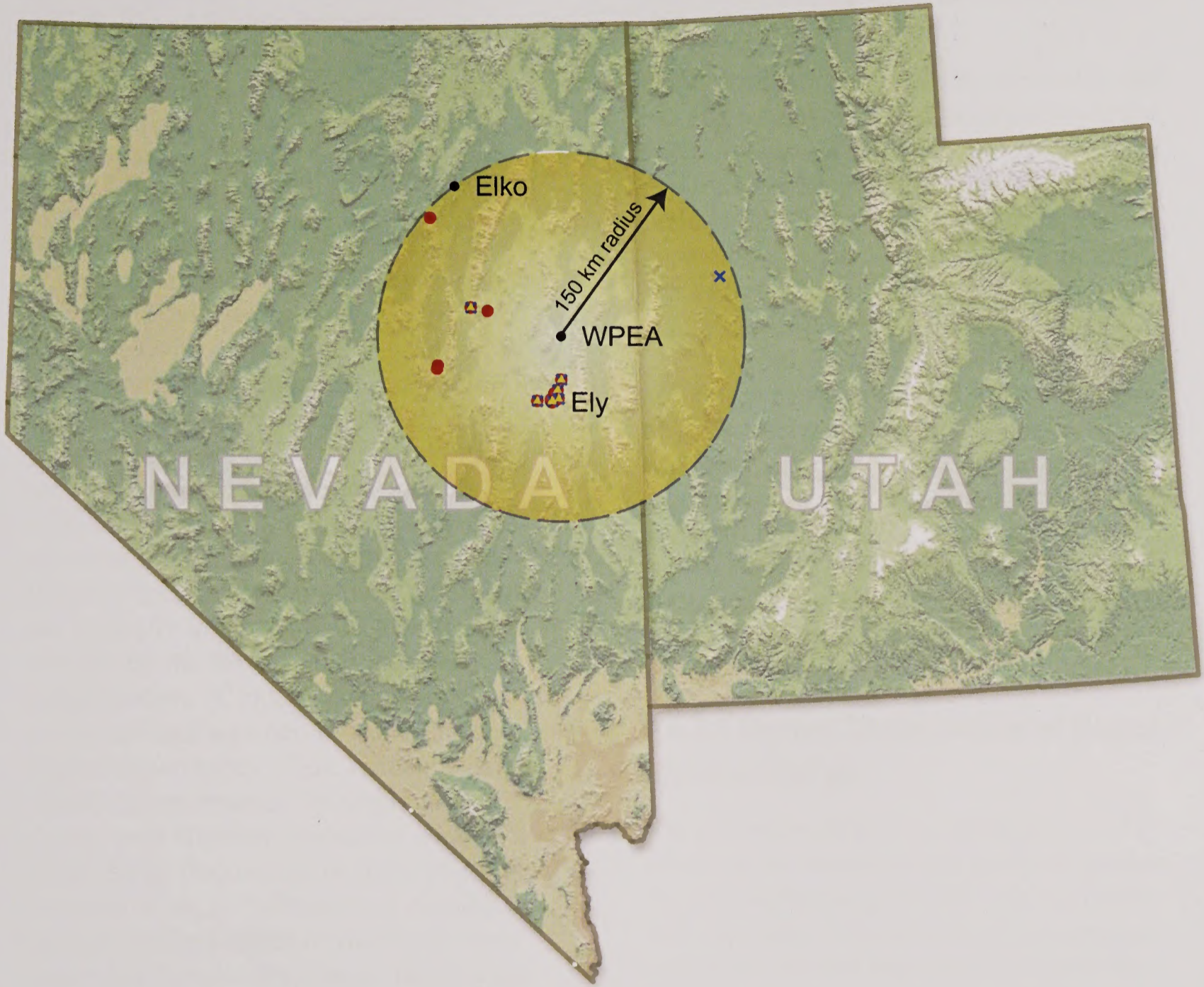

- *PM10 Major/Minor Sources*
- × *SO2 Major/Minor Sources*
- ▲ *NO2 Major/Minor Sources*

**Nearby PM10, SO2, and NO2 Sources
White Pine Energy Station Project**

3.6.2 Climate Change

Climate change is discussed in this section, and also in Sections 4.6.2, 4.19.3, and 4.21.5. For additional information on climate change, refer to Appendix M, *Understanding and Evaluating Climate Change*.

3.6.2.1 Background

In common terms, one can think of “climate” as the average weather conditions over some extended period. The IPCC (2001) provides a more rigorous definition of climate as the “statistical description in terms of the mean and variability of relevant parameters over a period of time ranging from months to thousands or millions of years.” Parameters measured are most often surface variables such as temperature, precipitation, and wind. Data are typically averaged in 30-year periods as defined by the World Meteorological Organization. “Climate change” is the shift in the average weather, or trend, that a region experiences. Thus, climate change cannot be represented by single annual events or individual anomalies. That is, a single large flood event or particularly hot summer is not an indication of climate change, while a series of floods or warm years that statistically change the average precipitation or temperature over time may indicate climate change.

“Climate variability” refers to the deviation from the average climate. For example, an individual year that is drier or hotter than average would indicate variability, but may not indicate a shift in the trend as would be defined as climate change.

A growing body of evidence indicates that the earth’s atmosphere is warming. Records show that surface temperatures have risen about 0.7°C since the early 20th century and that 0.5°C of this increase has occurred

since 1978 (NAS, 2006a summary; USGRP, 2001). Observed changes in oceans, snow and ice cover, and ecosystems are consistent with this warming trend (NAS, 2006a; IPCC, 2001, 2007).

Earth’s climate has exhibited variability and has changed over time. The extremes of the 100,000-year ice age cycles and interglacial periods have been well-documented. The period of the last 10,000 years has been generally warm and stable. Observations in the 20th century indicate rapid climate change (IPCC, 2001, 2007; NAS, 2006a). The National Academy of Sciences (NAS) (2006b) recently supported the conclusion that it is likely that the past few decades exhibited higher global mean surface temperatures than during any comparable period of the preceding four centuries. Additionally, 11 years between 1995 and 2006 rank among the 12 warmest years in the instrumentation record (1850 to 2006) for global surface temperature (IPCC, 2007b).

3.6.2.2 Recent Observations of Global Climate Change

The earliest records of temperature measured by thermometers are from western Europe beginning in the late 17th and early 18th centuries. The network of temperature collection stations increased over time. By the early 20th century, records were being collected in almost all regions except for polar regions where collections began in the 1940s and 1950s (National Climate Data Center, 2007a). As with other periods in the earth’s history, the period of instrumental temperature records shows both increases and decreases in global temperature. The changes in global temperature during the period of instrumental record are shown in Figure 3.6-4. (The phrase “temperature anomaly” refers to the difference between the observed temperature and the 20th century average temperature.)

FIGURE 3.6-4

Global Mean Annual Temperature Anomaly, 1880-2007

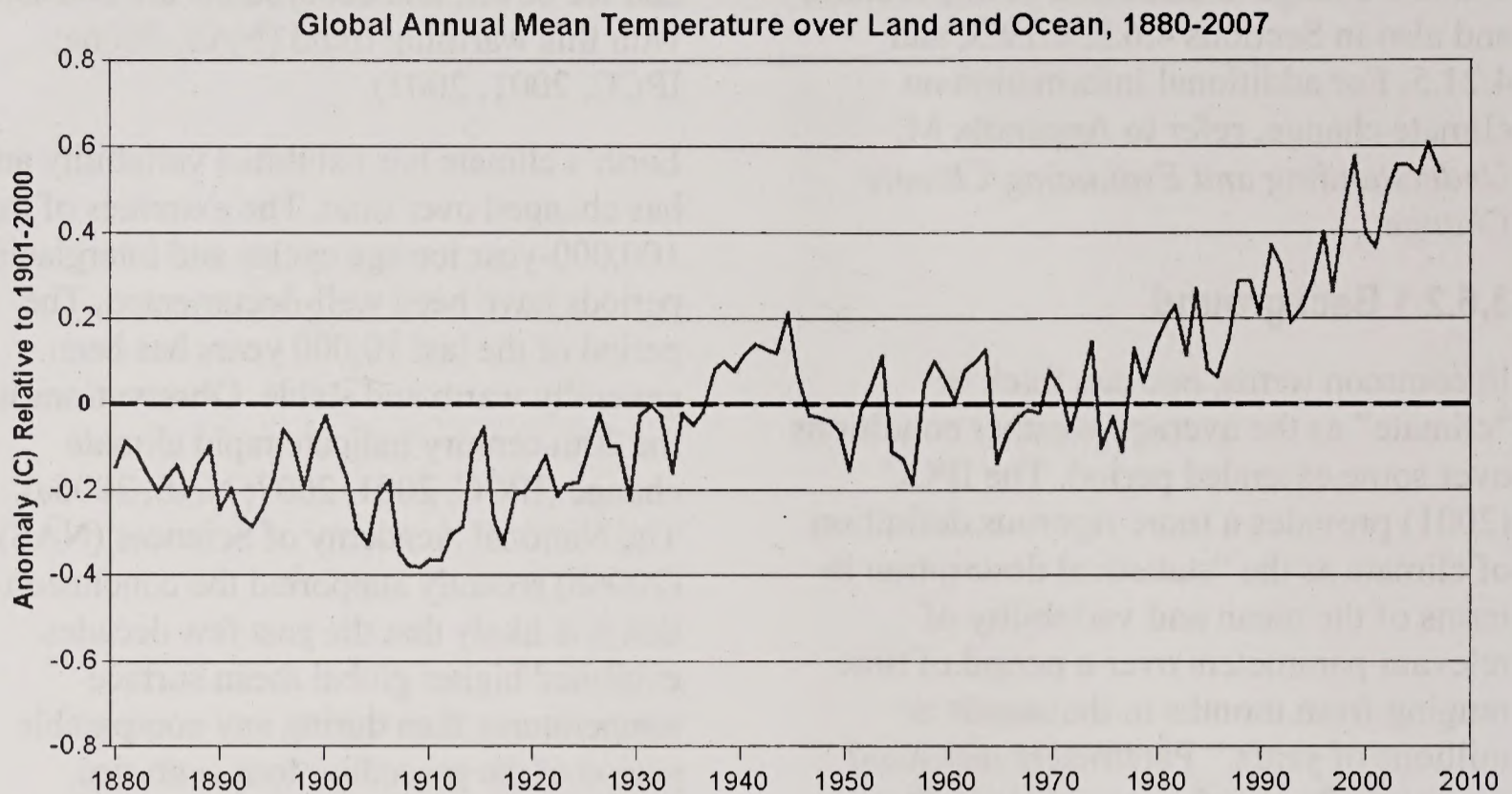

Source: National Climatic Data Center data 2007b (accessed January 16, 2008)

As shown in Figure 3.6-4, the instrumental global temperature record shows a decreasing temperature trend from 1880 to 1909; an increasing temperature trend from 1910 to 1945; a relatively stable period from 1946 to 1975; and an increasing trend from 1976 to present. The overall trend for the 20th century reflects increasing global temperatures, with current global temperatures approximately 0.6°C above the 20th century average. Over the past century, global surface temperatures have increased at an average rate of approximately 0.05°C per decade, with higher rates of approximately 0.15°C per decade for the periods from 1910 to 1945 and 1976 to 2007 (National Climate Data Center, 2007b).

3.6.2.3 Long-Term Temperature and Precipitation Trend for the United States

The National Weather Service/Climate Prediction Center prepared Figure 3.6-5 based on a database of all averaged monthly

average temperature and total precipitation for 102 climate regions of approximately equal area covering the lower 48 states. Each climate region is composed of one or more of the 344 climate divisions outlined on the maps. The monthly data were assembled into time series for each of the 12 3-month periods, as well as for the annual average. The analyses are based on 1941 to 2005 data for the temperature products, and 1931 to 2005 for precipitation.

These trend data show that the observed long-term increase in temperature in the area of the proposed WPES site is in the range of 0.4 to 0.8°F per decade. Also, the observed long-term increase in precipitation is 0.1 to 0.3 inch per decade.

**Rate of Long-Term Trend Temperature Change (top; °F per decade)
& Precipitation Change (bottom; inches per decade) – FULL YEAR**

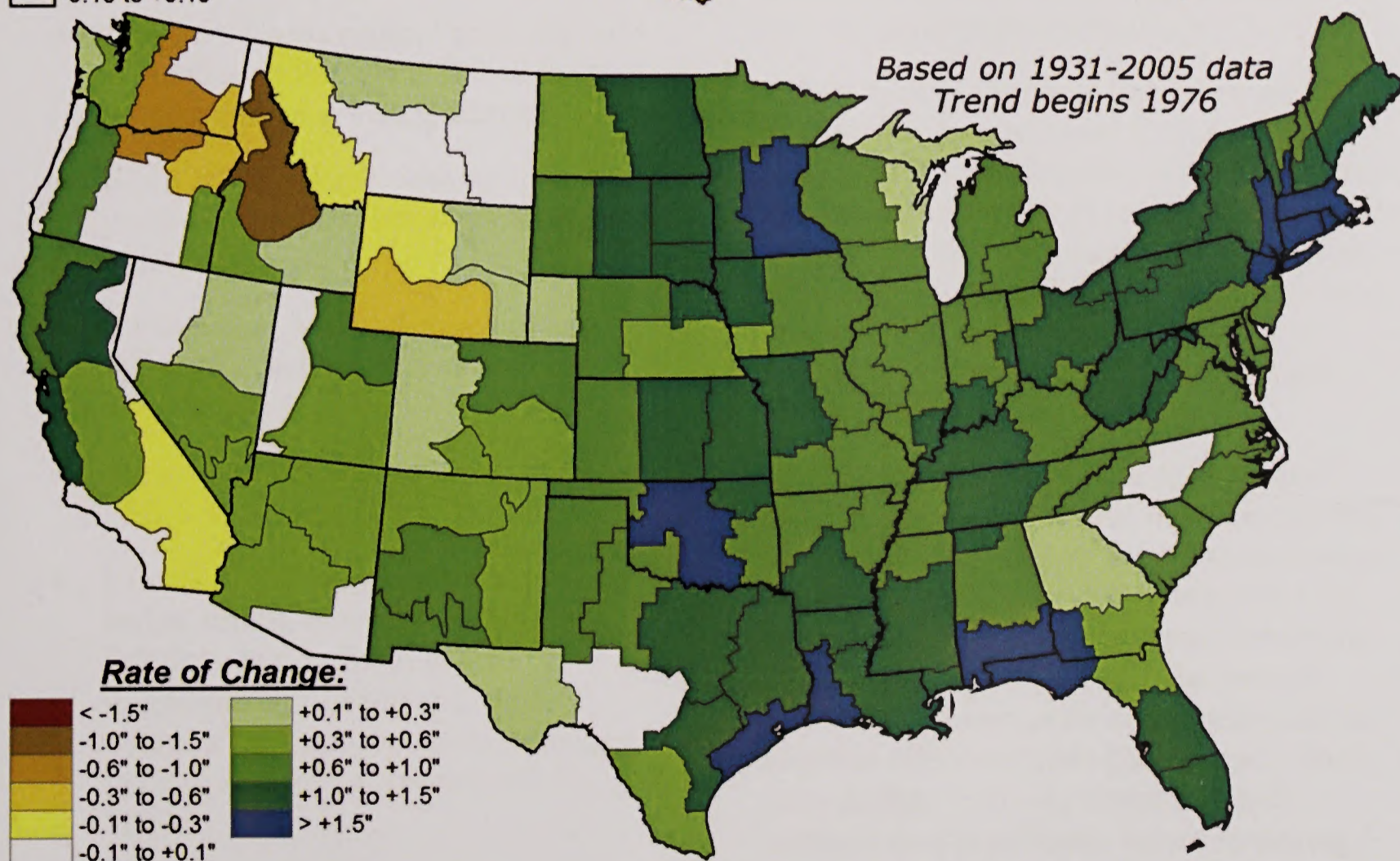
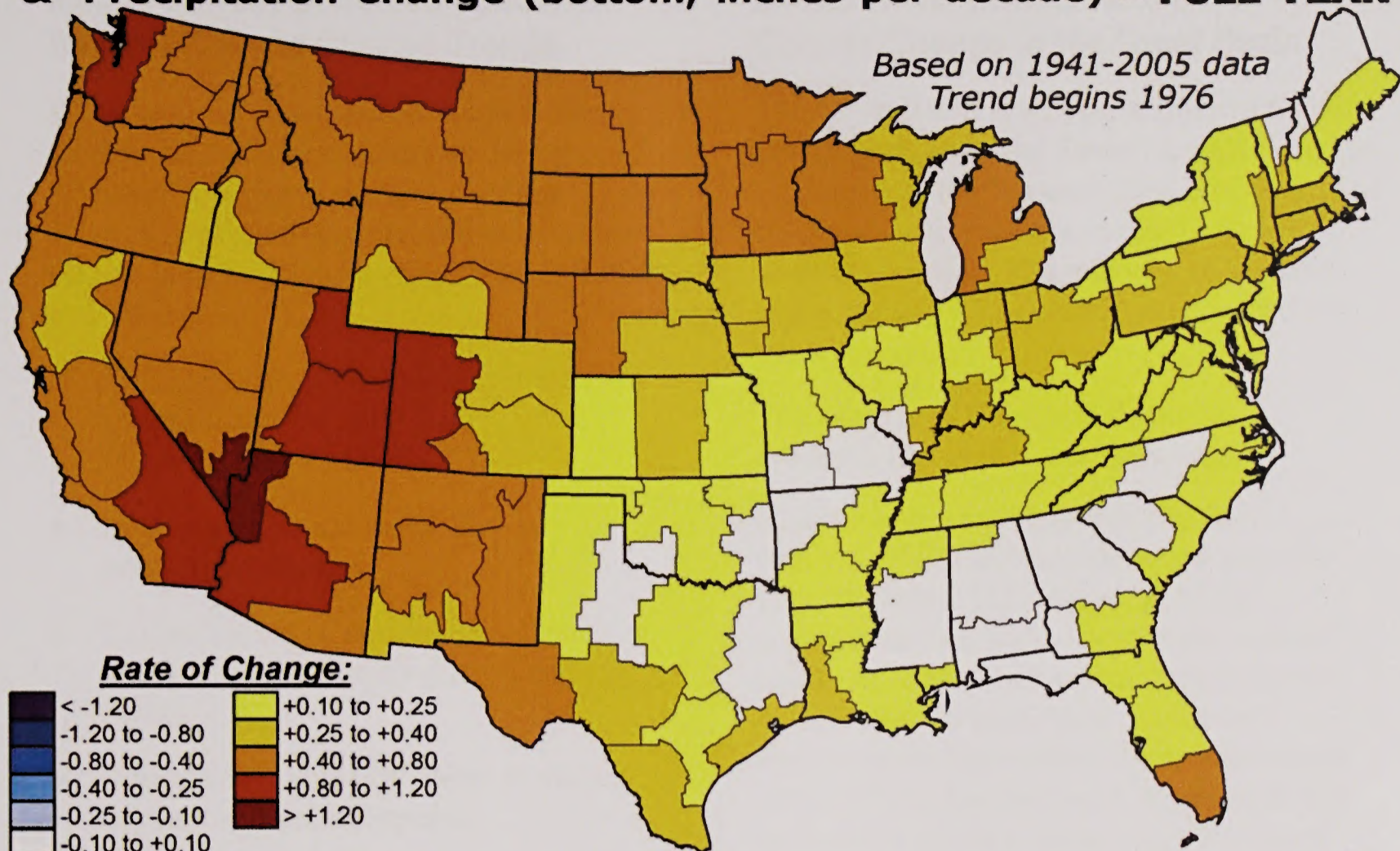

**National Weather Service
Long-Term Temperature Trend Data
White Pine Energy Station Project**

Figure 3.6-5

3.6.2.4 Current Observed Resource-Specific Climate Change Trends

Wide-ranging observations suggest that worldwide, natural systems are being affected by regional climate changes. Examples of such regional climate change effects include the following (IPCC, 2007d, p. 1-2):

- Enlargement and increased numbers of glacial lakes resulting from temperature increases
- Increasing ground instability in permafrost regions
- Earlier timing of spring events, such as leaf unfolding, bird migration and egg laying
- Poleward and upward shifts in ranges in plant and animal species
- A trend towards earlier “greening” of vegetation in the spring linked to longer thermal growing seasons
- Shifts in ranges and changes in algal, plankton and fish abundance in high-latitude oceans
- Increases in algal and zooplankton abundance in high-latitude and high-altitude lakes
- Range changes and earlier migrations of fish in rivers
- Effects to biological systems, such as earlier timing of spring events (for example, leaf-unfolding, bird migration, and egg-laying) and poleward and upward shifts in ranges in plant and animal species (IPCC, 2007e).

3.6.2.5 Recent Observations of Climate Change in the Great Basin

The Great Basin is a large, semi-arid region that extends from the Sierra Nevada Range in California to the Wasatch Range in Utah, and from southeastern Oregon and Idaho to southern Nevada. The majority of the land (approximately 72 percent) is under federal management.

The climate of the Great Basin has changed during the past 100 years.

Region-wide warming of 0.3 to 0.6°C (0.6 to 1.1°F) has been observed over the last 100 years. This warming, while widespread, has varied across the region (Wagner, 2003). Minimum temperatures have increased more than maximum temperatures and variability in interannual temperatures has declined. As a result, the probability of very warm years increased and very cold years declined.

Across most of the Great Basin, annual precipitation has increased from 6 to 16 percent since the middle of the last century. Interannual variability in precipitation also has increased, with an increase in the probability of extreme high-precipitation years. This has been reflected in increases in streamflow across the region, especially in winter and spring (Baldwin et al., 2003).

Since about 1950, trends in April 1 snow pack have been negative at most monitoring sites in the Great Basin. Elevation and mean winter temperature have a strong effect on snowpack with the warmest sites exhibiting the largest relative losses. In the warmer mountains, winter melt events have a strong negative effect on April 1 snow pack. Snow pack decline in the dry interior, which includes the Great Basin, has been among the largest observed, with the exception of central and southern Nevada (Mote et al., 2005).

The earlier arrival of spring has affected streamflow and plant phenology (the study of the timing of natural events). The timing of spring snowmelt-driven streamflow is now about 10 to 15 days earlier than in the mid-1900s, and an increase in interannual variability in spring flow has occurred (Baldwin et al., 2003; Stewart et al., 2004). Phenological studies indicate that in much of the West, the average bloom-date is earlier for both purple lilac (2 days per decade based on data from 1957 to 1994) and honeysuckle (3.8 days per decade based on data from 1968 to 1994) (Cayan et al., 2001; USFS, 2008).

3.6.2.6 Factors Contributing to Climate Change

Several mechanisms have been identified that have the potential to affect the earth's climate. Such mechanisms include, but are not limited to, the following:

- Aerosols
- Solar activity
- Surface albedo
- Variations in the earth's orbit
- Greenhouse gases

These mechanisms are discussed in more detail in Appendix M, *Understanding and Evaluating Climate Change*.

According to the IPCC: "Most of the observed increase in global average temperatures since the mid-20th century is very likely due to the observed increase in anthropogenic [human-caused] greenhouse gas concentrations" (IPCC Working Group I, Summary for Policymakers, 2007).

Greenhouse gases are components of the atmosphere that contribute to the greenhouse effect. The greenhouse effect is the rise in temperature that the earth experiences because certain gases in the atmosphere (for example, water vapor, carbon dioxide, nitrous oxide, and methane) trap energy from

the sun. Anthropogenic sources are a significant source of greenhouse gas.

The greenhouse effect is important. Without the greenhouse effect, the earth would not be warm enough for humans to live. (EPA, 2008b).

Information from various sources indicates an increase in the global atmospheric concentration of greenhouse gases over the past century. The IPCC indicates that the global average carbon dioxide concentration has increased from approximately 280 ppm in pre-industrial times to 379 ppm in 2005, and that this recent value exceeds the natural range of 180 to 300 ppm observed over the past 650,000 years (IPCC, 2007). The human-caused component of this increase is demonstrated to be caused primarily by fossil fuel use. Atmospheric concentrations of methane and nitrous oxide have also increased, primarily because of agricultural impacts.

Greenhouse gases such as carbon dioxide and methane are not reactive and do not form secondary particles that would contribute to visibility degradation. For additional information on greenhouse gases and their impact on climate change refer to Appendix M, *Understanding and Evaluating Climate Change*.

Carbon Dioxide Emissions Trends

Anthropogenic carbon dioxide emissions have increased from low levels in pre-industrial times (prior to 1750) to approximately 36,000 million tons (36 billion tons) per year at present day (IPCC, 2007d, p 2-3). The majority of anthropogenic carbon dioxide emitted to the atmosphere, approximately 80 percent, is released by fossil fuel combustion (IPCC, 2007d, p 2-3). The remaining 20 percent originates from anthropogenic land use changes. The main fossil fuel combustion carbon dioxide emission

source categories include electric power generation (35 percent of total anthropogenic carbon dioxide emissions [International Energy Agency, 2005]), transportation (20 percent), other industry (20 percent), and residential (20 percent). Global emissions in all of these fossil fuel categories are currently increasing, and are expected to do so for at least several decades; however, as discussed below, longer term future trends in global carbon dioxide emissions are uncertain.

Increased carbon dioxide emissions are associated with commercial, industrial, and population growth; therefore, carbon dioxide emissions from developing nations such as China and India are increasing rapidly. For example, China is currently constructing the equivalent of two 500-megawatt (MW) coal-fired power plants per week (Katzer et al., 2005). In the developed world, growth in population and industry, along with an aging fleet of existing power plants, dictate the need to construct new electric generating capacity. In the United States, there were recently more than 70 coal-fired power plant projects proposed and at various stages of development (EPA, 2007b), although that number has declined in light of various factors such as escalating cost, regulatory uncertainty and litigation risk.

The trend in future anthropogenic carbon dioxide emissions will likely be driven by a mix of technological, economic, and policy developments. As technology progresses, "carbon intensity" (the amount of carbon dioxide emitted per unit of economic output) is typically reduced, resulting in a decrease in the carbon dioxide emissions growth rate. Additionally, significant research and development efforts are underway in the field of carbon capture and sequestration (CCS) technology. This technology is

expected to become available within the next two decades and would allow the power generation industry to capture carbon dioxide and store it underground, drastically reducing emissions to the atmosphere (DOE, 2007). There is also an increased emphasis on the development of renewable energy projects. Policy developments worldwide will likely accelerate the process of carbon dioxide emissions reduction. In the near future, the U.S. is expected to join the European Union and other nations in placing mandatory caps on carbon dioxide emissions (there is also a possibility of a carbon tax). Such mandatory caps would be even more effective in reducing global carbon dioxide emissions with the participation of developing nations such as China and India. Vehicle fuel economy standards will further serve to reduce carbon dioxide emissions worldwide. Ultimately, the levels of global carbon dioxide emissions in the future will be determined by a mix of these technological, economic, and policy developments; thus, future increases and decreases in carbon dioxide emission rates remain uncertain at present.

3.6.2.7 Climate Tipping Points

Some climatologists have postulated the existence of climate "tipping points." A tipping point would occur if an aspect of the climate system were to reach a state such that strong amplifying feedbacks were activated by only moderate additional warming. Although the threshold conditions that would be required to trigger a tipping point in the climate system are not known, some climatologists are concerned that increasing atmospheric concentrations of greenhouse gases in the future could move the climate system toward a tipping point.

3.6.3 Noise

This section addresses existing noise sources and levels at noise-sensitive locations in the vicinity of the White Pine Energy Station Proposed Action and Alternative 1 power plant and substation sites. Noise levels near the power plant and associated substation sites are dominated by traffic on U.S. 93, while current noise exposure near the proposed Thirtymile Substation site is dominated by traffic on U.S. 50.

3.6.3.1 Fundamentals of Noise

Unless otherwise stated, all sound levels reported in this section are in A-weighted decibels (dBA). A-weighted sound level is defined as the level, in decibels, measured

with a sound level meter having the metering characteristics and a frequency weighting specified in the American National Standards Institute Specification for Sound Level meters, ANSI S 1.4-1983. The A-weighting de-emphasizes lower frequency sounds (below 1,000 Hertz [1 kiloHertz]) and higher frequency sounds (above 4 Hertz). It emphasizes sounds between 1 kiloHertz and 4 kiloHertz. A-weighting is the measure most used for traffic and environmental noise throughout the world. Most community noise standards use A-weighting, as it provides a high degree of correlation with human annoyance and health effects. Table 3.6-8 shows typical indoor and outdoor noise levels associated with common sources or activities.

TABLE 3.6-8
Typical Noise Levels (dBA)

Common Outdoor Activities	Noise Level (dBA)	Common Indoor Activities
Jet fly-over at 1,000 feet	110	Rock band
Gas lawn mower at 3 feet	100	
Diesel truck at 50 feet at 50 mph	90	Food blender at 3 feet
Noisy urban area, daytime	80	Garbage disposal at 3 feet
Gas lawn mower, 100 feet	70	Vacuum cleaner at 10 feet
Commercial area		Normal speech at 3 feet
Heavy traffic at 300 feet	60	Large business office
Quiet urban daytime	50	Dishwasher next room
Quiet urban nighttime	40	Theater, large conference room (background)
Quiet suburban nighttime		Library
Quiet rural nighttime	30	Bedroom at night, concert hall (background)
	20	Broadcast/recording studio
	10	
Lowest threshold of human hearing	0	Lowest threshold of human hearing

Source: Caltrans Technical Noise Supplement (TeNS), 1998

The actual impact of noise is not a function of loudness alone. The time of day during which noise occurs and the duration of the noise are also important. In addition, most noise that lasts for more than a few seconds is variable in its intensity. Consequently, a variety of noise descriptors have been used such as L_{10} , L_{50} , and L_{dn} . The noise descriptor used for this study is the L_{eq} .

The L_{eq} is the equivalent steady state sound level which in a stated period of time would contain the same acoustical energy as the time-varying sound level during the same period. The L_{eq} (1 hour) is the energy-average of the A-weighted sound levels occurring during a 1-hour period, in decibels (that is, a one hour L_{eq}). From the source to the receiver, noise changes both in level and frequency spectrum. The most obvious is the decrease in noise as the distance from the source increases. The manner in which noise reduces with distance depends on the following important factors:

- Geometric spreading from point and line sources
- Ground absorption
- Atmospheric effects and refraction
- Shielding by natural and man-made features, noise barriers, diffraction, and reflection

Sound from a small localized source (approximating a "point" source) radiates uniformly outwards in a spherical pattern as it travels away from the source. The sound level decreases at a rate of 6 dBA for each doubling of the distance (6 dBA/DD). However, highway traffic and train noise are not single, stationary point sources of sound. The movement of the vehicles makes the source of the sound appear to emanate from a line (line source)

rather than a point when viewed over some time interval.

Changes in noise levels are perceived as follows:

- A 3 dBA change is barely perceptible
- A 5 dBA change is readily perceptible
- A 10 dBA change is perceived as a doubling or halving of noise

3.6.3.2 Station Feature Sites

3.6.3.2.1 Proposed Action Power Plant Site

Prominent landmarks near the Proposed Action power plant site include U.S. 93 and the Schell Creek Range (in the Humboldt-Toiyabe National Forest) to the east; Duck Creek and the Egan Range to the west; and Goshute Lake to the north. The communities of McGill and Ely are approximately 22 miles and 34 miles south of the Proposed Action power plant site, respectively, and Great Basin National Park is approximately 57 miles to the southeast. The Proposed Action power plant site is located in a sparsely populated area. The closest noise sensitive receptor, Hot Springs Ranch, is approximately 3 miles from the power plant site.

3.6.3.2.2 Alternative 1 Power Plant Site

Prominent landmarks near the Alternative 1 power plant site area are the same as described for the Proposed Action. The communities of McGill and Ely are approximately 10 and 22 miles south of the Alternative 1 power plant site. The Alternative 1 power plant site is located farther from the nearest noise sensitive receptors (Hot Springs Ranch) than the Proposed Action power plant site.

3.6.3.2.3 Duck Creek Substation Site(s)

A new 500-kV electric substation would be located adjacent to and interconnected

with the Proposed Action or Alternative 1 power plant.

3.6.3.2.4 Thirtymile Substation Site

A new 500 kV/345 kV electric substation would be located approximately 18 miles northwest of Ely in the Robinson Summit area. This substation site is 0.6 mile from U.S. 50.

3.6.3.3 Background Noise Levels

Except for traffic on U.S. 93 and U.S. 50, there is no other noise source close to the Station power plant sites and substation sites. Ambient noise at these sites is dominated by traffic noise. The annual average daily traffic data and the percentages of automobiles, medium trucks, and heavy trucks for rural areas were obtained from the Nevada Department of Transportation Annual Traffic Report (NDOT, 2005a). Based on these data, background noise levels at sensitive locations are estimated to be 45-50 dBA at the Proposed Action and Alternative 1 power plant sites (and the Duck Creek Substation site[s]), and 40-45 dBA at the proposed Thirtymile Substation site. The calculation methodology follows the basic principles of the Traffic Noise Model developed by the U.S. Federal Highway Administration.

3.6.3.4 Noise Regulations or Standards

All sensitive noise receptors of concern in the project area are located in White Pine County. White Pine County does not have noise regulations or standards applicable to the Station.

3.7 Visual Resources

This section describes visual resources in the project area and how the BLM's Visual Resource Management (VRM) System was used to describe existing conditions and to assess potential impacts in Chapter 4. The section discusses the Key Observation Points (KOPs) that were used to describe existing conditions and to subsequently assess potential impacts from physical changes (for example, buildings, stacks, towers, bridges, etc.) associated with the Proposed Action and Alternative 1 on visual resources.

The visual resources analysis discussed in this section and in Section 4.7, *Visual Resources*, are different from and should not be confused with the discussion of visibility impacts at Class I areas resulting from the emissions of air pollutants as discussed in Section 4.6.1.3.8, *Class I Area Dispersion Modeling Results*.

3.7.1 Analysis Area

The visual resources analysis area for the proposed White Pine Energy Station consists of the "seen areas" (or viewsheds) of several proposed project facilities. These facilities are the cooling towers, the steam generator stacks, the power plant (building), and transmission line tower structures. Seen areas were determined by conducting a geographic information system (GIS) terrain analysis to depict the extent of the potential line of sight distance of the facilities in the landscape. The analysis area for visual resources primarily includes Steptoe Valley, slopes of the adjacent Schell Creek Range to the east, the Egan and Cherry Creek Ranges to the west, Hunter Flat, Butte Valley, and the Robinson Summit area.

3.7.2 Existing Conditions

All proposed project facilities except part of the transmission line would be located in Steptoe Valley. This north-south oriented valley lies between fault block mountain ranges, the Egan and Cherry Creek Ranges to the west, and the Schell Creek Range to the east. The valley is characterized by nearly flat to gently sloping basins, terraces, floodplains, and fan skirts. Duck Creek and several bodies of water (for example, Goshute Lake to the north and the McGill Tailings Reclamation Area to the south) are found in the valley. Vegetation in the valley consists of plants typically found in the Great Basin sagebrush community and includes several species of sagebrush, rabbitbrush, and an understory mixture of grass species. Local stands of Rocky Mountain juniper are found along the higher edges of the valley. In the mountains, vegetation communities range from the Great Basin sagebrush at the lower elevations to pinyon-juniper woodlands at the middle to higher elevations.

Steptoe Valley and the adjacent mountains have a largely undeveloped appearance. The south end of the valley has the most development and human-made features in the analysis area. It contains the City of Ely, the Falcon to Gonder transmission line, the Gonder Substation, U.S. 50, the community of McGill, the McGill Tailings Reclamation Area, the pipeline on the east side of the valley that supplied water to the closed Kennecott facility, residences, and other areas of development. The central part of the valley is largely undeveloped, but does contain scattered ranches and residences. The north end of the valley also contains scattered residences, commercial businesses at Schellbourne, and the community of Cherry Creek.

Several linear human-made features can be seen throughout the valley including U.S. 93, County Road 27, several side roads, the NNR, and various transmission lines that generally parallel U.S. 93 and other roads. Cattle grazing occurs throughout the valley and mountains.

Development near the communities of Ely and McGill has created an “island” or “dome” of light in an area of central Nevada that is one of the darkest areas in the continental United States, as evidenced by satellite imagery maps produced by the Light Pollution Science and Technology Institute (NPS, 2006). The issue of light associated with human development having impacts on “dark skies” is receiving more and more attention nationally. Lights from Ely can be seen from Great Basin National Park, and the NPS is concerned about the potential of increased impacts from White Pine Energy Station light on dark skies at National Parks (Moore, 2005).

3.7.3 BLM Visual Resource Management System

The BLM’s VRM system provides a way to inventory and evaluate the scenic value of an area’s visual resources in order to determine appropriate levels of management (BLM, 1986a; BLM, 1986b). The system also provides a way to analyze potential visual impacts and apply visual design techniques to ensure that surface-disturbing activities are harmonized with their surroundings or are appropriate with the surrounding landscape.

The VRM system consists of two stages: the inventory stage and the analysis stage. The inventory stage involves identifying and inventorying the visual resources of an area. Inventory classes are assigned using BLM’s visual resource inventory process. The analysis stage involves rating the

visual appeal of a tract of land, measuring public concern for scenic quality, and determining whether the tract of land is visible from representative or selected key travel routes and/or observation points. Results of the visual resource inventory were considered (along with many other resources) when the Proposed Ely District Resource Management Plan (BLM, 2007) was developed. A Resource Management Plan establishes how the public lands will be used and allocated for different purposes. Visual values are considered in the development of the Proposed Ely District Resource Management Plan, and the area’s visual resources are assigned one of four VRM Classes (classes). Table 3.7-1 lists the management objectives of the VRM classes.

TABLE 3.7-1
VRM Classes and Management Objectives

VRM Class	Management Objective
I	To preserve the existing character of the landscape. The level of change to the characteristic landscape should be very low and must not attract attention.
II	To retain the existing character of the landscape. The level of change to the characteristic landscape should be low.
III	To partially retain the existing character of the landscape. The level of change to the characteristic landscape should be moderate.
IV	To provide for management activities which require major modification of the existing character of the landscape. The level of change to the characteristic landscape can be high.

The Proposed Ely District Resource Management Plan (BLM, 2007) designated VRM classes for all BLM lands in the District. Figure 3.7-1 depicts the proposed VRM classes for lands in the analysis area.

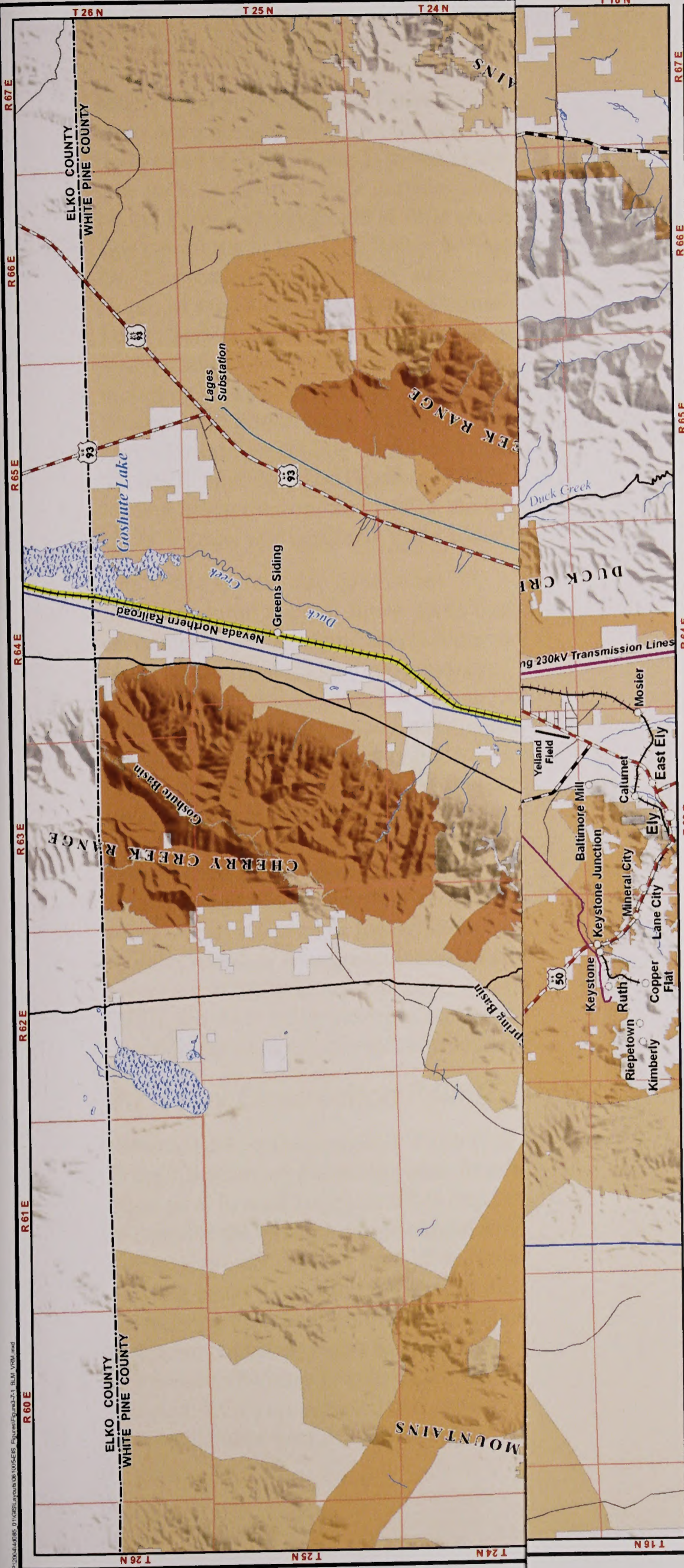

BLM Visual Resource Management (VRM) Classes White Pine Energy Station Project

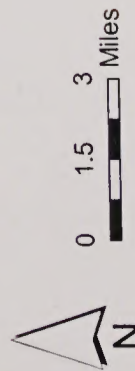
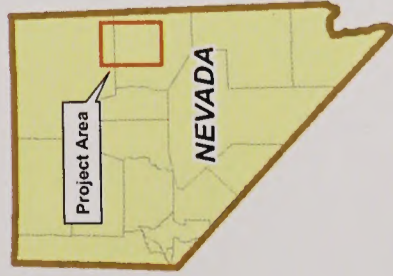

1:150,000 when printed at 22 x 34 inches

Existing Electrical Features

- Existing Substation
- Existing Transmission Line
- Existing Distribution Line

Surface Water

- Perennial Stream or River
- Wetland

Connected Action

- SWIP Transmission Line
- NNR Upgrade

Common Project Features

- Minerals Materials Sale Area
- Moriah Ranches
- Seeding Project

Proposed Action Project Features

- Proposed Well Site
- - - Proposed Water Pipeline/Distribution Line
- Proposed Rail Spur
- - - Proposed Transmission Line
- - - Proposed Electric Distribution Line
- Proposed Access Road
- Proposed Substation Site
- Proposed Power Plant Site

Alternative 1 Project Features

- Proposed Well Site
- - - Proposed Water Pipeline/Distribution Line
- Proposed Rail Spur
- - - Proposed Transmission Line
- - - Proposed Electric Distribution Line
- Proposed Access Road
- Proposed Substation Site
- Proposed Power Plant Site

BLM VRM Classes

- Class 1
- Class 2
- Class 3
- Class 4

Figure 3.7-1

Several linear human-made features can be seen throughout the valley including U.S. 93, County Road 27, several side roads, the NNR, and various transmission lines that generally parallel U.S. 93 and other roads. Cattle grazing occurs throughout the valley and mountains.

Development near the communities of Ely and McGill has created an “island” or “dome” of light in an area of central Nevada that is one of the darkest areas in the continental United States, as evidenced by satellite imagery maps produced by the Light Pollution Science and Technology Institute (NPS, 2006). The issue of light associated with human development having impacts on “dark skies” is receiving more and more attention nationally. Lights from Ely can be seen from Great Basin National Park, and the NPS is concerned about the potential of increased impacts from White Pine Energy Station light on dark skies at National Parks (Moore, 2005).

3.7.3 BLM Visual Resource Management System

The BLM’s VRM system provides a way to inventory and evaluate the scenic value of an area’s visual resources in order to determine appropriate levels of management (BLM, 1986a; BLM, 1986b). The system also provides a way to analyze potential visual impacts and apply visual design techniques to ensure that surface-disturbing activities are harmonized with their surroundings or are appropriate with the surrounding landscape.

The VRM system consists of two stages: the inventory stage and the analysis stage. The inventory stage involves identifying and inventorying the visual resources of an area. Inventory classes are assigned using BLM’s visual resource inventory process. The analysis stage involves rating the

visual appeal of a tract of land, measuring public concern for scenic quality, and determining whether the tract of land is visible from representative or selected key travel routes and/or observation points. Results of the visual resource inventory were considered (along with many other resources) when the Proposed Ely District Resource Management Plan (BLM, 2007) was developed. A Resource Management Plan establishes how the public lands will be used and allocated for different purposes. Visual values are considered in the development of the Proposed Ely District Resource Management Plan, and the area’s visual resources are assigned one of four VRM Classes (classes). Table 3.7-1 lists the management objectives of the VRM classes.

TABLE 3.7-1
VRM Classes and Management Objectives

VRM Class	Management Objective
I	To preserve the existing character of the landscape. The level of change to the characteristic landscape should be very low and must not attract attention.
II	To retain the existing character of the landscape. The level of change to the characteristic landscape should be low.
III	To partially retain the existing character of the landscape. The level of change to the characteristic landscape should be moderate.
IV	To provide for management activities which require major modification of the existing character of the landscape. The level of change to the characteristic landscape can be high.

The Proposed Ely District Resource Management Plan (BLM, 2007) designated VRM classes for all BLM lands in the District. Figure 3.7-1 depicts the proposed VRM classes for lands in the analysis area.

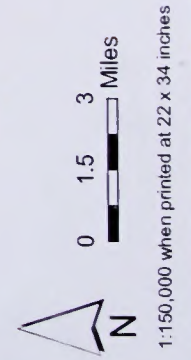
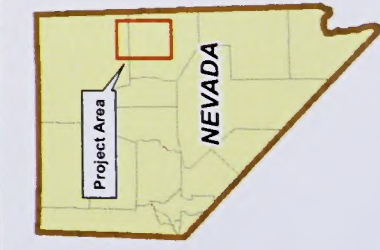
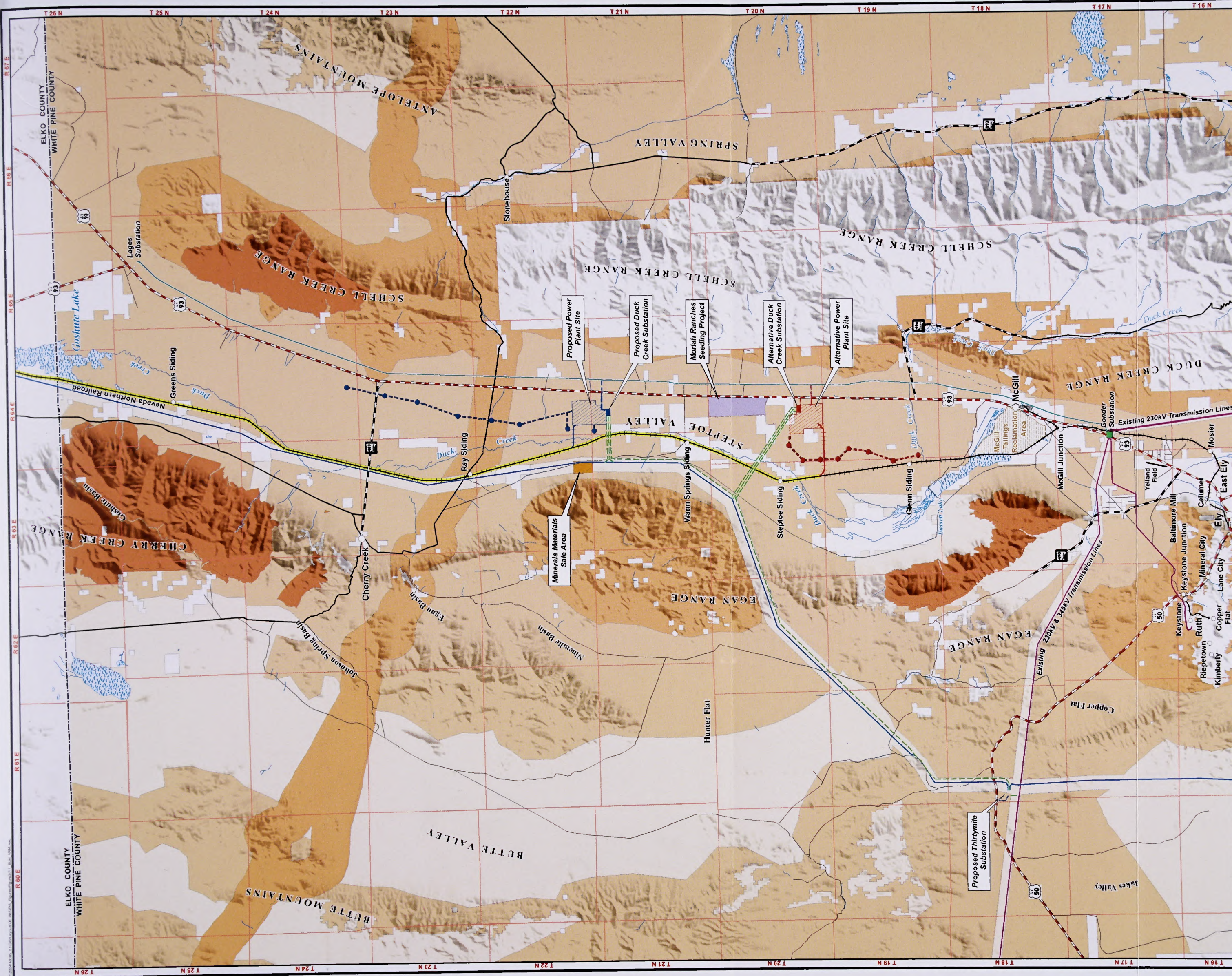

- Existing Electrical Features**
- Existing Substation
 - Existing Transmission Line
 - Existing Distribution Line
- Surface Water**
- Perennial Stream or River
 - Wetland
- Connected Action**
- SWIP Transmission Line
 - NRR Upgrade
- Common Project Features**
- Minerals Materials Sale Area
 - Moriah Ranches
 - Seeding Project

- Proposed Action Project Features**
- Proposed Well Site
 - Proposed Water Pipeline/Distribution Line
 - Proposed Rail Spur
 - Proposed Transmission Line
 - Proposed Electric Distribution Line
 - Proposed Access Road
 - Proposed Substation Site
 - Proposed Power Plant Site

- Alternative 1 Project Features**
- Proposed Well Site
 - Proposed Water Pipeline/Distribution Line
 - Proposed Rail Spur
 - Proposed Transmission Line
 - Proposed Electric Distribution Line
 - Proposed Access Road
 - Proposed Substation Site
 - Proposed Power Plant Site

- BLM VRM Classes**
- Class 1
 - Class 2
 - Class 3
 - Class 4

BLM Visual Resource Management (VRM) Classes
White Pine Energy Station Project

Figure 3.7-1

Much of Steptoe Valley and other nearby areas were designated VRM Class III. Areas designated as VRM Class II in the analysis area include a 2-mile-wide corridor centered on the Pony Express Route (1 mile on each side), portions of the Egan Range between Dry Canyon and Antone Pass, and the lower slopes of the Duck Creek Range (below Forest Service lands). Several large areas of VRM Class IV were assigned to BLM lands, including areas west of Duck Creek and Bassett Lake and in Butte Valley as well as several transmission line corridors including the SWIP corridor. The Goshute Wilderness, located along the southern part of the Cherry Creek Range, was assigned VRM Class I.

The VRM system also subdivides landscapes into three distance zones based on relative visibility from travel routes or observation points. The three zones are foreground-middleground, background, and seldom seen. The foreground-middleground zone includes areas seen from highways, rivers, or other viewing locations that are less than 3 to 5 miles away. The background zone is generally considered to include areas seen beyond the foreground-middleground zone that are usually less than 15 miles away. Areas not seen as foreground-middleground or background (hidden from view) are in the seldom-seen zone. For this DEIS, the three distance zones are used to describe the distance of objects from KOPs.

3.7.4 Key Observation Points

Projects such as the proposed White Pine Energy Station are potentially seen from a large area. In such large areas it is impractical to describe the existing visual conditions and potential project impacts from all important viewing areas. To assist in the description of the existing visual environment and to help in assessing potential project impacts, representative viewing areas called KOPs are selected. KOPs are selected to represent views of a potential project from different

geographic areas (close-up and distant views of a potential project); from different types of viewing areas (roadways, residences, recreation areas, etc.); and by different types of viewers (residents, people driving through an area, etc).

Six KOPs were selected from throughout the analysis area (see Figure 3.7-2). The KOPs represent different locations in the analysis area, different types of viewers, and different distances from facilities of the proposed alternatives. The KOPs (from north to south) are as follows:

- KOP 1—Cherry Creek
- KOP 2—Pony Express Route
- KOP 3—Lincoln Highway
- KOP 4—U.S. 93 Turnoff
- KOP 5—McGill
- KOP 6—U.S. 50

The following describes each KOP and the existing visual condition of the landscape seen from each KOP. Appendix N, *Visual Inventory Forms*, contains Visual Resource Inventory Forms that were prepared based on field examinations of the visual settings of each KOP. The forms include descriptions of the characteristic landscape, types of viewers, sensitivity of viewers, and other relevant information.

3.7.4.1 KOP 1: Cherry Creek

The community of Cherry Creek was selected to represent one of the few populated areas in the analysis area. It was also chosen to represent views from the northern and western parts of Steptoe Valley. KOP 1 offers expansive views of the valley floor and the Proposed Action power plant site approximately 12 miles to the southwest. Photo 3.7-1 depicts the view of the valley from KOP 1. This KOP represents the types of views that people have of the valley while driving into or out of the community of Cherry Creek. It is also

similar to the views that some residences of Cherry Creek would have of the Proposed Action power plant site.

Other than County Road 27 and some distant scattered buildings and fences, few human-made objects are visible from this KOP when looking in the direction the photograph was taken. The view directly behind the direction of this KOP is quite different and includes the Cherry Creek Cemetery along with several residential buildings.

Most of the area that can be seen from this KOP is BLM land that is either VRM Class II or III in the Proposed Ely District Resource Management Plan (BLM, 2007).

3.7.4.2 KOP 2: Pony Express Route

KOP 2 is located in the central part of Steptoe Valley on County Road 18, which also is the route of the Pony Express National Historic Trail. This KOP is located where the proposed water pipeline would cross under the road and is approximately 4.5 miles north of the Proposed Action power plant site. Views to the south of this KOP would include the proposed water pipeline ROW and the Proposed Action power plant site. Views from this KOP are expansive and range from east to west across the width of the valley (see Photo 3.7-2). The primary viewers from this location are people driving on County Road 18 (to access the community of Cherry Creek or for other purposes). Scattered buildings (particularly at Schellbourne approximately 1.5 miles east of KOP 2 and the community of Cherry Creek approximately 10 miles northwest) can be seen in the distance from this location, but the overall appearance of the landscape is natural and signs of human-made objects are few.

Because of the significance of the Pony Express National Historic Trail, the Proposed Ely District Resource Management Plan designated both sides of the Trail as Class II (BLM, 2007). Beyond the Class II lands are

BLM lands that have been designated VRM Class III in the Proposed Ely District Resource Management Plan (BLM, 2007).

3.7.4.3 KOP 3: Lincoln Highway

KOP 3 was selected for several reasons. It represents views looking north from the historic Lincoln Highway towards the Proposed Action power plant site (see Photo 3.7-3). Views from this location are similar to views of the valley (and the Proposed Action power plant site) that people driving north on U.S. 93 would have. KOP 3 also represents views from a nearby ranch. In addition, it is similar in distance (3 miles away) from the Proposed Action power plant site as several residences located in the Mattier Creek area (although they are located at a higher elevation than KOP 3).

Human-made features visible from this location are limited to the Lincoln Highway and U.S. 93 (approximately 1 mile to the west), a transmission line with wood poles that parallels U.S. 93, fences, and ranch buildings (behind the direction from which the photograph was taken).

BLM lands on the valley floor visible from this KOP have been designated VRM Class III in the Proposed Ely District Resource Management Plan (BLM, 2007).

3.7.4.4 KOP 4: U.S. 93

KOP 4 is located at an existing turnoff along U.S. 93 that is within approximately 0.25 to 0.5 mile of the Alternative 1 power plant site (see Photo 3.7-4). It represents close views that people driving north on U.S. 93 would have of Alternative 1 power plant facilities. KOP 4 is situated in one of the widest (10 miles) parts of Steptoe Valley. U.S. 93, some unpaved roads, and fencing are the only human-made features visible from this KOP. BLM lands seen from this location are Class III in the Proposed Ely District Resource Management Plan (BLM, 2007).



PHOTO 3.7-1
View from KOP 1



PHOTO 3.7-2
View from KOP 2

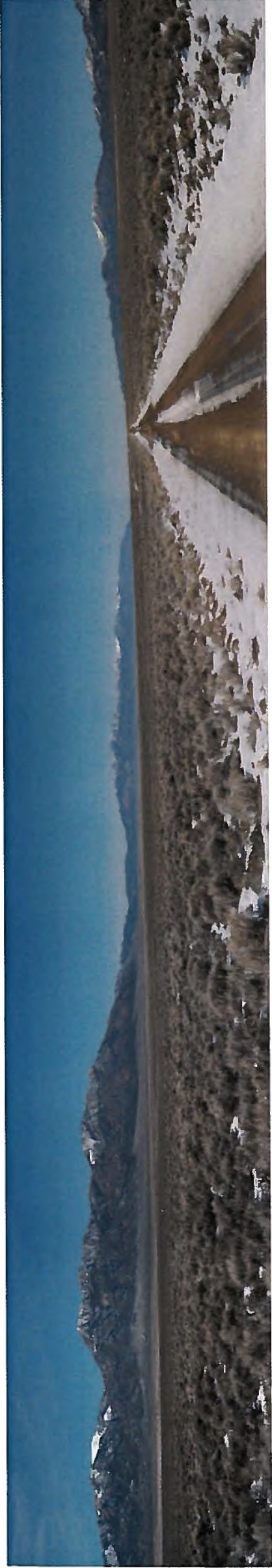

PHOTO 3.7-3
View from KOP 3

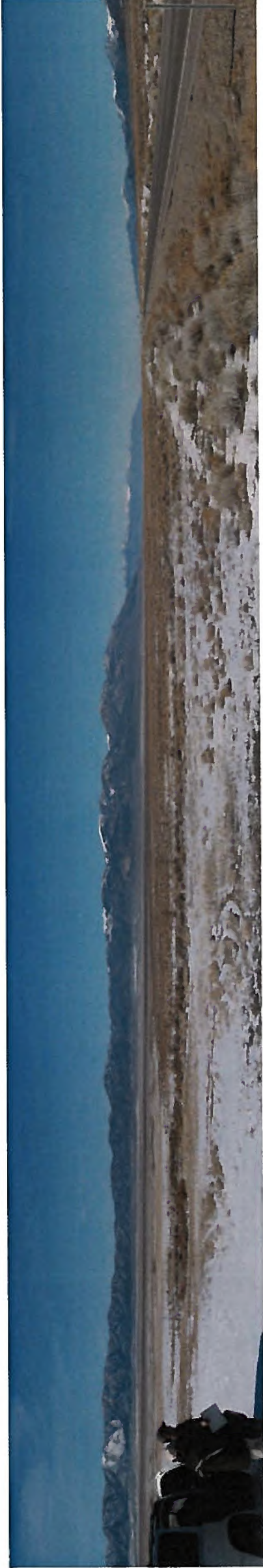
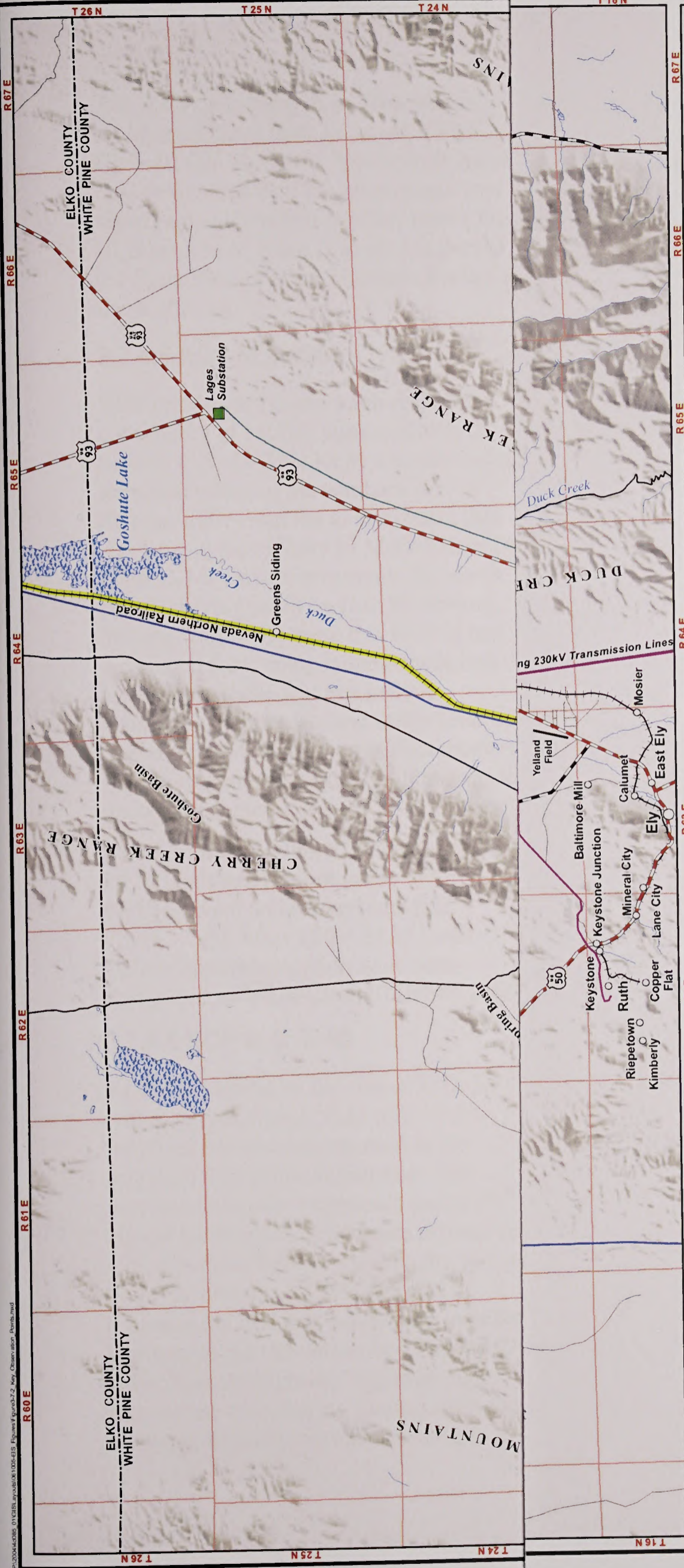
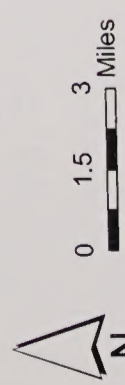
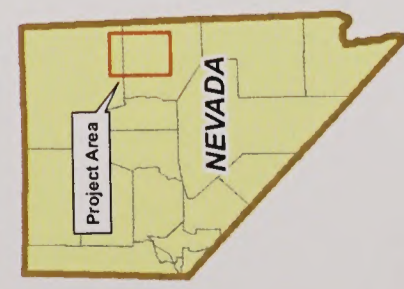

PHOTO 3.7-4
View from KOP 4



Key Observation Points (KOPs) White Pine Energy Station Project



1:300,000 when printed at 11 x 17 inches

Existing Electrical Features

- Existing Substation
- Existing Transmission Line
- Existing Distribution Line

Surface Water

- Perennial Stream or River
- Wetland

Connected Action

- SWIP Transmission Line
- NNR Upgrade

Common Project Features

- Minerals Materials Sale Area
- Moriah Ranches
- Seeding Project



Key Observation Point (KOP)

Proposed Action Project Features

- Proposed Well Site
- Proposed Water Pipeline/Distribution Line
- Proposed Rail Spur
- Proposed Transmission Line
- Proposed Electric Distribution Line
- Proposed Access Road
- Proposed Substation Site
- Proposed Power Plant Site

Alternative 1 Project Features

- Proposed Well Site
- Proposed Water Pipeline/Distribution Line
- Proposed Rail Spur
- Proposed Transmission Line
- Proposed Electric Distribution Line
- Proposed Access Road
- Proposed Substation Site
- Proposed Power Plant Site

Figure 3.7-2

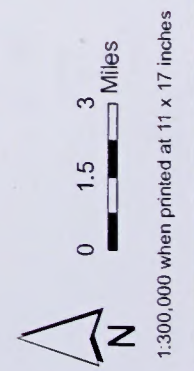
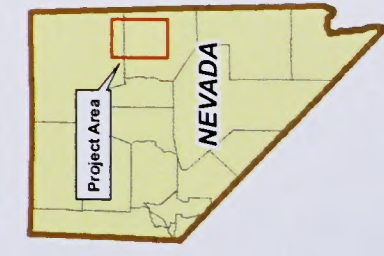
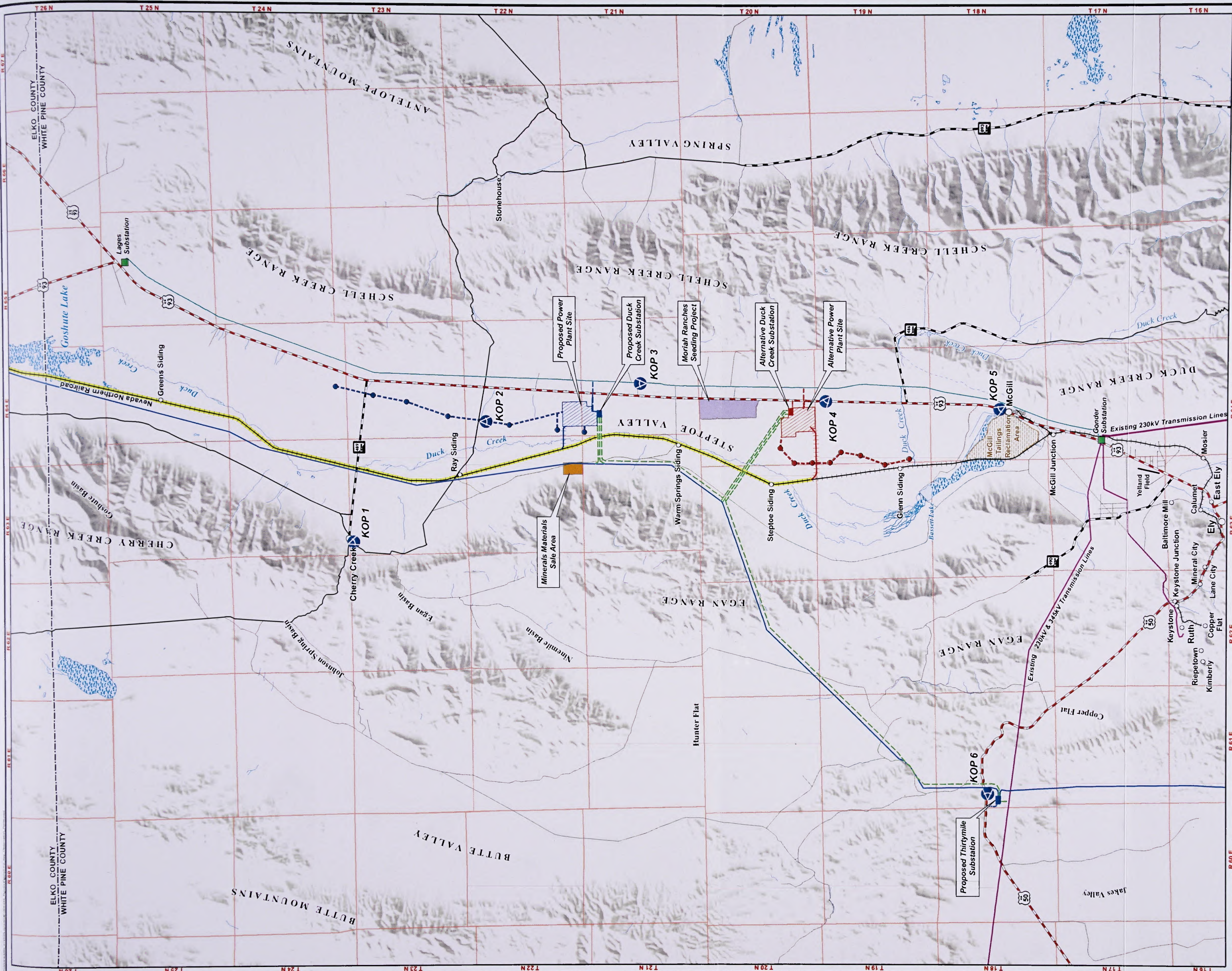

- Existing Electrical Features**
- Existing Substation
 - Existing Transmission Line
 - Existing Distribution Line
- Surface Water**
- Perennial Stream or River
 - Wetland
- Connected Action**
- SWIP Transmission Line
 - NNR Upgrade
- Common Project Features**
- Minerals Materials Sale Area
 - Moriah Ranches Seeding Project

- Proposed Action Project Features**
- Proposed Well Site
 - Proposed Water Pipeline/Distribution Line
 - Proposed Rail Spur
 - Proposed Transmission Line
 - Proposed Electric Distribution Line
 - Proposed Access Road
 - Proposed Substation Site
 - Proposed Power Plant Site
- Key Observation Point (KOP)**
- Key Observation Point (KOP)

- Alternative 1 Project Features**
- Proposed Well Site
 - Proposed Water Pipeline/Distribution Line
 - Proposed Rail Spur
 - Proposed Transmission Line
 - Proposed Electric Distribution Line
 - Proposed Access Road
 - Proposed Substation Site
 - Proposed Power Plant Site

**Key Observation Points (KOPs)
White Pine Energy Station Project**

Figure 3.7-2

This KOP is located in an area where BLM lands have been assigned VRM Class III (BLM, 2007). The nearest BLM land in the direction the photograph was taken that is classified as other than Class III is an area of Class II lands (on part of the Egan Range) approximately 8 miles to the northwest.

3.7.4.5 KOP 5: McGill

KOP 5 is located at the north end of the community of McGill approximately 30 feet west of U.S. 93. This KOP was selected to represent views of the southern part of Steptoe Valley and the analysis area that residents in the vicinity of McGill have (see Photo 3.7-5). It also represents the views people driving north on U.S. 93 have of Steptoe Valley. Because this KOP is in a developed area, many human-made features are visible. These features include residences, light poles, and utility lines to the east and the McGill Tailings Reclamation Area and scattered residential buildings to the west and north.

Lands adjacent to this KOP are private, but BLM lands can be seen in the middleground and background (see Photo 3.7-5). Most of the BLM lands visible from this location have been designated as VRM Class III (BLM, 2007).

3.7.4.6 KOP 6: U.S. 50

KOP 6 is located on the side of U.S. 50 within approximately 0.25 mile of the proposed entrance/access road to the proposed Thirtymile Substation. This section of highway represents one of the closest locations that motorists driving on U.S. 50 would have of viewing the entrance to the substation and the proposed transmission line that would pass over the highway to the substation (see Photo 3.7-6). Other than the highway, highway signs, and barbed wire fencing that parallels the highway, the adjacent hillsides visible from

this location have a natural appearance and do not contain human-made objects.

All of the BLM lands visible from this location (except the highway ROW) have been designated as VRM Class III lands (BLM, 2007).



PHOTO 3.7-5
View from KOP 5



PHOTO 3.7-6
View from KOP 6

3.8 Recreation Resources

This section describes recreational opportunities in the project area and discusses relevant recreation plans and policies. Federal, state, county, and private recreational opportunities within 50 miles of the project area are shown in Figure 3.8-1.

3.8.1 Analysis Area and Methodology

The analysis area for recreation resources includes all federal, state, local, and private recreation areas within 50 miles of the project route alternatives. This includes recreational opportunities on federal lands managed by the BLM and Forest Service, including WSAs. This analysis included a review of available existing recreation information in the analysis area, including information from the BLM Ely District Office, White Pine County, and the State of Nevada.

3.8.2 Recreational Opportunities on Federal Lands

3.8.2.1 Bureau of Land Management

The BLM provides a wide variety of dispersed outdoor recreational opportunities on more than 5 million acres of land in the analysis area. Recreational opportunities include fishing, hunting, camping, picnicking, hiking, spelunking, and wildlife viewing. Other activities include photography, nature study, rock climbing, mountain biking, horseback riding, cross-country skiing, off-highway vehicle riding, and scenic driving. The BLM also offers a number of developed recreation sites in the analysis area. Table 3.8-1 identifies the developed recreation areas managed by the BLM Ely District Office within 50 miles of the project route alternatives.

3.8.2.1.1 Garnet Hill Recreation Area

The Garnet Hill Recreation Area is located at the 7,000-foot Garnet Hill elevation, approximately 9.5 miles north of Ely via U.S. 50. This recreation area provides picnicking opportunities as well as rock collecting activities at the Garnet Fields Rockhounding Area (Recreation, 2005).

3.8.2.1.2 Cleve Creek Campground

Fishing, hiking, mountain biking, and cross-country skiing are available at the Cleve Creek Campground. Camping and a group barbecue area also are available at the Cleve Creek Campground (Recreation, 2005). The campground is approximately 26 miles southeast of Ely on U.S. 6/50, then north on SR 893 for 12 miles.

3.8.2.1.3 Egan Crest Trailhead

The Egan Crest Trailhead has picnic tables, grills, a gravel parking lot, an information kiosk, and a developed trail system. The trailhead is accessed on the north side of U.S. 50, approximately 8 miles west of Ely. The trail system has three loops north of the trail head (BLM, 2001a).

3.8.2.1.4 Goshute Creek Recreation Area

The Goshute Creek Recreation Area is approximately 60 miles north of Ely via White Pine County Road 21. The area offers hiking, picnicking, hunting, fishing, and camping (Nevada Commission on Tourism, 2005).

3.8.2.1.5 Ward Mountain Recreation Area

More than 20 miles of trails provide year-round use for hiking, trail biking, cross country skiing, motorcycling, and snow machining through the pinyon and juniper forested slopes of Ward Mountain. Campers and picnickers both use this site which is jointly administered by the BLM and Forest Service. The Ward Mountain Recreation Area is approximately 10 miles south of Ely via U.S. 6 (Reserve, 2005).

TABLE 3.8-1

Developed BLM Recreation Sites within 50 Miles of the Project Area

Recreation Area	Recreational Opportunities	Annual Visitation (visitor days)	Approximate Size (acres)	Distance to Proposed Action Project Site (miles)
Egan Crest Trailhead	Hiking, picnicking	7,232	65,000	41
Goshute Creek	Hiking, picnicking, hunting, fishing, camping	352	40	27
Garnett Hill	Fishing, wildlife observation, hiking, mineral collecting	10,200	1,280	22.5
Cleve Creek Campground	Fishing, hiking, mountain biking, camping, and cross-country skiing	10,055	40	23
Ward Mountain	Hiking, biking, picnicking, campground, bird watching, off-highway vehicle trails, hunting, Nordic skiing, snowshoeing	8,125	40	43

Source: Recreation (2005); (BLM 2001a); Nevada Commission on Tourism (2005); Reserve (2005); Tribble 2005.

3.8.2.2 Forest Service

The Ely Ranger District of the Humboldt-Toiyabe National Forest makes up 1.1 million acres of the Humboldt-Toiyabe National Forest and extends over Nye, White Pine, and Lincoln Counties. Ely, Nevada, located in the heart of the Ranger District, is the nearest town and houses the District office. The terrain of this district is mountainous, with elevations ranging from 6,500 feet to more than 12,000 feet above mean sea level. Some of the highest points in Nevada are in the Ely Ranger District (USFS, 2006a).

The Ely Ranger District offers numerous recreational opportunities including camping, trout/bass fishing, big game and bird hunting, wildlife viewing, mountain biking, horseback riding, cross-country skiing, bird watching, and picnicking (USFS, 2006a). The following text discusses developed Forest Service recreation areas within 50 miles of the project route alternatives.

3.8.2.2.1 East Creek Campground

The East Creek Campground is approximately 12 miles northeast of McGill off of Forest Service Road 427. The campground has seven campsites for both recreational vehicles (RVs) and tents, fire pits, cooking grills, and two vault toilets. East Creek runs through the middle of the picnic area.

Hiking is the primary recreational activity (USFS, 2006a).

3.8.2.2.2 Bird Creek Campground

The Bird Creek Campground is approximately 14 miles northeast of McGill off of Forest Service Road 426. The campground has eight group use sites for both RVs and tents, concrete pads, fire pits and cooking grills, drinking water, and a vault toilet. Bird Creek, a perennial stream, runs through the middle of the picnic area. Hiking is the primary recreational activity (USFS, 2006a).

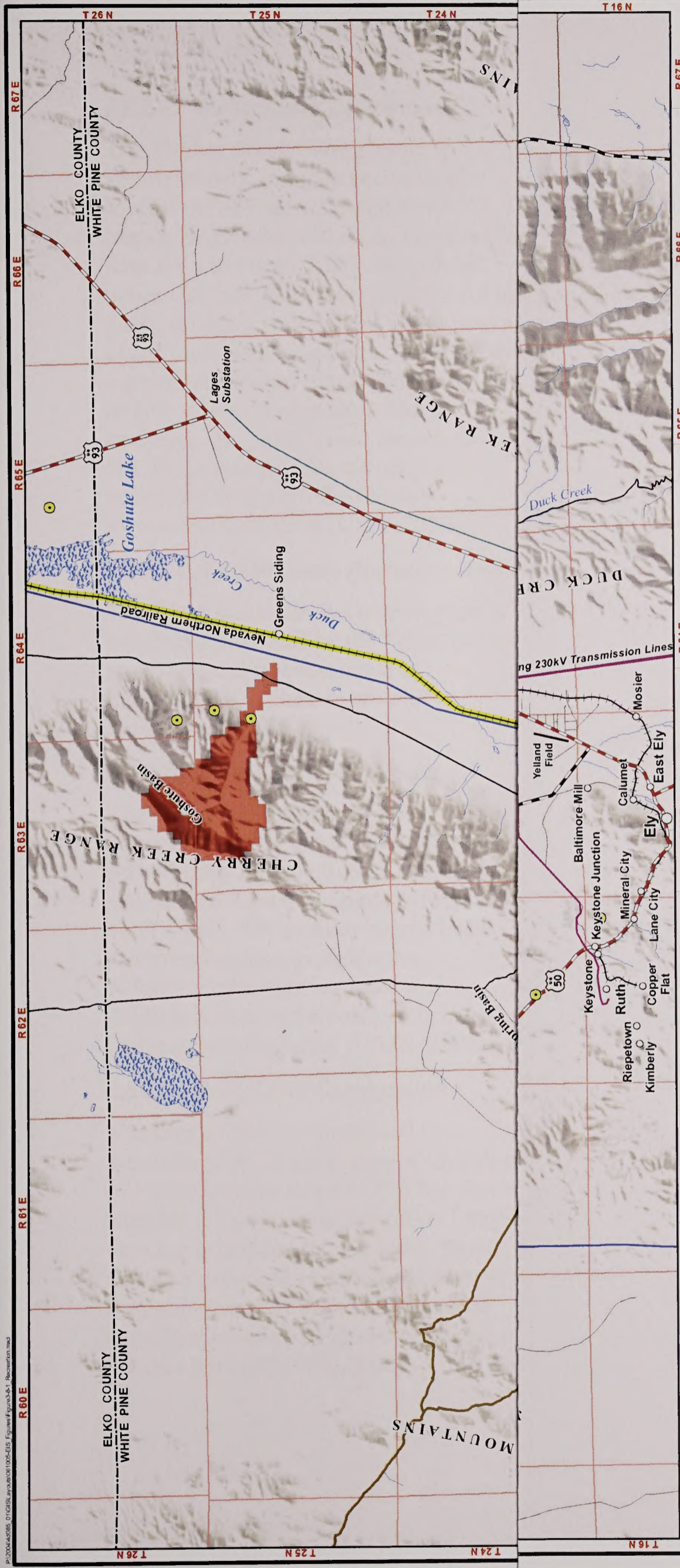

Developed Recreation Sites White Pine Energy Station Project

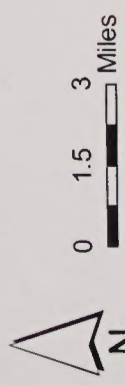
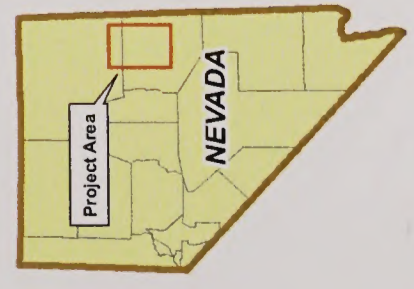

1:300,000 when printed at 11 x 17 inches

- Existing Electrical Features**
 - Existing Substation
 - Existing Transmission Line
 - Existing Distribution Line
- Surface Water**
 - Perennial Stream or River
 - Wetland
- Connected Action**
 - SWIP Transmission Line
 - NNR Upgrade
- Common Project Features**
 - Minerals Materials Sale Area
 - Moriah Ranches
 - Seeding Project

- Proposed Action Project Features**
 - Proposed Well Site
 - Proposed Water Pipeline/ Distribution Line
 - Proposed Rail Spur
 - Proposed Transmission Line
 - Proposed Electric Distribution Line
 - Proposed Access Road
 - Proposed Substation Site
 - Proposed Power Plant Site

- Alternative 1 Project Features**
 - Proposed Well Site
 - Proposed Water Pipeline/ Distribution Line
 - Proposed Rail Spur
 - Proposed Transmission Line
 - Proposed Electric Distribution Line
 - Proposed Access Road
 - Proposed Substation Site
 - Proposed Power Plant Site

- Recreation Site**
 - Pony Express Trail
 - Goshute Canyon Natural Area
 - Heusser Mountain Bristlecone
 - Pine Natural Area

Figure 3.8-1

TABLE 3.8-1

Developed BLM Recreation Sites within 50 Miles of the Project Area

Recreation Area	Recreational Opportunities	Annual Visitation (visitor days)	Approximate Size (acres)	Distance to Proposed Action Project Site (miles)
Egan Crest Trailhead	Hiking, picnicking	7,232	65,000	41
Goshute Creek	Hiking, picnicking, hunting, fishing, camping	352	40	27
Garnett Hill	Fishing, wildlife observation, hiking, mineral collecting	10,200	1,280	22.5
Cleve Creek Campground	Fishing, hiking, mountain biking, camping, and cross-country skiing	10,055	40	23
Ward Mountain	Hiking, biking, picnicking, campground, bird watching, off-highway vehicle trails, hunting, Nordic skiing, snowshoeing	8,125	40	43

Source: Recreation (2005); (BLM 2001a); Nevada Commission on Tourism (2005); Reserve (2005); Tribble 2005.

3.8.2.2 Forest Service

The Ely Ranger District of the Humboldt-Toiyabe National Forest makes up 1.1 million acres of the Humboldt-Toiyabe National Forest and extends over Nye, White Pine, and Lincoln Counties. Ely, Nevada, located in the heart of the Ranger District, is the nearest town and houses the District office. The terrain of this district is mountainous, with elevations ranging from 6,500 feet to more than 12,000 feet above mean sea level. Some of the highest points in Nevada are in the Ely Ranger District (USFS, 2006a).

The Ely Ranger District offers numerous recreational opportunities including camping, trout/bass fishing, big game and bird hunting, wildlife viewing, mountain biking, horseback riding, cross-country skiing, bird watching, and picnicking (USFS, 2006a). The following text discusses developed Forest Service recreation areas within 50 miles of the project route alternatives.

3.8.2.2.1 East Creek Campground

The East Creek Campground is approximately 12 miles northeast of McGill off of Forest Service Road 427. The campground has seven campsites for both recreational vehicles (RVs) and tents, fire pits, cooking grills, and two vault toilets. East Creek runs through the middle of the picnic area.

Hiking is the primary recreational activity (USFS, 2006a).

3.8.2.2.2 Bird Creek Campground

The Bird Creek Campground is approximately 14 miles northeast of McGill off of Forest Service Road 426. The campground has eight group use sites for both RVs and tents, concrete pads, fire pits and cooking grills, drinking water, and a vault toilet. Bird Creek, a perennial stream, runs through the middle of the picnic area. Hiking is the primary recreational activity (USFS, 2006a).



Developed Recreation Sites White Pine Energy Station Project

Existing Electrical Features

- Existing Substation
- Existing Transmission Line
- Existing Distribution Line

Surface Water

- Perennial Stream or River
- Wetland

Connected Action

- SWIP Transmission Line
- NNR Upgrade

Common Project Features

- Minerals Materials Sale Area
- Moriah Ranches
- Seeding Project

Proposed Action Project Features

- Proposed Well Site
- - - Proposed Water Pipeline/Distribution Line
- + Proposed Rail Spur
- - - Proposed Transmission Line
- - - Proposed Electric Distribution Line
- Proposed Access Road
- Proposed Substation Site
- Proposed Power Plant Site

Alternative 1 Project Features

- Proposed Well Site
- - - Proposed Water Pipeline/Distribution Line
- + Proposed Rail Spur
- - - Proposed Transmission Line
- - - Proposed Electric Distribution Line
- Proposed Access Road
- Proposed Substation Site
- Proposed Power Plant Site

Recreation Site

- Pony Express Trail
- Goshute Canyon Natural Area
- Heusser Mountain Bristlecone Pine Natural Area

1:300,000 when printed at 11 x 17 inches

Figure 3.8-1

3.8.2.2.3 Timber Creek Campground

The Timber Creek Campground is approximately 16 miles northeast of McGill off of Forest Service Road 425. It has six single sites and six group sites for both RVs and tents. The campground offers concrete pads, fire pits and cooking grills, drinking water, vault toilets, and a playground with a sandbox. Timber Creek, a perennial stream, runs through the middle of the campground, and all campsites are located near the stream. Hiking, nature/wildlife viewing, and horseback riding are the primary recreational activities (USFS, 2006a).

3.8.2.2.4 Ward Mountain Recreation Area

The Ward Mountain Recreation Area is jointly administered by the Forest Service and BLM and was discussed in Section 3.8.2.1, *Bureau of Land Management*.

3.8.2.2.5 White River Campground

The White River Campground is approximately 34 miles southeast of Ely off of Forest Service Road 1163. It has ten sites with fire pits, camping grills, and vault toilets. The primary recreational activities are hiking, sightseeing, wildlife/nature viewing, backpacking, hunting, and all-terrain vehicle/off-highway vehicle riding (USFS, 2006a).

3.8.2.2.6 Berry Creek Campground

The Berry Creek Campground is approximately 20 miles east of McGill off of Forest Service Road 424. It has five sites for RVs and tents and offers fire pits, cooking grills, and a vault toilet. Berry Creek, a perennial stream, runs through the campground. Primary recreational activities include hiking and wildlife/nature viewing (USFS, 2006a).

3.8.2.3 National Historic Trails

The Pony Express National Historic Trail is located almost entirely on BLM managed lands in the project area and enters Steptoe Valley via Egan Canyon (see Figure 3.8-1). Recreational uses of the trail include hiking, biking, horseback riding, and historic reenactments of the trail experience. Use of the trail is increasing because of heritage tourism (people rediscovering their past), commemorative activities, and media interest (National Park Service, 2005).

3.8.3 Recreational Opportunities on State Lands

3.8.3.1 Cave Lake State Park

Cave Lake State Park is approximately 15 miles southeast of Ely via SR 486. The 32-acre reservoir at Cave Lake State Park is popular for trout fishing, boating, picnicking, and camping. The park is located in the Schell Creek Range at an elevation of 7,300 feet, offering scenic views and opportunities for nature study and photography. Facilities include campgrounds, picnic areas, hiking trails, and a boat launch. Winter sports such as ice fishing, cross-country skiing, and ice-skating also are available. According to the Nevada Division of State Parks (Nevada Division of State Parks), Cave Lake is open all year, weather permitting (Nevada Division of State Parks, 2005). Visitation at Cave Lake for the year 2004 was 96,389 (Manning, 2005).

3.8.3.2 Comins Lake

Comins Lake is approximately 10 miles southeast of Ely via U.S. Highway 50/6/93. Originally established by the realignment of U.S. 93 that created a dam, it is fed by Steptoe, Cave, and Willow Creeks. At capacity, the lake

covers 410 surface acres and has a maximum depth of 15 feet. In 1999, the lake and the adjacent 3-C Ranch were purchased by the Nevada Department of Wildlife (NDOW). The lake is now managed to maximize fisheries resources and is inhabited by rainbow trout, brown trout, largemouth bass, and northern pike. In 2003, there were 23,251 angler-use days at Comins Lake (Crookshanks, 2005). There is a primitive boat launch and restrooms on site; however, no overnight camping or fires are permitted (NDOW, 2006).

3.8.3.3 Ward Charcoal Ovens State Historic Park

The Ward Charcoal Ovens State Historic Park is approximately 18 miles south of Ely via U.S. 50/6/93 and is known for its six historic charcoal ovens. These beehive-shaped ovens were used in the late 19th century to generate charcoal for use in the mines of nearby Ward. Today, the park offers limited facilities for picnicking and camping. Other features include forested woodlands, riparian areas, and views of Steptoe Valley and the surrounding mountains (Nevada Division of State Parks, 2005). Annual visitation at the Ward Charcoal Ovens in 2004 was 5,270 (Manning, 2005).

3.8.4 Recreational Opportunities on County Lands

Recreational facilities owned and operated by White Pine County include a golf course, tennis courts, numerous ball parks, six town parks, neighborhood parks, a shooting range, a summer swimming hole, and playgrounds (White Pine County, 2005b). These facilities are located in the City of Ely and the community of McGill.

The county also operates the White Pine County Rodeo Grounds and Fairgrounds north of Ely. Additionally, the City of Ely owns and operates the Ghost Train, which is a tourist train operation along the portion of the NNR from Keystone to McGill Junction. Other recreational opportunities in White Pine County are provided on state and federal lands. The varied outdoor recreational opportunities include camping, hiking, fishing, backpacking, horseback riding, all-terrain vehicle riding, mountain biking, cross-country skiing, snowmobiling, nature photography, wildlife viewing, and hunting.

3.8.5 Private Recreational Opportunities

3.8.5.1 Basset Lake

Basset Lake is approximately 4 miles northwest of McGill off of U.S. 93. Originally established in 1942 as a settling pond for mill tailings from local copper mines, it is now owned by the Kennecott Copper Corporation. At capacity, Basset Lake covers 77 surface acres and has an average depth of 5 feet. Its primary water source is Tailings Creek. It contains northern pike, largemouth bass, and a sizeable population of nuisance carp. In 2003, there were 670 angler-use days at Basset Lake (Crookshanks, 2005). There is a primitive boat ramp; however, no restrooms or overnight camping facilities exist at the lake (NDOW, 2006).

3.8.5.2 Campgrounds and RV Parks

Several private campgrounds and RV parks exist near the project area. Table 3.8-2 lists these campground and RV parks.

TABLE 3.8-2

Private Campgrounds and RV Parks within 50 Miles of the Project Area

Name	Amenities	Size	Distance to Proposed Action Project Site (miles)
Ely KOA Campground	Full hook-ups, cable TV, phones, pets, playground, tent sites, horse boarding	100 sites; 20 mobile home sites; 2 cabins	35.5
Harry's Wilderness Station	Full hook-ups	10 sites	32
Holiday Inn and Prospector's Casino	Phone, dining, slots, laundry, indoor pool	13 sites; 61 hotel rooms	33
Lanes Ranch RV Park	Cable TV, phones, store, pets, gas	7 sites; 15 motel rooms	57
Major's Station RV Park	Phone, slots, bar	7 sites	59
Schellbourne Station Motel and RV Park	Gas, dining, gaming, pets	18 sites; 5 motel rooms	7
Valley View RV Park	Cable, phones, propane, showers, laundry	46 sites	32
West End RV Park	None	11 sites	33

Source: White Pine Tourism, 2006

3.8.6 Recreation Management Plans and Policies

A number of land management plans and policies exist in the project area. These include BLM Resource Management Plans, the *Statewide Comprehensive Outdoor Recreation Plan* (SCORP), and county land use regulations. These plans and policies as they relate to recreation opportunities are described further below.

3.8.6.1 BLM Resource Management Plans

The proposed project lies within an area that is currently managed under the Egan Resource Area Resource Management Plan (BLM, 1984b), but will soon be managed under the nearly-finalized Ely District Resource Management Plan. The Egan Resource Area Resource Management Plan governs management of 3.8 million acres of public land in east-central Nevada. It was adopted by the Ely Field Office of the BLM in 1984. Most of

the plan area is in White Pine County, although portions are in Nye and Lincoln Counties. Section 3.11, *Special Designations*, discusses recent Wilderness designations.

The Ely Field Office has prepared the Proposed Ely District Resource Management Plan/Final Environmental Impact Statement (BLM, 2007) which will consolidate and update management direction for all BLM-managed lands in the Ely District and replace three separate planning documents (the Egan Resource Management Plan and the Schell and Caliente Management Framework Plans) that have guided management of public lands in the Ely District for over 15 years.

3.8.6.2 NPS/USFS/FWS Management Plans

National Park Service Historic Trails Management Plan

The National Park Service completed a Comprehensive Management and Use

Plan and Final EIS in 1999 for the Pony Express National Historic Trail along with three other historic trails. The document focuses on the trail's purpose and significance, issues, and concerns related to current conditions along the trail, resource protection, visitor experience and use, and long-term administrative and management objectives.

The plan identifies high-potential route segments and sites. High-potential segments are "Those portions of trail which would afford a high quality recreation experience in a portion of the route having greater-than-average scenic values or affording an opportunity to vicariously share in the experience of the original users of the historic route" (National Park Service, 2000). High-potential sites are "Those historic sites related to the route which provide opportunity to interpret the historic significance of the trail during the period of its major use" (National Park Service, 2000). In the analysis area, the National Park Service identifies the Overland Canyon to Simpson Park Station segment of the Pony Express National Historic Trail as a high-potential segment.

3.8.6.3 State Plans and Policies

The SCORP, prepared by the Nevada Division of State Parks (1992), provides an assessment of Nevada's characteristics, people, resources, and recreational activities and critical recreation issues facing the state. The SCORP identifies the major recreation sites in Nevada.

According to the plan, the outdoor recreational activity with the highest actual participation rate in Nevada (90 percent of telephone survey respondents) was defined as "relaxing outdoors." Hiking, walking, picnicking, and pleasure driving were also popular, with about 75 percent of all

respondents participating in these activities.

The SCORP also identifies future recreation issues and actions for the state as a whole. One of the issues applicable to the proposed project is the protection of Nevada's scenic resources, including "undisturbed mountainous areas that are not impaired by development (including roads, open mines, transmission towers, etc)." The actions to protect these resources are to: (1) prepare resource protection plans in parks with substantial natural, cultural, or scenic resources; (2) identify all areas that are environmentally sensitive; and (3) encourage other public landowners to use their properties as parkland and preserve sensitive areas for their scenic resources.

Another applicable issue identified in the plan is the protection of public access to public lands. The actions to address this issue include: (1) land exchanges, easements, ROWs, purchases, or cooperative agreements; and (2) acquisition of ROWs to public lands that are blocked by private lands and of in-holdings to solidify public land parcels.

A final applicable issue identified in the SCORP is the need to provide recreational, multiple-use trails in "wildland-urban interface" areas. The actions to address this issue include: (1) encourage trails on existing public and quasi-public lands (lands with attributes similar to public lands), and (2) encourage area-wide trail planning to develop master trail systems and connectors.

Visitation of developed, and especially dispersed recreational sites in Nevada, including those in the project area, has been increasing (Tribble, 2005). Visitation will likely continue to increase

proportionately with the growing statewide population.

3.8.6.4 County Plans and Policies

3.8.6.4.1 White Pine County Land Use Plan

The White Pine County Land Use Plan (White Pine County, 1998a) encourages development of county-wide recreation areas and supports activities by participating in county-wide youth programs and activities, enhancing and preserving existing recreational facilities, and supporting new recreational facilities in the county.

3.8.6.4.2 White Pine County Public Land Use Plan

The White Pine County Public Land Use Plan (White Pine County, 1998b), a coordinated land use planning effort among the county, BLM, and Forest Service, encourages dispersed recreational opportunities. The plan also states that federally managed lands with the value for concentrated recreation use (campgrounds, water recreation sites, etc.) should be identified, developed, and managed for recreational purposes.

3.9 Land Use

Land use studies involved a review of related county, state, and federal land use plans, as well as land use plats and other land records. Data were compiled to assess potential land use impacts from the construction, operation, and maintenance of the proposed White Pine Energy Station power plant, transmission lines, water lines, access roads, and railroad spur. Potential impacts are assessed in Chapter 4.

3.9.1 Existing Land Use and Land Ownership

3.9.1.1 Land Use in the Project Area

The project would be located entirely in White Pine County, Nevada, approximately 26 miles south of the White Pine County/Elko County line and approximately 40 miles west of the Nevada/Utah border. Prominent landmarks in the project area include U.S. 93 and the Schell Creek Range (in the Humboldt-Toiyabe National Forest, Ely Field Office) to the east; Duck Creek and the Egan Range to the west; and Goshute Lake to the north. The City of Ely is approximately 34 miles and 22 miles south, respectively, of the Proposed Action and Alternative 1 power plant sites. Ely is at 6,427 feet in elevation and has a population of approximately 4,041 people. The community of McGill is approximately 22 miles and 10 miles south, respectively, of the Proposed Action and Alternative 1 power plant sites. McGill sits at an elevation of 6,210 feet and has a population of approximately 1,054 people (City-data, 2005). Great Basin National Park, also in White Pine County, is approximately 57 miles to the southeast.

Land in the project area is primarily used for grazing. Other land uses in the area include recreation and small areas of commercial, agriculture, industrial, and residential uses. The project area includes a number of grazing allotments on federal lands. These

allotments are open range lands used periodically for cattle grazing or that have the potential to be used for grazing. Allotments are grazed at different times of the year and at varying intensities. Section 3.10, *Rangeland Resources*, provides additional detail about grazing allotments.

At one time, White Pine County was the largest mineral wealth producing county in Nevada; however, because of various factors, mining activity has decreased significantly. The Telegraph, Hunter, and Granite Mining Districts all fall within the project area, but mining in those Districts is not currently economically feasible, although mining is occurring in other Districts in the region (BLM, 2005). By filing a mining claim, a claimant secures the legal right to explore for locatable mineral resources, and upon 'proving' the claim, has a right to patent the area covered by the claim into private ownership. The presence of active mining claims indicates there is a potential for future mining activity in the Districts.

Transportation routes located within the project area include U.S. highways, state highways, major and minor White Pine County roads, and a railroad line. Several minor dirt roads would be improved for construction access purposes and new access roads would be constructed as described in Chapter 2, *Description of Proposed Action and Alternatives*.

3.9.1.2 Land Ownership Status

Two major categories of land ownership status were identified in the area: (1) federal land, and (2) privately held land. Table 3.9-1 lists the primary land managers within 30 miles of the project area. The BLM administers the vast majority of land in the project area (approximately 79 percent) through the BLM Ely District Field Office. Approximately 16 percent of the land is federally owned by other agencies and approximately 5 percent is privately owned.

TABLE 3.9-1

Land Ownership Status within White Pine County

Land Status Category within White Pine County	Acres	Percent
BLM	4,932,718	78.82
Forest Service, National Park Service, Bureau of Indian Affairs, Department of Defense	992,147	15.86
Private	301,850	4.82
State Of Nevada	6,512	0.10
Other (water)	24,772	0.40
Total	6,257,999	100.00

Source: EDAW GIS analysis, May 2005

On December 20, 2006, President Bush signed into law the White Pine County Conservation, Recreation and Development Act of 2006 (PL 109-432) which requires that four parcels of land containing approximately 3,526 acres in Steptoe Valley (including a portion of the Alternative 1 power plant site described as the SW1/4 and SE1/4 of the NW1/4 of Section 28, containing 80 acres more or less) be held in trust by the United States for the benefit of the Ely Shoshone Tribe. It is understood that the Tribe plans to use said lands in the immediate vicinity of the proposed White Pine Energy Station for economic/energy related industrial development purposes.

Figure 3.9-1 shows land ownership in White Pine County. The largest privately held landholdings include the following:

- One owner holding approximately 2,013 acres in various parcels in T20N, R64E and T20N, R63E
- One owner holding approximately 1,920 acres in various parcels in T26N, R65E
- One owner holding approximately 710 acres in various parcels in T21N, R64E

- One owner holding approximately 640 acres in various parcels in T20N, R64E
- One owner holding approximately 600 acres in one parcel in T21N, R64E

Figure 3.9-1 also shows public land transferred to the Ely Shoshone Tribe pursuant to Subtitle F, Section 361, of the White Pine County Conservation, Recreation and Development Act of 2006 (PL 109-432).

3.9.2 Designated Land Use

3.9.2.1 BLM Land Use Authorizations

The BLM grants land use authorizations that allow private entities and other government agencies to use BLM lands for specific purposes. Most land use authorizations in the project area are ROWs for roads and utilities.

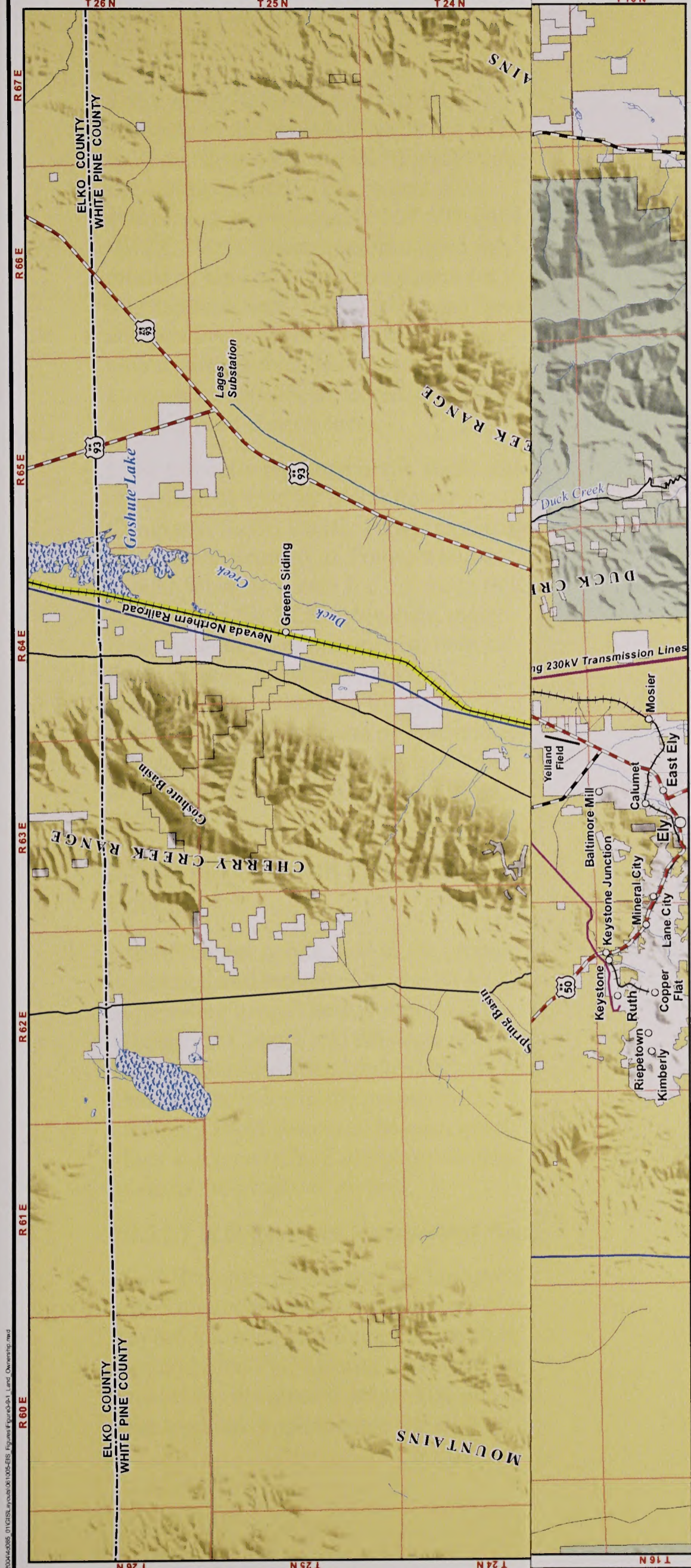

Land Ownership Status White Pine Energy Station Project

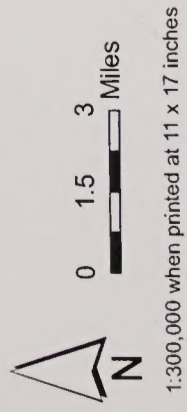
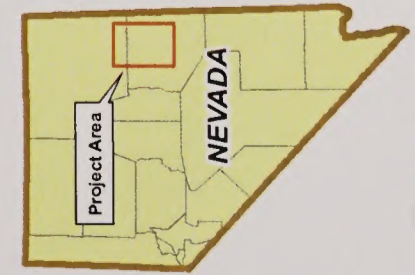

- Existing Electrical Features**
 - Existing Substation
 - Existing Transmission Line
 - Existing Distribution Line
- Surface Water**
 - Perennial Stream or River
 - Wetland
- Connected Action**
 - SWIP Transmission Line
 - NNR Upgrade
- Common Project Features**
 - Minerals Materials Sale Area
 - Moriah Ranches
 - Seeding Project

- Proposed Action Project Features**
 - Proposed Well Site
 - Proposed Water Pipeline/Distribution Line
 - Proposed Rail Spur
 - Proposed Transmission Line
 - Proposed Electric Distribution Line
 - Proposed Access Road
 - Proposed Substation Site
 - Proposed Power Plant Site

- Alternative 1 Project Features**
 - Proposed Well Site
 - Proposed Water Pipeline/Distribution Line
 - Proposed Rail Spur
 - Proposed Transmission Line
 - Proposed Electric Distribution Line
 - Proposed Access Road
 - Proposed Substation Site
 - Proposed Power Plant Site

- Land Ownership**
 - Bureau of Land Management
 - Forest Service
 - Ely Shoshone Tribe
 - Private

Figure 3.9-1

TABLE 3.9-1

Land Ownership Status within White Pine County

Land Status Category within White Pine County	Acres	Percent
BLM	4,932,718	78.82
Forest Service, National Park Service, Bureau of Indian Affairs, Department of Defense	992,147	15.86
Private	301,850	4.82
State Of Nevada	6,512	0.10
Other (water)	24,772	0.40
Total	6,257,999	100.00

Source: EDAW GIS analysis, May 2005

On December 20, 2006, President Bush signed into law the White Pine County Conservation, Recreation and Development Act of 2006 (PL 109-432) which requires that four parcels of land containing approximately 3,526 acres in Steptoe Valley (including a portion of the Alternative 1 power plant site described as the SW1/4 and SE1/4 of the NW1/4 of Section 28, containing 80 acres more or less) be held in trust by the United States for the benefit of the Ely Shoshone Tribe. It is understood that the Tribe plans to use said lands in the immediate vicinity of the proposed White Pine Energy Station for economic/energy related industrial development purposes.

Figure 3.9-1 shows land ownership in White Pine County. The largest privately held landholdings include the following:

- One owner holding approximately 2,013 acres in various parcels in T20N, R64E and T20N, R63E
- One owner holding approximately 1,920 acres in various parcels in T26N, R65E
- One owner holding approximately 710 acres in various parcels in T21N, R64E

- One owner holding approximately 640 acres in various parcels in T20N, R64E
- One owner holding approximately 600 acres in one parcel in T21N, R64E

Figure 3.9-1 also shows public land transferred to the Ely Shoshone Tribe pursuant to Subtitle F, Section 361, of the White Pine County Conservation, Recreation and Development Act of 2006 (PL 109-432).

3.9.2 Designated Land Use

3.9.2.1 BLM Land Use Authorizations

The BLM grants land use authorizations that allow private entities and other government agencies to use BLM lands for specific purposes. Most land use authorizations in the project area are ROWs for roads and utilities.

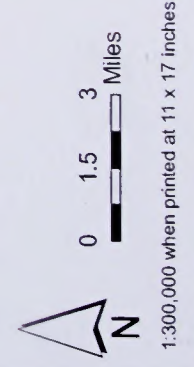
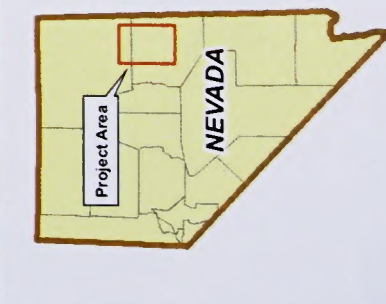
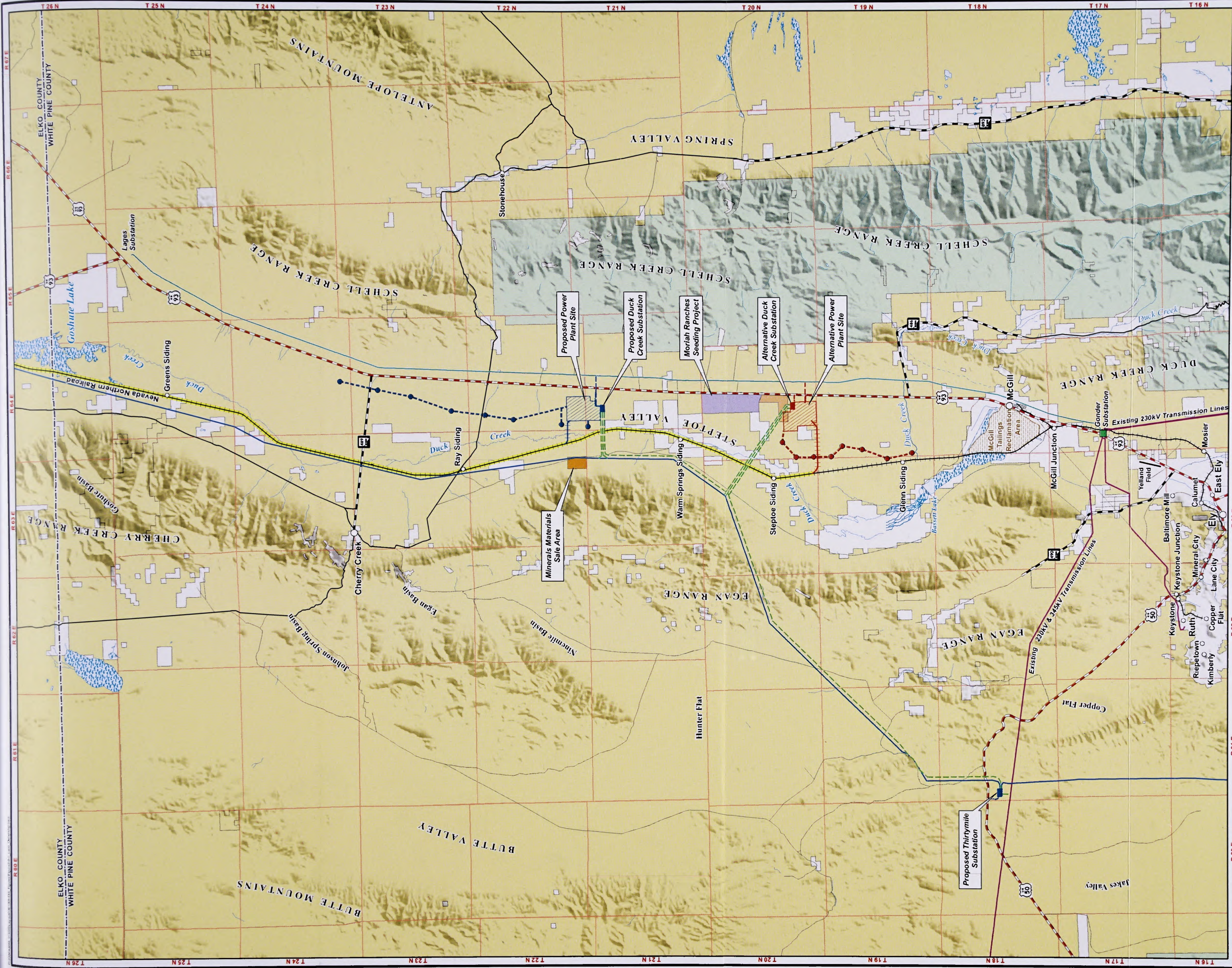

- Existing Electrical Features**
- Existing Substation
 - Existing Transmission Line
 - Existing Distribution Line
- Surface Water**
- Perennial Stream or River
 - Wetland
- Connected Action**
- SWIP Transmission Line
 - NNR Upgrade
- Common Project Features**
- Minerals Materials Sale Area
 - Moriah Ranches
 - Seeding Project

- Proposed Action Project Features**
- Proposed Well Site
 - Proposed Water Pipeline/Distribution Line
 - Proposed Rail Spur
 - Proposed Transmission Line
 - Proposed Electric Distribution Line
 - Proposed Access Road
 - Proposed Substation Site
 - Proposed Power Plant Site

- Alternative 1 Project Features**
- Proposed Well Site
 - Proposed Water Pipeline/Distribution Line
 - Proposed Rail Spur
 - Proposed Transmission Line
 - Proposed Electric Distribution Line
 - Proposed Access Road
 - Proposed Substation Site
 - Proposed Power Plant Site

- Land Ownership**
- Bureau of Land Management
 - Forest Service
 - Ely Shoshone Tribe
 - Private

White Pine Energy Station Project

Figure 3.9-1

The Legacy Rehost 2000 Database, available at the Nevada BLM State Office in Reno, shows that the BLM has 67 land use authorizations in the project area, comprising approximately 257,508 acres (BLM, 2005). These authorizations are primarily held by utility companies for transmission lines, roads, telephone lines, and pipelines. Other land use authorizations include recreation or public purpose leases, airport leases, and material sites for road construction.

Land use authorizations in the study area are primarily held by Idaho Power Company, Sierra Pacific Power Company, Nevada Department of Transportation, Mount Wheeler Power Inc., Nevada Bell, WPEA, and the BLM. However, many land use authorizations are also held by other entities, including road authorizations belonging to private individuals and telephone or transmission line authorizations belonging to smaller telecommunications companies (BLM, 2005).

3.9.2.2 Management Plans and Policies

Use of federal public land in the project area is planned and regulated by the BLM. Use of privately owned land is regulated by White Pine County and the State of Nevada. This section describes applicable land use plans and policies in the project area, including BLM Resource Management Plans and county land use plans as they relate to the proposed project.

3.9.2.2.1 BLM Resource Management Plans

BLM Resource Management Plans are long-range, comprehensive land use plans that are intended to provide for multiple uses and identify planning objectives and policies for designated areas. The planning objectives are implemented through

activity plans, such as allotment management plans, wildlife habitat management plans, and wild horse herd management area plans. The Resource Management Plans also provide standard operating procedures that are inherent to the implementation of any federal action on public lands, such as completing environmental analysis before project development (BLM, 2001a).

The proposed project would be located in the BLM Ely District. Applicable land use objectives and policies from the Egan Resource Management Plan are summarized in the following text.

Egan Resource Management Plan

The Egan Resource Management Plan is a 20-year plan to manage 3.8 million acres of public land in east-central Nevada by the BLM Ely District Field Office (BLM, 1984b). Most of the resource area is in White Pine County, with portions in Nye and Lincoln Counties. The Resource Management Plan focuses on various resource issues including realty actions, which includes a discussion of utility corridors. Figure 3.9-2 illustrates the current utilities and utility corridors in the project area and is based on information presented in the Egan Resource Management Plan map and amendment. The overall objective of the Egan Resource Management Plan is to provide a balanced approach to land management that protects fragile and unique resources, while not overly restricting the ability of other resources to provide economic goods and services. Management objectives relating specifically to realty actions and to the proposed project are summarized in the following text.

Proposed Ely Resource Management Plan

The Ely Field Office has prepared the Proposed Ely District Resource

Management Plan/Final Environmental Impact Statement (BLM, 2007) which will consolidate and update management direction for all BLM-managed lands in the Ely District and replace three separate planning documents (the Egan Resource Management Plan and the Schell and Caliente Management Framework Plans) that have guided management of public lands in the Ely District for over 15 years.

Realty Actions

Sale of BLM Land: Management

Objective. Dispose of lands to provide for more effective management of public lands in the planning area. Land disposals are not in big game or upland game habitat or in wild horse herd use areas. All land disposals would be done in a planned and orderly manner and would not adversely affect threatened or endangered species, destroy or degrade wetlands or riparian areas, or lead to the modification of floodplains.

Sale of BLM Land: Relationship to Proposed Project. In addition to the parcel of land that would be selected for the Proposed Action or Alternative 1 power plant site, other lands in the project area have been identified for disposal.

Utility Corridors: Management

Objective. Identify two existing utility corridors, one running north-south and one running east-west, and designate two other planned corridors, one running north-south and one running east-west. The actual route would be established after environmental analysis is completed for the ROW, and each corridor would be 5 miles wide to provide opportunities for multiple transmission facilities and selection of routes that minimize environmental degradation in a cost-effective manner. Applicants for use of a corridor would be required to locate new facilities proximate to

existing facilities except where considerations of construction feasibility, cost, resource protection, or safety are overriding. Corridors provide for a variety of ROW uses including power lines, pipelines, railroads, and highways. The major use expected in the Resource Management Plan area is related to installation of transmission lines.

Utility Corridors: Relationship to Proposed Project. Most of the length of the transmission lines for the proposed project would be located within the existing SWIP utility corridor (31 of 34 miles for the Proposed Action and 24 of 28.5 miles for Alternative 1).

3.9.2.2.2 County Land Use Plans and Policies

White Pine County Land Use Plan

The White Pine County Land Use Plan (White Pine County, 1998a) is intended to guide development of land resources in the county through 2017. Sustaining environmental values and promoting expansion and diversification of the regional economy are important goals expressed in the plan. The White Pine County Land Use Plan describes land use issues in the county, as well as in the specific planning areas of Ely, Baker, Lund, McGill, Preston, Ruth, and the Ely-McGill corridor. The plan also provides a number of land use goals and implementation strategies; however, it contains no goals or strategies related specifically to utilities or utility corridors, other than a provision for the efficient use of community infrastructure. In the 2007 update to the White Pine County Public Land Use Plan, the Board of County Commissioners adopted policies to guide potential energy projects in their selection of air emission control technologies, including the use of Best Available Control Technologies (White Pine County, 2007).

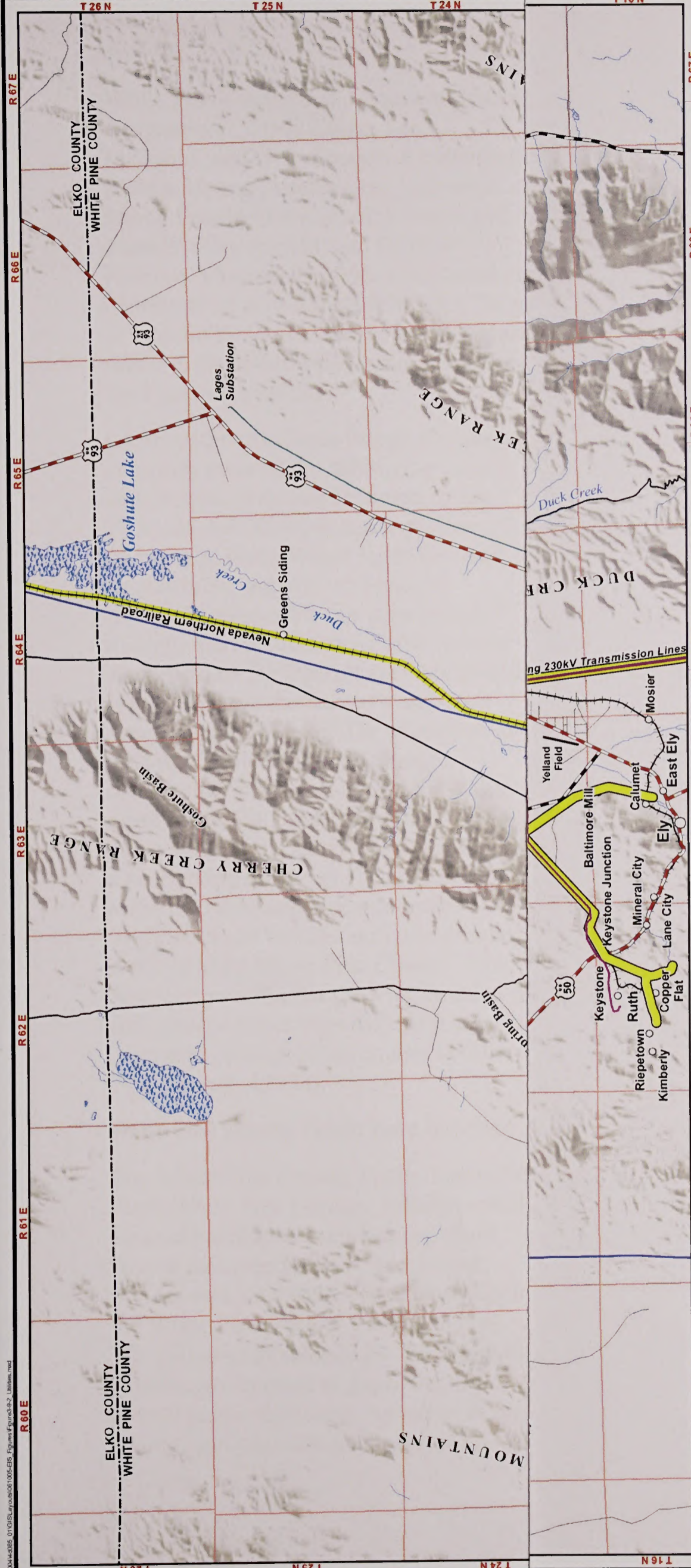

Utilities and Utility Corridors White Pine Energy Station Project

- | | | | | | | |
|--|--|--|---|---|---|---|
| <p>Existing Electrical Features</p> <ul style="list-style-type: none"> Existing Substation Existing Transmission Line Existing Distribution Line | <p>Surface Water</p> <ul style="list-style-type: none"> Perennial Stream or River Wetland | <p>Connected Action</p> <ul style="list-style-type: none"> SWIP Transmission Line NNR Upgrade | <p>Common Project Features</p> <ul style="list-style-type: none"> Minerals Materials Sale Area Moriah Ranches Seeding Project | <p>Utility Corridors</p> <ul style="list-style-type: none"> Utilities | <p>Proposed Action Project Features</p> <ul style="list-style-type: none"> Proposed Well Site Proposed Water Pipeline/
Distribution Line Proposed Rail Spur Proposed Transmission Line Proposed Electric Distribution Line Proposed Access Road Proposed Substation Site Proposed Power Plant Site | <p>Alternative 1 Project Features</p> <ul style="list-style-type: none"> Proposed Well Site Proposed Water Pipeline/
Distribution Line Proposed Rail Spur Proposed Transmission Line Proposed Electric Distribution Line Proposed Access Road Proposed Substation Site Proposed Power Plant Site |
|--|--|--|---|---|---|---|

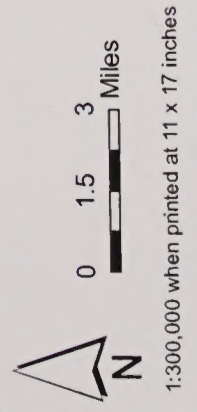
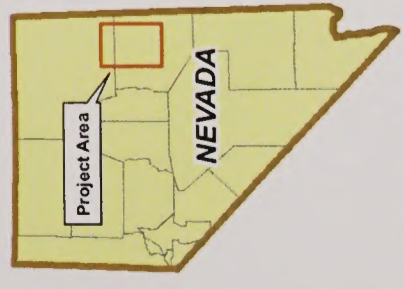

Figure 3.9-2

Management Plan/Final Environmental Impact Statement (BLM, 2007) which will consolidate and update management direction for all BLM-managed lands in the Ely District and replace three separate planning documents (the Egan Resource Management Plan and the Schell and Caliente Management Framework Plans) that have guided management of public lands in the Ely District for over 15 years.

Realty Actions

Sale of BLM Land: Management

Objective. Dispose of lands to provide for more effective management of public lands in the planning area. Land disposals are not in big game or upland game habitat or in wild horse herd use areas. All land disposals would be done in a planned and orderly manner and would not adversely affect threatened or endangered species, destroy or degrade wetlands or riparian areas, or lead to the modification of floodplains.

Sale of BLM Land: Relationship to Proposed Project. In addition to the parcel of land that would be selected for the Proposed Action or Alternative 1 power plant site, other lands in the project area have been identified for disposal.

Utility Corridors: Management

Objective. Identify two existing utility corridors, one running north-south and one running east-west, and designate two other planned corridors, one running north-south and one running east-west. The actual route would be established after environmental analysis is completed for the ROW, and each corridor would be 5 miles wide to provide opportunities for multiple transmission facilities and selection of routes that minimize environmental degradation in a cost-effective manner. Applicants for use of a corridor would be required to locate new facilities proximate to

existing facilities except where considerations of construction feasibility, cost, resource protection, or safety are overriding. Corridors provide for a variety of ROW uses including power lines, pipelines, railroads, and highways. The major use expected in the Resource Management Plan area is related to installation of transmission lines.

Utility Corridors: Relationship to Proposed Project. Most of the length of the transmission lines for the proposed project would be located within the existing SWIP utility corridor (31 of 34 miles for the Proposed Action and 24 of 28.5 miles for Alternative 1).

3.9.2.2 County Land Use Plans and Policies

White Pine County Land Use Plan

The White Pine County Land Use Plan (White Pine County, 1998a) is intended to guide development of land resources in the county through 2017. Sustaining environmental values and promoting expansion and diversification of the regional economy are important goals expressed in the plan. The White Pine County Land Use Plan describes land use issues in the county, as well as in the specific planning areas of Ely, Baker, Lund, McGill, Preston, Ruth, and the Ely-McGill corridor. The plan also provides a number of land use goals and implementation strategies; however, it contains no goals or strategies related specifically to utilities or utility corridors, other than a provision for the efficient use of community infrastructure. In the 2007 update to the White Pine County Public Land Use Plan, the Board of County Commissioners adopted policies to guide potential energy projects in their selection of air emission control technologies, including the use of Best Available Control Technologies (White Pine County, 2007).

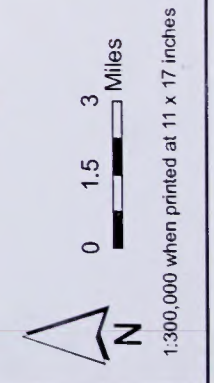
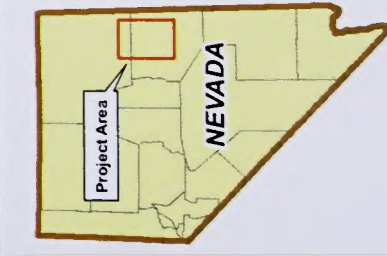
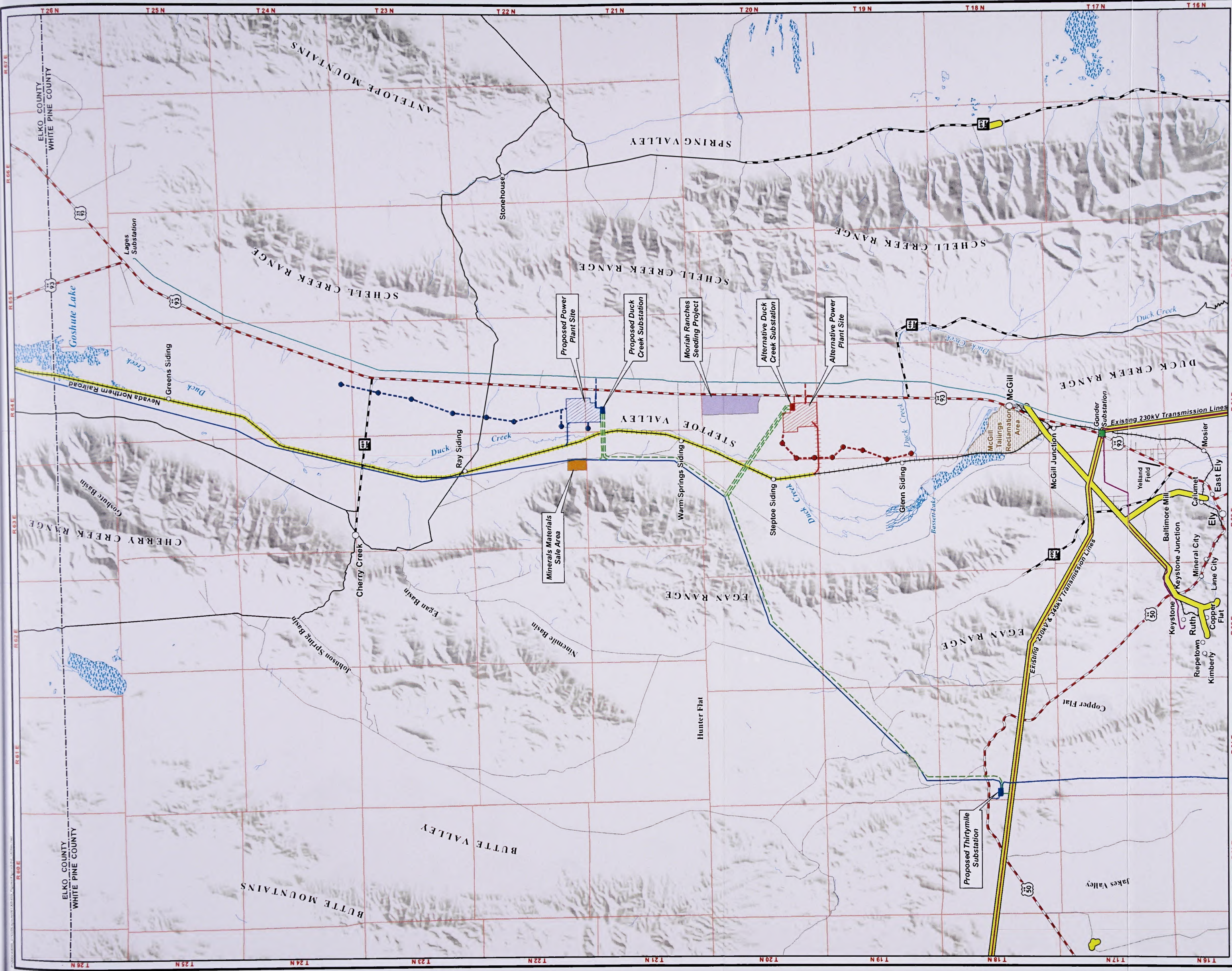

- Existing Electrical Features**
- Existing Substation
 - Existing Transmission Line
 - Existing Distribution Line
- Surface Water**
- Perennial Stream or River
 - Wetland
- Connected Action**
- SWIP Transmission Line
 - NNR Upgrade
- Common Project Features**
- Minerals Materials Sale Area
 - Moriah Ranches
 - Seeding Project

- Utility Corridors**
- Utilities
- Proposed Action Project Features**
- Proposed Well Site
 - Proposed Water Pipeline/Distribution Line
 - Proposed Rail Spur
 - Proposed Transmission Line
 - Proposed Electric Distribution Line
 - Proposed Access Road
 - Proposed Substation Site
 - Proposed Power Plant Site

- Alternative 1 Project Features**
- Proposed Well Site
 - Proposed Water Pipeline/Distribution Line
 - Proposed Rail Spur
 - Proposed Transmission Line
 - Proposed Electric Distribution Line
 - Proposed Access Road
 - Proposed Substation Site
 - Proposed Power Plant Site

**Utilities and Utility Corridors
White Pine Energy Station Project**

Figure 3.9-2

White Pine County has 11 general land use designations: Open Range; Low-, Medium-, and High-Density Residential; Mobile Home; Commercial; Industrial; Public Facility/Recreation; Public Land Transfer; Brownfield; and Federal Reserve. Most land outside of established communities is designated as Open Range or Federal Reserve. The proposed project area lies predominantly within these two land use designations.

Lands within the Open Range designation comprise most of the land in the county and include lands administered by the BLM, as well as those under private ownership. Open Range lands are used primarily for grazing or domestic livestock, although other uses include mining, recreation, and wildlife habitat. The intent of the Open Range designation is to encourage the resource and open space use of the lands. The minimum lot area requirement for Open Range designation is 5 acres. In Steptoe Valley north of McGill, areas have been designated Low-Density Residential with a ranch estates overlay. The intent of these areas is to encourage development of irrigated estate ranches utilizing ground water held by White Pine County. This designation reflects a growing demand for recreational home sites in desirable mountain settings in the county (White Pine County, 1998a).

White Pine County Public Land Use Plan

The White Pine County Public Land Use Plan (White Pine County, 1998b) provides a coordinated land use planning effort among the county, BLM, and Forest Service and is included as an appendix to the White Pine County Land Use Plan. The plan was developed by the White Pine County government to guide the use of federal public lands and resources in the county, and provides a number of policy

statements related to water, minerals, agriculture, recreation, wildlife, transportation, cultural resources, wild horses, forest management, and public lands identified for non-federal ownership. In general, the public land policies encourage mineral exploration, opportunities for livestock grazing, and other agricultural uses; encourage dispersed recreational opportunities; and support a diversity of wildlife species and habitats. Related to access and transportation, the plan encourages route locations for transportation, utilities, and communication corridors to be planned in harmony with other resources on public lands.

The White Pine County Public Land Use Plan applies to public lands designated as Open Range and Federal Reserve in the White Pine County Land Use Plan. No parcels of public land in the project area have been identified as desirable for transfer from the BLM to local government for community expansion purposes, including, but not limited to, roads, trails, or other access points to public and private lands.

3.10 Rangeland Resources

3.10.1 Livestock Grazing

The Taylor Grazing Act of 1934 (the Act) was passed by Congress to help reduce the threat of overgrazing on public lands. The Act regulated grazing on public lands by requiring permits. It provided a way to regulate the occupancy and use of public land and protect it from ruin. The Public Land Law Review Commission was created in 1964 to provide recommendations on how public land should be managed. Their report resulted in the Federal Land Policy and Management Act (FLPMA), enacted by Congress in 1976.

The study area for livestock grazing is a 10-mile radius surrounding the White Pine Energy Station Proposed Action and Alternative 1 project facility sites. The size of the study area is appropriate for rangeland resources given the general range of animal movements and includes the power plant site, transmission line alignment, well field and water line ROW, and access roads ROW. The cumulative effects analysis area involves the public and private lands crossed by potential power transmission line and water pipeline routes, substations, and rail line. The cumulative effects analysis area includes all affected allotments.

Sixty-three grazing allotments exist in the BLM's Ely District. Lands in the project area are primarily used for grazing. As shown in Table 3.10-1, the area includes a number of grazing allotments on federal lands. These allotments are open rangelands that have the potential to be used periodically for grazing. Allotments are grazed at different times of the year and at various intensities. Figure 3.10-1 shows the location of the various grazing

allotments in relation to the Station Proposed Action and Alternative 1 project facility sites.

3.10.2 Wild Horses

On December 15, 1971, Congress enacted the Wild and Free-Roaming Horse and Burro Act, authorizing the BLM to manage wild horses and burros on public lands and mandating that wild and free-roaming horses and burros be protected from unauthorized capture, branding, harassment, or death. Those areas of public land that were used as habitat for wild horses and burros in 1971 were delineated as Herd Areas (HAs). Upon evaluation of the HAs, 13 Herd Management Areas (HMAs) were designated within the Ely Field Office District. The BLM's policy is to protect, manage, and control wild horses and burros on public lands.

The study area and cumulative effects analysis area for wild horses is the same as defined above for livestock grazing in Section 3.10.1, *Livestock Grazing*.

Figure 3.10-2 shows the HMAs within the study area. The Butte and Antelope HMAs would be crossed by the proposed transmission line and water supply line, respectively. Wild horses are present, but no wild burros have been recorded in either HMA.

3.10.2.1 Butte HMA

The Butte HMA is approximately 30 miles north-northwest of Ely, 3 miles west of the Proposed Action power plant site, and 6 miles west of the Alternative 1 power plant site. The Butte HMA encompasses approximately 430,770 acres (673 square miles), 99.3 percent of which are public lands.

TABLE 3.10-1

Grazing Allotments in the Study Area*

Name	Size (acres)	Name	Size (acres)
Badger Spring	28,240	McDermitt Creek	2,703
Bassett Creek	9,091	Meadow Creek	9,330
Becky Creek	14,086	Medicine Butte	310,965
Becky Springs	44,766	Middle Steptoe	3,696
Bennett Creek	1,509	Moorman Ranch	66,946
Berry Creek	18,175	Muncy Creek	53,253
Big Indian Creek	6,417	Negro Creek	90
Big Rock Seeding	6,957	North Butte	27,896
Boneyard Cu	8,444	North Steptoe	15,606
Butte Seeding	1,522	Piermont	21,076
Cherry Creek	166,219	Queen Springs Cu	9,890
Chin Creek	50,230	Red Hills	28,202
Cleve Creek	16,698	Ruby Mattier	11,221
Cleveland Ranch	7,583	Sampson Creek	13,645
Copper Flat	41,308	Schellbourne	17,986
Duck Creek Cu	9,256	Schoolhouse Spring	6,656
Duckcreek	12,664	Second Creek	17,236
Duckcreek Basin	10,605	Seigel Creek Cu	11,689
Duckcreek Flat	37,334	South Butte	27,829
Fitzhugh	10,407	South Butte Seeding	981
Gallagher Gap	3,899	Stephens Creek	4,380
Georgetown Ranch	29,455	Steptoe	58,120
Gilford Meadows	5,608	Taft Creek	34,778
Goat Ranch	6,074	Thirty Mile Spring	188,865
Gold Canyon	23,673	Timber Creek	34,795
Goshute Basin	9,911	Tippett	68,917
Heusser Mountain	41,714	Tippett Pass	33,433
Horse Haven	22,438	Tom Plain	33,864
Indian Creek	3,316	Warm Springs	64,122
Indian Jake	5,089	West Schell Bench	37,133
Lovell Peak	2,418	Whiteman Creek	5,897
McCoy Creek	20,037		
		Total	2,229,573

* Study area is a 10-mile radius around the Station Proposed Action and Alternative 1 facility sites.
Source: GIS data provided by BLM Elko, Nevada Field Office, March 1, 2005



Grazing Allotments White Pine Energy Station Project

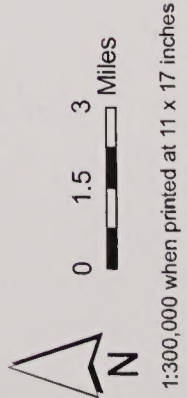
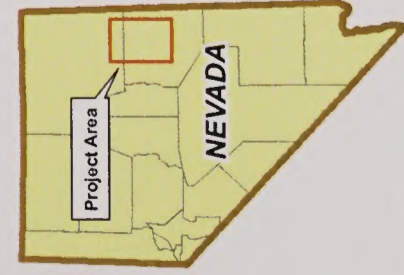

- Existing Electrical Features**
 - Existing Substation
 - Existing Transmission Line
 - Existing Distribution Line
- Surface Water**
 - Perennial Stream or River
 - Wetland
- Connected Action**
 - SWIP Transmission Line
 - NNR Upgrade
- Common Project Features**
 - Minerals Materials Sale Area
 - Moriah Ranches Seeding Project

- Grazing Allotment**
 - Grazing Allotment
- Proposed Action Project Features**
 - Proposed Well Site
 - Proposed Water Pipeline/Distribution Line
 - Proposed Rail Spur
 - Proposed Transmission Line
 - Proposed Electric Distribution Line
 - Proposed Access Road
 - Proposed Substation Site
 - Proposed Power Plant Site

- Alternative 1 Project Features**
 - Proposed Well Site
 - Proposed Water Pipeline/Distribution Line
 - Proposed Rail Spur
 - Proposed Transmission Line
 - Proposed Electric Distribution Line
 - Proposed Access Road
 - Proposed Substation Site
 - Proposed Power Plant Site

Figure 3.10-1

TABLE 3.10-1

Grazing Allotments in the Study Area*

Name	Size (acres)	Name	Size (acres)
Badger Spring	28,240	McDermitt Creek	2,703
Bassett Creek	9,091	Meadow Creek	9,330
Becky Creek	14,086	Medicine Butte	310,965
Becky Springs	44,766	Middle Steptoe	3,696
Bennett Creek	1,509	Moorman Ranch	66,946
Berry Creek	18,175	Muncy Creek	53,253
Big Indian Creek	6,417	Negro Creek	90
Big Rock Seeding	6,957	North Butte	27,896
Boneyard Cu	8,444	North Steptoe	15,606
Butte Seeding	1,522	Piermont	21,076
Cherry Creek	166,219	Queen Springs Cu	9,890
Chin Creek	50,230	Red Hills	28,202
Cleve Creek	16,698	Ruby Mattier	11,221
Cleveland Ranch	7,583	Sampson Creek	13,645
Copper Flat	41,308	Schellbourne	17,986
Duck Creek Cu	9,256	Schoolhouse Spring	6,656
Duckcreek	12,664	Second Creek	17,236
Duckcreek Basin	10,605	Seigel Creek Cu	11,689
Duckcreek Flat	37,334	South Butte	27,829
Fitzhugh	10,407	South Butte Seeding	981
Gallagher Gap	3,899	Stephens Creek	4,380
Georgetown Ranch	29,455	Steptoe	58,120
Gilford Meadows	5,608	Taft Creek	34,778
Goat Ranch	6,074	Thirty Mile Spring	188,865
Gold Canyon	23,673	Timber Creek	34,795
Goshute Basin	9,911	Tippett	68,917
Heusser Mountain	41,714	Tippett Pass	33,433
Horse Haven	22,438	Tom Plain	33,864
Indian Creek	3,316	Warm Springs	64,122
Indian Jake	5,089	West Schell Bench	37,133
Lovell Peak	2,418	Whiteman Creek	5,897
McCoy Creek	20,037		
		Total	2,229,573

* Study area is a 10-mile radius around the Station Proposed Action and Alternative 1 facility sites.
Source: GIS data provided by BLM Elko, Nevada Field Office, March 1, 2005

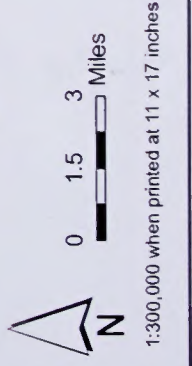
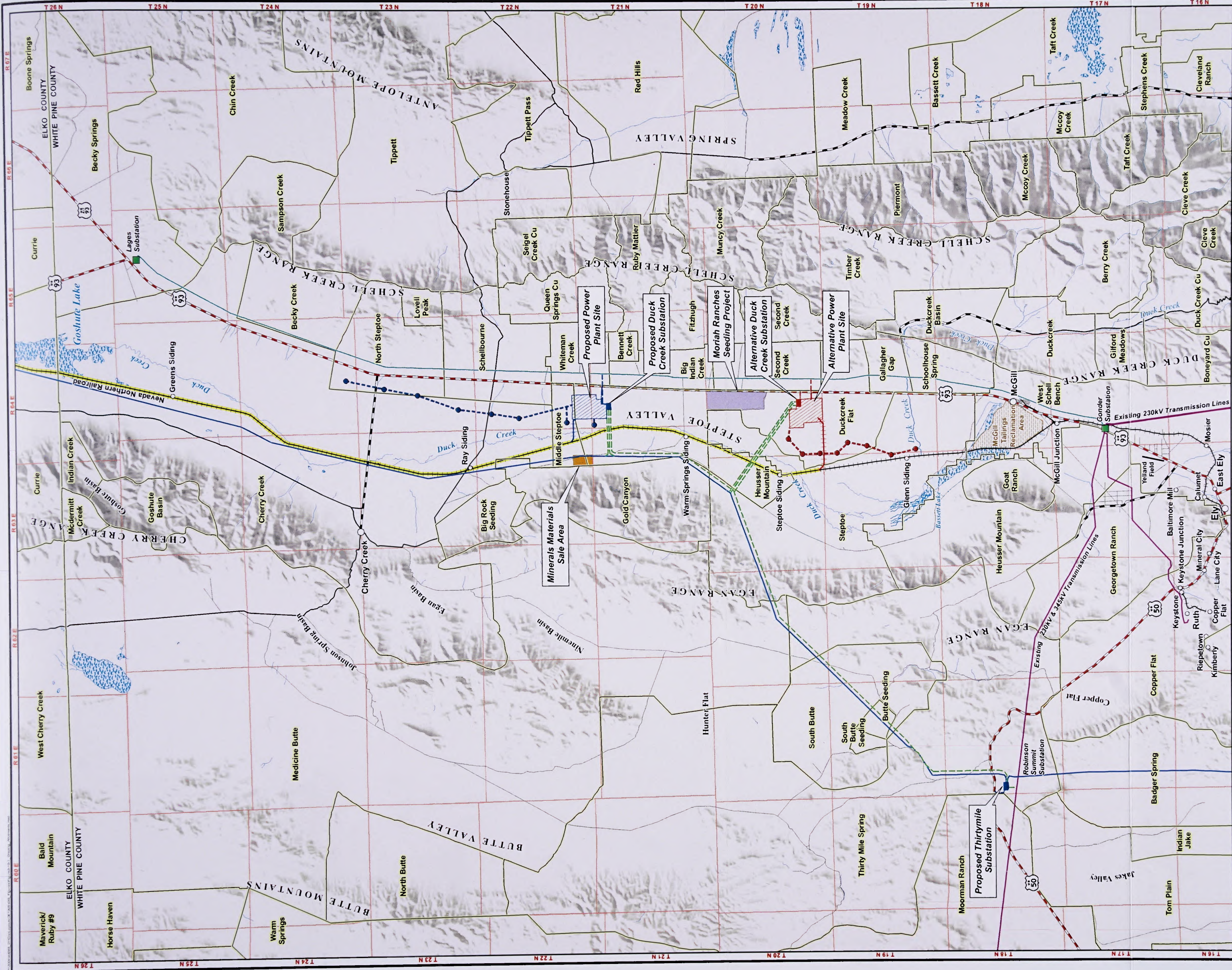

- Existing Electrical Features**
- Existing Substation
 - Existing Transmission Line
 - Existing Distribution Line
- Surface Water**
- Perennial Stream or River
 - Wetland
- Connected Action**
- SWIP Transmission Line
 - NNR Upgrade
- Common Project Features**
- Minerals Materials Sale Area
 - Moriah Ranches
 - Seeding Project

- Grazing Allotment**
- Grazing Allotment
- Proposed Action Project Features**
- Proposed Well Site
 - Proposed Water Pipeline/Distribution Line
 - Proposed Rail Spur
 - Proposed Transmission Line
 - Proposed Electric Distribution Line
 - Proposed Access Road
 - Proposed Substation Site
 - Proposed Power Plant Site

- Alternative 1 Project Features**
- Proposed Well Site
 - Proposed Water Pipeline/Distribution Line
 - Proposed Rail Spur
 - Proposed Transmission Line
 - Proposed Electric Distribution Line
 - Proposed Access Road
 - Proposed Substation Site
 - Proposed Power Plant Site

Grazing Allotments
White Pine Energy Station Project

Figure 3.10-1

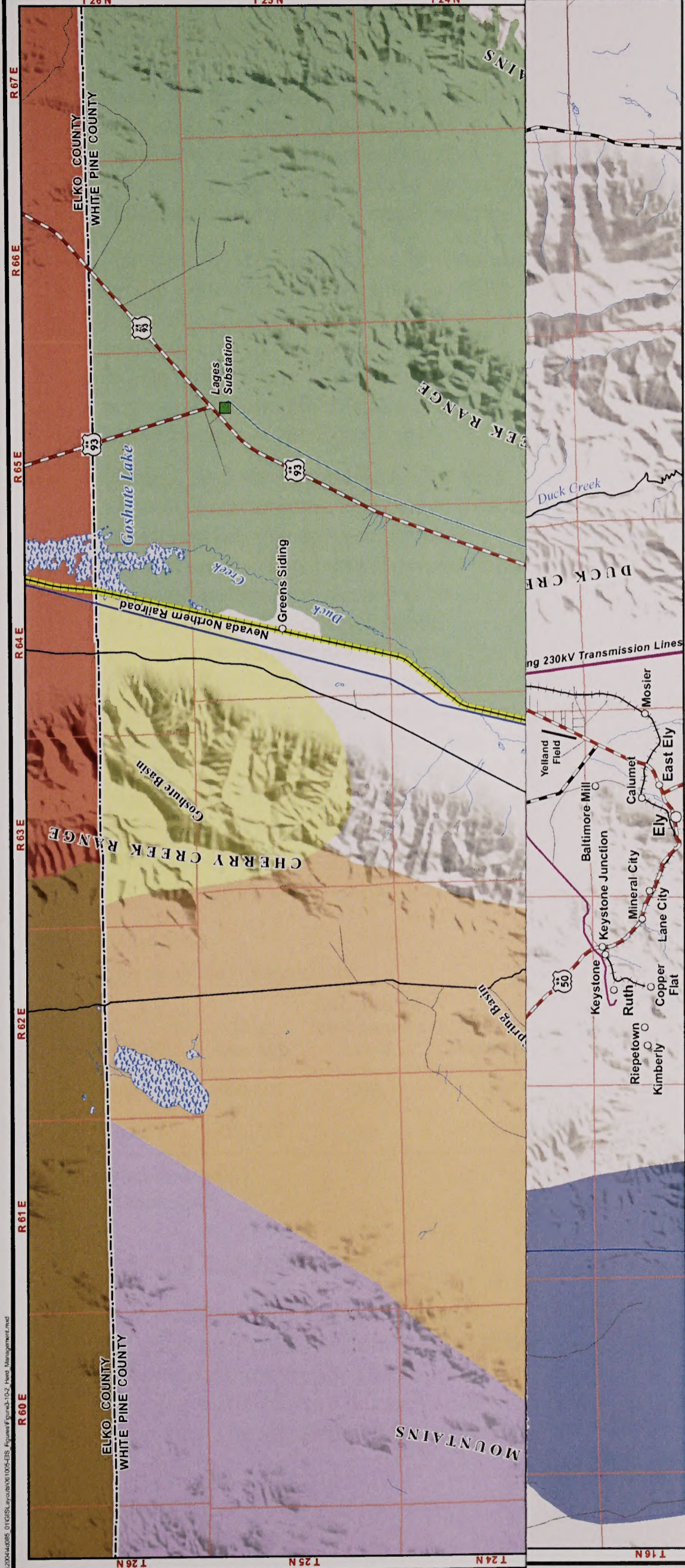

Herd Management Areas White Pine Energy Station Project

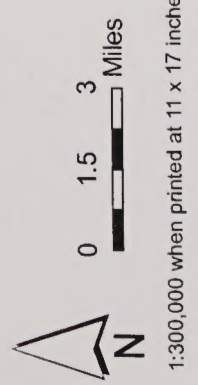
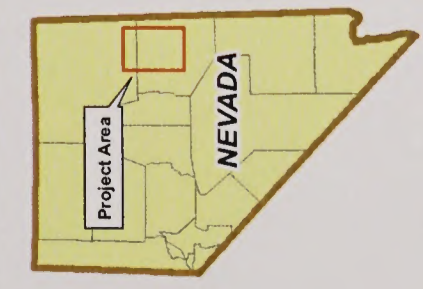

- Existing Electrical Features**
 - Existing Substation
 - Existing Transmission Line
 - Existing Distribution Line
- Surface Water**
 - Perennial Stream or River
 - Wetland
- Connected Action**
 - SWIP Transmission Line
 - NNR Upgrade
- Common Project Features**
 - Minerals Materials Sale Area
 - Moriah Ranches
 - Seeding Project

- Proposed Action Project Features**
 - Proposed Well Site
 - Proposed Water Pipeline/Distribution Line
 - Proposed Rail Spur
 - Proposed Transmission Line
 - Proposed Electric Distribution Line
 - Proposed Access Road
 - Proposed Substation Site
 - Proposed Power Plant Site

- Alternative 1 Project Features**
 - Proposed Well Site
 - Proposed Water Pipeline/Distribution Line
 - Proposed Rail Spur
 - Proposed Transmission Line
 - Proposed Electric Distribution Line
 - Proposed Access Road
 - Proposed Substation Site
 - Proposed Power Plant Site

- Herd Management Areas**
 - Antelope
 - Buck and Bald
 - Butte
 - Cherry Creek
 - Jakes Wash
 - Antelope Valley
 - Maverick-Medicine

Figure 3.10-2

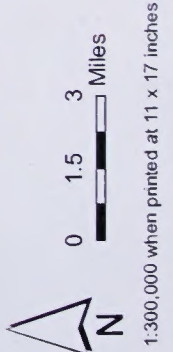
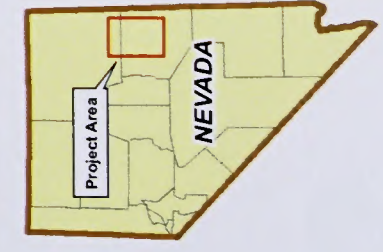
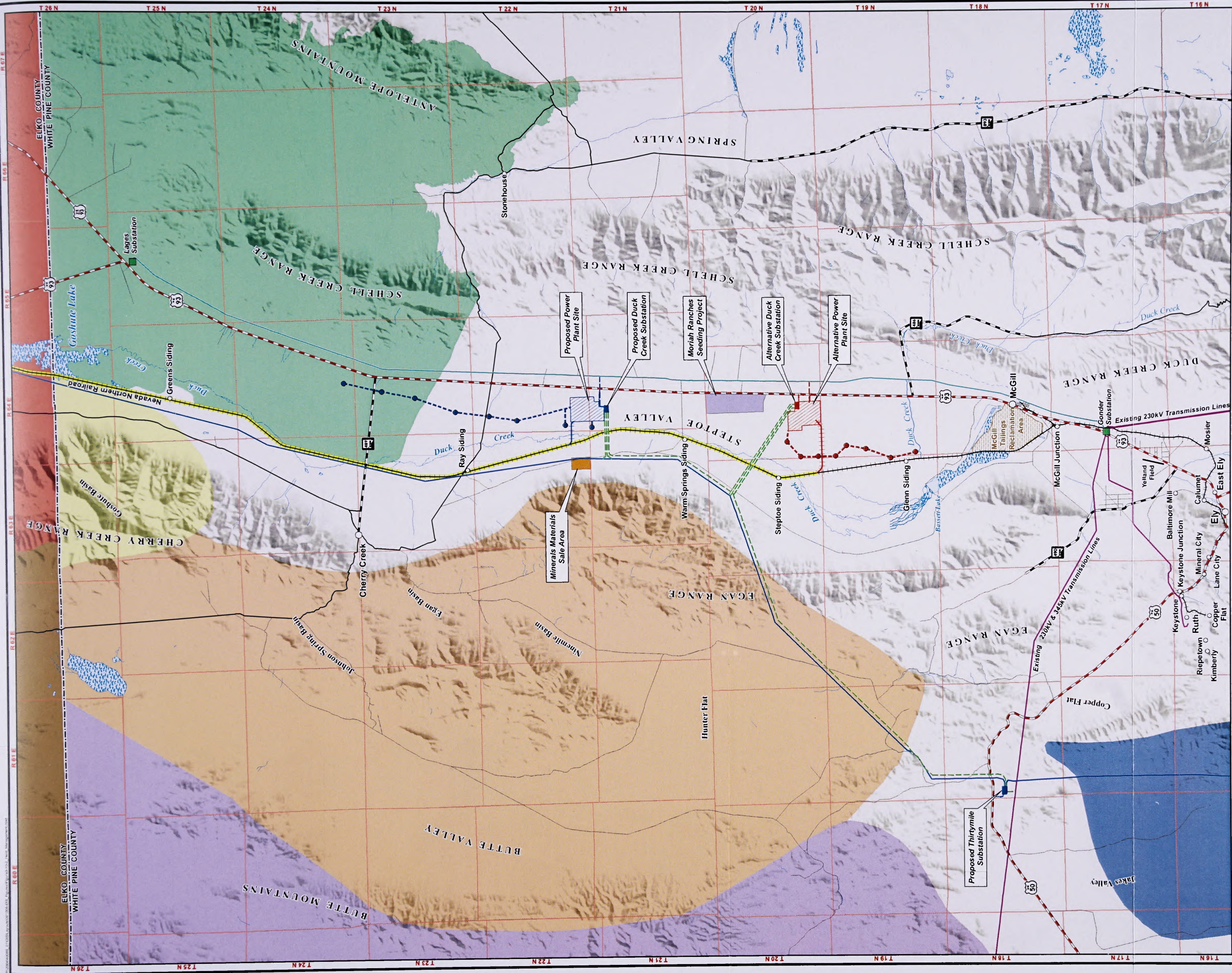

Existing Electrical Features

- Existing Substation
- Existing Transmission Line
- Existing Distribution Line

Surface Water

- Perennial Stream or River
- Wetland

Connected Action

- SWIP Transmission Line
- NNR Upgrade

Common Project Features

- Minerals Materials Sale Area
- Moriah Ranches
- Seeding Project

Proposed Action Project Features

- Proposed Well Site
- Proposed Water Pipeline/Distribution Line
- Proposed Rail Spur
- Proposed Transmission Line
- Proposed Electric Distribution Line
- Proposed Access Road
- Proposed Substation Site
- Proposed Power Plant Site

Alternative 1 Project Features

- Proposed Well Site
- Proposed Water Pipeline/Distribution Line
- Proposed Rail Spur
- Proposed Transmission Line
- Proposed Electric Distribution Line
- Proposed Access Road
- Proposed Substation Site
- Proposed Power Plant Site

Herd Management Areas
White Pine Energy Station Project

- Antelope
- Buck and Bald
- Butte
- Cherry Creek
- Jakes Wash
- Antelope Valley
- Maverick-Medicine

Figure 3.10-2

Access to the Butte HMA is provided only over dirt roads and trails. The only significant human settlements in the vicinity are Ely and McGill. Other human settlements include a few small ranches.

The Butte HMA is a large valley bounded on the east, south, and west by the Butte, Egan, and Cherry Creek mountain ranges, respectively, and on the north by the White Pine County line. The southeastern edge of the Butte HMA extends to the eastern bench of the Egan Range.

Table 3.10-2 shows the HMAs and their various characteristics. The Butte HMA has an appropriate management level of 95 wild horses. This number is based on a series of multiple-use decisions between 1991 and 2001 indicating that the approximate number of wild horses that could be sustained in the area without interrupting the balance of the ecosystem. The population as of March 2005 was 124 (Bybee, 2005). The wild horses tend to gather in the higher elevations in summer and lower elevations in winter and are rarely observed in the southern section of the Butte HMA (Bybee, 2005).

TABLE 3.10-2
Wild Horse HMA Characteristics

HMA	Size (Acres)	Appropriate Management Level	Current Population
Antelope	400,205	324	160 ^a
Butte	430,770	95	124 ^b

^aFebruary 2005

^bMarch 2005

3.10.2.2 Antelope HMA

The Antelope HMA is approximately 42 miles north of Ely, 9 miles north of the Proposed Action power plant site, and 20 miles north of the Alternative 1 power plant site. The Antelope HMA comprises

approximately 400,205 acres (625 square miles), 98 percent of which are public lands. Access to the Antelope HMA is provided by U.S. 93 and various state highways, dirt roads, and trails. The only significant human settlement in the vicinity is the community of Cherry Creek. Other human settlements include a few small ranches.

The Antelope HMA spans Steptoe Valley and Spring Valley. Steptoe Valley is the only section of the HMA that would be affected by the Proposed Action water supply line. The Antelope HMA is bounded on the west by the NNR. SR 893 runs just south of the HMA's southern border. The White Pine County line forms the eastern and northern borders. The mountain ranges in the Antelope HMA are the Schell Creek Range and Antelope Mountains. A fence runs the length of U.S. 93 through the Antelope HMA. This fence prohibits horses from entering the area where the Proposed Action water supply line would be constructed.

The Antelope HMA has an appropriate management level of 324 wild horses (see Table 3.10-2). This number is based on a series of multiple use decisions between 1991 and 2001 that indicated the approximate number of wild horses that could be sustained in the area without interrupting the balance of the ecosystem. The population as of February 2005 was 160 (see Table 3.10-2) (Bybee, 2005). The wild horses tend to gather in the higher elevations in summer and lower elevations in winter (Bybee, 2005).

3.11 Special Designations

This section describes resources comprising Wilderness, ACECs, and National Historic Trails in the analysis area. As part of the analysis for the proposed White Pine Energy Station, several issues were examined in relation to these types of resource area. Four of these issues were identified to have the potential for impacts. The first issue includes a determination of conflicts that may arise because of construction-related truck traffic on existing roads used to access these resource areas. The second issue examines potential conflicts between the White Pine Energy Station alternatives and relevant federal, state, or local management plans and policies. The third issue is a determination of impacts occurring to the resource areas because of access roads that would be constructed. The fourth issue is an analysis of potential impacts on access and visitation rates to the resource areas because of the proposed Station.

The analysis involved a review of related county, state, and federal land use plans as well as other land records. The analysis area for this set of resources is a 50-mile radius around the White Pine Energy Station Proposed Action and Alternative 1 facility sites.

3.11.1 Wilderness Areas

The Wilderness Act of 1964 established the National Wilderness Preservation System, which is comprised of public and “other federal lands designated by congress as Wilderness Areas.”

Wilderness is defined as a place where “...the earth and its community of life are untrammelled by man, where man himself is a visitor who does not remain.”

Wilderness is further defined to mean “...an area of undeveloped federal land retaining its primeval character and influence, without permanent improvements or human habitation, which is protected and managed as to preserve its natural conditions.” Designation is meant to ensure that the land is preserved and protected in its natural condition.

The White Pine County Conservation, Recreation and Development Act of 2006 (Public Law 109-432) was passed by Congress on December 20, 2006. This bill provides for 538,000 acres of Wilderness through the establishment of 12 new areas and the expansion of two existing areas (see Figure 3.11-1). Along with creating Wilderness, the bill allows the BLM to sell up to 45,000 acres consistent with its resource management plan.

Within the project study area there are four Wilderness areas (see Table 3.11-1). Goshute Canyon Wilderness is located in the Cherry Creek Mountains in northern White Pine County within the project area. Goshute Canyon Wilderness comprises approximately 42,544 acres of BLM managed land. Bristlecone Wilderness is located in the Egan Range within the project area, approximately three miles west of McGill. Bristlecone Wilderness comprises approximately 14,095 acres of BLM managed land. Becky Peak Wilderness is located in the Schell Creek Range in northern White Pine County within the project area. Becky Peak comprises approximately 18,119 acres of BLM managed land. High Schells Wilderness is located in the Schell Creek Range within the project area, approximately 3 miles east of McGill. High Schells Wilderness comprises approximately 121,497 acres of USFS managed land.

TABLE 3.11-1

Wilderness in the Project Area

Land Manager	Name	Size
BLM	Goshute Canyon	42,544 acres
BLM	Bristlecone	14,095 acres
BLM	Becky Peak	18,119 acres
USFS	High Schells	121,497 acres

Source: HR 6111; EDAW GIS 2006.

In addition to the High Schells Wilderness depicted in Figure 3.11-1, the Schell Creek Range north of the Wilderness contains four Inventoried Roadless Areas. These include the West Schell (18-04) and North Schell (18-03) Inventoried Roadless Areas located to the northwest and north, respectively, of the Schell Creek Wilderness, and the Tehama Creek (18-02) and McCurdy (18-01) Inventoried Roadless Areas, which are located in the northern extent of the Schell Creek Range.

3.11.2 Areas of Critical Environmental Concern

The FLPMA requires that priority be given to the designation and protection of ACECs. An ACEC designation is the principal BLM designation for public lands where special management is required to protect important natural, cultural, and scenic resources, or to identify natural hazards. No ACECs exist within 50 miles of the Station project area.

3.11.3 National Historic Trails

The Pony Express National Historic Trail (see Figure 3.8-1) was established as a National Historic Trail by Congress in 1992. The Pony Express route was established in 1860 to transport mail from Missouri to California and within Nevada. The trail symbolizes American's rapid expansion to the Pacific (National Park Service, 2005). The Pony Express National Historic Trail runs approximately east-west through the BLM Ely District in the analysis area. The Pony Express National Historic Trail enters Steptoe Valley via Egan Canyon. The trail is administered by the National Trails System, Salt Lake City, Utah, office, but responsibility for management of the trail lies in the hands of current trail managers at the federal, state, local, and private levels. The Pony Express Trail is located almost entirely on BLM managed lands in the project area.

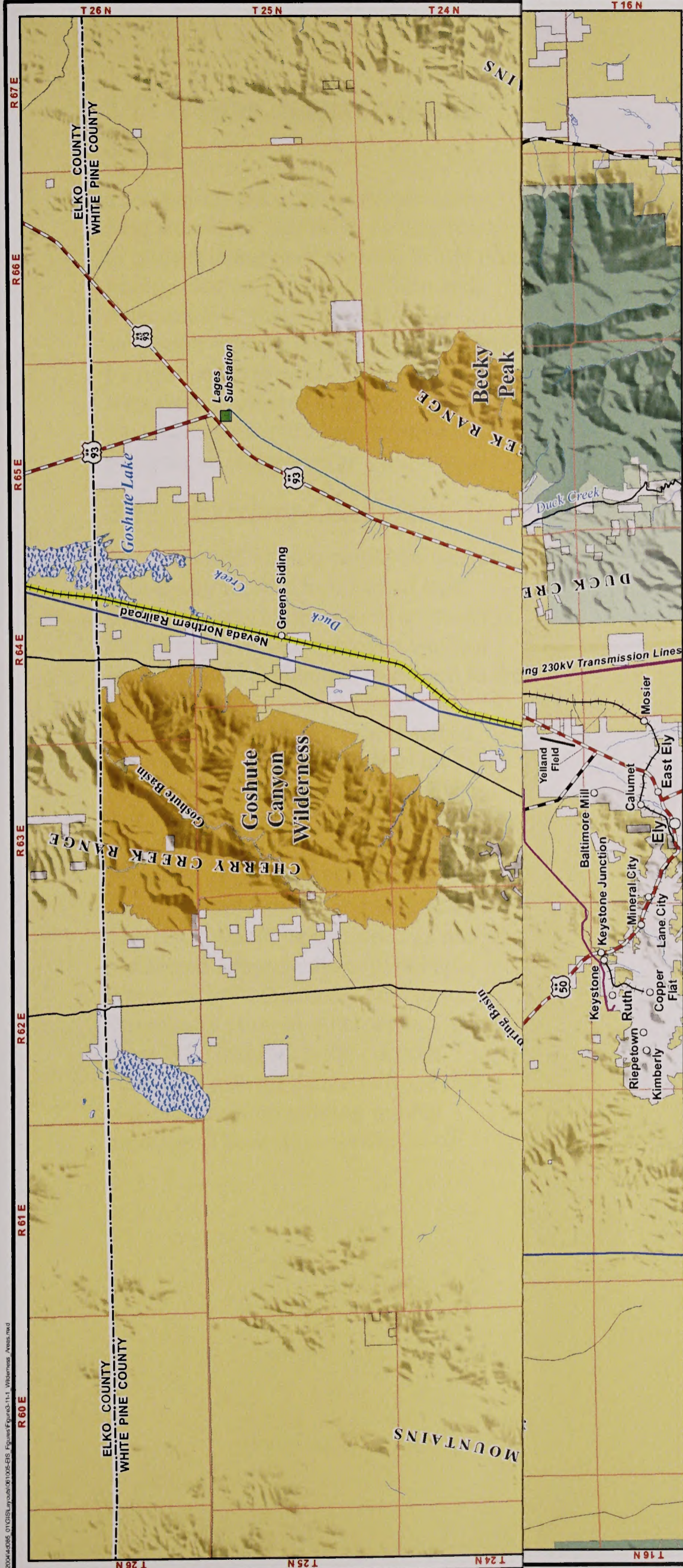

Wilderness Areas in the Project Area White Pine Energy Station Project

Existing Electrical Features

- Existing Substation
- Existing Transmission Line
- Existing Distribution Line

Surface Water

- Perennial Stream or River
- Wetland

Connected Action

- SWIP Transmission Line
- NNR Upgrade

Common Project Features

- Minerals Materials Sale Area
- Moriah Ranches
- Seeding Project

Proposed Action Project Features

- Proposed Well Site
- Proposed Water Pipeline/Distribution Line
- Proposed Rail Spur
- Proposed Transmission Line
- Proposed Electric Distribution Line
- Proposed Access Road
- Proposed Substation Site
- Proposed Power Plant Site

Alternative 1 Project Features

- Proposed Well Site
- Proposed Water Pipeline/Distribution Line
- Proposed Rail Spur
- Proposed Transmission Line
- Proposed Electric Distribution Line
- Proposed Access Road
- Proposed Substation Site
- Proposed Power Plant Site

Jurisdiction

- Bureau of Land Management
- BLM Wilderness Area
- US Forest Service
- USFS Wilderness Area
- Private

0 1.5 3 Miles

1:300,000 when printed at 11 x 17 inches

Figure 3.11-1

TABLE 3.11-1

Wilderness in the Project Area

Land Manager	Name	Size
BLM	Goshute Canyon	42,544 acres
BLM	Bristlecone	14,095 acres
BLM	Becky Peak	18,119 acres
USFS	High Schells	121,497 acres

Source: HR 6111; EDAW GIS 2006.

In addition to the High Schells Wilderness depicted in Figure 3.11-1, the Schell Creek Range north of the Wilderness contains four Inventoried Roadless Areas. These include the West Schell (18-04) and North Schell (18-03) Inventoried Roadless Areas located to the northwest and north, respectively, of the Schell Creek Wilderness, and the Tehama Creek (18-02) and McCurdy (18-01) Inventoried Roadless Areas, which are located in the northern extent of the Schell Creek Range.

3.11.2 Areas of Critical Environmental Concern

The FLPMA requires that priority be given to the designation and protection of ACECs. An ACEC designation is the principal BLM designation for public lands where special management is required to protect important natural, cultural, and scenic resources, or to identify natural hazards. No ACECs exist within 50 miles of the Station project area.

3.11.3 National Historic Trails

The Pony Express National Historic Trail (see Figure 3.8-1) was established as a National Historic Trail by Congress in 1992. The Pony Express route was established in 1860 to transport mail from Missouri to California and within Nevada. The trail symbolizes American's rapid expansion to the Pacific (National Park Service, 2005). The Pony Express National Historic Trail runs approximately east-west through the BLM Ely District in the analysis area. The Pony Express National Historic Trail enters Steptoe Valley via Egan Canyon. The trail is administered by the National Trails System, Salt Lake City, Utah, office, but responsibility for management of the trail lies in the hands of current trail managers at the federal, state, local, and private levels. The Pony Express Trail is located almost entirely on BLM managed lands in the project area.

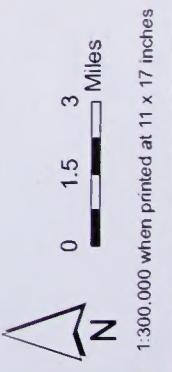
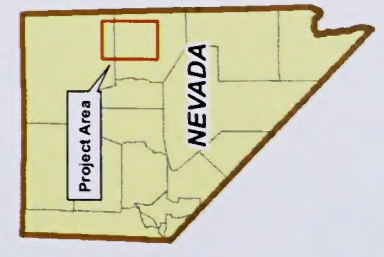
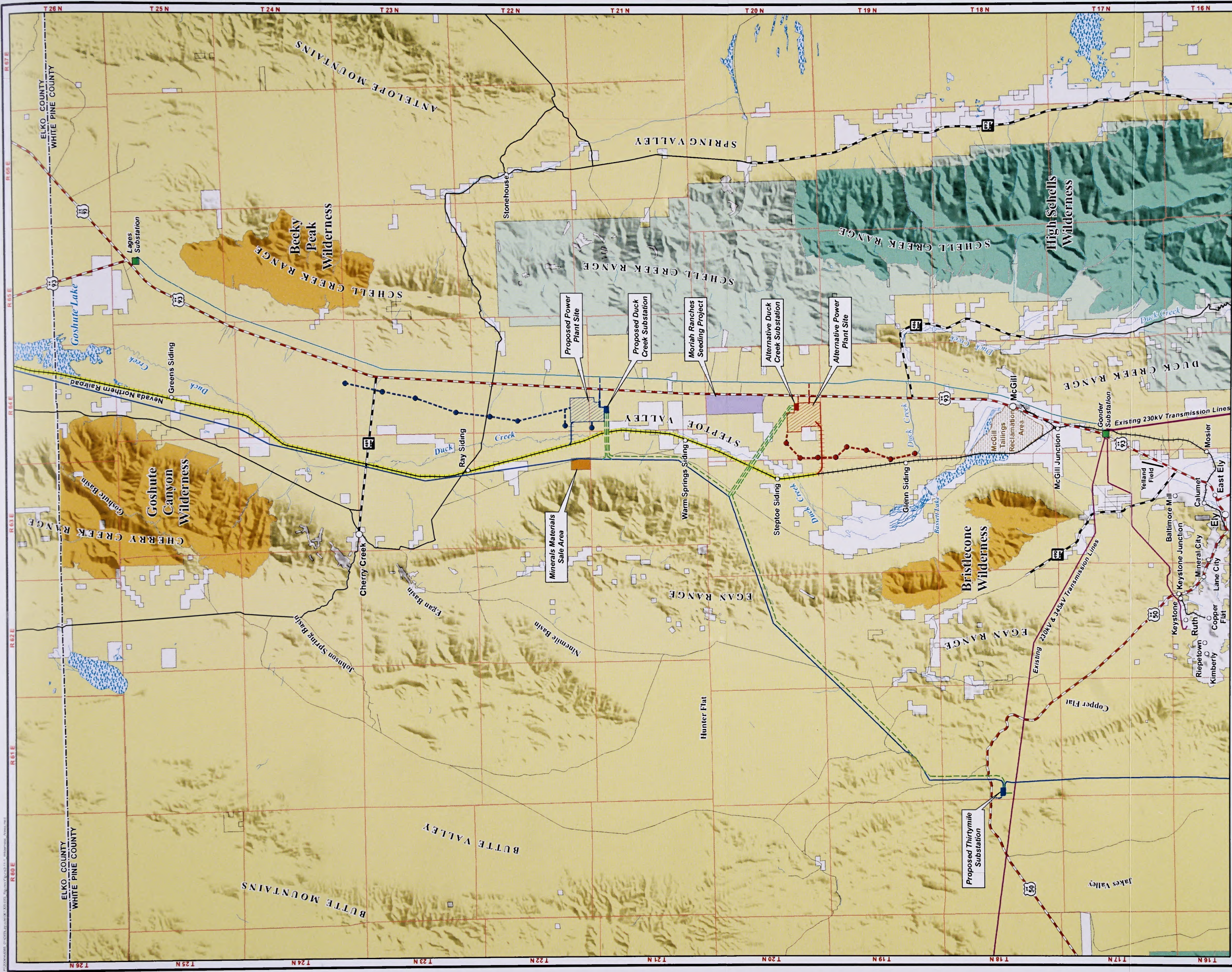

Existing Electrical Features

- Existing Substation
- Existing Transmission Line
- Existing Distribution Line

Surface Water

- Perennial Stream or River
- Wetland

Connected Action

- SWIP Transmission Line
- NNR Upgrade

Common Project Features

- Minerals Materials Sale Area
- Moriah Ranches
- Seeding Project

Proposed Action Project Features

- Proposed Well Site
- Proposed Water Pipeline/Distribution Line
- Proposed Rail Spur
- Proposed Transmission Line
- Proposed Electric Distribution Line
- Proposed Access Road
- Proposed Substation Site
- Proposed Power Plant Site

Wilderness Areas in the Project Area

White Pine Energy Station Project

Alternative 1 Project Features

- Proposed Well Site
- Proposed Water Pipeline/Distribution Line
- Proposed Rail Spur
- Proposed Transmission Line
- Proposed Electric Distribution Line
- Proposed Access Road
- Proposed Substation Site
- Proposed Power Plant Site

Jurisdiction

- Bureau of Land Management
- BLM Wilderness Area
- US Forest Service
- USFS Wilderness Area
- Private

Figure 3.11-1

3.12 Wastes, Hazardous and Solid

This section discusses existing wastes, both hazardous and solid, as they relate to project feature sites for the White Pine Energy Station Proposed Action and Alternative 1. Sites with known or suspected waste releases may be affected by a proposed project. Therefore, project sites were evaluated to assess environmental conditions relative to the presence of hazardous or solid wastes.

3.12.1 Existing Conditions

The proposed Station would be located entirely on BLM-administered land, except for approximately 80 acres within the Alternative 1 power plant site that were recently designated (pursuant to the White Pine County Conservation, Recreation and Development Act of 2006 [Public Law 109-432] as lands to be held in trust for the Ely Shoshone Tribe). This general area is very sparsely populated. Station feature sites for the Proposed Action and Alternative 1 are currently uninhabited and undeveloped. The NNR would be upgraded as part of a connected action and a new rail spur would be built to convey coal to the Proposed Action or Alternative 1 power plant. The original NNR corridor contained a small gauge railroad that was used for transporting mining products. There is low potential of

hazardous materials impacts from this historic use. The transmission line ROW for the Station Proposed Action and Alternative 1 would intersect several dirt roads and cross over the Egan Range. The transmission line ROW, as well as the water supply wellfield and pipeline, would be located on BLM land. Although the existence of hazardous materials along these proposed alignments is possible, development within these areas is limited and is not expected to have generated a substantial presence of hazardous materials within the alignments. No historic solid hazardous waste sites were identified in the project area. No hazardous or solid wastes are currently generated within the proposed project feature boundaries.

3.12.2 Regulatory Framework

Use, storage, and disposal of hazardous materials are regulated by numerous local, state, and federal laws. The U.S. Department of Transportation regulates the transport of hazardous substances. Table 3.12-1 summarizes applicable regulations for hazardous materials with which the proposed Station must be in compliance. White Pine County's 2006 Solid Waste Management Plan Revision was approved by the Nevada Division of Environmental Protection (NDEP) in September 2006. White Pine County's Solid Waste Landfill Management Plan, which was approved in 2006, considers the White Pine Energy Station.

TABLE 3.12-1

Summary of Applicable Regulations and/or Administering Agencies for Hazardous Materials

Regulation and/or Administering Agency	Relevance
U.S. Department of Transportation	Regulates the transport of hazardous substances
Resource Conservation and Recovery Action (RCRA), U.S. Environmental Protection Agency (EPA), 42 USC 321 et seq.	Regulates the use and disposal of hazardous wastes
Toxic Substance Control Act, EPA, 15 USC 2601 et seq.	Regulates the production, use, sale, and other distribution of potentially hazardous chemicals including polychlorinated biphenyls (PCBs)
Comprehensive Environmental Response, Compensation, and Liability Act and the Superfund Amendments and Reauthorization Act, EPA, 42 USC 9601 et seq.	Provides liability requirements for contaminated sites as well as use and spill notification requirements
Emergency Planning and Community Right-to-Know Act, EPA, 42 USC 11011 et seq.	Requires certain manufacturing facilities to file annual reports with the EPA that identify their use and release of one or more listed toxic chemicals and provides for a network of state and local emergency planning committees to facilitate planning of emergency response plans
Clean Water Act, EPA, 33 USC 1251 et seq.	Enforcement of discharge limitations through the National Pollutant Discharge Elimination System (NPDES)
Clean Air Act, EPA, 42 USC 7401 et seq.	Comprises several coordinated programs that address air pollution and sources

3.13 Cultural Resources

The following discussion provides an overview of the cultural resources that have been identified and can be expected to be found associated with each of the Station components that may be directly or indirectly impacted by the Proposed Action and Alternative 1. Potential impacts are discussed in Section 4.13, *Cultural Resources*.

3.13.1 Resource Definition

A cultural resource is any defined location of past human activity, occupation, or use, identifiable through field investigation, historical documentation, or oral histories. Cultural resources include archaeological, historic, or architectural sites, structures, places, objects, and artifacts (BLM, 1999). Cultural resources in the Station project area are divided into three groups: prehistoric archaeological resources; historic archaeological and architectural resources; and Traditional Cultural Properties (TCPs). Historic properties are those historic or prehistoric cultural resources or TCPs, which have been determined through consultation with the Nevada State Historic Preservation Office (SHPO) and advisory council to be eligible for inclusion in the National Register of Historic Places (NRHP).

3.13.2 Analysis Area and Methodology

A Cultural Resources Programmatic Agreement outlining the methods of identification and treatment was drafted and approved by LS Power Associates, the BLM Ely District, and the Nevada SHPO (March 2006) (see Appendix O, *Programmatic Agreement*). In accordance with the Programmatic Agreement, an area of potential effect (APE) was established for assessing the potential direct and indirect effects of the Station Proposed Action and Alternative 1. The APE for the

assessment of direct effects consisted of all Station components associated with the Proposed Action and Alternative 1. These were described in detail in Chapter 2.

A Class III inventory was conducted within the majority of the footprint for each of the Station components, with the following exception. The proposed 500-foot-wide corridors for the 500-kV transmission line that would connect the Proposed Action and Alternative 1 Duck Creek Substation to the SWIP were subjected to a Class I level of analysis. This analysis also included a predictive model of cultural resource sensitivity within the transmission line ROWs based on the BLM cultural resource predictive model. The potential indirect visual effect of Station features on the viewshed from historic resources also was assessed.

3.13.3 Regulatory Framework

Historical and archaeological resources are managed under an intricate system of federal laws, some of which have resulted in comprehensive plans or management strategies. Those that pertain specifically to historic and archaeological resources and the Station are described in detail in Appendix P, *Cultural Resources Background Information* (see *Regulatory Framework*) and are as follows:

- Historic Sites Act of 1935 (16 USC 461-467)
- National Environmental Policy Act (NEPA) of 1969 (42 USC 4321 et seq.)
- Executive Order 11593, Cultural Resources
- American Indian Religious Freedom Act of 1978 (PL 95-341)
- Executive Order 13007, Indian Sacred Sites

- Archaeological Resources Protection Act of 1979 (16 USC 470aa-mm)
- National Historic Preservation Act of 1966 (16 USC 470 et seq.)

3.13.4 Criteria for Significance

Decisions regarding the management of cultural resources, including TCPs, hinge on determinations of their NRHP significance.

To determine significance, the National Park Service has identified components that must be considered in the evaluation process. These include criteria for determining eligibility, historic context, and integrity.

Significance of cultural resources is measured against the following NRHP criteria for evaluation (36 CFR 60.4):

The quality of significance in American history, architecture, archeology, engineering, and culture is present in districts, sites, buildings, structures, and objects that possess integrity of location, design, setting, materials, workmanship, feeling, and association, and,

- (a) that are associated with events that have made a significant contribution to the broad patterns of our history; or
- (b) that are associated with the lives of persons significant in our past; or
- (c) that embody the distinctive characteristics of a type, period, or method of construction, or that represent the work of a master, or that possess high artistic values, or that represent a significant and distinguishable entity whose components may lack individual distinction; or
- (d) that has yielded, or may be likely to yield, information important in prehistory or history.

A more detailed explanation of each criterion and each component that must be considered in the cultural resource evaluation process is presented in Appendix P, *Cultural Resources Background Information* (see *Criteria for Significance*).

3.13.5 Affected Environment Setting

3.13.5.1 Natural Setting

A summary of the natural setting for the Station project area can be found in Appendix P, *Cultural Resources Background Information* (see *Affected Environment, Natural Setting*).

3.13.5.2 Cultural Setting

The Station project area and its vicinity are known to contain numerous traces of past human activity ranging from early Native American sites and artifacts, to the remains of early trails and transportation routes, historic-era mining, and ranching activities. Such materials can be found at many locations on the landscape and represent the traces of human activities that in some cases extend as far back as 10,000 to 12,000 years before the present. A detailed discussion of the Station area's prehistoric, ethnographic, and historic setting can be found in Appendix P, *Cultural Resources Background Information* (see *Cultural Setting*) and provides context for the following discussion of cultural resources identified within the APE.

3.13.6 Resources Identified Within the Area of Potential Effect

A series of technical studies (EDAW, 2006a and 2006b) identified several historic properties within the APE for the Proposed Action and Alternative 1. With the exception of the ROWs for the 500-kV transmission line linking the proposed

locations of the Duck Creek Substation at the power plant sites, all areas that may be directly impacted by implementation of the Proposed Action or Alternative 1 were subjected to an intense Class III inventory. A Class I inventory, consisting of a review of previous studies and application of the BLM cultural sensitivity model, was used to assess the cultural sensitivity of the 500-kV transmission line ROWs.

In coordination with the BLM, a significant viewshed was established for the assessment of indirect visual effects. An assessment of NRHP eligibility was conducted for 16 ranches whose eligibility may be compromised by the implementation of the Proposed Action or Alternative 1.

3.13.6.1 Class III Inventory

Class III inventories conducted by the BLM and EDAW resulted in the documentation of 37 cultural resource sites within the Proposed Action and Alternative 1 project areas (EDAW, 2006a). Of these, the majority are prehistoric resources (24), and the remainder (13) are the result of land use during the historic era. A total of 10 resources (5 prehistoric and 5 historic), or 27 percent of the total identified resources, have been recommended eligible for inclusion in the NRHP, pending determinations by the BLM and review by the Nevada SHPO. As shown in Table 3.13-1, three sites are in the area of

the Proposed Action and four are in the area of Alternative 1. Three additional NRHP eligible sites occur within the Thirtymile Substation site and are associated with the Proposed Action and Alternative 1. All significant prehistoric sites have been recommended NRHP eligible based upon their research potential, Criterion D. Of the five historic resources, one is a portion of the Pony Express National Historic Trail/Overland Stage, one is an historic homestead with evidence for the presence of subsurface archaeological deposits, one is the route of the Transcontinental Telegraph, and the remaining two are represented by documented segments of the NNR. While the Pony Express National Historic Trail has been determined eligible under Criteria A, B, and C described previously, that segment within the Proposed Action project area has been impacted by construction of County Road 18 and is recommended not eligible under Criterion C. The route was also recommended as eligible to the NRHP under Criterion A for its association with the Overland Stage. Both segments of the NNR have been recommended eligible under Criterion C, and one segment also appears eligible under Criterion D. The homestead was recommended eligible under Criterion D, based upon evidence for the presence of subsurface archaeological deposits. Table 3.13-1 summarizes these resources by Station project area.

TABLE 3.13-1
Summary of Identified Cultural Resources by Station Project Area

	Proposed Action		Alternative 1		Thirtymile Substation		Total	
	Total	Recommended NRHP-Eligible	Total	Recommended NRHP-Eligible	Total	Recommended NRHP-Eligible	Total	Recommended NRHP-Eligible
Prehistoric	4	0	8	2	12	3	24	5
Historic	9	3*	4	2	0	0	13	5
Total	13	3	12	4	12	3	37	10

* Includes the Pony Express National Historic Trail.

3.13.6.2 Class I Inventory

Results of the Class I inventory and application of the BLM sensitivity model for cultural resources (Drews and Ingbar, 2004) indicate a strong potential for the presence of significant archaeological sites within the proposed 500-kV ROWs for the transmission lines linking the Proposed Action and Alternative 1 power plants to the SWIP corridor. Also, both transmission line ROWs would bisect the NNR, for which the NRHP evaluation has yet to be completed.

3.13.6.3 Historic Ranches

Sixteen historic ranches within the viewshed of the Proposed Action and/or Alternative 1 power plant sites and the proposed transmission lines were assessed for eligibility to the NRHP under Criteria A, B, and C (EDAW, 2006b). Access was not available for the Pescio and Fitzhugh Ranches, consequently an assessment of NRHP eligibility could not be completed. Both of these resources are assumed eligible pending completion of the NRHP assessment. Of the remaining fourteen ranches, the Schellbourne Ranch is already listed on the NRHP and five other ranches were found to possess elements that have been recommended eligible under one or more of the three criteria. These six ranches are briefly described below.

3.13.6.3.1 Kemp Ranch

The dugouts on this property stand as reminders of the rural culture developed in response to the mining boom in the early 1900s, and therefore appear eligible under Criterion A of the NRHP. Research did not indicate that the original owners, the Mollesons, were considered important in local history (NRHP Criterion B) The slaughterhouse structure is a good example of early 20th century slaughterhouses and has retained a good degree of integrity of

design, workmanship, and historic structures. Therefore, it is recommended NRHP-eligible under Criterion C.

3.13.6.3.2 Mattier Creek Ranch

Similar to the Kemp Ranch, historic documentation did not reveal a relationship between significant historic events or persons that would qualify the Mattier Creek Ranch NRHP-eligible under Criteria A or B. However, the original stone homestead appears NRHP-eligible under Criterion C. This building is an excellent example of architectural characteristics and methods of construction used in the region during the early homestead era. In addition, it has retained its integrity of location, materials, workmanship, and design.

3.13.6.3.3 Magnuson Ranch

While not eligible under Criteria B and C, the residence (constructed around 1915) at Magnuson Ranch is recommended NRHP-eligible for its association with the original Lincoln Highway. Although additions and modifications have been made to the structure and other ranch buildings have been added to the complex, the residence retains its direct association with the Lincoln Highway and the surrounding rural landscape of Steptoe Valley that is virtually unchanged since the early 1900s, the period of significance.

3.13.6.3.4 Monte Neva Hot Springs Resort

The integrity of the Monte Neva Hot Springs Resort has been severely compromised through demolition and deterioration. Historic documentation failed to reveal an association with persons of importance during the historic era (Criterion B). However, the adobe building on this property appears to be eligible for listing on the NRHP for its association with the Monte Neva Hot Springs Resort, a

regional manifestation of the recreational/health movement of the late nineteenth/early twentieth century (Criterion A), and as a good example of a rare vernacular building type (Criterion C). The property as a whole has lost a significant amount of integrity because of the removal of almost all of the original buildings and structures. Most of what is known about this property is revealed through a relatively small number of surviving primary sources. Because of this property's significant association with an important historic theme, and because of the scarcity of surviving documentation concerning its history, any archaeological remains at this property would be likely to yield important primary information (Criterion D). The Monte Neva property, therefore, appears eligible for NRHP listing as a historic site for its archaeological information potential.

3.13.6.3.5 Schellbourne Ranch

The Schellbourne Ranch was previously evaluated and determined eligible for listing on the NRHP. Scant information contained in the nomination form lacks a discussion of the significant historic values represented at the ranch. However, the association with the Pony Express, Overland Stage, early mining, and as a stop on the original 1913 route of the Lincoln Highway appears to qualify the property under Criterion A. The potential for archaeological values associated with each of these events and the location of a Shoshoni village qualifies the ranch for archaeological values and as NRHP-eligible under Criterion D.

3.13.6.3.6 Whiteman Creek Ranch

The buildings that remain on this property, a cabin and dugout/cellar, appear to have been constructed sometime during the early twentieth century. This was a time of

renewed agricultural development in the Steptoe Valley, brought about by the discovery of great copper deposits in the area. These buildings reflect an association to that period in time, and therefore appear eligible under NRHP Criterion A.

Research did not reveal that the property was associated with individuals considered important in local history (NRHP Criterion B). The buildings themselves do not embody distinctive architectural characteristics, nor do they represent noteworthy examples of local vernacular architecture (NRHP Criterion C). These types of buildings are well recorded in both written and visual sources, and do not appear likely to yield important primary information concerning historic construction techniques or technology (NRHP Criterion D).

3.13.6.4 Historic Linear Resources

Three historic linear resources are located within the viewshed of the Station Proposed Action and Alternative 1. While the entire route of the Pony Express National Historic Trail has been determined NRHP-eligible under Criteria A and B, the route of the NNR from Ely to Cobre and the section of the Lincoln Highway within Steptoe Valley have yet to be evaluated.

3.13.6.4.1 Nevada Northern Railroad (NNR)

Forty acres containing the NNR Station, maintenance buildings, and associated rolling stock located in Ely are listed on the NRHP and has also been designated a National Historic Landmark. Two segments of the NNR within Steptoe Valley were assessed for NRHP-eligibility under Criteria C and D (EDAW, 2006a). One segment was recommended eligible under Criterion D and both segments were recommended as contributing elements under Criterion C. No eligibility assessments have been made for

the rail line from Ely to Cobre, however two other short segments of the rail line within Steptoe Valley have been recommended as contributing elements under Criterion C. While not formerly evaluated under Criteria A and B, the entire route of the NNR appears eligible under Criterion A for its contribution to the economic development of the Ely region, and under Criterion B for its association with Mark Requa who was instrumental in developing the copper mining operations of the region.

3.13.6.4.2 Pony Express National Historic Trail

Godfrey (1994) states that the significance of the Pony Express “does not rest on the company’s capabilities as a viable and efficient economic endeavor. Instead, its significance is grounded in the Pony Express’ basic contribution to transportation and communication history, and its very existence during a critical time period in American history.” For these reasons the route has been determined eligible to the NRHP under Criterion A. For similar reasons it can also be argued that the route would not have existed if it were not for the efforts of the primary owner of the COC & PP Express Co, William Russell, qualifying the Pony Express route for eligibility under Criterion B. Elsewhere, where the remains of stations exist, the associated features have been determined eligible under Criterion C.

Regarding those segments within the Station project area, lack of integrity, architectural or engineered features, or evidence for the presence of archaeological deposits precludes those segments from qualifying as a contributing element under Criteria C or D. Therefore, while the route as a whole is eligible under Criterion A and possibly B, and elsewhere outside the limits of the Station project area, stations have been determined eligible under Criterion C, those portions

within the Station project area (see Figure 3.8-1) have been recommended as a non-contributing segments under Criterion C and D (EDAW, 2006a).

NPS (Godfrey, 1994) lists the Pony Express route from the Nevada-Utah border to just east of Austin, including the route within Steptoe Valley, as a high potential route, which is defined as “those segments of a trail which would afford a high quality recreation experience in a portion of the route having greater than average scenic values or affording an opportunity to vicariously share the experience of the original users of a historic route.”

3.13.6.4.3 Lincoln Highway

Several components, including road segments and associated features, are listed on the NRHP elsewhere. Other constituents of the Lincoln Highway in Nevada have been recommended and determined eligible for inclusion in the NRHP, however none are currently listed. Evaluations have not been conducted on the segment in Steptoe Valley that is east and parallel to U.S. 93.

Within Steptoe Valley, the National Park Service (2004) has designated the route of the 1913 Lincoln Highway as a Heritage Area. Magnuson Ranch, a rest stop noted in the Lincoln Highway tour books, is located on the original 1913 portion of the route, and the Magnuson Ranch residence constructed around 1913 appears eligible to the NRHP under Criterion A (see discussion above). Schellbourne Ranch, another stop along the original route, is listed on the NRHP under Criteria A and D.

3.13.6.5 Traditional Cultural Properties

No Traditional Cultural Properties were identified in a recent Ethnographic study for the Ely Resource Management Plan (Woods, 2003), or during further consultation with the BLM, Ely Field Office.

3.14 Environmental Justice

Executive Order 12898, *Environmental Justice*, requires federal agencies to disclose if actions will result in a disproportionate concentration of impacts on minority or low-income populations.

3.14.1 Study Area

The study area for environmental justice is primarily within White Pine County, Nevada. However, effects concerning air quality could extend beyond White Pine County into counties to the north and east in both Nevada and Utah.

3.14.2 Populations

Executive Order 12898 addresses any identified minority populations or low-income populations likely to be adversely affected by the construction, operation, and maintenance of a project. A population is all people living in a given geographic area or a group of people from whom a statistical sample is taken. With respect to environmental justice, the population is all people who are members of a minority group or living in a low-income household.

Affected populations would be in three census tracts: 9701 (includes McGill), 9702 (includes Ely and Ruth), and 9703 (includes Ely, Keystone Junction, and Baltimore Mill). Census Tract 9701 averages less than 1 person per square mile and is the sparsest census tract in White Pine County. The densest census tract is 9703 with an average of 62 people per square mile.

The White Pine Energy Station Proposed Action and Alternative 1 power plant sites are located in a sparsely populated area of Census Tract 9701. The Proposed Action and Alternative 1 sites are 22 miles and

10 miles, respectively, from communities of any discernable density. All segments of the associated transmission line would pass through unpopulated or sparsely populated areas of White Pine County. None of the segments would pass near any known minority populations or low-income populations. The community with the largest population in Census Tract 9701 is McGill, with 1,054 residents in approximately 1 square mile. This is approximately half of the census tract's population. The remaining 1,718 residents are dispersed among the census tract's remaining 6,460 square miles (Rajala, 2005).

The closest residential structures are approximately 2 miles from the Station Proposed Action and Alternative 1 power plant sites. An interview with White Pine Economic Diversification Council staff indicates that none of the households closest to either site contain protected populations.

3.14.2.1 Low-Income Populations

The population of low-income people in the study area is identified through the annual statistical poverty thresholds from Bureau of the Census's *Current Population Reports, Series P-60 on Income and Poverty*. These thresholds are the same as those used by the U.S. Department of Health and Human Services. Low-income populations, when regarded as communities, may be characterized by geographic proximity or commonly experienced environmental conditions.

Table 3.14-1 presents the most recent update of the poverty thresholds (2004).

Table 3.14-2 presents the poverty statistics for White Pine County's three census tracts and the state of Nevada.

TABLE 3.14-1

Poverty Thresholds Annual Income (\$) for 2004 by Size of Family and Number of Related Children Under 18 Years

Size of Family Unit	Related Children Under 18 Years								
	None	One	Two	Three	Four	Five	Six	Seven	Eight or More
One person (unrelated individual)									
Under 65 years	9,827								
65 years and over	9,060								
Two people									
Householder under 65 years	12,649	13,020							
Householder 65 years and over	11,418	12,971							
Three people	14,776	15,205	15,219						
Four people	19,484	19,803	19,157	19,223					
Five people	23,497	23,838	23,108	22,543	22,199				
Six people	27,025	27,133	26,573	26,037	25,241	24,768			
Seven people	31,096	31,290	30,621	30,154	29,285	28,271	27,159		
Eight people	34,778	35,086	34,454	33,901	33,115	32,119	31,082	30,818	
Nine or more people	41,836	42,039	41,480	41,010	40,240	39,179	38,220	37,983	36,520

Source: U.S. Census Bureau, 2004

TABLE 3.14-2

Income Levels of Individuals Surveyed in Nevada and Project Area Census Tracts

	Census Tract			
	Nevada	9701	9702	9703
Individuals below poverty level in 1999	205,685	241	406	219
Individuals at or above poverty level in 1999	1,757,263	1,457	3,701	1,869
Percent below poverty level in 1999	10.5	14.2	9.9	10.5
Total	1,962,948	1,698	4,107	2,088

Source: U.S. Census Bureau, 2000

The number of low-income households surveyed in White Pine County is 838 (25.5 percent of the county's households). The number of individuals surveyed that are living in low-income households in the

three census tracts is 866. Of the 866 people, 265 live in either small communities of less than 1,000 or in areas where no other residences exist within several miles. Census Tract 9701 (the

location of the Proposed Action and Alternative 1 power plant sites) has the highest percentage of low-income people and the smallest total population in White Pine County. Of the 241 low-income people surveyed in Census Tract 9701, 112 live in McGill. Ely is home to 489 low-income people.

3.14.2.2 Minority Populations

A member of a minority population is a person or people identified as Hispanic (irrespective of racial category) or a person or people from any racial category except “white alone.”

The 2000 census placed the total population of White Pine County at 9,181. The number of people in White Pine

County identified as “white alone” was 7,295, or 79 percent of the total population. Census Tract 9701 had the greatest minority percentage, 27 percent, and the greatest number of minorities, 748. Census Tract 9701 had the smallest total population in White Pine County. Of Census Tract 9701’s 748 minorities, 111 lived in McGill. The remaining 637 were spread throughout the census tract and within small concentrated communities. The remaining 1,138 minorities in White Pine County are mostly concentrated in Ely and small communities south of the Proposed Action and Alternative 1 power plant sites and their associated facilities (see Table 3.14-3).

TABLE 3.14-3
Minority Population in Nevada and Project Area*

	Nevada	Census Tract		
		9701	9702	9703
Hispanic or Latino	393,970	328	381	299
Not Hispanic or Latino	1,604,287	2,444	3,947	1,782
Population of one race	1,555,056	2,415	3,878	1,748
White alone	1,303,001	2,024	3,606	1,665
Black or African American alone	131,509	306	59	5
American Indian and Alaska Native alone	21,397	64	161	49
Asian alone	88,593	14	34	23
Native Hawaiian and Other Pacific Islander alone	7,769	4	13	4
Some other race alone	2,787	3	5	2
Population of two or more races	49,231	29	69	34
Percent minority	35	27	17	20
Total	1,998,257	2,772	4,328	2,081

Source: U.S. Census Bureau, 2000

*The difference in population totals between Table 3.14-2 and Table 3.14-3 is due to the survey method used in the 2000 census. Table 3.14-2 is based on a sample survey and Table 3.14-3 is based on a 100 percent survey.

3.15 Native American Religious Concerns

An integral part of the NEPA scoping process includes coordination between federal agencies and those groups who may be affected by a proposed federal action. BLM representatives initiated formal and informal communication with Native American Tribal representatives in the project area to discuss the proposed project. This process has provided Tribes with the opportunity to identify potential effects of the project on Native American interests.

This section describes Native American Religious Concerns in the project area. Section 3.15.1, *Analysis Area and Methodology*, includes a brief description of the analysis area and methods. Section 3.15.2, *Regulatory Framework*, describes legal acts and Executive Orders that protect Native American cultural resources, rights, and values.

3.15.1 Analysis Area and Methodology

The analysis area for Native American Religious Concerns includes lands identified within the designated Station project area proposed for the following:

- Power plant sites
- Electrical substations
- Electric transmission lines (300 feet from each side of the centerline)
- A 200-foot-wide corridor that extends 100 feet from the centerline of other linear features (water pipelines, railway spur, and access roads)
- Up to 5-acre parcels for wells, pump stations, and water storage facilities

The methodology for the analysis of Native American concerns included a review of

correspondence and meetings with Tribal representatives to discuss the scope of the proposed project and any issues or concerns that Tribal representatives might have regarding the project.

A Native American coordination meeting was conducted on December 8, 2004, in the BLM Ely Field Office with representatives from the Ely Shoshone Tribe, Duckwater Shoshone Tribe, WPEA, and the Ely Field Office staff. WPEA representatives presented project details to the group. Issues and concerns were discussed.

After the December 2004 meeting, BLM Ely Field Office staff have remained in communication with the Tribes regarding the project. The most recent meeting with the Tribes was in July 2006. At this point in the project, no issues or concerns have been raised by the various Tribes regarding any religious or traditional cultural property concerns.

3.15.2 Regulatory Framework

The following text describes legal acts and Executive Orders followed by the BLM in their relationships with Tribal governments that protect Native American cultural resources, rights, and values.

3.15.2.1 National Historic Preservation Act, as Amended for Protection of Native American Values

As discussed in Section 3.13, *Cultural and Historical Resources*, Section 106 of the National Historic Preservation Act requires federal agencies to take into account effects of their undertaking on properties eligible to the NRHP. Amendments of 1992 provide explicitly for consideration of places of traditional religious or cultural significance as eligible to the National Register. Such places, referred to as

“traditional cultural properties,” require different considerations from archaeological sites and historic buildings (National Park Service, 1999) when evaluating their significance against National Register criteria. The 1992 amendments also direct federal agencies to consult with appropriate Tribes as part of their Section 106 process. Such consultation enables Tribal governments and traditional elders to assist in identifying potentially eligible properties and the values that make them eligible; and assessing project effects on such properties, including identification of mitigation measures where possible.

3.15.2.2 Native American Graves Protection and Repatriation Act of 1990

The Native American Graves Protection and Repatriation Act of 1990, as amended (Federal Register 62:148), requires consultation with appropriate Indian Tribes prior to the excavation of human remains, funerary objects, sacred objects, or objects of cultural patrimony on federal lands. The Native American Graves Protection and Repatriation Act recognizes Native American ownership interests in some human remains and cultural items on federal lands and makes illegal (under most circumstances) the sale or purchase of Native American human remains, whether or not they are derived from federal or Indian lands. Repatriations, on request, to the culturally affiliated Tribe are required for human remains and associated funerary objects. Repatriation of other cultural items depends on whether or not the original acquisition of an item was from an individual with the authority to alienate from the Tribal group (43 CFR Par 10).

3.15.2.3 American Indian Religious Freedom Act of 1978

The American Indian Religious Freedom Act of 1978 affirms United States policy that federal agencies will ensure that their policies and procedures protect and preserve the rights of American Indians to affirm, express, and exercise traditional religions, including access to sites, use and possession of sacred objects, and freedom of worship through ceremonials and traditional rites. The law required a review of policies by federal agencies when it was passed. However, it contains no enforcement provisions or sanctions for policies or procedures that do not comply with the overall policy.

3.15.2.4 Executive Order 13007 of 1996, “Indian Sacred Sites”

Executive Order 13007 adds an element of enforcement to the policy set forth by the American Indian Religious Freedom Act of 1978. It requires the following actions from federal agencies

- Accommodate access to and ceremonial use of sacred sites by Indian religious practitioners
- Avoid adverse physical effects to such sites

Agencies must provide reasonable notice of proposed actions that might “restrict further access to or ceremonial use of, or adversely affect the physical integrity of, sacred sites.” Tribes must inform agencies of the existence of such sites.

3.15.2.5 Memorandum on Government-to-Government Relations with Native American Tribal Governments of 1994

This memorandum outlines principals that executive departments and agencies are to

follow within a government-to-government relationship with federally recognized Tribes.

3.15.2.6 Title I of the Indian Self-Determination and Educational Assistance Act of 1975

Title I of this Act provides direct and primary authority to Tribal governments to contract programs and services that are carried out by the federal government under specific authorities or which are for the benefit of Indians because of their status as Indians, and also provides some limited authority for Tribal governments to acquire lands adjacent to reservations for purposes of the Act.

3.15.2.7 Archaeological Resources Protection Act of 1979

This Act provides for the notification of appropriate Indian Tribes, and subsequent consultation, prior to granting of any permit that might harm sites of cultural or religious importance to the Tribe(s).

3.15.2.8 Title IV of the Indian Self-Determination and Educational Assistance Act of 1994: The Self-Governance Act

This Title provides that certain programs, functions, services and activities or portions thereof are eligible to be planned, conducted, consolidated, and administered by a self-governance Tribal government. Title IV expands contracting beyond programs that are for the benefit of Indians by providing for discretionary compacting of "nexus" programs administered by the Secretary of the Interior where there is a special geographic, historic, or cultural significance to participating Tribes.

3.15.2.9 Executive Order 13175: Consultation and Coordination with Indian Tribal Governments

This order supersedes the previous Executive Order 13084 of the same title. Executive Order 13175 provides fundamental principles for agencies to follow when formatting or implementing "policies that have Tribal implications," referring to regulations, proposed legislation, other policy statements, or actions that have substantial direct effects on Tribes, or on the distribution of power and responsibilities between the Federal Government and Indian Tribes.

3.15.2.10 512 DM 2.1, Departmental Responsibilities for Indian Trust Resources

This directive establishes policies, responsibilities, and procedures for operating on a government-to-government basis with federally recognized Indian Tribes for the identification, conservation, and protection of American Indian and Alaska Native trust resources to ensure the fulfillment of the Federal Indian Trust Responsibility. Agencies must identify impacts from federal plans, projects, programs, or activities on Indian trust resources and must address such impacts in planning, decision, or operational documents and consult with Tribal governments whose assets are potentially affected.

3.15.2.11 512 DM 3, Sacred Sites

This directive establishes policy, responsibilities, and procedures to accommodate access to and ceremonial use of Indian sacred sites and to protect the physical integrity of such sites consistent with Executive Order 13007.

3.16 Paleontological Resources

Paleontological resources are fossilized remains of multi-cellular invertebrate and vertebrate animals and multi-cellular plants, including imprints (36 CFR 261.2). Section 3.16.1, *Analysis Area and Methodology*, includes a brief description of the analysis area and methods. Section 3.16.2, *Regulatory Framework*, describes federal regulations that protect paleontological resources. Section 3.16.3, *Existing Conditions*, describes the existing paleontological resource conditions in the project area.

3.16.1 Analysis Area and Methodology

The analysis area for paleontological resources includes lands identified within the designated Proposed Action and Alternative 1 Station areas proposed for:

- Power plant sites
- Electrical substations
- Electric transmission lines (300 feet from each side of the centerline)
- A 200-foot-wide corridor that extends 100 feet from the centerline of other linear features (water pipelines, railway spur, and access roads)
- Up to 5-acre parcels for wells, pump stations, and water storage facilities

Existing literature on the geology and paleontological resources of the project area was reviewed for the existence of known fossils or areas with high potential for the existence of fossils based on geologic conditions. No field surveys were conducted for this project.

3.16.2 Regulatory Framework

3.16.2.1 Code of Federal Regulations

The BLM manages paleontological resources under a number of federal regulations. Sited most often is 43 CFR 8365.1-5, which prohibits the willful disturbance, removal, and destruction of scientific resources or natural objects. Regulations at 43 CFR 8360.0-7 identify the penalties for such violations.

3.16.2.2 Federal Land Policy and Management Act

The Federal Land Policy and Management Act (FLPMA) of 1976 (P.L. 94-579) requires that public lands be managed in a manner that protects the "...scientific qualities..." and other values of resources under BLM management.

The BLM has a Paleontological Resource Management Program intended to provide a consistent and comprehensive approach to the management of paleontological resources, including identification, evaluation, protection, and use. This program is described in BLM Manual 8720 (BLM, 1998). The specific objectives of this program are included in Appendix C, *Best Management Practices*, under Paleontological Resources.

Paleontological resources found on public lands are recognized by the BLM as constituting a fragile and nonrenewable scientific record of the history of life on earth, and so represent an important and critical component of America's natural heritage. It is the BLM's policy, therefore, to manage paleontological resources for these values, and to mitigate adverse impacts to them (BLM, 1998).

3.16.3 Existing Conditions

The most recent, county-wide paleontological research in White Pine County was completed and presented in the *Final Environmental Impact Statement for the Proposed White Pine Power Project* completed for the BLM by Dames and Moore (BLM, 1984). The following existing condition information relies heavily on this source, which represents the most recent information available.

The earliest geological evidence in White Pine County is the late Precambrian McCoy Creek Group of quartzites and schists found in the Cherry Creek, Egan, Schell, and Snake Ranges. From Precambrian until early Mesozoic time, eastern Nevada was part of the Cordilleran miogeosyncline, a subsiding trough in which deposits accumulated. The materials representative of this period contain shallow marine deposits. Cambrian Period strata contain trilobites and are significant where these important fossils are present.

Several strata of the Paleozoic Era have moderate paleontological potential. The Ordovician Poqonip group contains marine invertebrates (mostly mollusks and algae). Devonian Period fossil-bearing strata include the Simonson dolomite and Guilmette Formation. The Joana Formation is the only unit in White Pine County dating to the Mississippian Period, appearing to be highly fossiliferous and containing abundant corals, brachiopods, mollusks, and crinoids. Permian Period strata contain the majority of paleontological resources found in White Pine County and account for most localities recorded.

Evidence of only limited sedimentary deposition exists in the county for the Cenozoic Era. Most of what is present dates to the Miocene Epoch when infilling

of structural and sedimentary basins occurred. Although limited in extent, these sediments are rich in paleontological deposits.

The Quaternary Period of the Cenozoic Era is noted for climatic oscillations resulting in the development of glacial ice and related pluvial lakes. Deposits dating to the period consist of a variety of alluvial deposits, and none has much potential for paleontological resources.

3.16.3.1 Paleontological Resources Literature Survey Results

Steptoe Valley sediments are mapped as Quaternary alluvium and playa deposits. A review of the literature did not reveal any recorded fossil locations within the project area, except for the transmission line ROW. Few reports of fossils were found in the literature review.

3.17 Socioeconomics

This section describes existing socioeconomic conditions in White Pine County, Nevada. White Pine County was selected as the primary study area for socioeconomic resources because the proposed White Pine Energy Station and ancillary facilities would be located entirely within the county, and the Station construction and operations work force would be based in the local area.

Therefore, the potential socioeconomic effects resulting from implementation of the Proposed Action or Alternative 1 would likely be concentrated in White Pine County. In some cases, socioeconomic effects would also take place in surrounding counties and/or other regions of the country, depending on the location of direct construction- and operations-related expenditures or indirectly as direct effects ripple through the economy (the multiplier effect).

The focus of this section is on those socioeconomic resources that may be affected by the Proposed Action or Alternative 1. The key resource topics addressed in this section include: population and housing, including property values; local economic conditions (as measured primarily by employment and income); fiscal resources of local government agencies; and local public services.

The purpose of the Affected Environment section is twofold. The information presented is intended to provide context and a general overview of the local economy and other socioeconomic resources that would be affected by the Station. This section also establishes baseline socioeconomic conditions against which the potential impacts of the Proposed Action and Alternative 1 will be

evaluated. The data used to establish baseline socioeconomic conditions come from a variety of federal, state, and local sources. County-level information, particularly data from the 2006 *Comprehensive Economic Development Strategy* (CEDS) prepared by the White Pine County Economic Diversification Council (WPCEDC, 2006), is included where appropriate and is considered the most accurate summary of existing local conditions, including data that reflect the recent re-opening of the Robinson Mine in 2004.

Historically, White Pine County's economy has depended on mining and agriculture, supplemented by tourism and recreation. The Robinson Copper Mine, located 7 miles west of Ely, provided the county's primary employment opportunities and economic activity from 1906 through the 1970s. In 1978, Kennecott Copper closed the mine, causing a severe economic decline. In 1996, the mine was sold to Magma Copper of Arizona and later to BHP of Australia. The mine operated until 1999, and when it closed the second time, it again caused a significant economic decline. The boom/bust cycle of the mining industry created wide fluctuations in population, labor force, and business activity and public revenues. The mine was purchased by Quadra Mining Company in April 2004 and went back into full operation in July of that year. Washington Group Nevada (a wholly-owned subsidiary of Quadra Mining) currently performs contract mining operations. In 2005, the mine produced 126 million pounds of copper and 85,000 ounces of gold, and in 2006, production was projected to decrease slightly to 115 million pounds of copper and 55,000-60,000 ounces of gold (Quadra Mining Ltd., 2005a). According to the 2006 CEDS report, the mine reached full

operation within a year of initial operations and has a work force of 500 employees. The combined employment of the Robinson Nevada Mining Company and Washington Group Nevada makes the Robinson Mine the largest private employer in White Pine County.

3.17.1 Population

White Pine County is rural and sparsely populated. Much of the county's population is centered in the City of Ely. According to the Nevada State Demographer's Office, the total population in White Pine County in 2006 was 9,542 people (see Table 3.17-1).

The existing county population accounts for 0.4 percent of the state's total population of just over 2.6 million people, which makes it the 10th most populated of the state's 17 counties. The county's total population declined slightly between 1990 and 2000 (minus 0.9 percent); however, this trend was more prominent for the 20- to 34-year-old age group where population decreased by roughly 14.4 percent (University of Nevada, Reno, 2004). There was a decline in total population in the early 2000s partly because of the closure of Robinson Mine, but population levels

recovered by 2005. More recently, population trends show an expanding population base with an increase of 2.9 percent new residents between 2005 and 2006. This is primarily a result of the re-opening of the Robinson Mine, as well as an increased demand for retirement and second homes, particularly from people residing in the Las Vegas area. Recent population increases make White Pine County the eighth fastest growing county in the state on a percentage basis.

The City of Ely, the only incorporated city in the county, had a population of 4,325 in 2006, where approximately 45 percent of the county's population resides. The City of Ely experienced declining population levels between 1990 and 2005 and recent increases in population since then. The county's other population centers include the small, rural communities of McGill, Ruth, Lund, and Baker.

Fluctuations in local population levels illustrate the influence of a relatively cyclical industry (mining), and its strong influence on the rural counties of Nevada. Such fluctuations are not evident at the state-wide level, where statistics are dominated by the state's urban centers and where population has more than doubled between 1990 and 2006 (Table 3.17-1).

TABLE 3.17-1
Historic and Current Population Levels*

Area	1990	2000	2005	2006
White Pine County	9,264	9,181 (-0.9%)	9,275 (1.0%)	9,542 (2.9%)
City of Ely	4,756	4,041 (-15.0%)	4,166 (3.1%)	4,325 (3.8%)
State of Nevada	1,201,833	1,998,257 (66.3%)	2,518,869 (26.1%)	2,622,753 (4.1%)

Source: U.S. Census Bureau 1990a, 1990b, 2000a, 2000b; Nevada State Demographer's Office 2005, 2006a
* Percentage increases are shown in parentheses and represent total percentage change from previous period.

The Nevada State Demographer's Office projects that the population in White Pine County will decrease over the next two decades (see Table 3.17-2). By 2026, the total county population is expected to fall to just under 8,600 people, representing a decline of 7.4 percent between 2005 and 2026. During this same period, high growth rates are expected at the state level with the population projected to increase by nearly 74 percent. However, it should be noted that these projections rely on historic population trends, which do not fully account for recent increases in local population levels attributed to changes in the local economy, such as the re-opening of the Robinson Mine, which is drawing people into the county and expanding its population base. These projections also do not consider potential future economic developments in the Station project area or a continuation of the recent trend of retirees moving to the county. As a result, these county-level population projections may not be an accurate gauge of future population trends.

3.17.2 Employment and Job Base

Generally, the economy in White Pine County is evolving from a mining-reliant economy to a service sector economy that is becoming more dependent on tourism,

retirement, and government employment. According to the U.S. Department of Commerce, Bureau of Economic Analysis, total full- and part-time employment in White Pine County in 2004 was 4,403 (Bureau of Economic Analysis, 2004a). Table 3.17-3 shows employment by type of industry in 2004. Non-farm employment is the predominant source of the county job base, accounting for 96 percent of all jobs. Overall, the largest sector in the county is Government, which employs 1,463 people and accounts for about 33 percent of the county job base. Approximately 1,000 public sector (government) jobs are with state and federal agencies and are independent of changes in the local economy (WPCEDC, 2006). Other leading sectors in the local economy in 2004 included Accommodation and Food Services (12.0 percent) and Retail Trade (11.4 percent).

In 2006, public employment still represented the largest employment sector (1,474 jobs) and mining employment had increased to 618 jobs (WPCEDC, 2006). Service-related industries, with a current employment base of 1,379 jobs in 2006, have experienced the greatest job growth in the county in recent years. The total number of non-farm private businesses in the county in 2006 was 193 (WPCEDC, 2006).

TABLE 3.17-2
Population Projections through 2026*

Area	2005	2010	2020	2026
White Pine County	9,275	9,217 (-0.6%)	9,149 (-0.7%)	8,592 (-6.1%)
State of Nevada	2,518,869	3,087,428 (22.6%)	4,001,520 (29.6%)	4,370,521 (9.2%)

Source: Nevada State Demographer's Office, 2006b

* Percentage increases are shown in parentheses and represent total percentage change from previous period.

TABLE 3.17-3

Employment by Industry in White Pine County (2004)

Industry/Sector*	Jobs	% of Total
Farm Employment	179	4.1
Non-Farm Employment	4,224	95.9
Forestry, fishing, related activities and other	(D)	--
Mining	335	7.6
Utilities	(D)	--
Construction	250	5.7
Manufacturing	51	1.2
Wholesale trade	58	1.3
Retail trade	502	11.4
Transportation and warehousing	(D)	--
Information	37	0.8
Finance and insurance	95	2.2
Real estate and rental and leasing	100	2.3
Professional and technical services	(D)	--
Management of companies and enterprises	(D)	--
Administrative and waste services	139	3.2
Educational services	(D)	--
Health care and social assistance	(D)	--
Arts, entertainment, and recreation	43	1.0
Accommodation and food services	529	12.0
Other services, except public administration	145	3.3
Government	1,463	33.2
Federal (including military)	220	5.0
State	562	12.8
Local	681	15.5
Total	4,403	100.0

Source: Bureau of Economic Analysis, 2004a

* Based on NAICS industry classifications.

(D) = Data not available to avoid disclosure of confidential information (too few firms in the category to allow publication of data without risking identification of individual firms and employees). Estimate included in totals.

3.17.3 Unemployment

Table 3.17-4 shows the current labor force and unemployment rate in White Pine County. These data include workers employed at the Robinson Mine, which reinstated mining activities in June 2004.

The average size of the county labor force has increased steadily since 2003 and was estimated at 4,380 workers in October 2006, with a corresponding unemployment

rate of 3.8 percent (Rajala, 2007). The current unemployment rate reflects two recent developments: (1) the community is experiencing job growth because of mine operations, new small industrial firms locating in the area, and business expansions; and (2) the northern Nevada region is experiencing job growth because of several other new projects, which is reducing the available labor pool for jobs in White Pine County (WPCEDC, 2006).

TABLE 3.17-4

Labor Force and Unemployment (2006)

Area	Labor Force	Unemployment Rate
White Pine County	4,380	3.8%
State of Nevada	1,264,101	4.1%

Source: Rajala, 2007; Nevada Department of Employment, Training, and Rehabilitation, 2006

Between 1990 and 2006, the size of the labor force and unemployment rates varied considerably in the county. The peak labor force of 4,337 occurred in 1995, which is comparable to current (2006) levels, and dropped to a low of 3,457 in 1999. Since that time, the labor force has expanded, driven in part by new mining activity that has resulted in new workers coming to the area seeking employment. Unemployment peaked in 1993 at 12.2 percent and has been stable at just over 4 percent for roughly the past five years. Although unemployment rates in the county are comparable to the statewide average (4.1 percent in 2006), the labor market in Nevada has been more stable with unemployment rates ranging between 4.1 and 6.9 percent from 1990 to 2006.

Employment conditions in White Pine County are influenced by the local work force's education levels. Based on the 2000 Census, White Pine County's proportionate share of people 25 years and older with a high school diploma or higher education was 82.0 percent; this is higher than both the state value of 80.7 percent and the national value of 80.4 percent (University of Nevada, Reno 2004). However, White Pine County's proportionate share of people 25 years and older with a bachelor's degree is 11.8 percent, which is lower than the state value of 18.2 percent and the national value of 24.4 percent.

The characteristics of the existing labor force have implications for the proposed

White Pine Energy Station (as discussed further in Section 4.17, *Socioeconomics*). As reported in the 2006 CEDS report (WPCEDC, 2006), White Pine County has a relatively low unemployment rate and is facing a critical issue of work force availability and especially work force skills. The work force in rural Nevada is fluid and tends to go where the jobs are, especially in the construction industry. Further, there are no major population centers in the county that can provide highly skilled workers in large numbers.

3.17.4 Earnings and Income

Total personal income in White Pine County in 2004 was \$259.5 million (Bureau of Economic Analysis, 2004b). Of that total, about \$160.5 million (or 62 percent) was attributed to wage earnings and \$75.4 million (29 percent) represented non-labor income. Personal income in White Pine County accounted for only 0.3 percent of the total income earned in Nevada in 2004. The per-capita income level in White Pine County was \$30,306 in 2004, which is about 11 percent less than per-capita income levels throughout the state. At the household level, the median income level in the county in 2000 was \$36,668 compared to \$44,581 for the state. Table 3.17-5 summarizes income-related conditions in the county in 2004.

Table 3.17-6 shows place of work earnings by industry in White Pine County in 2004. Following patterns similar to employment, the *Government* sector had the highest level of wage earnings at \$81.7 million, mainly at the state and local level, which accounted for over half (50.9 percent) of all wage earnings in the county. Other sectors that provide a relatively high proportion of wage earnings in the county include *Retail Trade* (6.1 percent) and *Accommodations and Food Service* (5.2 percent). Farm-related earnings only account for 2.5 percent of the county-wide total.

TABLE 3.17-5
Personal Income (2004) ^a

Area	Wage Earnings	Net Earnings ^b	Non-Labor Income ^c	Total Income	Per-Capita Income
White Pine County	\$160,478	\$184,038	\$75,444	\$259,482	\$30,306
State of Nevada	\$61,541,717	\$54,881,909	\$23,940,225	\$78,822,134	\$33,787

Source: Bureau of Economic Analysis, 2004b

^a Values in thousands (\$1,000s) of dollars, except for per-capita income levels.

^b Net earnings (by place of residence) = earnings by place of work (wage earnings) less contributions for government social insurance plus adjustment for residence.

^c Non-labor income = dividends, interest, and rents plus transfer payments.

TABLE 3.17-6
Earnings by Place of Work by Industry in White Pine County (2004) ^a

Industry/Sector ^b	Earnings	% of Total
Farm Earnings	\$4,029	2.5%
Non-Farm Earnings	\$156,449	97.5%
Forestry, fishing, related activities and other	(D)	--
Mining	\$19,185	12.0%
Utilities	(D)	--
Construction	\$7,618	4.7%
Manufacturing	\$983	0.6%
Wholesale trade	\$1,977	1.2%
Retail trade	\$9,720	6.1%
Transportation and warehousing	(D)	--
Information	\$1,080	0.7%
Finance and insurance	\$3,001	1.9%
Real estate and rental and leasing	\$1,000	0.6%
Professional and technical services	(D)	--
Management of companies and enterprises	(D)	--
Administrative and waste services	\$2,157	1.3%
Educational services	(D)	--
Health care and social assistance	(D)	--
Arts, entertainment, and recreation	\$2,510	1.6%
Accommodation and food services	\$8,268	5.2%
Other services, except public administration	\$2,741	1.7%
Government	\$81,684	50.9%
Federal (incl. military)	\$13,623	8.5%
State	\$34,487	21.5%
Local	\$33,574	20.9%
Total	\$160,478	100.0%

Source: Bureau of Economic Analysis, 2002b

^a Values in thousands (\$1,000s) of dollars

^b Based on NAICS industry classifications

(D) = Estimate not available to avoid disclosure of confidential information (too few firms in the category to allow publication of data without risking identification of individual firms and employees). Estimate included in totals.

Based on income levels, poverty rates are a good economic indicator of social well-being. In 1999, the poverty rate for families in White Pine County was 10.3 percent (U.S. Census Bureau, 2000). The poverty rate in the county is slightly lower than the poverty rate in the City of Ely (11.3 percent), but higher than the statewide rate of 7.5 percent.

Wage data can also help characterize income conditions in White Pine County. The average annual wage/salary in the county in 2006 was \$36,230, which is slightly higher than the statewide figure of \$35,499 (Nevada Department of Employment, Training and Rehabilitation, 2006).

3.17.5 Tax Receipts and Fiscal Resources

Development of the Station has the potential to affect local economic activity, property values, and land tenure, all of which may affect property and sales tax revenues realized by White Pine County. The county relies on tax revenues to fund public services and programs, and tax revenues represent a large proportion of the county's general fund revenue. The county's projected general fund budget for fiscal year (FY) 2006-07 is \$11.5 million (WPCEDC, 2006).

Potential public service and fiscal impacts in White Pine County are of particular interest locally and within Nevada's state government as the county faced potential insolvency at the end of 2005 and came under the supervision of the Nevada Department of Taxation (WPCEDC, 2006). The threat of insolvency was averted with increased revenues, including tax increases allowed under state law to resolve a severe financial condition, a franchise fee imposed by the county, layoffs, and substantial budget reductions. Fortunately, the county

and State Department of Taxation were able to avoid closure of county services and facilities; however, the county remains under the supervision of the state and will continue to do so until it is clear that the financial issues have been resolved and the county has policies and procedures in place to support its financial health.

3.17.5.1 Taxable Sales

The current sales and use tax rate in White Pine County is 7.125 percent (effective October 1, 2006). The base sales tax rate in Nevada is 6.5 percent. In White Pine County, an additional 0.25 percent is imposed for public mass transportation and construction of roads; 0.125 percent for extraordinary maintenance, repair, or improvement of school facilities; and 0.25 percent for the construction of a community swimming pool. Taxable sales in White Pine County in FY 2004-2005 were \$127.9 million, an increase of 58 percent compared to the previous fiscal year (Nevada Department of Taxation, 2005). By April 2006, fiscal year-to-date taxable sales in the county were \$145.3 million (WPCEDC, 2006). Based on the existing sales and use tax rate of 7.125 percent levied in White Pine County, the estimated tax revenue generated by taxable sales in the county in FY 2004-2005 was approximately \$9.1 million. Sales tax revenues are collected at the state level, with a portion of these revenues allocated to the State General Fund and the remaining revenues distributed back to local counties based on statutory formulas. White Pine County, like most rural Nevada counties, is guaranteed a base rate on sales tax revenues to keep revenues from falling below minimum levels. In 2004-2005, taxable sales in White Pine County generated an estimated \$2.6 million in State General Fund revenue, nearly

\$6.1 million in sales tax revenue distributions back to White Pine County, and about \$0.4 million in distributions to other Nevada counties. Distributions to White Pine County included local school support tax revenue (\$2.0 million, which is distributed to the local school district), basic and supplemental county relief tax transfers (\$3.3 million), and optional tax levies (\$0.8 million) (Nevada Department of Taxation, 2005). Based on inter-local agreements, tax revenues distributed to local counties by the state are also subsequently redistributed to local cities/townships and special districts.

3.17.5.2 Property Taxes

White Pine County also receives property tax revenue based on assessments of real and personal property in the county. In Nevada, assessed value is equal to 35 percent of taxable (or market) value. The total assessed value of personal and real property in White Pine County (after exemptions) was \$115.6 million in FY 2004-2005, an approximate 8.5 percent decline from the previous year (Nevada Department of Taxation, 2005). Recent estimates indicate the assessed value of property countywide reached \$230.7 million in 2006 (WPCEDC, 2006). Based on this recent figure and the average property tax rate in the county of 3.66 percent, the estimated property tax revenue generated in White Pine County is approximately \$8.4 million. Based on historic distributions of property tax revenues in the county, it is estimated that of this amount approximately \$3.9 million (or 45 percent) will be retained by White Pine County, with the remaining revenue distributed to the local school district, cities/towns, special districts, and the state.

One component of property taxes is the assessment of centrally-assessed properties, such as the proposed Station. In

FY 2004-2005, the assessed value of centrally-assessed properties in White Pine County was \$12.5 million (Nevada Department of Taxation, 2005).

3.17.5.3 Payments-in-Lieu-of-Taxes

White Pine County also receives “payments-in-lieu-of-taxes” (commonly referred to as PILT) from the federal government. PILT payments to counties are intended to help offset losses in property taxes resulting from nontaxable federal lands within their jurisdiction and are made available to help local governments carry out important public services. The U.S. Congress appropriates PILT payments each year. The formula used to compute the PILT payments is based on population, receipt sharing payments, and the amount of federal land within an affected county. As a result, PILT payments vary annually.

Approximately 93 percent of the land in White Pine County is administered by the federal government (the BLM, NPS, Forest Service, and FWS) and only 5 percent is owned by local government and the private sector (WPCEDC, 2006). In FY 2005-2006, White Pine County received approximately \$668,200 in PILT payments for the nearly 5.3 million acres of federal land in the county (BLM, 2006). This represents an average PILT payment of approximately \$0.13 per acre. Based on the amount of land administered by the BLM in the county (about 4.36 million acres), it is estimated that White Pine County received approximately \$550,000 in PILT payments attributed to BLM-administered lands in FY 2005-2006.

3.17.6 Housing

An overview of the existing housing stock in White Pine County, based on 2000 U.S. Census data, is presented in Table 3.17-7.

According to U.S. census data, the total housing stock in White Pine County in 2000 was 4,439 units. According to the White Pine County Assessor, the estimate of total housing stock in the county in 2000 was slightly lower at 4,200 units. As of July 2006, the County Assessor showed an increase in housing stock with 4,381 units in the county (WPCEDC, 2006).

Approximately half of these units are located in the City of Ely (2,177 units), followed by McGill (609 units), Ruth (212 units), and Lund (85 units). In addition, housing projects currently proposed to be developed within the next 2 years would add up to approximately 170 new housing units in the Ely/Ruth/McGill area (Rajala, 2007). The existing housing supply in the county accounts for less than 1 percent of the statewide housing stock.

In 2000, vacancy rates in the county varied considerably between owner-occupied and renter-occupied units, ranging from 6.7 percent to 23.8 percent, respectively. This pattern holds in the City of Ely as well, although there is a

slightly lower vacancy rate for owner-occupied units (4.9 percent) and slightly higher rate (25.4 percent) for rental units. Vacancy rates at the state level are substantially lower relative to White Pine County.

The median value of a home in White Pine County and the City of Ely were comparable at \$70,000 and \$71,300, respectively, in 2000. By 2005, the median value of a home in Ely increased substantially to \$152,500 (WPCEDC, 2006); however, local home values are roughly half that for the state as a whole. Rental rates in the City of Ely are less than rental rates across Nevada (approximately \$600 per month) (WPCEDC, 2006).

Temporary housing in the county is also provided by a combination of motel rooms and RV parks. According to the White Pine County Chamber of Commerce, White Pine County has 629 motel rooms and 209 RV park spaces, most of which are located in the Ely area (White Pine County Chamber of Commerce, 2006).

TABLE 3.17-7
Housing Characteristics (2000)^a

Area	Housing Stock ^b	Vacancy Rate		Median Value ^c	Median Rent ^c
		Owner	Rental		
White Pine County	4,439	6.7%	23.8%	\$70,000	\$452
City of Ely	2,205	4.9%	25.4%	\$71,300	\$444
State of Nevada	827,457	2.6%	9.7%	\$142,000	\$699

Source: U.S. Census Bureau 1990a, 1990b, 2000a, 2000b

^a Data presented in this table do not reflect economic activity generated by the recent re-opening of the Robinson Mine.

^b More recent information on the county's housing stock is available from the White Pine County Assessor; this information is reflected in the text presented in Section 3.17.6.

^c Median value and rent are based on sample data (DP-4)

Activity in the housing market has increased in recent years with the number of housing sales doubling between 2000 and 2004 (WPCEDC, 2006). The status of the current housing market has been affected by the recent re-opening of the Robinson Mine, including lower vacancy rates and increases in property values. However, and according to WPCEDC (2006) and Rajala (2006), a review of new housing starts data shows that 92 percent of the county's housing stock was built prior to 1978 and many of these homes were painted with lead-based paint. Rural Nevada still does not have any certified lead-based paint abatement contractors to carry out the provisions of lead-based paint regulations. Realtors report that they are already having difficulty getting financing through the Federal Housing Administration for homes with lead-based paint. Thus, the county is currently experiencing a housing shortage (particularly affordable housing) which in turn negatively affects recruiting of new employees. Another factor contributing to the affordable housing shortage is the deterioration of manufactured housing stock in the county and the lack of adequate regulations to prevent importation of older, single-wide manufactured housing into the county that no longer meets code requirements in other areas.

3.17.7 Community Infrastructure and Public Services

The proposed Station and associated ancillary facilities would be located on undeveloped, rural lands in White Pine County. While no public facilities would be directly affected by the physical development of the Proposed Action or Alternative 1, some of White Pine County's public services would likely be affected during construction of the Station

(see Section 4.7, *Visual Resources*). The following types of public services could be affected: law enforcement, fire protection, emergency medical services, other medical aid, education and schools, solid waste disposal, and water, wastewater, and power utilities (Impacts on parks and recreation facilities are addressed in Section 4.8, *Recreation Resources*). Existing characteristics of these services are described below.

3.17.7.1 Law Enforcement

Law enforcement in the county is provided jointly by BLM (on public lands), the White Pine County Sheriff's Department (on public roads and private lands), the Nevada Highway Patrol (on state highways), and the NDOW (on public lands). The Sheriff's Department is expected to be the primary source of law enforcement at the Station site. The Sheriff's Department, which is located in and contracts law enforcement services to the City of Ely, is the only full-service law enforcement agency in White Pine County and provides patrol and jail services. White Pine County is served by 15 patrol officers, five dispatchers, five jailers, and one part-time deputy (WPCEDC, 2006). The capacity of the local jail is 40 people (32 male and 8 female). The Sheriff's Department feels an expansion of its jail capacity is currently needed because of an increase in its inmate population and a trend of arrests increasing over time (Rajala, 2006). For example, the average inmate population in 2005 was 17.4 compared to 14 in 2001. Misdemeanor and felony arrests increased by 138 percent over the same time period.

The Sheriff's Department also experienced an increase in law enforcement demands during two large construction projects in the past 20 years—the construction of Ely State Prison in the late 1980s and the construction

of the mill at Robinson Copper mine in the mid 1990s. In both instances, the Sheriff's office reported an increase in the number of criminal investigations during construction followed by a sharp decline in the number of investigations following completion of the construction projects. In 1987 and 1988, the Sheriff's office reported 238 and 244 criminal investigations, respectively, followed by a decrease to 214 investigations in 1989 when the prison was opened. In 1995 and 1996, the Sheriff's office reported 390 and 433 investigations, respectively, followed by a decline to 367 investigations in 1997 when the mine was in full operation (Rajala, 2007).

The county's juvenile detention facilities are in a state of disrepair, and as a result, are not used. Juveniles requiring protective custody are transported to facilities in Elko and Lincoln Counties (WPCEDC, 2006).

The response time to the proposed White Pine Energy Station from the Sheriff's Department in Ely would be approximately 30 minutes (Rajala, 2005).

Based on the county's most recent budget data, law enforcement-related expenditures in the county are projected at approximately \$2.5 million in FY 2006-2007 (Rajala, 2007).

3.17.7.2 Fire Protection

Wildland fire protection on public lands in White Pine County is primarily provided by the BLM. The BLM's Ely District implements a fire management program in accordance with the *Ely Managed Natural and Prescribed Fire Plan*.

Structural fire protection on private lands is the responsibility of the White Pine County Fire District, which was formed under the provisions of NRS 474 and operates in cooperation with the Nevada Division of Forestry. The District includes seven

volunteer fire departments: Snake Valley (Baker), Ruth, McGill, Lackawanna (vicinity between Ely and McGill), Lund/Preston, Cold Creek (northern Newark Valley), and Cherry Creek. The McGill and Cherry Creek Volunteer Fire Departments would provide the initial response to an incident at the Station site, and as needed, backup would be provided from the other rural fire departments and the City of Ely Fire Department. Fire protection services are dispatched through the White Pine County Sheriff's Department.

The nearest fire station to the proposed Station site is the McGill Fire Department, 23 miles away. The McGill Fire Department consists of approximately 20 volunteer firemen, and it maintains two structure trucks, one wildland fire truck, and two medical chase vans. It is also equipped with eight self-contained breathing apparatus (SCBA) units. All of the McGill volunteer firemen have completed the Fire Fighter I training program, and they participate in a variety of training programs each year including HAZMAT training. Response time between McGill and the proposed Station site is estimated at 10 to 35 minutes depending on weather conditions (Rajala, 2005).

All of White Pine County's volunteer fire departments face a continuing concern associated with the difficulty of recruiting and retaining volunteers. The demands for additional training place a notable strain on volunteers who are attempting to maintain and improve levels of service. Concerns also are increasing over worker safety with respect to potential accidents involving hazardous materials (WPCEDC, 2006).

White Pine County maintains an inter-local agreement with the City of Ely for law enforcement, fire protection, and animal control services. For the 2006-07 budget, the City of Ely is scheduled to pay White

Pine County about \$600,000 for law enforcement through the County Sheriff's Department, with the County paying roughly \$170,000 for fire protection at the County Airport and in the unincorporated areas immediately surrounding Ely and \$22,000 for animal control services; the net payment from the City of Ely to White Pine County is nearly \$400,000 (Rajala, 2007).

3.17.7.3 Emergency Medical Services

Emergency medical services provided in the county are supervised by the White Pine County Ambulance Service, recognized as an Intermediate Ambulance Service by the State of Nevada. The Service and all volunteer Emergency Medical Technicians (EMTs) are licensed by the Nevada State Health Division. Transports are assigned to William Bee Ririe Hospital by medical direction. Volunteer emergency medical services are provided in the communities of Ely, Ruth, McGill, Baker and Lund, and are dispatched by the White Pine County Sheriff's Department.

McGill Emergency Medical Service is the closest to the Station site and would be the first service paged to respond to a Station-related incident. It maintains two ambulances that are licensed by the State of Nevada. Response times to the Station site would vary from 10 to 35 minutes depending on the weather. The other service centers are paged for backup as needed. Several area firemen are also licensed EMTs. Local fire departments act as first responders for all emergency medical calls and provide assistance with lifting, extrication, traffic, and crowd control. As warranted, patients may be stabilized at William Bee Ririe Hospital and sent to urban hospitals for specialized treatment via life flight. AccessAir out of Elko, Nevada, may be used in severe emergencies and

flight times to the Station site from Elko could be as short as 20 minutes.

As with the volunteer fire services, the White Pine County Ambulance Service faces continuing concerns about recruitment and retention. In addition, response times and availability of McGill EMTs may vary during the daytime hours when volunteer EMTs are at their places of employment.

3.17.7.4 Other Medical Aid

The nearest medical facility to the proposed Station power plant is William Bee Ririe Hospital, a "critical access hospital" in Ely. The hospital is approximately 34 miles from the Proposed Action power plant site and 22 miles from the Alternative 1 power plant site. This facility is a fully accredited 40-bed hospital providing in-patient medical, surgical, obstetrical, and intensive care unit services. The hospital also provides long-term care, out-patient services for surgery, physical therapy, respiratory therapy, and 24-hour physician-attended emergency room services. All physicians in White Pine County are employed by William Bee Ririe Hospital. The hospital also owns and operates the William Bee Ririe Medical Rural Health Clinic, which was completed in 2000. Plans have been approved for expansion and remodel of the hospital. The current utilization rate at the William Bee Ririe Hospital is 16 percent (WPCEDC, 2006).

William Bee Ririe Hospital and the Hospital Clinic maintain visiting services from specialists including cardiologists, orthopedic surgeons, and internists who provide visitation and medical services on an itinerant basis. Area physicians may send patients via life flight or referral to surrounding urban hospitals in Salt Lake City, Las Vegas, or Reno. Flight times vary and may be as short as 45 minutes, but average 1 to 2 hours.

3.17.7.5 Education and Schools

White Pine County is served by public elementary, middle, and high schools. Four elementary schools are located in the county, in the communities of Baker, Lund, McGill, and Ely. One middle school and high school are located in Ely, the primary population center in the county. Another high school is located in Lund. Total enrollment in the White Pine County School District in the 2006-07 school year was 1,429 students, which is approximately 53 percent of the total school district capacity of 2,680 students. One high school is also located at the prison and one alternative education high school is located in Ely; these facilities would not likely be affected by the proposed Station.

Table 3.17-8 summarizes school enrollment and capacity in White Pine County.

TABLE 3.17-8
School Enrollment and Capacity (2006-07)

School	Capacity	Enrollment
David E. Norma Elementary	700	415
Baker Elementary	4	21
McGill Elementary	350	137
Lund K-12	250	109
White Pine Middle School	600	323
White Pine High School	600	402
NOVA	20	13
Murray Street	120	0 (Vacant)
Out of State Students*	N/A	24
Total	2,680	1,429

Source: Rajala, 2007

*Of the 24 out-of-state students, 8 are in elementary schools, 5 are in middle school, and 11 are in high school. It is not possible to determine which schools they attend based on student records.

The average expenditure per pupil in the county was \$4,786, which was greater than the state average of \$3,751 (WPCEDC, 2006). School enrollment in the District dropped about 4 percent between 2003 and 2004 and remains lower than historic levels when the Robinson Mine was in full operation (WPCEDC, 2004). This indicates a shift to a senior and retirement population and away from young families with school-aged children. However, this trend has reversed with the recent re-opening of the mine. School enrollment increased slightly by four students from the 2003-04 to 2005-06 school years.

No schools are located in the immediate vicinity of the Station project area. The nearest school (McGill Elementary School) is in the town of McGill, approximately 22 miles south of the Station Proposed Action power plant site. The nearest secondary schools are in Ely, approximately 34 miles away.

3.17.7.6 Social Services

As summarized in the 2006 WPCEDC CEDS report (WPCEDC, 2006), social services in the county are provided by a variety of state and county agencies as well as by private, voluntary groups. White Pine County does not have a homeless, transient, or battered women's shelter. Emergency financial assistance is available through the county Social Services Department and Salvation Army. These financial services consist of emergency shelter (via a motel voucher program), food, transportation, rental deposit assistance, and medical and burial assistance. Food stamps are available through the Nevada Department of Human Resources, Food Stamps and Welfare Divisions. The Women and Infant Children Supplemental Foods Program provides nutrition education and assistance

in purchasing certain types of food for low-income families with infants and pre-school children. A variety of other services are provided by Support, Inc., the White Pine Rehabilitation and Training Center, a number of church organizations, and Little People's Headstart, which provides childcare services for low-income parents.

The county's social services director has reported that in the past, when large construction projects are hiring workers, some of the people coming into the area looking for work need social services; in fact, this is occurring now with the mine and prisons currently hiring people (Rajala, 2006). Most of these people are transients, and if they cannot find employment, they typically need money for lodging (before they move on), food, and transportation. Also, new hires in the region often need assistance between the time they start their job and their first paycheck to cover deposits for renting apartments or to help pay for food, clothing, etc.

3.17.7.7 Solid Waste Disposal

Solid waste in the Ely, Ruth, and McGill areas of White Pine County is disposed of at the City of Ely Landfill, an active Class I facility that was permitted in 1998. Currently, the Ely landfill processes approximately 25 tons of solid waste per day and has a total capacity of approximately 1.86 million cubic yards for all types of waste. Recently, the City of Ely has received a Class III Landfill Permit to expand the landfill facility to accommodate construction waste; the estimated available capacity for construction-related waste is 300,000 cubic yards (Rajala, 2006). According to the 2004 Solid Waste Management Plan, the projected closure date for the landfill is 2081 (Nevada Division of Environmental Protection,

2004). However, the landfill is using its capacity at a faster rate than anticipated and there has been an identified need to develop an alternative landfill site to accommodate the future needs of the local population and construction projects (WPCEDC, 2006).

White Pine County's 2006 Solid Waste Management Plan Revision was approved by the Nevada Division of Environmental Protection (NDEP) in September 2006. The revised Plan includes the future development of a private Class III landfill at the Station site.

3.17.7.8 Road Maintenance

The primary road to be used by Station construction and operation traffic is U.S. 93, which is maintained by the Nevada Department of Transportation. Also during construction, several White Pine County Roads may be used to transport mineral materials to the plant site. The most likely of these County Roads are White Pine County Road 27, White Pine County Road 24 (Monte Neva Road), and White Pine County Road 18. These county roads are well maintained gravel roads.

Traffic is sparse on highways through White Pine County, and Nevada Department of Transportation figures show they all have capacity to carry more traffic than currently uses them (WPCEDC, 2006). When improvements and maintenance are needed, a portion of the gasoline tax levied on gasoline purchases in the county is allocated to the Regional Transportation Commission to fund road improvement projects for the City of Ely and the county.

3.17.7.9 Utilities

3.17.7.9.1 Water and Wastewater

No public water supplies or sewer systems are currently located in the Station project area, and none would serve the Station during construction or operations. Instead, private ground water wells supply potable water in the Station project area and on-site septic systems are used to treat and dispose of wastewater.

Public water and sewer service are available in larger communities. Service providers include the Ely Municipal Water Department, McGill-Ruth Sewer and Water General Improvement District, and the Baker Water and Sewer General Improvement District. The capacity of these public water/sewer systems is as follows (Rajala, 2007):

- City of Ely. Water capacity is 640 to 1,334 residential equivalents (1.5 gallons per minute). The range is based on the potential loss of one well. Sewer capacity ranges between 460 and 1,460 residential equivalents (which is equal to 400 gallons per day). This range is based on NDEP rated treatment capacity at 1.5 million gallons per day versus operator estimate at 1.1 million gallons per day.
- McGill. Water capacity is 227 residential equivalents with the largest well out (1.0 gpm/residential equivalent metered). Sewer capacity is 117 to 185 residential equivalents.
- Ruth. Water capacity is 122 residential equivalents based on the largest pump out scenario. Sewer capacity ranges from -1 to 14 residential equivalents.

3.17.7.9.2 Power

The proposed Station is in the service area of the Mt. Wheeler Power Company, a

rural electrical power cooperative serving areas within White Pine and Eureka Counties, as well as portions of western Utah. Mt. Wheeler Power operates under an "All Requirements Contract" with its power supplier. Power loads of 2.5 MW and larger must be supplied via a negotiated contract (Robison, 2007). Mt. Wheeler Power has no power generation of its own, but has contracts that should meet current and future demands for power in their service area (WPCEDC, 2006). Natural gas service is not provided in White Pine County.

3.18 Transportation

This section discusses existing roadways that could provide access to the White Pine Energy Station Proposed Action and Alternative 1 power plant sites for project construction workers, construction materials and equipment deliveries, and project operation personnel.

The Proposed Action power plant site is located approximately 34 miles north of Ely, 22 miles north of McGill, and 1 mile west of U.S. 93. The Alternative 1 power plant site is located approximately 22 miles north of Ely, 10 miles north of McGill, and 1 mile west of U.S. 93.

Access to either power plant site would be from U.S. 93. Paved access to these power plant sites does not currently exist.

Workers, materials, and deliveries could originate from many cities during project construction and operation. Potential source towns and cities were identified and freeways/highways associated with them were considered potential routes to

be evaluated. Table 3.18-1 lists the source towns and cities and the associated roadways that are discussed in this section.

U.S. 6 is an east-west highway that connects SR 318 with Ely. U.S. 50 is an east-west highway that intersects with U.S. 93 at Ely.

U.S. 93 is a north-south highway that intersects with I-15 in southeastern Nevada and continues north into Idaho. It also intersects with I-80 in the northeastern part of the state, U.S. 50 in the east-central part of the state at Ely, and SR 318 in southeastern Nevada.

The Level of Service (LOS) of a roadway is a grading system for the amount of traffic congestion on the road. LOS "A" is the least amount of congestion and LOS "F" refers to the greatest amount of congestion (see Table 3.18-2). Roadway design capacity for the LOS considers speed limits, the number of lanes, curves, hills, width of lanes, and shoulder slope (Leegard, 2007).

TABLE 3.18-1

Potential Source Towns and Cities for Project Construction and Operation Personnel and Associated Roadways to the White Pine Energy Station Project Sites

Town/City	Freeway/Highway
Elko, Nevada	I-80 and U.S. 93
McGill, Nevada	U.S. 93
Wells, Nevada	I-80 and U.S. 93
West Wendover, Nevada	I-80 and U.S. 93
Wendover, Utah	I-80 and U.S. 93
Salt Lake City, Utah	I-80 and U.S. 93
Ely, Nevada	U.S. 93
Eureka, Nevada	U.S. 50 and U.S. 93
Austin, Nevada	U.S. 50 and U.S. 93
Pioche, Nevada	U.S. 93
Las Vegas, Nevada	I-15 and U.S. 93 or I-15, U.S. 93, SR 318, and U.S. 6

TABLE 3.18-2
Roadway Levels of Service

Level of Service	Description
A	Free flow with low volumes and high speed
B	Reasonably free flow, but speeds beginning to be restricted by traffic conditions
C	In stable flow zone, but most drivers are restricted in the freedom to select their own speeds.
D	Approaching unstable flow; drivers have little freedom to select their own speeds.
E	Unstable flow; may be short stoppages
F	Unacceptable congestion; stop-and-go forced flow.

I-15 is the main north-south route connecting Las Vegas, Nevada, and Salt Lake City, Utah. I-80 is an east-west interstate freeway that traverses Nevada in the northern part of the state. SR 318 is a north-south highway that connects U.S. 93 with U.S. 6.

Characteristics of these roadways (existing LOS, average daily vehicle traffic [ADT] volumes, estimated recent average daily truck traffic [ADTT] volumes, estimated 2007 ADT and ADTT volumes, peak hour traffic volumes, peak hours, roadway classification, number of traffic lanes, and roadway condition) are presented in Table 3.18-3. The existing LOS for all of the sections of roadway identified in Table 3.18-3 is A (Leegard, 2006; 2007).

The county roads that could potentially be used during construction to transport mineral materials to the plant site are White Pine County Road 27, White Pine County Road 24 (Monte Neva Road), and White Pine County Road 18. Traffic along these roads is light and generally results

from use by several homeowners along the Monte Neva Road, ranching equipment, and recreational users.

The Nevada Northern Railroad (NNR) is an existing, but currently inactive, north-south rail line that is located west of the Proposed Action and Alternative 1 power plant sites. This inactive section extends from Cobre, Nevada, to McGill, Nevada. The NNR line lies within approximately 1 mile of the Proposed Action power plant site and within approximately 2 miles of the Alternative 1 power plant site. The NNR would be used to deliver coal via rail spur to either power plant site for operation.

Through years of inactivity, the railroad is no longer capable of supporting rail traffic. Independent of the White Pine Energy Station, the railroad is now proposed to be rehabilitated and operated by the City of Ely and the White Pine Historical Railroad Foundation. It is intended to serve as both a freight line and a tourist attraction. The proposal is to rehabilitate the rail to a Federal Railroad Administration Class III rating. This rating would also be required to accommodate coal train traffic. Several sidings would be provided to allow the passage of trains. A description of the proposed 110-mile (Shafter to McGill Junction) rehabilitation and its associated potential impacts are addressed in an environmental assessment (David Evans and Associates, Inc., 2002) that was prepared in support of a grant application to the U.S. Department of Commerce, Economic Development Administration, by the City of Ely.

TABLE 3.18-3

Roadway Characteristics of Potential Routes to the Alternative Project Sites

Roadway Name	Existing Level of Service (LOS) ^a	2004 ADT ^{b,c}	Estimated 2004 ADTT ^d	Estimated 2004 Peak Hour Traffic ^e	Estimated 2007 ADT ^f	Estimated 2007 ADTT ^g	Estimated 2007 Peak Hour Traffic ^h	Peak Hours ^e	Roadway Classification ⁱ	Roadway Condition ^j
U.S. 6 north of intersection with SR 318	A	1,350	265	68	1,301	255	65	Morning: 6-7 Daily: 3 p.m. Afternoon: 5-6	Other Principal Arterials	Good
U.S. 50 east of SR 376	A	590	116	30	632	124	32	Morning: 6-7 Daily: 3 p.m. Afternoon: 5-6	Other Principal Arterials	Good
U.S. 50 east of Eureka	A	1,800	353	90	1,929	378	96	Morning: 6-7 Daily: 3 p.m. Afternoon: 5-6	Other Principal Arterials	Good
U.S. 93 south of junction with U.S. 93A at Lages Station	A	1,250	245	63	1,465	287	73	Morning: 6-7 Daily: 3 p.m. Afternoon: 5-6	Other Principal Arterials	Good
U.S. 93 near McGill	A	1,562	306	78	1,831	359	91	Morning: 6-7 Daily: 1 p.m. Afternoon: 4-5	Other Principal Arterials	Good
U.S. 93 near Pioche	A	1,335	231	80	1,431	248	86	Morning: 6-7 Daily: 1-3 p.m. Afternoon: 4-5	Other Principal Arterials and Minor Arterials	Good
U.S. 93 near SR 318	A	1,650	323	83	1,768	347	88	Morning: 6-7 Daily: 3 p.m. Afternoon: 5-6	Other Principal Arterials	Good
U.S. 93A south of West Wendover	A	440	76	22	516	89	26	Morning: 6-7 Daily: 3 p.m. Afternoon: 5-6	Minor Arterials	Good
I-15 near Las Vegas	A	19,668	1,947	983	22,790	2,256	1,139	Morning: 5-6 Daily: 3-5 p.m. Afternoon: 5-6	Interstate Highways	Good

TABLE 3.18-3

Roadway Characteristics of Potential Routes to the Alternative Project Sites

Roadway Name	Existing Level of Service (LOS) ^a	2004 ADT ^{b,c}	Estimated 2004 ADTT ^d	Estimated 2004 Peak Hour Traffic ^e	Estimated 2007 ADT ^f	Estimated 2007 ADTT ^g	Estimated 2007 Peak Hour Traffic ^h	Peak Hours ^e	Roadway Classification ⁱ	Roadway Condition ^j
I-80 east of Elko	A	5,161	511	258	5,161	511	258	Morning: 6-7 Daily: Noon Afternoon: 5-6	Interstate Highways	Good
SR 318 near Sunnyside Road	A	1,070	210	54	1,223	240	61	Morning: 8-9 Daily: Noon Afternoon: 5-6	Other Principal Arterials	Good

Source:

^a Leegard, 2006; 2007.

^b NDOT, 2005a (for U.S. 6, U.S. 50, U.S. 93, SR 318, and I-80).

^c U.S. Department of Transportation, 2001. Calculated for I-15 based on Clark County population estimates and population growth.

^d NDOT, 2005b. Calculated by reviewing the Nevada Roadway Functional Classification Map and multiplying the ADT by the statewide truck and passenger car percentages for rural roads (U.S. 6, U.S. 50, U.S. 93, and SR 318), and for urban roads (I-15 and I-80).

^e NDOT, 2005c. Determined by reviewing the Annual Hourly Day of Week Summary for 2004 Reports. In some cases where data were not provided, peak hours were assumed to be similar to other highways, and peak hour traffic was assumed to be 5 percent of ADT.

^f Calculated U.S. 6, U.S. 50, U.S. 50, and SR 318 by reviewing historical (1995 – 2004) AADT records and applying the average growth rate to 2004, 2005, and 2006 to calculate the estimated 2007 ADT. Calculated I-15 and I-80 by reviewing historical (2001) AADT records and applying the Clark County and Elko County population growth rates for 2001-2004, and applying the applicable growth rate to calculate the estimated 2007 ADT.

^g Calculated by applying to the 2007 ADT the same percentage as determined applicable for footnote "d".

^h Calculated by applying to the 2007 ADT the same percentage as determined applicable for footnote "e". In some cases where data were not provided, peak hour traffic was assumed to be 5 percent of ADT.

ⁱ Determined by reviewing the Nevada Roadway Functional Classification Map.

^j Assumed to be good condition.

