





**WORKS OF
PROFESSOR CECIL H. PEABODY**

PUBLISHED BY

JOHN WILEY & SONS.

Thermodynamics of the Steam-engine, and other Heat-engines.

This work is intended for the use of students in technical schools, and gives the theoretical training required by engineers. 8vo, cloth, \$5.00.

Tables of the Properties of Saturated Steam and other Vapors.

These tables were prepared for the use of students in technical schools and colleges, and of engineers in general. 8vo, cloth, \$1.00.

Valve-gears for Steam-engines.

This book is intended to give engineering students valve-gears for steam-engines. Second Edition, Revised and Enlarged. 8vo, cloth, \$2.50.

Steam-boilers.

By Prof. CECIL H. PEABODY and Prof. EDWARD F. MILLER. Nearly 400 pages; 142 illustrations. 8vo, cloth, \$4.00.

Manual of the Steam-engine Indicator.

154 pages; 98 figures. 12mo, cloth, \$1.50.

Naval Architecture.

v+616 pages; 217 figures. 8vo, cloth, \$7.50.

VALVE-GEARS

FOR

STEAM-ENGINES

BY

CECIL H. PEABODY

*Professor of Naval Architecture and Marine Engineering
Massachusetts Institute of Technology*

SECOND EDITION, REVISED

FIRST THOUSAND



NEW YORK

JOHN WILEY & SONS

LONDON: CHAPMAN & HALL, LIMITED

1906

TJ547
P36

LIBRARY of CONGRESS
Two Copies Received
FEB 23 1906
Copyright Entry
Feb. 10, 1906
CLASS *a*, Xxc. No.
138262
COPY B.

Copyright, 1890, 1906

BY

CECIL H. PEABODY

ROBERT DRUMMOND, PRINTER, NEW YORK

6-6755

PREFACE.

THIS book is intended to give engineering students instruction in the theory and practice of designing valve-gears for steam-engines. With the vast number of valves and gears in use at the present time, an exhaustive treatment in a text-book appears out of place; the author's aim is rather to give the learner a firm grasp of the principles and some facility in their application. Each type discussed is illustrated by one or more examples selected from good practice.

Graphical methods are used throughout, in the body of the book, both for demonstration of principles and for design of gear. In an appendix analytical demonstrations are given of certain principles that cannot be treated in a complete and satisfactory manner by construction only. Zeuner's valve-diagram is used because it is widely and favorably known and appears to the author to be at least as good as any other circular diagram.

In the discussion of radial valve-gears, the underlying principles found in all such gears are pointed out, and a few prominent forms are illustrated. All such gears have necessarily or designedly large irregularities in their motions, so that analytical methods are useless if not misleading, and general methods of treatment are of small value. Facility in design is to be obtained through experience only.

Drop cut-off gears are represented by a few examples chosen

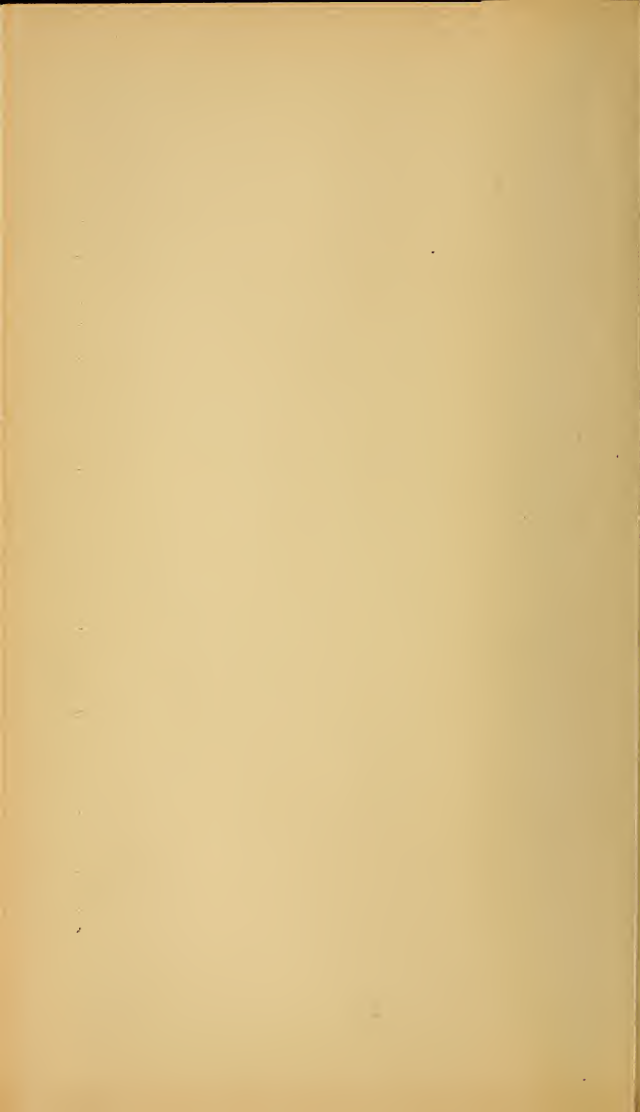

VALVE-GEARS FOR STEAM-ENGINES.

CHAPTER I.

PLAIN SLIDE-VALVE.

THE valve-gear of a steam-engine consists of the valve, or valves, for admitting steam to, and exhausting steam from, the cylinder of the engine, together with the mechanism for giving motion to the valve, or valves. The discussion of valve-gears is therefore a part of kinematics or mechanism; the extent and importance of the subject make a separate presentation of it desirable.

The larger part of valve-gears derive their motion from one or more eccentrics; of such gears, the plain slide-valve is the simplest. Other valve-gears are best studied after an examination of the plain slide-valve, since they accomplish the same results, and by analogous methods.

Slide-valve Engine.—A plain slide-valve engine has two trains or systems of moving parts, the piston, piston-rod, connecting-rod and crank, and the eccentric, eccentric-rod, valve-spindle and valve. These parts are represented in Figs. 1, 2 and 3 of Plate I; the engine-frame is omitted from the figures to simplify them and to concentrate attention on the moving parts, in which we are now interested.

The piston, half of which is represented in Fig. 2, is subjected to steam pressure on its right-hand side and presses the

piston-rod toward the left. The piston-rod is joined to a cross-head H (partly obscured by the valve-spindle), which moves in straight guides. The right-line reciprocating motion of the cross-head is transformed into a rotating motion by the connecting-rod L , which takes hold of the crank-pin C . At O is the centre of the engine-shaft, to which are keyed the crank OC and the eccentric E . The eccentric-rod l transforms the rotating motion of the eccentric E into the reciprocating motion of the head h of the valve-spindle, and the valve-spindle communicates that motion to the valve V . The valve is in this case placed at the side of the cylinder because the side-elevation brings the centre-lines of the moving parts into a simple relation, shown by Fig. 4, and this representation of the problem will be considered to be the normal case to which all other cases are assimilated, whatever variations may be found in actual practice. In the side-elevation, Fig. 1, the valve-chest cover is removed to show the valve, and the upper part of the valve is represented to be cut away to show the steam-passages.

Fig. 2 gives a horizontal section of the half cylinder, steam-passages, valve and valve-chest. In the design of a plain slide-valve it is customary to represent it in section, as in Fig. 3, which is drawn to a larger scale, with the valve in its middle position.

Crank and Connecting-rod.—The crank, connecting-rod and cross-head, in its guides, form a train of mechanism known as a sliding-block linkage. In Fig. 4, OC is the centre-line of the crank and CH is that of the connecting-rod; the point H is constrained to move on the line OX .

In designing valve-gears two problems may arise in the train made up of the crank, connecting-rod and cross-head, with its attached parts, the piston and piston-rod. They are (1) given the piston-displacement to find the crank-angle; and, conversely, (2) given the crank-angle to find the piston-displacement. Both are habitually solved graphically. In Fig. 4 first find the beginning of the stroke of the cross-head by laying off OA equal to

the length of the crank plus the length of the connecting-rod. From A lay off AH equal to the piston-displacement. With A as a centre and with a radius equal to the length of the connecting-rod, draw an arc cutting the circular path of the centre of the crank-pin at C ; then COA is the crank-angle. Conversely, lay off the crank-angle AOC , and, with C as a centre and the length of the connecting-rod as a radius, intersect the path of the cross-head at H ; then AH is the displacement of the cross-head and the piston. The centre-line of the cylinder is intended to pass through the centre of the shaft; small deviations are commonly ignored.

Eccentric and Eccentric-rod.—The eccentric is derived from the crank by the expansion of the crank-pin till it includes the shaft and obliterates the crank. Consequently the eccentric and eccentric-rod form sliding-block linkage.

The length of the eccentric-rod is commonly from 12 to 20 times the eccentricity, and the deviation of the true motion from harmonic motion is small and can usually be neglected. Should it be desirable in any case, the true motion can be determined graphically by the method given for the crank and connecting-rod.

Problems in valve-gears are solved by special methods to be described later; a solution of such problems involving an extension of the graphical method of page 2 will be given on page 5 in connection with the valve-ellipse.

The Slide-valve.—Fig. 3 gives the section of a plain slide-valve and its seat. The *ports* a, a_1 lead to the two ends of the cylinder; the *exhaust-space* s is connected with the exhaust-pipe; the *bridges* b, b_1 separate the ports from the exhaust-space. The steam-pressure in the steam-chest holds the valve against the seat and prevents leakage. The valve-seat is cut away so that the valve may over-travel its seat at the ends and thus both valve and seat may wear evenly. The edges of the ports and of the valves are machined and finished true; for convenience

in the work, the edges of the ports and the inside edges of the valve are undercut as shown.

The valve, when in its mid position, commonly overlaps both inside and outside edges of the ports. The amount, o , by which it laps over the outside edge of the port is called the *steam-lap* of the valve; the amount, i , by which it laps over the inside edge of the port is called the *exhaust-lap*. In the typical case represented by Fig. 3 the valve is exposed to the steam-pressure on the outside, and the exhaust-cavity and the exhaust-port are inside; in some cases this arrangement is reversed. In any case the steam-lap is the distance that the valve must be moved from middle position to let steam into the cylinder, and the exhaust-lap is the distance it must be moved to open the port to exhaust. The exhaust-lap may be nothing or negative. In the latter case the valve is said to have a clearance.

In Fig. 2 the valve is shown admitting steam to the end of the cylinder remote from the crank, called the head end; and it is exhausting steam from the other end of the cylinder, called the crank end. The valve is usually set in such a manner that when the engine is on a dead-point the valve is open by a small amount called the *lead*. For this purpose the eccentric is set ahead of the crank 90° plus the angle δ , called the *angular advance*. This definition applies only to the typical case represented by Fig. 4; a more general definition will be given later. As the crank moves forward the valve opens more and more till the centre of the eccentric comes to the line of centres, then the valve begins to return and it shuts the port before the stroke of the piston is finished. The stroke of the piston from the head end to the crank end of the cylinder is called the *forward stroke*; the *return stroke* is made from the crank end to the head end. The valve is open by the amount of the lead at the beginning of the return stroke, and at the same time the exhaust is open for the head end. As in the forward stroke, the valve first opens wider as the stroke proceeds, then it returns and closes the port before the piston reaches the end of the stroke.

Events of the Stroke.—When the outside edge of the valve is at the edge of the port, as shown by Fig. 4, Pl. II, and the valve is opening, *admission* is said to occur. This happens just before the stroke commences. When the valve is in the same position, but is closing, *cut-off* takes place. At either position the displacement of the valve is equal to the steam lap; consequently we have the following principle:

When the displacement of the valve is equal to the steam lap, the engine is either at admission or cut-off.

Release occurs when the inside edge of the valve is at the edge of the port and the valve is opening to exhaust, as shown by Fig. 5, Pl. II.

Compression occurs when the valve is at the same position but is closing the exhaust. At either position the displacement of the valve is equal to the exhaust lap; consequently we have:

When the displacement of the valve is equal to the exhaust lap, the engine is either at release or at compression.

Valve-ellipse.—The following method will be found convenient for studying the action of a valve, especially when its motion is irregular. Take first the typical case represented by Pl. I, where the centre-lines of the crank and connecting-rod and the eccentric and eccentric-rod coincide in the side elevation. Choose any piston-displacement and lay off AH , the displacement of the cross-head, equal to it; with the length of the connecting-rod as a radius cut the circular path of the crank-pin at C , thus determining the crank-angle COA . Make COF a right angle and lay off the angular advance FOE . With E , the centre of the eccentric, as a centre and with a radius equal to the length of eccentric-rod, cut the path of the end of the valve-spindle at h . Then ah is the displacement of the valve from its middle position, corresponding to the piston-displacement AH . In Fig. 1, Pl. II, take AA' to any convenient scale to represent the stroke of the piston; lay off the piston-displacement AH

of Fig. 4, Pl. I, from A to the scale chosen and erect the ordinate Hh equal to the corresponding valve-displacement to any desired scale, not necessarily the same as the scale of abscissæ. Very commonly the length of AA' is taken arbitrarily five or six inches while the ordinates are laid off full size. A sufficient number of points like h are constructed, with ordinates above the axis for displacements of the valve to the left of the middle position, and ordinates below the axis for displacements to the right. A smooth oval may be drawn through the points thus located, by aid of which the valve-displacement corresponding to any piston-position may be determined directly. Conversely, the piston-position can be determined for any valve-displacement; thus, if a valve-displacement Ao is taken, the corresponding piston-position, found by drawing a horizontal line, and an ordinate at the intersection with the oval, may be 0.88 of the forward stroke.

The oval of Fig. 1, Pl. II, is very irregular because both connecting-rod and eccentric-rod are short. If the length of the eccentric-rod is fifteen (or more) times the eccentricity, the valve-displacement may be found with sufficient approximation by making it equal to Oe in Fig. 1, Pl. I, found by dropping Ee perpendicular to the axis XX . In such case the oval will be less irregular than that of Fig. 1, Pl. II. If both the piston-motion and the valve-motion are harmonic, the oval becomes an ellipse like that drawn with a dotted line in Fig. 1. Though the figure is always an oval in practice, on account of the irregularity of motion due to the connecting-rod, it is customary to call it the valve-ellipse.

To use the valve-ellipse (or oval) for studying the valve-motion it is customary to draw horizontal lines oo' and o_1o_1' parallel to the axis AA' at distances equal to the steam-laps. In the figure these are equal. In like manner the lines ii and i_1i_1' are drawn at distances equal to the exhaust-laps. It has already been pointed out that a valve-displacement equal to the steam-lap will bring the edge of the valve to the edge of the port and that the valve is in such position when it is (1) opening at

admission or (2) closing at cut-off. An inspection of the figure shows that head-end admission occurs at 0.02 of the stroke before the dead-point, and that head-end cut-off occurs at 0.88 of the stroke, during the forward stroke. The crank-end admission comes just before the dead-point, and crank-end cut-off comes at 0.72 of the stroke, during the return stroke. Head-end compression occurs at 0.17 and head-end release at 0.98 of the stroke; and crank-end compression comes at 0.06 and release at 0.92 of the stroke. The lead for the forward stroke is on , and for the return stroke $o_1'n'$. The inequality of the leads is due to the short eccentric-rod; in practice such an inequality does not occur, first, because the eccentric-rod is longer, and, second, because the usual method of setting the valve makes the leads equal.

The valve-ellipse may be advantageously used to investigate the action of a valve having an irregular motion, such as is given by some special valve-gears to be studied later, and it should be drawn during the design of the valves for every important engine. The motion of valves of an existing engine may be investigated by causing the engine to draw its own valve-ellipse. For this purpose, a reduced copy of the piston-motion, obtained by aid of a pantograph or otherwise, may be communicated to a slip of paper on which is pressed a pencil that derives its motion across the slip of paper from the valve-gear. The oval thus drawn will have the piston-displacements for abscissæ and the valve-displacements for ordinates, and should be identical with the valve-ellipse drawn to the same scale; any discrepancy must be due to mechanical defects in the valve-gear.

Sinusoidal Diagram.—A diagram called by this name, because the curves resemble sinusoids, was devised by Moll and Montéty for use in designing valve-gears, taking account of the irregularities of both the piston and the valve. Starting at A , Fig. 2, Plate II, the crank-angles are laid off as abscissæ toward A'' ; and both the piston-displacement and the valve-displacement for a given crank-angle are laid off as ordinates, thus giving two curves,

$AA''A''$, representing the piston-motion, and $nm'n$, representing the valve-motion. The dotted lines are true sinusoids, and would represent the piston- and valve-motions if both were harmonic. The lines $oo'o$, $o_1o_1'o_1$ are drawn to represent the steam-laps, and the lines $ii'i$, $i_1i_1'i_1$ to represent the exhaust-laps, which may or may not be equal. Inspection of the diagram shows that cut-off occurs at the crank-angle 133° , and at a piston-displacement equal to ab . Conversely, if the cut-off is desired to take place at the piston-position ab , draw the line $b'b''$ parallel to AA'' and at a distance from it equal to the desired piston-displacement; from b , the intersection with the curve of piston-displacements, draw the ordinate ab ; then ac is the lap which will give the desired cut-off. It is convenient to draw the curve of piston-displacements on a sheet of paper on a drawing-board, and to draw the curve of valve-displacements, which may be extended to give about one and a half revolutions, on a piece of tracing-paper or tracing-cloth. By superimposing the tracing of the valve-displacements on the drawing of the piston-displacements, and slipping it along as desired, the effect of using different values for the angular advance may be readily determined; at the same time the effect of different laps may be determined, or the lap for a special purpose may be found.

This diagram cannot be conveniently substituted for the valve-ellipse, since it does not present to the eye the character of the valve-motion combined with the piston-motion; a valve-ellipse can readily be drawn from the sinusoidal diagram

Zeuner's Diagram.—In the design of a plain slide-valve, and the greater part of all steam-engine valves, it is customary to proceed as if the motion of the valve were harmonic; if any correction is required it is left as an adjustment to be provided either in the completion of the design or in setting the valve. A number of arbitrary circular diagrams have been devised for the purpose of designing slide-valves; though differing in appearance they are essentially similar in principle and any one can be used

to solve all the problems that arise in practice. The most commonly used circular diagram is one devised by Zeuner; it would be desirable that some one diagram should be accepted by engineers to avoid labor and misunderstanding.

Zeuner's diagram is represented by Fig. 7, Pl. II, where XOX' and OY are a pair of rectangular axes, and the crank is given a left-handed rotation, as shown by the arrow; this arrangement corresponds to the trigonometrical convention and is often chosen whatever may be the actual construction of the engine. The angle $YOP = \delta$, equal to the angular advance, is laid off toward the crank; OP is made equal to the eccentricity, and on it is drawn the *valve-circle* ONP ; then the valve-displacement for a given crank-angle θ is equal to the chord ON , cut off by the valve-circle from the centre-line OR of the crank.

A geometrical proof may be made by first locating the centre of the eccentric at p on the line Op which makes the angle $90^\circ + \delta$ with the position of the crank; for harmonic motion the valve-displacement is On , found by dropping a perpendicular from p onto the axis XX' . Now draw the line PN , making the angle at N a right angle because it lies in a semicircle. The two right-angle triangles OPN and Opn are equal because they have the sides OP and Op equal and the angles PON and pOn are both equal to $180^\circ - 90^\circ - \delta - \theta$. Consequently ON is equal to On equal to the valve-displacement.

For comparison with certain future work, notably on link-motions, it is worth while to notice that if On is represented by e , and the eccentricity by r , we have

$$e = r \sin(\theta + \delta),$$

as given by equation (6), page 123.

Attention should be called to the facts that the diagram is entirely arbitrary, that it gives a correct result, and that it is found in practice to be very convenient; and that these considerations justify its use.

The valve-circle of Fig. 7, Pl. II, represents the motion of the valve to the *left* from middle position, and back again to middle position. It is clear that the chord cut from the centre-line of the crank will increase in length as OR approaches OP , and that the length of the chord will be zero when OR is at right angles to OP , for which crank-position the valve will be in mid-position. Fig. 1, Pl. III, gives two valve-circles, one above the axis which gives valve-displacements to the left, and one below the axis which gives displacements to the right. By the aid of this latter diagram the entire action of the valve may be represented in detail.

Across the upper valve-circle is drawn an arc oo' , with a radius equal to the steam-lap that controls the flow of steam to the head end of the cylinder; this cuts the valve-circle at two points, through which are drawn the crank-positions OA_k and OC_k . At A_k the valve-displacement is just equal to the steam-lap and the valve is at admission in the position represented by Fig. 4, Pl. II, moving to the left to open the valve, as is evident from a consideration of the arrangement of the mechanism of Fig. 1, Pl. I, and also from the fact that as the crank moves toward the left the length of the chord cut from the crank by the valve-circle increases. At the dead-point OX , the valve-displacement is equal to $On = Oo + on$, that is, to the lap plus on , the lead; the valve is in the position shown by Fig. 3, Pl. II. As the crank moves forward the valve moves farther to the left and opens the port wider till the maximum displacement is attained, when the crank coincides with OP ; the valve is then in a position represented by Fig. 6, Pl. II, giving the maximum port-opening $o'P$, which in this case exceeds the width of the port. As the crank moves forward from the position just considered, the displacement decreases and the valve moves toward the right until at C_k the edge of the valve comes again to the edge of the port, but the valve now closes the port and interrupts the flow of steam to the cylinder; this action is known as cut-off.

Another arc, ii' , is drawn across the upper valve-circle, with a radius equal to the crank-end exhaust-lap, which controls the flow of exhaust from the crank end of the cylinder. A line OK_c drawn through the intersection of this arc with the valve-circle shows the crank-position when the displacement of the valve is equal to the exhaust-lap, and the valve is in the position represented by Fig. 5, Pl. II, moving to the right to close the valve and interrupt the exhaust at compression. The valve now closes the ports at both ends of the cylinder so that steam cannot enter or leave, and that condition persists till the valve opens for release at the head-end at the crank-position R_h ; this crank-position is drawn through the intersection of the lower valve-circle with the head-end exhaust-lap arc drawn through i'' . In this case the two steam-laps and the two exhaust-laps are equal; sometimes the laps are unequal, in which case the head-end steam-lap and the crank-end exhaust-lap, both drawn across the upper circle as in Fig. 1, Pl. V, are usually the larger. In any case the lap-arcs may be restricted to the circle to which they belong to avoid possibility of confusion.

The events of the stroke thus far considered are admission just before the forward stroke begins, cut-off which commonly comes after half stroke, and crank-end compression and head-end release toward the end of the stroke. Having the crank-end steam-lap arc drawn through o'' the other events of the stroke are admission at A_c , cut-off at C_c , head-end compression at K_h and crank-end release at R_c ; the valve is displaced to the right at all these events; at admission the valve is moving toward the right, but at the other events the valve is returning toward the left.

Though it is not customary to do so, the two arcs ll'' , $ss's''$ may be added to find the crank-positions at which the edge of the valve is on the further edge of the port, and the port is wide open. The radius Ol' is made equal to the width of the port plus the steam-lap; when the crank-position passes

through t or t'' the displacement of the valve is equal to the lap plus the width of the port and the port is then wide open. In like manner the radius Os' is made equal to the width of the port plus the inside lap, and when the crank-position passes through s or s'' the port is wide open for exhaust.

The diagram shows that the outside edge of the valve over-travels the edge of the port by the amount $t'P$. Some over-travel is desirable, as it gives in general a better action to the valve. The over-travel of the valve for exhaust is $s'P$, which is greater than $t'P$ by the amount of the difference of the steam- and exhaust-laps. The amount by which the port is open at any position of the valve is called the port-opening. The maximum port-opening for supply, which occurs when the crank coincides with OP , is equal to $o'P$, the difference between the eccentricity and the lap. The maximum port-opening for exhaust is equal to $i'P$. In this case the maximum port-openings are greater than the width of the port. A slide-valve moved by an eccentric always has the maximum port-opening for exhaust at least as great as the width of the port, and it is commonly greater; the maximum port-opening for supply is also commonly greater than the width of the port, but it is sometimes less. A slide-valve moved by a gear that gives a variable cut-off, as will be seen later, may have both maximum port-openings less than the width of the port for some settings of the gear.

An inspection of the diagram Fig. 1, Pl. III, will show that a change of the steam-lap will affect both admission and cut-off; thus, the cut-off is hastened and the admission is delayed by an increase of the steam-lap, and conversely the admission comes earlier and the cut-off comes later if the steam-lap is decreased. In a similar way, increasing the exhaust-lap delays the release and hastens the compression, while decreasing that lap produces a contrary effect. Since it is the relative proportions of lap and eccentricity which determine the cut-off, it is apparent that decreasing the eccentricity with a constant lap

produces the same effect as increasing the lap with a constant eccentricity; i.e. it hastens the cut-off and delays the admission. Finally, it will be seen that increasing the angular advance hastens all the events of the stroke; and that decreasing the angular advance delays all the events of the stroke.

Should the exhaust-lap of the valve be made nothing, so that in mid-gear its acting edge coincides with the edge of the port, then both compression and release will occur when the crank is at right angles to POP' . Sometimes, in designing or remodelling a valve, it will be found advisable to give a *clearance* to the valve instead of an exhaust-lap, as represented by Fig. 2, Pl. IX, in which case the valve must be displaced to the *right* to bring the crank-end exhaust-edge of the valve to the edge of the port as is indicated by Fig. 3. Compression consequently comes at OK_c drawn through the intersection of the lower valve-circle with the crank-end exhaust-clearance arc. Conversely, release, which is controlled by the head-end exhaust-edge of the valve, will occur when the valve is displaced to the left an amount equal to the head-end exhaust-clearance and will come *before* the crank-end compression. In order to emphasize the fact that the change from exhaust-lap to exhaust-clearance on the crank-end of the valve shifts the construction as shown in Fig. 1, Pl. IX, to the lower valve-circle, the construction for head-end release is omitted; it can be made by drawing the exhaust-clearance arc for the head-end of the valve across the upper circle, and will indicate that release comes between OC_h and OK_c . It is very important that the effect of giving the valve a clearance shall be clearly understood so that confusion cannot arise either in this place or in future work.

Expansion and Compression.—From cut-off at OC_h (Fig. 1, Pl. III) to release at OR_h , the head-end of the cylinder is shut off from both the supply and the exhaust. While the crank moves forward from C_h to R_h , the piston moves a corresponding amount, and the steam in the cylinder expands and experiences

a loss of pressure in consequence; this action is called the expansion. When the valve closes the exhaust at OK_h , the steam then caught in the cylinder is compressed ahead of the piston till a new supply of steam is admitted at OA_h ; this action is called the compression. For the crank-end of the cylinder, in a like manner, steam is expanded from OC_c to OR_c , and is compressed from OK_c to OA_c .

Lead and Lead-angle.—The lead, or the amount that the valve is open when the engine is on a dead-point, varies with the type and size of the engine, from a very small amount (or even nothing) up to half of an inch or more. Stationary engines running at slow speed may have from $\frac{1}{8}$ to $\frac{1}{16}$ of an inch lead. The effect of compression is to fill the waste space at the end of the cylinder with steam; consequently engines having much compression need less lead. Locomotive-engines having the valves controlled by the ordinary form of Stevenson link-motion may have a small lead when running slowly and with a long cut-off, but when running at high speed with a short cut-off the lead is at least $\frac{1}{4}$ of an inch; and locomotives that have a valve-gear which gives constant lead commonly have $\frac{1}{4}$ of an inch lead.

In the solution of problems it is sometimes convenient to use the *lead-angle*, A_hOX , Fig. 1, Pl. III, instead of the *lead on*. The lead-angle is likely to vary from zero to 8° ; $2\frac{1}{2}^\circ$ is a convenient angle for the solution of problems.

Problems on the Slide-valve.—By assuming various elements of the valve-gear to be known a series of problems relating to the plain slide-valve may be stated and solved. A few of these problems which will be stated and solved are of real importance to the engine-designer.

PROBLEM I. *Given the eccentricity, the lead-angle and the crank-angle at cut-off, to find the angular advance, the lap and the lead.*

In Fig. 1, Pl. IV, draw, to any convenient scale, the arc

XCX' to represent the path of the crank, referred to the axes XOX' and OY . Lay off the angle XOA equal to the lead-angle, and lay off XOC , the crank-angle at cut-off. Should the piston-position at cut-off be given instead of the crank-angle, find the crank-position OR_c corresponding by the method used for the valve-ellipse, p. 5. With equal leads the laps and crank-angle at cut-off will be the same for each stroke, and the mean piston-position will be nearly equal to the piston-position at cut-off with harmonic motion. In such case the crank-angle at cut-off may be found by laying off Xr equal to the given piston-displacement at cut-off and drawing the vertical line rC .

Bisect the angle AOC and draw the line OP ; on it draw the valve-circle $OoPo'''$, and through the intersections of this valve-circle by the lines OA and OC draw the lap-arc oo''' . The lead is $o'a$.

In Fig. 1 the eccentricity is $1\frac{1}{2}$ of an inch, the cut-off is at $\frac{3}{4}$ of the stroke, and the lead-angle is $2\frac{1}{2}^\circ$. The lap is $\frac{2}{3}\frac{2}{3}$ of an inch, and the lead is $\frac{1}{8}$ of an inch; the angular advance is $\delta = 31\frac{1}{4}^\circ$.

PROBLEM II. *Given the eccentricity, the lead, and the crank-angle at cut-off, to find the angular advance and the lap.*

In Fig. 4, Pl. IX, lay off the angle XOC equal to the crank-angle at cut-off, and draw the arc CPb with a radius equal to the eccentricity. From b draw an arc with a radius equal to the lead, and from C draw CA tangent to that arc. Draw a line OA through the point A , and bisect the angle COA by the line OP perpendicular to CA . Draw the lap-arc mng , which will touch the line CA at the point n ; it may be noted that the triangle AOn is equal to the right triangle OPg formed by drawing the line Pg , because they have the sides OP and OA equal and have the angle POA in common, and consequently On is equal to Og .

The construction gives of for the lead which must be equal to the assumed lead, i.e. equal to be . To prove this equality draw the line Pf and drop the perpendicular bk from b onto OP , thus forming the two equal right triangles OPf and Obk , which

have the sides OP and Ob equal and the common angle POb ; the two sides Of and Ok are equal, and taking away the equals Oo and On there will remain

$$of = nk = be,$$

as required for the construction.

In the problem discussed the eccentricity is assumed to be known and direct solutions are readily found. Very often the designer has sufficient information to proceed in this way, or he may assume a series of values for the eccentricity and in a few minutes have a series of results from which he can select the eccentricity that will give satisfactory proportions for the valve.

Now the real object of the gear is to open the steam-port and the designer must decide whether the port-opening is sufficient and whether the valve opens and closes rapidly enough. Referring again to Fig. 1, Pl. III, it appears that the valve begins to open at OA_k and that the port is wide open when the crank reaches a position that can be located by drawing a line through O and t , because in that figure Oo' is equal to the lap and $o't'$ is equal to the width of the port. During this action the valve moves rapidly, and in like manner the valve moves rapidly while the valve is closing. After the port is wide open the valve moves more and more slowly till it stops when the crank coincides with OP , when the port-opening exceeds the width of the port by the amount $t'P$. Such a favorable action for the supply of steam is possible only for comparatively small and slow engines. Very often the maximum port-opening for large engines is from two-thirds to three-fourths of the width of the port. The maximum exhaust port-opening, which is greater than the steam port-opening, is always equal to the width of the port and usually larger.

The method of determining the area and thence the width of the port will be given on page 36. Having the width of the port, the designer may determine the desirable or the possible maxi-

mum steam-port opening. He may then determine the proper eccentricity by trial as just explained, or he may make a determination by the following method.

PROBLEM III. *Given the maximum port-opening, the crank-angle at cut-off, and the lead-angle, to find the eccentricity, the lap, and the angular advance.*

Assume an eccentricity, preferably a little larger than that required, and solve the problem by the method of Problem I, by drawing the crank-positions at OA and OC for admission and cut-off, and bisecting the angle AOC and drawing the valve-circle OP_1 . Draw the lap-arc qq'' , thus determining the maximum port-opening $q''P_1$. From this trial port-opening and eccentricity, and the desired port-opening, determine the proper eccentricity by the following proportion:

Assumed Required Assumed Required
port-opening : port-opening :: eccentricity : eccentricity ;

which is evident from the similarity of the figures.

In the case represented by Fig. 2, Pl. IV, the desired port-opening is $\frac{3}{4}$ of an inch; an eccentricity of $1\frac{3}{4}$ of an inch gave a port-opening of $\frac{2}{3}\frac{9}{2}$ of an inch, so that the proportion

$$\frac{2}{3}\frac{9}{2} : \frac{3}{4} :: 1\frac{3}{4} : e$$

gave

$$e = 1\frac{7}{16} \text{ of an inch.}$$

With this eccentricity the second valve-circle OP is drawn, from which all the elements of the valve may be taken.

In general, it is preferable to solve the proportion numerically, but if desired a graphical solution may be made as follows: Lay off the line $Oc_1 = q''P_1$, in a convenient position, and join e_1c_1 ; make Oc equal to the given maximum port-opening, and draw ce parallel to c_1e_1 ; then e is the centre of the required valve-circle and OP is the required eccentricity.

Modifications.—In general it is not of great importance that the cut-off shall occur exactly at the chosen crank-angle or piston-position, and it is seldom necessary to know the angular advance

except in drawing the valve-diagram. It is, however, very convenient if not necessary that the lead and lap shall be determined quantities stated in fractions of an inch that are commonly used in the machine-shop. By judicious modifications the designer may secure this for the valve without seriously affecting the point of cut-off. In Fig. 3, Pl. IV, the lap, Oo , is made $\frac{3}{4}$ of an inch, and the lead is $\frac{1}{8}$ of an inch. At a the vertical aP is drawn, and from O , with a radius equal to $1\frac{1}{2}$ of an inch, the vertical is intersected in P ; thus giving the diameter OP on which the valve-circle $OaPo''$ is drawn. The cut-off comes at the crank-position OC , corresponding to the piston-displacement Xr instead of $Xt = \frac{3}{4}$ stroke, as required.

The process of laying out a slide-valve will be considered in connection with the valve for equal cut-off.

Equalization of Cut-off at the Expense of the Lead.—Let it be assumed that the cut-off shall occur at a given piston-position for each stroke, taking account of the irregularity due to the connecting-rod. Draw the line xX' , Fig. 1, Pl. V, on which choose O for the centre of the crank and for the origin of coördinates, and draw the vertical axis YOY' . Draw the circle $XYX'Y'$, to any convenient scale, to represent the crank-circle. With a radius equal to the length of the connecting-rod, on the same scale, and with X and X' as centres, cut the centre-line $X'x$ at x and x' ; this will give the stroke of the cross-head, equal to the stroke of the piston. Lay off the point on the stroke at which cut-off is to occur on both strokes, and with these points as centres and the length of the connecting-rod as a radius intersect the crank-circle at C_h and C_c . In the figure the connecting-rod is taken to be five times the crank, and cut-off is assumed to occur at $\frac{3}{4}$ of the stroke. It is at once apparent that the crank-angles XOC_h and $X'OC_c$ are not equal, and OC_h and OC_c are not one straight line. Choose a small head-end lead-angle XOA_h ; in the figure it is 1° . Bisect the angle A_hOC_h , and draw the line POP , on which draw the two valve-circles as shown. The eccentricity

may be determined by a preliminary solution, assuming harmonic motion, as in Problem III, or the same solution may be made directly on the figure; if the latter method is used, confusion is liable to occur from the number of circles drawn, especially if the eccentricity is modified to get some convenient dimension; consequently it is better to make such a construction separately and transfer the results to the main diagram. Draw the lap-arc oo for the upper valve-circle, through the intersections of that circle by OA_h and OC_h ; and draw the lap-arc $o'o'$ for the lower valve-circle, through the intersection OC_e with that circle. The admission at OA_e occurs at the intersection of the lower valve-circle and the lap-arc $o'o'$; as a result the crank-end lead is large, if not excessive.

It is customary, in designing a valve for equal cut-off, to equalize the compression also. In Fig. 1 the compression is assumed to occur at $\frac{7}{8}$ of the stroke, or at the crank-positions OK_h and OK_e . The exhaust-laps are ii and $i'i'$, so that the release occurs at R_h and R_e . The point of intersection i of the line OK_h with the valve-circle may be determined by dropping a perpendicular Pi from P on OK_h . The valve-diagram in Fig. 1 gives the following dimensions:

Eccentricity.	$1\frac{1}{2}$ inch
Steam-lap, head-end.....	$\frac{51}{64}$ "
" crank-end.	$\frac{37}{64}$ "
Exhaust-lap, crank-end.....	$\frac{5}{16}$ "
" head-end.	$\frac{3}{64}$ "
Lead, head-end.	$\frac{1}{64}$ "
" crank-end.....	$\frac{15}{64}$ "

On account of the excessive crank-end lead which is likely to result when this method is applied to an engine which has a short connecting-rod, it is customary to make a compromise; the head-end lead is made as small as practice shows to be allow-

able and the crank-end lead is made as large as allowable; the head-end cut-off will then be longer than the crank-end cut-off, but the inequality will be less than if the leads were equal.

To Lay out a Slide-valve.—The valve for which dimensions were found in Fig. 1, Pl. V, is shown in section by Fig. 2. To lay out the valve, begin at the crank end and make $ab = \frac{3}{4}$ of an inch, equal to the crank-end steam-lap; make $bc = \frac{1}{8}$ of an inch, equal to the width of the port.

The greatest displacement of the valve, equal to the eccentricity $1\frac{1}{2}$ of an inch, will carry the point a to a' , and when the valve is in that position it must not overrun the edge of the bridge, but rather there must be width enough remaining to prevent leakage. The least width of bridge in the figure is $\frac{3}{4}$ of an inch, and the width of $\frac{1}{2}$ inch is chosen to insure a joint.

The crank-end exhaust-lap, $\frac{1}{8}$ of an inch, is laid off at cd . The greatest displacement of the valve will carry the point d to d' , and at that position of the valve the remnant of the exhaust-space should be at least as wide as the port, i.e. $\frac{1}{8}$ of an inch as shown. The exhaust-space is commonly made wider than this construction gives; it should not be unduly increased, since it will then make the valve large and the friction excessive.

The valve is completed by making the width of the bridge $\frac{1}{2}$ of an inch and of the port, $\frac{1}{8}$ of an inch, as shown. If the eccentricity, $1\frac{1}{2}$ of an inch, be laid off toward the left, from the right-hand edges of the valve, it will appear that the right-hand bridge is wider than necessary, and that the remnant of the exhaust-space, when the valve has its maximum displacement to the left, is greater than the width of the steam-port. No inconvenience will occur from such an excess of bridge or exhaust-space; but had the construction been begun at the right-hand, then both the bridge and the exhaust-space would be too narrow, which explains why the drawing is begun at the crank-end. For constructive reasons, the bridge for any slide-valve may be made wider than required to prevent leakage.

Fig. 3, Pl. V, gives the section (half-size) of a valve with equal laps, which will give the same average cut-off as the valve shown by Fig. 2; the cut-off at the head-end will be longer, and that at the crank-end will be shorter. The steam-lap for Fig. 3 is very nearly the mean of the unequal steam-laps of Fig. 2; and the exhaust-lap is very nearly the mean of the exhaust-laps of the same figure. Such a valve may be laid off, beginning at either end.

The height of the exhaust-cavity of the valve should never be less than the width of the steam-port; it may conveniently be made equal to the width of the port plus half the width of the bridge.

The method just given for laying out the slide-valve has the apparent inconvenience that the centre of the exhaust-space cannot be directly located on the assembly drawing of the engine. This difficulty is, however, only apparent, for the section of the valve is commonly drawn separately and at full size, and then can be transferred to the assembly drawing, which may be to any convenient scale. The results obtained by laying out the work on the drawing-board should always be checked by a numerical calculation; and if desired such a numerical calculation may be made first, but it should be checked by the subsequent laying out of the valve. Thus the width of the bridge should be greater than

$$1\frac{1}{2} - \frac{3}{4} - \frac{1}{8} = \frac{3}{4}, \text{ or nearly } \frac{3}{8} \text{ of an inch;}$$

and the exhaust-space should have a width of

$$\frac{5}{8} + 1\frac{1}{2} + \frac{1}{8} - \frac{1}{2} = 1\frac{3}{4} \text{ of an inch.}$$

Rocker and Bell-crank Lever.—In the work thus far it has been assumed that the centre-lines of the crank and connecting-

rod with the cross-head and piston, and of the eccentric and eccentric-rod with valve-spindle and valve, coincide in the elevation, as shown by Fig. 1, Pl. I. This assumption is convenient in giving the first description of the valve-gear and in discussing the action and the theory of the valve-motion; and the design of the valve is commonly carried on as though such a coincidence existed, the deviation from such a coincidence being considered only in the mechanical problem of laying out the mechanism of the engine.

If the centre-line of the valve-spindle passes through the centre of the shaft, and the eccentric-rod is connected directly to the valve-spindle, then the motion of both crank and connecting-rod, and eccentric and eccentric-rod, referred to their own proper axes, will be the same as already found, even though their centre-lines do not coincide. Such a lack of coincidence will make the angle between the eccentric and the crank more (or less) than 90° plus the angular advance, by the amount of the angle between the two centre-lines. This difference needs consideration only in the process of setting the valve; and if the angle between the centre-lines is small, it will require little or no attention at that time. Since such an arrangement involves a lack of parallelism between the paths of the valve and of the piston, the work of boring the cylinder and facing off the valve-seat is more troublesome, and other machine-work is more difficult, unless special processes are provided; consequently this arrangement is seldom adopted.

Very commonly the paths of the piston and the valve are parallel but do not coincide in the elevation; thus, the axis of the crank and connecting-rod with the cross-head and cylinder may be XX' in Figs. 2, 3, and 4, Pl. III, while the centre-line of the valve-spindle may be xx' in the same figures. In such cases a rocker or a bell-crank lever should be used to transmit motion from the eccentric to the valve.

The following method may be used in laying out a bell-

crank lever. Let A be the position of the end of the valve-spindle when the valve is in mid-position; lay off Aa and Aa' equal to the steam-laps of the valve, and with a radius equal to the length of the arm of the bell-crank lever draw arcs intersecting at C ; this gives the axis about which the bell-crank lever vibrates. This construction prevents the bell-crank lever from introducing any irregularity into the action of the valve at admission and cut-off, because the valve-spindle at those events has its proper displacement; irregularities at other times are of less consequence. In laying out such a gear for a locomotive with a rigid valve-spindle that extends directly from the end of the bell-crank lever or rocker to the valve-yoke, it is important to have the bending or lateral motion of the valve-spindle as small as possible; in such case the point C may be so chosen that the lateral motion of the end of the valve-spindle shall be half above and half below the line xx' .

With a radius equal to BC , the other arm of the bell-crank lever, draw an arc as shown, and draw a tangent to this arc from O . Draw perpendiculars OE and CB from O and C to this tangent; then EB is the length of the eccentric-rod; this construction tends to minimize irregularity due to the eccentric-rod and the rocker. If desired, the relation of the crank and eccentric may be found by laying off the angle $XOR = \delta$, the angular advance, since the crank is at that angle before the dead-point when the valve is in mid-position; the angle EOR will not be equal to $90^\circ + \delta$, but this is a matter that affects the valve-setting only, and even in that process the exact knowledge of the angle between the crank and eccentric is not of importance.

If it is considered of importance that the eccentric-rod shall be some definite length, then the centre C , on which the bell-crank lever vibrates, may be shifted so as to give that length. If C is to be shifted a short distance, then a line parallel to XX' may be drawn through B , and with a radius equal to the desired length of the eccentric-rod an arc may be drawn from E inter-

secting that parallel line at a point B' ; the whole bell-crank lever is to be shifted bodily to the extent BB' , and the length of the valve-spindle must be changed the same amount.

In the figure the arm CB is made $\frac{3}{4}$ of CA ; consequently the motion of the valve will be that which would be given by an eccentric equal to $\frac{4}{3}$ of OE if the connection were direct. In designing and laying out the valve it is treated as though it were moved by such an eccentric. The ratio of the arms may be made anything desired; they have commonly the same length.

In laying out a rocker, the process is the same as that just described for the bell-crank lever, except that the arm CB , Fig. 3, is laid off on the side opposite A , and the eccentric follows the crank.

Fig. 4 shows an equal-armed straight rocker with the centre of vibration C midway between the lines XX' and xx' ; it may be made a little longer if desired so as to give a construction equivalent to that shown by AA' , Figs. 2 and 3.

Angular Advance.—On page 4, angular advance is defined as the amount by which the angle between the crank and eccentric exceeds 90° , and that definition is correct and sufficient for the typical arrangement of Fig. 1, Pl. I; and as slide-valves are usually designed as though that arrangement were to be used, the definition stated is the one commonly given and accepted by engineers. As a matter of fact it is only in the process of setting the valve that a deviation from this definition is recognized, and the one condition that usually brings the deviation into prominence is the use of a rocker, which requires that the eccentric shall *follow* the crank by an angle equal to 90° *minus* the angular advance, as indicated on Fig. 4, Pl. III. Engine-setters are familiar with this condition and allow for it without special directions. A convenient mnemonic is to consider that the rocker reverses the motion of the valve and that to compensate, the eccentric must be reversed, i.e., shifted 180° . Sometimes, when a bell-crank lever or a rocker is used, as in Fig. 2 or Fig. 3,

Pl. III, the eccentric is not exactly 90° plus (or minus) the angular advance from the crank; or if the centre-line of the valve-gear is shifted a small angle from that of the crank and connecting-rod, as explained on page 22, the same condition arises. The deviation from the typical condition is usually small in such cases, and is not likely to be observed by the engine-setter; the engine-designer is liable to ignore the deviation if he gives it any thought.

If an exact definition is desired it may be derived from Figs. 2 and 3, Pl. III, and stated as follows: the angular advance is the angle the crank makes with its line of centre when the valve is in mid-position.

Equalization of Cut-off with Rocker.—In the directions for laying out a rocker or a bell-crank lever care is taken to avoid disturbing the valve-motion and for that purpose symmetrical constructions are used. Needless deviations from the methods given are likely to introduce undesirable irregularities into the valve-motion. On the other hand a judicious deviation from the symmetrical constructions may introduce a desirable irregularity into the valve-motion which can be used to off-set the irregularity of the piston-motion which is due to the connecting-rod.

The typical arrangement of the valve-gear represented by Fig. 1, Pl. I, with a long eccentric-rod, will give nearly a harmonic motion to the valve. If the valve has equal laps the port-openings will be equal but the piston-positions at cut-off will be very unequal. An attempt to equalize the cut-off at the expense of the lead (and also of the port-openings) has already been shown to be unsatisfactory. To Professor Sweet is due the idea, that by the use of a bent-rocker an irregularity may be purposely introduced into the valve-motion which may be made to equalize the cut-off without interfering with the equality of the lead; in this case the inequality of the port-openings may be excessive.

On Plate VI an example is given of such a use of a bent rocker to equalize the cut-off of a valve which is designed to give cut-

off at $\frac{3}{4}$ th stroke. In the first place the valve-circle is drawn as for harmonic motion for both piston and valve. That is, the diameter of the crank-circle XX' is divided into quarters and a vertical line through the $\frac{3}{4}$ ths mark N is drawn intersecting the crank-circle at C , and the crank-position OC is drawn; the dotted circle which represents the path of the eccentric happens to pass through N because the eccentricity was taken equal to one-half the crank. The crank-positions at admission OA_h and OA_c are also drawn and these remain fixed during the following constructions. Bisecting the angle A_hOC by the line OP determines the angular advance YOP , and on OP the valve-circle is drawn with the proper diameter, together with the lap-arc oo' which determines the lap for both ends of the valve for equal lead. The valve design is to be completed in the usual way and the valve and seat are to be laid out. The remainder of the discussion has to do with the design of the rocker and its effect on the motion of the valve.

The usual harmonic action of the valve with a symmetrical rocker will give cut-off at the head end when the piston is somewhat beyond $\frac{3}{4}$ th stroke, and the crank-end cut-off will come earlier than $\frac{3}{4}$ th stroke; the mean piston-position at cut-off will be very nearly at $\frac{3}{4}$ th stroke. The object of the use of the bent rocker is to bring the valve to the position of cut-off when the piston is at $\frac{3}{4}$ th stroke for both strokes of the engine. With the length of the connecting-rod as a radius and with X and X' as centres, determine the stroke xx' of the cross-head and divide it into quarters; with the $\frac{3}{4}$ th points as centres and the connecting-rod as a radius, determine the crank-positions C_h and C_c corresponding to the desired piston-positions at cut-off. Since a rocker is to be used the normal position of the eccentric is 90° minus the angular advance after the crank; the angle to use for this purpose is XOP . Laying off this angle to the right from OC_h gives Or_c for the corresponding position of the eccentric for head-end cut-off at $\frac{3}{4}$ th stroke; in like manner Or_a corresponds to

OA_b , Or_c' corresponds to OC_e and Or_a' corresponds to OA_e . With r_c' and r_a' as centres and with the length of the eccentric-rod as a radius, draw arcs intersecting at e ; then if a rocker be constructed in such a way that the end of the eccentric-rod is guided to e when the eccentric is at r_c' and r_a' (that is, when the crank is at C_e and A_e) and if the valve be so set that its displacement shall then be equal to the lap, the cut-off will come at $\frac{3}{4}$ th stroke of the piston and the engine will also have the desired lead. In like manner, with r_c and r_a as centres, strike arcs intersecting at e_1 ; this last is the point to which the end of the eccentric-rod must be guided in order that cut-off may come at $\frac{3}{4}$ th stroke for the head-end. With a convenient length for one arm of the rocker as a radius, draw arcs from e and e_1 intersecting at T_1 ; this will be a proper centre for the rocker, and from it the path of the end of the eccentric-rod may be drawn through e and e_1 . The other arm of the rocker will be turned downward and its length must be such that the valve-displacements corresponding to the positions e and e_1 shall be equal to the steam-lap. Draw the chord ee_1 ; half of this chord will be found to be greater than the steam-lap Oo , consequently the other arm of the rocker must be proportionately reduced. A convenient construction is to lay off qs from the middle of the chord equal to the lap and through s draw a line parallel to eT_1 , cutting the line T_1q at the point t ; then st is the proper length for the other rocker arm.

Thus far no attention has been paid to the position of the valve-spindle, and it is altogether likely that a position of the rocker corresponding to the trial centre T_1 will be practically inconvenient, and that the whole gear must be shifted to accommodate the location of the valve. Suppose that nn' is the desired position of the valve-spindle; draw a line W' parallel to this position and at a distance equal to tq , and from O draw an arc through T_1 cutting W' at T ; this will be the proper position for the centre of the rocker. The mechanism for the guid-

ance of the eccentric-rod is to be swung through the same angle T_1OT , so that the path of the end of the eccentric-rod will be found at cc_1c_1 , of which the middle point may be found by drawing an arc from the centre O through the middle point e_0 of the original construction and laying of an angle equal to T_1OT . The eccentric centre must move with the rest of the gear so that its position corresponding to c_1 will be r_a'' , with the angle $r_a'Or_a''$ equal to T_1OT . The construction is completed by drawing Ta_0 perpendicular to nm' and equal in length to ts , for the middle position of the lower arm of the rocker. The end of the rocker and the head of the valve-rod which communicates motion to the valve-spindle will move on the arc $b'b$, drawn with T as a centre; a and a' are the positions when the valve is at admission or cut-off. The extreme positions are b and b' , found by trial, which indicate that the port-openings are unequal. It may be desirable to construct a valve-ellipse, taking account of all irregularities of the entire mechanism of piston and valve-gear, from which it may be decided whether or not the design is sufficient. Should the port-opening at one end appear to be really insufficient, it will be necessary to take a larger eccentricity and repeat the construction.

Piston-valve.—If the section of a plain slide-valve and its seat, as shown by Fig. 3, Pl. I, be supposed to revolve about an axis xx' , there will be generated a piston-valve with its cylindrical seat. Such a valve is represented by Fig. 1, Pl. VII, which gives a section of the high-pressure cylinder and valve of the U. S. battle-ship *Massachusetts*. It will be seen that the outside shell of the cylinder, the lower cylinder-head, and the valve-chest form one casting, with feet attached for bolting to the engine-frame. A cylinder-liner is forced into and secured to the outer shell, with a space between to serve as a steam-jacket. The piston is of conical form, and the heads are shaped to correspond. Leakage by the piston is prevented by two packing-rings held in place by a junk-ring.

The piston-valve is in the shape of two pistons connected by a pipe or sleeve through which the valve-spindle passes. The valve-spindle is prolonged beyond the valve and attached to a small balancing-piston which relieves the valve-gear of the weight of the valve and attached parts; the upper end of the balancing-cylinder is connected with the exhaust. The valve-seat is formed by two short hollow cylinders, forced into the shell of the valve-chest. The space surrounding each half of the valve-seat is connected with and forms part of the port leading to the cylinder. The ports are cut through the cylindrical valve-seat as shown.

Steam is supplied to the middle of the steam-chest and is exhausted from the ends through pipes shown by dotted circles. This arrangement secures the advantages that the supply and the exhaust-steam are kept well separated so that heat cannot easily pass from one to the other, and the valve-rod stuffing-box is exposed to the exhaust-steam only; such an arrangement is not advisable for a cylinder in which there may be a vacuum, since the leakage of air inward, past the stuffing-box, is more troublesome than the escape of steam.

The valve is drawn in mid-position to show the relation of the laps and other properties of the valve, and it is consequently not in proper relation to the piston, but no confusion need come from this disposition. The laps controlling the admission and cut-off are by this arrangement placed inside, while the laps controlling the release and compression are outside. It will be noticed that the top-end steam-lap is the larger, while the top-end exhaust-lap is the smaller, and is here a negative lap or clearance. This arrangement is adopted to hasten the cut-off and compression on the down-stroke and delay them on the up-stroke, but is not carried far enough to produce complete equalization.

Leakage past the valve is prevented by packing-rings, like those of the piston, which form the acting-edges of the valve.

To prevent the valve-rings from springing into the ports, bridges are left as shown at *A*.

Double-ported Valve.—It is frequently difficult or impossible to get sufficient width of port for engines having a large cylinder diameter and short stroke, if the common plain slide-valve is to be used. Fig. 2, Pl. VII, shows a device, known as a double-ported valve, used in marine engineering to overcome this difficulty. Each passage leading to the cylinder has two ports, and two slide-valves, joined together in one casting, to control the flow of steam through those ports. The inner valve resembles the common slide-valve, except that there is a communication through the top between its exhaust-space e_0 and the exhaust-space e of the outer valve. The outer valve is elongated enough to leave a steam-space (a and a') to supply the inner valve; a bridge between e and a separates the exhaust of the outer valve from the steam-space of the inner valve, and is continued to the opening through the top of the inner valve. Fig. 3 gives, at the left hand, a transverse section through the exhaust-space e , and at the right, through the steam-space a . The space a is drawn down toward the middle of the valve as shown, so that the valve may be made compact while providing sufficient area for the flow of steam.

Allen or Trick Valve.—Fig. 4, Pl. VII, shows a valve which is so made that a double admission of steam takes place at and near cut-off and admission. It is used with the link-motion and other gears which give a variable cut-off with the slide-valve, and is intended to remedy the defects due to the slow motion imparted to the valve at those points when the cut-off occurs early in the stroke.

Through the body of the valve there is a passage ss' , and the valve-seat is cut away so that the distance from the outer edge of the passage to the edge of the valve-seat is equal to the steam-lap of the valve. If the valve is displaced toward the right by the amount of the steam-lap, the edge c of the valve is brought to the edge of the port a , and at the same time the edge of the

passage s' is brought to the edge d of the valve-seat. Consequently there is a double admission of steam to the port a , one in the usual way past the edge c , and the other under the right-hand end of the valve, past the edge d of the valve-seat, and through the passage $s's$. As the valve opens wider, the passage ss' is liable to be shut off by traversing past the farther edge of the port a , but when that happens the supply past the edge c is abundant. Near cut-off the passage ss' is open at s and gives a double supply of steam till cut-off occurs by the simultaneous coincidence of c with the edge of the port a , and of d with the edge of the passage s' . This principle has been applied to give double admission to piston-valves and other forms of valves, which appear to be different from Fig. 4, but which are essentially similar to it in this particular feature.

Balanced Valves.—When the difference of pressure between the steam- and exhaust-pipes is large, the force exerted to hold a plain slide-valve against its seat is very large, and the friction of the valve on its seat is excessive: This consumes a needless part of the work developed by the engine, throws a severe duty on the valve-gear, and makes it difficult to maintain the acting-surfaces of the valve and its seat in good condition. Various methods of relieving valves from part or all of the steam-pressure on them have been devised, resulting in what are called balanced valves.

The piston-valve (shown by Fig. 1, Pl. VII) is not pressed against its seat by the steam, and is consequently perfectly balanced. It is very commonly used for the high-pressure and intermediate cylinders of triple-expansion marine-engines, and on high-speed engines under the control of a shaft-governor. When well made, and provided with packing-rings, there is no more reason for leakage than exists with the piston of the engine. Small piston-valves are commonly made without packing-rings, and then depend on the fit in the valve-seat to prevent leakage. It is claimed that they do not leak when new, that the wear is

insignificant, and that both valve and seat may readily be renewed when necessary. It is, however, probable that such piston-valves do frequently leak in common service.

The double-ported valve (Figs. 2 and 3, Pl. VII) and the Allen valve (Fig. 4, Pl. VII) have part of the pressure on the back relieved, and are known as balanced valves. The double-ported valve has a shallow cylindrical recess turned in its back. In this is a short cylinder or ring that is pressed by springs against a finished surface on the valve-chest cover. A bronze ring fastened to the valve and bearing against the vertical ring or cylinder is intended to prevent leakage. Communication is opened between the enclosed space and the exhaust, so that the leakage may not accumulate in this space and destroy the balancing of the valve. The unbalanced pressure of the steam on the unenclosed part of the valve gives enough pressure against the seat to prevent leakage. The Allen valve is commonly wider (measured at right angles to the axis of the cylinder) than it is long, and consequently a rectangular balancing-frame is used to exclude pressure from part of the top of the valve. Leakage into the enclosed space is allowed to flow directly into the exhaust-cavity through a small round passage, shown by dotted lines.

All such devices are somewhat costly to make and troublesome to maintain in good condition, and if allowed to get out of condition are liable to a large loss from leakage directly into the exhaust.

Valve-setting.—A slide-valve is commonly set to give equal lead, or else equal cut-off. Sometimes the leads are made unequal, so as to partially equalize the cut-off; in this case the method of setting is like that used for equal lead, except that the lead at each end is made the amount determined on. If the cut-off is equalized by aid of a rocker or bell-crank lever, as shown on Plate VI, the valve is set to give equal lead.

As a preliminary to the setting of the valve, a method will be given for putting the engine-crank on the dead-centre.

To put an engine on the dead-centre. — In Fig. 1, Pl. VIII, let

the circle $C_0CC_0'C'$ be the path of the crank-pin, and let A_0A_0' be the stroke of the cross-head; while $abcd$ represents the edge of the fly-wheel or the face of the crank-disk, if the crank is so made. Set the engine with the cross-head near the middle of the stroke, and make reference-marks at A , or take measurements so that it may be set again in the same position. Make a reference-mark on the circle $abcd$, and on some fixed object as, at a and o . Turn the engine around till the cross-head again comes to A ; the crank will then be at C' , and the mark made at a will be found at c . Make another mark at a , and bisect the arcs abc and adc at b and d . It is apparent that the angular distance of b from a is equal to the angular distance of C' from C_0' ; consequently the crank will be at the dead-point C_0' , if the mark at b is brought opposite o . Also the crank will be at the dead-point C_0 when d is brought opposite o .

In this process, and during all the operations of valve-setting, the engine and the valve-gear should always be moved in the direction in which the engine is intended to run, so that the lost motion or back-lash may be taken up in the right way. Should the engine or the gear be moved too far at any time, it should then be turned back beyond the desired point, and again brought up to that point with a motion in the right direction. Should the elasticity of the engine-belt interfere with the convenient and accurate setting of the engine, it may often be possible to place a stick of timber under a fly-wheel arm, block up one end and place a jack-screw under the other, and so force the engine to the desired setting and hold it at will; or some equivalent device may be used.

To set a valve with equal lead.—First method.—Set the engine on a dead-point and give the eccentric the proper angular advance, as near as may be; making it too much rather than too little. Adjust the length of the eccentric-rod or of the valve-spindle to give the valve the proper lead. Move the engine forward to the other dead-point, and measure the lead; if it is not right,

then correct half the error by changing the length of the valve-spindle, and the other half by moving the eccentric. Repeat till the result is satisfactory.

If a valve-gear has a rocker, then the length of the valve-spindle should be such that the rocker may swing as designed; usually to an equal angle on each side of a perpendicular through its axis, to the centre-line of the eccentric-rod motion. In such case the eccentric-rod only should be changed in setting the valve; a small change of the valve-spindle may be allowed.

Second method.—A valve that has harmonic motion will give the same maximum port-opening for each stroke when set with equal lead. Such a valve may be set for equal lead by the following method.

Loosen the eccentric on the shaft, and turn it around till it gives the maximum port-opening first at one end and then at the other. If the maximum port-openings are not equal, make them so by changing the length of the valve-spindle by half the difference; this operation adjusts the length of the valve-spindle. When that adjustment is complete, set the engine on a dead-point and give the valve the proper lead by turning the eccentric on the shaft; this adjusts the angular advance. This method is convenient when it is difficult to turn the engine.

Valves which do not have harmonic motion cannot be so set; as examples, may be quoted a slide-valve having equal lead and with the cut-off equalized by aid of a rocker or bell-crank lever, and a valve controlled by a link-motion or a radial valve-gear; the two last forms will be described in future chapters.

To set a valve for equal cut-off.—With the crank on the head-end dead-point, give the eccentric the proper angular advance, and give the valve the proper lead. Move the engine forward till cut-off occurs, and measure the displacement of the cross-head from the beginning of the stroke. Move the engine forward, again, till cut-off occurs on the return stroke, and measure the displacement of the cross-head from the crank end of the stroke.

Should the cut-off be earlier at the head end than at the crank end the valve-spindle is too long; and conversely it is too short if the crank-end or return-stroke cut-off is the earlier. In either case, change the length of the valve-spindle by an amount which it is estimated will correct the inequality; it may be convenient to draw a valve-diagram to aid in making an estimate for a large engine. Set the engine again on the head-end dead-point, and adjust the lead by moving the eccentric. Try the cut-off again, and repeat till the result is satisfactory.

It is apparent that a valve that is designed for equal cut-off will be properly set if the leads are made what the design gives for them. When such information is at hand, the process of setting the valve will be the same as the first method except that the lead at each end is to be made the proper amount, with the addition that the displacement of the cross-head at cut-off is to be determined for each stroke, and the adjustment is to be completed by the method just given.

To set a valve with the steam-chest cover on.—It is customary to provide for setting certain valves for locomotive engines and some other engines, with the steam-chest cover on, and with steam up. In preparation the valve is set to give the proper lead at one end, as shown by Fig. 2, Pl. VIII, a centre-punch mark is made at a point on the valve-chest and another mark at a point on the valve-spindle, and a tram is made of the proper length to reach from mark to mark. The valve is in like manner set to give the proper lead at the other end and a second tram is made to reach from mark to mark, as indicated by Fig. 3. It is apparent that after such preparation the valve may be set to give the proper leads by aid of the trams when the valve-chest cover is in place and the valve itself cannot be seen, and that the valve-gear can be set by the first method to give equal leads, or any predetermined leads. The description with two trams is given because the method is more apparent on the diagrams; in practice it is customary to use one tram which is set with one point

on the valve-chest as in Fig. 2, and the other point of the tram determines a point on the valve-spindle which is marked with a centre-punch; with the valve in the position shown by Fig. 3 the same tram is used to locate another centre-punch mark on the valve-spindle; consequently the valve may readily be set to give the proper leads by aid of the tram and the two centre-punch marks on the valve-spindle when the steam-chest cover is in place.

It should be noted that the method of setting the valve with equal lead or equal cut-off insures that the action of the valve shall be what is desired when opening or closing. Any error of design due to the neglect of the angularity of the eccentric-rod is therefore transferred to some other part of the motion of the valve, namely, to a place where the valve is open or closed and any irregularity of motion is then of little consequence.

Areas of Steam-pipe and of Steam-ports.—The proper sizes of the steam-pipe and of the ports and passages for an engine are determined by comparison with successful engines. For this purpose it is customary to make a conventional calculation of the velocity of the steam through pipes and passages and to use such a conventional velocity for determining the areas of the sections of pipes and passages and of steam- and exhaust-ports.

To find the conventional steam velocity it is assumed that the cylinder is filled at each stroke of the engine, or, more properly, that the cylinder takes a volume of steam equal to the piston-displacement, by which term is understood the volume of a cylinder equal in diameter to the engine-cylinder and in length to the stroke of the engine.

Suppose, for example, that a certain engine having the diameter of the cylinder 18 inches and the stroke 3 feet, makes 75 revolutions per minute. The piston displacement will be

$$\frac{\pi}{4} \left(\frac{18}{12} \right)^2 \times 3 = 5.30 \text{ cubic feet,}$$

and the volume of steam assumed to be used by the engine per minute will be

$$2 \times 75 \times 5.30 = 795 \text{ cubic feet.}$$

If the steam-pipe has a diameter of 5 inches, its area will be about

$$\frac{3.1416}{4} \left(\frac{5}{12} \right)^2 = 0.136$$

of a square foot, so that the conventional steam velocity will be

$$795 \div 0.136 = 6000 -$$

feet per minute.

We may now use this velocity to calculate the steam-pipe and the ports and passages.

For example: The diameter of the steam-pipe of an engine having a diameter of 18 inches and a stroke of 3 feet, and making 75 revolutions per minute, should be five inches as determined by the following calculation.

The piston-displacement is

$$\frac{\pi}{4} \times \left(\frac{18}{12} \right)^2 \times 3 = 5.30 \text{ cubic feet;}$$

the volume of steam per minute is

$$2 \times 75 \times 5.30 = 795 \text{ cubic feet;}$$

and the area of the steam-pipe to give a velocity of 6000 feet per minute should be

$$\frac{795}{6000} \times 144 = 19.08 \text{ square inches;}$$

so that the diameter should be

$$\left(\frac{4}{\pi} \times 19.08 \right)^{\frac{1}{2}} = 4.93,$$

or very nearly 5 inches.

It is only with small and slow engines that a velocity as low as 6000 feet a minute will be found. Velocities as high as 8000 and 10,000 are common, and 12,000 feet per minute is not infrequent.

If the steam-pipe has considerable length, a small diameter with high velocity is to be avoided, if possible, to avoid excessive loss of pressure. If the diameter is smaller than advisable, it will be expedient to place a steam-drum near the engine, especially if the engine has a short cut-off.

The areas of ports and passages leading to the cylinder should be equal to that of the steam-pipe; and the areas of ports and passages leading from the cylinder should be double that area; a port or passage for both supply and exhaust is to be calculated for the latter. In some cases it is more difficult to provide sufficient areas for ports and passages than for the steam-pipe.

For example: The engine mentioned above should have the area of the port.

$$2 \times 19.08 = 38.16 \text{ square inches.}$$

Now, it is seldom possible to make the transverse length of the port equal to the diameter of the cylinder; $\frac{8}{15}$ of the diameter is not unusual. Using this proportion, the width of port will be

$$38.16 \div 14 = 2.65 \text{ inches.}$$

This calculation is made with the conventional velocity of 6000 feet per minute. Were the velocity taken at 12,000 feet per minute, the width would, of course, be half as much, namely, $1\frac{3}{8}$ inches.

When it becomes difficult or undesirable to give the slide-valve sufficient motion to open the steam-port wide for the supply, the maximum port-opening may be made from $\frac{1}{15}$ to $\frac{1}{10}$ the width of the port.

When special valve-gears are used that open the valve rapidly and close it promptly, the area of the ports and passages may be made smaller than the above methods provide, but such reduction should be made only with complete knowledge of the action of the valve and of the effect of the reduction on the flow of steam.

CHAPTER II.

ADJUSTABLE ECCENTRICS.

Reversing with Loose Eccentric.—The device shown by Fig. 4, Pl. VIII, was used for reversing some of the earliest locomotive and marine engines; it is to-day used for reversing small and unimportant engines, and, with some modifications to secure positive action, is used on engines of considerable power. As shown, the crank is at C , and the eccentric has its centre at E , so that the engine will run in right-handed rotation as shown by the arrow. The eccentric is loose on the shaft and has a pin at B , which engages with the end of a circular slot in a disk back of the eccentric, so that the eccentric is driven by the disk. To reverse the engine, it is stopped, and the eccentric or the engine is turned till the pin B engages with the other end of the slot at B' .

The valve-circles for forward and for backward motion are drawn at OP and OP' , and the lap-circle is mn_1n_2 ; the cut-off occurs at OR , on the forward stroke when running right-handed, and at OR' , on the forward stroke when running reversed.

In this chapter the engine-shaft is assumed to be located to the right of the cylinder and the crank in forward motion turns to the right, consequently the valve-circles come to the left of the vertical YY' , as shown in Fig. 4. This disposition has been chosen deliberately, so that the student may become familiar with both arrangements. The valve-circles for showing the other half travel of the valve are omitted to avoid confusing the diagram.

Shaft-governor.—At the present time a large number of engines of comparatively small power and high rotative speed are controlled by shaft-governors, which act directly on the valve of the engine. Fig. 1, Pl. XI, shows such a fly-wheel governor, which was formerly used on the straight-line engine. It is desirable for illustration because its parts are clearly distinguishable and because its action is easily understood. XX' is the centre-line of the cylinder, which lies to the left, and xx' is the line of the valve-spindle, which is moved by a shifting eccentric through the bent rocker CTa , designed by the method of page 25 to give equal cut-off and equal leads. The consequence is that when the crank is at C ready for the return stroke in right-handed rotation, the eccentric is at E and the centre-line to which the motion of the eccentric and eccentric-rod is referred is OS , making an angle SOX with the centre-line of the cylinder. As explained in connection with the discussion of the rocker, this peculiarity of the drawing of Plate XI is of importance in the design of the rocker and is not taken into account in the design of the valve; neither need it be taken into account in the explanation of the action of the fly-wheel governor, which would act in exactly the same way if there were no rocker and if the two lines XX' and OS coincided.

The essential parts of the governor are the weight W and the spring QL . The weight W moves at the end of the lever WNM , which is pivoted at N to one of the arms of the fly-wheel; the spring QL , (which is in compression), pushes through the bars LV and VM against the end M of the lever and tends to force the weight W toward the centre of the wheel. The eccentric is cast on to a diamond-shaped plate SV , which is pivoted at S to the hub of the fly-wheel and is pinned to the bar LV and VM at V . When the engine turns slowly, the weight W is pressed against the hub of the fly-wheel and the valve acts like a plain slide-valve with a fixed eccentric, giving a long cut-off; when the engine approaches its normal speed the centrifugal force of the weight W overcomes

the tension of the spring and the ball moves out from the hub and shifts the centre of the eccentric toward the shaft in such a way as to shorten the cut-off in a manner to be discussed later. It is to be borne in mind that the pivot S , the diamond plate SV , the weight W , the lever WM , the rods MV and VL , and the spring QL are all attached to the fly-wheel and revolve with it, usually at such a speed that they cannot be distinguished while the engine is running.

Suppose that while the engine is running at a certain speed with the weight W at a given distance from the shaft, the load on the engine is reduced; the effort which the steam at the given setting of the valve can exert, will be greater than necessary to do the work and the excess will be applied to increasing the speed of the engine, and in consequence the centrifugal force of the weight W will enable it to move out further, compressing the spring QL and forcing the eccentric toward the shaft, thus shortening the cut-off and adjusting the work of the engine to its load. Of course a contrary action will take place when the load on the engine is increased. It must be noted that the engine will always increase in speed as the load is reduced, so that the governor does not keep the engine at constant speed, but, rather, it restrains the variation of speed within certain predetermined limits.

The defect of all the earlier fly-wheel governors, like the one illustrated, was their tendency to shift the valve-gear too suddenly and too far if a sudden change of load occurred; the consequence was that the engine after such a change of load would slow down and speed up alternately for some time before it would settle down to the new conditions of service. To overcome this tendency inertia-governors have been devised with heavy moving-parts so hung that the centrifugal force increases but a moderate amount when the parts shift to adapt the work to the load. The increase of centrifugal force must move the heavy parts in order to shift the valve-gear and consequently violent fluctuations of cut-off are restrained, while at the same time the entire gear

can be so constructed as to avoid friction and be sensitive to small changes of load or steam-pressure.

In order that a shaft-governor may be able to control the valve of an engine, and maintain nearly uniform speed without being excessively large, the valve must be nicely balanced and must move freely. For this purpose it is customary to use piston-valves without packing rings; or if rings are used they are set at a determined diameter. Sometimes the packing-rings are transferred to the valve-seat and can be adjusted to the valve. If a flat valve is used, it is made double-faced, and runs between a fixed seat and a parallel plate or adjustable outside seat, so that it acts much like a piston-valve. Preferably the valve should take steam in the middle so that the valve-spindle shall run in exhaust-steam and be easier to keep tight without excessive pressure on the packing.

Shifting Eccentric with Variable Lead.—A shifting eccentric, like that shown by Fig. 1, Pl. X, may be used for reversing an engine, and it possesses also the property of giving a variable cut-off. The eccentric is swung on a pivot (located at S on the diagram) which is carried by an arm keyed to the shaft, and it is slotted to clear the shaft; the angle OSO' is made equal to ESE' , so that the centre of the eccentric may be brought to the point E' when the engine is reversed. Let the lap of the valve be equal to Ob ; then the displacement of the valve when the engine is on a dead-point is Oa , found by drawing the vertical EaE' , and the lead is ba .

In Fig. 2 the valve-circle OP represents the valve-motion when the eccentric-centre is at E . The cut-off occurs at the crank-position OR , or at the piston-displacement xa , assuming harmonic motion; with crank and connecting-rod the piston-displacement will be longer at the forward-stroke cut-off, and shorter at the return-stroke cut-off, but in such case xa is nearly the mean for the two strokes. When reversed the motion of the valve will be represented by the dotted valve-circle OP' .

Suppose, now, that the eccentric-centre is shifted to E_1 , Fig. 1; the angular advance is YOE_1 , and the eccentricity is OE_1 . The valve-circle OP_1 will represent the motion of the valve; it has the angle YOP_1 equal to the angular advance, and the diameter OP_1 equal to the eccentricity when the eccentric-circle is at E_1 , Fig. 1. The point P_1 is evidently on an arc of a centre having its centre on XOX' produced, and drawn with a radius equal to ES , Fig. 1. In like manner the valve-circles OP_2 and OP_0 represent the motion given to the valve when the centre of the eccentric is at E_2 and at E_0 , respectively. The piston-displacement at cut-off for the valve-circle OP_1 is xa_1 ; the cut-off for the valve-circle OP_2 is at a_2 , and for the valve-circle OP_0 is at a_0 . Thus it appears that the cut-off may be made to vary from the piston-displacement xa to the piston-displacement xa_0 ; that is, from $\frac{7}{8}$ to $\frac{1}{8}$ of the stroke. All the other events of the stroke, namely, compression, release and admission, vary at the same time as the cut-off, and in a similar manner, though to a less degree. Of these other events, the admission varies the least; an examination of the figure will show that the lead-angle increases from about 2° to about 40° . The lead increases from ba to bE_0 , Fig. 1, and the increase is as clearly shown by Fig. 2. An arc representing the exhaust-lap would, if drawn, show the change of release and compression; it is omitted to avoid further complexity. Such an arc would show that the compression varies less than the cut-off, and that the release varies more than the admission. It is apparent that the increase of the lead depends on the radius SE (Fig. 1) of the arc on which the eccentric-centre moves, and may be diminished by moving the pivot S away from the axis of the shaft.

The gear is said to be in full-gear forward when the eccentric is at OE , Fig. 1, and at full-gear backing when the eccentric is at OE' . When the eccentric is at OE_0 the gear is said to be at mid-gear; intermediate positions may be called grades. An examination of Fig. 2 will show that, since the centre of the

valve-circle OP_0 , is on the axis XOX' , the crank-angle at admission is equal to the crank-angle at cut-off, and this, with other considerations, will indicate that the mid-gear position of the eccentric does not give proper motion of the valve for either forward or backward motion of the engine.

Fig. 2, Plate XI, gives the valve-diagrams for the eccentric controlled by the shaft-governor shown by Fig. 1, but drawn to eight times as large a scale. Since this engine always runs in the same direction, only one set of valve-diagrams is drawn (above the axis XX'), and the eccentric is slotted only enough to allow for a corresponding shifting of the eccentric.

The action of the reciprocating parts of a high-speed engine is of great importance. A considerable part of the work of the steam is expended in imparting motion to the reciprocating parts during the first half of the stroke, and this stored energy is restored during the second half of the stroke, as the reciprocating parts come to rest. In order that they may come to rest quietly at the end of the stroke, the piston should be cushioned by compression. Now, a valve that gives a variable cut-off and a variable compression is likely to have too little compression at full-gear and too much at short cut-off. An engine with a large clearance will suffer less from this difficulty than one with a small clearance; consequently the clearance of high-speed engines with shaft-governors is often made large, but a large clearance is not conducive to economy in the use of steam. Now, lead may act like compression, to stop the reciprocating parts, so that in general the more compression an engine has the less lead it may need. But it has just been seen that the shifting eccentric, shown on Plate X, gives an increasing lead toward mid-gear, that is, at the time when it may be least needed on a stationary engine. Had the pivot S been placed on the opposite side of the shaft, then the lead would have decreased toward mid-gear. Fig. 1, Pl. XII, gives the valve-diagrams for such an eccentric.

Shifting Eccentric with Constant Lead.—Fig. 2, Pl. XII, shows an eccentric that has a motion square across the shaft, thus carrying the centre of the eccentric on the straight line EE_0E' from full-gear forward to full-gear backing. It is at once apparent that the lead is constant. Fig. 3 gives the valve-diagrams for the full-gear, mid-gear, and two intermediate grades. Though the lead is constant, the lead-angle is not so; a comparison with Fig. 2, Pl. X, will show that the variation of the lead-angle is not so much as that for an eccentric with increasing lead, but it is more than for an eccentric with decreasing lead, as may be seen by a comparison with Fig. 1, Pl. XII.

A shifting eccentric with constant lead must be slotted to clear the shaft; the line OO' is made equal to EE' , in order that E may pass to E' when the engine is reversed. If the engine runs always in one direction, the slot, from centre to centre, may be only as long as EE_0 .

The mechanism for guiding a shifting eccentric along a straight line is more complicated than that for guiding such an eccentric on the arc of a circle and consequently that form has been but little used.

The shifting eccentric accomplishes nearly the same result as the link-motion, to be described in the next chapter, but with fewer parts and by a more evident action; it is consequently desirable that it shall be clearly understood before beginning that chapter.

CHAPTER III.

LINK-MOTION.

THE valves of locomotives, marine engines, and other reversing engines are commonly controlled by a mechanism called a link-motion; this mechanism has also the property of giving a variable cut-off. The mechanism consists essentially of two eccentrics, one for full-gear forward and one for full-gear backing, together with the eccentric-rods and the *link*. The eccentric-rods are attached to the link, at or near the ends, and the link is slotted or otherwise arranged to receive a block on the end of the valve-spindle, or a radius-rod, or on the end of a rocker, as the case may be. The link-motion takes two forms; in one, known as the Stephenson or shifting link, the link is moved on the block to reverse the engine or to vary the cut-off; in the other, known as the Gooch or stationary link, the block is moved in the link to accomplish the same object.

Stephenson Link.—The usual form of link-motion for American locomotives is shown by Figs. 1 and 2, Pl. XIII. The valve is moved through a rocker so that the eccentrics follow the crank; thus, the centre of the crank-pin is at *C*, and the go-ahead eccentric has its centre at *E*, while the backing eccentric-centre is at *E'*. The link-pins *P* and *P'*, to which the eccentric-rods are attached, are set back from the link-arc, and the link may move over the link-block *B* so far as to bring the centre of the block opposite the centre of the link-pin, as shown by Fig. 1; in which position the motion of the valve is controlled almost entirely by

the eccentric E , and has essentially the motion of a plain slide-valve. The link is suspended by a link or hanger, nm_0 , from a reverse-shaft centred at S ; the hanger takes hold of the saddle-pin m_0 on a plate that is commonly at the middle of the link.

A locomotive has two cylinders, with pistons acting on two cranks set at a right angle, and thus has two engines each of which must be provided with its own link-motion. Both links are suspended from one reverse-shaft, which has an arm SR from which a rod runs to a reverse-lever conveniently located in the engineer's cab. The reverse-lever moves over a notched arc, and by aid of a latch engaging with the notches the link may be set and secured in any desired position.

Fig. 2, Pl. XIII, gives an end elevation of the link, the hanger, and one arm of the rocker carrying the link-block B .

English locomotives commonly have the link acting directly on the valve-spindle, without the intervention of a rocker. In such case the link-pins should be placed on the link-arc, as shown by Fig. 3, Pl. XIII, and with that construction the link-block cannot be opposite one of the link-pins and cannot receive the full motion of the eccentric. Consequently the eccentricity, and with it all the dimensions of the link-motion, must be larger to give proper motion to the valve.

The link-motion for the high-pressure cylinder of one of the engines of the U. S. S. *Maine* is shown by the figures on Plate XIV. The parts are lettered as on Plate XIII, and, although no rocker is used, the eccentrics follow the crank, as the valve takes steam in the middle; thus E and E' are the centres of the eccentrics, and P and P' are the link-pins, which in this case are on the link-arc; S is the reverse-shaft, and NP is the drag-link or bridle which takes hold of the go-ahead link-pin. The link, which is known as the Scotch or side-bar link, is shown in plan by Fig. 2. The link-block is between the side-bars, and is pivoted directly on the end of the valve-spindle; thus the link can be set so that the axis of the

link-pin coincides with that of the link-block pivot, and the full motion of the eccentric can be given to the valve. The head of the valve-spindle is guided by cast-iron jaws, as shown in Fig. 1. The end of the reverse-arm is slotted and provided with a sliding-block, screw and hand-wheel, as shown, so that the cut-off may be adjusted in a manner to be described later.

Open Rods and Crossed Rods.—If the eccentric-rods of a link-motion are connected as shown in Fig. 1, Pl. XV, the rods are said to be open; on the other hand, the rods are said to be crossed when connected as shown by Fig. 2. In both figures the crank is on the crank-end dead-point, and the valve-gear has no rocker. A link-motion with a rocker is said to have open rods when the eccentric-rods are connected as shown by Fig. 3; aTb is the rocker, and bc the valve-spindle; the crank is on the head-end dead-point. If the link-motion moves a piston-valve which takes steam in the middle it will have open rods when the parts have the relation of Fig. 3, *without* a rocker. In all these figures the link-pins are on the link-arc. Since half a revolution will apparently cross the rods for Figs. 1 and 3, while it will apparently open the rods for Fig. 2, the nomenclature seems to be unfortunate. There is, however, a real difference in the methods of the connection of the rods, and that difference has an important influence on the action of the valve, for open rods give an increasing lead from full toward mid gear, while crossed rods give a decreasing lead from full toward mid gear. All arrangements which give increasing lead toward mid-gear are classed with open rods. In Fig. 1, the full lines $E\phi_0$, $E'\phi_0'$, and the arc $\phi_0\phi_0'$, show the eccentric-rods and the arc of the link at mid-gear, while the thin lines Ec , $E'\phi'$, and the arc $c\phi'$, show them at full-gear forward. Since the valve and valve-rod have the same motion as the link-block, it will be sufficient to trace the motion of the latter. At full-gear the link-block will be at c , found by intersecting the line of centres with E as a centre, and with a radius equal to the length of the eccentric-rod. The eccentric-pin ϕ' is located by draw-

ing arcs from E' and c , with the lengths of the eccentric-rod and the length of the link as radii. At mid-gear the link-block is at c_0 ; the points p_0 and p_0' are at a distance from the centre-line OX , equal to half the chord of the link-arc, and the link is erect. The increase of lead from full-gear to mid-gear, cc_0 , is apparent from the diagram. A similar construction in Fig. 2 shows the decrease of lead from full-gear toward mid-gear for crossed rods. In the figure the decrease is greater than the full-gear lead, so that the valve is shut at the dead-point when the link is at mid-gear.

Long and Short Rods.—The variation of lead from full-gear toward mid-gear is due to the curvature of the link-arc, and is more pronounced for a link with short radius than for one with long radius; now the radius of the link-arc is usually equal to the length of the eccentric-rod, hence the variation is more for short than for long rods. In Fig. 1, Pl. XV, it is apparent that $c''c_0''$ is greater than cc_0 ; a similar construction will show that the decrease of the lead from full-gear to mid-gear for crossed rods is more marked for short than for long rods.

Radius of the Link-arc.—An analytical discussion (see Appendix) of the link-motion shows that the radius of the link-arc should be equal to the length of the eccentric-rod; if the link-pins are on the link-arc, then the radius should be the distance from the centre of the eccentric to the link-pin; but if the pins are back of the arc, the radius is the distance from the centre of the eccentric to the link-arc, i.e., the length of the rod plus the distance the pins are back of the arc. The same discussion establishes also the fact that open rods give increasing lead, and that crossed rods give decreasing lead, from full-gear toward mid-gear; but the demonstrations given are believed to be useful, and a similar demonstration will be given of the proper radius for the arc.

In Fig. 1, Pl. XV, the link-block is at c at full-gear when the crank is on the crank-end dead-point; when the crank is on the head-end dead-point a similar construction will give for

Comp. 32
0

the position of the link-block the point c' . The point o , half-way between c and c' , corresponds to the mid-position of the valve, and from o the lap on, on' may be laid off on each side, giving $nc = n'c'$ for the lead. At mid-gear the head-end lead is nc_0 , and a similar construction for the crank-end dead-point will give $n'c'_0 = nc_0$ for the crank-end mid-gear lead. If now a diagram is drawn for some intermediate gear of the link, it will be found that the lead is the same at the two ends, and that it is intermediate between nc and nc_0 . Fig. 1 is drawn with the radius of the link-arc equal to the length of the eccentric-rod, and any diagram drawn with dimensions chosen at random will in like manner show equal leads under like conditions. Constructions for a link with crossed rods will also show equal leads if the radius of the link-arc is equal to the length of the eccentric-rod. Consequently, it may be inferred that the one requirement for equal leads is that given, i.e., that the radius of the link-arc shall be equal to the length of the eccentric-rods. A natural inference is that any other radius for the link-arc will give unequal leads for some grades of the link, and such will be found to be the case if constructions are made.

Zeuner's Diagram.—The best idea of the nature of the motion given by a link to a valve is obtained by drawing a series of valve-diagrams like those for a shifting eccentric. An analytical proof that such diagrams properly represent the motion of the valve will be found in the appendix. An approximate construction sufficient for the purpose can be made in the following manner. First draw a diagram like Fig. 1, Pl. XV, showing the link full-gear and in mid-gear and measure the difference in lead in these two positions. Next draw a pair of axes, XOX' and OY , as in Fig. 4, Pl. XVI, and draw the full-gear valve-circle OP . Drop the perpendicular Pq onto the axis XX' and draw the lap-arc nn'' with the proper full-gear lead, qn . Lay off the increase of lead qP_0 , as determined from Fig. 1, Pl. XV, and with a centre on the axis XX' , draw an arc through P and P_0 . Choose a

point like P_1 on this arc and draw the line OP_1 and on it the valve-circle OP_1 ; it will exhibit the action of the valve for the corresponding intermediate grade of the link. A number of important facts concerning the general action of a valve controlled by a link-motion can be inferred directly from such a diagram. If R_0R_1R be taken to represent the path of the crank (drawn to a different scale), then the mean piston-displacement at cut-off for full-gear is xa , about $\frac{1}{2}$ of the stroke. For the grade OP_1 the piston-position at cut-off will be xa_1 , somewhat more than $\frac{2}{3}$ of the stroke, but the maximum port-opening decreases to less than half that at full-gear, while the lead is nearly as much as at mid-gear. The grade represented by OP_2 gives cut-off just before half-stroke and a port-opening less than a quarter as much as at full-gear. These two features, the increase of lead and decrease of port-opening are the most striking features of the action of a valve which is controlled by a link-motion with open rods. A link-motion with crossed rods will, of course, show a decreasing lead toward mid-gear, but it will have much the same notable decrease of port-opening.

If a diagram like Fig. 4, Pl. XVI, is drawn, but with a larger angular advance and larger steam-lap, it will show a better port-opening at an early cut-off, but the maximum cut-off corresponding to full-gear of the link will be correspondingly reduced. A careful study of such diagrams will give a broader and clearer idea of the essential properties of the link-motion than any work with a model or with complete diagrams of the gear. Unfortunately the inequalities which it is customary and desirable to introduce into the valve-motion by the way the link is suspended, make it impossible to design a link-motion by such diagrams alone; the complete design can be best made by aid of a skeleton wooden model to be described on page 64.

Gooch Link.—Fig. 1, Pl. XVIII, shows the Gooch or stationary link, as applied to locomotive engines. E and E' are the forward and backing eccentrics, from which the eccentric

rods lead to the link-pins P and P' . The link is suspended by the rod mn , from a fixed pivot n , and has its convex side turned toward the axle O . The link-block B is carried by a radius-rod BD , which is connected directly to the head of the valve-spindle at D . By means of a reverse-arm ST and hanger TU , the engineer may place the link-block B opposite the link-pin P for full-gear forward, opposite the link-pin P' for full-gear backing, or at any intermediate position. The action of this link-motion is therefore equivalent to that of the Stephenson link-motion. The details of the mechanism are varied somewhat by different makers. In the figure the link is suspended from a saddle-pin on or near the chord joining the ends of the link-arc; and for this purpose a plate or bridge similar to that shown by Fig. 2, Pl. XIII, is employed which permits the passage of the link-block. The saddle-pin is sometimes placed behind the link-arc toward O , so as to avoid the use of a plate or bridge. The link-pins are placed behind the link-arc to allow the link-block to be brought opposite the link-pins. They may be placed on the link-arc, using a link like that shown by Fig. 3, Pl. XIII, but turned so that the convex side is toward the axle O ; in which case the full action of the eccentric cannot be given to the valve. Sometimes a box-link, shown by Fig. 3, Pl. XVIII, is used, and then the saddle-pin and link-pins may be placed in any desired positions without interfering with the link-block; this device is equivalent to the side-bar link shown on Plate XIV.

Open and Crossed Rods.—As was found to be the case with the Stephenson link, the rods of the Gooch link may be open or crossed. Fig. 1, Pl. XVIII, has open rods, and Fig. 2, Pl. XVII, has crossed rods.

Radius of the Link-arc.—The common and proper practice is to make the radius of the link-arc equal to the length of the radius-rod; and when so made the lead is constant for all grades of the link. This property is at once evident from inspection of Fig. 1, Pl. XVIII, and Fig. 2, Pl. XVII, one having open and

the other crossed rods; for it will be seen that when the engine is at a dead-point and the link is erect, the link-block may be moved from one end of the link-arc to the other without moving the valve.

Comparison of the Stephenson and Gooch Links.—A comparison of the link-motions on Plates XIII and XIV with that on Plate XVIII will show that the Gooch link-motion has more parts and more joints at which lost motion will result from wear, and that it occupies nearly twice the longitudinal space required for a Stephenson link-motion. As an offset may be urged its property of giving a constant lead. The choice of a link-motion for a specific purpose must depend on the importance that should be attached to any given feature of the gear under the given conditions. With proper proportions either gear can be made to give the valve a nearly harmonic motion, or, with proper modifications, either gear may be adjusted to give an equalized cut-off; from this point of view neither appears to have an advantage.

Locomotive Link-motion.—Reversing engines are of two types, locomotive engines and marine engines; the conditions of their service are so different as to merit detailed discussion. Some stationary engines are reversing engines, and are controlled by hand instead of by a governor; for examples may be mentioned winding and hoisting engines, and engines for driving reversing roll-trains. According to the conditions of their use they will fall into one or other of the two classes mentioned, or may partake of the characteristics of both.

In starting a railway train, the link-motion is thrown into full-gear forwards, and should then give a long cut-off, so that, with the throttle-valve partially open, a moderate and steady force may be exerted on the driving-wheels to overcome the friction of, and impart motion to, the train, without slipping the wheels on the track. The lead may properly be small at full-gear, and is sometimes zero or even negative. As the train

gets under way and the revolutions per minute become high, the action of the reciprocating parts becomes important; just as was seen to be the case for a high-speed stationary engine (see page 45), there must be a considerable amount of compression in order that the engine may run smoothly. An early admission and release are also desirable in order that the steam may be supplied and exhausted freely. All these conditions are met by raising the Stephenson link toward mid-gear and opening the throttle-valve, and at the same time the economic advantage of the expansive working of steam can be obtained.

American and English locomotive-designers have used the Stephenson link-motion, while Continental designers have used the Gooch link quite widely. In American practice the cylinders are commonly placed outside of the locomotive-frames, with the valve-chest on top; the link-motions are placed between the frames and act on the valve through a rocker, as has already been shown on Plate XIII. English locomotives frequently have the cylinders inside the frames, and the valve-chests are on the sides of the cylinders and under the smoke-box; the link-motions then act directly on the valve-spindle, using a link like that shown by Fig. 3, Plate XIII. When the Continental locomotive designers use the Gooch link-motion, they place it outside the drivers, and so readily find room for eccentric-rods and radius-rod. Such a disposal of the valve-gear keeps it in sight where it may receive attention, but does not meet with favor among American and English engineers, since it is liable to derangement from slight accidents.

Locomotive link-motions have the pins and other smaller wearing parts made of hard steel, the link is case-hardened, and the eccentric-rods are bushed with steel; the eccentrics and straps are the only exception to the rule that all the wearing parts are made as hard as possible. With the exception of the eccentric-straps, no provision is made for taking up wear; when the looseness becomes excessive the whole gear is over-

hauled, and new pins and bushings provided if necessary. The reason for this practice is twofold: first, the complication of adjustable parts is avoided; second, the gear is unavoidably exposed to dirt and grit, and when grit gets into a joint between a hard and a soft metal, it becomes embedded in the latter and rapidly abrades the hard surface. The custom is to equalize the cut-off by a method that gives a good deal of slipping of the block in the link, but as both link and block are hard, and the cut-off is continually varying, this practice is not so objectionable as it would be on a marine-engine link-motion.

Marine Link-motions.—At the present time marine engines are commonly compound or triple-expansion, and the link-motions are used only for reversing the engine, the reverse-arc having only three notches, full-gear forward, full-gear backing, and mid-gear. Crossed rods may be used to advantage, for then the engine can be stopped by setting the link at mid-gear. In this connection it may be remarked that an engine controlled by a Stephenson link-motion with open rods will not necessarily stop when the link is placed in mid-gear, provided the engine is running under no load or a very light load; though the engine will not start with the link in that position. The normal condition for a marine engine is to run at full speed and under a full load, and when the speed decreases the load falls off rapidly. The result of an attempt to adjust the steam-supply to a smaller load, by shifting the link toward mid-gear, is to give an excessive compression, and an early release, when the reciprocating parts have least effect, and when the reduced quantity of steam is readily exhausted. Simple-expansion engines and many compound engines were provided with an independent cut-off valve on the back of the main valve, of a type to be discussed in Chapter V.

Marine-engine link-motions are designed to give the required cut-off for full load when set at full-gear; as has already been said, there is frequently no provision for shortening the cut-off as on locomotives. Since the engine is liable to run for days

or weeks at full-gear forward, the gear is designed to give very little slipping of the block in the link at this position. As the gear is large and frequently massive, the complication of making the wearing parts adjustable is not objectionable; and as the engine works in a closed engine-room, there is no reason why grit should get into the wearing surfaces, which may therefore be lined with soft metal when that is desirable.

Modification of the Link-motion.—In the analytical discussion of link-motions it is supposed that the arrangement of the parts and the choice of dimensions are such as to give a nearly harmonic motion to the valve. In both the Stephenson and the Gooch link-motions the link-pins are supposed to be on the link-arc; in the first the radius of the link-arc is assumed to be equal to the length of the eccentric-rod, and in the second it is assumed to be equal to the length of the radius-rod. It is, however, possible, by modifying some of the arrangements, to obtain certain desired effects, such as the equalization of the cut-off, without sacrificing the equality of the leads. The effect of some of the modifications can be proved, or at least inferred, from the diagram of the link-motion; but since they are in the nature of adjustments and must in any case be worked out by trial, it will be sufficient to state some of them for the Stephenson link-motion.

Link-pins.—The link-pins of a Stephenson link-motion *with a rocker* may advantageously be placed back of the link-arc; *without a rocker* they should be on the link-arc, or they may be placed ahead of the arc if mechanical difficulties do not interfere.

Saddle-pin.—By proper location of the saddle-pin, or the point of the attachment of the hanger or bridle, it is possible to equalize the cut-off at any point of the stroke both in forward and backing gears. This element of link-motion is by far the most effective, for good or evil, of all that the designer has at his control, and fortunately he usually has complete control over it. If a symmetrical gear is desired, the saddle-pin should be placed at the middle of the length of the link; *with a rocker* it will be

back of the link-arc, and *without* a rocker it will be ahead of the link-arc. With proportions common for American locomotives a fair action may be had by placing the saddle-pin at the middle of the link and one-third way from the chord to the arc. On such locomotives, with a rocker, the slip of the link-block is greater in forward than in backing gear, when the saddle-pin is at the middle of the link; and the forward-gear slip may be diminished by placing it nearer the forward-gear link-pin, but this is attained at the expense of the symmetry of the gear. Sometimes the link is supported from below instead of being suspended from above; and in such case the forward-gear slip is less than the slip in backing-gear. Links for marine engines, and in English locomotives without a rocker, are frequently suspended by the forward link-pins. It is customary to equalize the cut-off at half-stroke, or earlier, by a proper location of the saddle-pin; an equalization at one-third stroke is recommended.

Reverse-shaft.—The position of the reverse-shaft is often fixed or susceptible of but little change. If it can be located at pleasure, it may also be used to equalize the cut-off at any point of the stroke. When so used, the location of the reverse-shaft is used to equalize the cut-off near the end of the stroke, usually in combination with an equalization to the cut-off by the location of the saddle-pin at half-stroke or earlier. With a rocker, such a manner of locating the reverse-shaft is liable to bring it in conflict with the eccentric-rods at one of the full-gear positions.

Radius of the Link-arc.—It has been shown that the link-arc for the Stephenson link should have a radius equal to the length of the eccentric-rod, in order that the leads may be equal. It may sometimes be desirable to use a different radius to facilitate the equalization of the cut-off. *Without* a rocker the radius may be made greater than the length of the eccentric-rod, and *with* a rocker it may be made less. Such a choice of the radius of the link-arc will sacrifice the equality of the leads, and the deviation from the normal radius must never be enough to badly

derange them. In this connection it should be said that the lead near mid-gear supplies a large portion of the steam admitted, and that the lead at full-gear affects the facility with which the engine passes the centres; much inequality in either place is undesirable. With open rods the full-gear lead is small, and may vary from a certain amount to double that amount, or to zero, without serious consequence. At and near mid-gear the lead is large, and may vary as much absolutely as at full-gear, since that will not be much relatively.

Any change from the standard radius of link-arc should be made by trial with the aid of the model to be described on page 64. In the use of that model it will be found convenient to start with the standard radius and to increase the length of the *eccentric-rods* progressively till the desired effect is obtained. Afterward the *radius* of the link-arc may be decreased a like amount and a new link-template can be cut and used to determine whether the desired results can be attained by using it with the original length of eccentric-rods. The reason for this procedure will be evident after the model is described, and it will then be evident that the length of the rod can be readily varied while a change of radius of the link-arc involves the making of a new template.

The motion of the valve will be more nearly harmonic with long rods and with a long link; the first should be twelve times and the second four times the eccentricity, or more, except under peculiar conditions. A skilful designer may use the inequality introduced by short rods or a short link to adjust a link-motion, but these dimensions are commonly fixed, and the modification of them for that purpose is not in general to be regarded with favor.

Designing Link-motions.—The design of a link-motion may be divided into two parts: first, the choice of such a type of link-motion and such general proportions as will be likely to give a satisfactory solution of the problem in hand; and, second, the application of modifications and adjustments to give equal cut-off, or to reduce the slip, or to produce any other desired effect.

The first part of the design may be much aided by the use of the Zeuner diagram; the second part is commonly attained either by drawing out the link-motion and by making the proper constructions, or by aid of a working model with adjustable parts. A combination of the methods of drawing and using a model, combining certain advantages of each, will be explained later. The first part of the design is often so fixed by the requirements of the general design of the engine, or by custom, that it is liable to be neglected.

Marine-engine Link-motions.—As has already been stated, the link-motions of modern marine engines are commonly used for reversing only, and not for regulating the power of the engine. Since the Stephenson link-motion at full-gear acts like a plain slide-valve gear, the determination of the eccentricity and angular advance and the design of the valve may be carried out by the methods given in the first chapter. It is customary to make the head-end lap greater than the crank-end lap, thereby partially equalizing the cut-off, and the consequent inequality of leads (the crank-end lead being the larger) is a partial compensation for the longer cut-off at the head-end. In Fig. 1, Pl. V, the only change required is to choose the point of cut-off for both forward and return strokes, the former being the longer.

The link is usually guided by the go-ahead pin, as shown on Plate XIV and Plate XIX, both of which represent the link-motion of the U. S. S. *Maine*; though sometimes a point beyond the link-pin, or a point at the middle of the link, is chosen. This particular link-motion actuates a piston-valve like that shown by Fig. 1, Pl. VII, which takes steam in the middle and exhausts at the ends. Consequently the motion of the valve is in the opposite direction from that of a plain slide-valve, and the general effect is like that produced by moving a valve through a rocker; the eccentric follows the crank, and the rods are crossed, as shown on Plate XIV and Plate XIX. Let p and P be the positions of the go-ahead link-pin when the crank is on crank-end and head-

end dead-points respectively; then with p and P as centres and with a radius equal to the length of the bridle, arcs are struck intersecting at N , which is one extreme position of the end of the reverse-shaft arm. The length of the bridle is such that the arc $aPpa_1$ nearly coincides with the line XX' , and the slipping of the link-block is small; the arc aa_1 is extended both ways for sake of clearness in the diagram.

The location of the reverse-shaft may now be made either to give the backing action symmetrical with the forward action of the link, or to reduce the slip in backing-gear.

Symmetrical Action.—Let it be assumed that the backing link-pin shall be guided to the points P and p , when the engine is on the dead-points; then the go-ahead link-pin will be found at P_1 and p_1 . With these points as centres and with the length of the bridle for a radius, draw arcs intersecting at n ; and with N and n as centres and with the length of the reverse-shaft arm as a radius, draw arcs intersecting at S : the last point is the desired location of the reverse-shaft.

Reduction of the Slip.—In full-gear forward the go-ahead link-pin moves on the arc aa_1 , and the backing link-pin describes an elongated looped figure, of which the upper loop is quite small; P' and p' are two points on the larger loop. If now the link be thrown into full-gear backing, and if the backing link-pin be made to move on the line XX' , then the go-ahead link-pin will describe a looped figure of which P_1 and p_1 are two points. To draw the looped figure, let C be a given position of the crank, and let E and E' be the corresponding positions of the eccentric-centres; with E' as a centre and with the length of the eccentric-rod for a radius, cut the line XX' at P ; with E as a centre and with the same radius draw an arc and intersect it with another arc drawn from P and with the length of the link between the pins for a radius; then P_1 at the intersection of the two last arcs is one point on the looped figure. To find other points make the same construction for a sufficient number of crank-

positions, say twelve, at equal intervals around the circle described by the crank-pin.

Find by trial a centre n_0 , from which, with a radius equal to the length of the bridle, the arc u_1 may be drawn through the middle of the looped figure. Then with a radius equal to the length of the reverse-arm, draw arcs intersecting at S_0 ; this is the location of the reverse-shaft for giving as small a slip as possible in full-gear backing. With this construction the go-ahead link-pin describes the arc u_1 when the link is in full-gear, and at the same time the backing link-pin describes a looped figure similar to the one at $P'p'$, and lying partially on one side and partially on the other side of the line XX' near Pp . The link-block will slip in the link an amount nearly equal to the width of the looped figure P_1p_1 , measured on a radial line from n_0 ; the exact amount of slip can be found by drawing the true looped figure near Pp ; it is omitted in the diagram to avoid confusion. It is evident that the slip of the link-block will be greater if the construction for symmetrical action resulting in the location of the reverse-shaft at S , should be used. In that case the slip is nearly equal to the total deviation of the looped figure P_1p_1 from the arc through P_1p_1 ; it can be found by drawing the true looped figure near Pp when the path of the go-ahead link-pin is the arc P_1p_1 .

Adjusting the Cut-off.—The distribution of work among the cylinders of a compound or multiple-expansion engine depends on the ratio of the volumes of the cylinders and on the cut-off for the several cylinders. If the distribution of the work is not satisfactory when all the links are set at full-gear, it may be adjusted, or at any rate it may be improved by shortening the cut-off on one or more of the cylinders. On recent marine engines which have only three notches on the reverse-arc, namely, full-gear forward, full-gear backing, and mid-gear, a device known as a gag is put on the end of the reverse-arm for this purpose. The rod of the bridle is carried by a block N (Fig. 1, Pl. XIV),

which may be moved in a slot NM in the end of the reverse-shaft arm, by aid of a screw and hand-wheel, and thus the link may be moved toward mid-gear and the cut-off may be shortened.

The construction of the gag for the link-motion shown on Pl. XIV is found on Pl. XIX. A line (not shown on the diagram) is to be drawn midway between nP_1 and np_1 , and perpendicular thereto is drawn the line nm ; this is chosen as the centre-line of the slot and screw NM , Fig. 1, Pl. XIV. In full-gear forward the centre-line of the slot and screw is at MN , which makes an angle of about 7° with a line midway between NP and Np . It is apparent that when the block N is moved toward M , Pl. XIV, the cut-off is shortened for forward gear without appreciably changing the method of supporting the link-motion, while in backing gear the cut-off is not affected. This construction is commonly found for engines that back only occasionally, but for engines, like those for double-ended ferry-boats, which run one way as much as the other, it is desirable to shorten the cut-off equally in forward and in backing gear. For this purpose the line of the slot in the gag can be set at NM' and will come to nm' in backing gear, the position of those lines being found by trial so that the angle which NM' makes with a line mid-way between PN and pn , shall be equal to 180° minus the angle which nm' makes with a line midway between P_1n and p_1n . But this latter construction modifies appreciably the general method of guiding the link and there is likely to result a considerable interference with the harmonic motion of the valve.

Locomotive Link-motions.—In American practice the link-motion is set to give equal lead at full-gear, and is adjusted to give equal cut-off; the reduction of slip being considered to be of less importance, though it is not to be neglected. The adjustment of the cut-off is made by aid of a model with adjustable parts, by aid of which an experienced designer can readily work out a satisfactory motion, or at any rate as good a motion as the conditions will allow.

In equalizing the cut-off, it is to be borne in mind that any irregularity at short cut-off is of much more importance than at long cut-off, since the amount of steam admitted to the cylinder is nearly proportional to the length of the cut-off, and the work varies with the amount of steam admitted. Thus an inequality of half an inch in six inches is $\frac{1}{12}$, while half an inch in eighteen inches is only $\frac{1}{36}$.

The full-gear or maximum cut-off varies with the conditions of the service and the judgment of the designer from $\frac{3}{4}$ to $\frac{1}{2}$ of the stroke. When an engine, for example, one in passenger service, is to be run at high speed and with a short cut-off, it is advisable to make the full-gear cut-off as short as the ready handling of the engine, when starting, will permit, in order that a favorable action of the valve may be obtained at short cut-off. This will be made clear by a comparison of Fig. 4, Pl. XVI, in which the maximum cut-off is at $\frac{7}{8}$ of the stroke, with Fig. 1, Pl. XX, in which the maximum cut-off is at $\frac{5}{8}$ of the stroke; the diameters of the full-gear valve-circles are the same. In each figure OP_1 is the valve-circle for the link-block half-way between the link-pin and the saddle-pin. In Fig. 4, Pl. XVI, OP_1 has a diameter of $\frac{3}{8}$ of an inch, gives a maximum port-opening of $\frac{1}{12}$ of an inch, and the cut-off occurs at 0.70 of the stroke. In Fig. 1, Pl. XX, the cut-off occurs at 0.55 of the stroke, the diameter of OP_1 is $1\frac{1}{2}$ of an inch, and the maximum port-opening is again $\frac{1}{12}$ of an inch. The comparison also shows the importance of the first part of the design of a link-motion, mentioned on page 59, and the advantage of using Zeuner's diagram for that purpose.

Skeleton Model.—The author has found that a skeleton model, such as is shown on Pl. XX, can be used with advantage in laying out and adjusting a link-motion. It consists of a piece shown by Fig. 3 to represent the crank and eccentrics, of a template shown by Fig. 4 to represent the link, and of rods to represent the eccentric-rods, the hanger and the reverse-shaft arm, together with screws and washers to make attachments.

The several parts may be made of any fine-grained hard wood, such as mahogany or cherry. Fig. 5 shows one of the joints with a thick wooden washer, as at the eccentric-centre e' , Fig. 2. A wood screw of proper size is cut off so that it may not protrude through the plate into which it is set. The hole at b for the screw is drilled a trifle smaller than the shank of the screw at the bottom of the threads, and a pointed screw like the one to be used is run through to cut a thread in the hole. The hole in the washer c may be an easy fit for the screw, while the hole in the rod d is a snug fit for the body of the screw under the head. The countersunk hole in the rod d should be made with a tool, like a machinist's countersink, but with the cutting edges sharper. One size of wood screw may be used to fasten all the joints of the model, and two drills should be carefully selected, one to drill a hole into which the body of the screw will fit snugly, and the other to drill a hole in like manner for the shank at the bottom of the screw-threads. A steel jig should be made to guide the drills and keep them from running to one side while drilling the holes in the wooden members of the model. For this purpose take a piece of steel, about $1\frac{3}{4}$ inches long, half an inch wide, and one-eighth of an inch thick. Draw a line through the middle of the face of the jig and transverse lines about a quarter of an inch from each end; continue all lines down the edges of the jig to the opposite side to aid in setting the jig. Drill holes at the intersection of the longitudinal and transverse lines, one for the larger and the other for the smaller drill. Any hole for a screw will be located on the member of the template by perpendicular lines to which the jig may be set; after the jig is set and clamped in place the hole is to be drilled carefully in a lathe or a sensitive drill-press. This method is susceptible of great accuracy and delicacy and its success depends in the first place on the exactness with which the model is laid out and assembled and in the second place on the intelligence and skill with which it is used.

In anticipation of laying out the model, a Zeuner's diagram

should be drawn as in Fig. 1; in which the full-gear valve-circle OP is laid out as for a plain slide-valve to give the lead-angle XOA and the cut-off at OR_1 , corresponding to the piston-position a , on the assumption of harmonic motion. As was found to be the case for a plain slide-valve, it may be necessary to modify and redraw the full-gear valve-circle in order to get a desired lead and lap. The diameter of the mid-gear valve-circle may be determined by the graphical method of page 51, and then the locus $PP_1P_2P_0$ of the end of the valve-circle diameters may be drawn as the arc of a circle centred on the line XX' .

Laying out the Model.— Experience has shown that the model may be laid out and tested very exactly by the following method which should be followed explicitly, at any rate for the first time.

To lay out the crank-disk, draw a line AB as nearly as may be across the middle of the wooden template used for this purpose, as indicated on Fig. 1, Pl. XXa. Lay off the radius of the crank-circle from A and thus locate the centre O of the disk and draw a line DON through it perpendicular to AB . It will be convenient to take this radius as six inches for a full-size construction, whatever may be the real stroke of the engine.

At a distance from O equal to the steam-lap plus the full-gear lead draw $E'H$ parallel to DN . With O as a centre and with a radius equal to the eccentricity describe arcs cutting $E'H$ at E and E' respectively; they are the eccentric centres. Draw the lines PS and RT through E and E' at right angles to HE' ; they will be required for setting the steel jig when the holes are drilled at E and E' . Draw the lines OK and OL from O through E and E' . Lay the disk flat on a board and with a steel scale square down lines to the under side of the disk from A , B , L and K . Drill a large hole for the body of the screw at O and small holes for the shank of the screw at E and E' .

To lay out the drawing, stretch a sheet of good drawing-paper,

large enough to take the entire construction, or if more convenient stretch two pieces, one for the construction near the crank-shaft, and the other for the construction near the link. A full-size diagram for the usual American locomotive link-motion will require a sheet of paper 54 inches long and 27 inches wide; if two pieces are used, that at the crank-shaft may be 14 inches square and the other at the link may be 24 inches horizontally and 27 inches vertically; in either case the centre-line may be about 16 inches below the top of the paper where the link construction is to be made.

Place the disk on the paper so that the hole at O shall come at the proper location for the centre of the crank-shaft, and drive a screw through that hole into the drawing-board; this gives the final location of the disk, and, like all the work for this use of the model, must be done carefully. Further instructions direct the disk to be taken up and afterwards replaced, and in like manner certain other parts of the model are assembled and separated for testing and again put together. If this work is done carefully and with discretion, the model when finished and ready for use will be free from back-lash and other sources of error and will endure much more use than required for working out any single problem. It is needless to say that haste or carelessness can easily ruin the model at any stage of the work.

Have a strip of wood prepared to clamp to the disk, as shown by Fig. 2, Pl. XXa, with two holes, one to receive the body of the crew at E and another to receive a pencil at Q . The latter will be placed at a distance from O equal to the radius of the crank-circle which, as already said, may be 6 inches. These holes are to be laid out and drilled with care according to the general directions. The path of the crank-pin can now be drawn with this device clamped to the disk and will be properly centred.

Remove the disk and draw the centre-line corresponding to

XX' , Pl. XX, through the centre of the hole for the screw which passed through O in the disk. Having the crank-pin circle already drawn, this may be done accurately by choosing one point at A and locating the other, A' , exactly opposite by spacing around the circle with dividers. The line XX' is to be produced across the entire drawing by aid of a steel straight-edge, or a very fine thread drawn taut across the drawing. With the proper ratio of connecting-rod to crank, lay off the stroke xx' and locate the one-third stroke marks as indicated for both forward and return stroke. It will be convenient at the same time to locate the following divisions of the stroke, beginning at x , namely: $\frac{1}{4}$, $\frac{1}{2}$, $\frac{5}{8}$, $\frac{3}{4}$, and $\frac{7}{8}$, or, in place of the latter, the full-stroke cut-off as determined by Zeuner's diagram.

To test the eccentricity, make a testing-piece of a strip of wood about 8 inches long, drilled to take the body of the screw at E' and a pencil at J , as shown by Fig. 3, Pl. XXa. Clamp the disk in place and turn it until the line OL through E' comes to the axis XX' and draw a short arc cutting that axis at J . Apply the testing-piece to the eccentric E and bring the line OK to the axis and again draw an arc across the axis; if the arcs coincide, the eccentricity is the same for both eccentrics; if not, the disk must be laid out and drilled anew.

To test the angular advance, set the disk with the mark that represents the centre of the crank-pin on the axis XX' , as indicated in Fig. 4, Pl. XXa, and with the testing-piece first on E and afterwards on E' describe arcs cutting the axis; if the intersections coincide, the eccentrics have the same angular advance; if not, the disk may be turned by trial until a coincidence is secured and the centre-line AB representing the crank may be located midway between the eccentrics by marking the point on the disk which then comes on the axis. Of course, this method should be used only when the discrepancy is small; if it is large, the disk must be laid out again from the beginning.

To lay out the link-template, draw an arc ZZ' , Fig. 5, Pl. XXa,

with beam-compasses, using the proper radius for the link-arc and a convenient centre on the axis XX' . Place the template on the paper in contact with this arc and with its middle point on the axis XX' . Mark the points q and r on the edge of the template and square them up onto the face, then draw the line qr on the template. With the centre already used and with a radius equal to that of the link-arc minus the distance the link-pins are set back from the arc, draw the short arcs yy_1 and y_2y_3 as shown. Draw two lines parallel to qr and at a distance from it equal to half the distance between the link-pins; this can be conveniently done by drawing arcs with the proper radius from a point near r and another near q . These lines PV and $P'V'$ will locate the centres P and P' of the link-pins. Produce these lines to the edge of the template and square down to the under surface. At P and P' small holes are to be drilled for the shanks of the screws. To test the accuracy of this construction place the template again in the position shown by Fig. 5 and weight it to prevent accidental movement, and then with the testing-piece attached first at P and afterwards at P' , draw arcs intersecting the axis XX' on both sides, as shown. If these intersections coincide, the link-pins are accurately located; if not, we must either relocate qr by trial or reconstruct the location for P and P' ; the latter procedure is to be preferred.

Saddle-pin block.—While it is possible to locate the saddle-pin directly on the link-template, it is convenient to use an adjustable block like that shown by Fig. 6, Pl. XXa, which has two slots through which round-headed screws with steel washers may be passed to clamp it to the link-template. Draw a line pr across the face of the block and square down at the sides to the lower surface. At a point about one-fourth of an inch from the right-hand end locate a point m for the saddle-pin and drill a small hole for the shank of a screw. Place the block on the template with pr on the middle line qr of the template and with m about half an inch from the link-arc and locate holes for the

round-headed clamping-screws so that the block can be moved back or forth half an inch. The holes for the clamping-screws are then to be drilled and the block clamped temporarily in place.

Eccentric-rods, hanger and tumbler-arm.—One of the eccentric-rods is to be laid out with a length equal to the radius of the link-arc minus the distance the link-pins are set back from the arc, and then both rods are clamped together and drilled at both ends with large holes for the bodies of the screws.

The hanger is to be laid out with the proper length and drilled with a large hole at each end. The tumbler-arm is also to be laid out with the proper length and drilled with a small hole at one end and a large hole at the other.

First test of the model.—Assemble the crank-disk, link-template and eccentric-rods, placing proper wooden washers under the backing rod, and place the model in its proper location on the drawing-board with a screw at O , Fig. 2, Pl. XX. To make a preliminary test of the model, place the crank-disk with the forward eccentric at its head-end dead-point and place the link-template so that the point V (Fig. 5, Pl. XXa) comes on the axis XX' , and mark that location by drawing a small portion of its arc near V across the axis with a sharp pencil. Set the same eccentric on the crank-end dead-point and repeat the operation. Make the same construction with the backing eccentric on the axis. If the arcs thus drawn with the two eccentrics on the head-end dead-point intersect, and those drawn with them on the crank-end dead-point also intersect, the link-model is satisfactorily laid out and assembled as far as we have gone.

If this test fails, the trouble may be in one of three places: (1) the lengths of the eccentric-rods, (2) the location of the link-pins, or (3) on the crank-disk. The rods may be tested by interchanging them; if they are found to be right, test the link-template by reversing it; if it also is right the error must be on the crank-disk, which must be tested again by the methods already given. In all the tests for accuracy, the methods given insure

symmetry rather than absolute correctness, namely, such tests show that the eccentrics have the same eccentricity and angular advance, that the eccentric-rods have equal lengths, and that the link-template is symmetrical with regard to its arc and the diameter at its middle point. These are exactly the properties that a link-motion must have in practice; slight variation from absolute dimensions have trifling effect on the valve-action.

Full-gear Lead.—Having the model assembled and tested, it may now be used to ascertain what method of suspension will produce the desired valve-action and to determine completely the effects of that action.

Set the model with the crank at a dead-point, with the crank on the axis XX' , Plate XX, and with the upper link-pin P on the same axis, and draw a short part of the link-arc across the axis with a sharp pencil. Place the crank on the other dead-point and repeat the operation; this will locate the points c and c' , the distance between which should be twice the lap plus twice the full-gear lead, as shown on Zeuner's diagram, Fig. 1, Pl. XX, because the model thus shows twice the valve-displacement from mid-position when the engine is on a dead-point. If there is a slight discrepancy, it may be neglected; a notable difference will demand a reconstruction of the model with stricter regard to actual dimensions as well as symmetry.

In this construction it is important that the link-pin P shall be placed accurately on the axis XX' . One way is to stretch a fine line over the axis across the model and see that the centre of the screw at the point P comes under that line; the inconvenience of this method is due to the fact that the eccentric-rod may be so placed as to require a long line. Another way is to draw a perpendicular to XX' near the location of P and on it establish two points equidistant from that axis; with a pair of compasses the template may be placed equidistant from these reference-marks and consequently exactly on the axis.

Having located c and c' , Fig. 2, Pl. XX, the distance between

them may be bisected and from the middle point o the laps may be laid off on either side, these locating the point n and n' . These points are very important in the future work with the model and it is convenient to locate them by drawing a circle with the proper radius from o , as shown to a larger scale by Fig. 7, Pl. XXa; some draughtsmen draw that circle immediately in ink to make it distinct. Another circle may be drawn at the same time with a radius equal to the exhaust-lap.

Location of Rocker.—The axis of the rocker may be located on a line oT perpendicular to XX' , Fig. 2, Pl. XX; to avoid disturbing the motion of the valve at cut-off and admission, T may be chosen so that an arc from T with a radius equal to the length of the rocker-arm shall pass through n and n' (see also Fig. 7, Pl. XXa). Since the arc through n and n' is short, nearly the same result will be obtained if oT is made directly equal to the length of the rocker-arm, but in such case n and n' will be slightly above the axis XX' .

Location of the Saddle-pin.—As already pointed out the location of the saddle-pin is the most important single item in a link-motion design, and it is fortunately entirely under the control of the designer. A very good action of the valve will usually be obtained if the reverse-shaft is so located that its arm shall be horizontal when the link is in mid-gear, and if the saddle-pin be then located to equalize the cut-off at one-third stroke. For this purpose we may proceed as indicated on Plate XX, and more distinctly by Fig. 7, Pl. XXa. First, the model may be placed with the crank at R' corresponding to cut-off at one-third stroke, and the link-template may be moved till its arc comes to the point n' , which corresponds to a valve-displacement equal to the steam-lap as should be the case at cut-off. Draw a bit of the link-arc and mark the ends of the line $q'r'$, and after the model is moved aside draw that line on the paper. Repeat the operation with the piston at one-third stroke at the other end of the cylinder and so locate the line qr . With the location

of the reverse-shaft already decided upon, the path of the saddle-pin while the template moves from $q'r'$ to qr , will be very nearly horizontal. Consequently the saddle-pin m may be located on Fig. 7, Pl. XXa, by drawing by trial a horizontal line mm' which shall be so placed that mr shall be equal to $m'r'$. Having determined this distance, mr or $m'r'$, which the saddle-pin shall be placed back from the link-arc, the block shown by Fig. 6, Pl. XXa, may be properly located and clamped to the link-template.

Location of the Reverse-shaft.—The centre of the reverse-shaft arm S , Fig. 2, Pl. XX, may now be located as follows: Bisect the line mm' (shown also on Fig. 7, Pl. XXa) by a line perpendicular to the axis XX' and on it locate N_0 at a distance from the axis equal to the length of the hanger; draw N_0S parallel to the axis and make it equal to the length of the reverse-shaft arm. Drill a hole in the drawing-board at S and connect up the hanger with wooden washers at N and m' to give proper clearance so that the model may work freely.

Final Test of Model.—Having the model connected, the crank should be set to give cut-off at one-third stroke at one end, as at R' , Fig. 2, Pl. XX; the reverse-shaft arm is to be raised or lowered till the link-arc touches the corresponding lap-point n' ; place a weight on the reverse-shaft arm and turn the model till the link touches the other lap-point n ; if the crank is now at the proper point R , corresponding to one-third stroke, the model is ready for service. If there is any discrepancy, it may be eliminated by shifting the saddle-pin m a slight distance.

Alternate Location of Reverse-shaft.—If the ratio of crank to connecting-rod is unfavorable, it may appear in the investigation of the valve-action that the cut-off may be very unequal at and near full-gear. Sometimes a better action can be had by a different location of the reverse-shaft, by aid of which the cut-off may be equalized at another point of the stroke.

Suppose that the work has proceeded as already described so far as the location of the saddle-pin, and that the reverse-shaft

is to be located so as to give equal cut-off also at two-thirds stroke. For this purpose let the model be set so that the crank comes at R_a , corresponding to two-thirds stroke at one end, as indicated by Fig. 2, Pl. XXI, and let the template be moved so that the link-arc touches the lap-point n ; again place the crank at R_b , corresponding to two-thirds stroke at the other end, and move the template till it touches the other lap-point n' ; the two positions m_a and m_b of the saddle-pin are to be located on the paper when the template is in the proper positions. Now take m_a and m_b as centres and with the length of the hanger as a radius draw arcs intersecting at N_a . The entire operation may now be repeated in backing gear, but the construction thus made will be found to be symmetrical with that for forward gear, and the corresponding locations of the saddle-pin, m_a' and m_b' , will be symmetrical with m_a and m_b and can be located above XX' directly without the trouble of a second construction. With m_a' and m_b' as centres and with the hanger as a radius, arcs are to be drawn intersecting at N_b . With N_a and N_b as centres and the length of the arm N_aS' as a radius, arcs are to be drawn intersecting at S' , the alternate location of the reverse-shaft.

This location of the reverse-shaft is likely to disturb the equalization of cut-off at one-third stroke; this can be tested as described on page 70, and an adjustment can be made which in turn is liable to derange the cut-off at two-thirds stroke, but unless this latter effect is pronounced no attention need be paid to it.

Comparing Plates XX and XXI, it is evident that S' , the alternate location of the reverse-shaft, is nearer XX' than is S , the original and simpler location; not unfrequently such a location will make it interfere with the eccentric-rods in backing gear.

This alternate method lacks precision, since the points m_a and m_b , and also m_a' and m_b' , are too near together to give a satisfactory determination of the points N_a and N_b ; but in compensation, so long as the construction is symmetrical, a con-

siderable deviation of the shaft from S' will have comparatively little effect on the valve-action.

Lead, Port-opening and Slip.—After the locations of the saddle-pin and reverse-shaft are completed, the model is then to be used to test the action of the link in all grades, forward and backing. To do so, place the reference-mark on the crank-disk, at the crank-position corresponding to a chosen piston-position (for example, at half-stroke forward); adjust the link-template so that its arc shall come to the point n , Fig. 2, Pl. XX, and place a weight on the reverse-shaft arm. Turn the crank-disk and thus move the model till the link-template comes to the point n' ; note the position of the reference-mark on the crank-template, and find and record the corresponding position of the cross-head on its path xx' .

With the same setting of the model find the lead, port-opening and slip. The first will be found by placing the crank on the dead-points. The second must be found by noting the greatest displacement of the link-arc from n toward the right, and from n' toward the left; these quantities are to be measured on a horizontal chord, not on the arc, since they represent the valve-displacements minus the lap. To find the slip, find and mark the highest point on the link-arc that comes to the arc through nm' , and also the lowest point; the distance between these points is the slip of the link-block.

This investigation of the action of the link should be carried on systematically for a sufficient number of points of the stroke, and recorded in a table similar to that on page 78.

Should the action of the link-motion be deemed unsatisfactory, experiments may be made by changing the various dimensions of the link, so far as possible, following the general directions on page 57. It is probable that the most troublesome element will be the slip of the link-block due to the attempt to equalize the cut-off, and with the method of suspension shown on Plates XIII and XX this is worse in forward than in backing

gear. When feasible, this unfortunate condition may be reversed by supporting the link from below, with which arrangement the slip in forward gear will be less than in backing gear.

In this use of the model it will be found that the forward eccentric-rod will strike the washer placed at e' , Fig. 2, Pl. XX. Perhaps the required setting can be obtained by turning the model in the reverse direction, or the requisite freedom may be had by cutting a notch at v ; or the rod may be reversed and another notch can be cut at w .

It is clear that a similar model can be made for the Gooch link-motion or for other gears like those described in the following chapter.

To Set a Link-motion.—If a link-motion is designed for equal lead, it is set by a method like the first method for setting a slide-valve with equal lead. Place the link at full-gear forward; with the proper angular advance as near as may be for each eccentric and with the engine on a dead-point give the valve the proper lead; turn the engine onto the other dead-point, and if the valve does not then give the proper lead, change the length of the eccentric-rod by half the error or obtain the same result by changing the length of the valve-spindle, and shift the eccentric till the proper lead is obtained. Place the link at full-gear backing and set the valve again, changing the length of the eccentric-rod and the angular advance as may be necessary. Now place the link again at full-gear forward, and see if the setting has been disturbed by the changes of the backing eccentric and eccentric-rod; if it has, the valve must be reset by the same method. Place the link again in full-gear backing, and make any correction needed; very commonly none will be required. When a link-motion is designed to give unequal leads (a common practice on marine-engines), the process differs only in that the lead at each end must be made the proper amount.

The second method given on page 34 cannot be used in setting

a link-motion, since the maximum port-openings are not likely to be equal.

A rocker for a link-motion is designed to avoid interference with lead and cut-off (Fig. 7, Pl. XXa), and when the valve is set this condition should be considered. A horizontal link-motion like Fig. 1, Pl. XIII, will have the rocker set to swing equally from a plumb-line through *T*, when the engine is at the dead-points.

The eccentric-rods for the link-motions on Plates XIII and XIV are joined to the eccentric-straps by T-heads and bolts. The length of the rods may be adjusted by placing slips of metal called shims under the head—a method which may appear crude but is really convenient and effective. The bolt-holes through the shims can be slotted through to one side in order that a shim may be put in or withdrawn without taking out the bolts.

Application of Skeleton Model.—To illustrate the method, and to show the influence of changing some of the parts of a link-motion, there are given here the results of the application of the skeleton model to a few examples.

The following dimensions were used in all the examples:

Eccentricity.	3 inches
Steam-lap.	$\frac{3}{4}$ inch
Radius of link-arc.	48 inches
Length of hanger.	16 “
Length of reverse-arm.	20 “
Length of rocker-arm (when used).	12 “
Stroke.	24 “
Ratio of crank to connecting-rod.	1:5

In all the examples except that shown by Table II the distance from the centre of the eccentric to the link-arc was equal to the radius of the link-arc; the length of the eccentric-rods from the centre of the eccentric to the link-pins was made less or more than this distance according as the link-pins were back

of or ahead of the link-arc, except for the example shown by Table V, which had the link-pins on the link-arc. The saddle-pin in all cases is at the middle of the length of the link. Other dimensions of the link-motion and details of the arrangement are given with the tables.

In the example shown by Table I the reverse-shaft was set square, i.e., with the arm horizontal at mid-gear as shown on Pl. XX, and the cut-off was equalized at $\frac{1}{3}$ stroke only. This may be considered to be the typical example. The lead at full-gear, or with the cut-off at $22\frac{1}{2}$ inches, is small, but increases rapidly as the cut-off is shortened, till it is nearly half an inch when the cut-off is at quarter stroke; meanwhile the travel and port-opening both decrease rapidly. The travel of the valve in full-gear is more than twice the eccentricity, due to the slip of the link-block and to other irregularities.

TABLE I.

Rocker used—link-pins $2\frac{7}{8}$ inches back of link-arc.
 Cut-off equalized at $\frac{1}{3}$ d stroke.
 Saddle-pin $\frac{3}{32}$ of an inch back of link-arc.
 Distance between link-pins 14 inches.

Cut-off.			Lead.	Slip.	Travel.	Port-opening.
a H.E.	b C.E.	Diff. a & b.				
6	$5\frac{15}{16}$	$\frac{1}{16}$	$\frac{15}{32}$	$\frac{1}{8}$	$2\frac{15}{32}$	$\frac{15}{32}$
9	$8\frac{15}{16}$	$\frac{1}{16}$	$\frac{7}{16}$	$\frac{1}{16}$	$2\frac{1}{16}$	$\frac{1}{32}$
12	$11\frac{7}{8}$	$\frac{1}{8}$	$\frac{1}{16}$	$\frac{1}{4}$	$2\frac{23}{32}$	$\frac{1}{8}$
15	$14\frac{13}{16}$	$\frac{3}{16}$	$\frac{13}{32}$	$\frac{11}{32}$	$3\frac{1}{16}$	$\frac{3}{4}$
18	$17\frac{3}{8}$	$\frac{3}{8}$	$\frac{3}{8}$	$\frac{1}{2}$	$3\frac{19}{32}$	$\frac{1}{32}$
21	$20\frac{3}{8}$	$\frac{5}{8}$	$\frac{9}{32}$	$\frac{7}{8}$	$4\frac{27}{32}$	$\frac{21}{32}$
$22\frac{1}{2}$	22	$\frac{1}{2}$	$\frac{1}{16}$	$1\frac{9}{32}$	$6\frac{3}{16}$	$2\frac{21}{32}$

An inequality in the cut-off of $\frac{1}{4}$ of an inch in 24 inches, i.e., one per cent of the stroke, cannot be distinguished in the running of the engine or on the indicator-diagram; consequently the

cut-off may be considered to be equalized from $\frac{1}{4}$ to $\frac{5}{8}$ of the stroke. The inequality of the cut-off becomes as large as $\frac{5}{8}$ of an inch at 18 and 21 inches; but while such an inequality may possibly be distinguished on an indicator-diagram, it cannot have an appreciable effect on the running of the engine.

In all the examples the gear was made symmetrical; consequently the action in backing gear was almost identical with that in forward gear, and need not be stated separately.

TABLE II.

Rocker used—link-pins $2\frac{7}{8}$ inches back of link-arc.
 Cut-off equalized at $\frac{1}{3}$ d stroke.
 Saddle-pin $\frac{5}{32}$ of an inch back of link-arc.
 Distance between link-pins 14 inches.

Cut-off.			Lead.	Slip.	Travel.	Port-opening.
a H.E.	b C.E.	Diff. a & b.				
6	$5\frac{25}{32}$	$\frac{7}{32}$	$\frac{7}{16}$	$\frac{1}{4}$	$2\frac{7}{16}$	$1\frac{15}{32}$
9	$8\frac{25}{32}$	$\frac{7}{32}$	$\frac{7}{16}$	$\frac{1}{4}$	$2\frac{3}{32}$	$1\frac{17}{32}$
12	$11\frac{1}{4}$	$\frac{1}{4}$	$\frac{13}{32}$	$\frac{9}{32}$	$2\frac{11}{16}$	$1\frac{8}{8}$
15	$14\frac{3}{32}$	$\frac{3}{32}$	$\frac{3}{8}$	$\frac{3}{8}$	$3\frac{3}{32}$	$2\frac{25}{32}$
18	$17\frac{5}{8}$	$\frac{3}{8}$	$\frac{11}{32}$	$\frac{1}{4}$	$3\frac{9}{16}$	$1\frac{1}{32}$
21	$20\frac{5}{8}$	$\frac{3}{8}$	$\frac{11}{32}$	$\frac{25}{32}$	$4\frac{13}{16}$	$1\frac{1}{32}$
$22\frac{1}{2}$	$22\frac{5}{32}$	$1\frac{11}{32}$	H.E. $\frac{1}{8}$ C.E. $\frac{1}{16}$	$1\frac{1}{8}$	$6\frac{5}{16}$	$2\frac{13}{32}$

In this example the eccentric-rods were made one inch longer than in the preceding example, which made the radius of the link-arc one inch shorter than required for the normal condition, i.e., 48 instead of 49 inches. The effect was to reduce the inequality of the cut-off at long cut-off, so that the cut-off may be considered to be practically equal for the entire stroke. The full-gear lead had an inequality of $\frac{1}{16}$ of an inch, but at other grades of the link the lead was sensibly equal. Had the link been set to give equal lead at full-gear, then the mid-gear lead would have had an inequality of $\frac{1}{16}$ of an inch in half an inch, which

would not have any appreciable effect in the running of the engine.

In the third example the cut-off was equalized at $\frac{1}{2}$ stroke and at full-gear as recommended by Auchincloss in his *Link and Valve-motions*, by the method described on page 73 and shown on Pl. XXI. With the ratio of crank to connecting-rod used in these examples, i.e. 1:5, the reverse-shaft was found to interfere with the eccentric-rods at full-gear backing. The table shows that the equalization of the cut-off was nearly perfect from half-gear to full-gear. The inequality in the cut-off increases as the cut-off is shortened, that is, at the place where it has the most deleterious effect; but it must be admitted that an inequality of $\frac{3}{8}$ of an inch in 6 inches cannot have a very bad effect, if indeed it should be distinguishable in the running of the engine. Both the danger of interference of the reverse-shaft with the eccentric-rods and the inequality of cut-off near mid-gear will be found to be less with a more favorable ratio of crank to connecting-rod, or with the cut-off equalized at $\frac{1}{3}$ and $\frac{2}{3}$ stroke as recommended on page 73 and shown on Pl. XXI.

TABLE III.

Rocker used—link-pins $2\frac{7}{8}$ inches back of link-arc.

Cut-off equalized at $\frac{1}{2}$ stroke and at full-gear.

Saddle-pins $\frac{5}{32}$ of an inch back of link-arc.

Distance between link-pins 14 inches.

Cut-off.			Lead.	Slip.	Travel.	Port-opening.
a H.E.	b C.E.	Diff. a & b.				
6	$5\frac{21}{32}$	$\frac{11}{32}$	$\frac{7}{16}$	$\frac{9}{32}$	$2\frac{13}{32}$	$\frac{7}{16}$
9	$8\frac{29}{32}$	$\frac{7}{32}$	$\frac{7}{16}$	$\frac{5}{16}$	$2\frac{1}{2}$	$\frac{1}{2}$
12	12	0	$\frac{13}{32}$	$\frac{13}{32}$	$2\frac{1}{4}$	$\frac{5}{8}$
15	$14\frac{31}{32}$	$\frac{1}{32}$	$\frac{8}{8}$	$\frac{1}{2}$	$3\frac{1}{16}$	$\frac{3}{8}$
18	$17\frac{31}{32}$	$\frac{1}{32}$	$\frac{5}{16}$	$\frac{21}{32}$	$3\frac{5}{8}$	$\frac{1}{16}$
21	$20\frac{13}{16}$	$\frac{1}{16}$	$\frac{3}{16}$	I	$4\frac{1}{8}$	$\frac{3}{16}$
22 $\frac{1}{2}$	$22\frac{13}{32}$	$\frac{3}{32}$	H.E. 0 C.E. $\frac{1}{16}$	$1\frac{1}{4}$	$6\frac{1}{2}$	$2\frac{1}{2}$

The fourth example had the reverse-shaft set square and differed from the first example in that the link was made shorter, i.e., 12 instead of 14 inches between the link-pins; the link-pins were also set back 3 inches instead of $2\frac{1}{8}$, but such a change has not much effect. A comparison of this table with Table I will show that shortening the link increases the irregularities of the link-motion, and especially that it increases the slip at all gears.

TABLE IV.

Rocker used—link-pins 3 inches back of link-arc.
Cut-off equalized at $\frac{1}{4}$ d stroke.
Saddle-pin $\frac{3}{32}$ of an inch back of link-arc.
Distance between link-pins 14 inches.

Cut-off.			Lead.	Slip.	Travel.	Port- open- ing.
a H.E.	b C.E.	Diff. a & b.				
6	$5\frac{7}{8}$	$\frac{1}{8}$	$\frac{3}{8}$	$\frac{5}{8}$	$2\frac{5}{16}$	$\frac{13}{32}$
9	$8\frac{11}{16}$	$\frac{1}{16}$	$\frac{3}{8}$	$\frac{11}{16}$	$2\frac{13}{32}$	$\frac{15}{32}$
12	$11\frac{11}{16}$	$\frac{1}{16}$	$\frac{11}{32}$	$\frac{3}{4}$	$2\frac{9}{8}$	$\frac{9}{16}$
15	$14\frac{5}{8}$	$\frac{3}{8}$	$\frac{8}{16}$	$\frac{5}{8}$	$2\frac{15}{16}$	$\frac{3}{4}$
18	$17\frac{3}{8}$	$\frac{5}{8}$	$\frac{6}{16}$	$\frac{15}{16}$	$3\frac{1}{2}$	1
21	$20\frac{3}{8}$	$\frac{5}{8}$	$\frac{7}{32}$	$1\frac{1}{4}$	$4\frac{13}{16}$	$1\frac{5}{8}$
$22\frac{1}{2}$	22	$\frac{1}{2}$	H.E. $\frac{3}{32}$ C.E. $\frac{1}{16}$	$1\frac{3}{4}$	$6\frac{7}{16}$	$2\frac{7}{16}$

Example five was chosen to represent the type of link-motion which acts directly on the valve-spindle without the intervention of a rocker, and, as is customary, has the link-pins on the link-arc. It may be compared with Table IV, which has the link-pins the same distance apart. The equalization of cut-off from $\frac{1}{4}$ to $\frac{5}{8}$ stroke is good, though not perfect, and the inequality at and near full-gear cannot have a very bad effect, though it is much larger than in the fourth example. The slip is less than for that example at all grades; but probably the slip could be much reduced in such a link-motion with a rocker, if the link-

pins were placed nearer the link-arc or on the link-arc. Such an arrangement would show greater inequality in cut-off than is found in Table IV.

TABLE V.

Link acts directly on valve-spindle without rocker.
 Link-pins on link-arc.
 Cut-off equalized at $\frac{1}{3}$ d stroke.
 Saddle-pin $\frac{1}{2}$ of an inch forward of link-arc.
 Distance between link-pins, 12 inches.

Cut-off.			Lead.	Slip.	Travel.	Port-opening.
a H.E.	b C.E.	Diff. a & b.				
6	$6\frac{3}{8}$	$\frac{3}{8}$	$\frac{3}{8}$	$\frac{2}{16}$	$2\frac{5}{16}$	$\frac{13}{32}$
9	$9\frac{1}{16}$	$\frac{1}{16}$	$\frac{3}{8}$	$\frac{7}{32}$	$2\frac{1}{32}$	$\frac{15}{32}$
12	$11\frac{3}{4}$	$\frac{1}{4}$	$\frac{3}{8}$	$\frac{1}{4}$	$2\frac{3}{32}$	$\frac{9}{16}$
15	$14\frac{5}{8}$	$\frac{3}{8}$	$\frac{11}{32}$	$\frac{5}{16}$	$2\frac{3}{8}$	$\frac{11}{16}$
18	$17\frac{1}{8}$	$\frac{1}{8}$	$\frac{11}{32}$	$\frac{3}{8}$	$3\frac{3}{8}$	H.E. $\frac{1}{8}$ C.E. $\frac{7}{8}$
21	$20\frac{3}{16}$	$\frac{1}{16}$	$\frac{7}{32}$	$\frac{1}{2}$	$4\frac{5}{8}$	H.E. $\frac{5}{8}$ C.E. $1\frac{1}{2}$
$22\frac{1}{2}$	$21\frac{7}{8}$	$\frac{5}{8}$	$\frac{3}{32}$	$\frac{5}{8}$	$6\frac{1}{16}$	H.E. $2\frac{3}{8}$ C.E. $2\frac{1}{16}$

The sixth example was chosen to show the effect of placing the link-pins *ahead* of the link-arc, on a link which acted directly on the valve-spindle without the intervention of a rocker. Such an arrangement would require the use of a side-bar link or a box-link (shown by Fig. 1, Pl. XIV, and Fig. 3, Pl. XVIII), and might involve some mechanical difficulties.

The equalization of the cut-off must be considered to be satisfactory, but it is attained at the expense of an excessive slip of the link-block. Probably a compromise between the link-motions shown by Tables V and VI, having the link-pins an inch or an inch and a half ahead of the link-arc, would be found to give a fair equalization of the cut-off without excessive slip. Also greater distance between the link-pins (14 instead of 12 inches) could be used with advantage.

TABLE VI.

Link acts directly on valve-spindle without rocker.

Link-pins 3 inches ahead of link-arc.

Cut-off equalized at $\frac{1}{2}$ d stroke.

Saddle-pin $1\frac{1}{8}$ of an inch ahead of link-arc.

Distance between link-pins, 12 inches.

Cut-off.			Lead.	Slip.	Travel.	Port-opening.
a H.E.	b C.E.	Diff. a & b.				
6	$6\frac{3}{8}$	$\frac{3}{8}$	$\frac{3}{8}$	$1\frac{23}{32}$	$2\frac{9}{32}$	$\frac{3}{8}$
9	$8\frac{31}{32}$	$\frac{3}{32}$	$\frac{3}{8}$	$1\frac{11}{16}$	$2\frac{3}{8}$	$\frac{7}{16}$
12	$11\frac{15}{16}$	$\frac{1}{16}$	$\frac{11}{32}$	$1\frac{21}{32}$	$2\frac{3}{8}$	$\frac{7}{16}$
15	$14\frac{3}{4}$	$\frac{1}{4}$	$\frac{5}{16}$	$1\frac{21}{16}$	$2\frac{13}{16}$	$\frac{21}{32}$
18	$17\frac{11}{16}$	$\frac{5}{16}$	$\frac{1}{4}$	$1\frac{5}{8}$	$3\frac{1}{4}$	$\frac{7}{8}$
21	$20\frac{11}{16}$	$\frac{5}{16}$	$\frac{3}{16}$	$1\frac{8}{8}$	$4\frac{3}{4}$	$1\frac{1}{16}$
$22\frac{1}{2}$	$22\frac{3}{8}$	$\frac{1}{8}$	$\frac{1}{32}$	$1\frac{5}{8}$	$6\frac{7}{8}$	$2\frac{1}{16}$

CHAPTER IV.

RADIAL VALVE-GEARS.

THE name radial valve-gear has been applied to a number of reversing-gears that differ widely in detail and in general appearance, but agree in that they derive the mid-gear motion of the valve from some source that is equivalent to an eccentric with 90° angular advance, and they combine with this motion another that is equivalent to that of an eccentric with no angular advance. The general conception of this form of valve-gear is most easily obtained from an example.

Walschaert Gear.—This gear is chosen as the first example of the type because the elements are easily distinguished. In Fig. 1, Pl. XXII, H is the engine cross-head, and a is the head of the valve-spindle. The valve is moved through a radius-rod, one end of which carries a block that may be set at any position in a slotted link dF , and the other end takes hold of a combining-lever aj , that receives motion from the engine cross-head. The slotted link swings on a fixed trunnion at G and is moved by an eccentric OE , which has no angular advance. In Fig. 2 the diagram in thin lines shows the gear at a dead-point, and the diagram in heavy lines shows the gear when the crank has moved through the angle $C_0O = \theta$.

If the motion of the engine cross-head can be considered to be harmonic, then it is clear that the motion that it gives to the valve could be derived from an eccentric with 90° angular advance; this motion is made equal to twice the lap plus twice the lead. If the

block d is at the middle of the link, the valve will derive motion from the cross-head only and the mechanism will be at mid-gear. The radius of the link-arc is made equal to the length de of the radius-rod, consequently the lead is constant for all settings of the gear. If the point h of the guiding-link hf were a fixed point, then the valve would receive motion from the eccentric OE , which has no angular advance. By placing the link-block nearer the trunnion G the motion is reduced; for example, the motion communicated from the eccentric OE will be half as much if the block is half-way between d and G . If the link-block is below G , the motion is eversed

It is shown in the appendix, that the motion imparted to a valve by this gear can be approximately represented by Zeuner's valve-diagrams like those used for a shifting-eccentric. As usually constructed, this gear does not give harmonic motion to the valve, for the motion of the cross-head of the engine with the usual proportions of locomotives has considerable irregularity on account of the angularity of the connecting-rod; also some irregularity is introduced by the combining-lever af . Consequently such a diagram as Fig. 1, Pl. XXI, can be of use only in roughly blocking out a gear. The real action of the gear can be determined either by constructing diagrams similar to Fig. 2 on as large a scale as convenient, or by aid of a model. A combination of the two methods, similar to the skeleton model for link-motions, may be found convenient for this purpose. Since part of the motion of the valve is derived from the cross-head, the adjustment of the gear to give equal cut-off will generally be easier than for a link-motion.

In laying out a Walschaert gear, the combination-lever af should be made vertical when the cross-head is at the middle of its stroke; the guiding-link hf should be made to vibrate equal angles above and below a horizontal line; a line from G to F on the link should be made vertical when the engine is on a dead-point; and the supporting-link with the reverse-arm ST should

be so laid out that c may be guided nearly on a horizontal line, unless the adjustment may be found to require a different arrangement. The length of the combining-lever should be so chosen that its angular vibration shall not exceed 60° .

The main dimensions of the gear for any engine will be imposed on the designer by the general proportions of the engine and its frame. There are, however, two elements over which the designer will have more or less control: they are the position of the axis of the trunnion G , which in the figures is on the link-arc, but which may be placed either forward of or back of the link-arc; and the reverse-shaft T , which may often be located at will, within limits. The first will be found to have the most influence on the action of the gear.

The eccentric OE is sometimes replaced by a return-crank from the engine-crank C . The link is sometimes turned the other way, in which case the radius-rod extends forward from the head of the valve-rod.

Marshall Valve-gear.—Plate XXIII shows the Marshall valve-gear as applied to the U. S. S. *Yorktown*. In Fig. 1, XX' is the axis of the cylinder, O is the centre of the shaft, and C is the crank-pin. The eccentric centred at E gives motion to a short and massive eccentric-rod EG , which is guided at o by the link oD , and is connected to the valve-spindle V by a valve-rod GV . The guiding-link oD is supported by the bell-crank lever DoS , having its axis at o ; the rod ST gives connection with the reverse-shaft arm TU . In the figure the engine is at a dead-point, so that the guided point of the eccentric-rod coincides in projection with the axis of the bell-crank lever.

Fig. 2 shows the centre-lines of the gear in two positions; the heavy lines are for the full-gear of the valve-motion, and the fine lines are for a gear between that and the mid-gear. OC is the centre-line of the crank; E is the centre of the eccentric; FD is the guiding-link; and oD is the arm of the bell-crank lever, having its axis at o .

When the bell-crank lever is set to give the mid-gear action of the valve, D is found at D_0 , and the guided point F moves on an arc of a circle that nearly coincides with the line OY ; the point E describes a circle, and all other points of the eccentric-rod except F describe ovals that are more or less elongated as they are near or removed from the guided point F . In this setting of the gear the horizontal motion of the point G is made equal to twice the lap plus twice the lead, so that the valve receives a motion like that given by an eccentric having 90° angular advance; as G is beyond F , the eccentric E properly coincides with the crank.

At any other gear than mid-gear, for example with D set for full-gear, the vertical displacement of F will have two components, one along the axis OY , and one perpendicular to it. The second component with some modification is transferred to G and gives to the valve an additional displacement like that from an eccentric with no angular advance. This gear is consequently of the general type described at the beginning of the chapter, but the various irregularities of the gear are so marked that the valve-diagrams similar to Fig. 1, Pl. XXI, cannot be used at all in designing and laying out the gear. Since the guided point F is always brought into coincidence with the axis of the bell-crank lever when the engine is on a dead-point, the lead is the same for all gears.

The cut-off is shortened by making D approach D_0 ; the thin lines show the gear set for a cut-off at about $\frac{3}{8}$ stroke. The engine is reversed by carrying D beyond D_0 toward D'' .

Fig. 3 gives the valve-ellipses for full-gear and for a short cut-off, corresponding with the diagrams in full lines and finer lines shown by Fig. 2. The valve-ellipses show the defect of the gear, which is a marked inequality in the maximum port-opening. This defect may be overcome by an adaptation of Prof. Sweet's method (page 25) for equalizing the cut-off of a plain slide-valve with the aid of a rocker or bell-crank lever.

In some cases the point G is taken between the eccentric

and the guided point, in which case the eccentric is set opposite the crank.

The design of the Marshall valve-gear must be carried out by the aid of diagrams or a model, or by a combination of the two methods, which appears to be well adapted for this work.

Hackworth Valve-gear.—This gear differs from the Marshall gear in having the guided point carried by a block that slides in straight guides and thus avoids the irregularity due to the guiding-link. The irregularity of the valve-motion is less than when the Marshall gear is used, and the maximum port-openings can be made nearly equal. The pressure on the sliding-block is large, especially at full-gear, and unless ample wearing surface is provided the friction and wear are liable to be excessive. In some cases the sliding-block has been provided with rollers to reduce the friction.

Joy Valve-gear.—An example of the Joy valve-gear used on the Pennsylvania Railroad Company's tugboat *Delaware* is shown by Pl. XXIV. XX' is the centre-line of the crank and connecting-rod, xx' is the centre-line of the valve-spindle. The lever abc is guided at one end on a flat arc by the rod gc , and at the other end is attached to the connecting-rod at the point a , which describes an oval having the length a_1a_2 equal to the stroke of the engine. This oval, which is omitted to avoid confusion of the diagram, is symmetrical with regard to the axis XX' , and is slightly more pointed at the cross-head end than at the crank end. The point b , which describes the irregular oval bb_1b_2 , takes the place of the centre of the single eccentric used with the Marshall valve-gear (Pl. XXIII), and acts on the lever bie . The point i of the lever bie is guided on the circular arc jj_1 by the sliding-block B , and the point e , which describes the oval ee_1e_2 , carries the valve-rod ed . The connecting-rod CD , the valve-rod ed , and the rod cg are in one plane; the levers ac and be and the curved guide-

bar ff_1 are double, one system being on each side of the connecting-rod; in the figure the system of levers in front of the connecting-rod is omitted to show the construction more clearly. The guided point i could evidently be guided on the arc ff_1 by a link centred at k ; such a construction is frequently used in marine engines. A comparison of this gear with the Marshall valve-gear will show much similarity. The essential points of difference are : (1) the radius of the guiding-arc ff_1 is always equal to the length of the valve-rod, and (2) the irregularity due to the angularity of the lever bie is compensated by the action of the lever ac , somewhat in the manner that the linkage known as Watt's parallel motion is made to give nearly a straight-line motion. These advantages are attained at the expense of greater complication and cumbersomeness. It may be remarked that the inequality of port-opening, which is the notable defect of the Marshall gear, may be nearly if not quite remedied by making the length of the guiding-link equal to the valve-rod, but such a construction is usually impracticable, since it requires either an impossible length for the guiding-link, or else a short valve-rod and a long valve-spindle that must be guided at the outer end. The guiding-bars ff_1 are hung on trunnions with the axis at the point i_1 , and are connected at f to the reversing-lever. The gear is shown at full-gear for left-handed rotation; it may give a shorter cut-off if the guiding-bars ff_1 are given less inclination from the horizontal or mid-gear position, and when in mid-gear it will give the valve a motion equal to twice the lap plus twice the lead; if the guiding-bars ff_1 are inclined the other way, the engine will be reversed.

This gear, when properly proportioned, gives a rapid motion to the valve when opening and closing, less compression at short cut-off than does a link-motion, and the cut-off can be made nearly equal for all grades of the gear. Like all other radial valve-gears, it gives a constant lead. Its defects are the number of parts and of joints that are liable to wear loose, and the

obstruction that it offers to inspection and care of the crank-pin and cross-head when the engine is run.

To lay out a Joy valve-gear: Choose a point a on the connecting-rod, having a transverse throw equal to twice the maximum displacement of the valve; make the length of the lever ac such that the angle $a_1c_1a_2$ shall not be more than 90° ; draw the centre-line xx' of the valve-stem, and locate the point e_0 opposite the middle-point of the line a_1a_2 ; lay off $e_0e_1 = e_0e_2$ equal to the lap plus the lead; lay off $a_1b_1 = a_2b_2$ equal to about one third of a_1c_1 ; and draw the lines e_1b_1 and e_2b_2 intersecting at i_1 ; this last point locates the axis of the trunnions carrying the guiding-bars jj_1 . If the point i is guided by a link, then the arm carrying the link must be centred at i_1 ; in the figure the position of such an arm is shown by the line i_1k . Finally, the valve-ellipse should be drawn for several grades of the gear; in the figure the valve-ellipse oo_1 has its length equal to the stroke of the engine, and the valve-displacements are magnified fourfold, i.e., $st = 4dod$. Usually the axis xxi of the valve-motion is determined by the general design, and cannot be changed much, if at all. The length of the lever ac will commonly be as great as desirable if the angle $a_1c_1a_2$ is something less than 90° ; it cannot be made shorter without throwing excessive stress on the links and levers. The transverse motion of the point a is properly twice the maximum displacement of the valve, in order that the inclination of the guide-bars jj_1 may not be more than 25° or 30° ; should such a location bring the lever ac too near the shaft, as may be the case when the crank is counterweighted, then a may be placed nearer the cross-head, but at the expense of more inclination of the guiding-bars at long cut-off. The location of the point b is under the control of the designer, and may be used to equalize the cut-off either at that grade at which the engine is to run habitually, or else to give nearly equal cut-off at all grades. The equalization of the cut-off must be made by trial, and no general rule can be given, since the elements, such as the length of the lever

ac and the distance between the axes xx' and XX' , over which the designer has little control, have a large influence. A skeleton model may be used to advantage in this work. It should have rods to represent the connecting-rod, the levers ac and be , and the links cg and ki . The point k will be located on an arc of a circle centred at i_1 . The points i and b on the levers be and ac should be made adjustable; the first by mounting it on a sliding-block that can be clamped in any desired position, and the second by that method, or by a series of holes to receive the screw representing the pin at b . It may be found advantageous to provide pieces, properly guided, to represent the cross-head and head of the valve-spindle, but a simple model may be made by placing these points by hand on the lines XX' and xx' for the several positions of the model, and the centre C may in like manner be placed on the circle $CC'C'$.

CHAPTER V.

DOUBLE VALVE-GEARS.

A PLAIN slide-valve, set to give an early cut-off, is liable to give either an excessive compression or an early release, or both. A single valve under the control of a gear that gives a variable cut-off, such as a shifting-eccentric or a link-motion, is open to the same difficulties; and in addition the compression varies with the cut-off, though to a less degree. For a stationary engine a large compression may be undesirable, and a varying compression is always so. To avoid these difficulties two valves are frequently used: one, called the main valve, has an unvariable motion, and gives the admission, release, and compression; the other, called the cut-off valve, gives the cut-off only, which may be varied without affecting the other events of the stroke.

The cut-off valve may be placed in a separate valve-chest, as shown by Fig. 3, Pl. XXV, or it may be placed on the back of the main valve, as shown by Fig. 1, Pl. XXVI; thus giving rise to two separate types of double valve-gears. It is important to obtain a clear conception of the principles of double valves, and then all existing forms of double valve-gears may be readily understood, and a gear for a given purpose may be easily designed, or else it may be shown that a satisfactory design is impossible.

take
Cut-off Valve in a Separate Valve-chest.—The usual arrangement of this valve-gear is shown by Fig. 3, Pl. XXV. The main valve, which receives motion from an eccentric with constant

angular advance and eccentricity, is designed to give the desired release and compression, and is set to give equal lead; it will be observed that either the release or the compression may be equalized. In the figure there is no exhaust-lap; this arrangement may be frequently found desirable, but it is chosen here for the sake of simplicity, and will be adhered to throughout the chapter; attention will be given exclusively to the cut-off, since the other features of the gear are the same as for a plain slide-valve and have received sufficient attention in the first chapter.

In the figure the valves are shown disconnected from the eccentrics and both in mid-position; they cannot both be in such position when the gear is connected up, but such a drawing is convenient in laying out the valves. The cut-off valve is a rectangular open frame having the acting edges inside. The distance l from one edge of the valve to the opposite edge of the port is the *clearance* of the valve; when the valve is displaced from mid-position an amount equal to the clearance, the cut-off valve gives either *cut-off* or *readmission*. The right-hand edge gives cut-off for the head end of the engine, and readmission for the crank end; it is important that the readmission by the cut-off valve should precede the admission by the main valve, in order that the second steam-chest shall then be properly filled with steam at full pressure.

The steam-port a_0 is for the passage of full-pressure steam only, and may consequently be made from $\frac{1}{2}$ to $\frac{2}{3}$ of the area of the port a , through which exhaust-steam also must pass. Two or more ports are frequently provided in the cut-off valve-seat, and the valve is then known as a gridiron valve; in such case the combined area of all the ports a_0 should be a little in excess of what would be given to one port, to allow for the greater friction in numerous narrow passages. A gridiron valve acting on several narrow ports will require a proportionately less throw.

In Fig. 1, Pl. XXV, OP is the diameter of the valve-circle

for the main valve which gives admission at OR_0 and OR_0' , and cut-off at OR . The eccentric acting on the cut-off valve is given a negative angular advance, i.e., it is less than 90° in advance of the crank; consequently the displacements of the cut-off valve from mid-position are given by a valve-circle, such as OP_0 , having its diameter laid off at an angle δ_0 (the negative angular advance) away from the crank. If the clearance is equal to Ol_2 , then the cut-off by the cut-off valve occurs at OR_2 and the readmission at OR .

A variable cut-off by aid of this gear may be obtained by varying the clearance of the valve, or the throw of the eccentric, or by using a shifting-eccentric. Now, the same effect is produced by increasing the lap (or decreasing the clearance) with a constant eccentricity as is produced by decreasing the eccentricity with a constant lap; consequently an investigation of one of the two methods will serve for both. It will appear that neither will give a good variable cut-off. On the other hand, a satisfactory gear may be had by using a shifting-eccentric.

In Fig. 1, Pl. XXV, the clearance Ol_2 gives cut-off at OR_2 and readmission at OR , coincident with the cut-off by the main valve: and OR_2 is the latest admissible cut-off; for if the clearance is made greater or equal to Ol_1 in order to obtain a later cut-off at OR_1 , the readmission will occur at OR_1' , before the main-valve cut-off, and a double admission of steam will occur. Such a double admission causes a large waste of steam and an irregular action of the engine and cannot be tolerated.

The earliest admissible cut-off is obtained by a clearance equal to Ol_3 , which gives cut-off at OR_3 and readmission at OR_0' . An inspection of the figure shows that the angle R_2OR_3 must, from symmetry, be equal to ROR_0' ; the latter angle depends on the lap of the main valve, and it is at once evident that only a limited range of cut-off can be obtained with such an arrangement.

In practice a gridiron cut-off valve was commonly used and the cut-off was obtained by varying the travel of the valve. For

this purpose a fixed eccentric was connected to the end of a slotted lever or *link*, and motion was communicated to the valve from a link-block that could be set at any desired place in the link. To shorten the cut-off, the link-block was moved toward the fixed end or fulcrum of the link. An idea of this arrangement may be obtained by supposing the radius-rod of the Walschaert gear (Plate XXII) to act on the cut-off valve-spindle; the eccentric should, of course, have a negative angular advance, and only half of the link will be required. The effect of such an arrangement is the same as though the eccentricity were varied, and, just as has been shown to be the case for a gear with varying lap, the range of variation of cut-off depends on the lap of the main valve.

Valve
Cut-off Valve with Shifting-eccentric.—If the cut-off valve in a separate valve-chest is moved by a properly designed shifting-eccentric, the readmission may be kept within the proper limits, i.e. before the admission for one end of the cylinder and after the cut-off for the opposite end by the main valve, and at the same time any desired range of cut-off may be had.

In Fig. 2, Pl. XXV, let OP be the main valve-circle, giving cut-off at OR and admission at OR_0' . Suppose that the cut-off is to vary from OR_1 , corresponding with $\frac{1}{8}$ stroke, to OR coincident with the cut-off by the main valve. Bisect the angle ROR_0' by the line OP_0' , and bisect the angle ROR_1 by the line OP_0 ; then a valve-circle centred at C_0' can be made to give a cut-off coincident with that by the main valve, and readmission coincident with the main-valve admission; while a valve-circle centred at C_0 can give cut-off at OR_1 , and readmission coincident with the main-valve cut-off at OR .

It is convenient to have the shifting-eccentric on an arm centred on the centre-line of the crank, or rather on that line produced, for then the cut-off gear will work equally well in forward and in backing gear on a reversing-engine; but for a stationary engine such an arrangement is not essential. We now have three elements of which one may be chosen at pleasure

and the other two will then be determinate. In the figure the diameter OP_0 of the valve-circle to give early cut-off is made $1\frac{1}{2}$ inches, equal to the eccentricity for the main eccentric; the clearance Ol of the cut-off valve is then determined by the intersection of that circle by the lines OR and OR_1 , and is $\frac{1}{8}$ of an inch. The centre C_0' of the valve-circle to give the cut-off coincident with that of the main valve must be so chosen that it shall pass through O and l'' ; it is on a perpendicular to Ol'' at its middle point. Draw AS perpendicular to the middle point of an imaginary line joining P_0 and P_0' ; then S , the intersection of this line with the axis XX' , is the centre o of an arc on which the point P_0 will travel as the cut-off is shortened. The shifting-eccentric must be swung from a point on the centre-line of the crank produced and at a distance from the centre of the shaft equal to OS ($1\frac{1}{8}$ of an inch); when the crank is at OX this point will be at T . With ordinary proportions for an engine, the point T is liable to fall inside the shaft, or else so near that the construction of an arm for the eccentric will be impossible. A reversing-engine may have the following arrangement: fast to the shaft may be an eccentric with an eccentricity equal to OS and with its centre opposite the crank-pin; this eccentric may carry another having an eccentricity equal to AS ($1\frac{3}{8}$ of an inch); the second or outside eccentric will be turned toward the crank so that its angular advance will be negative. A stationary engine that always runs in one direction may have the swinging arm, for the eccentric controlling the cut-off valve, centred at any convenient point on the line AS produced.

There now remains the determination of the width of the cut-off valve to prevent leakage past the outside edge. The greatest displacement of the valve from mid-position is equal to $OP_0 = 1\frac{1}{2}$ of an inch; consequently the distance in Fig. 3, Pl. XXV, from the outside edge of the valve to the nearest edge of the port should be somewhat greater than $1\frac{1}{2}$ of an inch; it is made $1\frac{9}{16}$ of an inch.

The arrangement shown by Fig. 3, Pl. XXV, has an excessively large steam-chest for the main valve, which gives an undesirable action because the steam in that chest can flow into the cylinder with a decreasing pressure until the cut-off by the main valve occurs; it is commonly said that the steam in that chest takes part in the expansion. This defect can be ameliorated by reducing the height of the main valve and the size of its chest as far as possible; or a piston-valve taking steam in the middle can be used, or some other device may be invented to decrease the space thus affected.

valve
Cut-off Valve on back of Main Valve.—Fig. 1, Pl. XXVI, shows a cut-off valve on the back of the main valve, both being disconnected from their eccentrics and placed in mid-position. When the gear is connected up, such a position of both valves at the same time does not occur, but it is convenient to make a drawing of the valves in that position to show the laps and other dimensions of the main valve, and the clearance and length of the cut-off valve. The main valve is designed to give the desired compression and release, and is set to give equal lead; either the compression or the release may be equalized. The cut-off valve is connected to an eccentric having a large angular advance, so that it is nearly (sometimes exactly) opposite the crank.

In Fig. 3, OP is the diameter of the main valve-circle, and OP_0 is the diameter of a valve-circle showing the absolute displacements of the cut-off valve. At any crank-position, such as OR , the chord Oc intercepted by the main valve-circle shows the displacement of the main valve; represented in Fig. 2 by e . The absolute displacement of the cut-off valve is shown by the chord Ob , intercepted by the cut-off valve-circle; represented by e_0 in Fig. 2. Both of these displacements are toward the left, but the former being the greater, the relative displacement e_x of the cut-off valve with regard to the main valve, and measured from the centre of the main valve, is towards the right, tending to shut the port in the main valve.

The displacement of the cut-off valve, or plate, to the right from the middle of the main valve can be represented by an auxiliary valve-circle having its diameter at OP_x on Fig. 3, and which can be constructed by drawing OP_x parallel and equal in length to the line PP_0 , which connects the points P and P_0 . At the crank-position OR , the absolute displacements of the main valve and the plate, both to the left, are Oc and Ob , and the relative displacement of the plate from the middle of the main valve, toward the right, is bc ; but bc is equal to the chord Oa cut from OR by the auxiliary circle, as can be seen by drawing the lines P_c , P_0b , and P_xa (all of which are perpendicular to OR because they are drawn in semicircles) and further by producing Pc to e and drawing P_0e parallel to OR ; for P_0e is equal to bc and the triangle P_0Pe and OP_xa are evidently equal. A convenient construction for the diameter of the auxiliary circle is to draw an arc from O with a radius equal to PP_0 and another from P with a radius equal to OP_0 , which arcs will intersect at P_x , and we may draw the parallelogram OP_xPP_0 . A second auxiliary circle, OP'_x , drawn below the axis XX' , shows the displacement of the plate to the left, from the middle of the main valve.

It must be remembered that OP_x is not an eccentricity and that the angle P_xOY is not an angular advance, and in general that the auxiliary circle is only a device for solving problems, and represents no part of the engine when completed.

The essential parts of the diagram given in Fig. 3 are repeated in Fig. 4, together with the lap-arc nm' for the main valve and the clearance-arcs ll' and ll'' for the plate. When the displacement of the plate to the right from the middle of the valve is equal to the clearance l , the edge of the plate comes to the edge of the port as indicated by Fig. 1, Pl. XXVII, and we have either cut-off or readmission. Cut-off by the plate comes at OR and readmission at OR' ; at the first position the plate is moving to the right relative to the main valve to close the port, and at the

second it is moving relatively to the left and reopens the port. The cut-off by the main valve comes at OC so that a double admission does not occur; the valves are then in the position shown in Fig. 2, Pl. XXVII. On the other stroke of the engine, cut-off by the plate comes at OR''' and readmission at OR'' , but these events belong to the left-hand edge of the plate and have nothing to do with the right-hand end of the cylinder, so that, in particular, we need not be concerned as to whether the readmission is early enough, as was the case for the valve in a separate valve-chest

Meyer Valve.—A double valve-gear, known as the Meyer valve, is shown by Fig. 2, Pl. XXVIII. The cut-off valve is made in two parts on a valve-spindle with a right and left screw, so that the position of the plates may be adjusted by rotating the valve-spindle; thus the clearance may be changed, and consequently the cut-off may be varied. In order that this may be done while the engine is running, there is a swivel-joint in the valve-spindle between the valve-rod head and the valve-chest, and the tail of the valve-spindle is carried through the head end of the valve-chest, where it reciprocates through a hand-wheel as shown by Fig. 1; the valve-spindle is squared at the end so that it may be rotated by turning the hand-wheel.

An inspection of Fig. 4, Pl. XXVI, shows that the cut-off may be lengthened by increasing the clearance and that it may be shortened by decreasing the clearance. In order that the cut-off may come at a given crank-position, such as OR , the clearance must be equal to the chord cut by that line from the auxiliary circle. If the clearance becomes equal to zero so that the edge of the plate is on the edge of the port when both are in mid-position, then the cut-off comes at OR_0 and the readmission is at a position diametrically opposite. If an earlier cut-off is desired, the plates must be pushed still farther out so that they have a lap; such a lap will be drawn across the other valve-circle, as at mm' , and will indicate that cut-off comes at OR_1 and readmission at OR_2 .

Table
Design of a Meyer Valve.—The main valve as shown by Fig. 2, Pl. XXVIII, has a steam-lap of half an inch, and is moved by an eccentric with an eccentricity of $1\frac{1}{2}$ of an inch; the exhaust-lap is zero. It is set with $\frac{1}{32}$ of an inch lead. With these dimensions the valve-circle OP in Fig. 3 can be drawn, and the cut-off will be found to occur at OR_c ; corresponding, with harmonic motion, to 0.89 of the stroke of the piston:

The steam-port in the valve-seat is $\frac{3}{4}$ of an inch wide, and the steam-port through the main valve may be taken to be $\frac{2}{3}$ as much, or $\frac{1}{2}$ of an inch. The diameter of the auxiliary circle may be assumed to be one inch. With an eccentricity of $1\frac{1}{4}$ of an inch for the cut off valve-eccentric, the parallelogram PP_0OP_x may be drawn locating both the auxiliary circle OP_x and the diameter OP_0 of the circle, showing the absolute displacements of the cut-off valve. The cut-off valve-eccentric has the angular advance YOP_0 , equal to 55° ; it is convenient to know this angle approximately in setting the valves. The dimensions for OP_x and OP_0 are chosen by trial to give a convenient location of the auxiliary circle, with its diameter placed beyond OR_c to avoid the possibility of a double admission.

The largest clearance is $Ol = \frac{3}{16}$ of an inch; the least clearance, or the greatest lap, will depend on the earliest required cut-off. Let it be assumed that the earliest cut-off shall be at OR_1 , corresponding to a piston-displacement $Xa = \frac{1}{8}$ of the stroke, for harmonic motion; then the cut-off valve must have a *lap* equal to $Ol'' = Ol''' = \frac{1}{16}$ of an inch, nearly.

The lower face of the main valve is laid out as for a plain slide-valve, but with the additions demanded by the passage through it. The least width of bridge is equal to the eccentricity less the sum of the lap and the width of port, or $1\frac{1}{2} - (\frac{1}{2} + \frac{3}{4}) = \frac{1}{4}$ of an inch; the width used is $\frac{1}{2}$ of an inch. In like manner the width of the exhaust-space is $1\frac{1}{2} + \frac{3}{4} - \frac{1}{2} = 1\frac{3}{4}$ of an inch; the width used is $2 \times \frac{15}{8} = 1\frac{7}{8}$ of an inch. In order that the edge c of the passage through the valve may not reduce the passage

through the port to less than $\frac{1}{2}$ of an inch, the distance ac is made $1\frac{1}{2} + \frac{1}{2} = 2$ inches; this feature is frequently overlooked and dc is carelessly made equal to ef . In order that the edge g of the valve shall not come to the edge b of the port, the distance bg is made $1\frac{1}{2} + \frac{1}{8} = 1\frac{5}{8}$ of an inch. The valve-face is cut away at a point h , $1\frac{1}{4}$ of an inch from g , thereby giving an overtravel of $\frac{1}{4}$ of an inch. In order that the space $efdc$ may be made small, the height of the exhaust-space is made only $\frac{7}{8}$ of an inch, a dimension that is probably too small to give a perfectly free exhaust.

The length of the cut-off valve must be enough so that steam cannot leak past the inside edge when the valve is set to give the earliest cut-off and when it also has its maximum displacement. In Fig. 2, Pl. XXVIII, the position of the valve to give cut-off at $\frac{1}{8}$ of the stroke is shown by dotted lines; its *lap* is $\frac{7}{16}$ of an inch, and its left-hand edge k is $1 + \frac{1}{8} = 1\frac{1}{8}$ of an inch from e . The length of the cut-off valve is $1\frac{1}{8} + \frac{1}{2} + \frac{7}{16} = 2\frac{1}{16}$ inches. The cut-off valve is shown in section with a clearance of $\frac{3}{32}$ of an inch, which is proper for giving the longest cut-off coincident with that of the main valve; its left-hand edge is $2\frac{1}{16} + \frac{3}{32} = 3\frac{1}{32}$ inches from the edge f of the port ef ; the distance of the edge j of the port from the middle of the valve is made $3\frac{1}{16}$ inches. The half-length of the main valve, over all, is made $4\frac{1}{2}$ inches, and provides an overtravel of $\frac{1}{4}$ of an inch for the cut-off valve when set to give the earliest cut-off. The cut-off valve has an overtravel only when the cut-off comes early in the stroke; the main valve might be somewhat shorter, but an attempt to provide overtravel for the cut-off valve when it gives a long cut-off will make the main valve too short.

The valve-spindle is provided with a right-and-left-hand screw, of which the right-hand part is shown. The thread should be cut only far enough to give the desired variation of cut-off, or some other stop should be provided in order that the engine attendants may not move the cut-off valve too far out, and so get a leakage or even admission of steam past the

inner edge. The spindle is shown in two parts, joined by a right-handed screw and circular nut or sleeve with pins to prevent the joint from jarring loose; this arrangement is to facilitate the assembling of the valve-gear.

In this design the exhaust-lap is made zero and the compression and release are neglected; in practice these features should receive the same attention as is accorded to them in designing a plain slide-valve. Again, the irregularity of the piston-motion due to the angularity of the connecting-rod has been ignored, and the clearance (or lap) of the cut-off valve has been made the same at both ends. This method is commonly followed in practice, but by using proper pitches for the threads on the valve-spindle the cut-off may be equalized at two points of the stroke, for example at $\frac{1}{8}$ and at $\frac{1}{2}$ stroke, and will then be found to be more nearly equal for all parts of the stroke, except for long cut-off, when inequality is of less importance.

Meyer Valve with Cut-off at Inside Edge.—Sometimes the Meyer valve is designed to cut off at the inside edge, as shown by Fig. 4, Pl. XXVIII. It is then convenient to consider that the valve has a lap ab which diminishes as the cut-off is lengthened, and which may become zero and finally change to a clearance, shown by ac when the valve is in the position indicated by dotted lines. The eccentric is given a negative angular advance, i.e. it is set somewhat less than 90° ahead of the crank.

In Fig. 4, Pl. XXVII, the main valve-circle is OP , giving a cut-off at OR , with a lap $On = On''$. Let it be assumed that the earliest required cut-off is at OR_2 , and that the *latest* re-admission must be at OR_1 ; then the auxiliary circle may have its diameter at OP_x , on a line bisecting the angle R_1OR_2 . The diameter of the valve-circle for showing the absolute displacement of the cut-off valve will be found at OP_0 by completing the parallelogram PP_xOP_0 ; the eccentricity for the cut-off valve-eccentric is OP_0 , and the negative angular advance is YOP_0 . The auxiliary circle may be placed lower down, thereby giving

an earlier readmission and at the same time a larger eccentricity, but it cannot be placed higher up. There is no danger of a double admission of steam at a long cut-off, in which regard this form of valve differs from the ordinary Meyer valve.

The Meyer valve is sometimes applied to reversing-engines, like marine or locomotive engines, and in such case it is desirable to have the cut-off valve thrown entirely out of action in the backing motion of the engine because it is impossible to design a motion that shall be satisfactory in both forward and backing gear, and engines of such type habitually run forward and only back occasionally. The valve should then be designed for forward motion only and as such a valve is likely to give a very bad distribution of steam when backing, the plates may be drawn back so far that they will not have any effect in that gear.

Cut-off Valve with Loose Eccentric.—Let the cut-off valve receive motion from an eccentric which may turn freely on the engine-shaft and which is under the control of a shaft-governor; let the clearance of the cut-off valve be unalterable: then the cut-off can be varied by changing the angular advance of the cut-off eccentric.

In Fig. 3, Pl. XXVII, the main valve-circle is OP , and with a lap $on = on'$ the cut-off by the main valve occurs at OR_c . The cut-off eccentric may have its angular advance changed from YOP_0 to YOP'_0 , then the auxiliary circle may change from OP_x to OP'_x . When the position of the diameter OP_0 of the circle, showing the absolute displacement of the cut-off valve, is known, the auxiliary circle may be located by completing the parallelogram PP_0OP_x ; or the centre C_x of the auxiliary circle may be located by completing a parallelogram CC_0OC_x on the half-diameters OC and OC_0 of the main valve-circle and the cut-off valve-circle. Since the side CC_x of this last parallelogram is equal to $OC_0 = \frac{1}{2}OP_0$, it is at once apparent that the locus of the centre of the auxiliary circle is the dotted circle $C_xC'_x$ drawn from

the centre C of the main valve-circle, and with a radius equal to half the eccentricity of the cut-off eccentric. Again, since PP_x is equal to OP_0 , the locus of the end of the diameter of the auxiliary circle is a circle drawn from P as a centre and with a radius equal to the eccentricity of the cut-off eccentric. The locus of the end of the diameter of the auxiliary circle is the more convenient for use in solution of problems.

Let it be assumed that the cut-off shall vary from the crank-position OR_0 , coincident with the cut-off by the main valve, to OR_1 , corresponding to $\frac{1}{4}$ stroke for harmonic motion. Assume the clearance of the cut-off valve and draw the circle $W'W''$. Erect a perpendicular SC_x at the middle of the line OW'' ; it will intersect the locus C_xC_x' at C_x , the centre of the auxiliary circle that will give a cut-off by the cut-off valve coincident with the cut-off by the main valve. In like manner, erect a perpendicular at the middle of the line OW' ; it will locate the centre C_x' of the auxiliary circle that gives a cut-off at OR_1 , corresponding to $\frac{1}{4}$ stroke. By drawing perpendiculars from W'' and W' , the ends of the diameter $OP^{x'}$ and OP_x'' would have been found.

In designing a valve-gear of this type, the clearance of the cut-off valve may be chosen, usually somewhat larger than the width of the port in the main valve; and then the auxiliary circle for maximum cut-off may be given such a diameter that a satisfactory action may be had in that gear. The eccentricity of the cut-off eccentric will be found by completing the parallelogram in the usual way; should the result be an undesirable dimension it may be modified, since the diameter of the auxiliary circle may be varied to a considerable extent. Finally, the auxiliary circle to give the earliest cut-off may be found by the process just stated; it is liable to have a large diameter, and the travel and wear of the cut-off valve is likely to be excessive. In the figure the auxiliary circle which gives a cut-off at $\frac{1}{4}$ stroke is one-third larger than the main valve-circle, and it would be still larger for a shorter cut-off. It may be seen that the maximum diameter of

the auxiliary circle is equal to the sum of the eccentricities for the two eccentrics.

If this gear is used with a shaft-governor, the cut-off by the main valve will commonly be earlier than that shown in Fig. 3—a circumstance that will make the design of a satisfactory gear easier. Moreover, it may be possible to limit the maximum cut-off to half-stroke or less, even though the main valve gives a cut-off beyond half-stroke; in that case the valve mechanism must be so arranged that the cut-off valve cannot act beyond the assumed range of cut-off, otherwise a double admission may occur. These observations are applicable also to the next type of valve-gear.

Cut-off Valve with Constant Travel.—It is desirable that a valve shall overtravel its seat in order that the seat and the face of the valve may wear evenly and remain true. This is seldom possible for all grades of cut-off with a Meyer valve of common proportions, or with a cut-off valve under the control of a loose eccentric. It has been seen that the design of the cut-off valve is conveniently begun by choosing the diameter and position of the auxiliary circle; it will be found that the design of a double valve-gear for a given purpose may be worked out by first finding how the auxiliary circle must be located or changed to give the desired action, and then finding how the cut-off eccentric must move to produce such an auxiliary circle.

Suppose that the auxiliary valve-circle is to have a constant diameter, and that the variation in cut-off is to be produced by swinging the auxiliary circle around the origin O , Fig. 1, Pl. XXIX, from the position OP_x to OP_x' . With a clearance equal to $Ol = Ol' = Ol''$, the first-named auxiliary circle will give cut-off at OR_0 , coincident with the cut-off by the main valve; and the other auxiliary circle, OP_x' , will give cut-off at OR_1 , corresponding to $\frac{1}{2}$ stroke. The diameters of the cut-off valve-circles, showing absolute displacements, are OP_0 and OP_0' , found by completing the parallelograms PP_xOP_0 and $PP_x'OP_0'$. It is

evident that the locus of the point P_0 is the circle P_0P_0' drawn from P as a centre and with a radius equal to the diameter of the auxiliary circle.

The arrangement of the eccentrics for this type of valve-gear is shown by Fig. 2, Pl. XXIX. The centre of the engine-shaft is at O ; on the shaft is the fixed eccentric centred at E , for giving motion to the main valve; the cut-off eccentric is carried by the main eccentric, and is shown by the full-line circle with its centre at E_0' , corresponding to OP_0' in Fig. 1, while the dotted circle shows it with the centre at E_0 , corresponding to OP_0 in Fig. 1. The cut-off eccentric may readily be placed under the control of a shaft-governor.

The main valve represented by Fig. 3, Pl. XXIX, has a lap of $\frac{1}{2}$ of an inch, and is moved by an eccentric having $1\frac{1}{2}$ of an inch eccentricity, and is consequently a reduplication of the main valve for the Meyer valve-gear shown on Pl. XXVIII, at its lower surface; the top is of course laid out after the cut-off valve has been designed. The main valve-circle has its diameter at OP , Fig. 1, and the cut-off by that valve occurs at OR_c . The cut-off valve is a double-ported or gridiron valve, each of the ports being $\frac{1}{4}$ of an inch wide. The clearance of the cut-off valve is assumed to be $\frac{3}{8}$ of an inch, represented by the circle $l'l''$. As the auxiliary circle swings toward the right to give an earlier cut-off, the readmission moves through the same angle toward the line OR_c , the crank-position at cut-off by the main valve; and it is at once evident that the readmission must not be earlier than OR_c , otherwise a double admission may occur. The smallest admissible auxiliary circle will have its centre on the line OS bisecting the angle R_1OR_c , and it will pass through the points l' and l'' at the intersection of the clearance-circle by the lines OR_1 and OR_c . The diameter chosen for the auxiliary circle is $\frac{3}{4}$ of an inch, or twice the clearance of the cut-off valve. The extreme positions, OP_x' and OP_x , of the auxiliary circle are so located that they shall pass, one through l' and the other

through l'' ; they give cut-off at OR_1 and at OR_c . The corresponding diameters of the cut-off valve-circles are OP_0' and OP_0 , found by completing the parallelograms P_xPP_0O and $P_x'PP_0'O$. The cut-off eccentric is mounted on the main eccentric and has an eccentricity, referred to that eccentric, of $\frac{3}{4}$ of an inch, equal to the diameter of the auxiliary circle.

In laying out the cut-off valve and the upper surface of the main valve, it is convenient to begin in Fig. 3 by placing the port a in a convenient position near the exhaust-space e . From the right-hand edge of this port lay off $\frac{3}{4}$ of an inch to c , the left-hand edge of the outer part of the cut-off valve; this is equal to the greatest displacement of that valve, and insures that the edge c shall not overrun and contract the port a . From c lay off somewhat more than $\frac{3}{4}$ of an inch, in this case $\frac{11}{16}$ of an inch to the left-hand edge of the port b ; this gives the necessary length of the bar cd in order that leakage may not occur past the edge c at the maximum displacement toward the right. The clearance, $\frac{3}{8}$ of an inch, is laid off from the right-hand edge of the port b , to determine the edge d of the bar cd . The inner right-hand bar is made as wide as cd . The left-hand half of the main valve and the cut-off valve is a counterpart of the right-hand half.

The cut-off valve-spindle takes hold of a lug on one of the bars of the gridiron cut-off valve; and the main valve-spindle passes through a tube or passage bored out through the middle of the main valve.

To Set a Double Valve-gear.—Set the main valve to give equal lead; the cut-off by that valve has little influence on the running of the engine, and requires little or no attention. If the cut-off valve is designed to cut off at a definite point when the engine is running under normal conditions, equalize the cut-off by that valve at that point. If the load on the engine and the cut-off are variable within a limited range, the valve should be set to give the least irregularity within that range;

it will usually be sufficient to equalize the cut-off for the middle of the range. If the range of cut-off is wide, it will often be impossible to get a good action for the entire range, and then it will be advisable to equalize the cut-off for some early point in the stroke of the piston. It has already been pointed out that the Meyer valve may have the cut-off equalized at two points of the stroke by using unequal pitches for the screws on the valve spindle.

CHAPTER VI.

DROP CUT-OFF VALVE-GEARS.

IN this chapter there will be given descriptions of a few special forms of valve-gears, selected, partly at random, from the large variety of such gears employed by the builders of automatic cut-off stationary engines. All are of the four-valve type of valve-gears, and all give a drop or disengagement cut-off. A description and analysis of these few forms will enable the student to analyze and understand other gears of similar types.

Brown Engine Gear.—Fig. 1, Pl. XXX, gives a section through the head-end valves and valve-chests of the Brown engine; the crank-end valves and gears are a duplication of those for the head end. The admission-valve *V* is a five-ported gridiron valve on a vertical valve-seat, and the exhaust-valve is a three-ported gridiron valve on a horizontal seat. Both are controlled by valve-gears on the shaft *O*, which is driven by the engine-shaft through a pair of equal bevel-gears and which makes one revolution for each revolution of the engine. It is clear that four such valves might be driven directly by one eccentric on the engine-shaft, or by four eccentrics on the shaft *O*, and that in such case the four valves would be equivalent to one plain slide-valve, and would be designed by the principles laid down in the first chapter.

The eccentric *E*, which moves the steam valve-gear, is set to one side of a vertical through *e*, so that it gives a slow upward motion to the lever *je*. The toe of the lever *je* catches

under the edge of the latch L , and lifts the valve V through the spindle SV . When the tail of the latch strikes the pin d , the valve is disengaged from the lever je , and it falls shut; a dash-pot P checks the fall of the valve and prevents jar. The pin d on the arm bd is under the control of the governor through the horizontal shaft b . It is commonly said that the governor on an engine with a detachment cut-off gear has only the light duty of setting the stop (in this case the pin d) that unlatches the gear and releases the valve; the friction of the governor and the attached parts is, or should be, small. Most such gears throw a shock on the governor, tending to disturb it and make it race when the cut-off valve is released; and the governor should be sufficiently powerful to resist the shock. In this gear, when the tail of the latch L strikes the pin d , the shock tends to open the later and to throw the pin toward the left; both will yield, but the motion of d , and consequently of the governor, is slight.

The exhaust-valve is moved by the cam C , which consists of a groove, in the face of a disk, in which works a roller on the end of the lever trS' . The end S' of the lever is slotted and provided with a block to avoid bending the valve-spindle $V'S'$. The action of this cam is equivalent to that of an eccentric, except that there are periods of rest when the valve is open or shut. Fig. 2 shows two ways of laying out such a cam; it is intended to show general principles only, and would require some modification to fit it to the engine shown by Fig. 1. Let it be supposed that the cam acts directly on the end of a horizontal valve-spindle, such as $V'S'$, Fig. 1, and that its centre is on a prolongation of the path of the valve-spindle. Suppose, further, that the cam turns toward the left, and that the valve shall begin to open when the line Od is horizontal, and be wide open when Ob is horizontal. To give a uniform motion to the cam, make the curve 1, 3, 7 an arc of an Archimedean spiral; this is done by dividing the angular space bd and the linear space

$r'7$ into the same number of equal parts, and by drawing intersecting arcs and radii, $6'6$, $O6$, $5'5$, $O5$, etc., as shown. The cam from b to c is a circular groove, so that the cam remains at rest till the line Oc comes into coincidence with the path of the valve-spindle. The groove from the line Oc to the line Oa is so designed that it gives a harmonic motion. On the line $r'7$ a semicircle is drawn, and its arc and the angular space cOa are divided into the same number of equal parts; arcs and radii are drawn intersecting at 1, 2, 3, etc. Finally, the cam from Oa to Od is a circular arc, giving a period of rest. The second construction, giving harmonic motion, is to be preferred for heavy valves having a rapid motion, in order that they may start and stop easily and quietly; for valves that move slowly and have a large frictional resistance, the first construction may be preferable, but the cam should be modified by rounding the corners at 1 and 7, to avoid a shock at starting and stopping. The positions of the lines Ob , Od , Oa , and Oc may be chosen by the designer so that the time and rate at which the valve opens and shuts may conform to the requirements of his design and to the dictates of his judgment and experience.

The cam in the figure has a symmetry with regard to the axes xx' and yy' that suggests the resemblance of its action to that of an eccentric.

It is neither necessary nor customary to balance valves of the type used on the Brown engine, for they have little pressure on them to produce friction when they are moving, and when they are shut they are at rest. It is usual and advisable to set the exhaust-valve to give compression nearly up to the steam-pressure in the steam-chest, so that the pressure under the steam-valve is nearly equal to the pressure on it at admission. The valve drops shut at cut-off, and after it is at rest the steam-pressure in the cylinder is reduced by expansion. The expansion is carried down to within a few pounds of the back-pressure, so that at release the pressure on the exhaust-valve is not excessive;

at compression the pressure in the cylinder rises after the valve is at rest.

A feature common to many detachment cut-off gears can be well shown by reference to Fig. 1, Pl. XXX. Let it be supposed that the eccentric *E* has no angular advance, and that the valve has no lead; then the valve will open at the beginning of the stroke, and will have its greatest displacement, provided that it is not sooner released, when the piston is at or near half-stroke. If the latch has not then struck the pin *d*, it will not strike it at all, and the valve will remain connected to the gear, and will close at or near the end of the stroke. It is also evident that giving angular advance to the eccentric and lap to the valve will limit still further the range of cut-off. In this gear, however, the cut-off may be continued beyond half-stroke by giving a negative angular advance to the eccentric and a clearance to the valve. If an engine with a detachment cut-off that is limited to the first half of the stroke is overloaded, there is a liability that a failure to cut off will occur, in which case the sudden increase of work due to the steam following the piston to the end of the stroke will make the engine run very irregularly.

Corliss Valve-gear.—Of all types of detachment valve-gears, that invented by Corliss has been most widely known and has received the most favor. A modification of this gear designed by Mr. Edwin Reynolds is shown by Plate XXXI, which represents the valve-gear on the intermediate cylinder of the triple-expansion engine in the Engineering Laboratories of the Massachusetts Institute of Technology.

The Corliss type of engine has two steam-chests, *S* for the supply and *R* for the exhaust; the latter is separated from the cylinder in order that the exhaust-steam may not chill it. This arrangement produces a somewhat rectangular casting containing the steam-chests and the cylinder, at the four corners of which are placed four valves, two of which, *V* and *v*, are admission- or steam-valves, and the other two, *W* and *w*; are exhaust-

valves. The valve-seats are bored cylindrical and the faces of the valves are turned to fit; the valves bear on half a circle or less, and are so connected to the valve-spindles that they may follow the valve-seats without cramping the valve-spindles. The valve-spindles, which are at right angles to the axis of the cylinder, project through stuffing-boxes and carry cranks on the ends, by means of which the valves are turned on their seats. The exhaust-valves W and w have their valve-cranks WD and wd connected directly to pins A and a , in a wrist-plate O , which receives a harmonic oscillation from an eccentric on the engine-shaft. The admission-valves take steam on their inner edges as shown at V , and their cranks carry blocks as shown at the crank-end. In the figure a section is taken just behind the crank Vh , which is represented by a dotted line only, in order to show the disengagement-latch zTh , which engages the block h and is carried by the bell-crank lever EVT ; the lever EVT is connected by the link EB to the wrist-plate. The latch is opened when the finger Tz strikes the stop x on the ring xq ; the ring is placed under the control of the governor through the cut-off rod NM and the double-armed bell-crank lever Mlm , to which the governor-rod is attached at l . The linkage made up of the valve-crank, valve-rod, and wrist-plate, for example $Oadw$, is designed to give a slow motion when the valve is closed, and a rapid motion when opening or closing. The figure shows the wrist-plate and valves in mid-position, the eccentric being erect. The exhaust-valve w has its edge on the edge of the port; its crank moves through the angle dwd_2 , while the wrist-plate oscillates through the angle aOa_2 , but that crank has only the angular motion dwd_1 , while the wrist-plate moves through the angle $aOa_1 = aOa_2$. The admission-valves have a similar action as shown at e_1ve_2 . If it be supposed that the governor-balls are at their lowest position (at which the disengagement-gear does not act), it will be seen that this gear differs from the plain slide-valve gear in two points: first, it has four valves; and second, these

valves have a more favorable action when opening and closing, on account of the linkages just described.

From a pin at g in the crank Vh , a dash-pot rod represented by the line gi leads to a vacuum dash-pot shown by Fig. 2. This dash-pot has two pistons, p and P ; the lower piston fits nicely in a closed cylinder from which air is excluded; the upper piston works in a larger cylinder that is open to the atmosphere through a series of orifices i , i_1 , and i_2 and the pipe O . When the valve-crank Vh , Fig. 1, is raised, it lifts the double piston Pp and a partial vacuum is formed under p , while air enters freely through the orifices i , i_1 , i_2 , to the annular space under the piston P . When the valve is disengaged, the weight of the dash-pot and the dash-pot rod, aided by the vacuum under the piston p , closes the valve promptly; while the air under the piston P acts as a buffer and prevents a shock. The pipe O is provided with a hollow plug as shown, by aid of which the escape of air through the orifices i , i_1 , and i_2 may be regulated.

A large number of detachment-gears have been devised and used by Corliss, and by others who have used this type of valve-gear. The one shown by Fig. 1, Pl. XXXI, was invented by Mr. Reynolds and has the advantage that the latch mechanism is centred on the same axis as the cut-off stop; consequently the finger z always strikes the stop x at the same angle, and the same force is required to disengage the cut-off valve. The block, when disengaged, slides along the plate y . On the return motion the plate y slides over the block till it can snap on to it, under the influence of the spring st .

It is customary to give a small lap to the steam-valves; consequently, as with a plain slide-valve, the eccentric has a small angular advance. With such an arrangement the eccentric centre will be on the line of dead-points, and the valves will have their greatest displacement when the crank has moved through 90° less than angular advance, and before the piston is at half-stroke. If the detachment-gear has not been released before

the valve has received its greatest displacement, the valve will not be disengaged at all, but will remain under the control of the linkage connecting it to the wrist-plate; and cut-off will occur near the end of the stroke, and will be determined by the lap and angular advance as with a plain slide-valve. It is therefore evident that the range of cut-off for the ordinary form of the Corliss gear is from the beginning of the stroke to half-stroke or less. When a longer cut-off is desired, for example on the low-pressure cylinder of a compound engine, two wrist-plates may be used; one wrist-plate, moved by an eccentric with a small angular advance, has control of the exhaust-valves, and gives release and compression near the ends of the stroke; the other wrist-plate is moved by an eccentric with a negative angular advance, and has control of the steam-valves which have a clearance instead of a lap: with this device the range of cut-off may be extended beyond half-stroke

Expertness in laying out Corliss valve-gears can be obtained only by experience, with good examples for models. The steam-port may be made from $\frac{1}{15}$ to $\frac{1}{16}$ of the area of the piston, and the exhaust-port may be made $\frac{1}{16}$ to $\frac{1}{17}$ of that area. The exhaust-valve commonly has no lap; the admission-valve has a small lap, $\frac{1}{4}$ of an inch, in Fig. 1, Pl. XXXI. In that figure ve is the mid-position of the steam valve-crank, and $e'e_1'$ is the maximum valve-displacement, equal to the lap plus the port-opening; ve_1 is the extreme position of the valve-crank. The points b and b_1 are found by intersecting the arc b_1b_2 by arcs drawn from e and e_1 with a radius equal to the length of the link BE . The arc bb_2 is made equal to bb_1 , and ve_2 , the extreme position of the crank when the valve is shut, is found by intersecting the arc e_1e_2 by an arc drawn from b_2 with a radius equal to the length of the link. The linkage $Oadw$ is laid out in a similar way, except that the angle aOa_1 is from necessity equal to bOb . The lengths of the valve-cranks and the radii from the centre of the wrist-plate to the pins a and b depend partly

on the proportions of the engine and partly on the habit and discretion of the designer; the longer they are, the less will be the force exerted on the links, ad and be , and on the pins which they connect. The angle veb should be nearly a right angle, so that a rapid opening of the valve may be obtained. The pin C in the wrist-plate receives motion from the eccentric either directly or through a carrier or single-armed rocker that magnifies the throw of the eccentric in about the proportion of $1:1\frac{1}{4}$. The chord of the arc C_1C_2 , through which C swings, is not longer than the radius OC in order that the angle C_1OC may not be more than 30° . The linkages $Oadw$ and $Obev$ are to be laid out by trial to give as nearly as may be the desired motion to the valves. It will be noticed that the radius Oa_1 and the link a_1d_1 are in one straight line at the extreme position of the exhaust-valve; and in like manner Ob_2 and b_2e_2 are in one line; should the linkages be carried beyond these positions, a double oscillation would be given to the valve-cranks, which is considered to have a bad appearance. The system of rods and levers connecting the rings xqN and vn with the governor is laid out so that the cut-off may come at the beginning of the stroke when the governor stands at the top of its range of motion, and when the governor is at the bottom of that range the cut-off may come at or after half-stroke, i.e. the valve will not be released. Though it is not always done, it will be advisable for an inexperienced designer to draw the valve-ellipse for the steam- and exhaust-valves. The ellipse, or more properly the oval, will have a form like that shown by Fig. 3. The valve will be found to open rapidly and to nearly its full width early in the stroke of the piston. A line nn' drawn at the distance xn , equal to the lap, from the axis xx' , will show that the cut-off occurs near the end of the stroke. The valve will be found to be nearly at rest during the greater part of the time when it is closed.

The steam-valve is disengaged when the latch holding it is released, but cut-off does not occur till the edge of the valve

comes to the edge of the port, which is an appreciable time later. In Fig. 3, Pl. XXXI, let a represent the point of disengagement; then, under the influence of the dash-pot, the valve falls with an accelerated velocity till it is checked by the air-cushion in the dash-pot. Representing the motion of the piston by abscissæ, and the motion of the valve by ordinates (just as in drawing the ellipse), the action of the valve in closing may be represented by the dotted line abc ; the point of cut-off is represented by b at the intersection of this line and the lap-line mn' . The piston-displacements may be readily found from the dimensions of the engine and its speed of rotation, but the forces acting on the valve and its resistances cannot be estimated. The forces are the weight of the dash-pot and attached parts, together with the pressure of the atmosphere on the area of the piston p . The resistances are friction of the valve, of the dash-pot, and of other parts of the mechanism, and the varying pressures under the pistons P and p ; the pressure under P is due to the escaping air, and under p to the air beneath it when at its lowest position. Though the line abc cannot be determined by calculation or construction, it may be found experimentally by an apparatus described on page 7 for making an engine draw its own ellipse. The action of the valves of a Corliss engine is commonly investigated by aid of a steam-engine indicator; if the indicator diagram shows a sharp cut-off, and if the other features are good, the action of the valves is considered to be satisfactory.

Putnam Valve-gear. The Putnam engine has four double poppet-valves, two for admission and two for exhaust. Plate XXXII shows a section through one of the admission-valves and its valve-gear XX' is a casting bolted onto the cylinder-casting. The space SS' is the steam-chest, and the space P leads to the cylinder. The two valves V and V_1 are made of composition and, when closed, rest on composition seats let into the casting. The seat of the valve V is large enough to

pass the valve V_1 , so that the valves may be readily withdrawn through the hand-hole H . The unbalanced pressure, which must be overcome when the valve is opened, is that on the excess of the area of the upper valve over that of the lower valve. The valve-spindle ab is made of iron to avoid unequal expansion and consequent leakage; for, if the distance between the valves is not exactly the same as the distance between the valve-seats, one or other of the valves will not come properly to its seat.

The valve-spindle ab is stepped into a frame mn , shown in section. The arm gq is loose on the shaft and under the influence of the spring lk presses on the frame mn ; a pin p' is interposed to reduce friction. The other arm, gj , of the bell-crank lever carries the cam-lever fe , which acts on the frame mn through the interposed sliding-block d and the pin p ; this cam-lever is driven by the double cam C . This cam C , and three others, one for the other steam-valve and two for the exhaust-valves, are carried by a shaft which is parallel to the axis of the cylinder and which is driven from the engine-shaft through bevel-gears, so proportioned that the cam-shaft makes one turn for two revolutions of the engine. The figure shows the cam in contact with the cam-lever, and the valves on their seats; the engine is consequently at admission. As the engine moves forward, the cam-shaft turns as shown by the arrow and raises the valves, giving admission of steam, till the cam slides past the corner y of the cam-lever; the valve is then released and falls shut under the influence of the spring kl . The governor-rod takes hold of the pin h at the end of the lever gh . When the speed of the engine increases and the governor rises, the lever hg is thrown down and the cam-lever ef is pushed to the left, so that the cut-off comes earlier. No shock is thrown on the governor when the valve is released, but as the edge of the cam is rounded to avoid cutting the cam-lever, there is a tendency to disturb the governor which the governor must be able to resist. Should the valve fail to close for any reason, the other

end of the cam will strike on *i* and close the valve before the engine makes a return stroke.

The exhaust-cam is shown at *A*. At each end the cam is cylindrical, so that it holds the exhaust-valve open till near the end of the stroke. The exhaust cam-lever is not placed under the control of the governor, but can be set to give a fixed compression.

Gaskill Valve-gear.—One of the steam-valves for the high-pressure cylinder of the Gaskill horizontal pumping-engine, and part of the valve-gear, are shown on Plate XXXIII. The valve is shown in section by Fig. 2, and the seat is shown in section and half-plan by Figs. 2 and 3. The valve is of the Cornish type and differs from the double poppet-valve only in detail. Like that valve it consists of two valves joined together, the inner valve being small enough to pass through the valve-seat of the outer or upper valve. The unbalanced pressure to be overcome to open the valve is that on the difference of areas of the two valves. When open, both valves give admission of steam. The valve-seat *S* is bolted to the cylinder-casting, and a passage leads directly to the end of the cylinder. The valve is covered by a small cylindrical valve-chest; there are two such chests, one at each end of the cylinder, supplied by a branched steam-pipe.

The valve-gear is shown by Fig. 1, in which *E* is an eccentric on a shaft parallel to the axis of the cylinder, and driven from the engine-shaft through equal bevel-gears, so that it makes one turn for each revolution of the engine. The eccentric-strap has the cut-off toe *a* at one end and a lug *b* at the other. From *b* the rod *bC* leads to one end of an equal-armed lever, and the valve-spindle *d* is hung from the other arm; the distance between the rod *C* and the valve-spindle is several times as much as shown in the figure. The lever *il*, centred at *h*, is under the control of the governor through the rod *ki*. The eccentric and eccentric-strap, with the lever *il*, form a radial-detachment cut-off gear.

Suppose, first, that the lever hl is thrown so far to the right that the toe a does not touch it; then as the centre of the eccentric describes a circular path around the point O , the point b_0 of the line b_0Ea will move on an arc sensibly parallel with the axis XX' , and the point a_1 will describe an oval $a_1a_2a_3$; the valve meanwhile will remain shut.

On the other hand, if the lever hl is supposed to be so far to the left that the toe a may remain always in contact with its curved end, and if by some means it is prevented from rising from that surface, then the point a will travel on a circular arc nearly coincident with the axis XX' , and the point b will describe the oval $b_0b_1b_2$; such an action is of course impossible when the gear is connected up, as the valve is on its seat when the point b is on the axis XX' and consequently b cannot rise above that axis.

With the lever hl in the position shown in the figure, the toe a describes the oval $a_1a_2a_3$ till it comes in contact with the curved surface at the end of the lever; and then a slides along that surface, while the point b describes the arc b_1b_0 , and the valve is opened as shown by Fig. 2. When the toe comes to the edge of the surface l , it slips off and the valve is thrown shut by the action of a spring and dash-pot. The toe falls from a to a_1 , and the point b_0 returns to b on the axis XX' .

It is evident that this form of valve-gear can give a range of cut-off varying from the beginning to the end of the stroke, and that the releasing-device does not throw a shock on the governor. On the other hand, the sudden opening of the steam-valve when the toe a comes in contact with the lever hl throws a shock on the valve-gear that might be troublesome at any but the low speeds at which pumping-engines are commonly run.

APPENDIX.

ANALYTICAL DISCUSSION.

Crank and Connecting-rod.—The graphical construction for the motion of a piston when connected to the crank by a connecting-rod, given on page 2, is customary and convenient. It may be desirable to have in addition the following analytical discussion of the problem.

Let the length of the connecting-rod be represented by L , the length of the crank by R , and the angle which the crank makes with the centre-line XX' , by θ ; then the displacement HA of the cross-head from the beginning of its stroke is

$$D = OA - Oc - (\overline{HC}^2 - \overline{Cc}^2)^{\frac{1}{2}};$$

$$D = L + R - R \cos \theta - (L^2 - R^2 \sin^2 \theta)^{\frac{1}{2}};$$

$$D = R(1 - \cos \theta) + L \left\{ 1 - \left(1 - \frac{R^2 \sin^2 \theta}{L^2} \right)^{\frac{1}{2}} \right\} . . . (1)$$

The principal use of this equation is to study the nature of the irregularity introduced by the connecting-rod into the motion of the cross-head, and for that purpose it is convenient to expand the expression containing L by the binomial theorem,

rejecting terms having the higher powers of L in the denominator; whence

$$D = R(1 - \cos \theta) + L \left\{ 1 - \left(1 - \frac{R^2 \sin^2 \theta}{2L^2} \right) \right\}$$

$$D = R(1 - \cos \theta) + \frac{R^2 \sin^2 \theta}{2L} \dots \dots \dots (2)$$

The ratio of crank to connecting-rod in stationary-engine practice varies from 1:5 to 1:7½. In marine engineering the ratio 1:4, or even more, sometimes obtains. The maximum value of the term containing L occurs at $\theta = 90^\circ$; for the ratios of crank to connecting-rod just given, the term containing L has then the values $\frac{1}{10}R$, $\frac{1}{8}R$, $\frac{1}{6}R$, respectively. It is apparent that the difference between the motion of the cross-head and piston, and harmonic motion, represented by the equation

$$D = R(1 - \cos \theta), \dots \dots \dots (3)$$

is always notable, and may be large.

Eccentric and Eccentric-rod.—The displacement of the valve is always reckoned from the middle position, and in Fig. 4, Pl. I, is $e = ha$; it may be calculated as follows:

$$e = Oe + Oa - (\overline{Eh}^2 - \overline{Ec}^2)^{\frac{1}{2}};$$

$$\therefore e = r \cos \{90^\circ - (\theta + \delta)\} + l - [l^2 - r^2 \sin^2 \{90^\circ - (\theta + \delta)\}]^{\frac{1}{2}};$$

$$\therefore e = r \sin (\theta + \delta) + l \left[1 - \left\{ 1 - \frac{r^2 \cos^2 (\theta + \delta)}{l^2} \right\}^{\frac{1}{2}} \right] \dots \dots (4)$$

This equation differs from equation (1) only in that the eccentric angle and the valve-displacement are reckoned from different points. Expanding by the binomial theorem and

rejecting terms containing the higher powers of l in the denominator gives

$$e = r \sin (\theta + \delta) + \frac{r^2 \cos^2(\theta + \delta)}{2l}. \quad \dots \quad (5)$$

The length of the eccentric-rod is commonly from 12 to 20 times the eccentricity; the right-hand terms for such ratio will have the values $\frac{1}{24}r$ and $\frac{1}{40}r$, respectively, for maxima. It is customary to assume the motion of the valve to be harmonic, in which case it is represented by the equation

$$e = r \sin (\theta + \delta). \quad \dots \quad (6)$$

The error of this assumption, though appreciable, is not large; moreover the method of setting values of engines prevents any inconvenience from this source unless the eccentric-rods are very short.

Stephenson Link-motion.—The only satisfactory justification of the use of Zeuner's valve diagrams is the analytical discussion given by him in his Treatise on Valve-gear. That discussion involves the development of a number of long equations, which, however, require only a knowledge of simple trigonometry and present no great difficulty.

As presented here the work is perhaps given with undue prolixity because it is desired that sufficient intermediate steps shall be given to enable any one to read it readily. It will be sufficient in any case to follow the transformations and recognize the results. It may be noted that the use of the model described on page 64 does not depend on this discussion.

On Plate XVI the Figures 1 and 2 are drawn to represent link-motions with open and with crossed rods. The diagrams in thin lines give the positions of the parts when the crank is on the crank-end dead-point; and the diagrams in heavy lines show the positions when the crank has moved through the angle θ .

The eccentricity for each eccentric is r , and the angular advance is δ . The link-pins are on the link-arc, the length of the eccentric-rcds is l , and the radius of the link-arc is ρ which may or may not be equal to l . The length of half the link-arc is c , and the displacement of the link-block from the middle of the link-arc is d . In the discussion it is assumed that the link is supported and guided by the link-block, so that the point n remains on the line XX' . It is also assumed that the chord joining the link-pins is equal to the length of the link-arc between those pins, and that in like manner the displacement of the link-block from the middle of the link may be measured indifferently either on the link-arc or on the chord. The error of this assumption may be estimated as follows: A common proportion is $r = \frac{1}{2}c = \frac{1}{4}l$, or $c = \frac{1}{6}l$, so that the arc subtends an angle of about 20° , and for that angle the arc is 0.3490 of the radius and the chord is 0.3473 of the radius, and the error is a little more than half of one per cent.

The distance from the centre of the driver-axle to the middle of the valve, in either Fig. 1 or Fig. 2, Pl XVI, is

$$Ob = Om + mn + nb = Op - mp + mn + nb, \dots (7)$$

in which the length of the valve-spindle nb may be replaced by s , and the value of the other terms may be conveniently determined as follows:

First, the term mp is determined by the equation

$$mp = mP \sin mPp = (c - d) \sin \alpha. \dots (8)$$

Now

$$\sin \alpha = \frac{pp'}{PP'} = \frac{Op - Op'}{2c}. \dots (9)$$

From Fig. 1, Pl. XVI,

$$Op = Oe + ep = Oe + \{\overline{EP^2} - (Pp - Ee)^2\}^{\frac{1}{2}}; \dots (10)$$

and from Fig. 2,

$$Op = Oe + ep = Oe + \{\overline{EP}^2 - (Pp + Ee)^2\}^{\frac{1}{2}}. \quad \dots (11)$$

In either figure

$$Oe = r \sin(\theta + \delta), \quad Ee = r \cos(\theta + \delta), \quad EP = l,$$

and

$$Pp = mP \cos mPp = (c - d) \cos \alpha;$$

these values substituted in equations (10) and (11) give

$$Op = r \sin(\theta + \delta) + \{l^2 - [(c - d) \cos \alpha \mp r \cos(\theta + \delta)]^2\}^{\frac{1}{2}}; \quad (12)$$

the upper sign being taken for open and the lower sign for crossed rods. Expanding the term with a fractional exponent by the binomial theorem, and rejecting terms with the higher powers of l in the denominator, gives

$$Op = r \sin(\theta + \delta) + l - \frac{(c - d)^2 \cos^2 \alpha}{2l} \\ \pm \frac{(c - d)r \cos(\theta + \delta) \cos \alpha}{l} - \frac{r^2 \cos^2(\theta + \delta)}{2l}.$$

Now the terms containing $\cos \alpha$ in the numerator have l in the denominator, and are comparatively small, while α is not more than 30° , for which the cosine is 0.866; consequently we may replace unity for $\cos \alpha$ without much error. With that change and some expansion,

$$Op = r \sin(\theta + \delta) + l - \frac{c^2}{2l} + \frac{cd}{l} - \frac{d^2}{2} \\ \pm \frac{(c - d)r \cos(\theta + \delta)}{l} - \frac{r^2 \cos^2(\theta + \delta)}{2l}. \quad (13)$$

Similarly Fig. 1 and Fig. 2 give respectively equations (14) and (15):

$$Op' = e'p' - Oe' = \{\overline{E'P'^2} - (P'p' - E'e')^2\}^{\frac{1}{2}} - Oe'; \quad (14)$$

$$Op' = e'p' - Oe' = \{\overline{E'P'^2} - (P'p' + E'e')^2\}^{\frac{1}{2}} - Oe'. \quad (15)$$

In either figure

$$Oe' = r \sin (\theta - \delta), \quad E'e' = r \cos (\theta - \delta), \quad E'P' = l,$$

and

$$P'p' = mP' \cos mP'p' = (c+d) \cos \alpha;$$

these terms substituted in equations (14) and (15) give

$$Op' = -r \sin (\theta - \delta) + \{l^2 - [(c+d) \cos \alpha \mp r \cos (\theta - \delta)]^2\}^{\frac{1}{2}}; \quad (16)$$

the upper sign being taken for open and the lower for crossed rods. As in the previous work, $\cos \alpha$ may be replaced by unity; expanding by the binomial theorem, and rejecting terms with the higher powers of l in the denominator, gives

$$\begin{aligned} Op' &= -r \sin (\theta - \delta) + l - \frac{(c+d)^2}{2l} \\ &\quad \pm \frac{(c+d)r \cos (\theta - \delta)}{l} - \frac{r^2 \cos^2 (\theta - \delta)}{2l}; \\ \therefore Op' &= -r \sin (\theta - \delta) + l - \frac{c^2}{2l} - \frac{cd}{l} - \frac{d^2}{2l} \\ &\quad \pm \frac{(c+d)r \cos (\theta - \delta)}{l} - \frac{r^2 \cos^2 (\theta - \delta)}{2l}. \quad (17) \end{aligned}$$

Substituting in equation (9) the values for Op and Op' ,

$$\begin{aligned} \sin \alpha = & \frac{r \sin (\theta + \delta) + r \sin (\theta - \delta)}{2c} + \frac{2cd}{2cl} \\ & \pm \frac{(c-d)r \cos (\theta + \delta) - (c+d)r \cos (\theta - \delta)}{2cl} \\ & - \frac{r^2 \cos^2 (\theta + \delta) - r^2 \cos^2 (\theta - \delta)}{4cl}; \end{aligned}$$

$$\begin{aligned} \therefore \sin \alpha = & \frac{r}{c} \cos \delta \sin \theta \mp \frac{r}{l} \sin \delta \sin \theta \mp \frac{dr}{cl} \cos \delta \cos \theta \\ & + \frac{d}{l} - \frac{r^2}{4cl} [\cos^2 (\theta + \delta) - \cos^2 (\theta - \delta)]. \quad (18) \end{aligned}$$

To obtain an expression for the term mn in equation (7) consider Fig. 3, Pl. XVI, where Pn_0 is half the link and n_0T is the diameter of the arc Pn_0 , while On corresponds to the line OnX' of Fig. 1. If the half-chords Pm_0 and ni are drawn, it may be admitted that mn is nearly equal to m_0i , so that approximately

$$mn = m_0n - in_0.$$

But noting that the diameter n_0T is divided into segments both by Pm_0 and by ni , and that the smaller segments are very small compared with the larger segments, we may write

$$mn = \frac{\overline{Pm_0}^2}{m_0T} - \frac{\overline{ni}^2}{iT} = \frac{c^2}{2\rho} - \frac{d^2}{2\rho} \text{ (nearly)}. \quad \dots \quad (19)$$

Substituting in equation (7) the values of the several terms,

$$\begin{aligned}
 Ob &= r \sin \delta \cos \theta + r \cos \delta \sin \theta + l - \frac{c^2}{2l} + \frac{cd}{l} - \frac{d^2}{2l} \\
 &\pm \frac{r(c-d)}{c} (\cos \theta \cos \delta - \sin \theta \sin \delta) - \frac{r^2 \cos^2 (\delta + \theta)}{2l} \\
 &- (c-d) \left\{ \frac{r}{c} \cos \delta \sin \theta \mp \frac{r}{l} \sin \delta \sin \theta \mp \frac{dr}{cl} \cos \delta \cos \theta \right. \\
 &\quad \left. + \frac{d}{l} - \frac{r^2}{4cl} [\cos^2 (\theta + \delta) - \cos^2 (\theta - \delta)] \right\} + \frac{c^2}{2\rho} - \frac{d^2}{2\rho} + s;
 \end{aligned}$$

$$\begin{aligned}
 Ob &= r \left[\sin \delta \pm \frac{c-d}{l} \cos \delta \pm (c-d) \frac{d}{cl} \cos \delta \right] \cos \theta \\
 &+ r \left[\cos \delta \mp \frac{c-d}{l} \sin \delta - \frac{c-d}{c} \cos \delta \pm \frac{c-d}{l} \sin \delta \right] \sin \theta \\
 &- \frac{r^2}{4cl} \{ 2c \cos^2 (\delta + \theta) - (c-d) [\cos^2 (\theta + \delta) - \cos^2 (\theta - \delta)] \} \\
 &+ \frac{-c^2\rho + 2cd\rho - d^2\rho - 2(c-d)d\rho + c^2l - d^2l}{2l\rho} + l + s;
 \end{aligned}$$

$$\begin{aligned}
 \therefore Ob &= r \left(\sin \delta \pm \frac{c^2 - d^2}{cl} \cos \delta \right) \cos \theta + r \frac{d}{c} \cos \delta \sin \theta \\
 &- \frac{r^2}{4cl} [(c+d) \cos^2 (\delta + \theta) + (c-d) \cos^2 (\theta - \delta)] \\
 &+ (c^2 - d^2) \frac{l - \rho}{2l\rho} + l + s \quad \dots \dots \dots (20)
 \end{aligned}$$

The third term has its greatest value when d is equal to c , and it is then equal to

$$\frac{r^2 \cos^2 (\theta + \delta)}{2l},$$

which is the term that appears in equation (5) for the plain slide-valve. In the discussion of the plain slide-valve this term was neglected, and consequently it may be neglected here with equal propriety. Equation (20) may therefore be written

$$Ob = r \left(\sin \delta \pm \frac{c^2 - d^2}{cl} \cos \delta \right) \cos \theta + r \frac{d}{c} \cos \delta \sin \theta + (c^2 - d^2) \frac{l - \rho}{2l\rho} + l + s. \quad (21)$$

If the engine is on the crank-end dead-point, then θ is zero; and it is 180° at the head-end dead-point. These special values of the crank-angle give

$$Ob' = r \left(\sin \delta \pm \frac{c^2 - d^2}{cl} \cos \delta \right) + (c^2 - d^2) \frac{l - \rho}{2l\rho} + l + s; \quad (22)$$

$$Ob'' = -r \left(\sin \delta \pm \frac{c^2 - d^2}{cl} \cos \delta \right) + (c^2 - d^2) \frac{l - \rho}{2l\rho} + l + s. \quad (23)$$

The mid-position of the valve should be midway between b' and b'' , Figs. 1 and 2, Pl. XVI; half the sum of Ob' and Ob'' is

$$Oo = \frac{Ob' + Ob''}{2} = (c^2 - d^2) \frac{l - \rho}{2l\rho} + l + s; \quad (24)$$

in which the only variable is the term containing ρ , the radius of curvature of the link-arc. If ρ be made equal to l , then this term disappears, leaving

$$Oo = l + s. \quad (25)$$

With equal laps, the necessary and sufficient condition for equal leads, at all grades, is that the radius of the link-arc shall be equal to the length of the eccentric-rod.

Applying this condition to equation (21) gives

$$Ob = r \left(\sin \delta \pm \frac{c^2 - d^2}{cl} \cos \delta \right) \cos \theta + r \frac{d}{c} \cos \delta \sin \theta + l + s. \quad (26)$$

The displacement of the valve from mid-position is

$$e = Ob - Oo;$$

$$\therefore e = r \left(\sin \delta \pm \frac{c^2 - d^2}{cl} \cos \delta \right) \cos \theta + r \frac{d}{c} \cos \delta \sin \theta. \quad (27)$$

General Equation for Valve-motion.—Equation (6), page 123, gives for the displacement of a plain slide-valve moved by an eccentric

$$e = r \sin (\delta + \theta);$$

expanding the parenthesis,

$$e = r \cos \delta \sin \theta + r \sin \delta \cos \theta; \quad \dots \quad (28)$$

which may be written

$$e = A \cos \theta + B \sin \theta, \quad \dots \quad (29)$$

since r and δ are constant for a given slide-valve gear.

It has been shown by the aid of Fig. 7, Pl. II, that the motion of a plain slide-valve may be represented by a valve-circle, and a comparison of that figure with equation (29) will show that the constants in the equation are the coördinates of the end P of the diameter of the valve-circle. Thus

$$Oq = r \sin \delta = A; \quad \dots \quad (31)$$

$$Pq = r \cos \delta = B. \quad \dots \quad (32)$$

It may be concluded that any valve which has its displacement represented by an equation of the same form as equation (29) has a harmonic motion and may have its motion represented by a valve-circle.

Zeuner's Diagram.—A comparison of equation (27) with equation (29) shows that a valve controlled by a Stephenson link-motion has a harmonic motion, and that its displacements from mid-position, at any grade of the link, may be represented by a valve-circle, having for the coördinates of the end of the diameter

$$A = r \left(\sin \delta \pm \frac{c^2 - d^2}{d} \cos \delta \right); \dots \dots \dots (33)$$

$$B = r \frac{d}{c} \cos \delta. \dots \dots \dots (34)$$

At full-gear $d=c$, which applied to equations (33) and (34) will reduce them to equations (31) and (32). Thus the valve-diagram for a link-motion at full gear is identical with the diagram for a plain slide-valve under the control of an eccentric having the same eccentricity and angular advance as one of the eccentrics of the link-motion; which coincides with our conceptions of the link-motion, derived from the drawings on Plates XIII and XIV.

In Fig. 4, Pl. XVI, and Fig. 1, Pl. XVII, Oq and qP are made equal to the coördinates of the end of the valve-circle diameter at full-gear, when $d=c$; i.e.,

$$Oq = r \sin \delta = A, \quad qP = r \cos \delta = B.$$

At mid-gear d becomes zero, and the coördinates of the end of the diameter of the valve-circle become

$$A_0 = r \sin \delta \pm \frac{rc}{l} \cos \delta; \dots \dots \dots (35)$$

$$B_0 = 0. \dots \dots \dots (36)$$

The upper sign is taken for open rods, and the lower sign for crossed rods. Fig. 4, Pl. XVI, corresponds with the first case, and Fig. 1, Pl. XVII, with the second case. The ends of the diameter of valve-circles for intermediate grades of the link may be found by assuming values for d and calculating the coördinates by aid of equations (33) and (34), if desired; but an inspection of those equations shows that they give the coördinates of a parabola having its vertex on the axis XX' . Two points, P and P_0 , are already located and an arc of the parabola may be passed through them by the ordinary geometrical construction; or, since the arc is quite flat, there may be substituted for it the arc of a circle having its centre on the axis XX' . The centres of the valve-circles have for their coördinates $\frac{1}{2}A$ and $\frac{1}{2}B$, and consequently lie on another parabola with its vertex on XX' ; an arc of a circle centred on XX' may be substituted for the arc of this parabola, and will be more convenient to draw since its radius is half the radius of the circular arc substituted for the parabola through P and P_0 .

Fig. 4, Pl. XVI, and Fig. 1, Pl. XVII, exhibit the variation of lead which was pointed out in Figs. 1 and 2, Pl. XV. The same thing is evident from an inspection of equation (33), taking the upper sign for open and the lower sign for crossed rods. For convenience the fact is stated as follows:

A Stephenson link-motion with open rods gives increasing lead from full-gear toward mid-gear; with crossed rods it gives decreasing lead from full-gear toward mid-gear.

Valve-circles showing the motion of the valve at intermediate grades of the link are drawn at OP_1 and OP_2 , on Fig. 4, Pl. XVI, and on Fig. 1, Pl. XVII. On both figures the lap-circles are $nn'n''$, showing cut-off at the crank-positions OR , OR_1 , OR_2 , and OR_0 ; neglecting the influence of the connecting-rod, the corresponding piston-displacements are xa , xa_1 , xa_2 , and xa_0 . An inspection of the figure will show that the lead angle increases as the cut-off is shortened, accompanied by an earlier

admission. If an exhaust-lap circle were drawn, it would show that an early cut-off is accompanied by an early release and a large compression. A comparison of these diagrams with the valve-diagrams shown by Fig. 2, Pl. X, and Fig. 1, Pl. XII, will show that a Stephenson link-motion is equivalent to a shifting eccentric with variable lead.

Gooch Link-motion.—Making use of the same notation as in the analytical discussion of the Stephenson link, let e be the eccentricity, and δ the angular advance for each eccentric; let c be the half-length of the link, and d the displacement of the link-block from the middle of the link; let l be the length of the eccentric-rod, the link-pins being assumed to be on the link-arc; let l_1 be the length of the radius-rod, and s the length of the valve-spindle.

Assume that the link is so suspended that m , the middle point of the chord, shall remain on the central line XX' , and that the length of the link is sensibly the same whether measured on the chord or on the arc. Assume also that the rods are open.

In Fig. 2, Pl. XVIII, the diagram in fine lines represents the link-motion when the crank is on a dead-point; and the diagram in heavy lines represents it when the crank has moved from C_0 to C through the angle θ .

The distance from the origin O to the middle of the valve b is

$$Ob = Op - pk - kq + qS + Sb. \quad \dots \quad (37)$$

The term pk is determined by the equation

$$pk = KP \sin \angle PK = (c - d) \sin \alpha. \quad \dots \quad (38)$$

Now

$$\sin \alpha = \frac{pp'}{PP'} = \frac{Op - Op'}{2c}. \quad \dots \quad (39)$$

But

$$Op = Oe + ep = Oe + \{\overline{EP}^2 - (Pp - Ee)^2\}^{\frac{1}{2}}; \quad . \quad . \quad (40)$$

$$Op' = -Oe' + e'p' = -Oe' + \{\overline{E'P'}^2 - (P'p' - E'e')^2\}^{\frac{1}{2}}; \quad . \quad (41)$$

in which

$$\begin{aligned} EP &= E'P' = l, & Pp &= P'p' = c \cos \alpha; \\ Oe &= r \sin (\theta + \delta), & Oe' &= r \sin (\theta - \delta); \\ Ee &= r \cos (\theta + \delta), & Ee' &= r \cos (\theta - \delta). \end{aligned}$$

Substituting these values in equations (40) and (41) gives

$$Op = r \sin (\theta + \delta) + \{l^2 - [c \cos \alpha - r \cos (\theta + \delta)]^2\}^{\frac{1}{2}}. \quad . \quad (42)$$

$$Op' = -r \sin (\theta - \delta) + \{l^2 - [c \cos \alpha - r \cos (\theta - \delta)]^2\}^{\frac{1}{2}}. \quad . \quad (43)$$

A comparison of equations (42) and (43) with equations (12) and (16) shows that they differ in that the coefficient of $\cos \alpha$ does not contain d , and that only the upper sign of the double sign appears before the last term in the bracket; this last, because the discussion applies only to open rods. Consequently the value of $\sin \alpha$ may be obtained from equation (18) by omitting terms containing d , and using only the upper sign of the double signs; hence

$$\begin{aligned} \sin \alpha &= \frac{r}{c} \cos \delta \sin \theta - \frac{r}{l} \sin \delta \sin \theta \\ &\quad - \frac{r^2}{4cl} [\cos^2 (\theta + \delta) - \cos^2 (\theta - \delta)]. \quad (44) \end{aligned}$$

Expanding by the binomial theorem the term in equation (42) which has a fractional exponent, and rejecting terms with

higher powers of l in the denominator, and at the same time substituting unity for $\cos \alpha$, will give

$$Op = r \sin(\theta + \delta) + l - \frac{c^2}{2l} + \frac{cr}{l} \cos(\theta + \delta) - \frac{r^2 \cos^2(\theta + \delta)}{2l}. \quad (45)$$

The first two terms of the equation (37) are now determined; the others are

$$Sb = s,$$

$$qS = \{l_1^2 - d^2\}^{\frac{1}{2}} = l_1 - \frac{d^2}{2l_1} \text{ (nearly),}$$

and

$$kq = \frac{c^2}{2l_1} - \frac{d^2}{2l_1} \text{ (nearly).}$$

To obtain the last equation, it may be admitted that qk (Fig. 2, Pl. XVIII) is nearly equal to QK , which is nearly equal to tm . Now Pm is half of a chord bisected by a diameter, of which one segment is nm and the other is $2l_1 - mn$; consequently

$$Pm^2 = nm(2l_1 - mn);$$

$$\therefore mn = \frac{c^2}{2l_1} \text{ (nearly);}$$

and in like manner

$$nt = \frac{d^2}{2l_1} \text{ (nearly).}$$

$$\therefore tm = kq = \frac{c^2}{2l_1} - \frac{d^2}{2l_1} \text{ (nearly).}$$

Substituting the values of the several terms in equation (37),

$$\begin{aligned}
 Ob &= r \sin (\theta + \delta) + l - \frac{c^2}{2l} + \frac{cr \cos (\theta + \delta)}{l} - \frac{r^2 \cos^2 (\theta + \delta)}{2l} \\
 &- (c-d) \left\{ \frac{r}{c} \sin \theta \cos \delta - \frac{r}{l} \sin \theta \sin \delta \right. \\
 &\left. + \frac{r^2}{4cl} [\cos^2 (\theta - \delta) - \cos^2 (\theta + \delta)] \right\} - \frac{c^2}{2l_1} + \frac{d^2}{2l_1} + l_1 - \frac{d^2}{2l_1} + s;
 \end{aligned}$$

$$\therefore Ob = r \sin \theta \cos \delta + r \cos \theta \sin \delta + \frac{cr}{l} \cos \theta \cos \delta$$

$$- \frac{cr}{l} \sin \theta \sin \delta - r \sin \theta \cos \delta + \frac{cr}{l} \sin \theta \sin \delta$$

$$+ \frac{dr}{c} \sin \theta \cos \delta - \frac{dr}{l} \sin \theta \sin \delta + l - \frac{c^2}{2l} - \frac{c^2}{2l_1} + l_1 + s$$

$$- \frac{r^2}{2l} \cos^2 (\theta + \delta) - \frac{r^2}{4l} \cos^2 (\theta - \delta) + \frac{r^2}{4l} \cos^2 (\theta + \delta)$$

$$+ \frac{r^2 d}{4cl} \cos^2 (\theta - \delta) - \frac{r^2 d}{4cl} \cos^2 (\theta + \delta);$$

$$\therefore Ob = r \left(\sin \delta + \frac{c}{l} \cos \delta \right) \cos \theta + \frac{dr}{c} \left(\cos \delta - \frac{c}{l} \sin \delta \right) \sin \theta$$

$$+ l + l_1 + s - \frac{c^2}{2l} - \frac{c^2}{2l_1}$$

$$- \frac{r^2}{4cl} [(c+d) \cos^2 (\theta + \delta) + (c-d) \cos^2 (\theta - \delta)]. \quad \dots \quad (46)$$

The last term is identical with the term dropped from equation (20), and it may be neglected here as well.

At the crank-end dead-point θ is zero, and it is 180° at the head-end dead-point. The corresponding values for Ob are

$$Ob' = r \left(\sin \delta + \frac{c}{l} \cos \delta \right) + l + l_1 + s - \frac{c^2}{2l} - \frac{c^2}{2l_1}; \quad (47)$$

$$Ob'' = -r \left(\sin \delta + \frac{c}{l} \cos \delta \right) + l + l_1 + s - \frac{c^2}{2l} - \frac{c^2}{2l_1}. \quad (48)$$

Hence the distance from the origin O to the middle of the valve, when in mid-position, is (Fig. 2, Pl. XVIII)

$$Oo = \frac{1}{2}(Ob_1 + Ob_2) = l + l_1 + s - \frac{c^2}{2l} - \frac{c^2}{2l_1}. \quad (49)$$

The displacement of the valve from mid-position at any crank-angle is obtained by subtracting equation (49) from equation (46), member from member, giving

$$e = r \left(\sin \delta + \frac{c}{l} \cos \delta \right) \cos \theta + \frac{dr}{c} \left(\cos \delta - \frac{c}{l} \sin \delta \right) \sin \theta. \quad (50)$$

Thus far in this discussion attention has been given to the case of open rods only; were the same method to be carried through for crossed rods, using a figure similar to Fig. 2, Pl. XVIII, a similar equation would be found for the valve-displacement, except that the quantities c and d would be affected by a negative sign.

Zeuner's Diagram.—A comparison of equation (50) with equation (29) shows that a valve controlled by a Gooch link-motion has a harmonic motion, and that its displacement from mid-position, at any grade of the link, may be represented by a valve-circle. Taking account of the observation at the end of the previous paragraph, with regard to crossed rods, the coordinates of the end of the diameter of the valve-circle may be written

$$A = r \left(\sin \delta \pm \frac{c}{l} \cos \delta \right); \quad (51)$$

$$B = \frac{dr}{c} \left(\cos \delta \mp \frac{c}{l} \sin \delta \right); \quad (52)$$

the upper sign being used with open and the lower with crossed rods.

The expression for A , the abscissa of the end of the diameter of the valve-circle, is the same for all grades of the link; which agrees with the statement on page 53 that the lead is constant when the radius of the link-arc is equal to the length of the radius-rod. It is apparent, therefore, that a Gooch link-motion is equivalent to a shifting eccentric with constant lead. Fig. 3, Pl. XVII, gives the valve-circles for full-gear, mid-gear, and for two intermediate gears; and shows the variation of cut-off from full-gear to mid-gear. As was found to be the case with the shifting eccentric, constant lead is found to be accompanied by an earlier admission from full-gear toward mid-gear, though the change is not so marked as it is with an increasing lead.

It must be noted that the Gooch link-motion at full-gear does not give the valve the motion that it would have if the connection were made by an eccentric-rod to the head of the valve-spindle. In this respect the action of the Gooch link-motion differs from the Stephenson link-motion, which at full-gear acts like a plain slide-valve gear. The diameter of the valve-circle is, at full-gear,

$$\begin{aligned} (A^2 + B^2)^{\frac{1}{2}} &= r \left(\sin^2 \delta + \frac{c^2}{l^2} \cos^2 \delta \pm 2 \frac{c}{l} \sin \delta \cos \delta \right. \\ &\quad \left. + \cos^2 \delta + \frac{c^2}{l^2} \sin^2 \delta \mp 2 \frac{c}{l} \sin \delta \cos \delta \right)^{\frac{1}{2}} \\ &= r \left(1 + \frac{c^2}{l^2} \right)^{\frac{1}{2}}, \end{aligned}$$

which for the ordinary proportions of the link-motion is a trifle longer than r . Consequently the full-gear action of a Gooch link-motion with open rods is equivalent to that of a plain slide-valve gear with a little greater angular advance; with crossed rods it is equivalent to the action of such a gear with a little less angular advance. The difference in each case, though not large, is appreciable.

Walschaert Gear.—The motion of a valve controlled by this gear can be represented in a general way by Zeuner's diagrams, but the discrepancy between the results from such diagrams and the actual valve-motion is too large to allow us to use the diagrams even for a preliminary design. The general conception, however, is a very important matter.

The displacement from mid-position of a valve moved by an eccentric is

$$e = r \sin (\theta + \delta).$$

Now the motion derived from the cross-head is equivalent to that from an eccentric having 90° angular advance, provided the cross-head motion is assumed to be harmonic. Consequently the valve derives a displacement from this source of

$$e_1 = r_1 \sin (\theta + 90^\circ) = r_1 \cos \theta. \quad (53)$$

From the proportions of the combining-lever and the length R of the crank, we have

$$r_1 = \frac{ae}{ef} R.$$

The displacement of the valve from the influence of the eccentric OE is

$$e_2 = r_2 \sin (\theta + 0^\circ) = r_2 \sin \theta, \quad (54)$$

in which

$$r_2 = OE \frac{dG}{GF} \times \frac{af}{ef}.$$

The entire displacement e of the valve at any crank-angle is the sum of the displacements of the two independent sources.

$$\therefore e = e_1 + e_2 = r_1 \cos \theta + r_2 \sin \theta; \quad . . . \quad (55)$$

and since r_1 and r_2 are constant for any grade of the link, equation (55) is a special case of equation (29), r_1 and r_2 being the coördinates of the diameter of a valve-circle for that grade of the gear.

In Fig. 1, Plate XXI, the valve-circle OP_0 is drawn with a diameter r_1 and represents the mid-gear action of the valve. The circles Op , Op_1 , and Op_2 represent the motions derived from the eccentric OE_1 at full-gear and at two intermediate gears. The circles OP , OP_1 , and OP_2 represent the actual displacements of the valve, derived from both sources. It is evident that

$$OP = \{ \overline{OP_0}^2 + \overline{Op}^2 \}^{\frac{1}{2}},$$

and that OP_1 and OP_2 may be obtained in a similar manner. A comparison of Fig. 1, Pl. XXI, with Fig. 3, Pl. XVII, shows that the action of the Walschaert gear is equivalent to that of the Gooch link-motion. To aid in this comparison, the dimensions OP_0 and P_0P were transferred from Fig. 3, Pl. XVII, to Fig. 1, Pl. XXI, and consequently the diagrams are identical.

INDEX.

- Admission, 5
Allen valve, 30
Analytical discussion, 121
Angular advance, 4, 24
Area of steam-pipe and steam-ports, 36
Auxiliary valve-circle, 98
- Balanced valves, 31
Bell-crank lever, 21
Brown engine gear, 109
- Clearance, 13
Compression, 13
Corliss valve-gear, 112
Crank and connecting-rod, 121
Cut-off, 5
 " equalization of, 18, 25
Cut-off valve on back of main valve, 97
 " " in separate chest, 92
 " " with constant travel, 105
 " " with shifting eccentric, 95
- Dead-centre, to set engine on, 32
Designing Meyer valve, 100
 " link-motions, 59
Diagram, elliptical, 5
 " sinusoidal, 7
 " Zeuner's, 8
Double-ported valve, 30
Double valves, 92
 " " auxiliary circle, 98
Drop cut-off valve-gears, 109
- Eccentric and eccentric-rod, 122
Equalization of cut-off, 18, 24
Events of the stroke, 5
Expansion and compression, 13
- Gaskill valve-gear, 119
General equation, 130
Gooch link-motion, 52, 133
- Hackworth valve-gear, 88
- Joy valve-gear, 88
- Lap, steam and exhaust, 4
Lead, 4, 14
Lead-angle, 14
Link-arc, radius of, 50, 53, 58
Link-motion, 47
 " adjusting cut-off, 62
 " analytical discussion, 123,
 133
 " designing, 59
 " for locomotives, 63
 " for marine engines, 56
 " Gooch, 52, 133
 " location of reverse-shaft,
 73
 " location of rocker, 72, 73
 " " " saddle-pin, 72
 " modifications, 57
 " open and crossed rods,
 53, 49

- Link-motion, port-opening, 74
 " saddle-pin, 57
 " skeleton model, 64
 " slip, 74
 " Stephenson, 47, 54, 123
 " to set, 76
 " Zeuner's diagram, 51
 Link-pins, 57
 Loose eccentric, 40

 Marine link-motions, 56, 60
 Marshall valve-gear, 86
 Meyer valve-gear, 99
 " " cut-off at inner edge, 102
 " " designing, 100
 " " for reversing engines, 103
 Model for link-motion, 64
 " " " applications, 77

 Piston-valve, 28
 Port-opening, 74
 Ports, 3
 " area of, 36
 Putnam valve-gear, 117

 Radial valve-gears, 84
 Radius of link-arc, 50, 53
 Reduction of slip of link-motion, 61
 Release, 5
 Reverse-shaft for link-motion, 58, 73
 Rocker, 21
 " equalization of cut-off by, 24
 " location for link-motion, 72

 Saddle-pin, 57
 Shaft-governor, 41
 Shifting-eccentric, constant lead, 46
 " variable lead, 43
 Sinusoidal diagram, 7
 Skeleton model for link-motion, 64

 Skeleton applications, 77
 Slide-valve, 1, 3
 " problems, 14
 " to lay out, 20
 Slip of link-motion, 74
 " reduction of, 61
 Steam-pipe, area of, 36
 Stephenson link-motion, 47, 54, 123
 Stroke, events of, 5

 To set a double valve, 107
 " " link-motion, 76
 " " slide-valve, 32
 " " an engine on a dead-point, 32
 Trick valve, 30

 Valve, Allen or Trick, 30
 " balanced, 31
 " double-ported, 30
 " piston, 28
 Valve-circle, auxiliary, 98
 Valve-ellipse, 5
 Valve-gear, Brown engine, 109
 " cam, 110
 " Corliss, 112
 " double, 92
 " drop cut-off, 109
 " Gaskill, 119
 " Hackworth, 88
 " Joy, 88
 " Marshall, 86
 " Meyer, 99
 " Putnam, 117
 " radial, 84
 " Walschaert, 85
 Valve-setting, for double valves, 107
 " for link-motions, 76
 " for slide-valve, 32

 Walschaert gear, 85, 139

 Zeuner's diagram, 8, 51, 131, 137

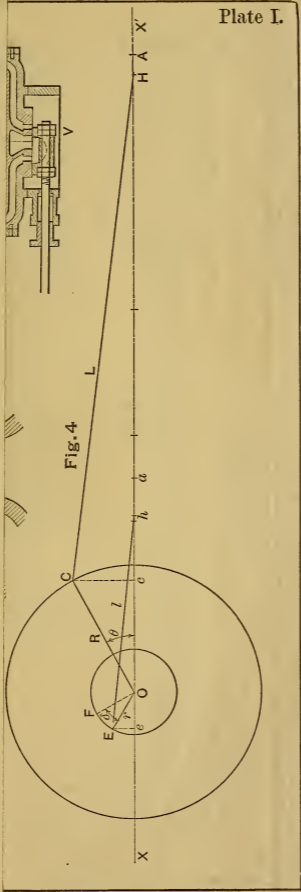

Fig. 4



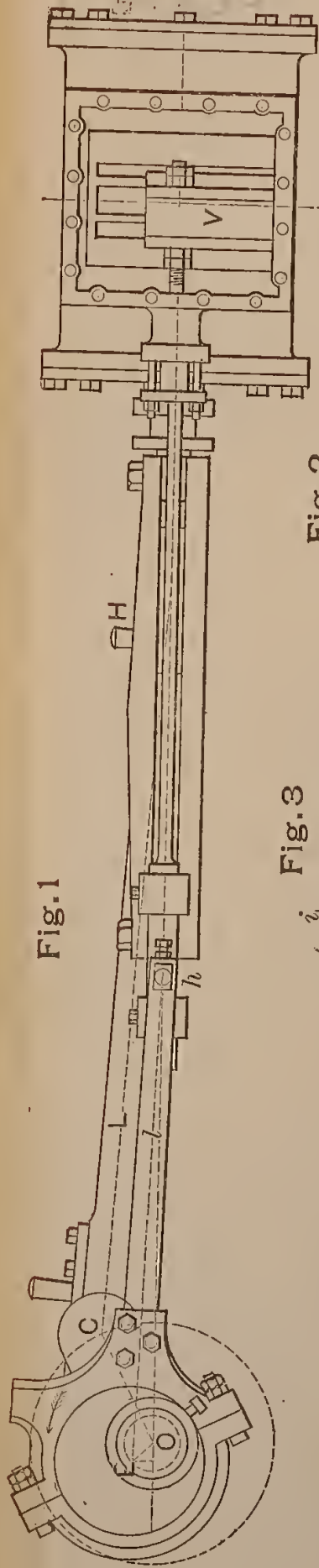

Fig. 1

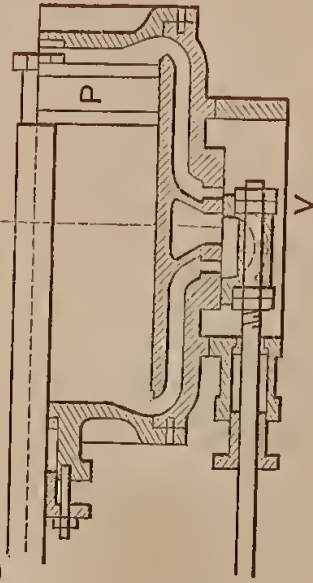

Fig. 2

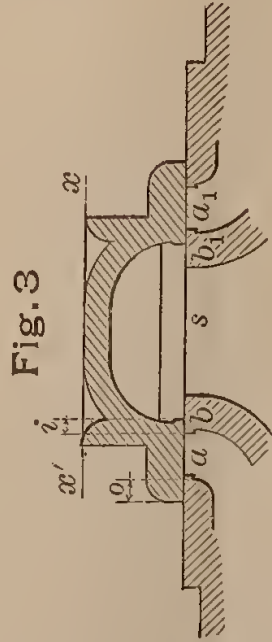

Fig. 3

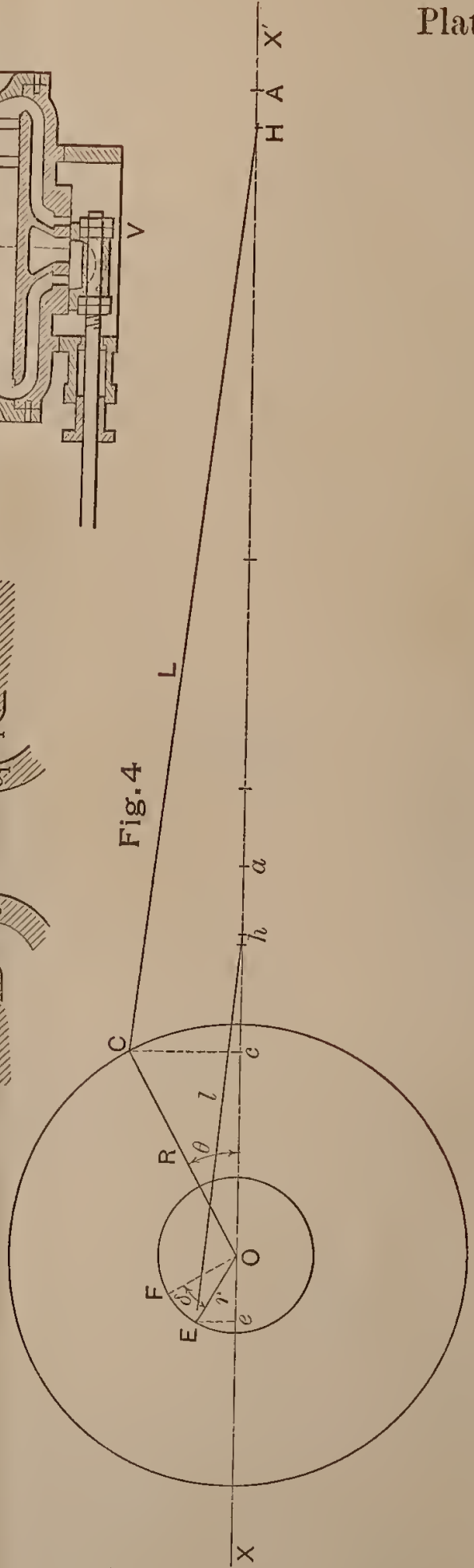

Fig. 4

145

Lin

Lir

Lo

Ma

Ma

Ma

M

Pi

Pe

Pe

Pr

R

R

R

R

R

R

S

S

S

S

S

Fig. 7

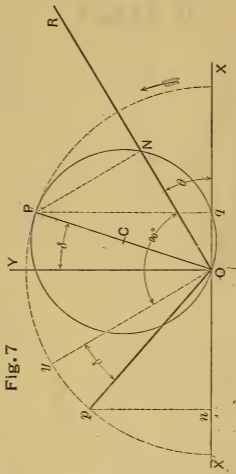
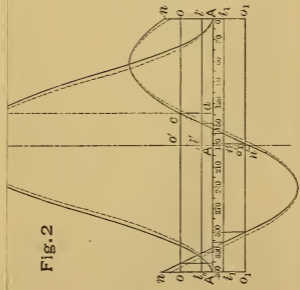
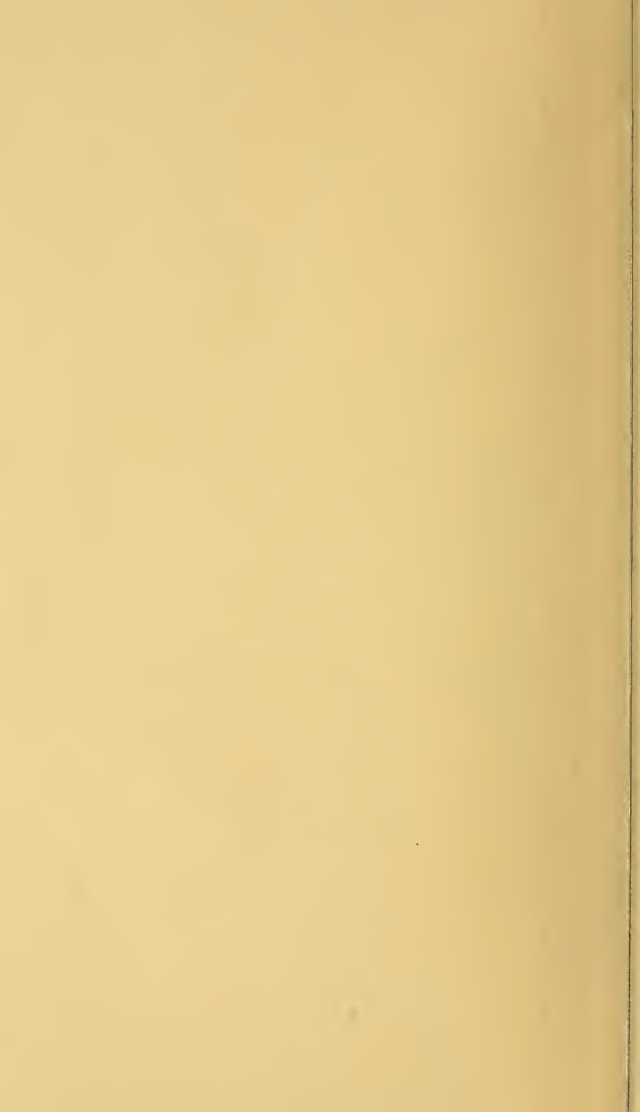

Fig. 2





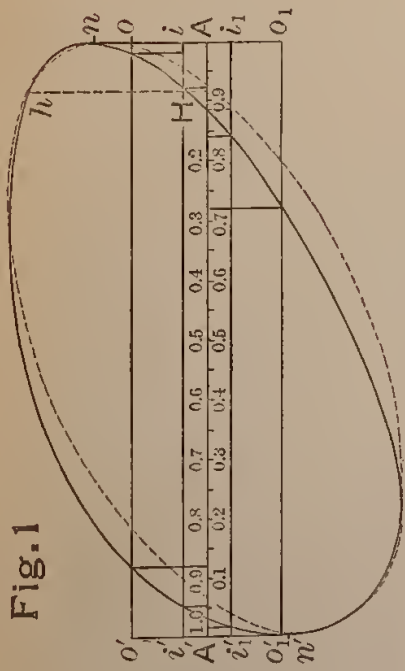

Fig. 3

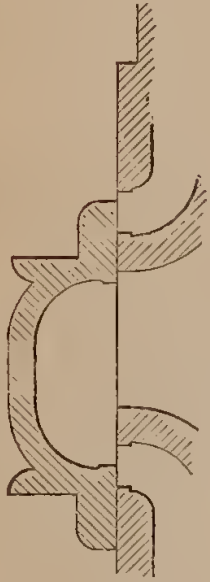

Fig. 4

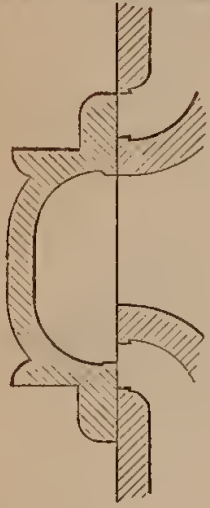

Fig. 5

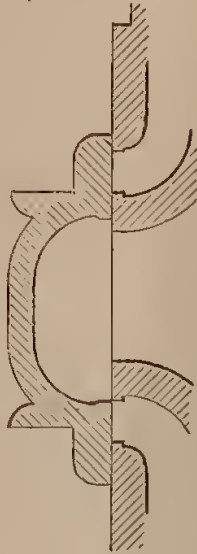

Fig. 6

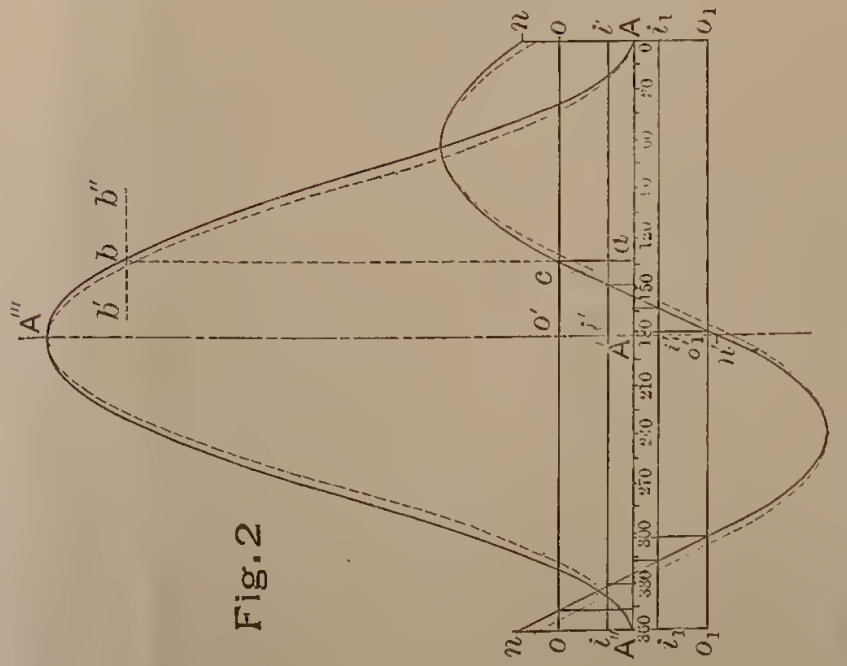
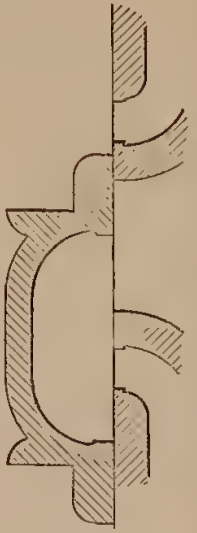
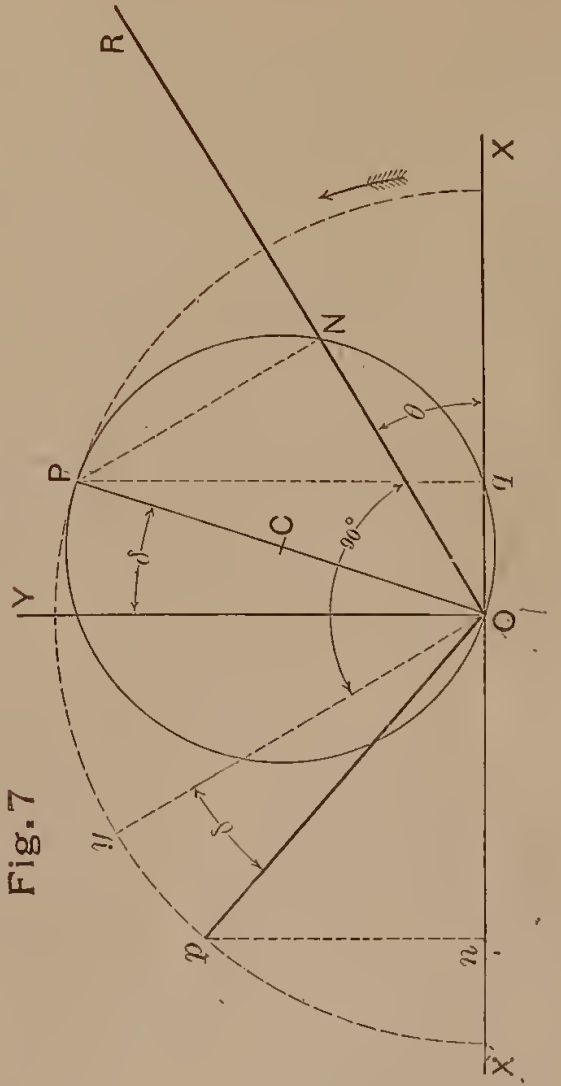

Fig. 7



1

1

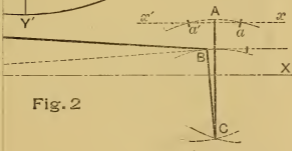
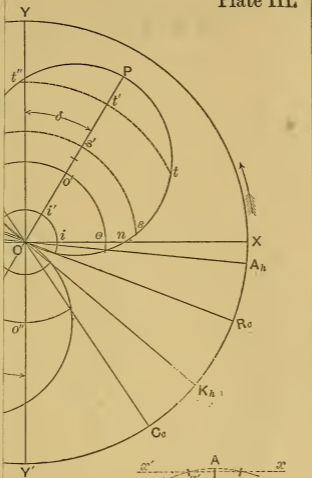

Fig. 2



Fig. 3

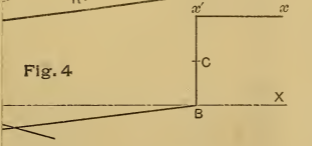

Fig. 4

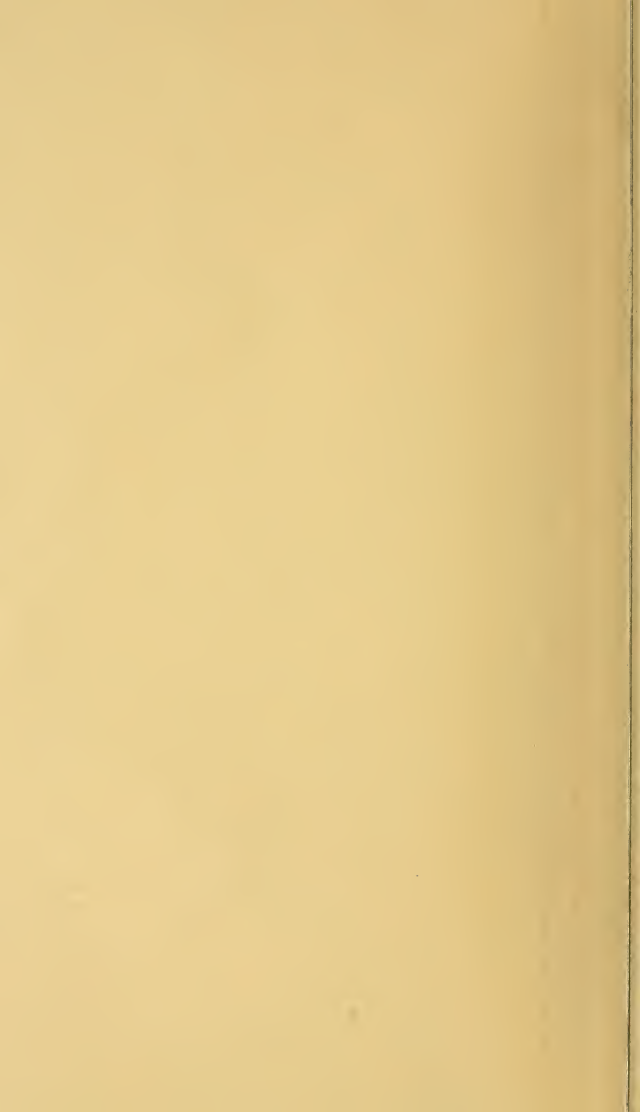

Fig. 1

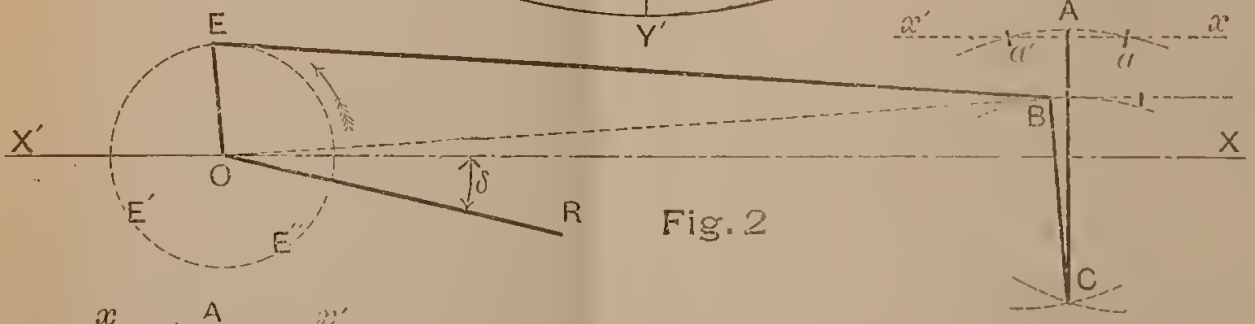
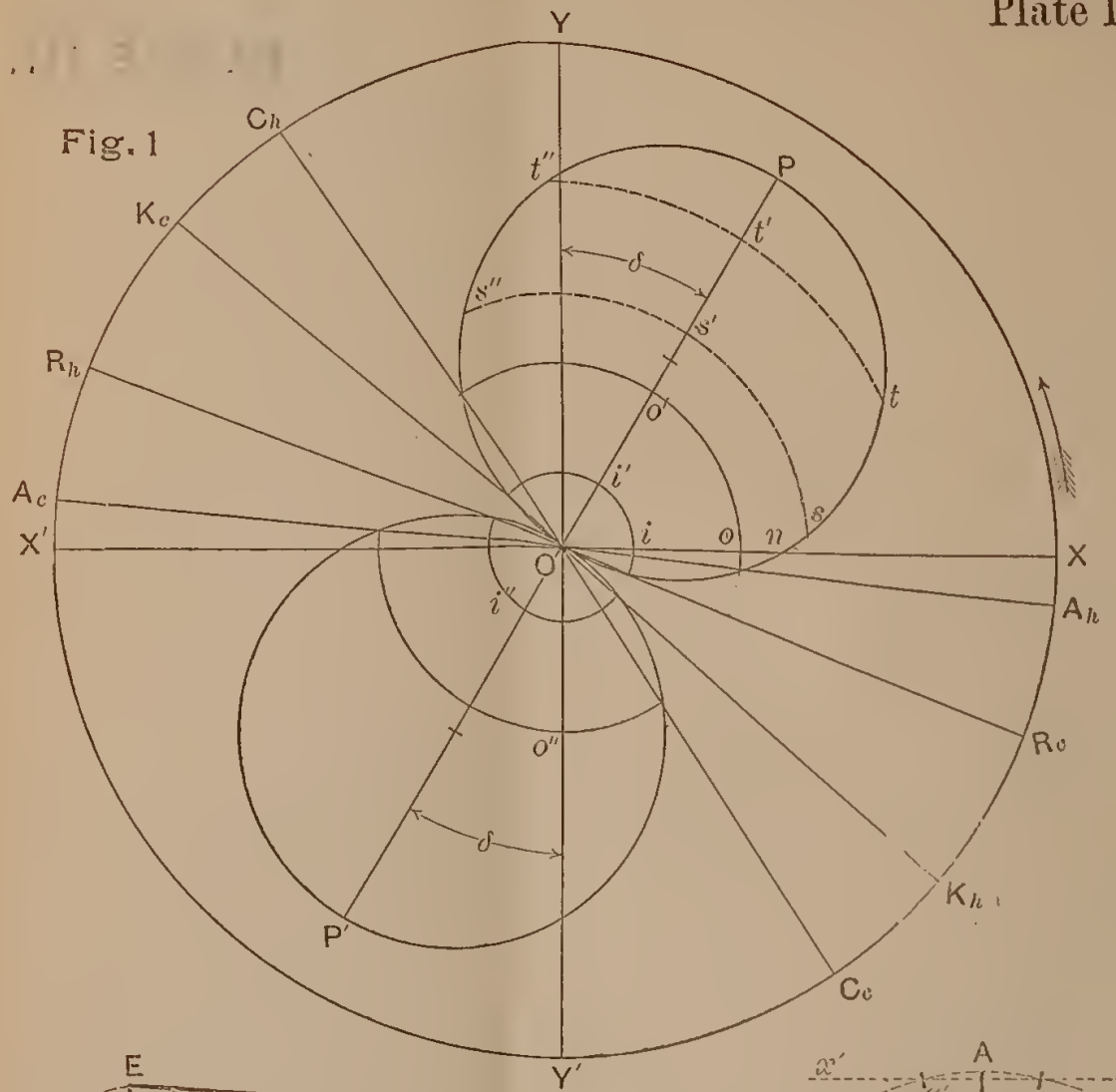

Fig. 2

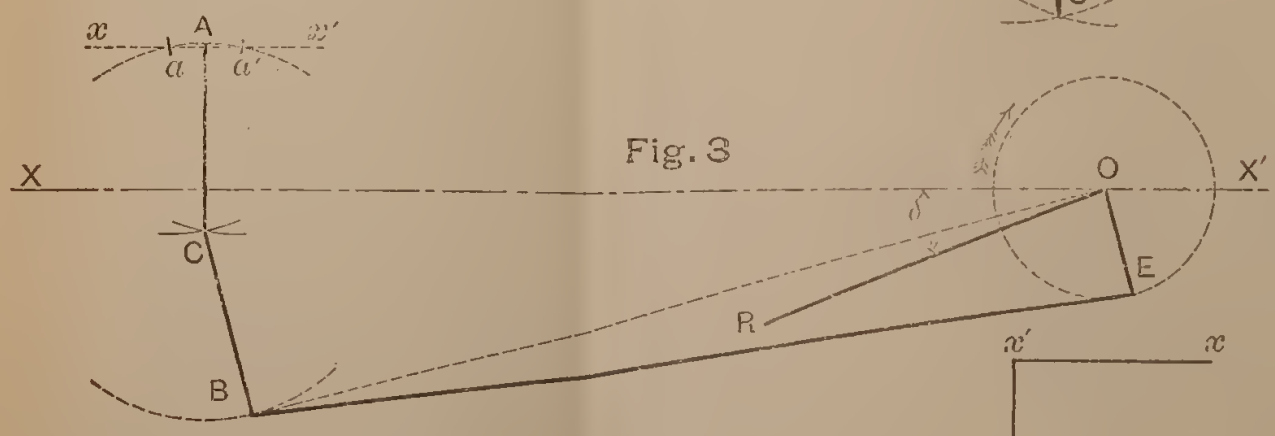

Fig. 3

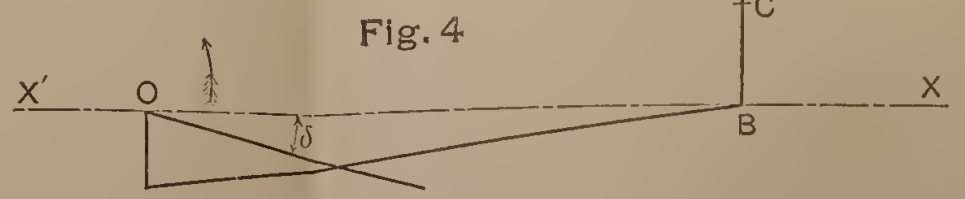
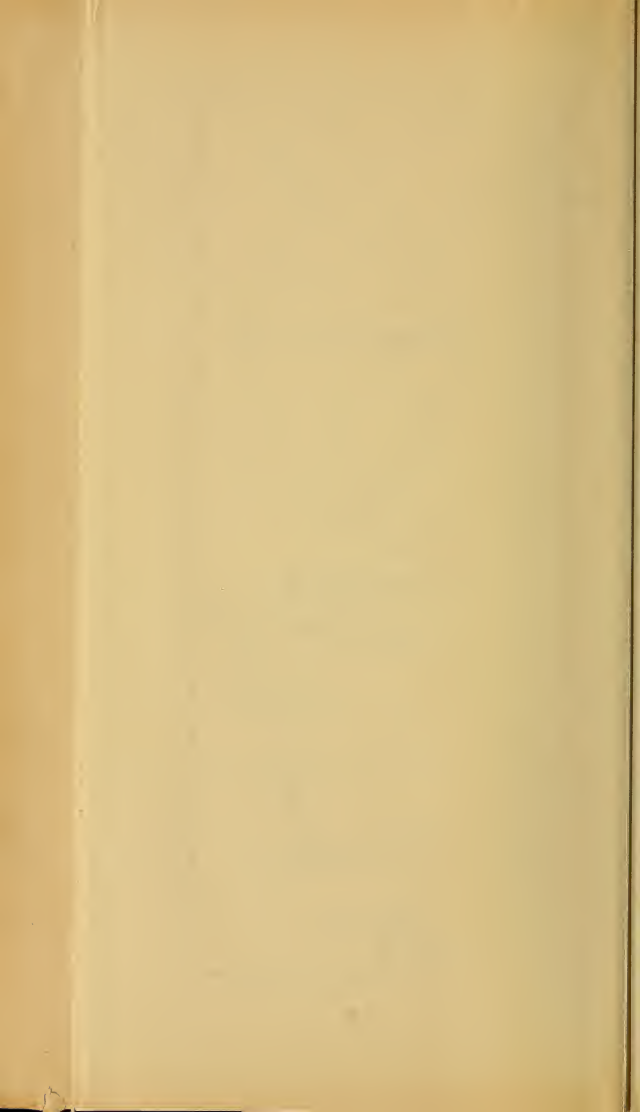
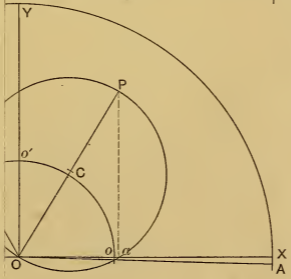
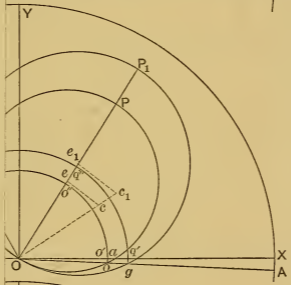
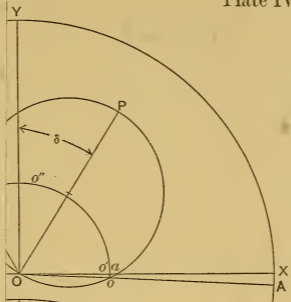

Fig. 4





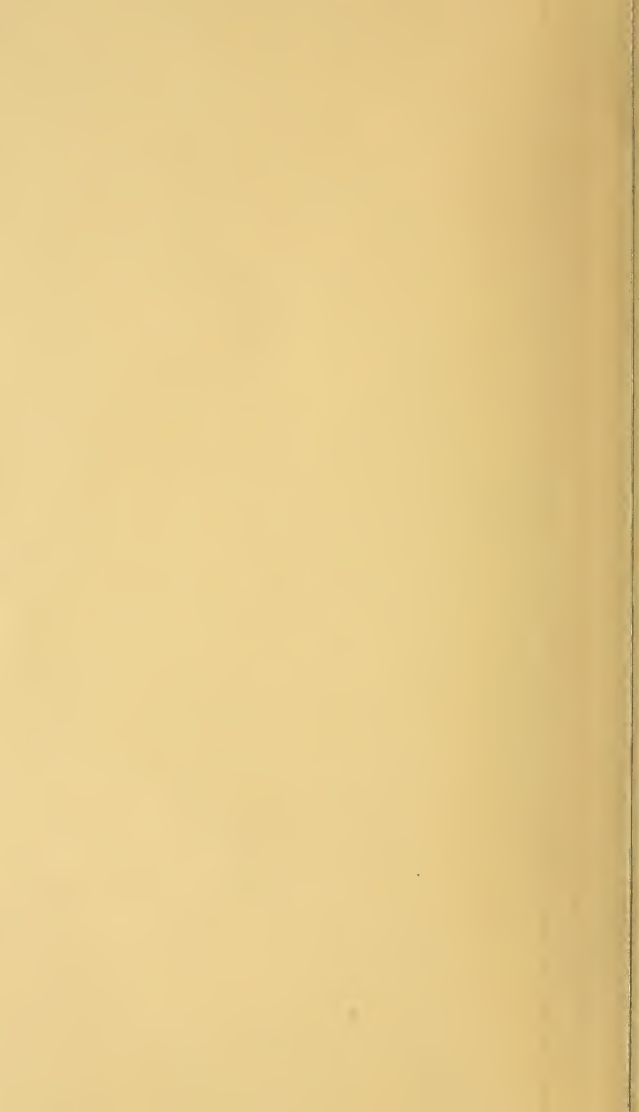

Fig. 1

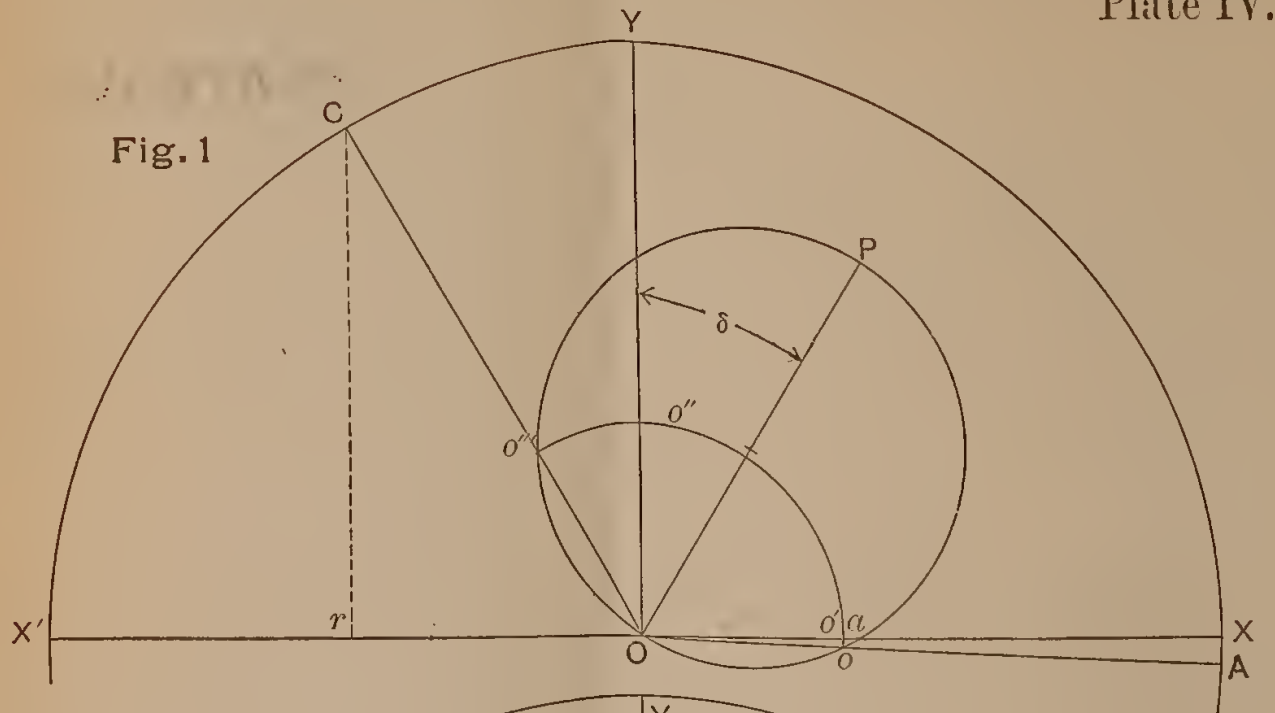

Fig. 2

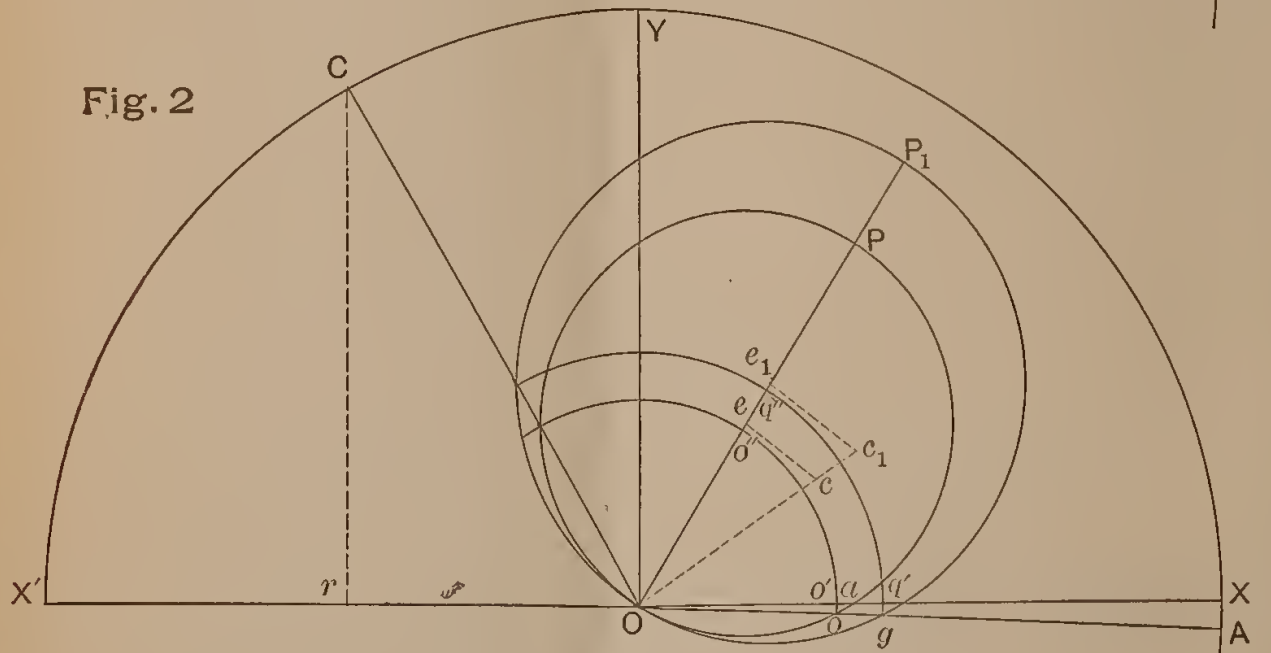
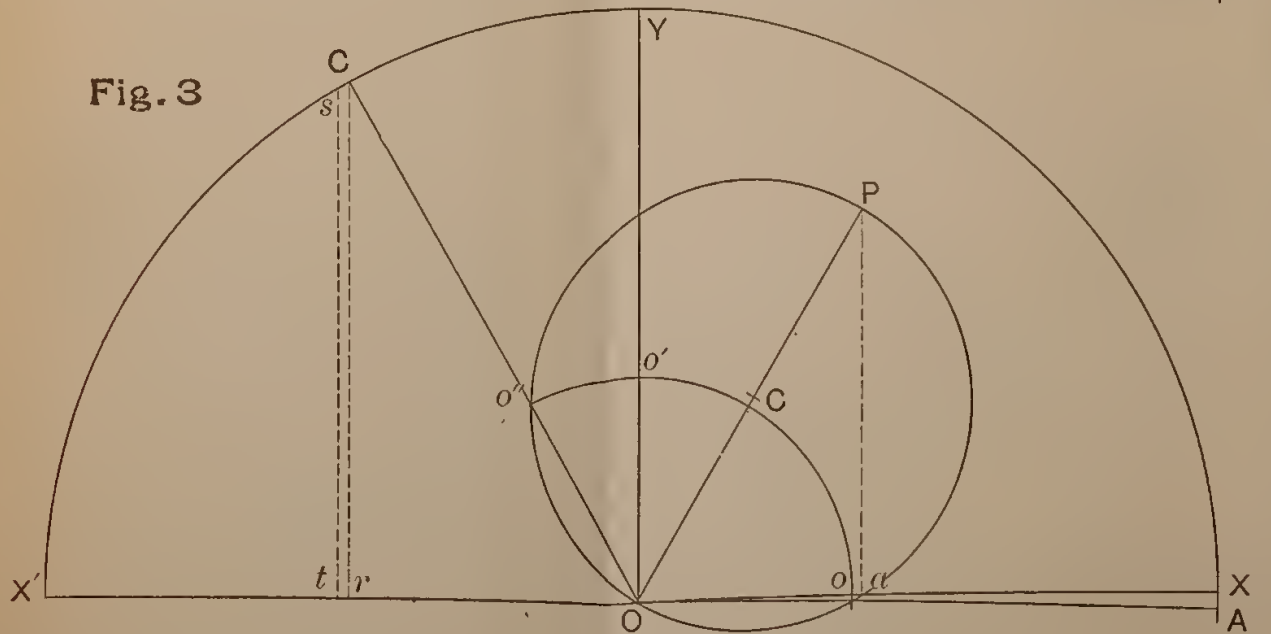
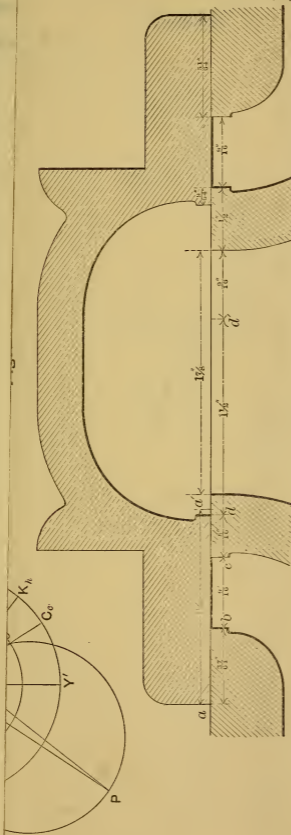
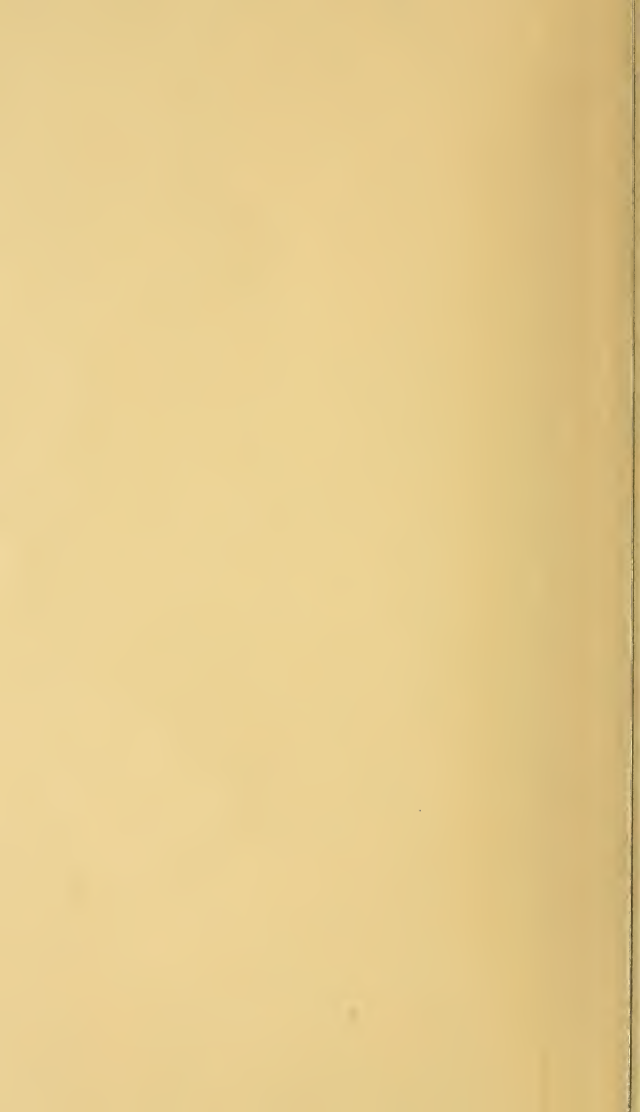

Fig. 3









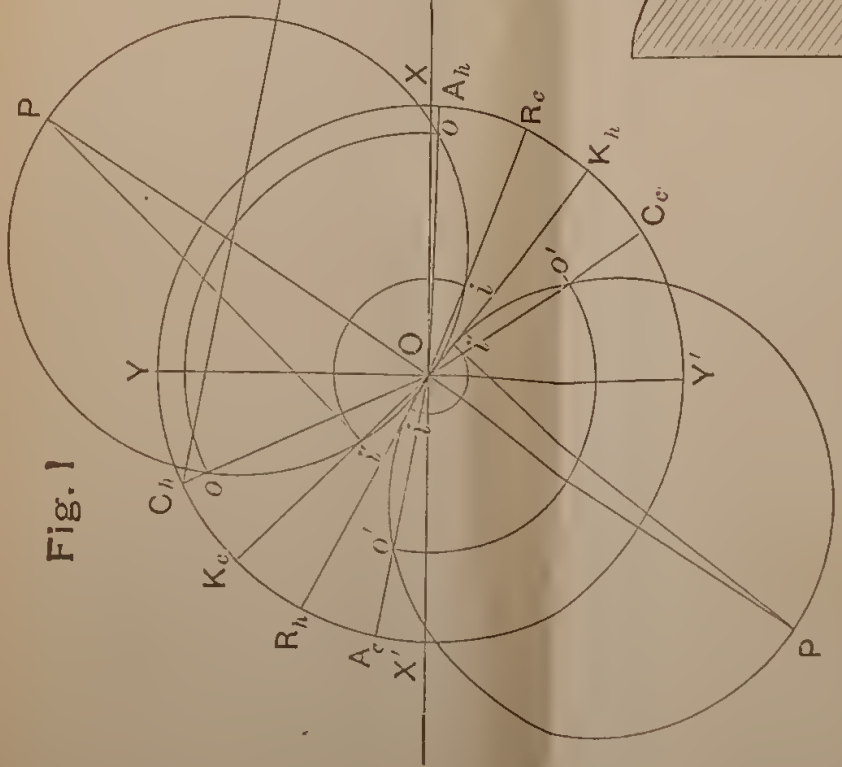

Fig. 3

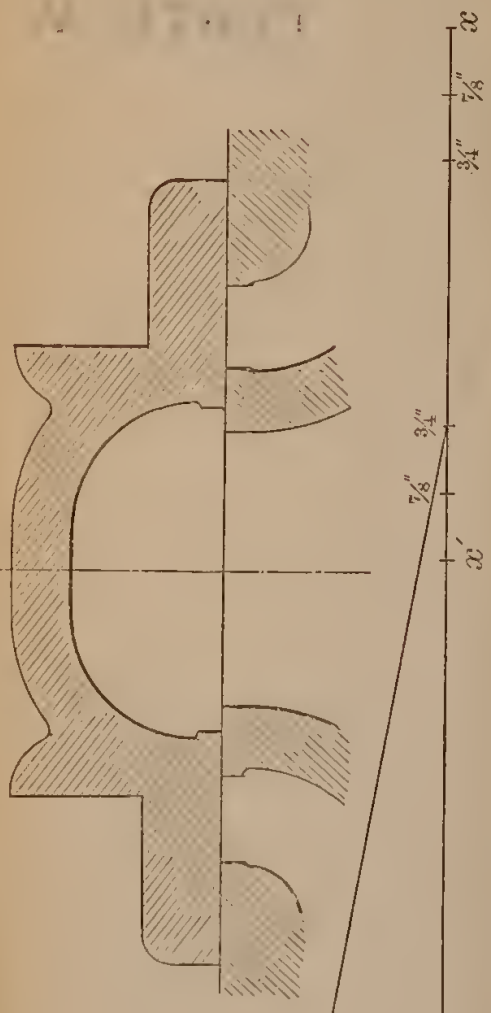
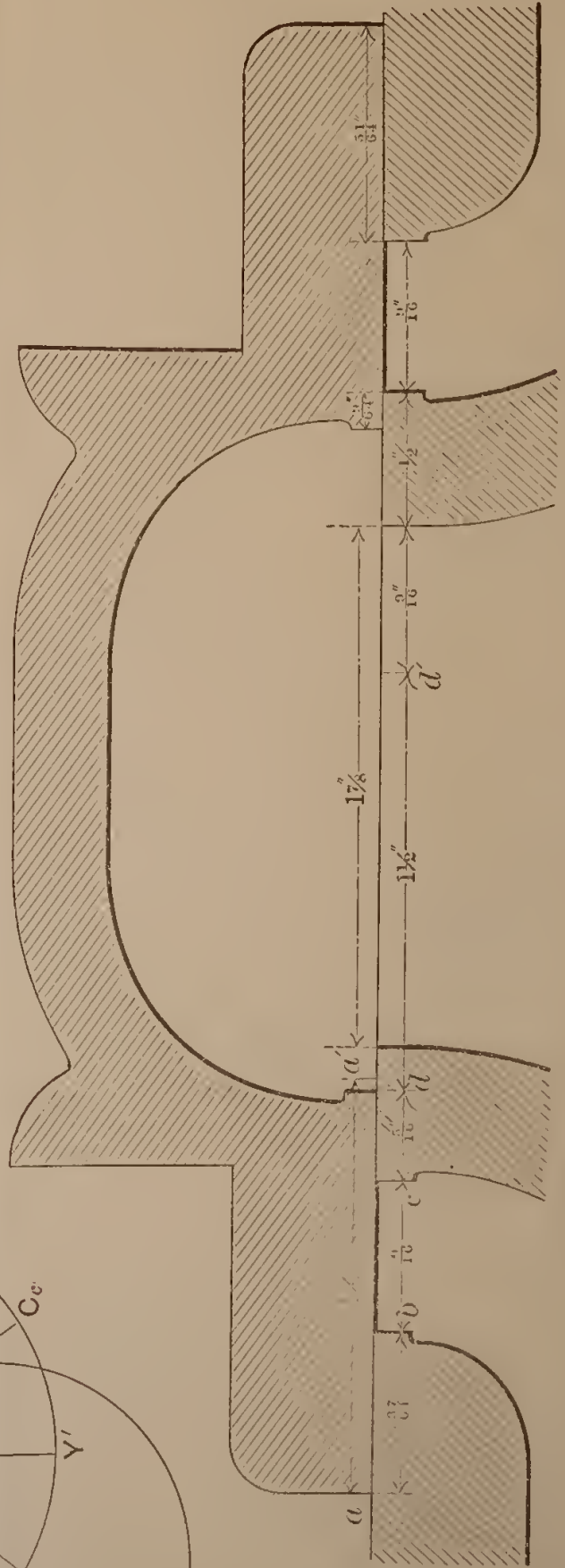
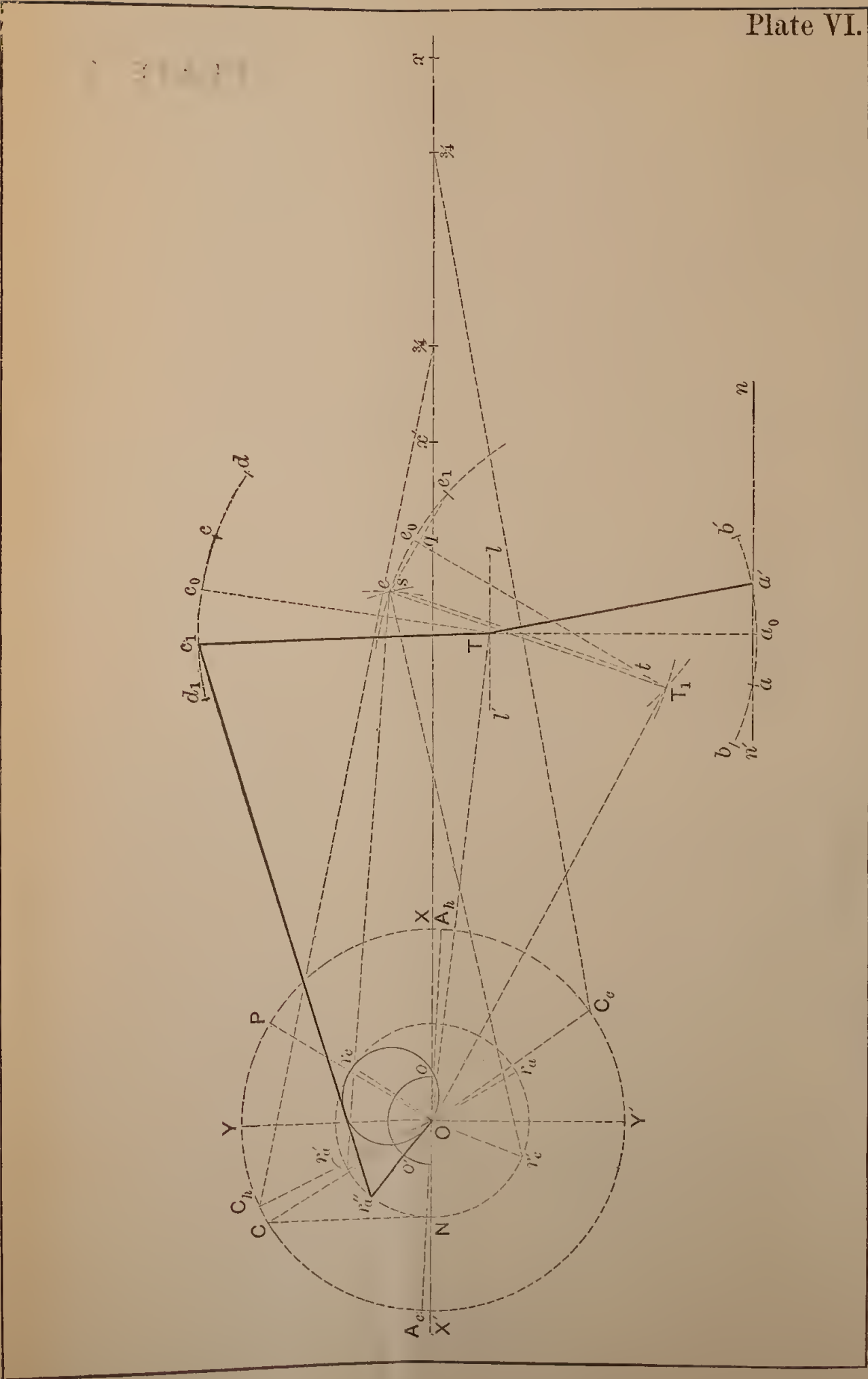

Fig. 2









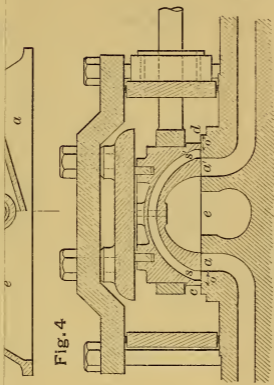
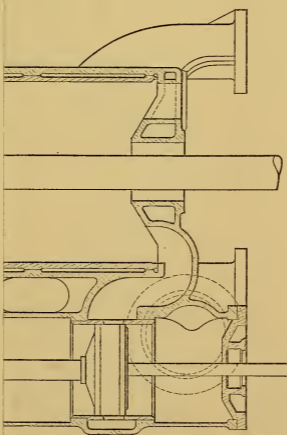
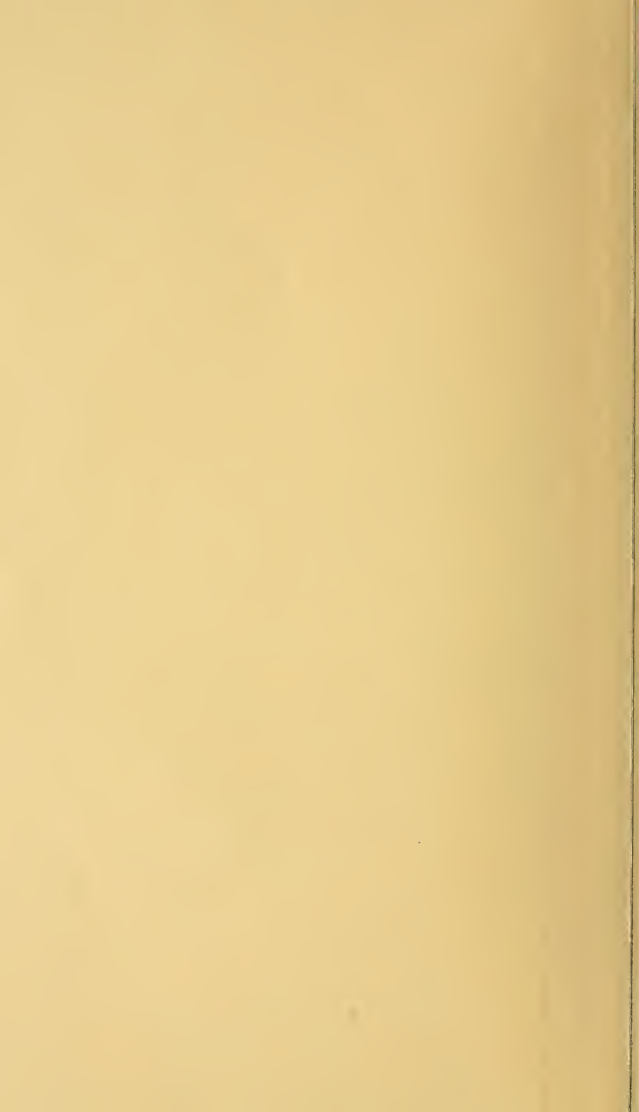

Fig. 4





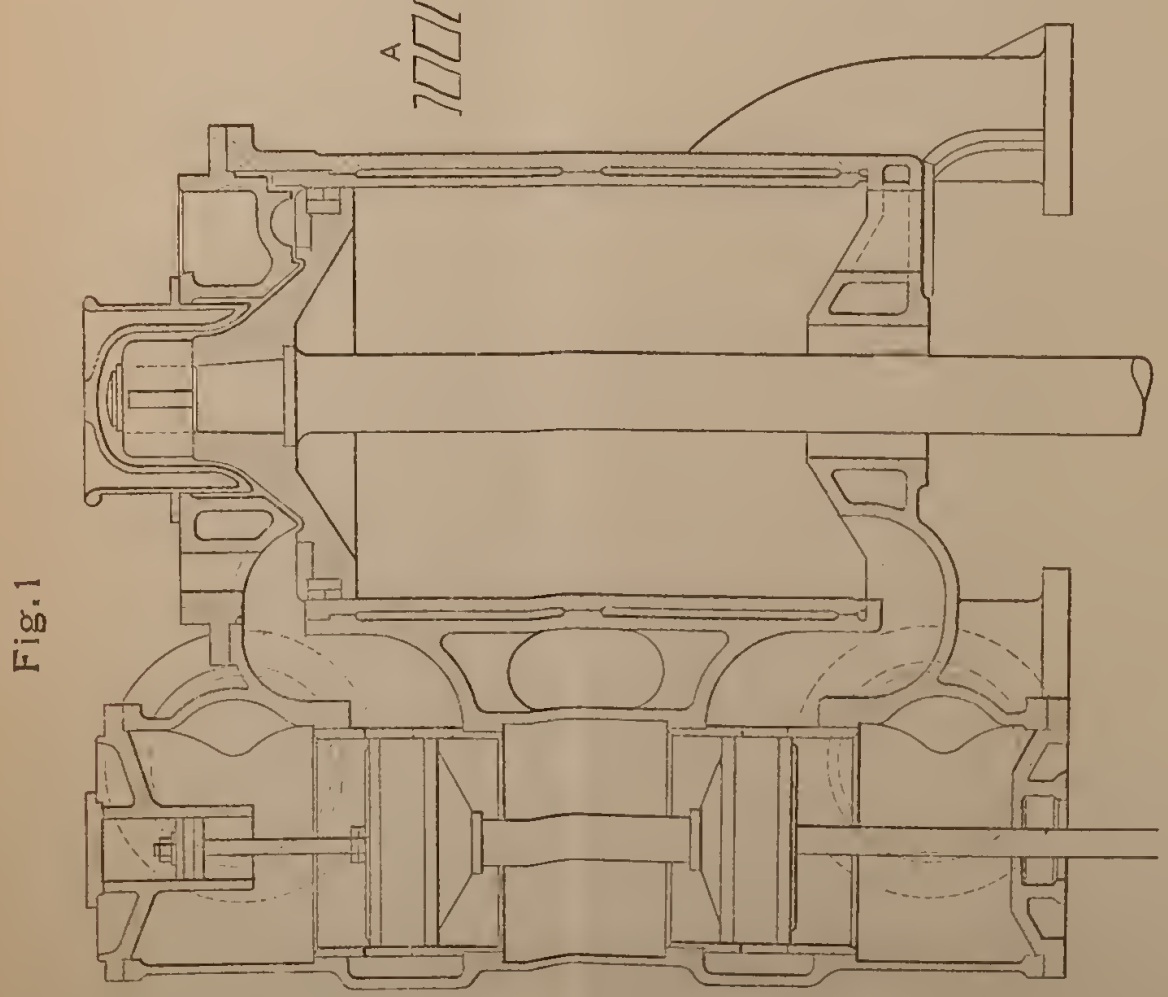

Fig. 1

Fig. 2

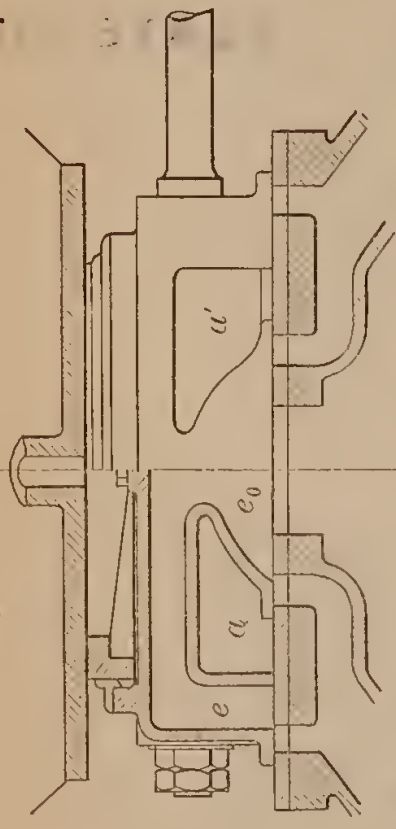

Fig. 3



Fig. 4

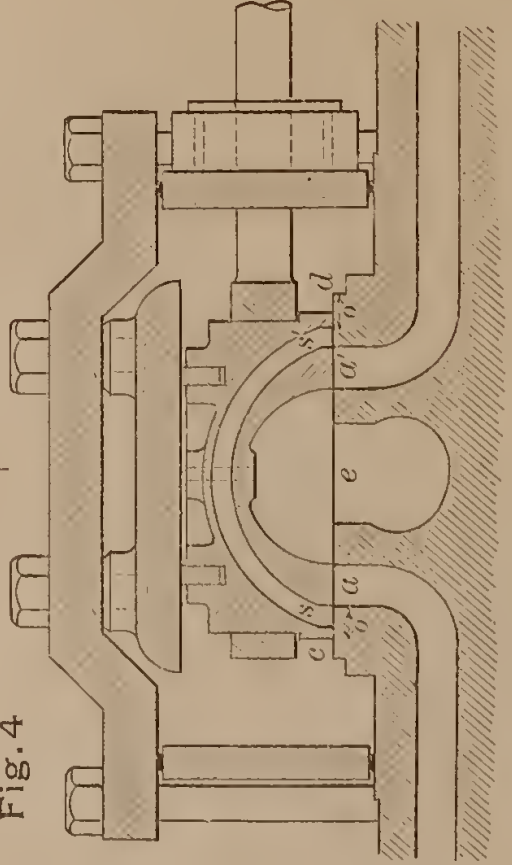



Fig. 1

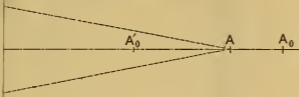

Fig. 2

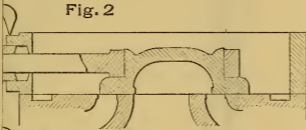
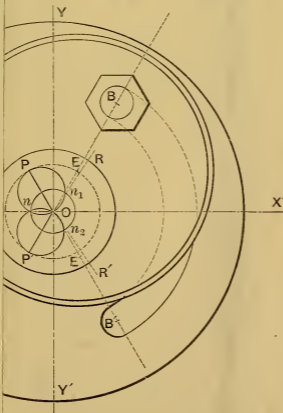
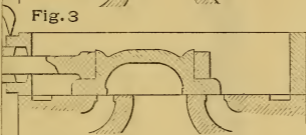
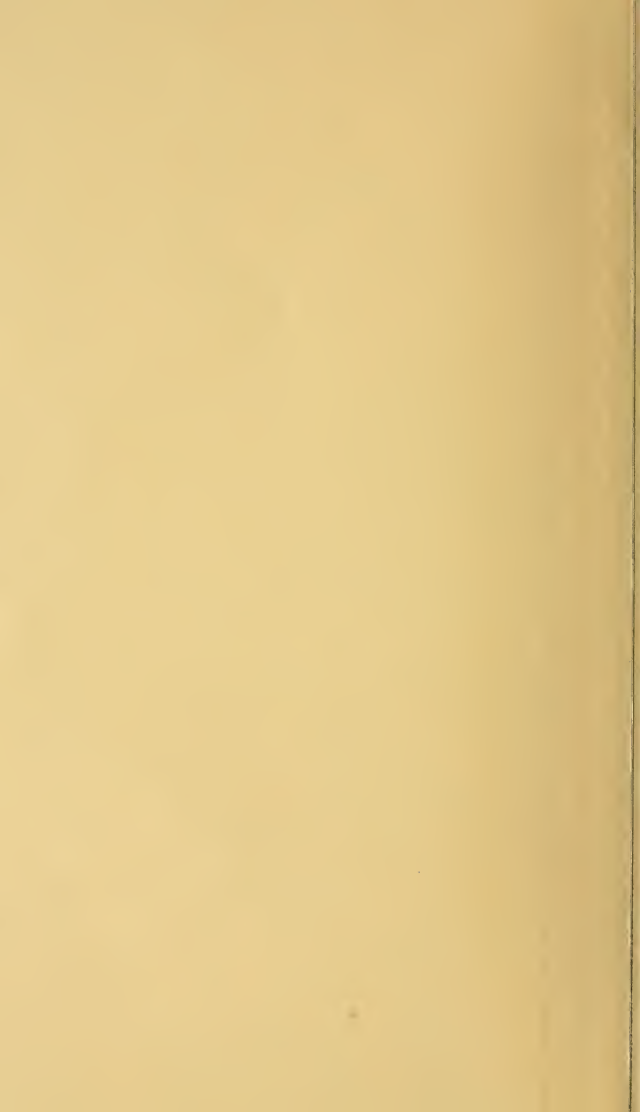
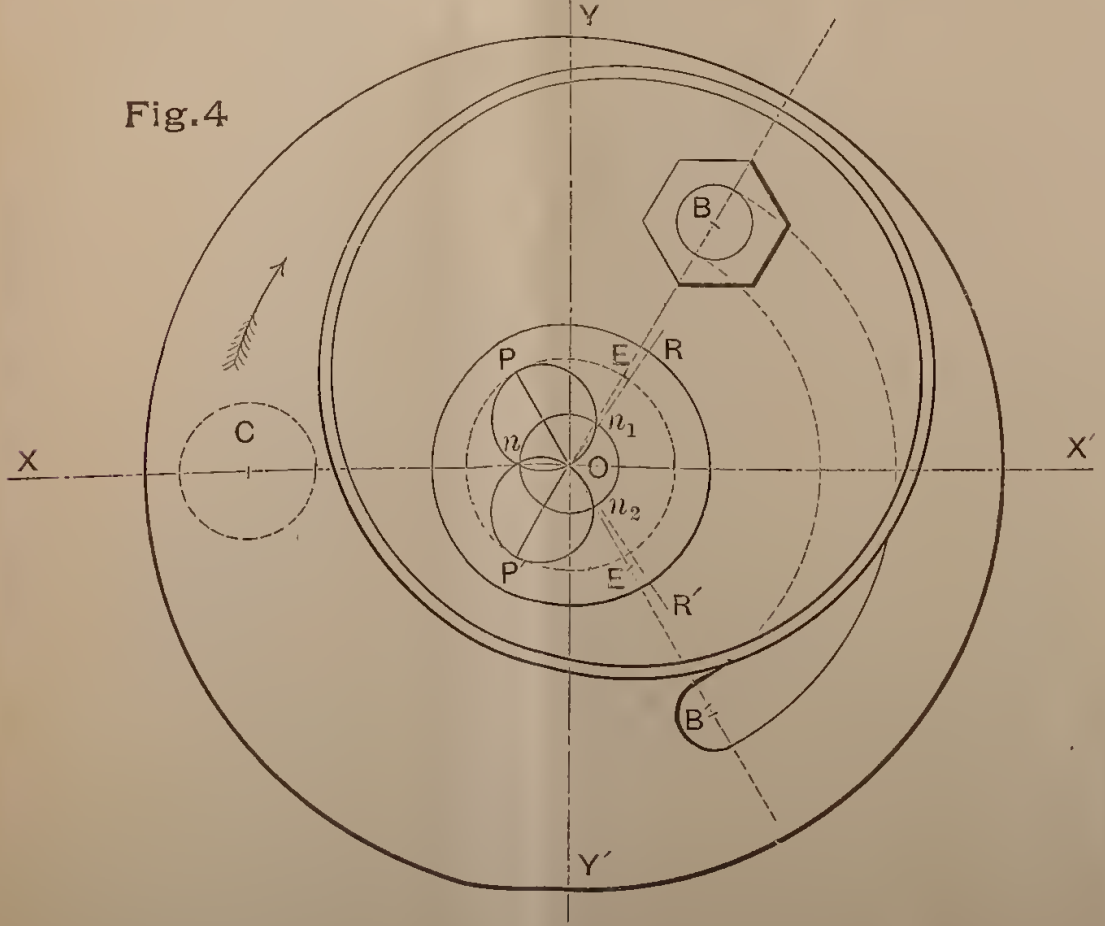
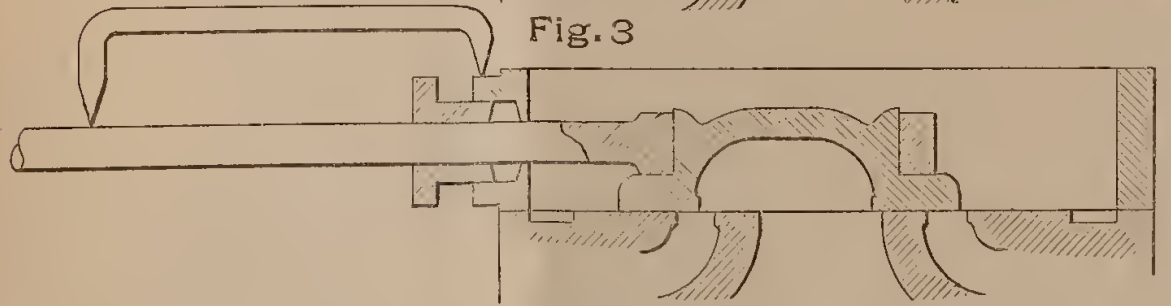
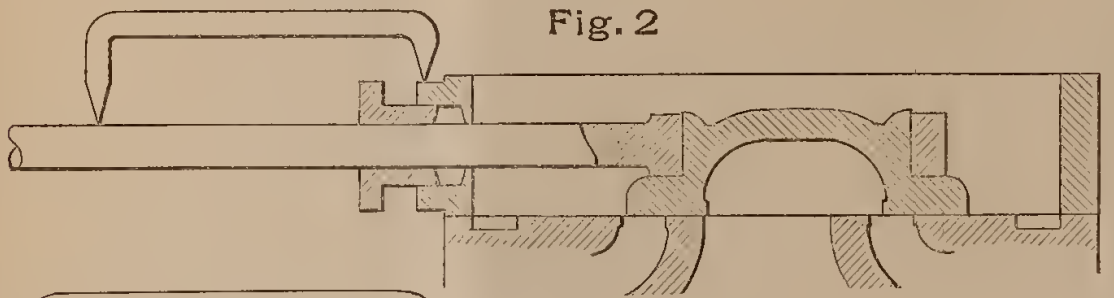
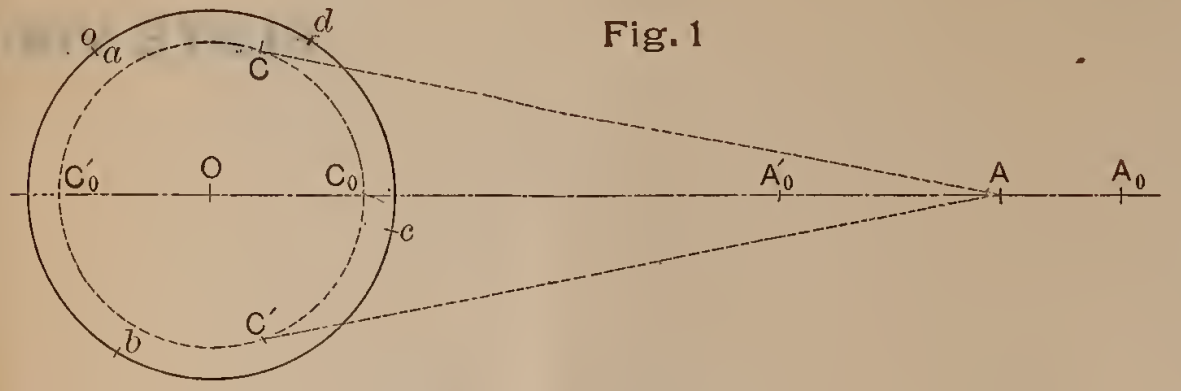

Fig. 3









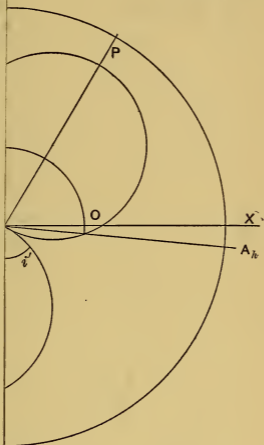
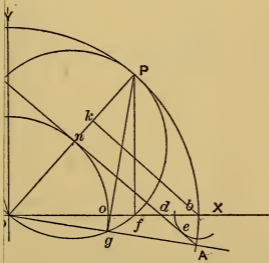

Fig. 3



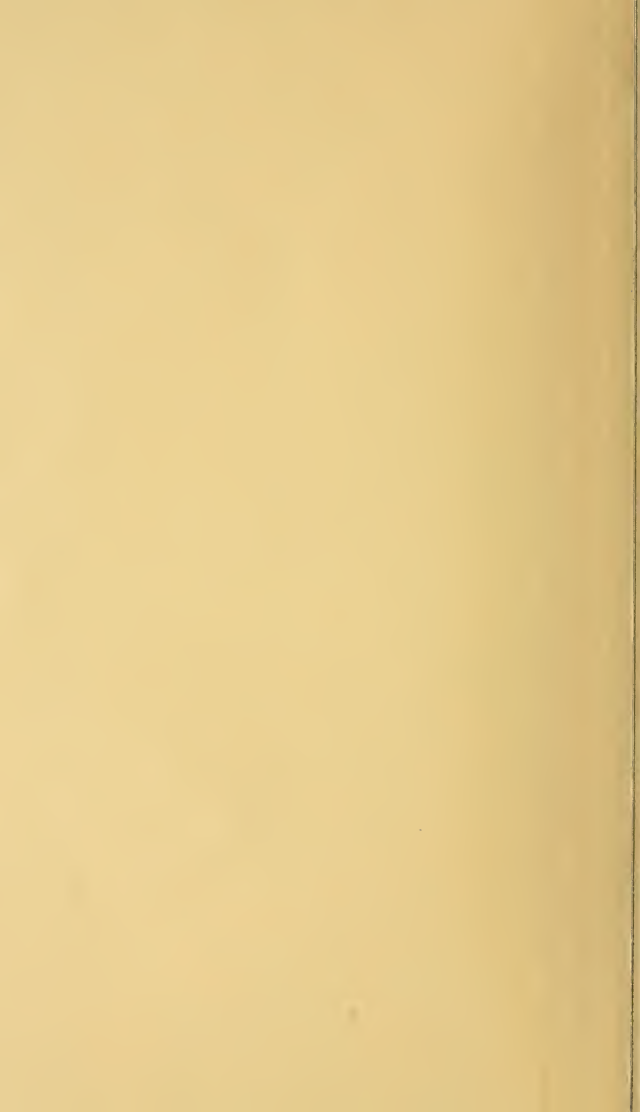

Fig. 1

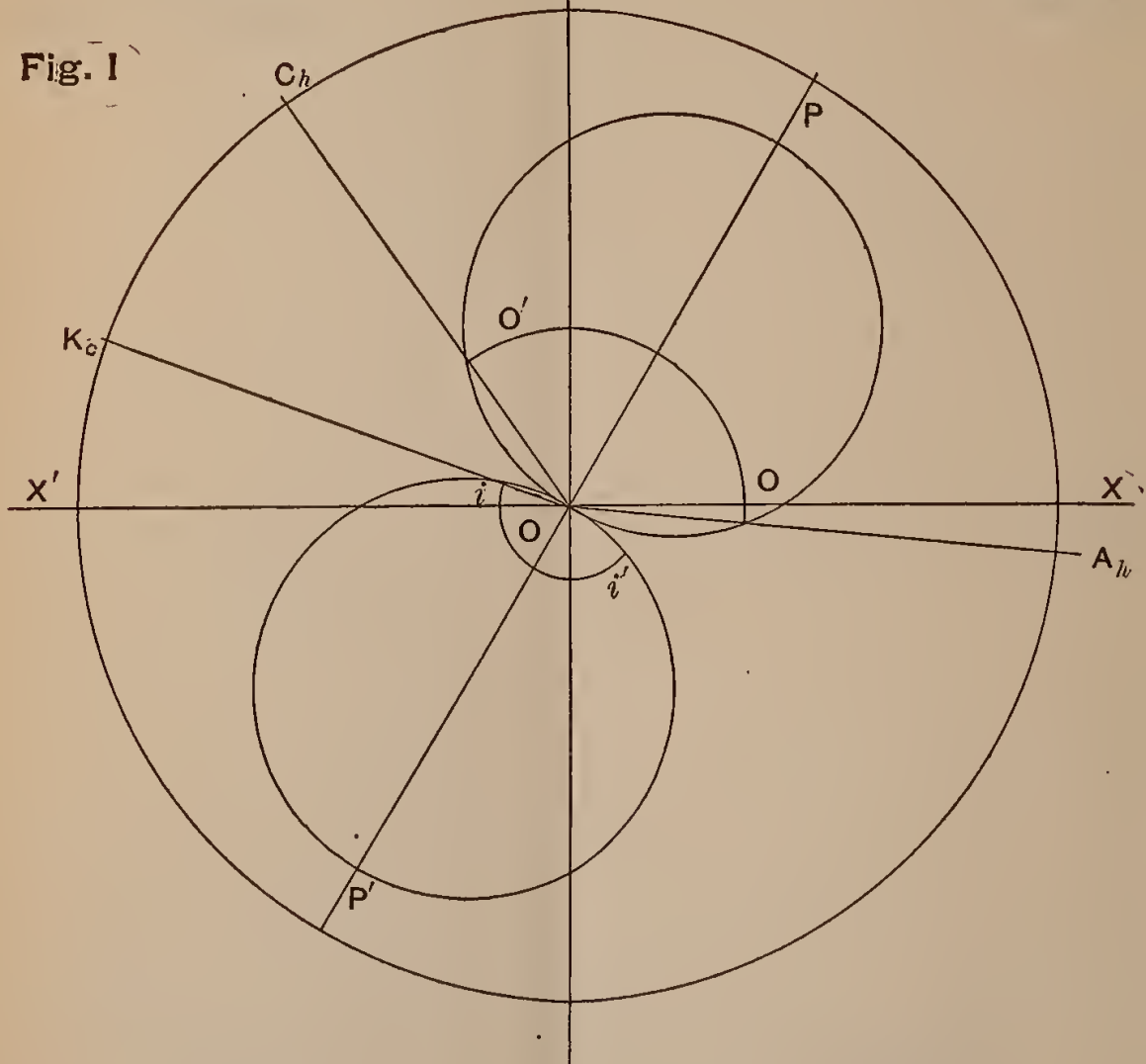

Fig. 2

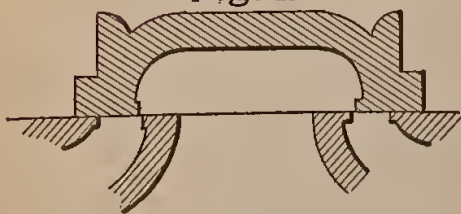

Fig. 3

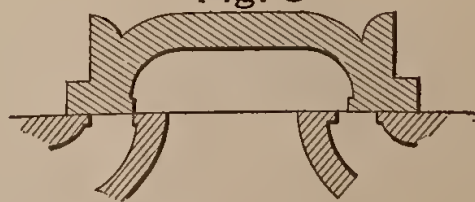
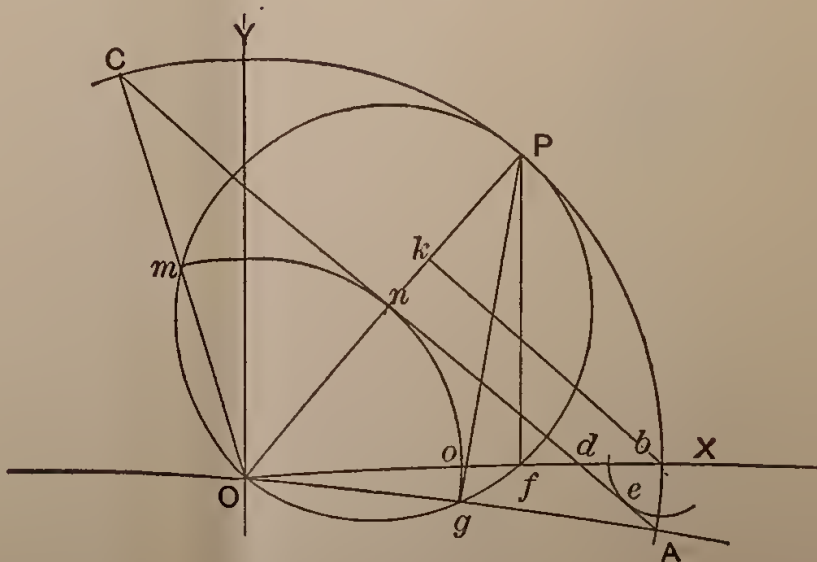
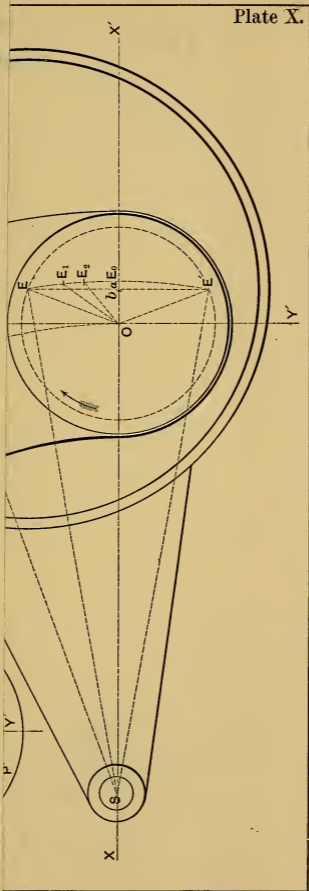

Fig. 4







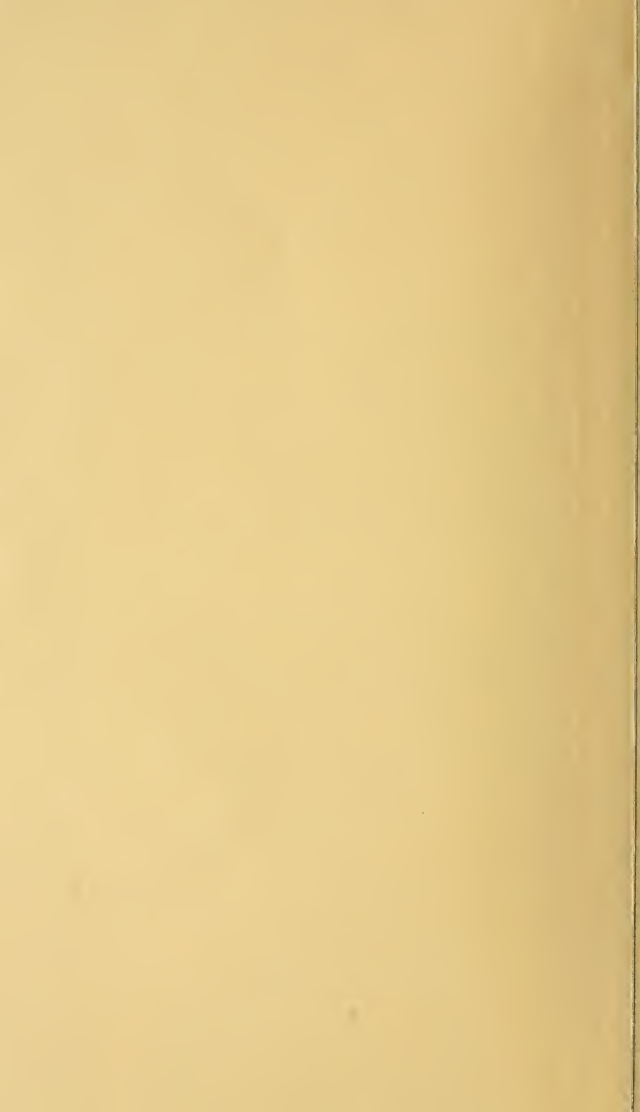

Fig. 1

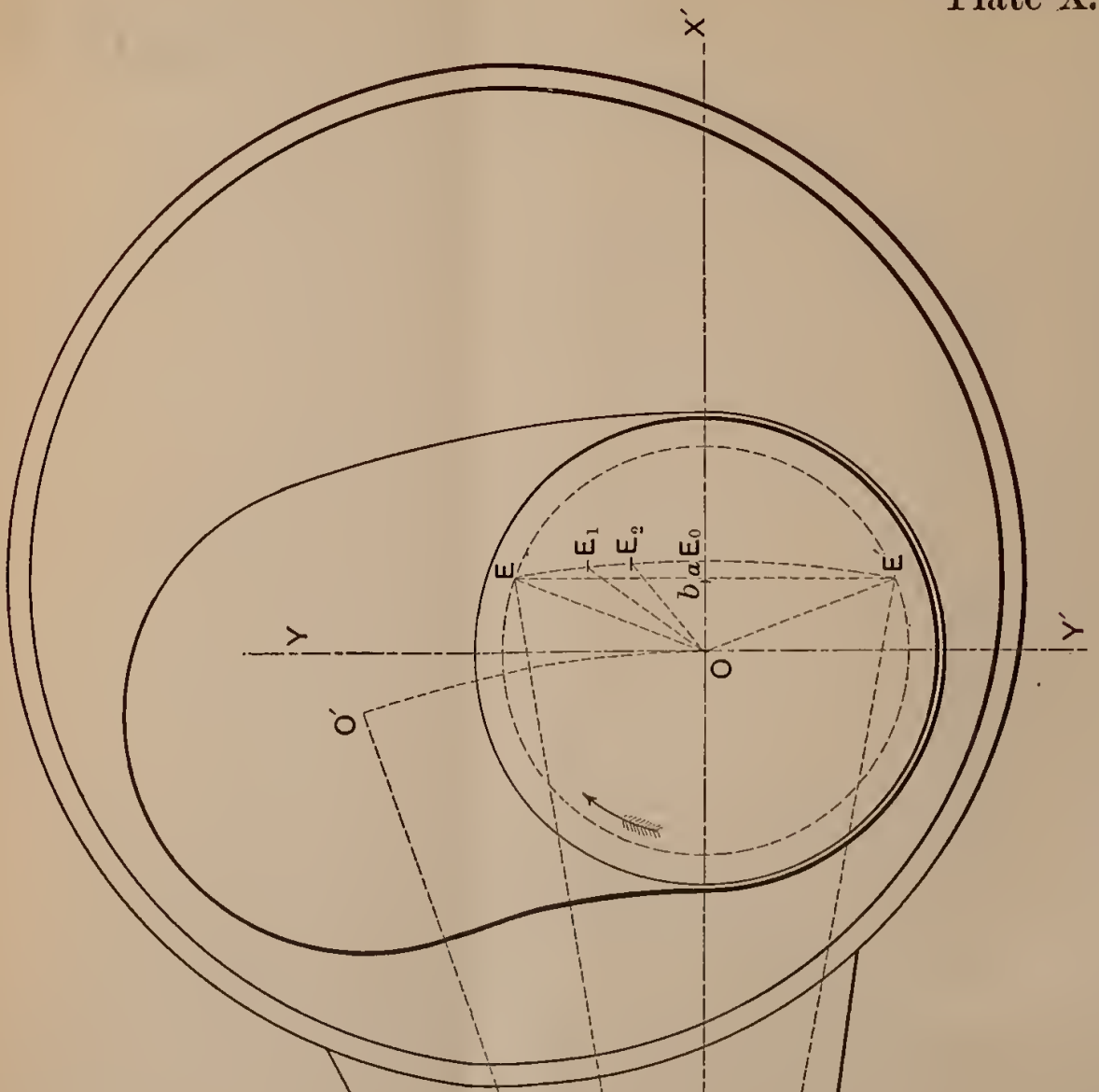
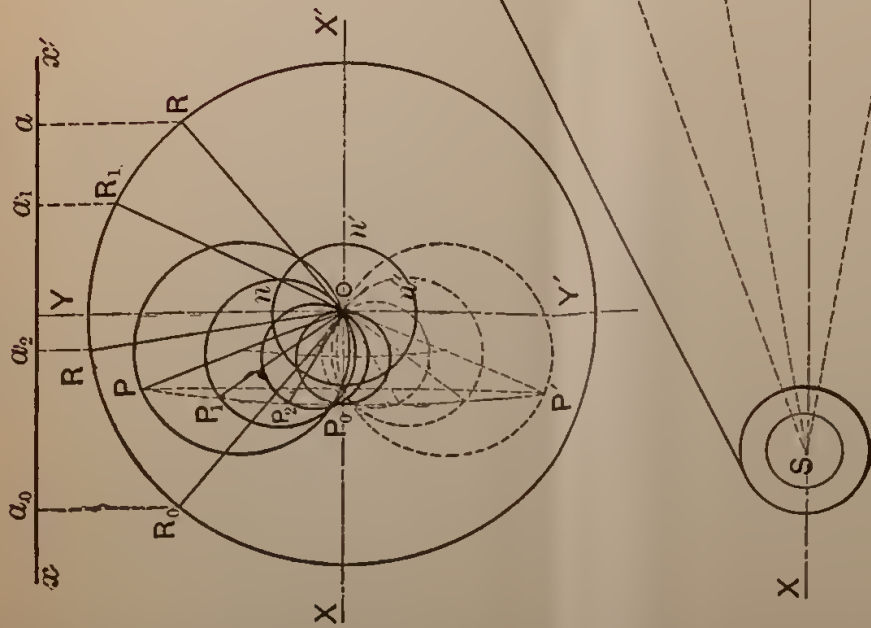

Fig. 2





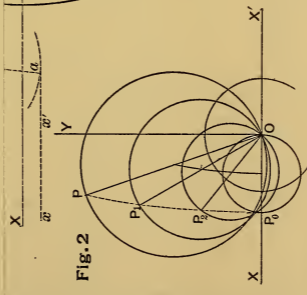
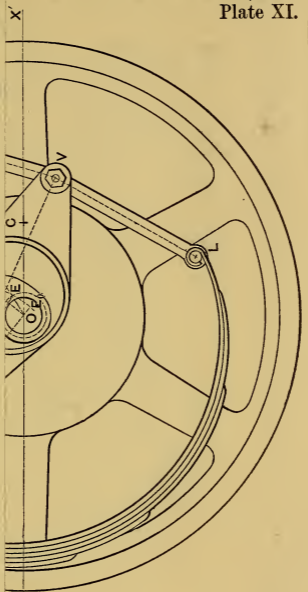
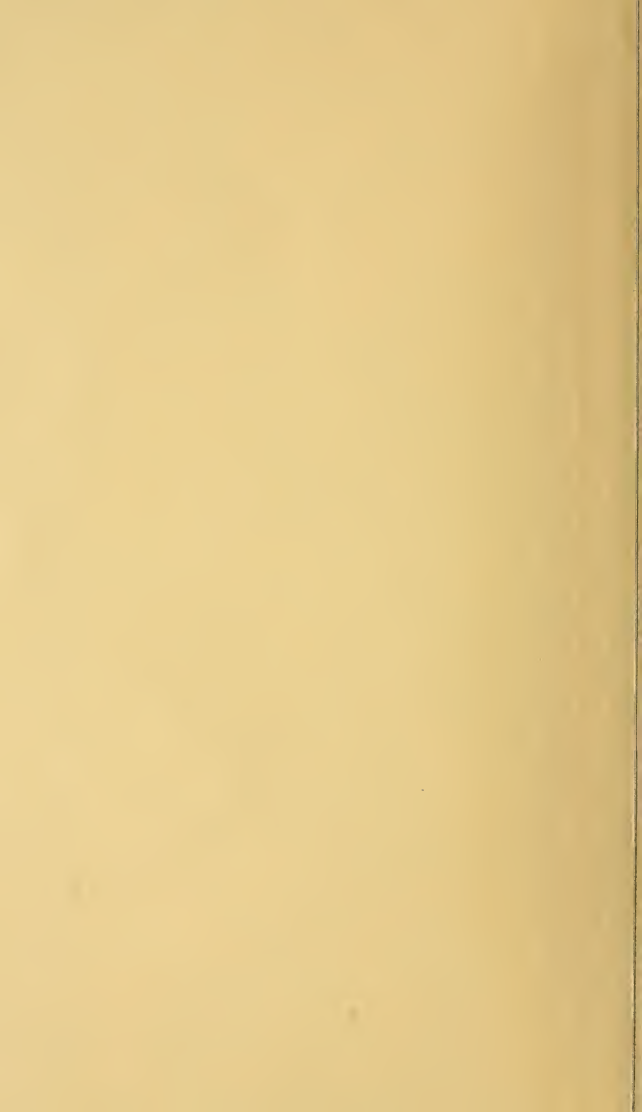

Fig. 2



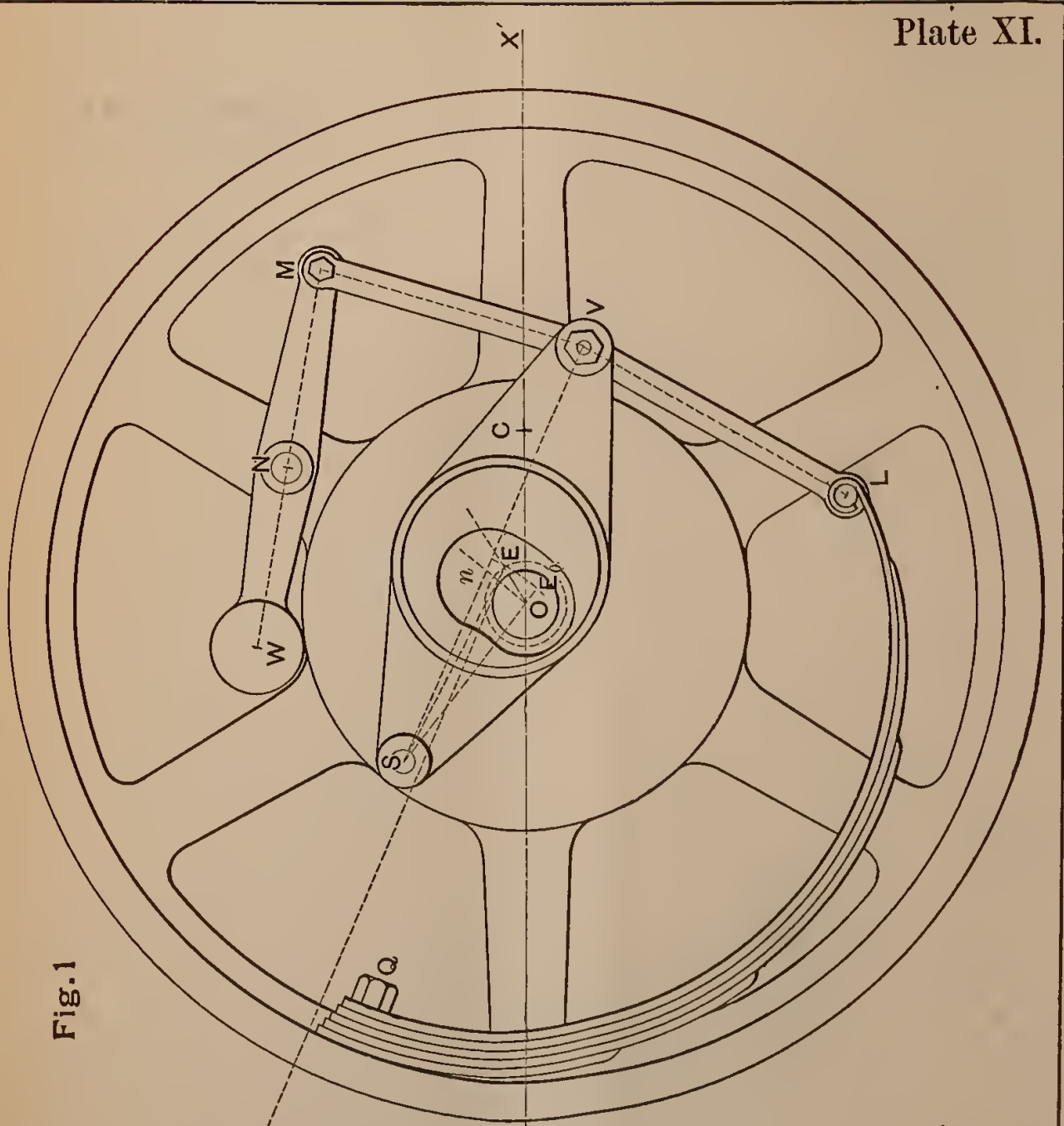

Fig. 1

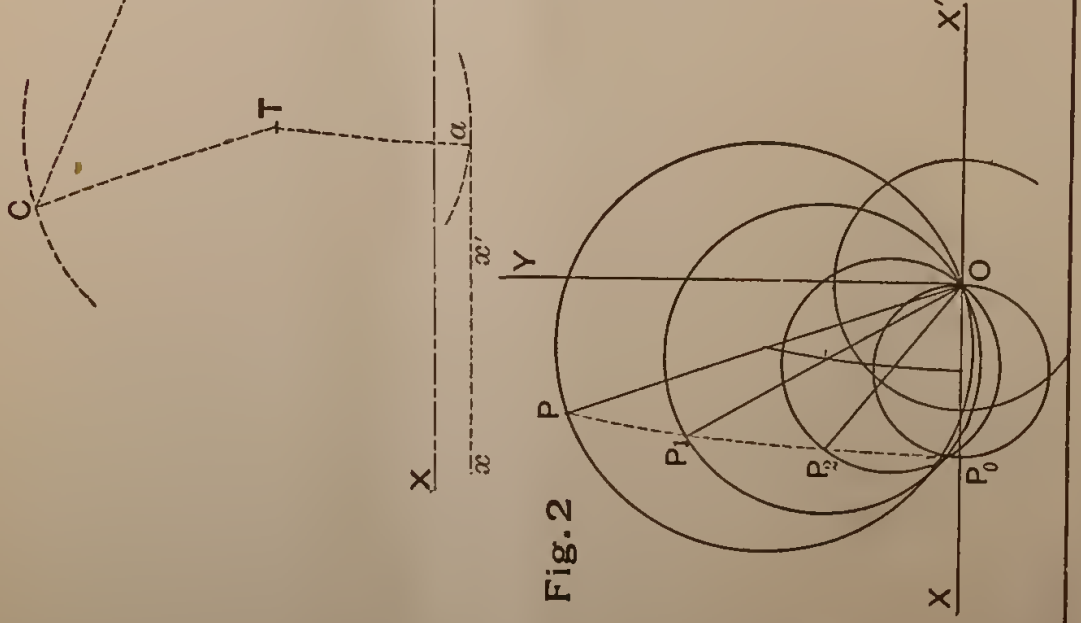
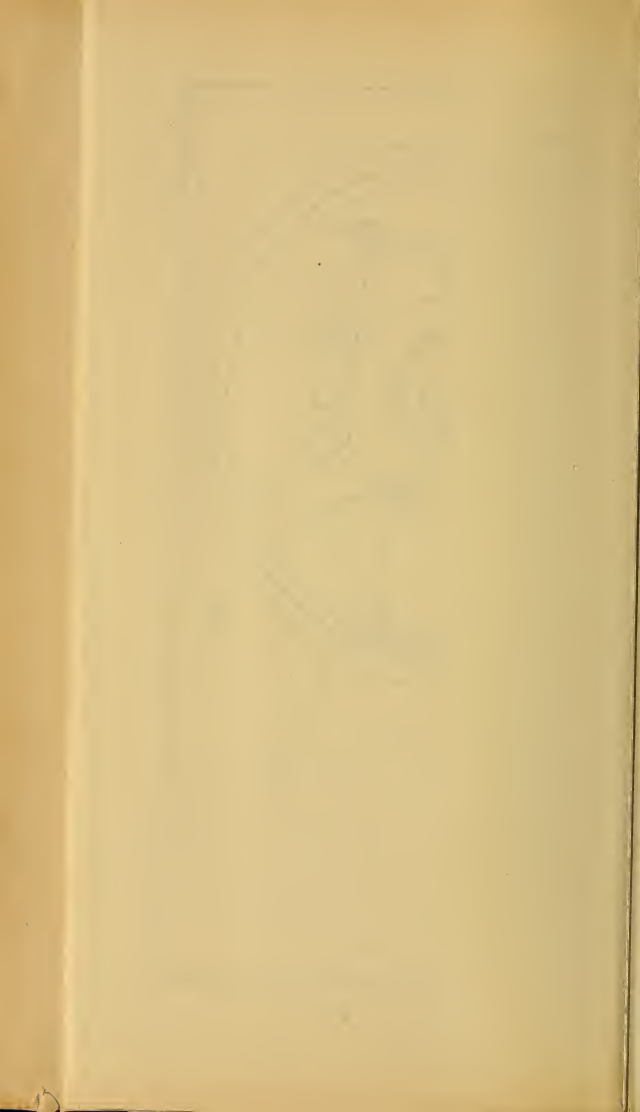

Fig. 2



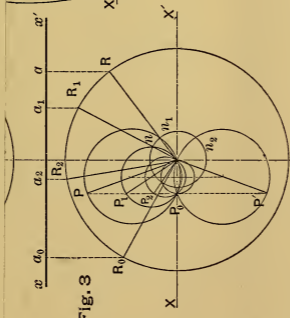
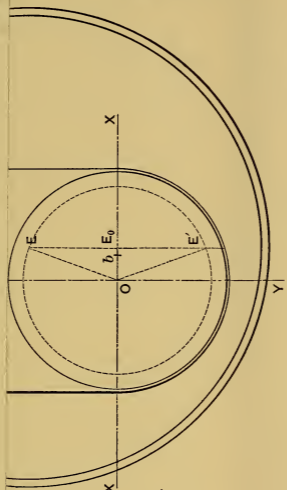

Fig. 3

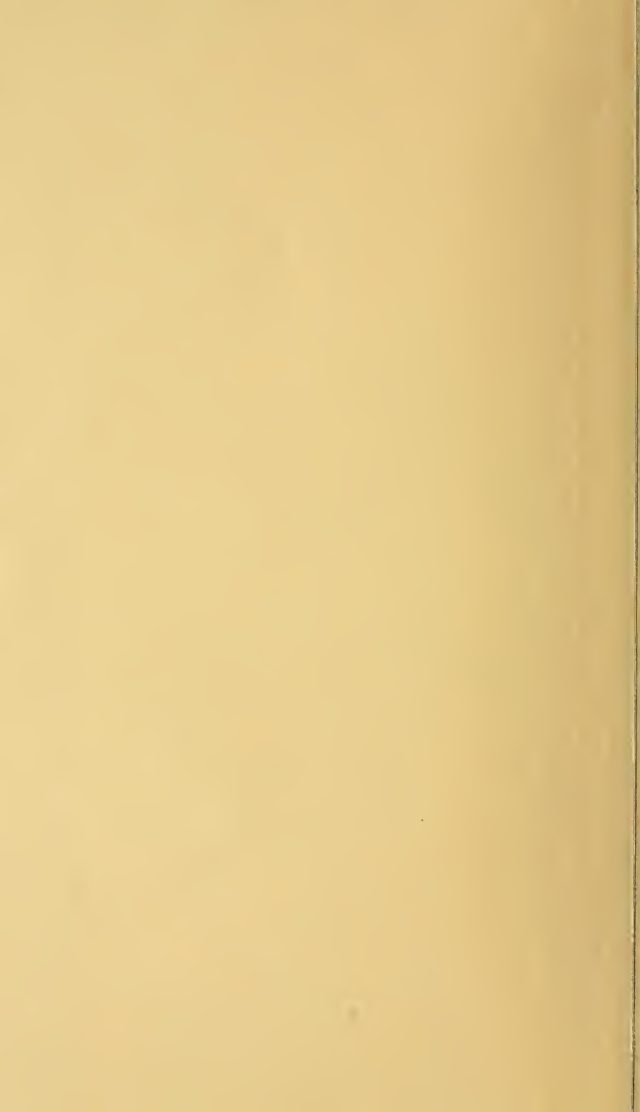

Fig. 2

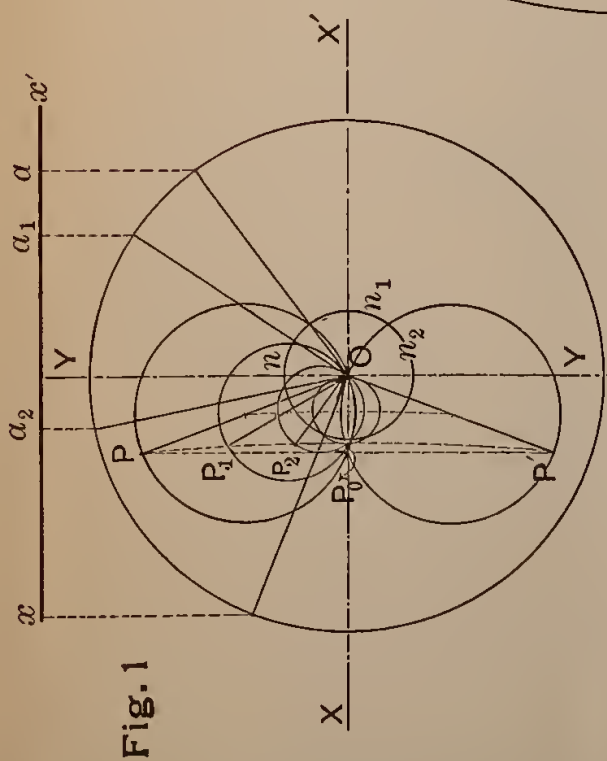
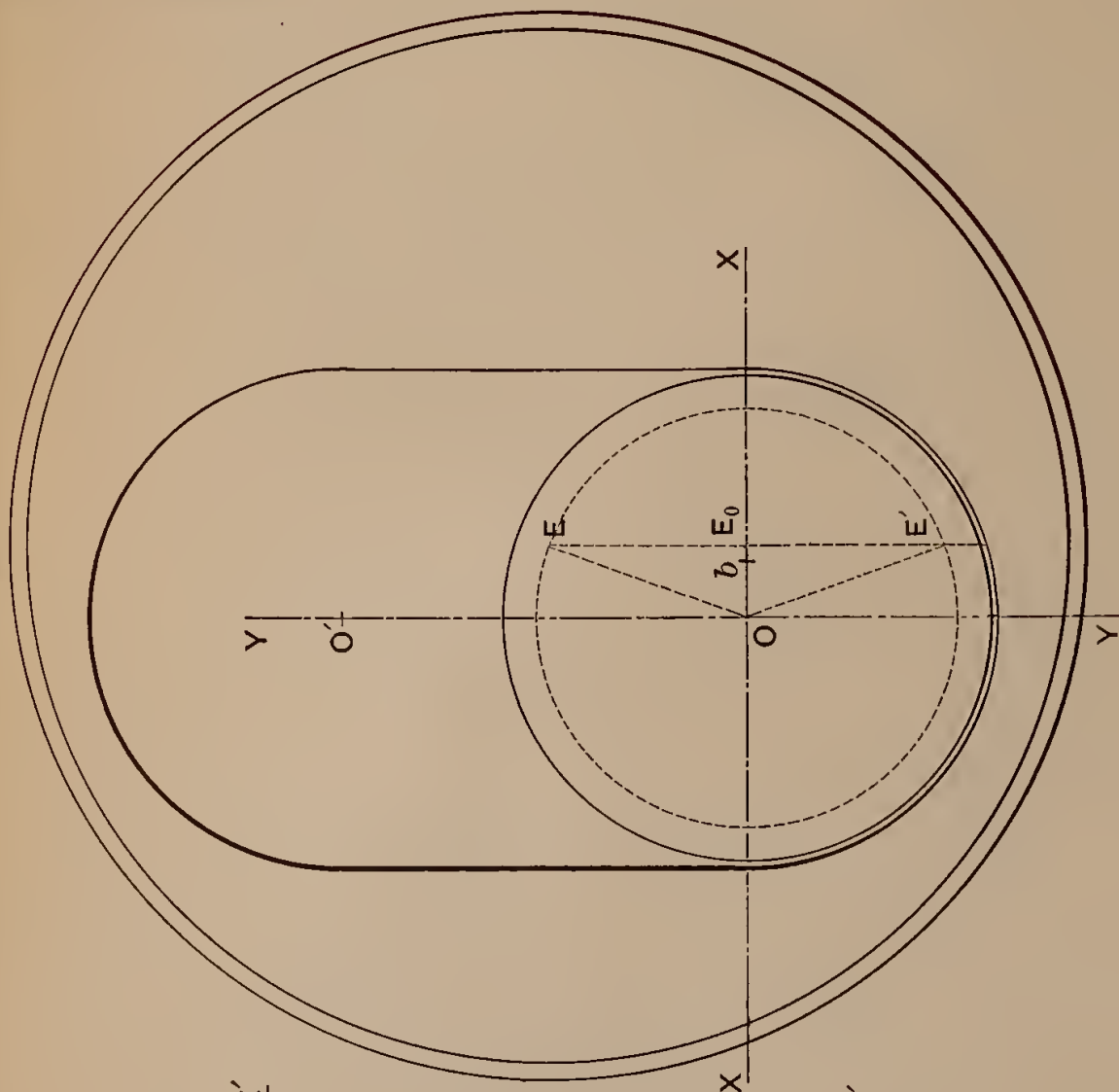

Fig. 1

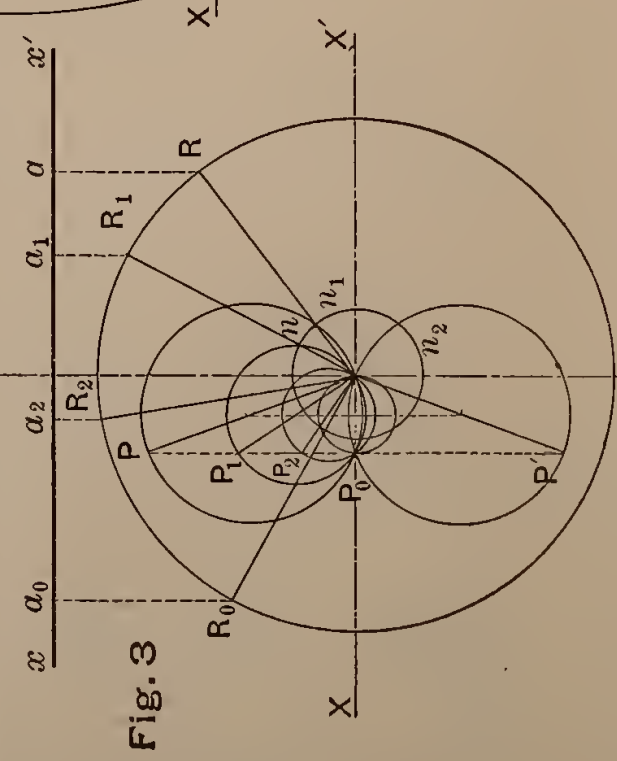
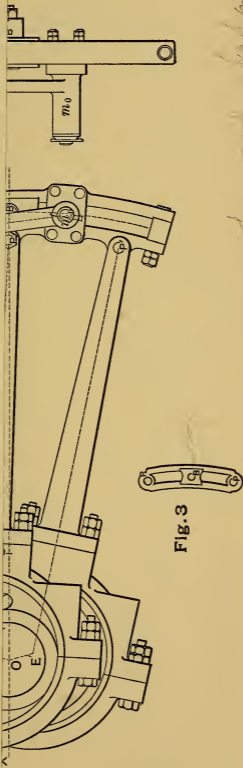
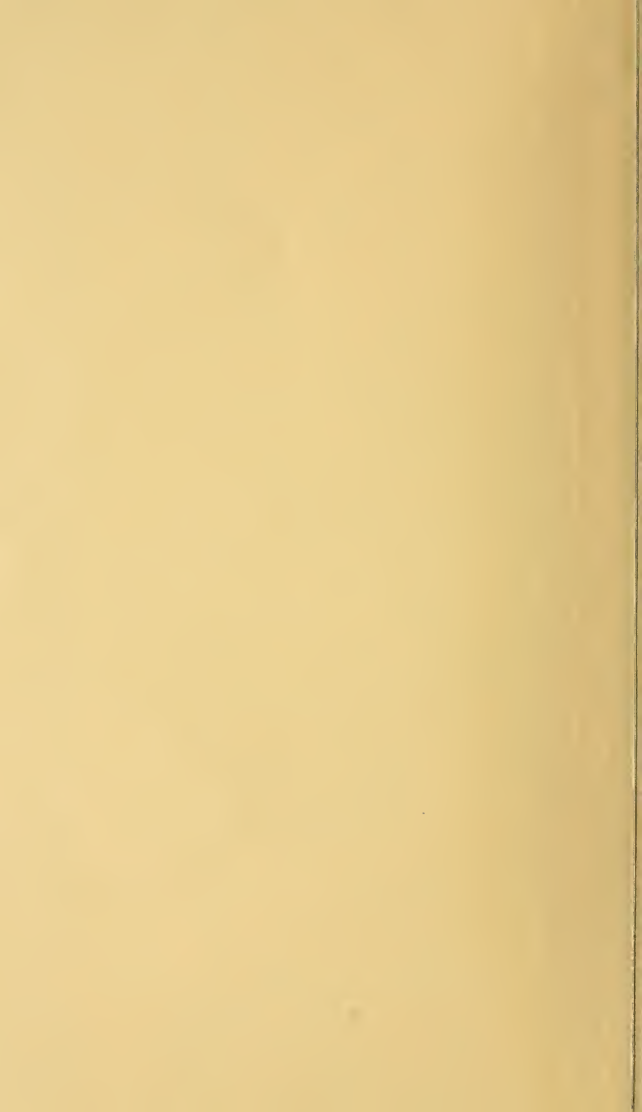

Fig. 3







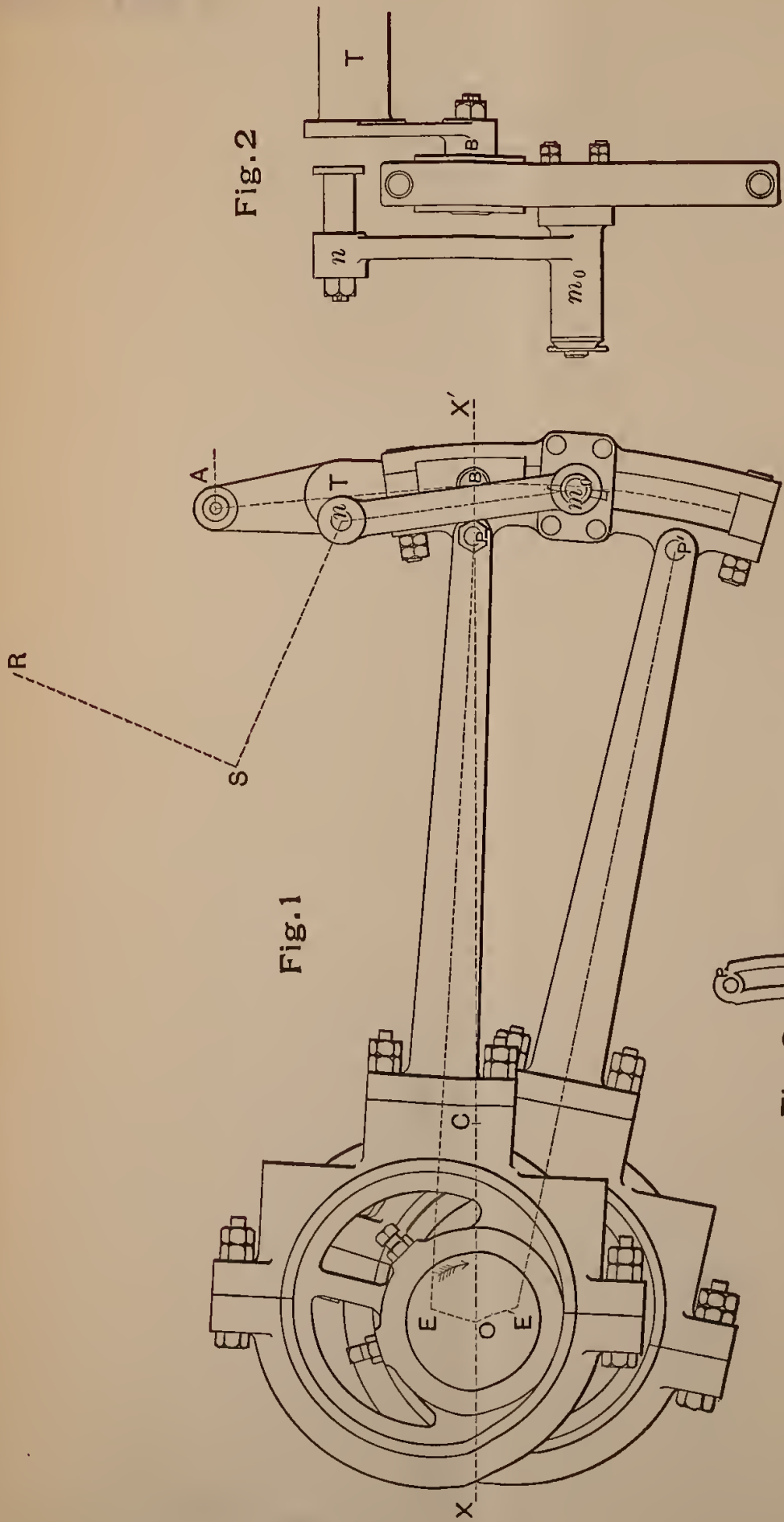

Fig. 2

Fig. 1

Fig. 3



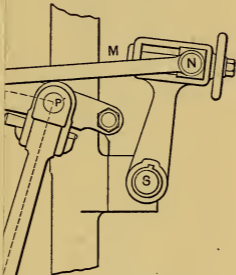
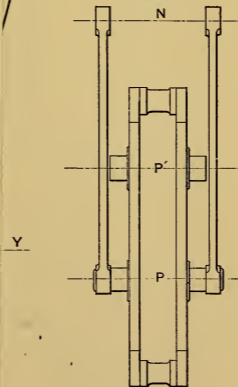

Fig. 2



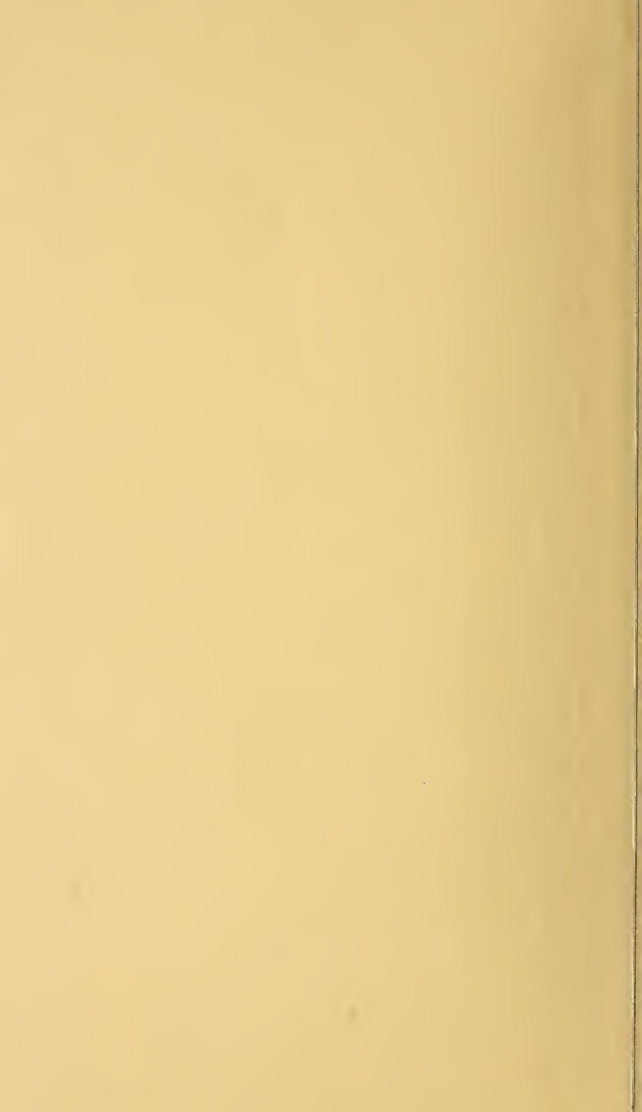
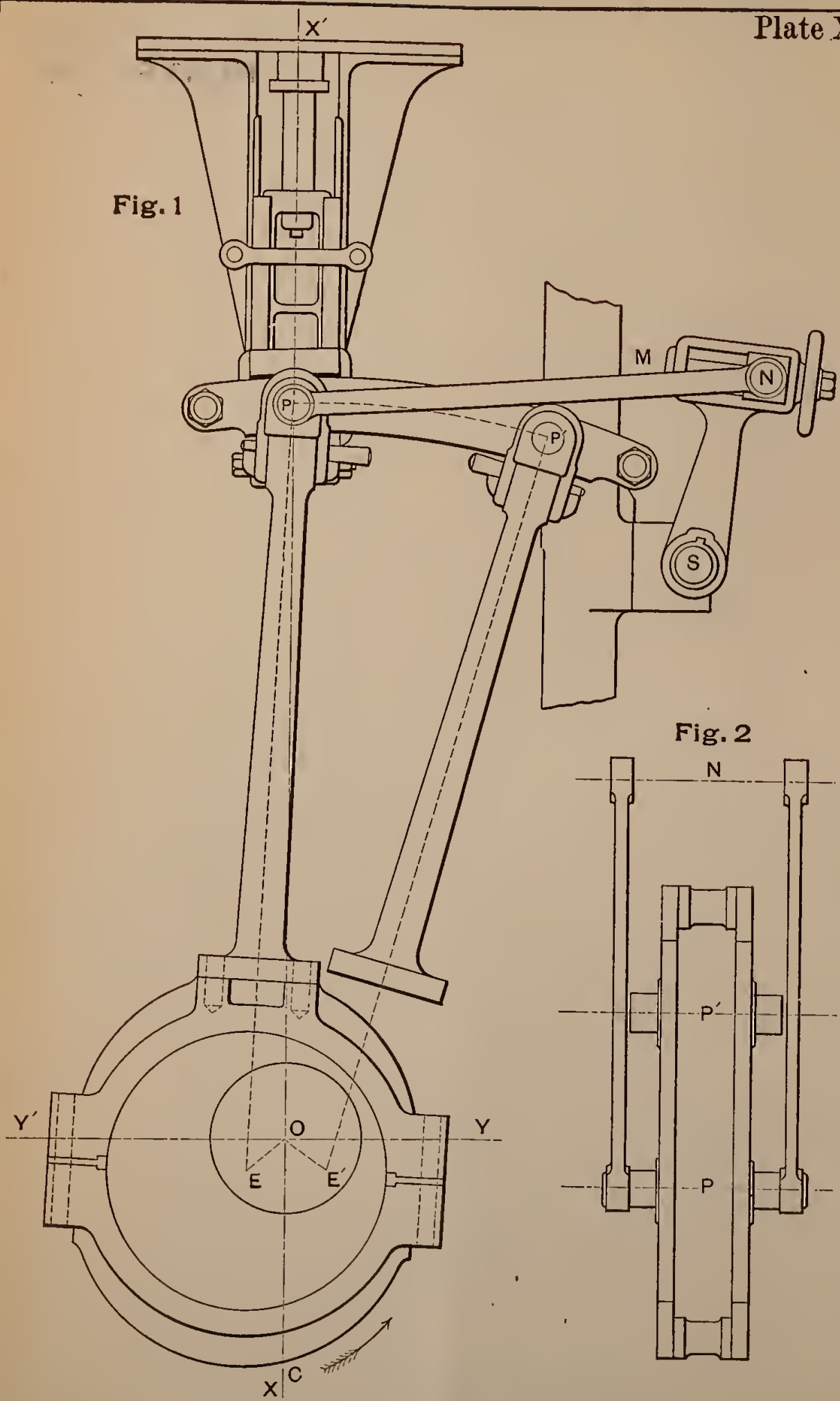

Fig. 1



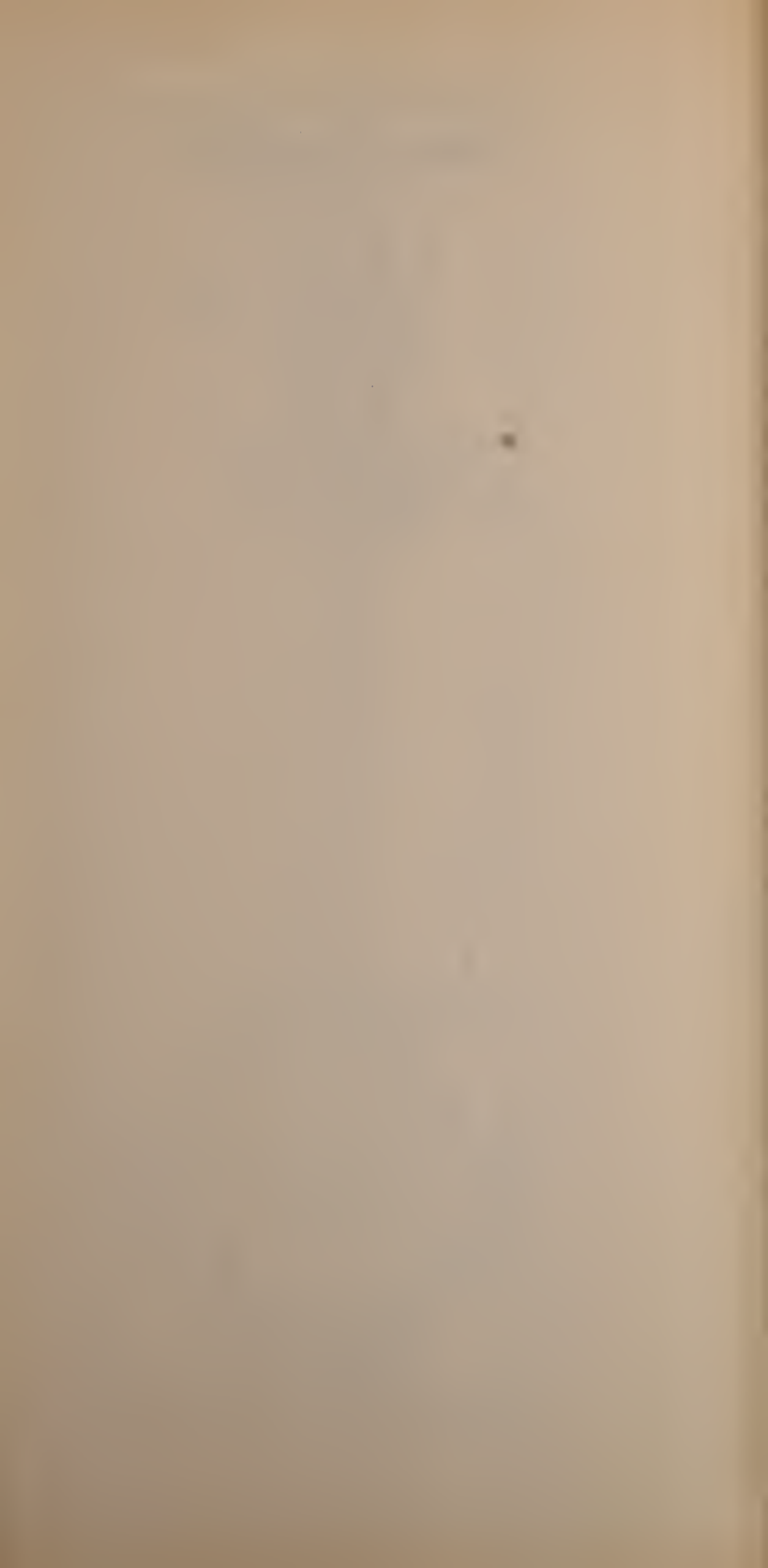
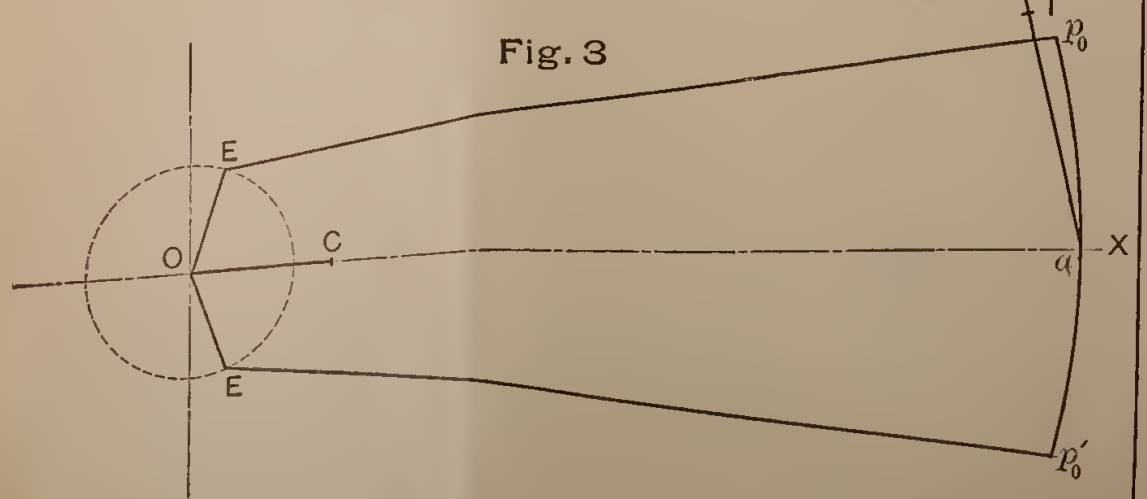
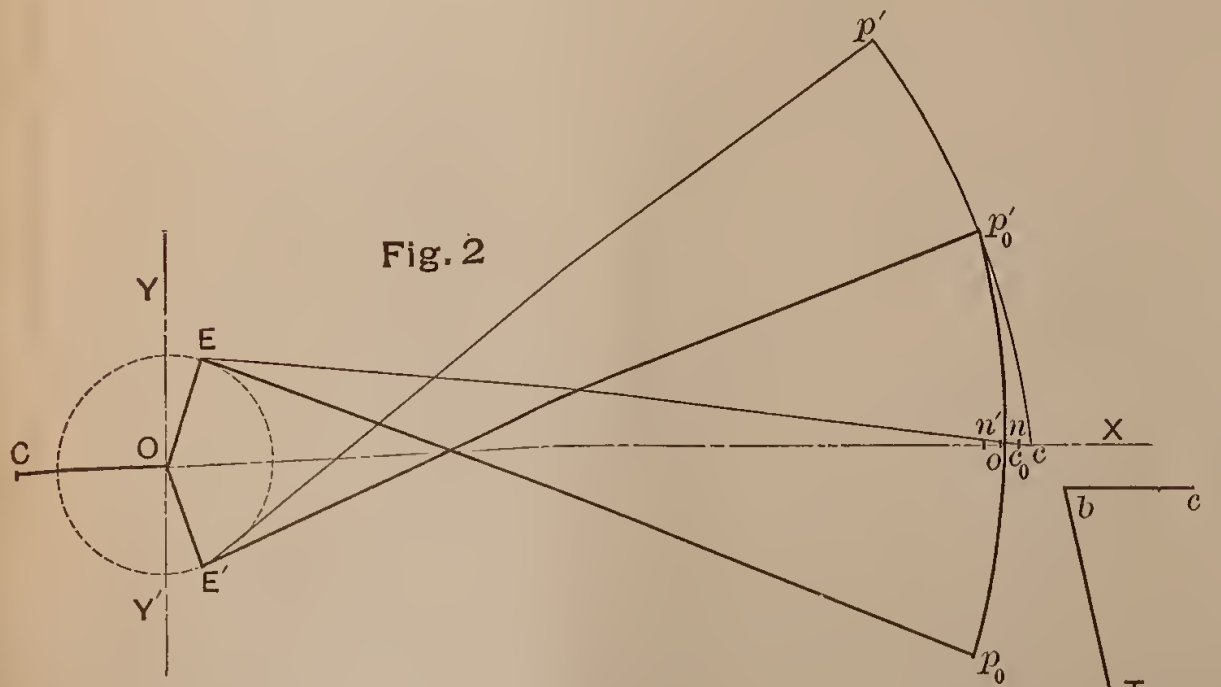
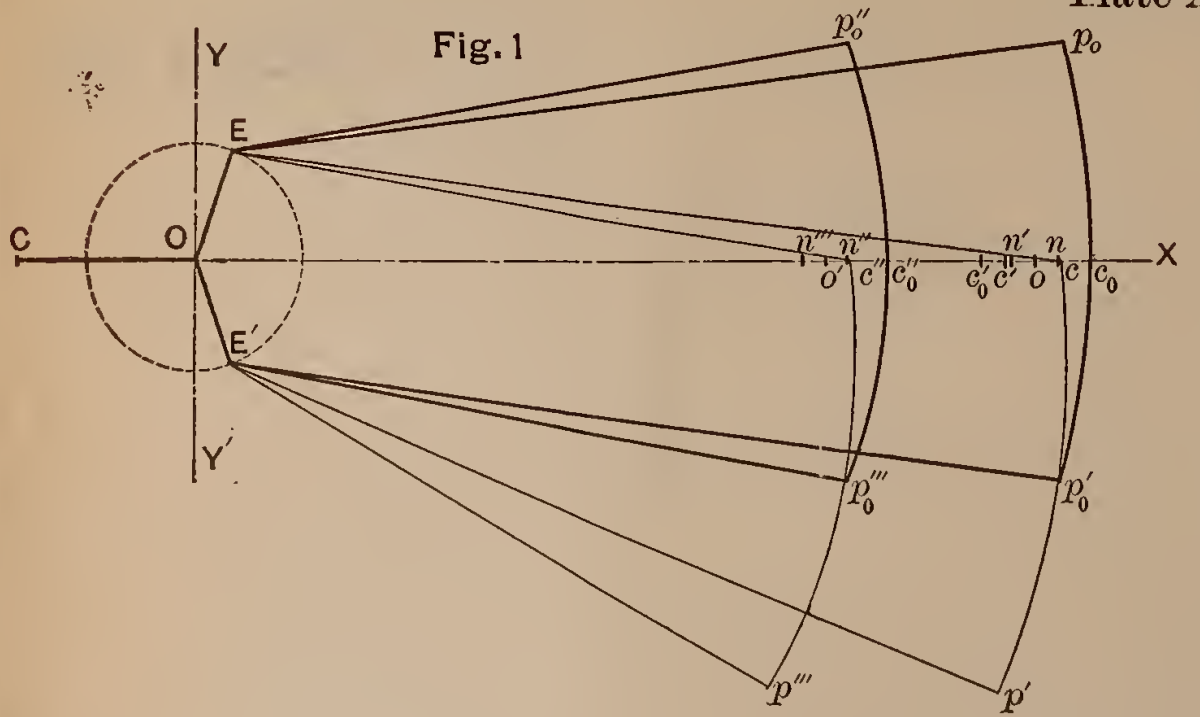
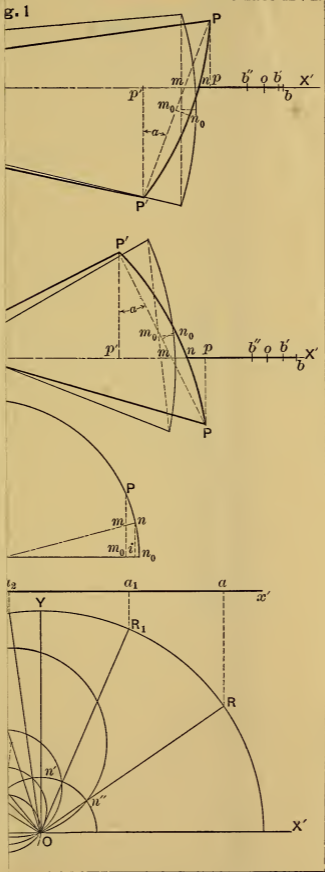

PLATE XV.









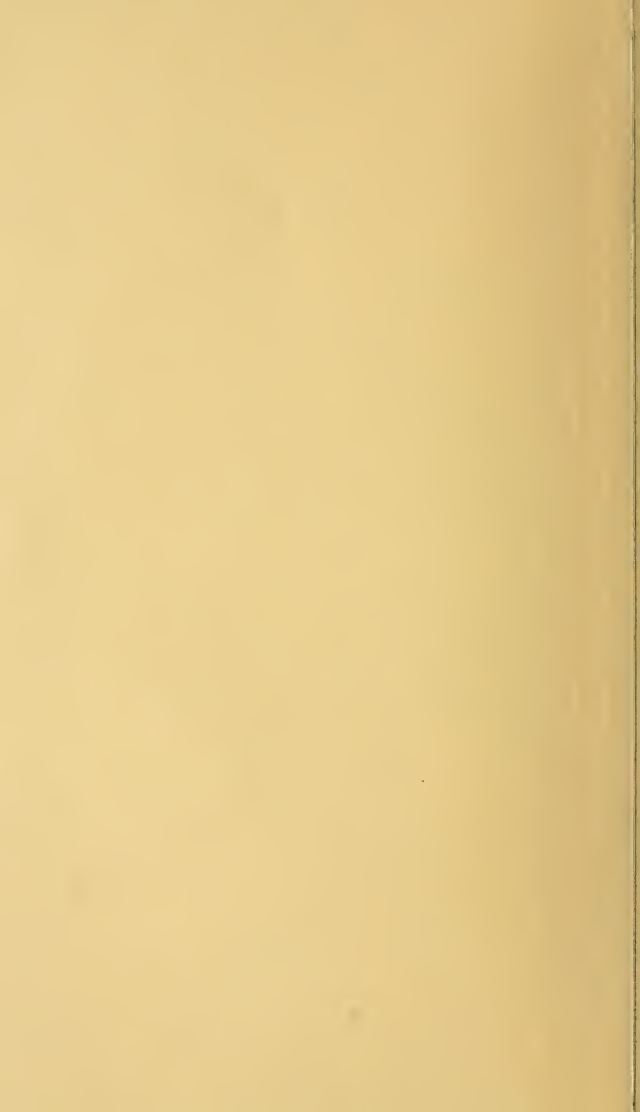

Fig. 1

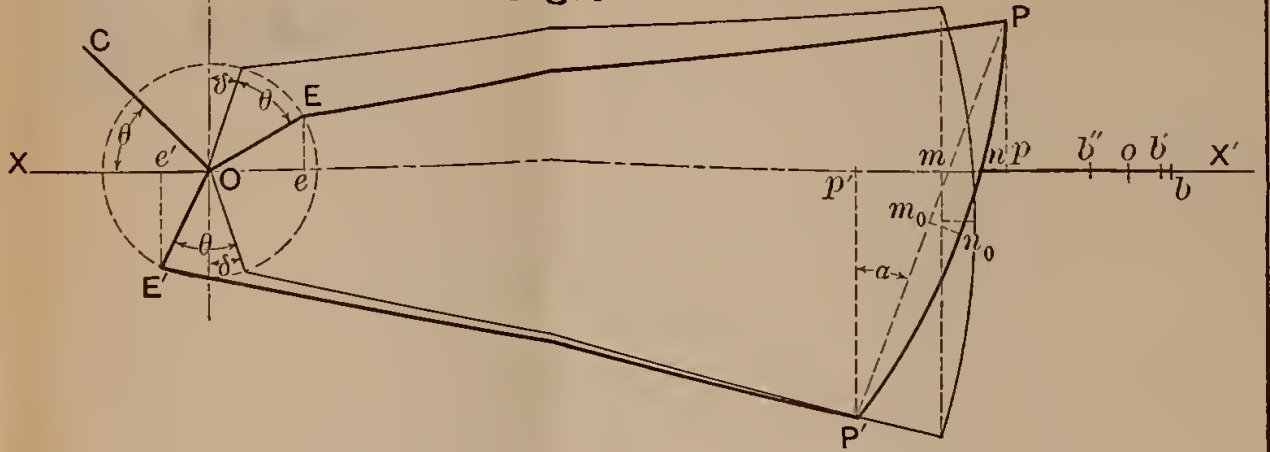

Fig. 2

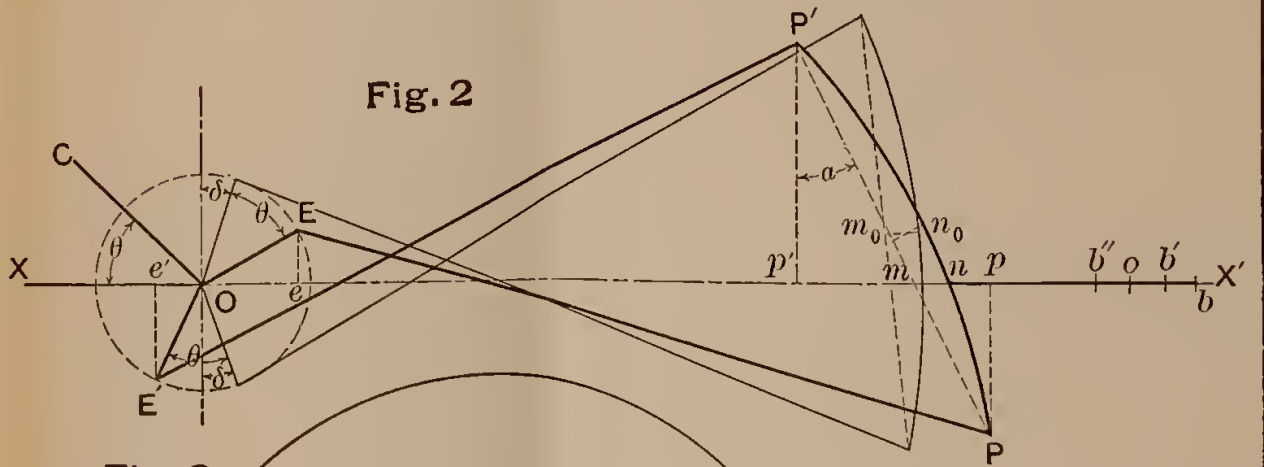

Fig. 3

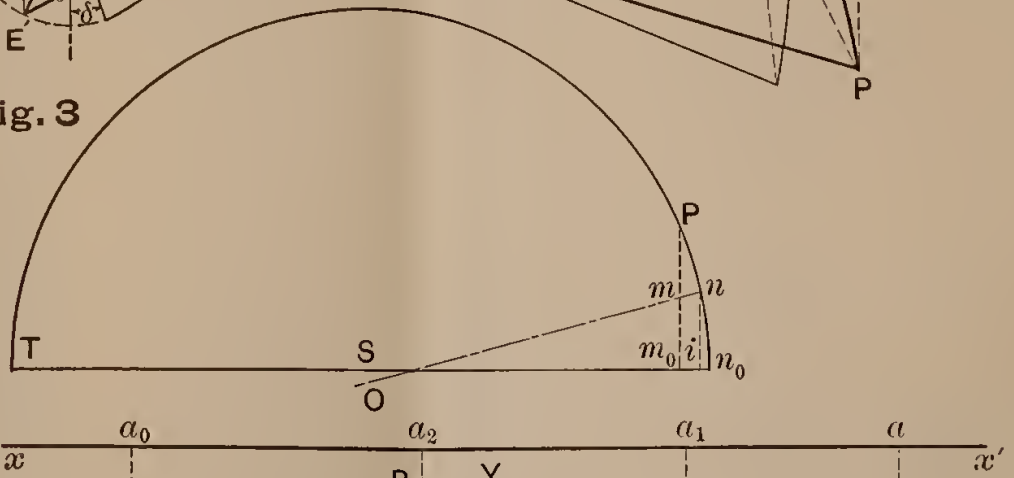
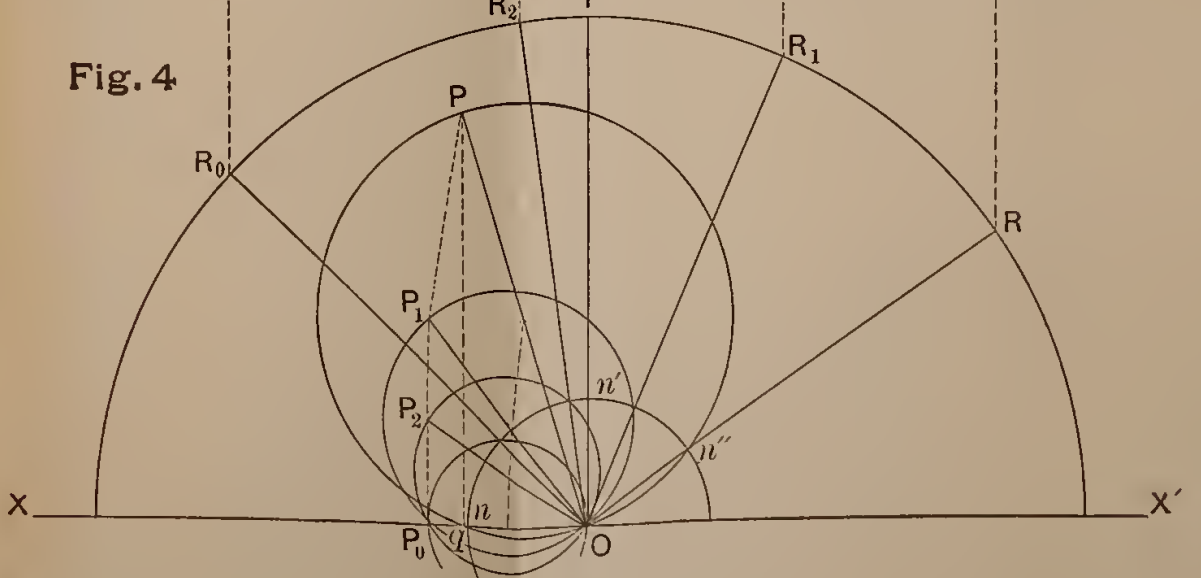
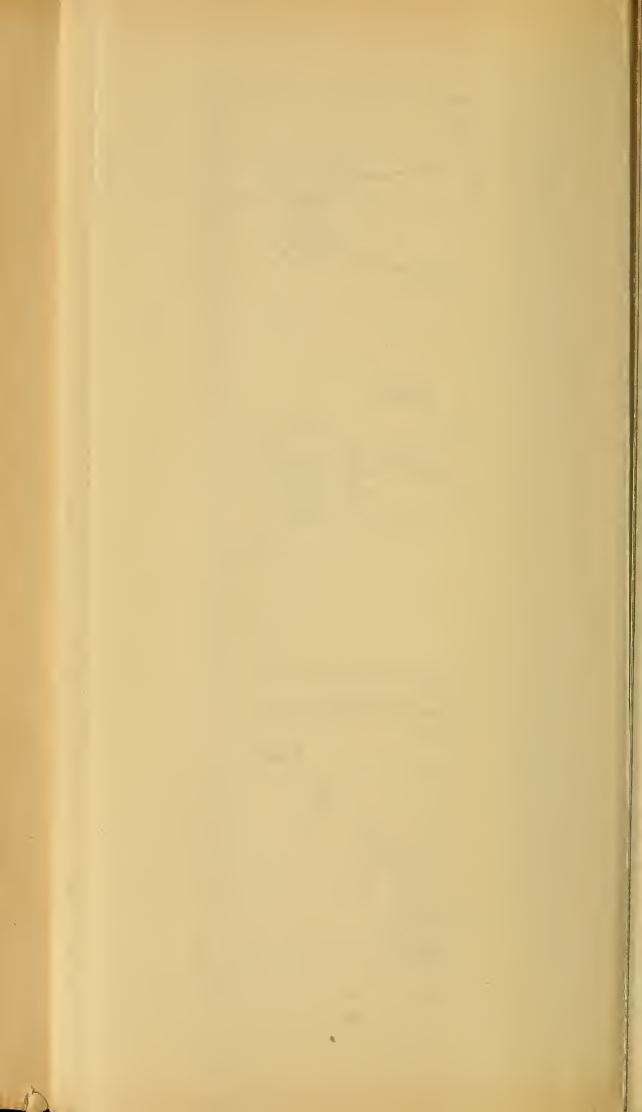
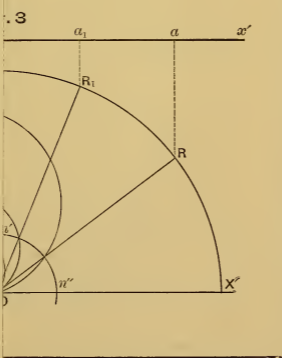
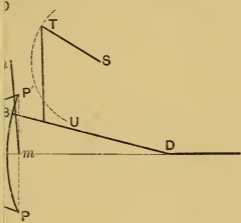
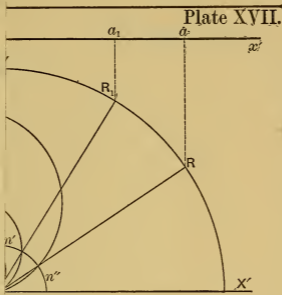

Fig. 4







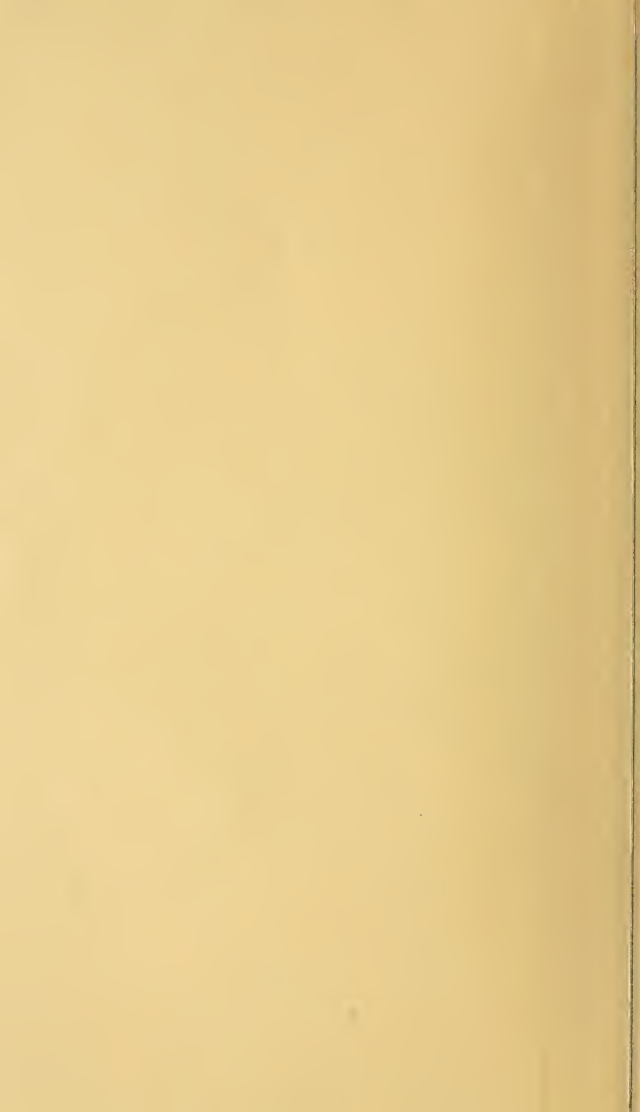

Fig. 1

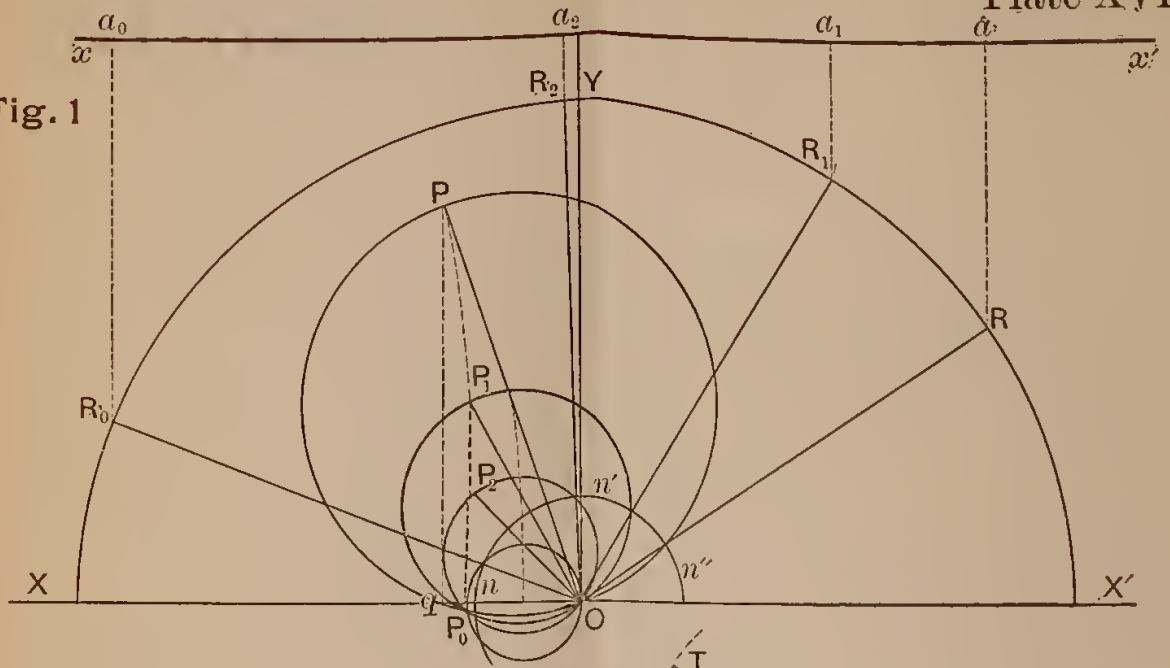

Fig. 2

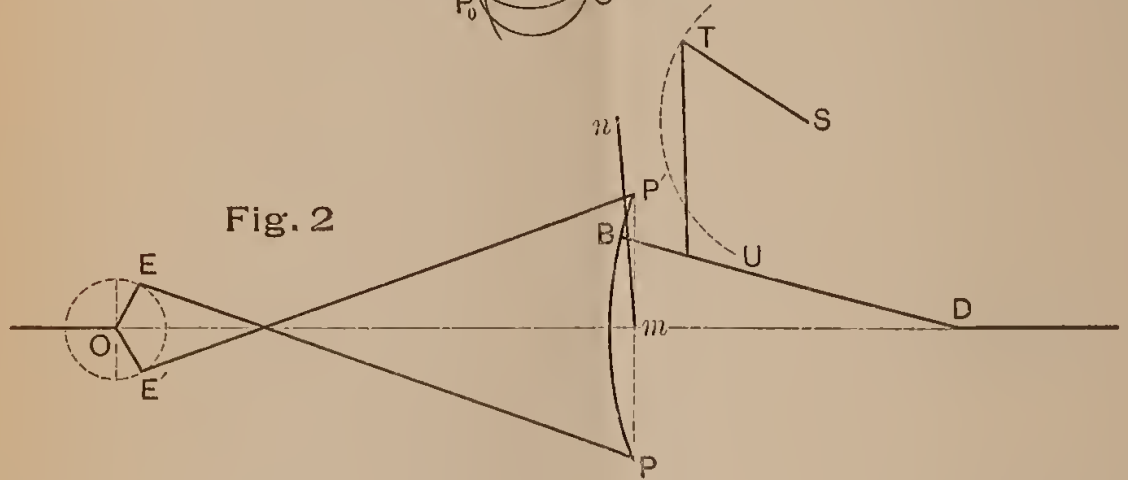
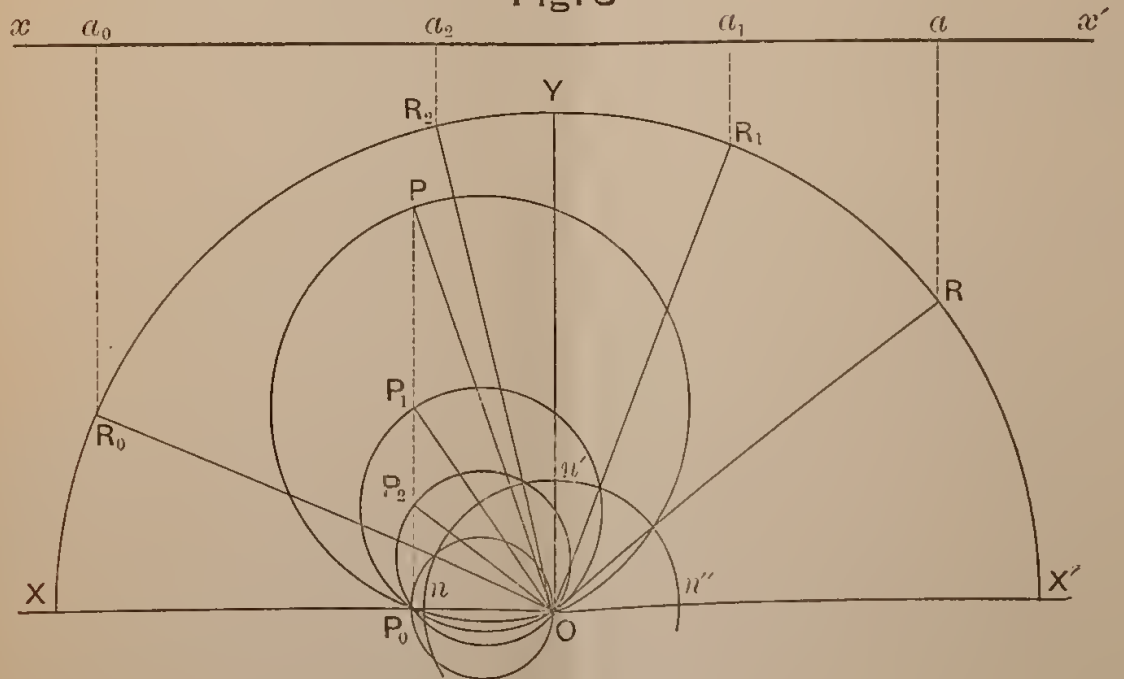
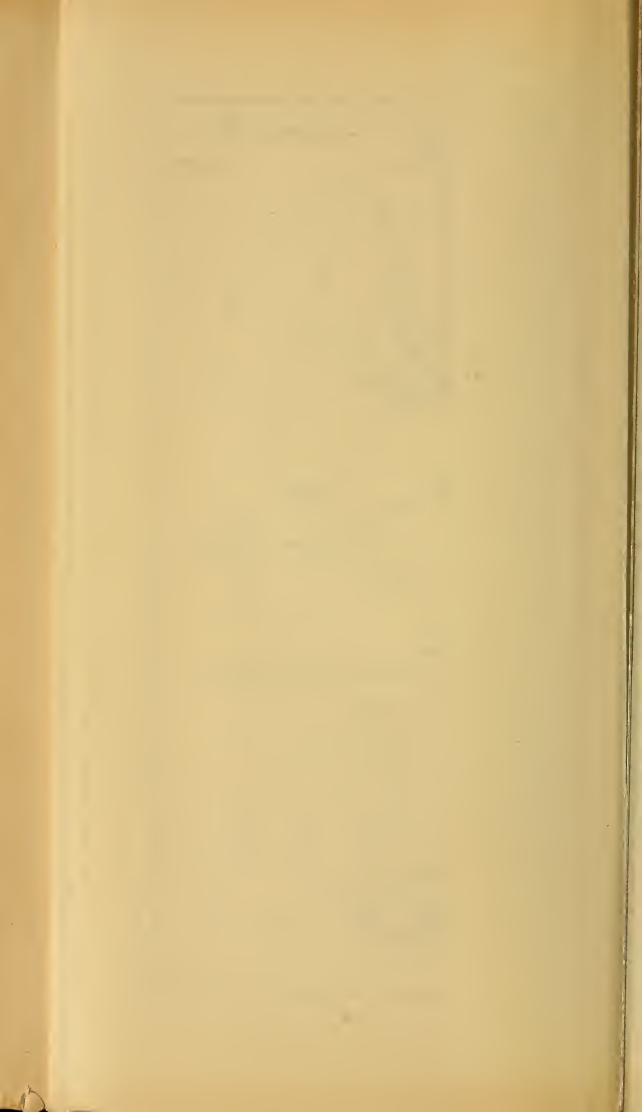
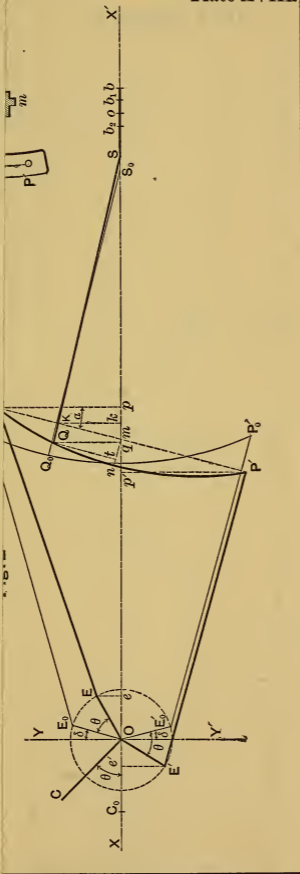

Fig. 3









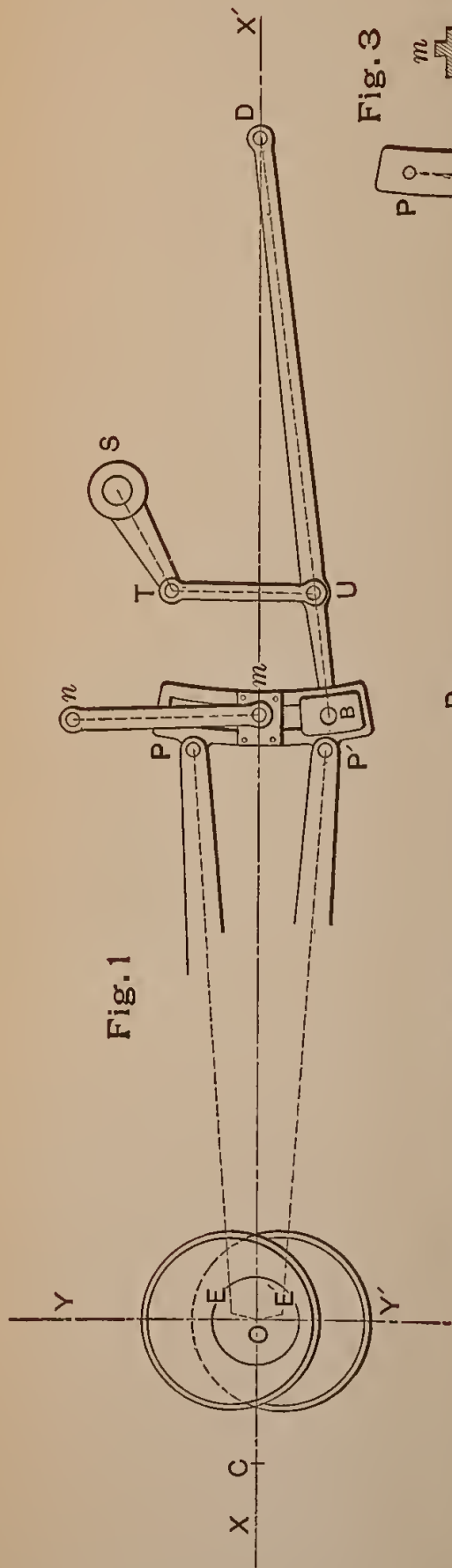

Fig. 1

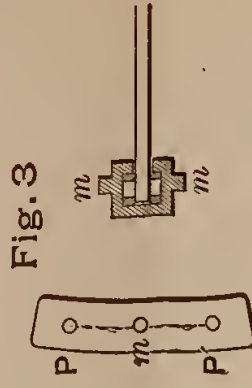

Fig. 3

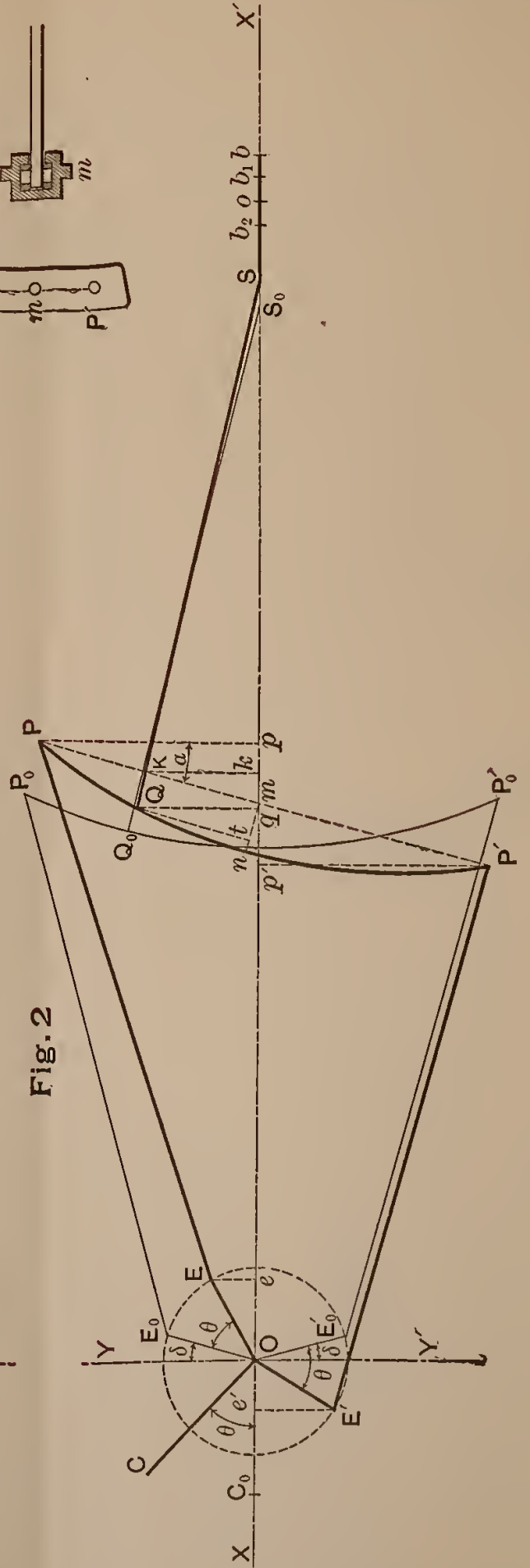
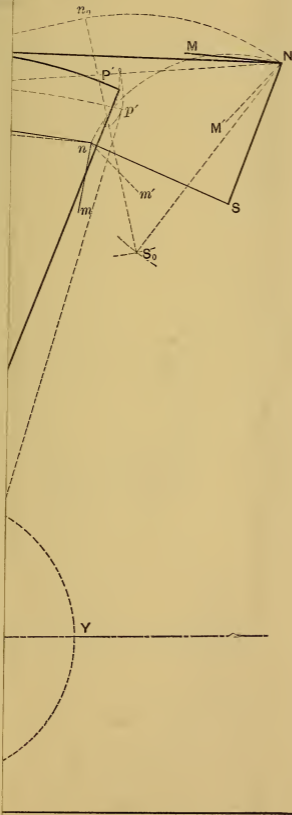
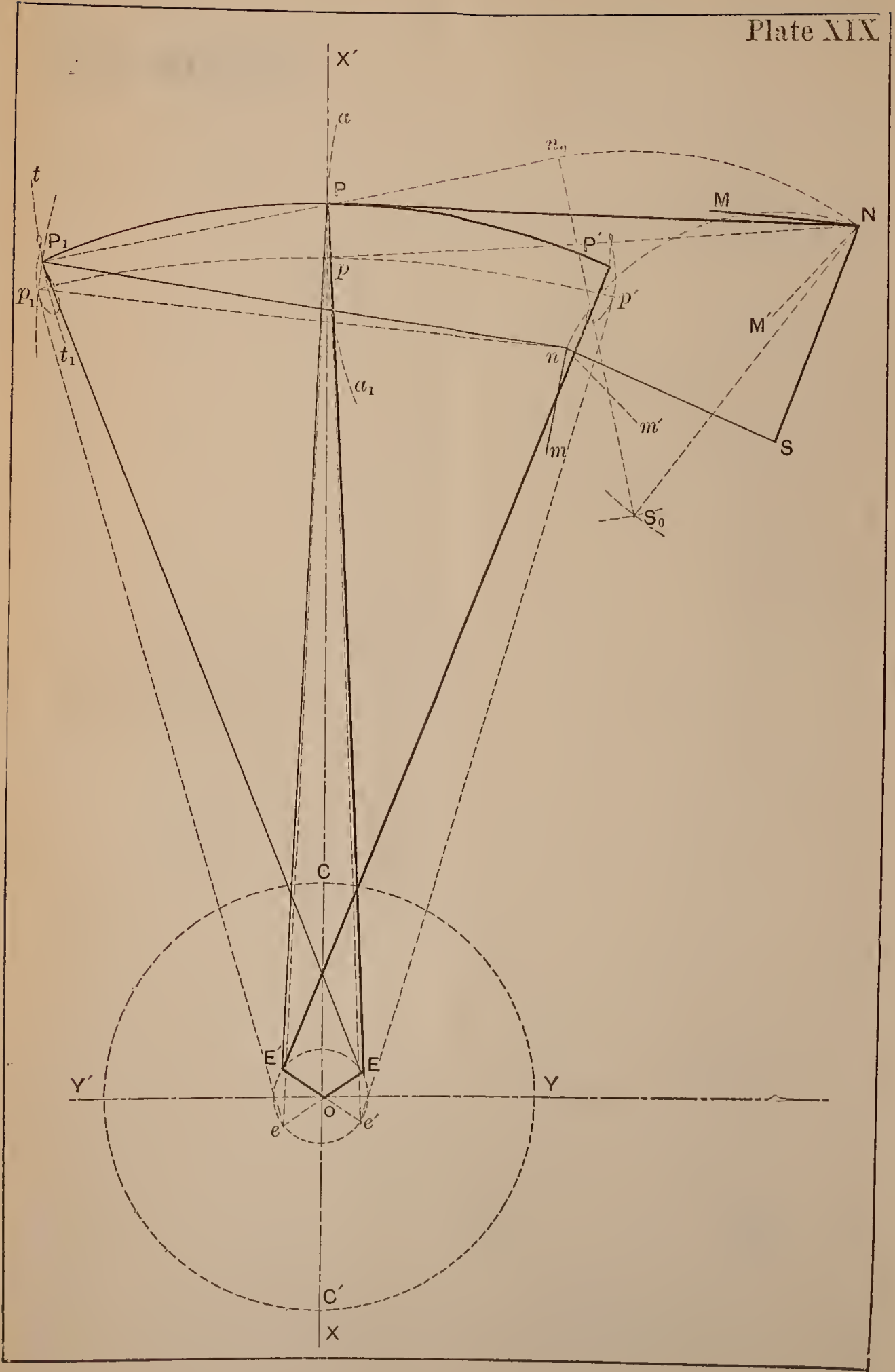

Fig. 2











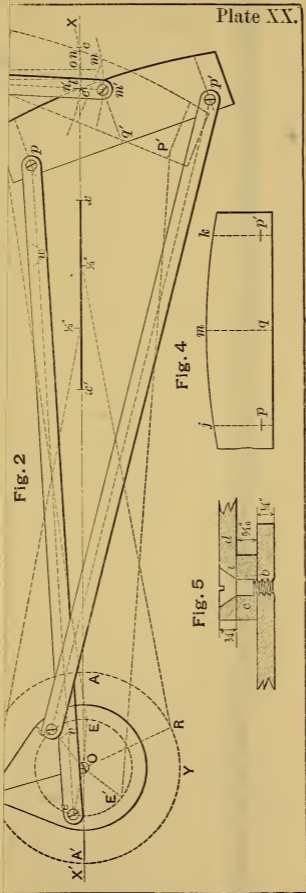

Fig. 2

Fig. 4

Fig. 5



Fig. 1

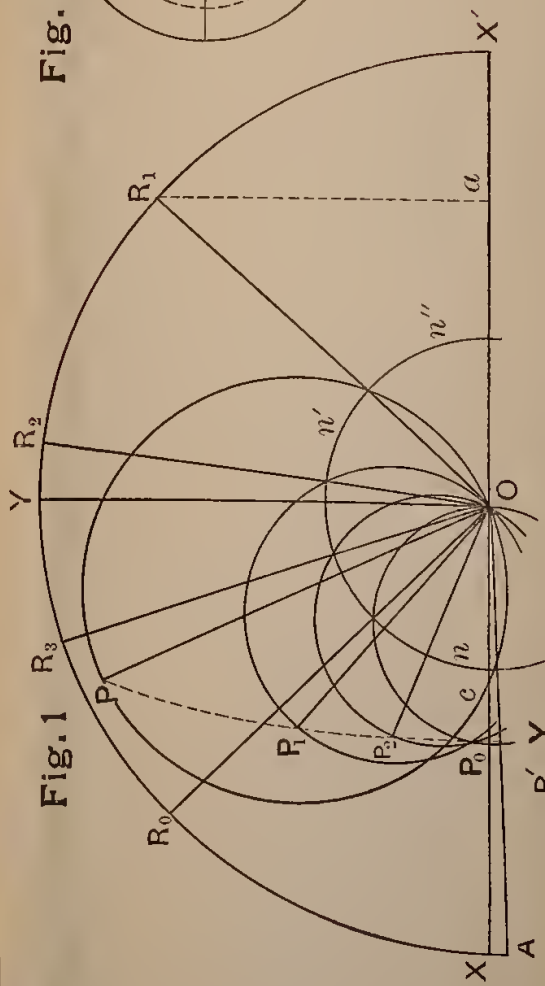

Fig. 3



Fig. 2

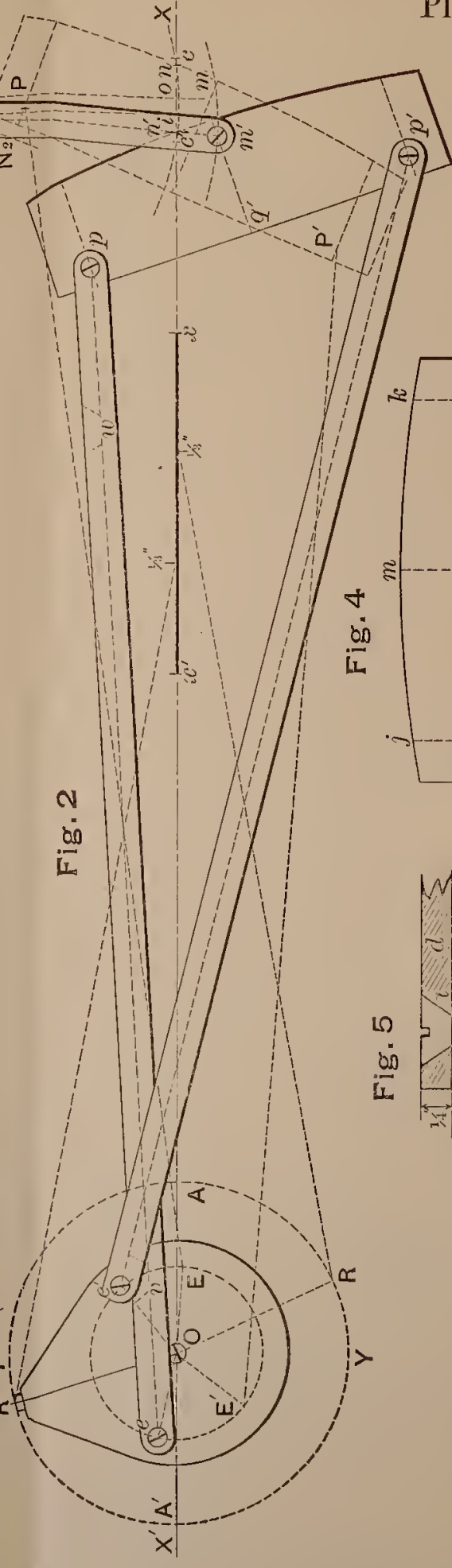

Fig. 4

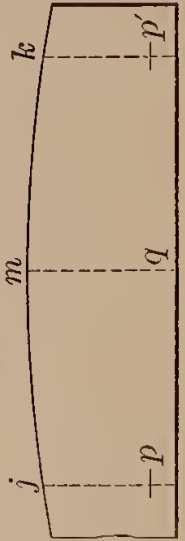
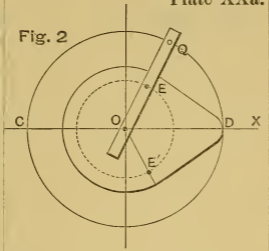

Fig. 5



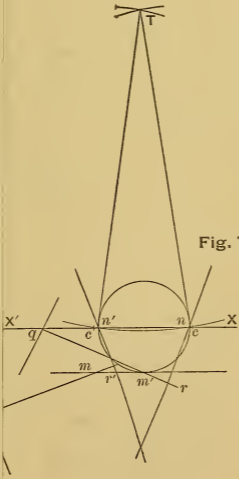

Fig. 2



X

Fig. 7



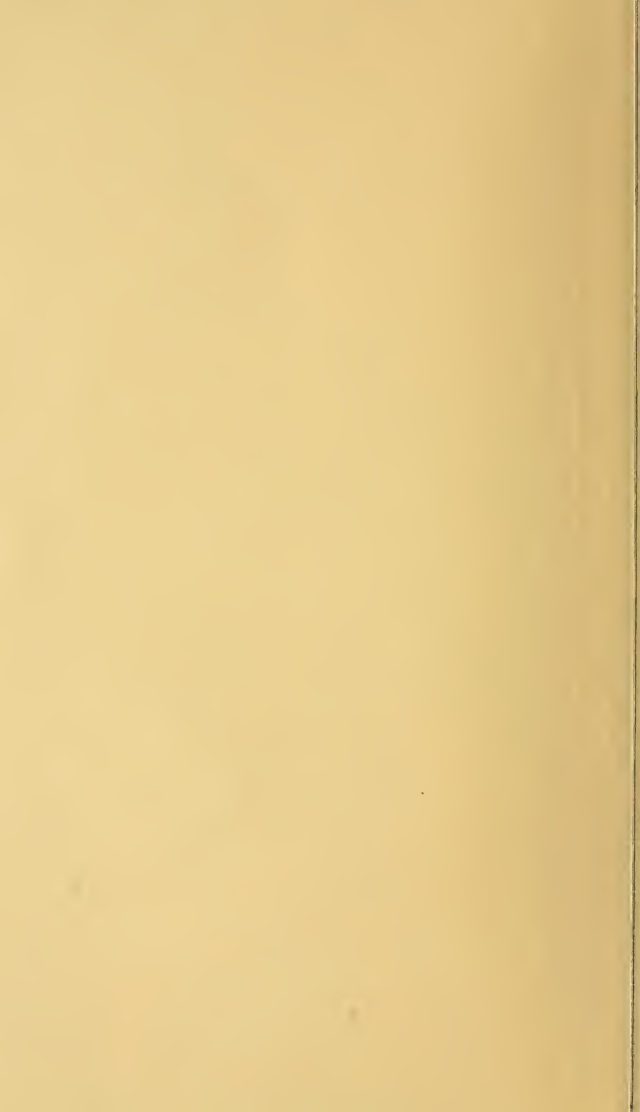

Fig. 1

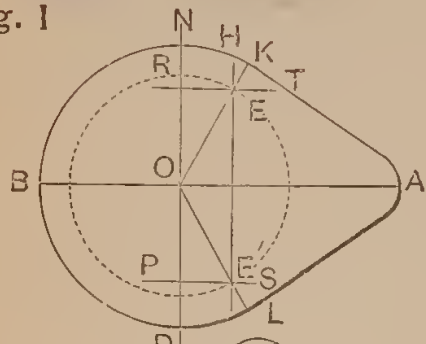

Fig. 2

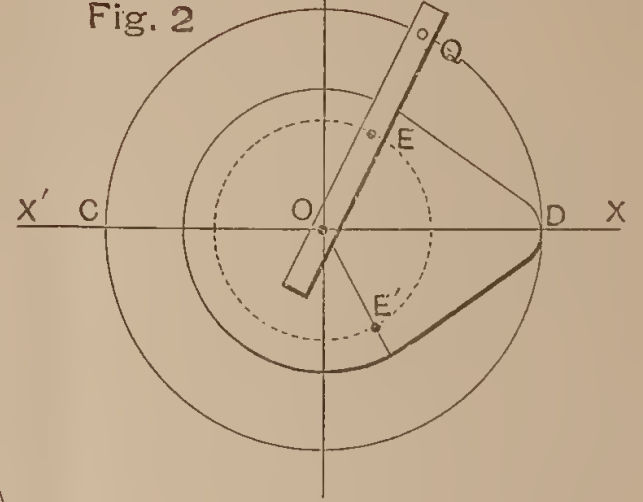

Fig. 3

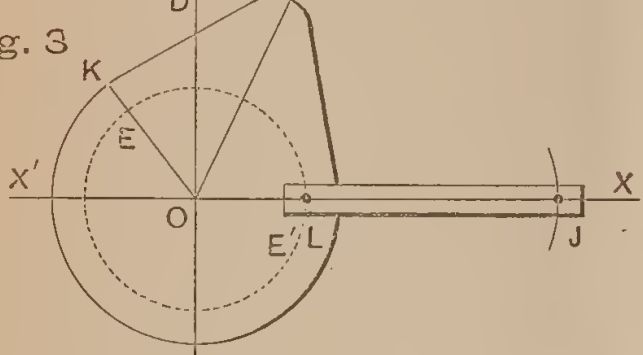

Fig. 4

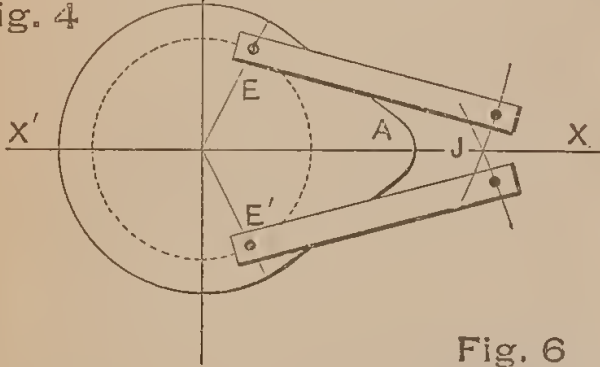

Fig. 6

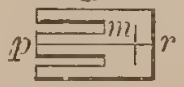

Fig. 5

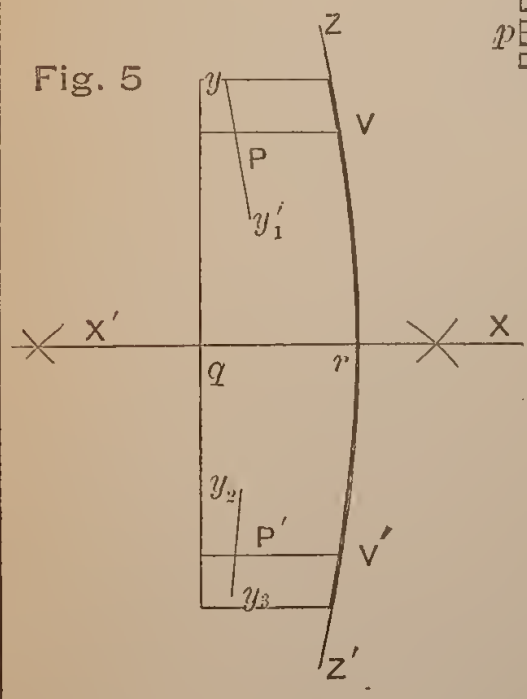
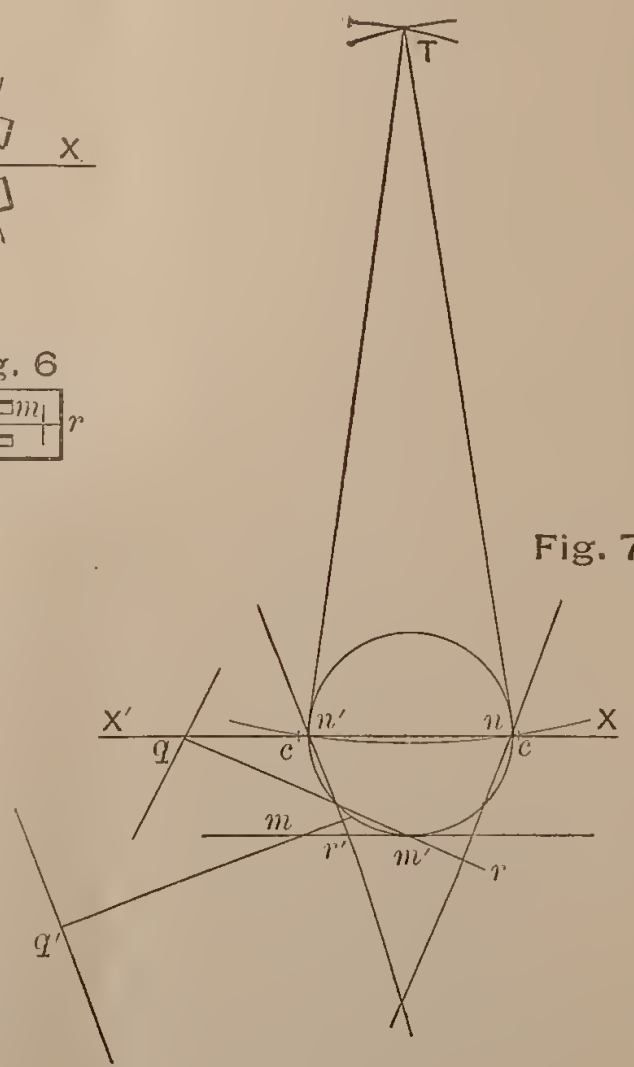
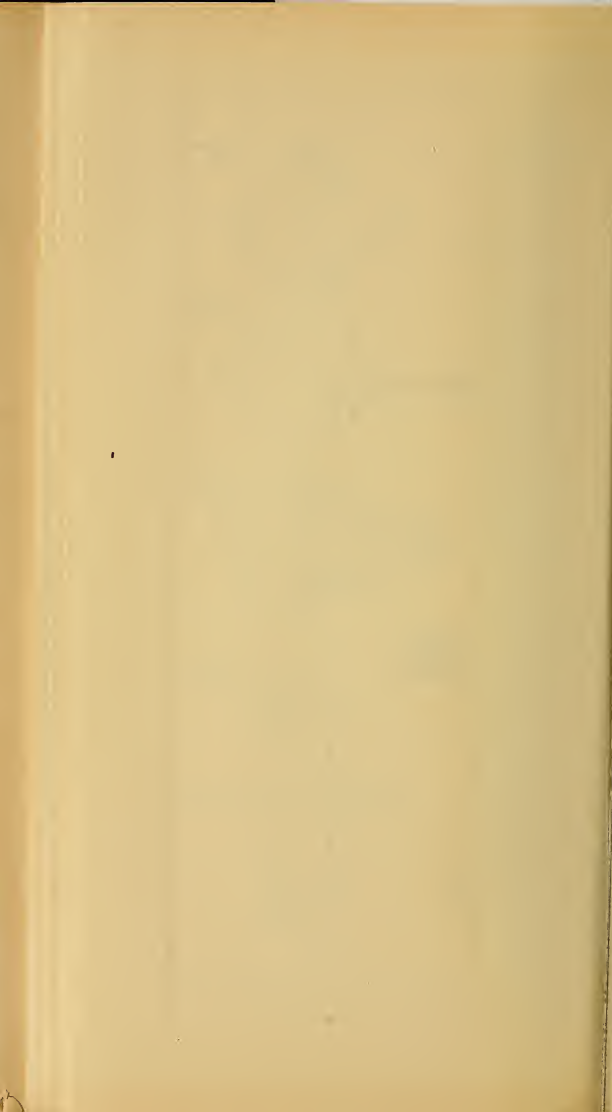
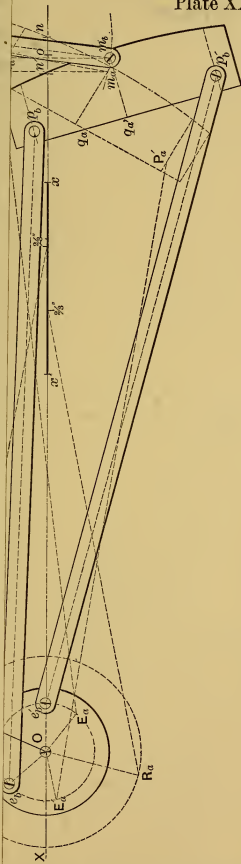

Fig. 7







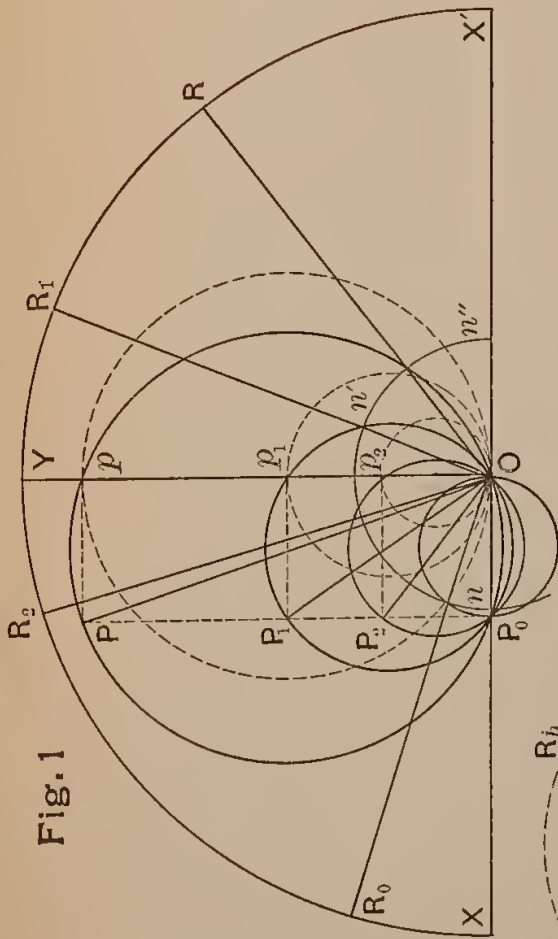

Fig. 1

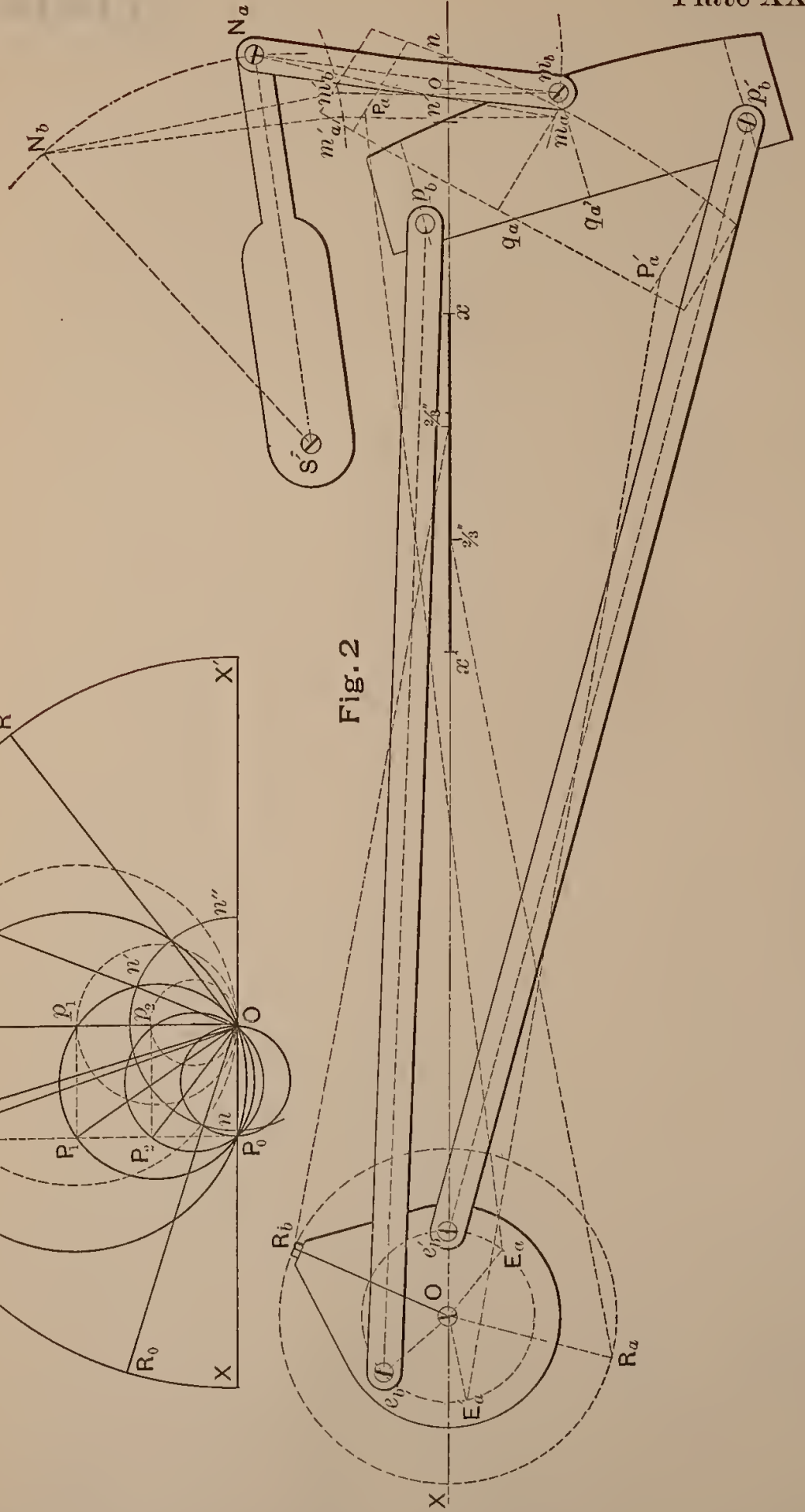

Fig. 2



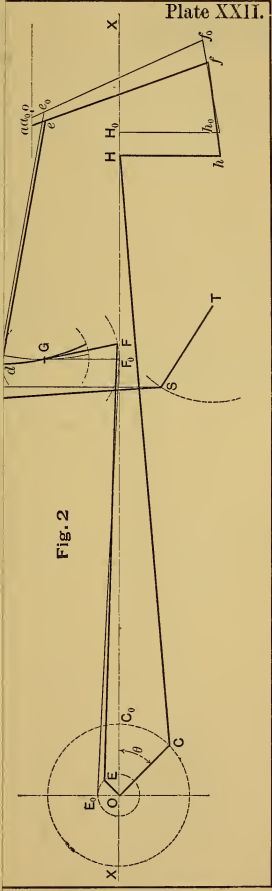

Fig. 2

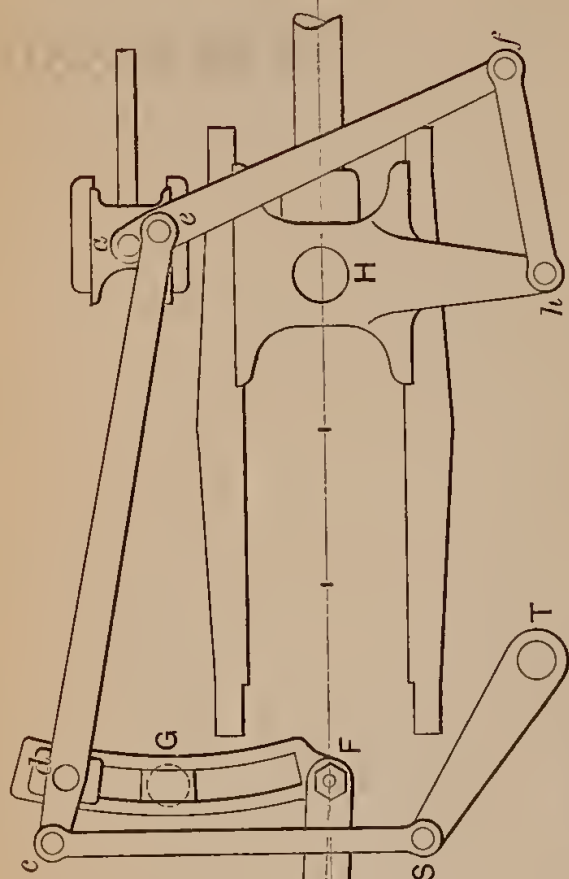

Fig. 1

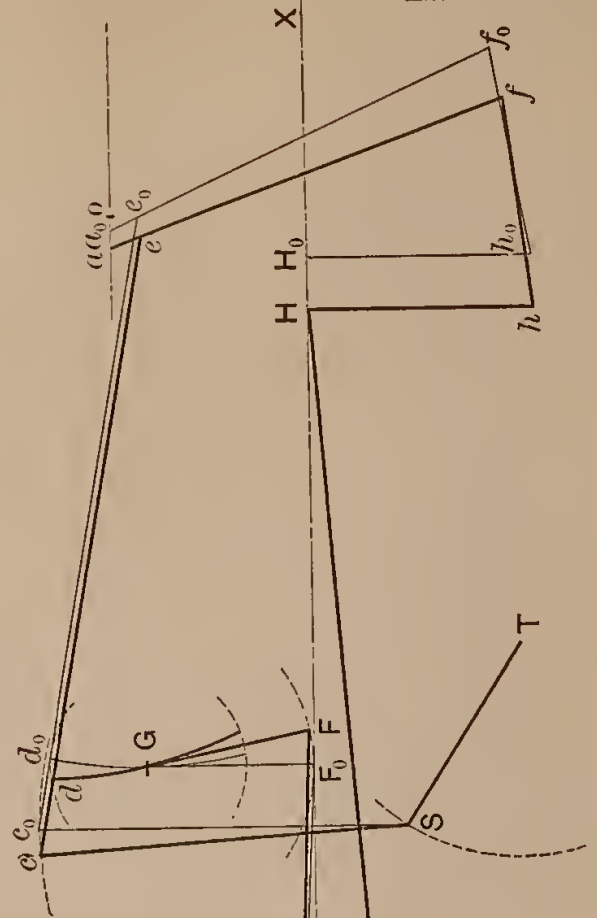
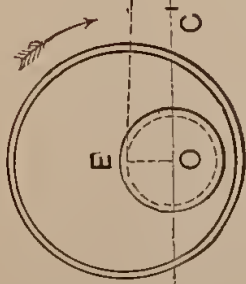
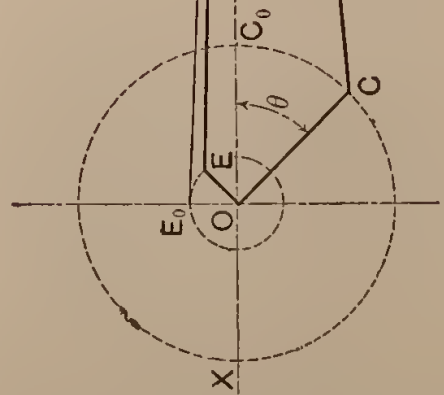

Fig. 2



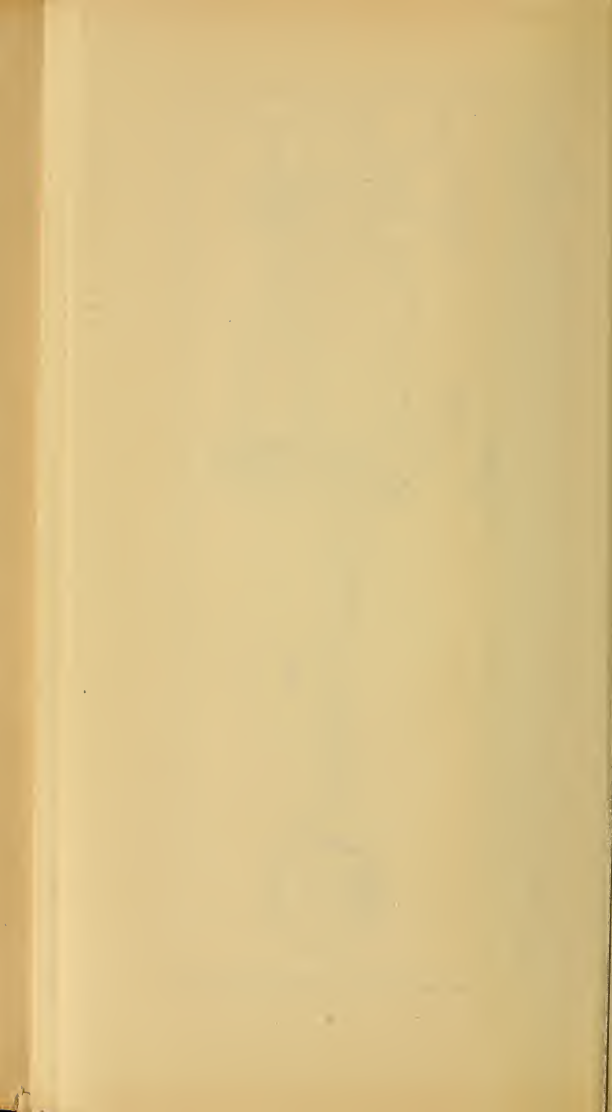

Plate XXIII.

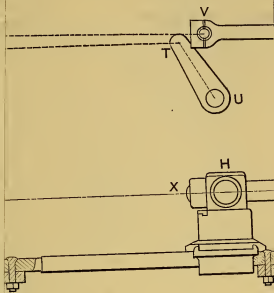

Fig. 3

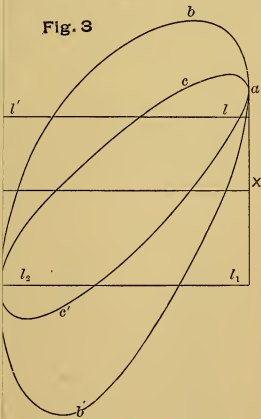

Fig. 1

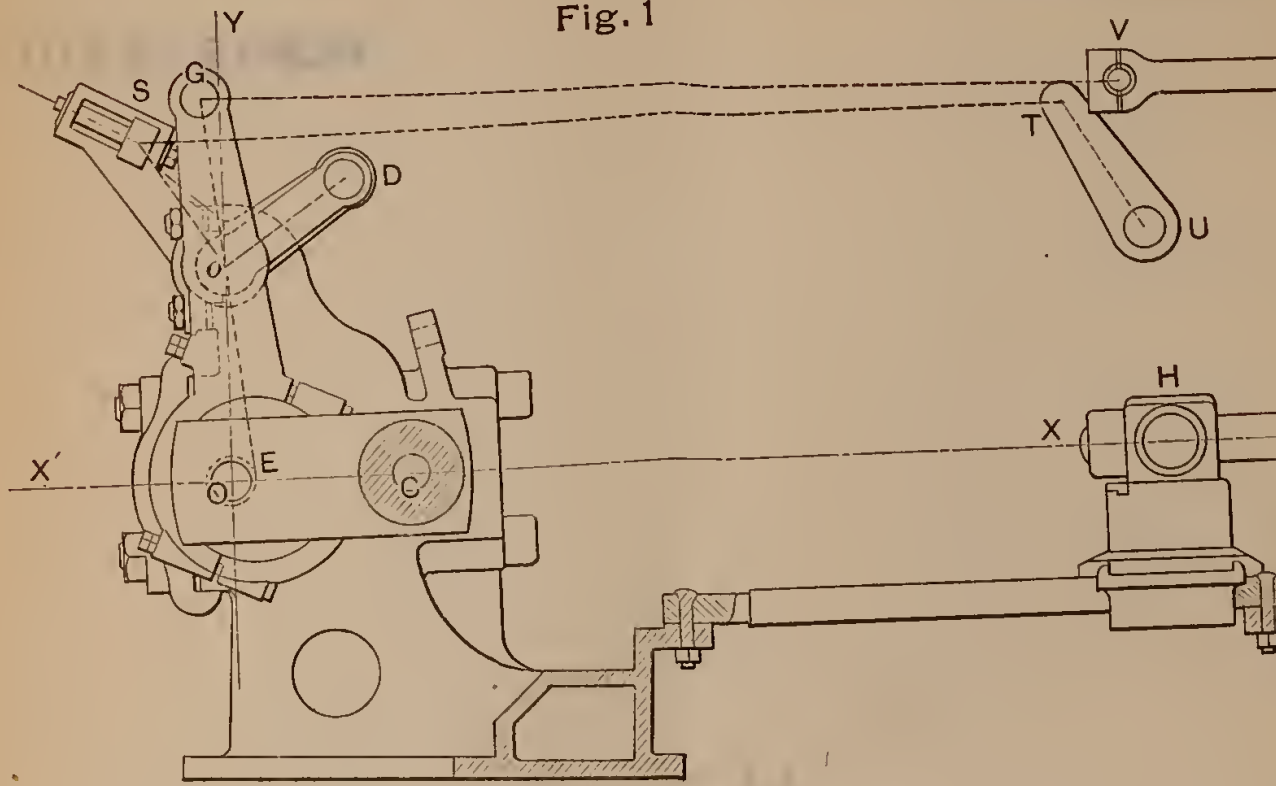

Fig. 2

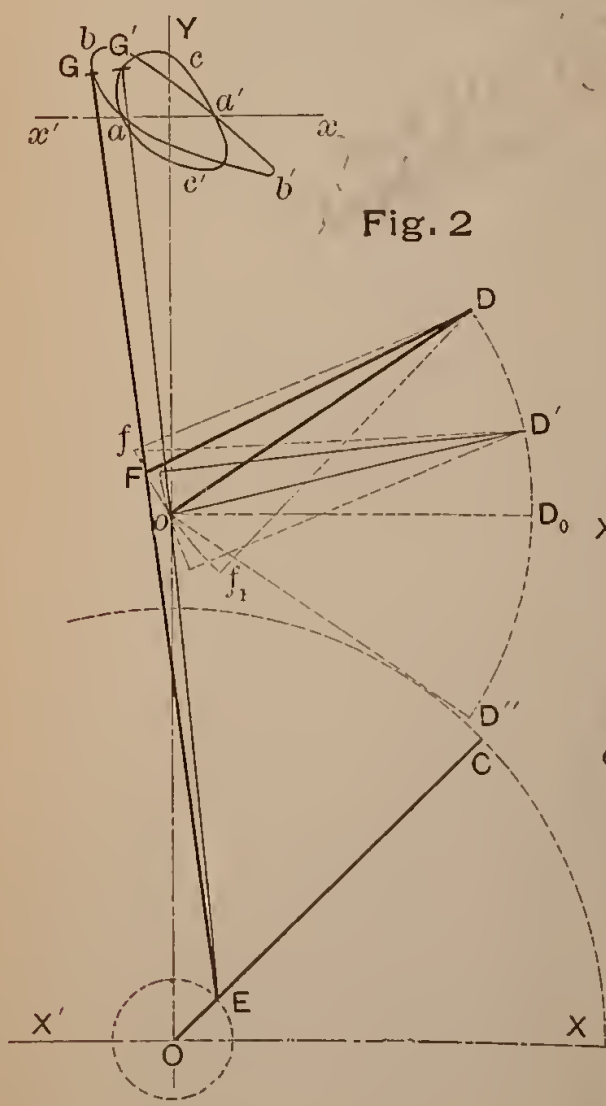
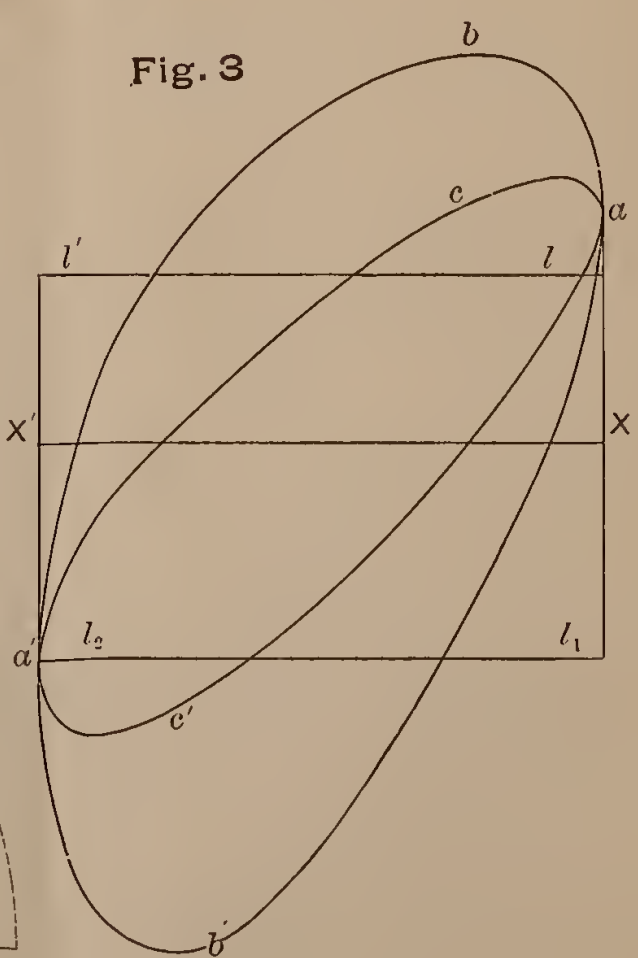

Fig. 3



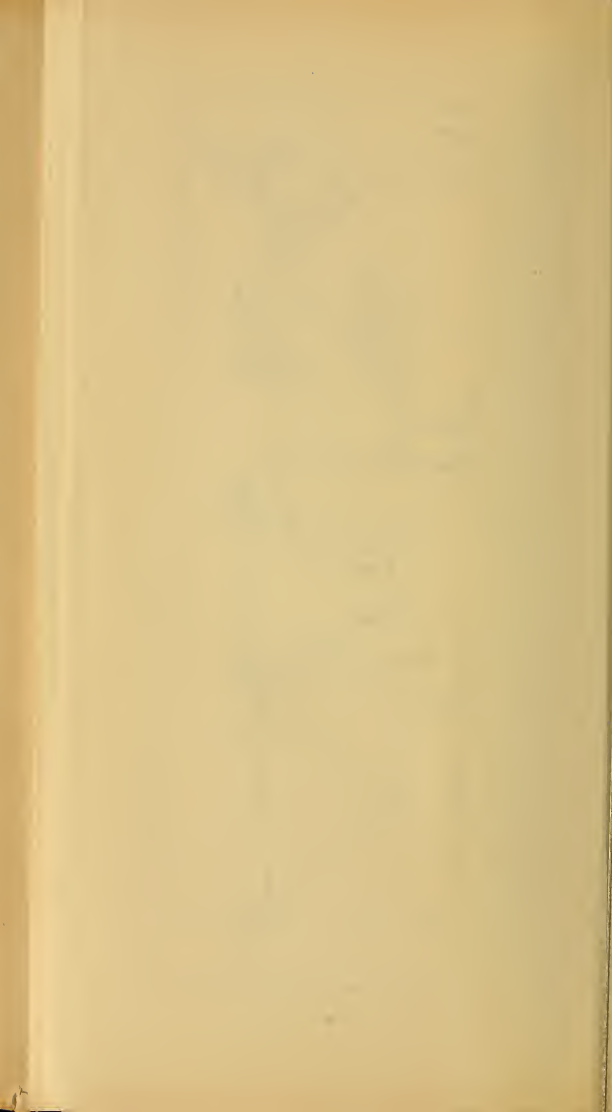
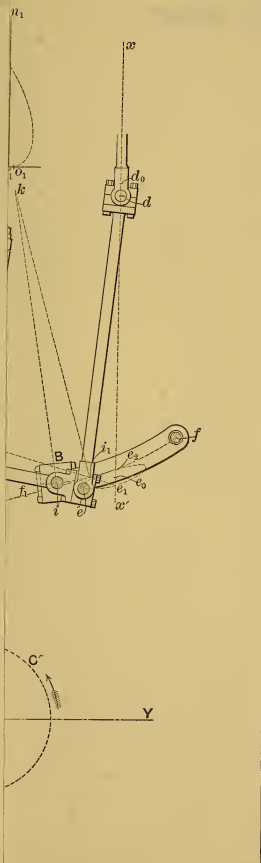

Plate XXIV.



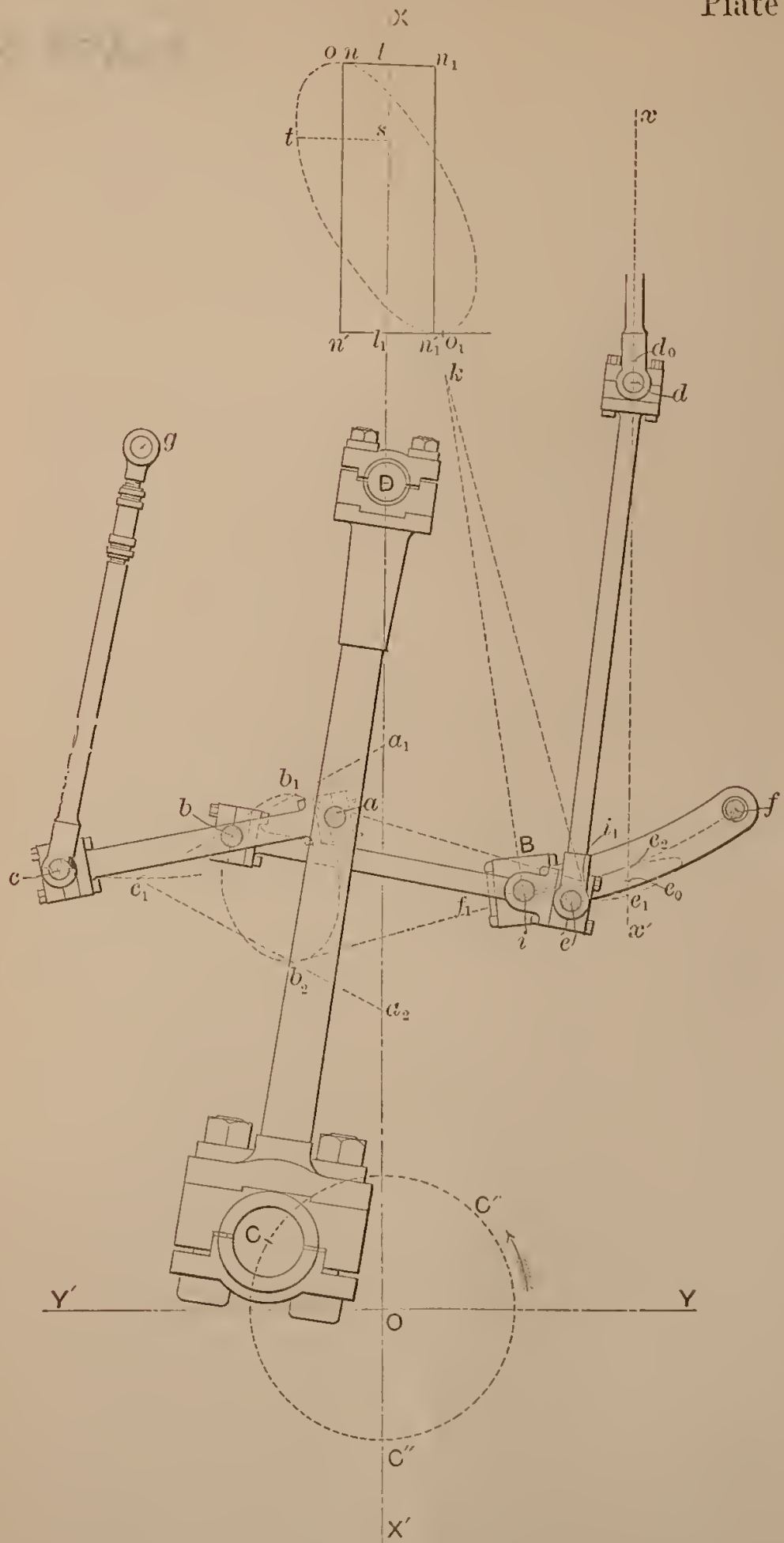



Plate XXV.

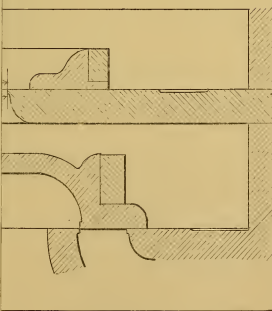
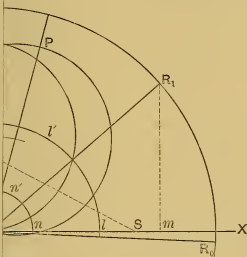
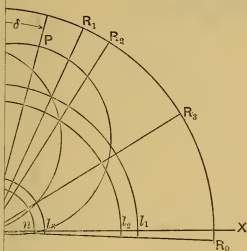

Fig. 1

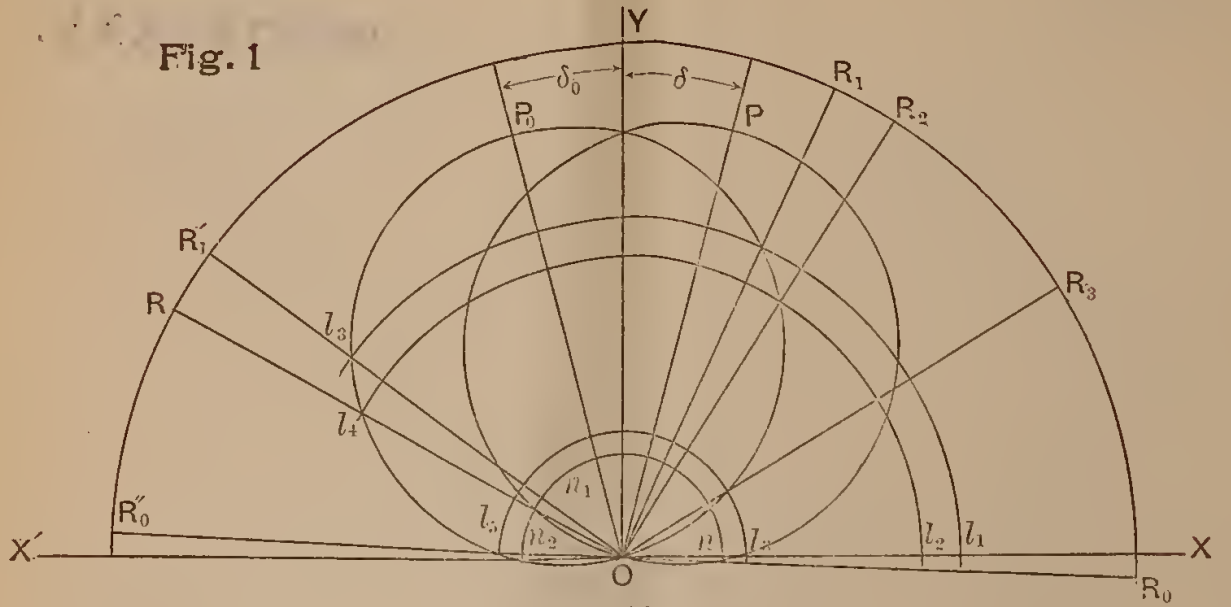

Fig. 2

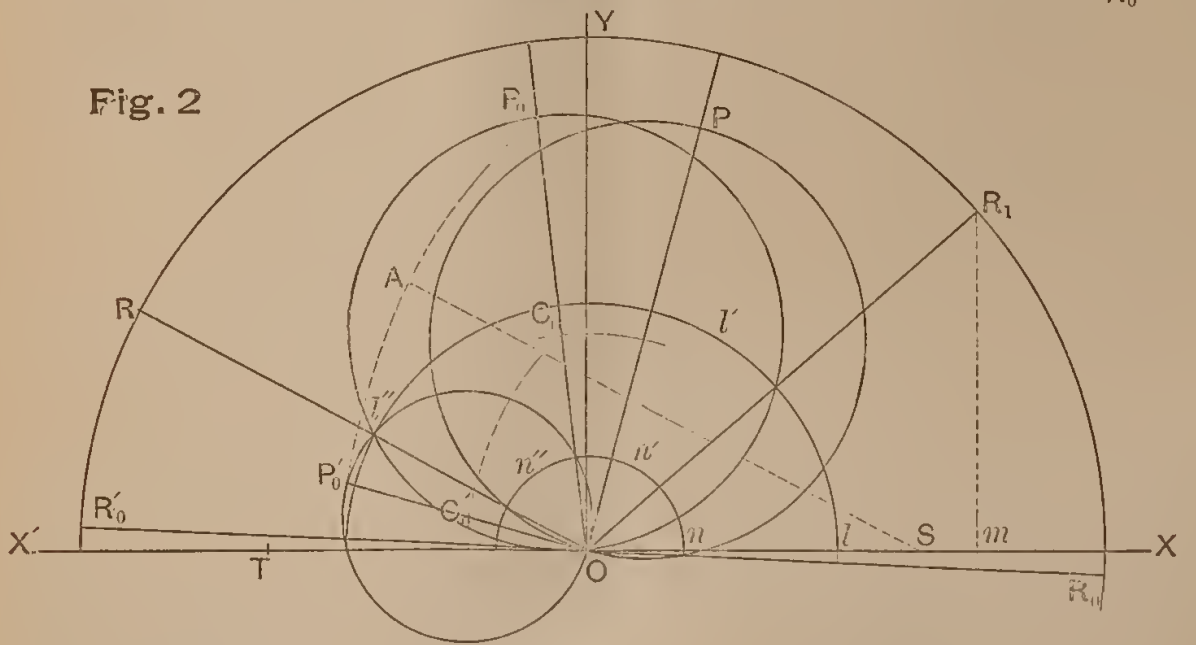
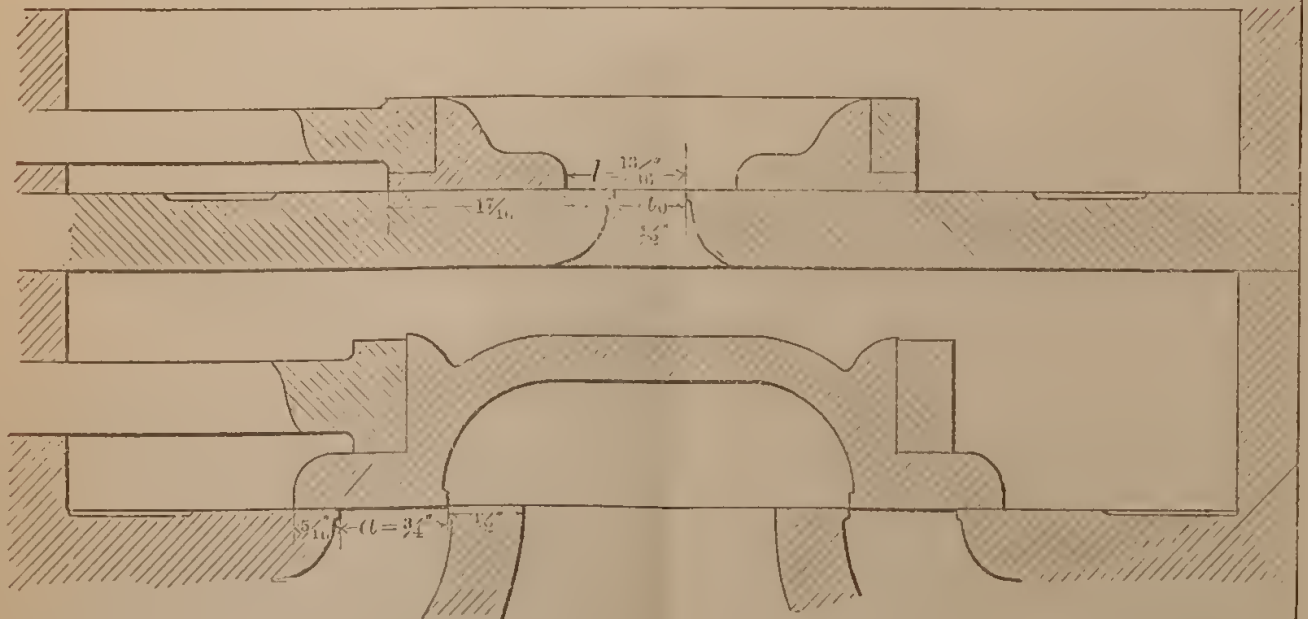

Fig. 3



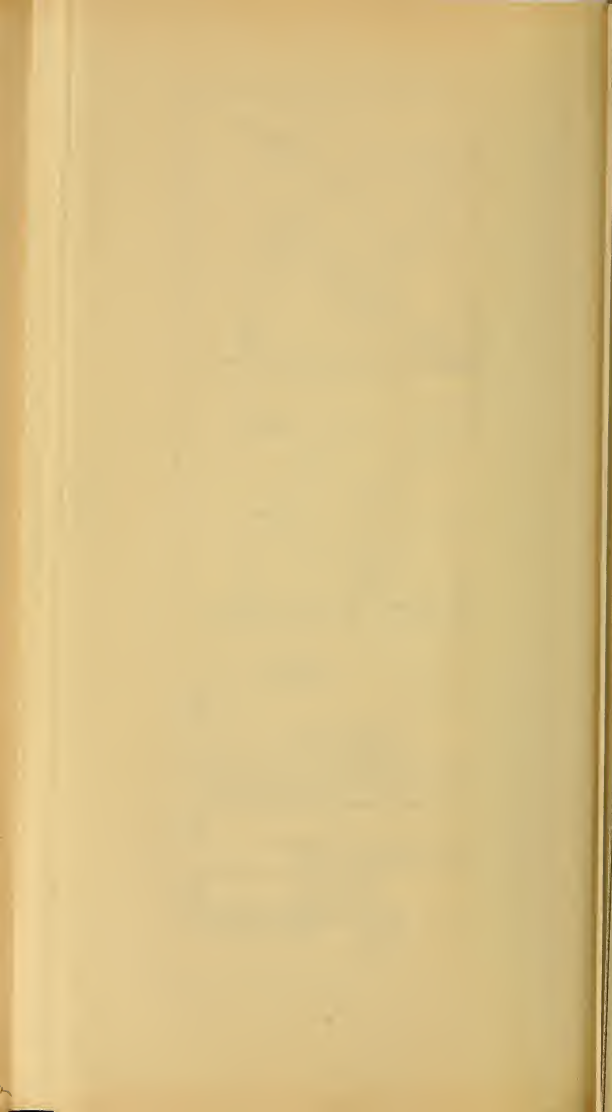
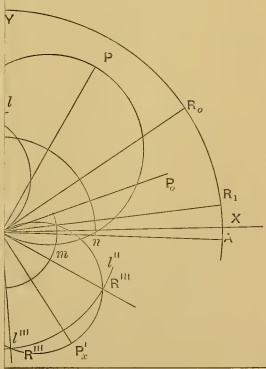
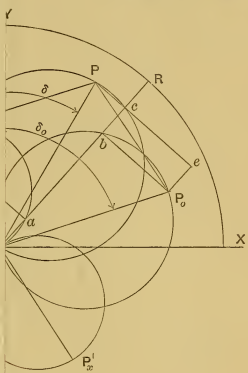
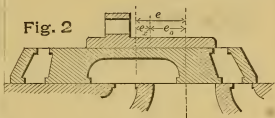

Fig. 2



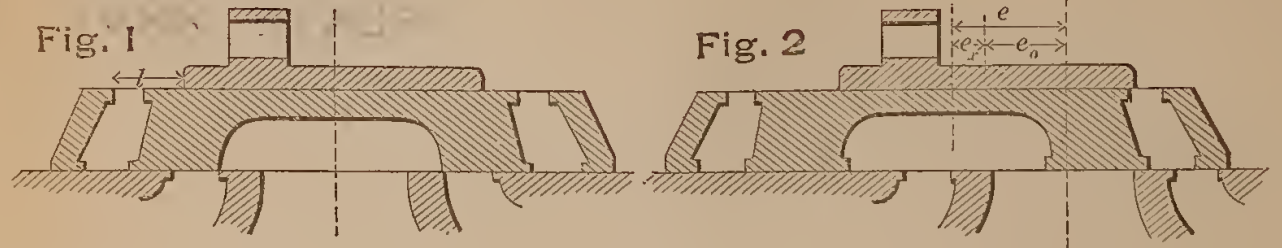

Fig. 3

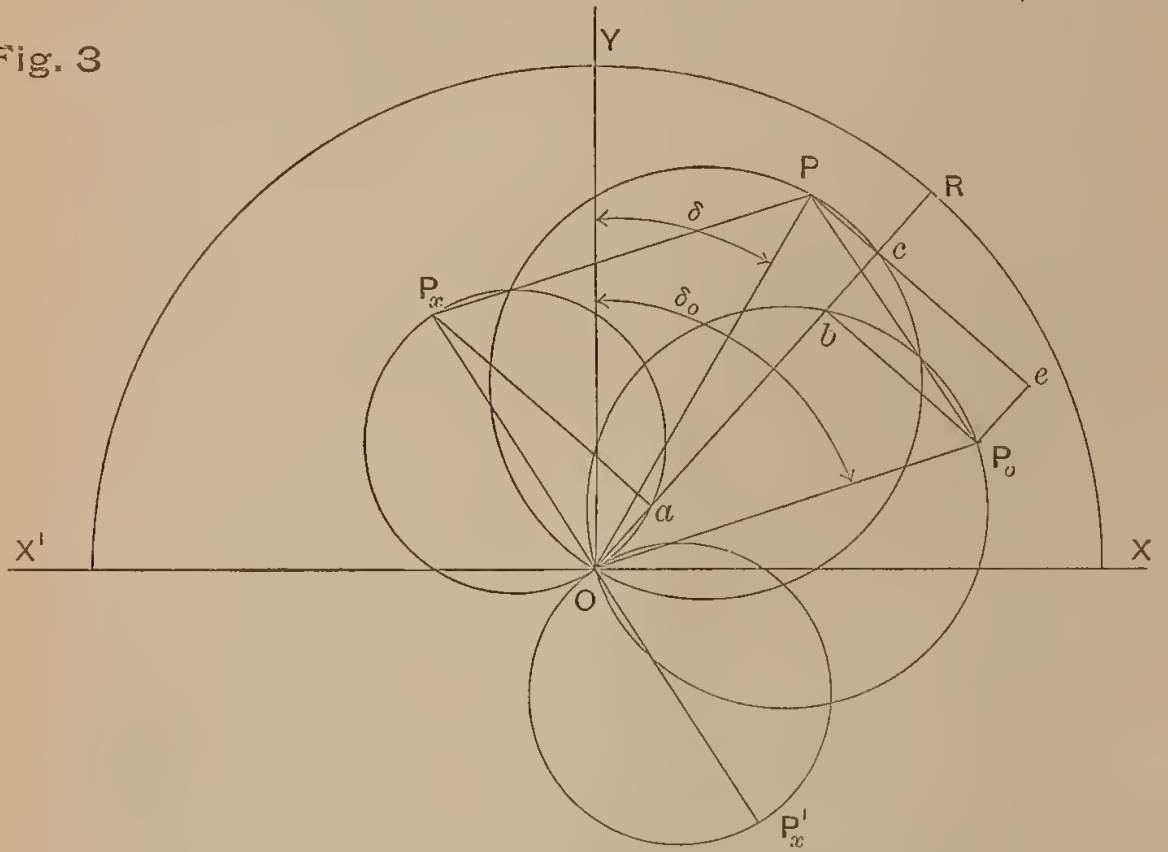
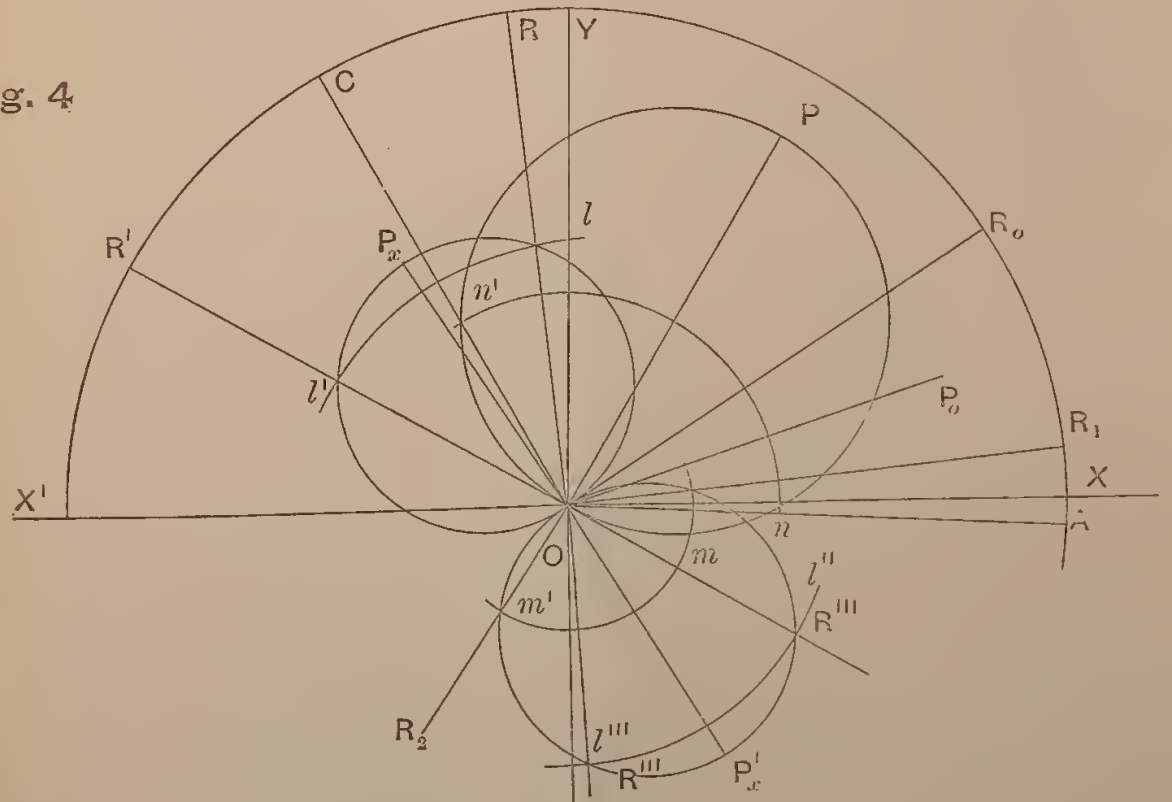

Fig. 4





I.

Fig. 2

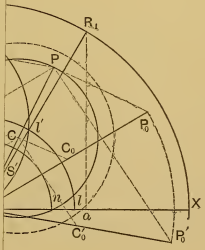
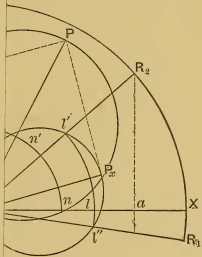
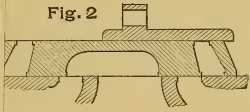

Fig. 1

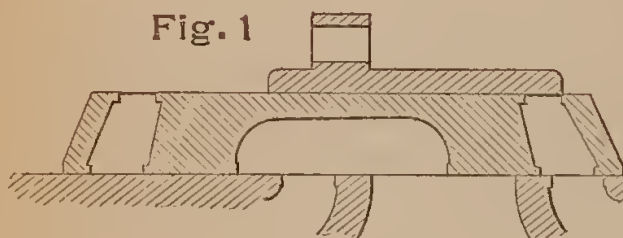

Fig. 2

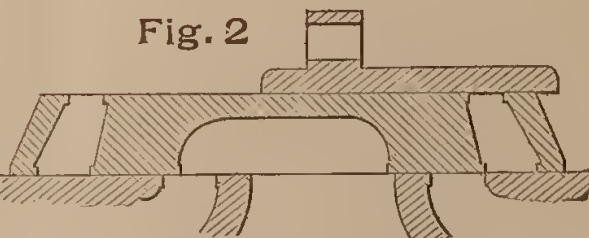

Fig. 4

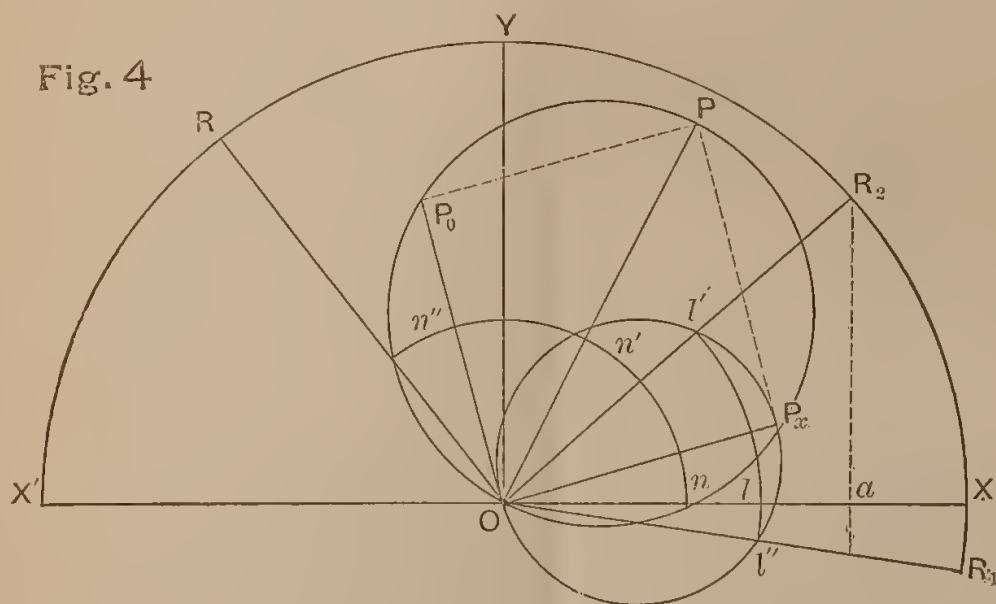
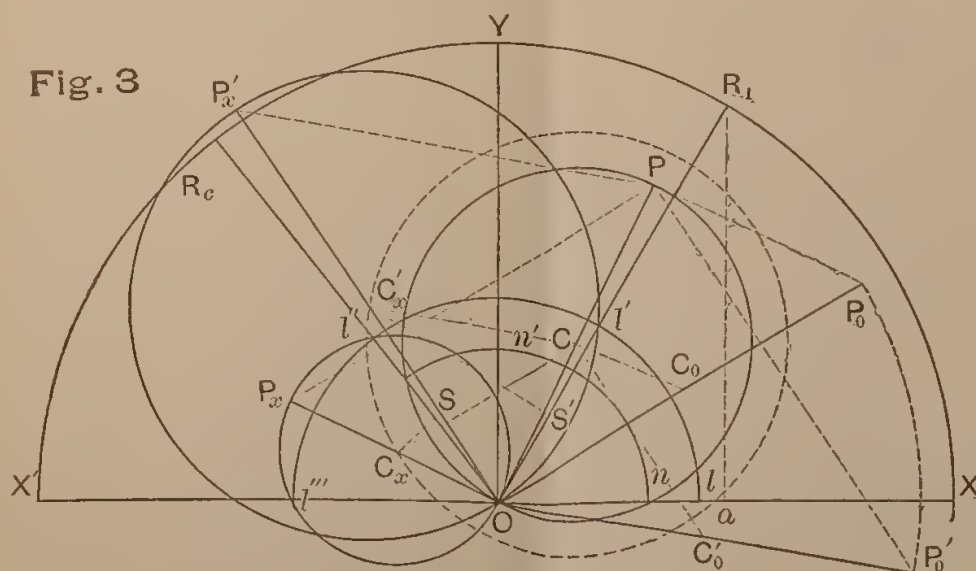

Fig. 3





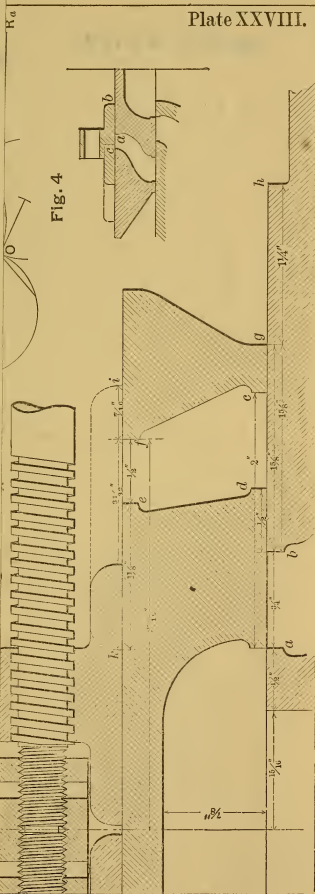
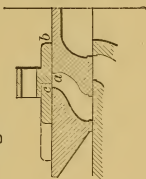

Fig. 4



R^a

Fig. 3

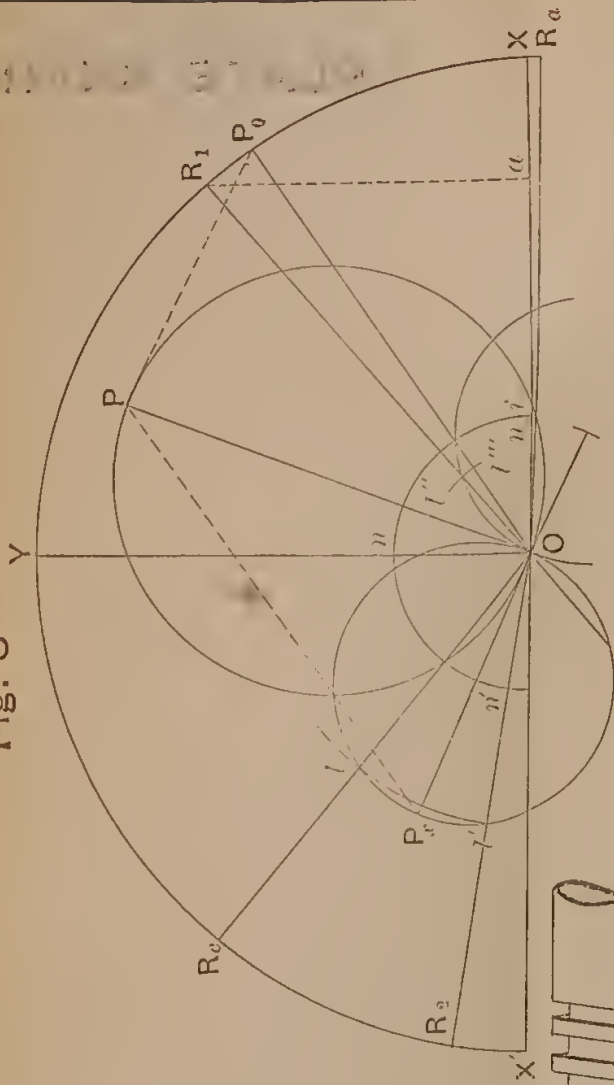

Fig. 1

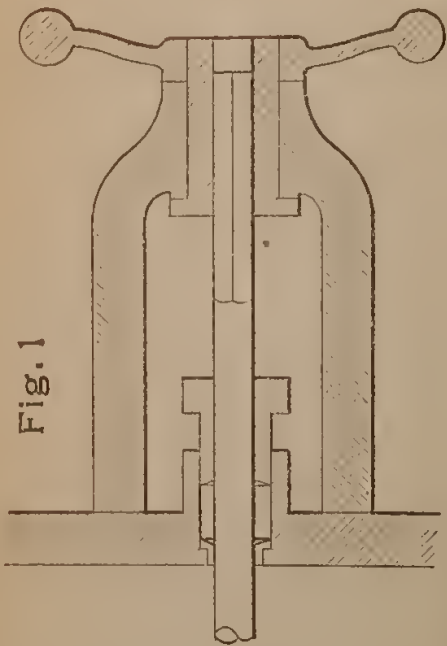

Fig. 2

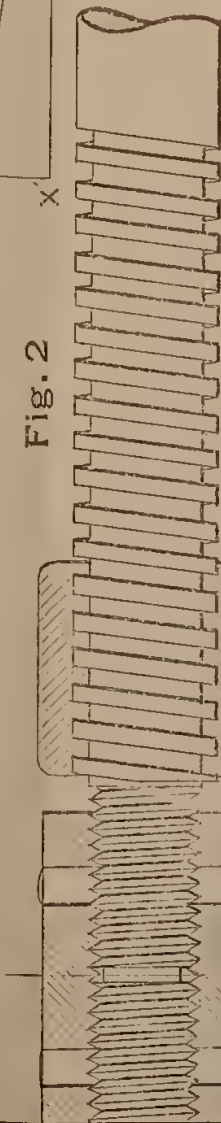
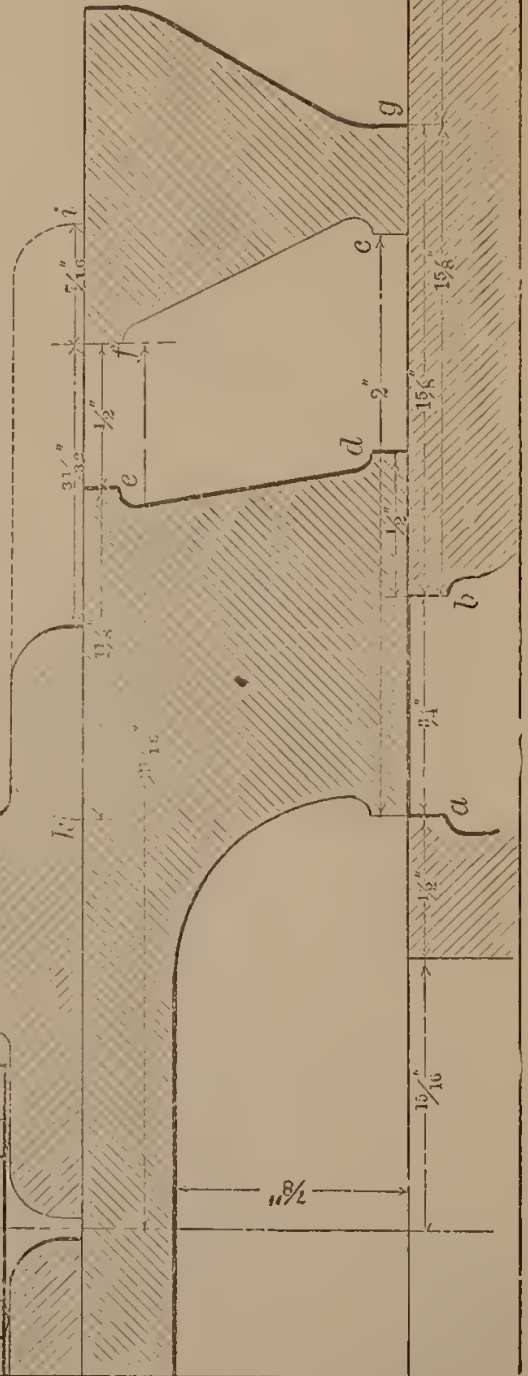
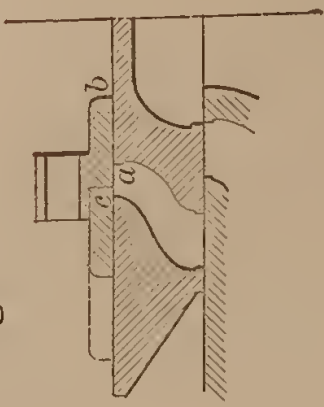
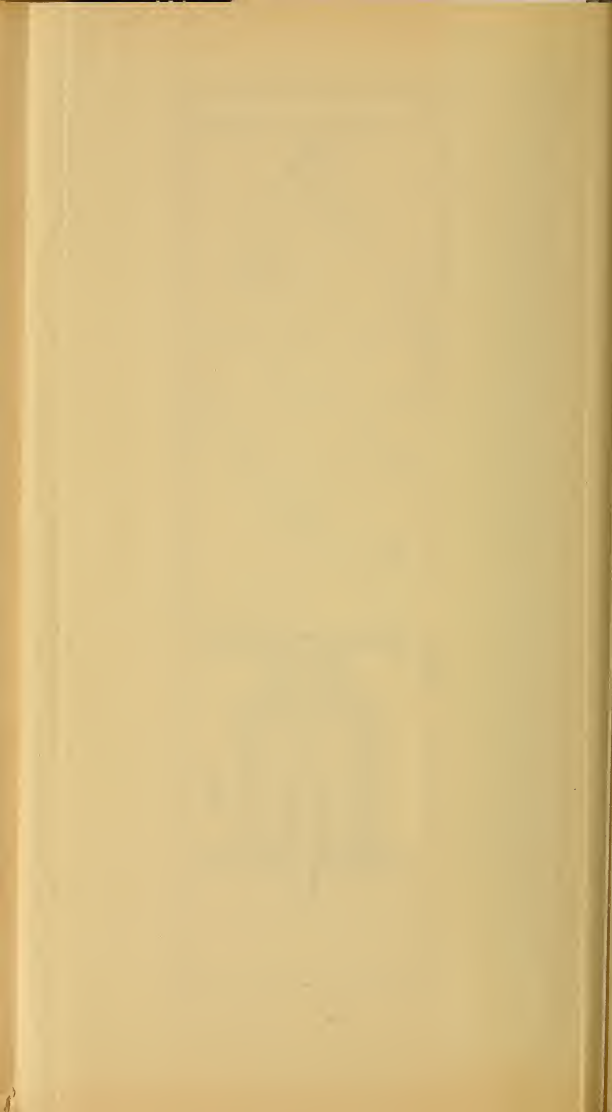

Fig. 4





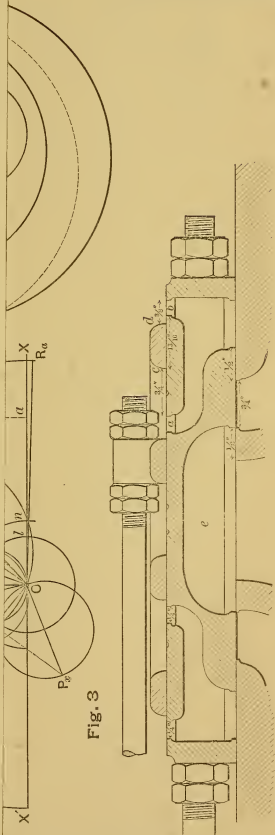

Fig. 3

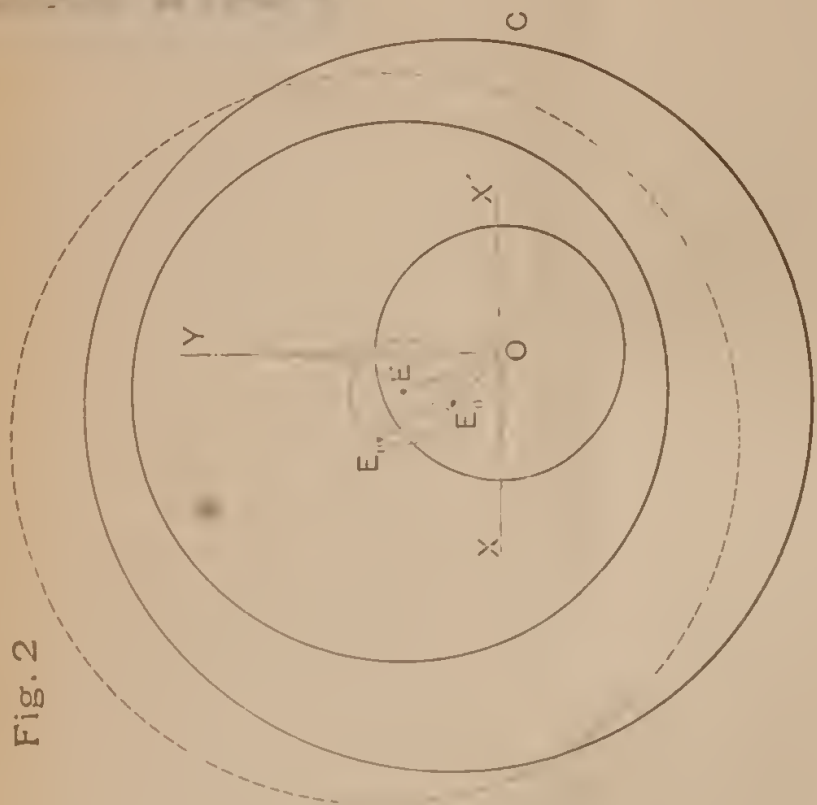

Fig. 2

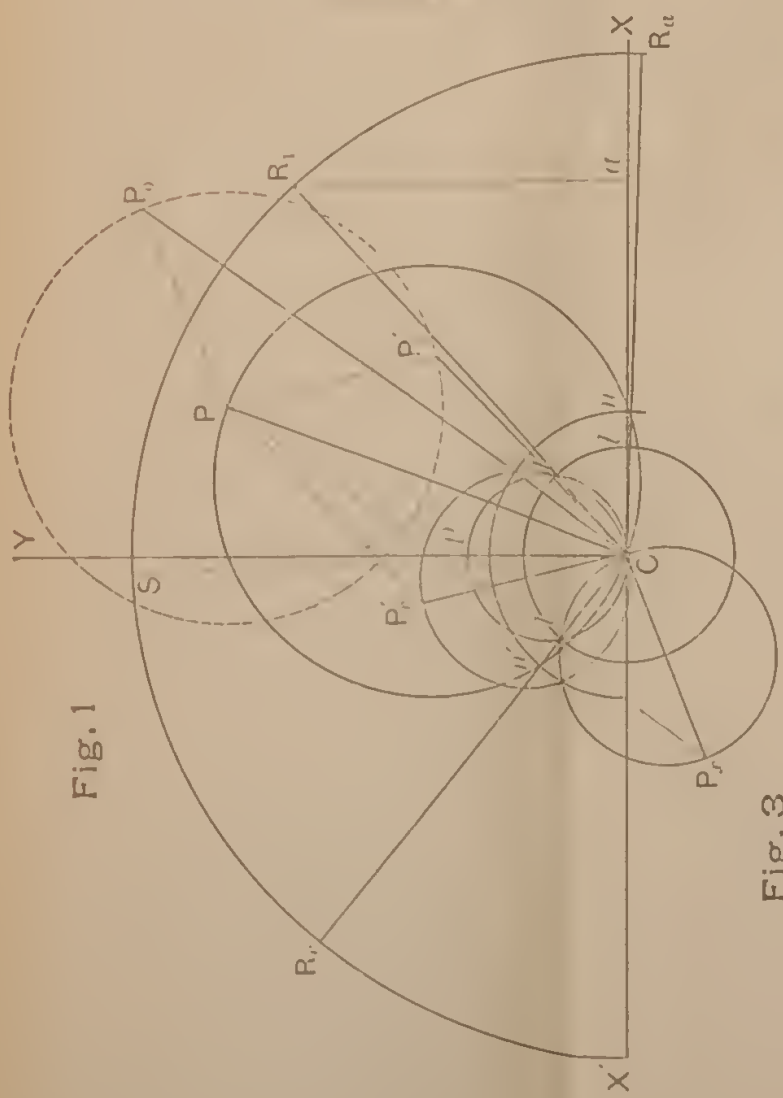

Fig. 1

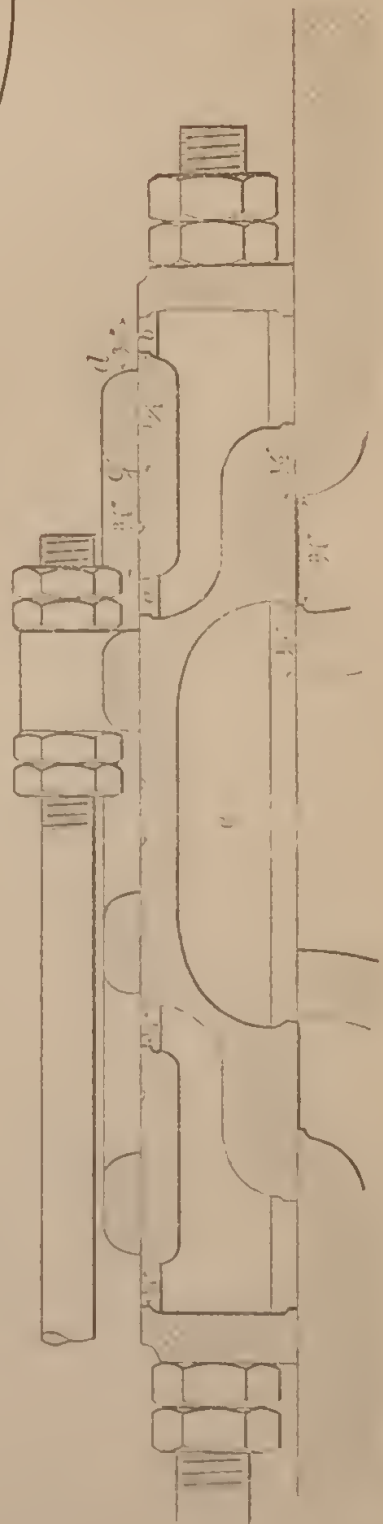
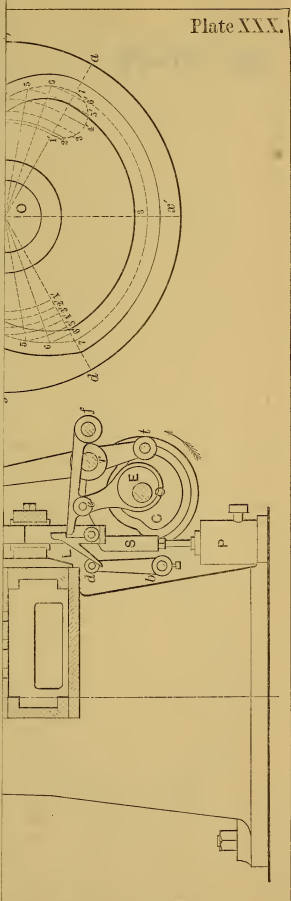

Fig. 3





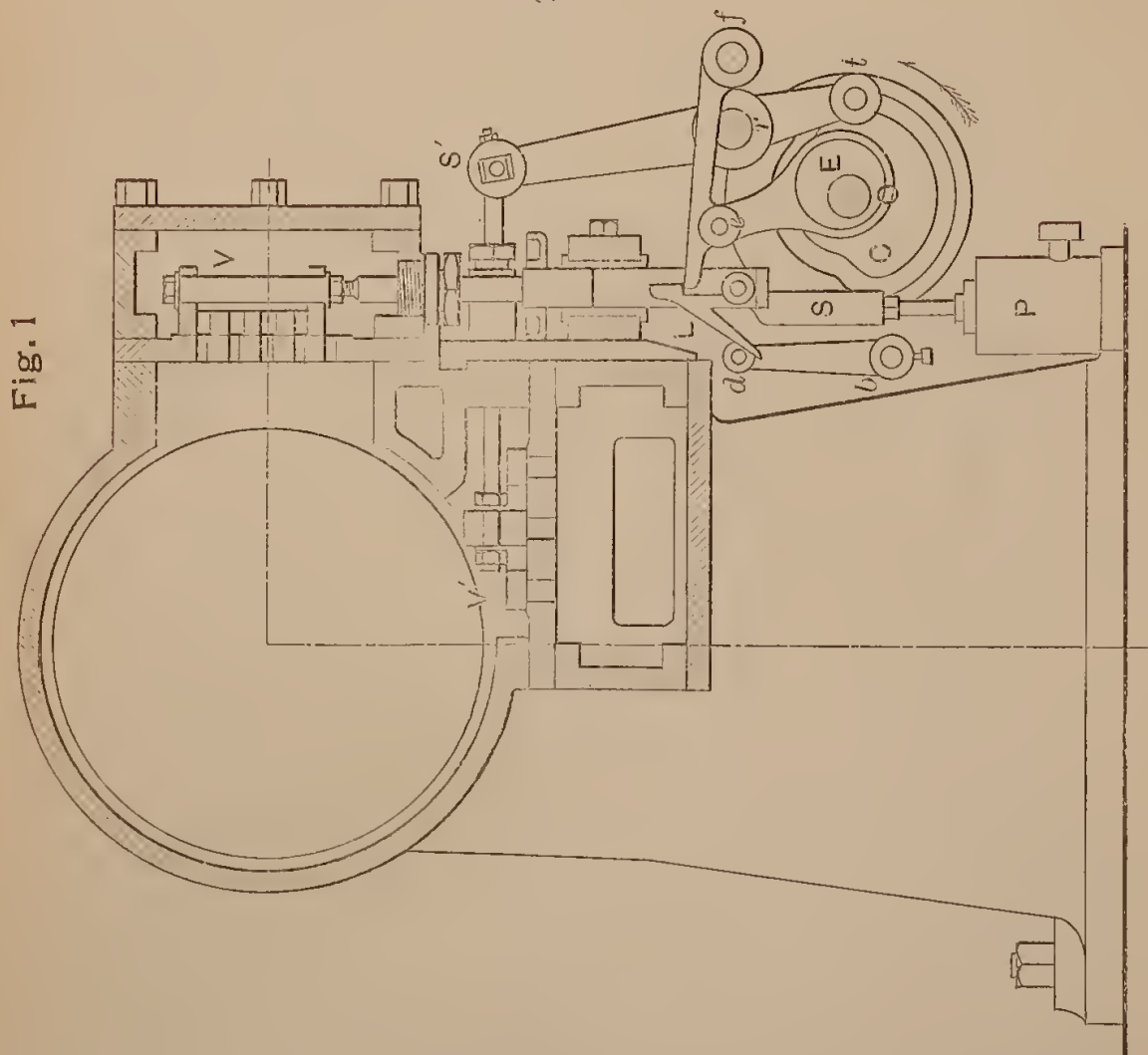

Fig. 2

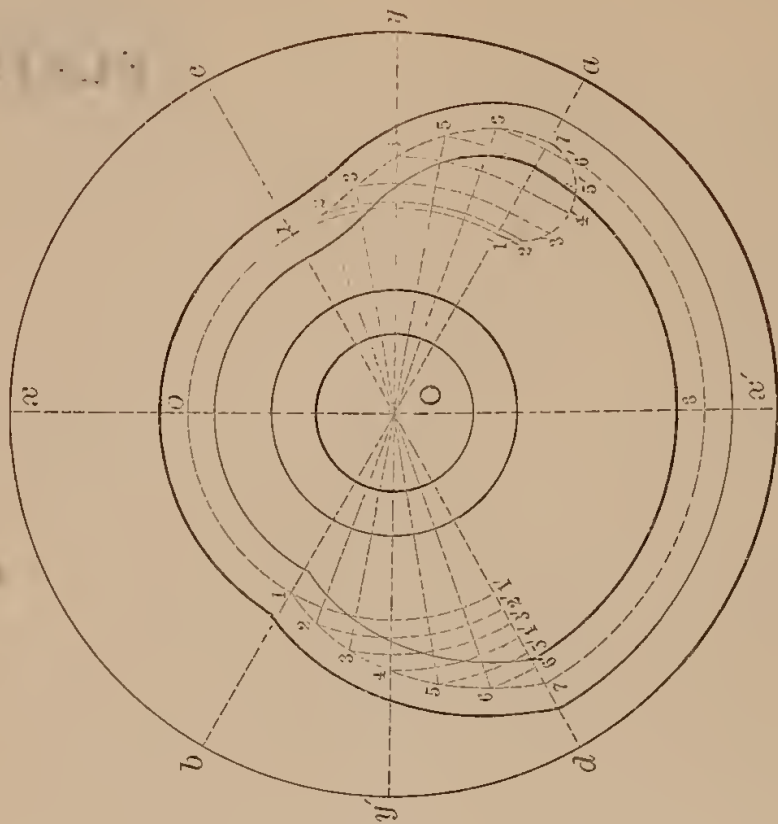



Fig. 3

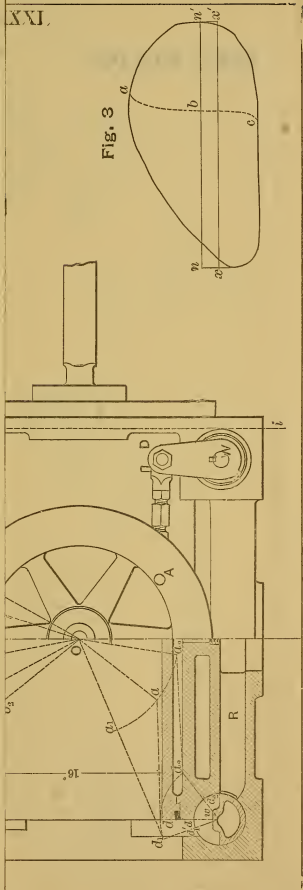

Fig. 1

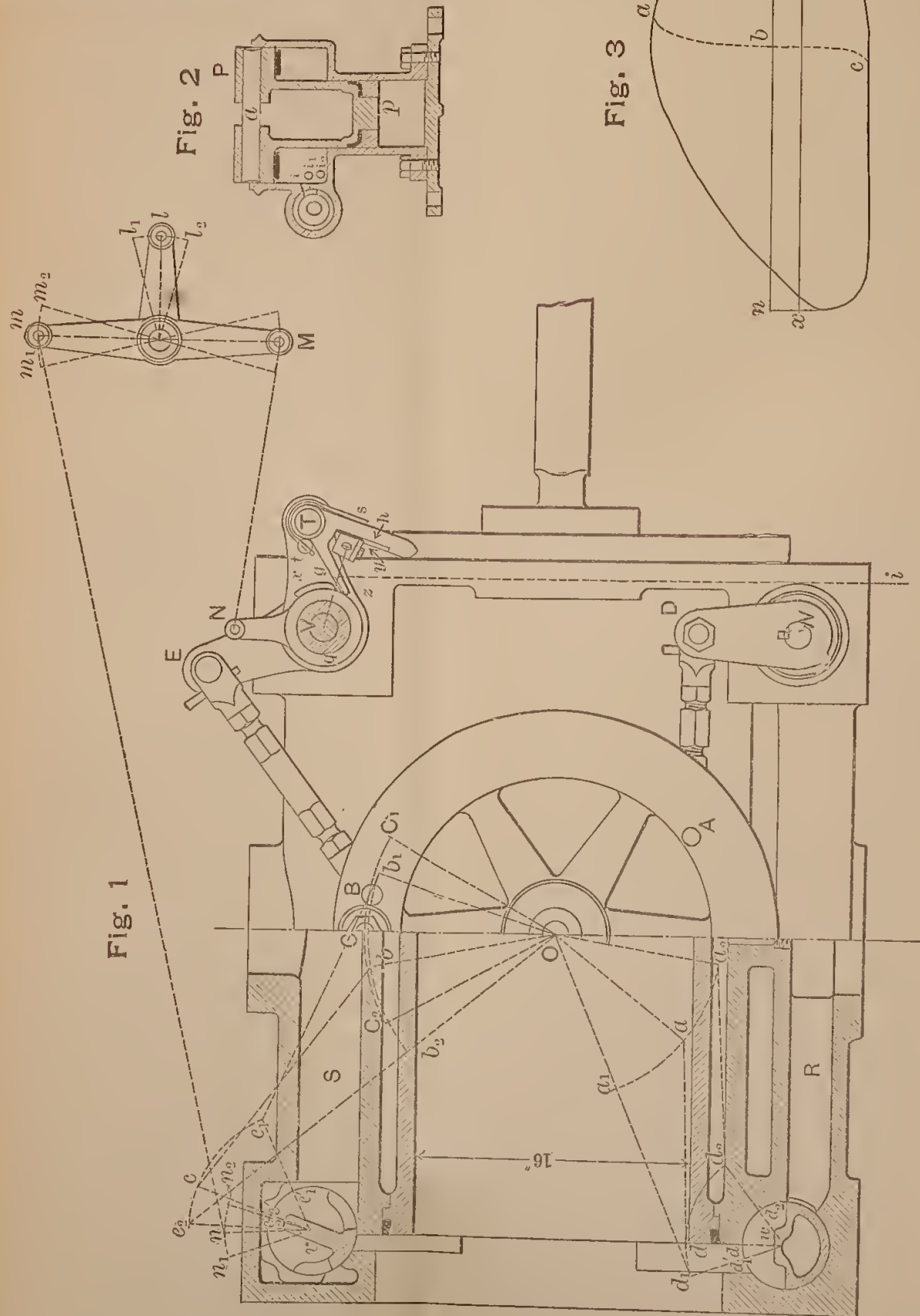

Fig. 2

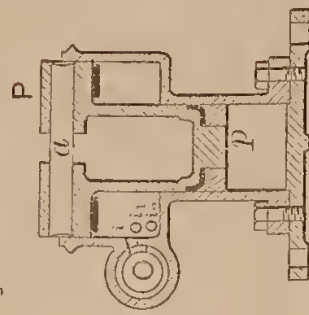
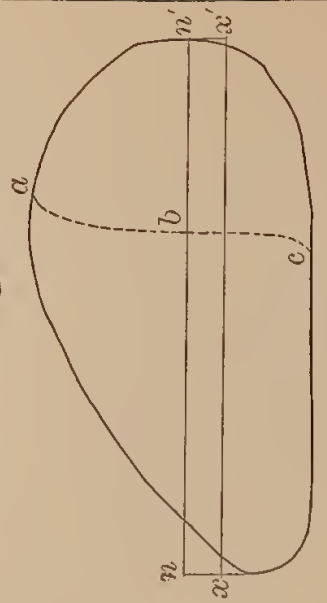
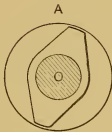

Fig. 3







K

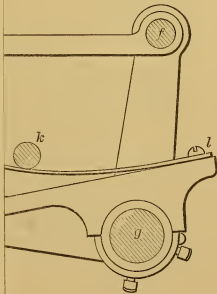

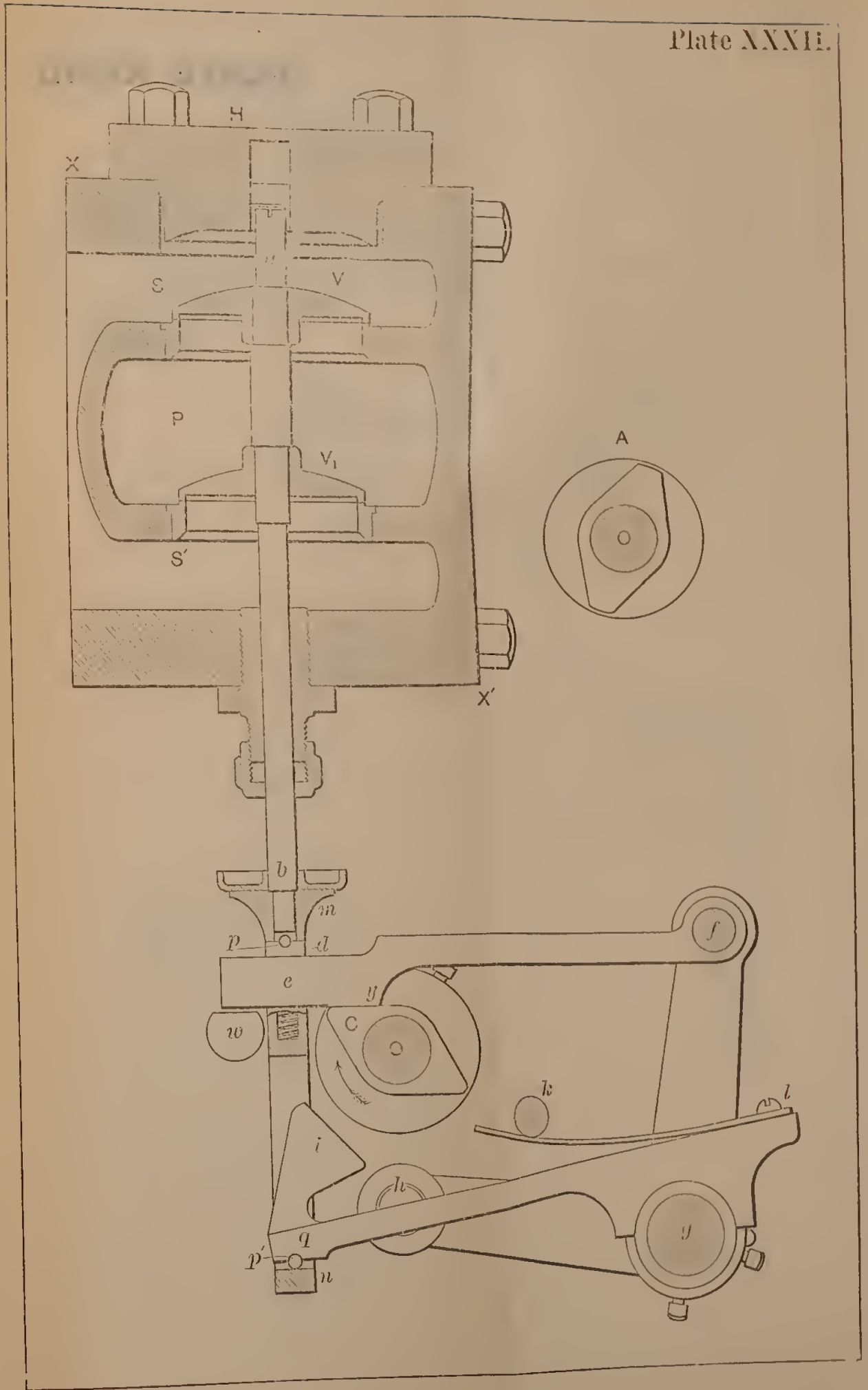



XXIII.

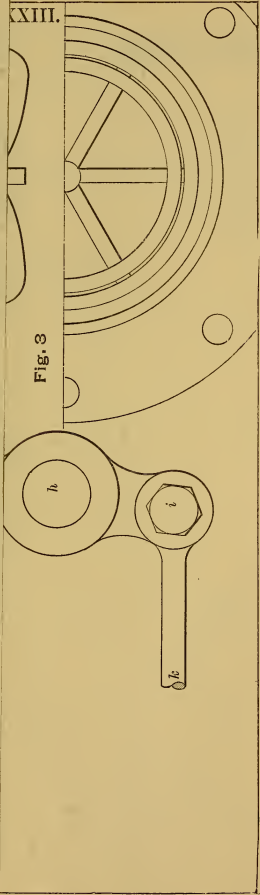

Fig. 3

Fig. 1

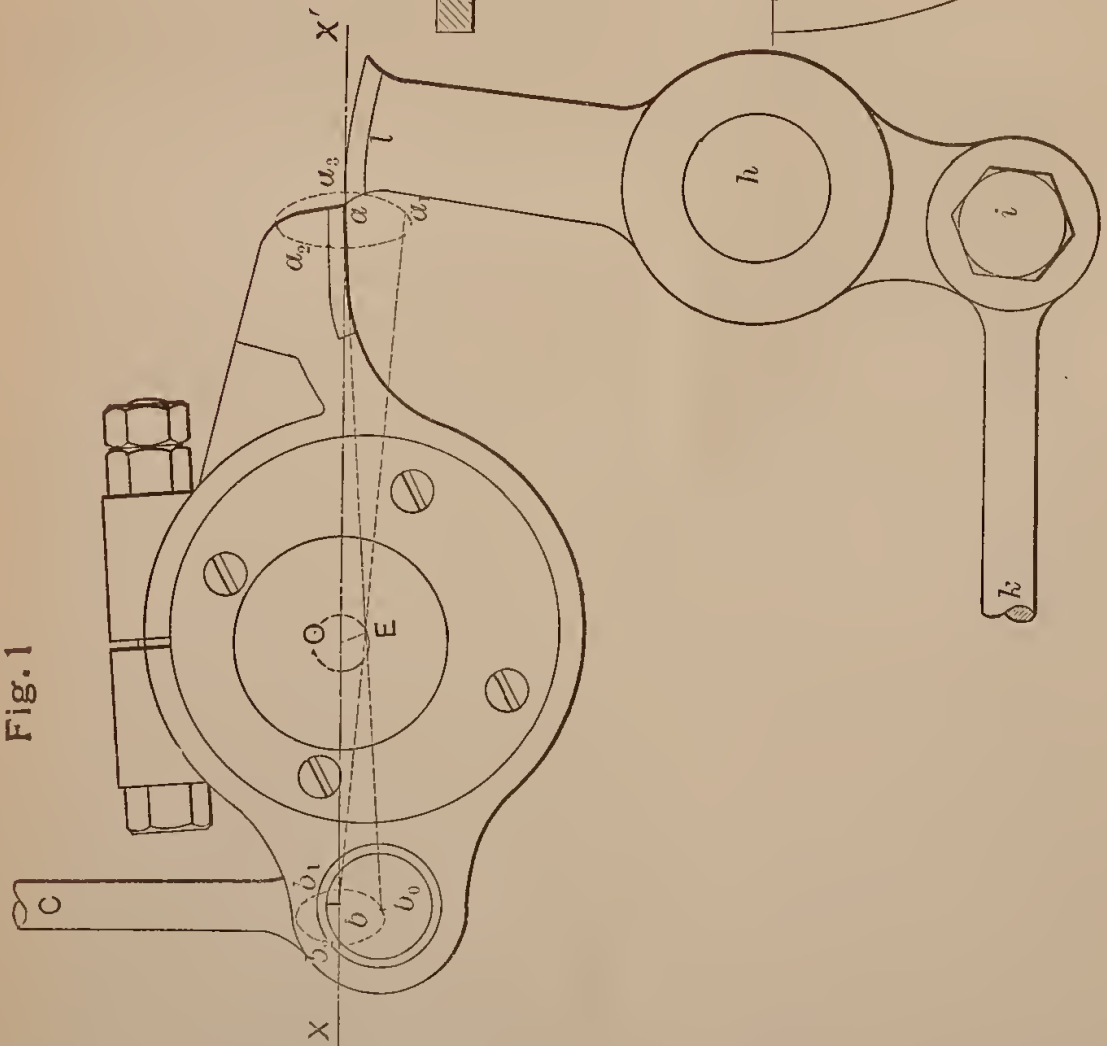

Fig. 2

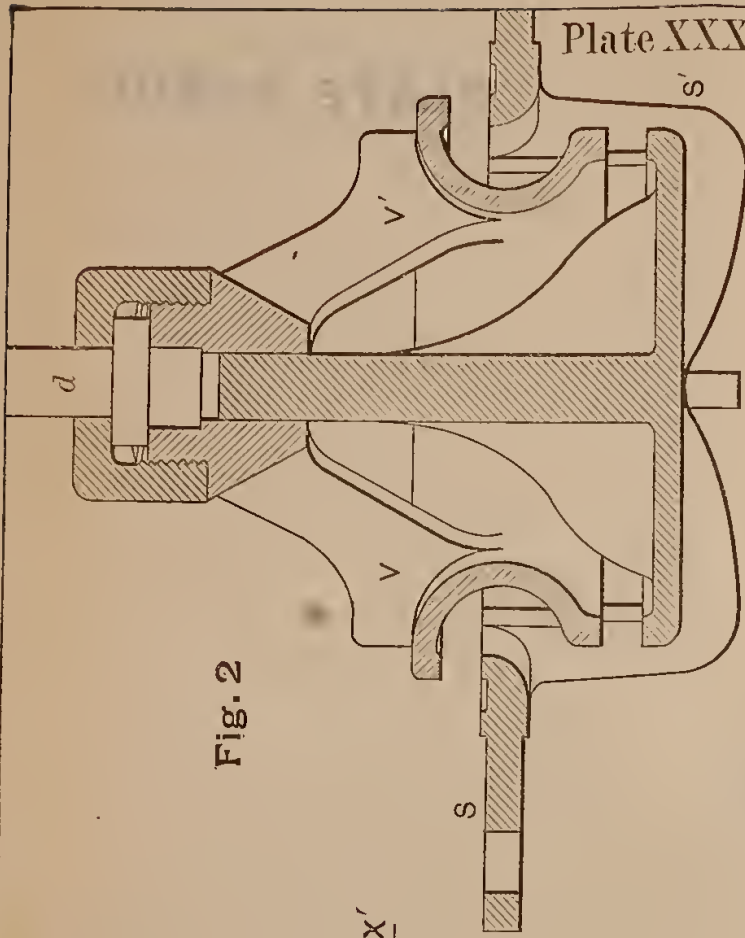
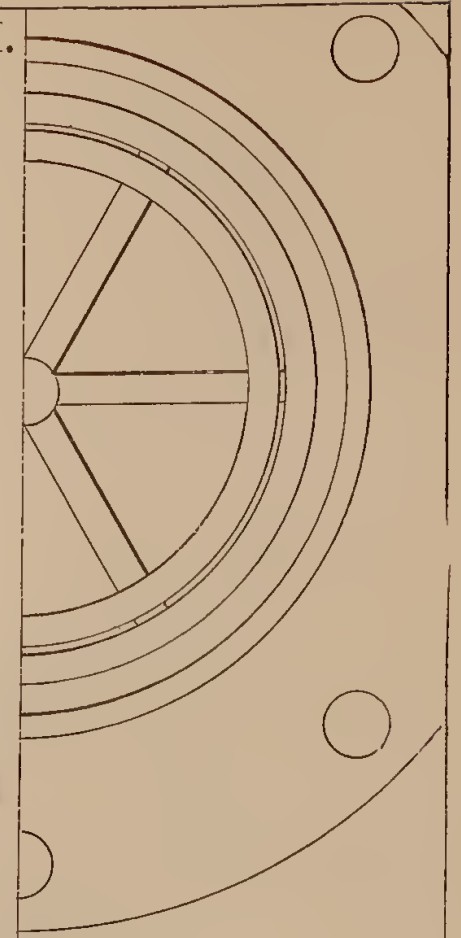

Fig. 3





SHORT-TITLE CATALOGUE

OF THE

PUBLICATIONS

OF

JOHN WILEY & SONS,

NEW YORK.

LONDON: CHAPMAN & HALL, LIMITED.

ARRANGED UNDER SUBJECTS.

Descriptive circulars sent on application. Books marked with an asterisk (*) are sold at *net* prices only, a double asterisk (**) books sold under the rules of the American Publishers' Association at *net* prices subject to an extra charge for postage. All books are bound in cloth unless otherwise stated.

AGRICULTURE.

Armsby's Manual of Cattle-feeding.	12mo,	\$1 75
Principles of Animal Nutrition.	8vo,	4 00
Budd and Hansen's American Horticultural Manual:		
Part I. Propagation, Culture, and Improvement.	12mo,	1 50
Part II. Systematic Pomology.	12mo,	1 50
Downing's Fruits and Fruit-trees of America	8vo,	5 00
Elliott's Engineering for Land Drainage.	12mo,	1 50
Practical Farm Drainage.	12mo,	1 00
Green's Principles of American Forestry.	12mo,	1 50
Grottenfelt's Principles of Modern Dairy Practice. (Woll).	12mo,	2 00
Kemp's Landscape Gardening.	12mo,	2 50
Maynard's Landscape Gardening as Applied to Home Decoration.	12mo,	1 50
* McKay and Larsen's Principles and Practice of Butter-making	8vo,	1 50
Sanderson's Insects Injurious to Staple Crops.	12mo,	1 50
Insects Injurious to Garden Crops. (In preparation.)		
Insects Injuring Fruits. (In preparation.)		
Stockbridge's Rocks and Soils.	8vo,	2 50
Winton's Microscopy of Vegetable Foods.	8vo,	7 50
Woll's Handbook for Farmers and Dairymen.	16mo,	1 50

ARCHITECTURE.

Baldwin's Steam Heating for Buildings.	12mo,	2 50
Bashore's Sanitation of a Country House.	12mo,	1 00
Berg's Buildings and Structures of American Railroads.	4to,	5 00
Birkmire's Planning and Construction of American Theatres.	8vo,	3 00
Architectural Iron and Steel.	8vo,	3 50
Compound Riveted Girders as Applied in Buildings.	8vo,	2 00
Planning and Construction of High Office Buildings.	8vo,	3 50
Skeleton Construction in Buildings.	8vo,	3 00
Brigg's Modern American School Buildings.	8vo,	4 00
Carpenter's Heating and Ventilating of Buildings.	8vo,	4 00
Freitag's Architectural Engineering.	8vo,	3 50
Fireproofing of Steel Buildings.	8vo,	2 50
French and Ives's Stereotomy.	8vo,	2 50

Gerhard's Guide to Sanitary House-inspection.	16mo,	1 00
Theatre Fires and Panics.	12mo,	1 50
*Greene's Structural Mechanics.	8vo,	2 50
Holly's Carpenters' and Joiners' Handbook.	18mo,	75
Johnson's Statics by Algebraic and Graphic Methods.	8vo,	2 00
Kidder's Architects' and Builders' Pocket-book. Rewritten Edition.	16mo, mor.,	5 00
Merrill's Stones for Building and Decoration.	8vo,	5 00
Non-metallic Minerals: Their Occurrence and Uses.	8vo,	4 00
Monckton's Stair-building.	4to,	4 00
Patton's Practical Treatise on Foundations.	8vo,	5 00
Peabody's Naval Architecture.	8vo,	7 50
Richey's Handbook for Superintendents of Construction.	16mo, mor.,	4 00
Sabin's Industrial and Artistic Technology of Paints and Varnish.	8vo,	3 00
Siebert and Biggin's Modern Stone-cutting and Masonry.	8vo,	1 50
Snow's Principal Species of Wood.	8vo,	3 50
Sondericker's Graphic Statics with Applications to Trusses, Beams, and Arches.	8vo,	2 00
Towne's Locks and Builders' Hardware.	18mo, morocco,	3 00
Wait's Engineering and Architectural Jurisprudence.	8vo,	6 00
Sheep,		6 50
Law of Operations Preliminary to Construction in Engineering and Architecture.	8vo,	5 00
Sheep,		5 50
Law of Contracts.	8vo,	3 00
Wood's Rustless Coatings: Corrosion and Electrolysis of Iron and Steel.	8vo,	4 00
Worcester and Atkinson's Small Hospitals, Establishment and Maintenance, Suggestions for Hospital Architecture, with Plans for a Small Hospital.	12mo,	1 25
The World's Columbian Exposition of 1893.	Large 4to,	1 00

ARMY AND NAVY.

Bernadou's Smokeless Powder, Nitro-cellulose, and the Theory of the Cellulose Molecule.	12mo,	2 50
* Bruff's Text-book Ordnance and Gunnery.	8vo,	6 00
Chase's Screw Propellers and Marine Propulsion.	8vo,	3 00
Cloke's Gunner's Examiner.	8vo,	1 50
Craig's Azimuth.	4to,	3 50
Crehore and Squier's Polarizing Photo-chronograph.	8vo,	3 00
* Davis's Elements of Law.	8vo,	2 50
* Treatise on the Military Law of United States.	8vo,	7 00
Sheep,		7 50
De Brack's Cavalry Outposts Duties. (Carr.)	24mo, morocco,	2 00
Dietz's Soldier's First Aid Handbook.	16mo, morocco,	1 25
* Dredge's Modern French Artillery.	4to, half morocco,	15 00
Durand's Resistance and Propulsion of Ships.	8vo,	5 00
* Dyer's Handbook of Light Artillery.	12mo,	3 00
Eissler's Modern High Explosives.	8vo,	4 00
* Fiebege's Text-book on Field Fortification.	Small 8vo,	2 00
Hamilton's The Gunner's Catechism.	18mo,	1 00
* Hoff's Elementary Naval Tactics.	8vo,	1 50
Ingalls's Handbook of Problems in Direct Fire.	8vo,	4 00
* Ballistic Tables.	8vo,	1 50
* Lyons's Treatise on Electromagnetic Phenomena. Vols. I. and II.	8vo, each,	6 00
* Mahan's Permanent Fortifications. (Mercur.)	8vo, half morocco,	7 50
Manual for Courts-martial.	16mo, morocco,	1 50
* Mercur's Attack of Fortified Places.	12mo,	2 00
* Elements of the Art of War.	8vo,	4 00

Metcalf's Cost of Manufactures—And the Administration of Workshops.	8vo,	5 00
* Ordnance and Gunnery. 2 vols.	12mo,	5 00
Murray's Infantry Drill Regulations.	18mo, paper,	10
Nixon's Adjutants' Manual.	24mo,	1 00
Peabody's Naval Architecture.	8vo,	7 50
* Phelps's Practical Marine Surveying.	8vo,	2 50
Powell's Army Officer's Examiner.	12mo,	4 00
Sherpe's Art of Subsisting Armies in War.	18mo, morocco,	1 50
* Walke's Lectures on Explosives.	8vo,	4 00
* Wheeler's Siege Operations and Military Mining.	8vo,	2 00
Winthrop's Abridgment of Military Law.	12mo,	2 50
Woodhull's Notes on Military Hygiene.	16mo,	1 50
Young's Simple Elements of Navigation.	16mo, morocco,	2 00

ASSAYING.

Fletcher's Practical Instructions in Quantitative Assaying with the Blowpipe.	12mo, morocco,	1 50
Furman's Manual of Practical Assaying.	8vo,	3 00
Lodge's Notes on Assaying and Metallurgical Laboratory Experiments.	8vo,	3 00
Low's Technical Methods of Ore Analysis.	8vo,	3 00
Miller's Manual of Assaying.	12mo,	1 00
Minet's Production of Aluminum and its Industrial Use. (Waldo.)	12mo,	2 50
O'Driscoll's Notes on the Treatment of Gold Ores.	8vo,	2 00
Ricketts and Miller's Notes on Assaying.	8vo,	3 00
Robine and Lenglen's Cyanide Industry. (Le Clerc.)	8vo,	
Ulke's Modern Electrolytic Copper Refining.	8vo,	3 00
Wilson's Cyanide Processes.	12mo,	1 50
Chlorination Process.	12mo,	1 50

ASTRONOMY.

Comstock's Field Astronomy for Engineers.	8vo,	2 50
Craig's Azimuth.	4to,	3 50
Doolittle's Treatise on Practical Astronomy.	8vo,	4 00
Gore's Elements of Geodesy.	8vo,	2 50
Hayford's Text-book of Geodetic Astronomy.	8vo,	3 00
Merriman's Elements of Precise Surveying and Geodesy.	8vo,	2 50
* Michie and Harlow's Practical Astronomy.	8vo,	3 00
* White's Elements of Theoretical and Descriptive Astronomy	12mo,	2 00

BOTANY.

Davenport's Statistical Methods, with Special Reference to Biological Variation.	16mo, morocco,	1 25
Thomé and Bennett's Structural and Physiological Botany.	16mo,	2 25
Westermaier's Compendium of General Botany. (Schneider.)	8vo,	2 00

CHEMISTRY.

Adriance's Laboratory Calculations and Specific Gravity Tables.	12mo,	1 25
Allen's Tables for Iron Analysis.	8vo,	3 00
Arnold's Compendium of Chemistry. (Mandel.)	Small 8vo,	3 50
Austen's Notes for Chemical Students	12mo,	1 50
Bernadou's Smokeless Powder.—Nitro-cellulose, and Theory of the Cellulose Molecule.	12mo,	2 50
* Browning's Introduction to the Rarer Elements.	8vo,	1 50

Brush and Penfield's Manual of Determinative Mineralogy.	8vo,	4 00
Classen's Quantitative Chemical Analysis by Electrolysis. (Boltwood.)	8vo,	3 00
Cohn's Indicators and Test-papers.	12mo,	2 00
Tests and Reagents.	8vo,	3 00
Crafts's Short Course in Qualitative Chemical Analysis. (Schaeffer.)	12mo,	1 50
Dolezalek's Theory of the Lead Accumulator (Storage Battery). (Von Ende.)	12mo,	2 50
Drechsel's Chemical Reactions. (Merrill.)	12mo,	1 25
Duhem's Thermodynamics and Chemistry. (Burgess.)	8vo,	4 00
Eissler's Modern High Explosives.	8vo,	4 00
Effront's Enzymes and their Applications. (Prescott.)	8vo,	3 00
Erdmann's Introduction to Chemical Preparations. (Dunlap.)	12mo,	1 25
Fletcher's Practical Instructions in Quantitative Assaying with the Blowpipe.	12mo, morocco,	1 50
Fowler's Sewage Works Analyses.	12mo,	2 00
Fresenius's Manual of Qualitative Chemical Analysis. (Wells.)	8vo,	5 00
Manual of Qualitative Chemical Analysis. Part I. Descriptive. (Wells.)	8vo,	3 00
System of Instruction in Quantitative Chemical Analysis. (Cohn.) 2 vols.	8vo,	12 50
Fuertes's Water and Public Health.	12mo,	1 50
Furman's Manual of Practical Assaying.	8vo,	3 00
* Getman's Exercises in Physical Chemistry	12mo,	2 00
Gill's Gas and Fuel Analysis for Engineers.	12mo,	1 25
Grottenfelt's Principles of Modern Dairy Practice. (Woll.)	12mo,	2 00
Hammarsten's Text-book of Physiological Chemistry. (Mandel.)	8vo,	4 00
Helm's Principles of Mathematical Chemistry. (Morgan.)	12mo,	1 50
Hering's Ready Reference Tables (Conversion Factors).	16mo, morocco,	2 50
Hind's Inorganic Chemistry.	8vo,	3 00
* Laboratory Manual for Students	12mo,	1 00
Holleman's Text-book of Inorganic Chemistry. (Cooper.)	8vo,	2 50
Text-book of Organic Chemistry. (Walker and Mott.)	8vo,	2 50
* Laboratory Manual of Organic Chemistry. (Walker.)	12mo,	1 00
Hopkins's Oil-chemists' Handbook.	8vo,	3 00
Jackson's Directions for Laboratory Work in Physiological Chemistry.	8vo,	1 25
Keep's Cast Iron.	8vo,	2 50
Ladd's Manual of Quantitative Chemical Analysis.	12mo,	1 00
Landauer's Spectrum Analysis. (Tingle.)	8vo,	3 00
* Langworthy and Austen. The Occurrence of Aluminium in Vegetable Products, Animal Products, and Natural Waters.	8vo,	2 00
Lassar-Cohn's Practical Urinary Analysis. (Lorenz.)	12mo,	1 00
Application of Some General Reactions to Investigations in Organic Chemistry. (Tingle.)	12mo,	1 00
Leach's The Inspection and Analysis of Food with Special Reference to State Control.	8vo,	7 50
Löb's Electrochemistry of Organic Compounds. (Lorenz.)	8vo,	3 00
Lodge's Notes on Assaying and Metallurgical Laboratory Experiments.	8vo,	3 00
Low's Technical Method of Ore Analysis.	8vo,	3 00
Lunge's Techno-chemical Analysis. (Cohn.)	12mo,	1 00
Mandel's Handbook for Bio-chemical Laboratory	12mo,	1 50
* Martin's Laboratory Guide to Qualitative Analysis with the Blowpipe.	12mo,	60
Mason's Water-supply. (Considered Principally from a Sanitary Standpoint.) 3d Edition, Rewritten.	8vo,	4 00
Examination of Water. (Chemical and Bacteriological.)	12mo,	1 25
Matthew's The Textile Fibres.	8vo,	3 50
Meyer's Determination of Radicles in Carbon Compounds. (Tingle.)	12mo,	1 00
Miller's Manual of Assaying.	12mo,	1 00
Minet's Production of Aluminum and its Industrial Use. (Waldo.)	12mo,	2 50
Mixer's Elementary Text-book of Chemistry.	12mo,	1 50
Morgan's Elements of Physical Chemistry.	12mo,	3 00
* Physical Chemistry for Electrical Engineers.	12mo,	1 50

Morse's Calculations used in Cane-sugar Factories.	16mo, morocco,	1 50
Mulliken's General Method for the Identification of Pure Organic Compounds.		
Vol. I.	Large 8vo,	5 00
O'Brine's Laboratory Guide in Chemical Analysis.	8vo,	2 00
O'Driscoll's Notes on the Treatment of Gold Ores.	8vo,	2 00
Ostwald's Conversations on Chemistry. Part One. (Ramsey.).	12mo,	1 50
" " " " " " " " " " " " " " " " " " " "	Part Two. (Turnbull.).	12mo, 2 00
* Penfield's Notes on Determinative Mineralogy and Record of Mineral Tests.		
8vo, paper,		50
Pictet's The Alkaloids and their Chemical Constitution. (Biddle.)	8vo,	5 00
Pinner's Introduction to Organic Chemistry. (Austen.).	12mo,	1 50
Poole's Calorific Power of Fuels.	8vo,	3 00
Prescott and Winslow's Elements of Water Bacteriology, with Special Reference to Sanitary Water Analysis.	12mo,	1 25
* Reisig's Guide to Piece-dyeing.	8vo,	25 00
Richards and Woodman's Air, Water, and Food from a Sanitary Stand-point.	8vo,	2 00
Richards's Cost of Living as Modified by Sanitary Science.	12mo,	1 00
Cost of Food, a Study in Diетaries	12mo,	1 00
* Richards and Williams's The Dietary Computer.	8vo,	1 50
Ricketts and Russell's Skeleton Notes upon Inorganic Chemistry. (Part I. Non-metallic Elements.)	8vo, morocco,	75
Ricketts and Miller's Notes on Assaying.	8vo,	3 00
Ridea'll's Sewage and the Bacterial Purification of Sewage.	8vo,	3 50
Disinfection and the Preservation of Food.	8vo,	4 00
Rigg's Elementary Manual for the Chemical Laboratory.	8vo,	1 25
Robine and Lenglen's Cyanide Industry. (Le Clerc.).	8vo,	
Rostoski's Serum Diagnosis. (Bolduan.).	12mo,	1 00
Ruddiman's Incompatibilities in Prescriptions.	8vo,	2 00
* Whys in Pharmacy	12mo,	1 00
Sabin's Industrial and Artistic Technology of Paints and Varnish.	8vo,	3 00
Salkowski's Physiological and Pathological Chemistry. (Orndorff.).	8vo,	2 50
Schimpf's Text-book of Volumetric Analysis.	12mo,	2 50
Essentials of Volumetric Analysis.	12mo,	1 25
* Qualitative Chemical Analysis.	8vo,	1 25
Spencer's Handbook for Chemists of Beet-sugar Houses.	16mo, morocco,	3 00
Handbook for Cane Sugar Manufacturers.	16mo, morocco,	3 00
Stockbridge's Rocks and Soils.	8vo,	2 50
* Tillman's Elementary Lessons in Heat.	8vo,	1 50
* Descriptive General Chemistry.	8vo,	3 00
Treadwell's Qualitative Analysis. (Hall).	8vo,	3 00
Quantitative Analysis. (Hall.).	8vo,	4 00
Turneure and Russell's Public Water-supplies.	8vo,	5 00
Van Deventer's Physical Chemistry for Beginners. (Boltwood.).	12mo,	1 50
* Walke's Lectures on Explosives.	8vo,	4 00
Ware's Beet-sugar Manufacture and Refining	Small 8vo, cloth,	4 00
Washington's Manual of the Chemical Analysis of Rocks.	8vo,	2 00
Wassermann's Immune Sera: Hæmolysins, Cytotoxins, and Precipitins. (Bolduan.)	12mo,	1 00
Well's Laboratory Guide in Qualitative Chemical Analysis.	8vo,	1 50
Short Course in Inorganic Qualitative Chemical Analysis for Engineering Students.	12mo,	1 50
Text-book of Chemical Arithmetic	12mo,	1 25
Whipple's Microscopy of Drinking-water.	8vo,	3 50
Wilson's Cyanide Processes	12mo,	1 50
Chlorination Process.	12mo,	1 50
Winton's Microscopy of Vegetable Foods.	8vo,	7 50
Wulling's Elementary Course in Inorganic, Pharmaceutical, and Medical Chemistry.	12mo,	2 00

CIVIL ENGINEERING.

BRIDGES AND ROOFS. HYDRAULICS. MATERIALS OF ENGINEERING. RAILWAY ENGINEERING.

Baker's Engineers' Surveying Instruments.	12mo,	3 00
Bixby's Graphical Computing Table.	Paper 19½ × 24½ inches.	25
** Burr's Ancient and Modern Engineering and the Isthmian Canal. (Postage, 27 cents additional).	8vo,	3 50
Comstock's Field Astronomy for Engineers.	8vo,	2 50
Davis's Elevation and Stadia Tables.	8vo,	1 00
Elliott's Engineering for Land Drainage.	12mo,	1 50
Practical Farm Drainage.	12mo,	1 00
*Fiebegeer's Treatise on Civil Engineering.	8vo,	5 00
Folwell's Sewerage. (Designing and Maintenance).	8vo,	3 00
Freitag's Architectural Engineering. 2d Edition, Rewritten	8vo,	3 50
French and Ives's Stereotomy.	8vo,	2 50
Goodhue's Municipal Improvements.	12mo,	1 75
Goodrich's Economic Disposal of Towns' Refuse.	8vo,	3 50
Gore's Elements of Geodesy.	8vo,	2 50
Hayford's Text-book of Geodetic Astronomy.	8vo,	3 00
Hering's Ready Reference Tables (Conversion Factors).	16mo, morocco,	2 50
Howe's Retaining Walls for Earth.	12mo,	1 25
Johnson's (J. B.) Theory and Practice of Surveying.	Small 8vo,	4 00
Johnson's (L. J.) Statics by Algebraic and Graphic Methods.	8vo,	2 00
Laplace's Philosophical Essay on Probabilities. (Truscott and Emory).	12mo,	2 00
Mahan's Treatise on Civil Engineering. (1873.) (Wood).	8vo,	5 00
* Descriptive Geometry.	8vo,	1 50
Merriman's Elements of Precise Surveying and Geodesy.	8vo,	2 50
Merriman and Brooks's Handbook for Surveyors.	16mo, morocco,	7 00
Nugent's Plane Surveying.	8vo,	3 50
Ogden's Sewer Design.	12mo,	2 00
Patton's Treatise on Civil Engineering.	8vo half leather,	7 50
Reed's Topographical Drawing and Sketching	4to,	5 00
Rideal's Sewage and the Bacterial Purification of Sewage.	8vo,	3 50
Siebert and Biggin's Modern Stone-cutting and Masonry.	8vo,	1 50
Smith's Manual of Topographical Drawing. (McMillan).	8vo,	2 50
Sondericker's Graphic Statics, with Applications to Trusses, Beams, and Arches. 8vo, 2 00		
Taylor and Thompson's Treatise on Concrete, Plain and Reinforced.	8vo,	5 00
* Trautwine's Civil Engineer's Pocket-book.	16mo, morocco,	5 00
Wait's Engineering and Architectural Jurisprudence.	8vo,	6 00
Law of Operations Preliminary to Construction in Engineering and Archi- tecture.	8vo,	5 00
Law of Contracts.	8vo,	3 00
Warren's Stereotomy—Problems in Stone-cutting.	8vo,	2 50
Webb's Problems in the Use and Adjustment of Engineering Instruments. 16mo, morocco, 1 25		
Wilson's Topographic Surveying.	8vo,	3 50

BRIDGES AND ROOFS.

Boller's Practical Treatise on the Construction of Iron Highway Bridges.	8vo,	2 00
* Thames River Bridge.	4to, paper,	5 00
Burr's Course on the Stresses in Bridges and Roof Trusses, Arched Ribs, and Suspension Bridges.	8vo,	3 50

Burr and Falk's Influence Lines for Bridge and Roof Computations.	8vo,	3 00
Design and Construction of Metallic Bridges.	8vo,	5 00
Du Bois's Mechanics of Engineering. Vol. II.	Small 4to,	10 00
Foster's Treatise on Wooden Trestle Bridges.	4to,	5 00
Fowler's Ordinary Foundations.	8vo,	3 50
Greene's Roof Trusses.	8vo,	1 25
Bridge Trusses.	8vo,	2 50
Arches in Wood, Iron, and Stone.	8vo,	2 50
Howe's Treatise on Arches.	8vo,	4 00
Design of Simple Roof-trusses in Wood and Steel.	8vo,	2 00
Johnson, Bryan, and Turneure's Theory and Practice in the Designing of Modern Framed Structures.	Small 4to,	10 00
Merriman and Jacoby's Text-book on Roofs and Bridges:		
Part I. Stresses in Simple Trusses.	8vo,	2 50
Part II. Graphic Statics.	8vo,	2 50
Part III. Bridge Design.	8vo,	2 50
Part IV. Higher Structures.	8vo,	2 50
Morison's Memphis Bridge.	4to,	10 00
Waddell's De Pontibus, a Pocket-book for Bridge Engineers.	16mo, morocco,	2 00
Specifications for Steel Bridges.	12mo,	1 25
Wright's Designing of Draw-spans. Two parts in one volume.	8vo,	3 50

HYDRAULICS.

Bazin's Experiments upon the Contraction of the Liquid Vein Issuing from an Orifice. (Trautwine.)	8vo,	2 00
Bovey's Treatise on Hydraulics.	8vo,	5 00
Church's Mechanics of Engineering.	8vo,	6 00
Diagrams of Mean Velocity of Water in Open Channels.	paper,	1 50
Hydraulic Motors.	8vo,	2 00
Coffin's Graphical Solution of Hydraulic Problems.	16mo, morocco,	2 50
Flather's Dynamometers, and the Measurement of Power.	12mo,	3 00
Folwell's Water-supply Engineering.	8vo,	4 00
Frizzell's Water-power.	8vo,	5 00
Fuertes's Water and Public Health.	12mo,	1 50
Water-filtration Works.	12mo,	2 50
Ganguillet and Kutter's General Formula for the Uniform Flow of Water in Rivers and Other Channels. (Hering and Trautwine.)	8vo,	4 00
Hazen's Filtration of Public Water-supply.	8vo,	3 00
Hazlehurst's Towers and Tanks for Water-works.	8vo,	2 50
Herschel's 115 Experiments on the Carrying Capacity of Large, Riveted, Metal Conduits.	8vo,	2 00
Mason's Water-supply. (Considered Principally from a Sanitary Standpoint.)	8vo,	4 00
Merriman's Treatise on Hydraulics.	8vo,	5 00
* Michie's Elements of Analytical Mechanics.	8vo,	4 00
Schuyler's Reservoirs for Irrigation, Water-power, and Domestic Water- supply.	Large 8vo,	5 00
** Thomas and Watt's Improvement of Rivers. (Post., 44c. additional.)	4to,	6 00
Turneure and Russell's Public Water-supplies.	8vo,	5 00
Wegmann's Design and Construction of Dams.	4to,	5 00
Water-supply of the City of New York from 1658 to 1895.	4to,	10 00
Williams and Hazen's Hydraulic Tables.	8vo,	1 50
Wilson's Irrigation Engineering.	Small 8vo,	4 00
Wolff's Windmill as a Prime Mover.	8vo,	3 00
Wood's Turbines.	8vo,	2 50
Elements of Analytical Mechanics.	8vo,	3 00

MATERIALS OF ENGINEERING.

Baker's Treatise on Masonry Construction.	8vo,	5 00
Roads and Pavements.	8vo,	5 00
Black's United States Public Works	Oblong 4to,	5 00
* Bovey's Strength of Materials and Theory of Structures.	8vo,	7 50
Burr's Elasticity and Resistance of the Materials of Engineering.	8vo,	7 50
Byrne's Highway Construction.	8vo,	5 00
Inspection of the Materials and Workmanship Employed in Construction.	16mo,	3 00
Church's Mechanics of Engineering.	8vo,	6 00
Du Bois's Mechanics of Engineering. Vol. I.	Small 4to,	7 50
*Eckel's Cements, Limes, and Plasters.	8vo,	6 00
Johnson's Materials of Construction.	Large 8vo,	6 00
Fowler's Ordinary Foundations.	8vo,	3 50
* Greene's Structural Mechanics.	8vo,	2 50
Keep's Cast Iron.	8vo,	2 50
Lanza's Applied Mechanics.	8vo,	7 50
Marten's Handbook on Testing Materials. (Henning.) 2 vols.	8vo,	7 50
Maurer's Technical Mechanics.	8vo,	4 00
Merrill's Stones for Building and Decoration.	8vo,	5 00
Merriman's Mechanics of Materials.	8vo,	5 00
Strength of Materials	12mo,	1 00
Metcalf's Steel. A Manual for Steel-users.	12mo,	2 00
Patton's Practical Treatise on Foundations.	8vo,	5 00
Richardson's Modern Asphalt Pavements.	8vo,	3 00
Richey's Handbook for Superintendents of Construction.	16mo, mor.,	4 00
Rockwell's Roads and Pavements in France.	12mo,	1 25
Sabin's Industrial and Artistic Technology of Paints and Varnish.	8vo,	3 00
Smith's Materials of Machines.	12mo,	1 00
Snow's Principal Species of Wood.	8vo,	3 50
Spalding's Hydraulic Cement.	12mo,	2 00
Text-book on Roads and Pavements.	12mo,	2 00
Taylor and Thompson's Treatise on Concrete, Plain and Reinforced.	8vo,	5 00
Thurston's Materials of Engineering. 3 Parts.	8vo,	8 00
Part I. Non-metallic Materials of Engineering and Metallurgy.	8vo,	2 00
Part II. Iron and Steel.	8vo,	3 50
Part III. A Treatise on Brasses, Bronzes, and Other Alloys and their Constituents.	8vo,	2 50
Thurston's Text-book of the Materials of Construction.	8vo,	5 00
Tillson's Street Pavements and Paving Materials.	8vo,	4 00
Waddell's De Pontibus. (A Pocket-book for Bridge Engineers.)	16mo, mor.,	2 00
Specifications for Steel Bridges.	12mo,	1 25
Wood's (De V.) Treatise on the Resistance of Materials, and an Appendix on the Preservation of Timber.	8vo,	2 00
Wood's (De V.) Elements of Analytical Mechanics.	8vo,	3 00
Wood's (M. P.) Rustless Coatings: Corrosion and Electrolysis of Iron and Steel.	8vo,	4 00

RAILWAY ENGINEERING.

Andrew's Handbook for Street Railway Engineers.	3x5 inches, morocco,	1 25
Berg's Buildings and Structures of American Railroads	4to,	5 00
Brook's Handbook of Street Railroad Location.	16mo, morocco,	1 50
Butt's Civil Engineer's Field-book.	16mo, morocco,	2 50
Crandall's Transition Curve.	16mo, morocco,	1 50
Railway and Other Earthwork Tables.	8vo,	1 50
Dawson's "Engineering" and Electric Traction Pocket-book.	16mo, morocco,	5 00

Dredge's History of the Pennsylvania Railroad: (1879).....	Paper,	5 00
* Drinker's Tunnelling, Explosive Compounds, and Rock Drills.	4to, half mor.,	25 00
Fisher's Table of Cubic Yards.....	Cardboard,	25
Godwin's Railroad Engineers' Field-book and Explorers' Guide...	16mo, mor.,	2 50
Howard's Transition Curve Field-book.....	16mo, morocco,	1 50
Hudson's Tables for Calculating the Cubic Contents of Excavations and Embankments.....	8vo,	1 00
Molitor and Beard's Manual for Resident Engineers.....	16mo,	1 00
Nagle's Field Manual for Railroad Engineers.....	16mo, morocco,	3 00
Philbrick's Field Manual for Engineers... ?.....	16mo, morocco,	3 00
Searles's Field Engineering.....	16mo, morocco,	3 00
Railroad Spiral.....	16mo, morocco,	1 50
Taylor's Prismatical Formulæ and Earthwork.....	8vo,	1 50
* Trautwine's Method of Calculating the Cube Contents of Excavations and Embankments by the Aid of Diagrams.....	8vo,	2 00
The Field Practice of Laying Out Circular Curves for Railroads.....	12mo, morocco,	2 50
Cross-section Sheet.....	Paper,	25
Webb's Railroad Construction.....	16mo, morocco,	5 00
Wellington's Economic Theory of the Location of Railways.....	Small 8vo,	5 00

DRAWING.

Barr's Kinematics of Machinery.....	8vo,	2 50
* Bartlett's Mechanical Drawing.....	8vo,	3 00
* " " " " Abridged Ed.....	8vo,	1 50
Coolidge's Manual of Drawing.....	8vo, paper	1 00
Coolidge and Freeman's Elements of General Drafting for Mechanical Engineers.....	Oblong 4to,	2 50
Durley's Kinematics of Machines.....	8vo,	4 00
Emch's Introduction to Projective Geometry and its Applications.....	8vo,	2 50
Hill's Text-book on Shades and Shadows, and Perspective.....	8vo,	2 00
Jamison's Elements of Mechanical Drawing.....	8vo,	2 50
Advanced Mechanical Drawing.....	8vo,	2 00
Jones's Machine Design:		
Part I. Kinematics of Machinery.....	8vo,	1 50
Part II. Form, Strength, and Proportions of Parts.....	8vo,	3 00
MacCord's Elements of Descriptive Geometry.....	8vo,	3 00
Kinematics; or, Practical Mechanism.....	8vo,	5 00
Mechanical Drawing.....	4to,	4 00
Velocity Diagrams.....	8vo,	1 50
MacLeod's Descriptive Geometry.....	Small 8vo,	1 50
* Mahan's Descriptive Geometry and Stone-cutting.....	8vo,	1 50
Industrial Drawing. (Thompson.).....	8vo,	3 50
Moyer's Descriptive Geometry.....	8vo,	2 00
Reed's Topographical Drawing and Sketching.....	4to,	5 00
Reid's Course in Mechanical Drawing.....	8vo,	2 00
Text-book of Mechanical Drawing and Elementary Machine Design.....	8vo,	3 00
Robinson's Principles of Mechanism.....	8vo,	3 00
Schwamb and Merrill's Elements of Mechanism.....	8vo,	3 00
Smith's (R. S.) Manual of Topographical Drawing. (McMillan.).....	8vo,	2 50
Smith (A. W.) and Marx's Machine Design.....	8vo,	3 00
Warren's Elements of Plane and Solid Free-hand Geometrical Drawing.....	12mo,	1 00
Drafting Instruments and Operations.....	12mo,	1 25
Manual of Elementary Projection Drawing.....	12mo,	1 50
Manual of Elementary Problems in the Linear Perspective of Form and Shadow.....	12mo,	1 00
Plane Problems in Elementary Geometry.....	12mo,	1 25

Warren's Primary Geometry	12mo,	75
Elements of Descriptive Geometry, Shadows, and Perspective.	8vo,	3 50
General Problems of Shades and Shadows	8vo,	3 00
Elements of Machine Construction and Drawing.	8vo,	7 50
Problems, Theorems, and Examples in Descriptive Geometry.	8vo,	2 50
Weisbach's Kinematics and Power of Transmission. (Hermann and Klein.)	8vo,	5 00
Whelpley's Practical Instruction in the Art of Letter Engraving.	12mo,	2 00
Wilson's (H. M.) Topographic Surveying.	8vo,	3 50
Wilson's (V. T.) Free-hand Perspective.	8vo,	2 50
Wilson's (V. T.) Free-hand Lettering.	8vo,	1 00
Woolf's Elementary Course in Descriptive Geometry.	Large 8vo,	3 00

ELECTRICITY AND PHYSICS.

Anthony and Brackett's Text-book of Physics. (Magie.)	Small 8vo,	3 00
Anthony's Lecture-notes on the Theory of Electrical Measurements.	12mo,	1 00
Benjamin's History of Electricity.	8vo,	3 00
Voltaic Cell.	8vo,	3 00
Classen's Quantitative Chemical Analysis by Electrolysis. (Boltwood.)	8vo,	3 00
Crehore and Squier's Polarizing Photo-chronograph.	8vo,	3 00
Dawson's "Engineering" and Electric Traction Pocket-book.	16mo, morocco,	5 00
Dolezalek's Theory of the Lead Accumulator (Storage Battery). (Von Ende.)	12mo,	2 50
Duhem's Thermodynamics and Chemistry. (Burgess.)	8vo,	4 00
Flather's Dynamometers, and the Measurement of Power.	12mo,	3 00
Gilbert's De Magnete. (Mottelay.)	8vo,	2 50
Hanchett's Alternating Currents Explained.	12mo,	1 00
Hering's Ready Reference Tables (Conversion Factors).	16mo, morocco,	2 50
Holman's Precision of Measurements.	8vo,	2 00
Telescopic Mirror-scale Method, Adjustments, and Tests.	Large 8vo,	75
Kinzbrunner's Testing of Continuous-current Machines.	8vo,	2 00
Landauer's Spectrum Analysis. (Tingle.)	8vo,	3 00
Le Chatelier's High-temperature Measurements. (Boudouard—Burgess.)	12mo,	3 00
Löb's Electrochemistry of Organic Compounds. (Lorenz.)	8vo,	3 00
* Lyons's Treatise on Electromagnetic Phenomena. Vols. I. and II.	8vo, each,	6 00
* Michie's Elements of Wave Motion Relating to Sound and Light.	8vo,	4 00
Niaudet's Elementary Treatise on Electric Batteries. (Fishback.)	12mo,	2 50
* Rosenberg's Electrical Engineering. (Haldane Gee—Kinzbrunner.)	8vo,	1 50
Ryan, Norris, and Hoxie's Electrical Machinery. Vol. I.	8vo,	2 50
Thurston's Stationary Steam-engines.	8vo,	2 50
* Tillman's Elementary Lessons in Heat.	8vo,	1 50
Tory and Pitcher's Manual of Laboratory Physics.	Small 8vo,	2 00
Ulke's Modern Electrolytic Copper Refining.	8vo,	3 00

LAW.

* Davis's Elements of Law.	8vo,	2 50
* Treatise on the Military Law of United States.	8vo,	7 00
*	Sheep,	7 50
Manual for Courts-martial.	16mo, morocco,	1 50
Wait's Engineering and Architectural Jurisprudence.	8vo,	6 00
.	Sheep,	6 50
Law of Operations Preliminary to Construction in Engineering and Architecture.	8vo	5 00
.	Sheep,	5 50
Law of Contracts.	8vo,	3 00
Winthrop's Abridgment of Military Law.	12mo,	2 50

MANUFACTURES.

Bernadou's Smokeless Powder—Nitro-cellulose and Theory of the Cellulose Molecule.	12mo,	2 50
Bolland's Iron Founder.	12mo,	2 50
"The Iron Founder," Supplement.	12mo,	2 50
Encyclopedia of Founding and Dictionary of Foundry Terms Used in the Practice of Moulding.	12mo,	3 00
Eissler's Modern High Explosives.	8vo,	4 00
Effront's Enzymes and their Applications. (Prescott.)	8vo,	3 00
Fitzgerald's Boston Machinist.	12mo,	1 00
Ford's Boiler Making for Boiler Makers.	18mo,	1 00
Hopkin's Oil-chemists' Handbook.	8vo,	3 00
Keep's Cast Iron.	8vo,	2 50
Leach's The Inspection and Analysis of Food with Special Reference to State Control.	Large 8vo,	7 50
Matthews's The Textile Fibres.	8vo,	3 50
Metcalf's Steel. A Manual for Steel-users.	12mo,	2 00
Metcalf's Cost of Manufactures—And the Administration of Workshops.	8vo,	5 00
Meyer's Modern Locomotive Construction.	4to,	10 00
Morse's Calculations used in Cane-sugar Factories.	16mo, morocco,	1 50
* Reisig's Guide to Piece-dyeing.	8vo,	25 00
Sabin's Industrial and Artistic Technology of Paints and Varnish.	8vo,	3 00
Smith's Press-working of Metals.	8vo,	3 00
Spalding's Hydraulic Cement.	12mo,	2 00
Spencer's Handbook for Chemists of Beet-sugar Houses.	16mo, morocco,	3 00
Handbook for Cane Sugar Manufacturers.	16mo, morocco,	3 00
Taylor and Thompson's Treatise on Concrete, Plain and Reinforced.	8vo,	5 00
Thurston's Manual of Steam-boilers, their Designs, Construction and Operation.	8vo,	5 00
* Walke's Lectures on Explosives.	8vo,	4 00
Ware's Beet-sugar Manufacture and Refining.	Small 8vo,	4 00
West's American Foundry Practice.	12mo,	2 50
Moulder's Text-book.	12mo,	2 50
Wolff's Windmill as a Prime Mover	8vo,	3 00
Wood's Rustless Coatings: Corrosion and Electrolysis of Iron and Steel.	8vo,	4 00

MATHEMATICS.

Baker's Elliptic Functions.	8vo,	1 50
* Bass's Elements of Differential Calculus.	12mo,	4 00
Briggs's Elements of Plane Analytic Geometry.	12mo,	1 00
Compton's Manual of Logarithmic Computations.	12mo,	1 50
Davis's Introduction to the Logic of Algebra.	8vo,	1 50
* Dickson's College Algebra.	Large 12mo,	1 50
* Introduction to the Theory of Algebraic Equations.	Large 12mo,	1 25
Emch's Introduction to Projective Geometry and its Applications.	8vo,	2 50
Halsted's Elements of Geometry.	8vo,	1 75
Elementary Synthetic Geometry.	8vo,	1 50
Rational Geometry.	12mo,	1 75
* Johnson's (J. B.) Three-place Logarithmic Tables: Vest-pocket size, paper,	100 copies for	5 00
* Mounted on heavy cardboard, 8×10 inches,	10 copies for	2 00
Johnson's (W. W.) Elementary Treatise on Differential Calculus.	Small 8vo,	3 00
Johnson's (W. W.) Elementary Treatise on the Integral Calculus.	Small 8vo,	1 50

Johnson's (W. W.) Curve Tracing in Cartesian Co-ordinates.	12mo,	1 00
Johnson's (W. W.) Treatise on Ordinary and Partial Differential Equations.	Small 8vo,	3 50
Johnson's (W. W.) Theory of Errors and the Method of Least Squares.	12mo,	1 50
* Johnson's (W. W.) Theoretical Mechanics.	12mo,	3 00
Laplace's Philosophical Essay on Probabilities. (Truscott and Emory.)	12mo,	2 00
* Ludlow and Bass. Elements of Trigonometry and Logarithmic and Other Tables.	8vo,	3 00
Trigonometry and Tables published separately.	Each,	2 00
* Ludlow's Logarithmic and Trigonometric Tables.	8vo,	1 00
Mathematical Monographs. Edited by Mansfield Merriman and Robert S. Woodward.	Octavo, each	1 00
No. 1. History of Modern Mathematics, by David Eugene Smith.		
No. 2. Synthetic Projective Geometry, by George Bruce Halsted.		
No. 3. Determinants, by Laenas Gifford Weld. No. 4. Hyperbolic Functions, by James McMahon. No. 5. Harmonic Functions, by William E. Byerly. No. 6. Grassmann's Space Analysis, by Edward W. Hyde. No. 7. Probability and Theory of Errors, by Robert S. Woodward. No. 8. Vector Analysis and Quaternions, by Alexander Macfarlane. No. 9. Differential Equations, by William Woolsey Johnson. No. 10. The Solution of Equations, by Mansfield Merriman. No. 11. Functions of a Complex Variable, by Thomas S. Fiske.		
Maurer's Technical Mechanics.	8vo,	4 00
Merriman and Woodward's Higher Mathematics.	8vo,	5 00
Merriman's Method of Least Squares.	8vo,	2 00
Rice and Johnson's Elementary Treatise on the Differential Calculus. Sm. 8vo,		3 00
Differential and Integral Calculus. 2 vols. in one.	Small 8vo,	2 50
Wood's Elements of Co-ordinate Geometry.	8vo,	2 00
Trigonometry: Analytical, Plane, and Spherical	12mo,	1 00

MECHANICAL ENGINEERING.

MATERIALS OF ENGINEERING, STEAM-ENGINES AND BOILERS.

Bacon's Forge Practice.	12mo,	1 50
Baldwin's Steam Heating for Buildings.	12mo,	2 50
Barr's Kinematics of Machinery.	8vo,	2 50
* Bartlett's Mechanical Drawing.	8vo,	3 00
* " " " Abridged Ed.	8vo,	1 50
Benjamin's Wrinkles and Recipes.	12mo,	2 00
Carpenter's Experimental Engineering.	8vo,	6 00
Heating and Ventilating Buildings.	8vo,	4 00
Cary's Smoke Suppression in Plants using Bituminous Coal. (In Preparation.)		
Clerk's Gas and Oil Engine.	Small 8vo,	4 00
Coolidge's Manual of Drawing.	8vo, paper,	1 00
Coolidge and Freeman's Elements of General Drafting for Mechanical Engineers.	Oblong 4to,	2 50
Cromwell's Treatise on Toothed Gearing.	12mo,	1 50
Treatise on Belts and Pulleys.	12mo,	1 50
Durley's Kinematics of Machines.	8vo,	4 00
Flather's Dynamometers and the Measurement of Power.	12mo,	3 00
Rope Driving.	12mo,	2 00
Gill's Gas and Fuel Analysis for Engineers.	12mo,	1 25
Hall's Car Lubrication.	12mo,	1 00
Hering's Ready Reference Tables (Conversion Factors).	16mo, morocco,	2 50

Hutton's The Gas Engine.	8vo,	5 00
Jamison's Mechanical Drawing.	8vo,	2 50
Jones's Machine Design:		
Part I. Kinematics of Machinery.	8vo,	1 50
Part II. Form, Strength, and Proportions of Parts.	8vo,	3 00
Kent's Mechanical Engineers' Pocket-book.	16mo, morocco,	5 00
Kerr's Power and Power Transmission.	8vo,	2 00
Leonard's Machine Shop, Tools, and Methods.	8vo,	4 00
* Lorenz's Modern Refrigerating Machinery. (Pope, Haven, and Dean.)	8vo,	4 00
MacCord's Kinematics; or, Practical Mechanism.	8vo,	5 00
Mechanical Drawing.	4to,	4 00
Velocity Diagrams.	8vo,	1 50
MacFarland's Standard Reduction Factors for Gases.	8vo,	1 50
Mahan's Industrial Drawing. (Thompson.)	8vo,	3 50
Poole's Calorific Power of Fuels.	8vo,	3 00
Reid's Course in Mechanical Drawing.	8vo,	2 00
Text-book of Mechanical Drawing and Elementary Machine Design.	8vo,	3 00
Richard's Compressed Air	12mo,	1 50
Robinson's Principles of Mechanism.	8vo,	3 00
Schwamb and Merrill's Elements of Mechanism.	8vo,	3 00
Smith's (O.) Press-working of Metals.	8vo,	3 00
Smith (A. W.) and Marx's Machine Design.	8vo,	3 00
Thurston's Treatise on Friction and Lost Work in Machinery and Mill Work.	8vo,	3 00
Animal as a Machine and Prime Motor, and the Laws of Energetics.	12mo,	1 00
Warren's Elements of Machine Construction and Drawing.	8vo,	7 50
Weisbach's Kinematics and the Power of Transmission. (Herrmann— Klein.)	8vo,	5 00
Machinery of Transmission and Governors. (Herrmann—Klein.)	8vo,	5 00
Wolf's Windmill as a Prime Mover.	8vo,	3 00
Wood's Turbines.	8vo,	2 50

MATERIALS OF ENGINEERING.

* Bovey's Strength of Materials and Theory of Structures.	8vo,	7 50
Burr's Elasticity and Resistance of the Materials of Engineering. 6th Edition. Reset.	8vo,	7 50
Church's Mechanics of Engineering.	8vo,	6 00
* Greene's Structural Mechanics	8vo,	2 50
Johnson's Materials of Construction.	8vo,	6 00
Keep's Cast Iron.	8vo,	2 50
Lanza's Applied Mechanics.	8vo,	7 50
Martens's Handbook on Testing Materials. (Henning.)	8vo,	7 50
Maurer's Technical Mechanics.	8vo,	4 00
Merriman's Mechanics of Materials.	8vo,	5 00
Strength of Materials	12mo,	1 00
Metcalf's Steel. A manual for Steel-users.	12mo,	2 00
Sabin's Industrial and Artistic Technology of Paints and Varnish.	8vo,	3 00
Smith's Materials of Machines.	12mo,	1 00
Thurston's Materials of Engineering.	3 vols., 8vo,	8 00
Part II. Iron and Steel.	8vo,	3 50
Part III. A Treatise on Brasses, Bronzes, and Other Alloys and their Constituents.	8vo,	2 50
Text-book of the Materials of Construction.	8vo,	5 00
Wood's (De V.) Treatise on the Resistance of Materials and an Appendix on the Preservation of Timber.	8vo,	2 00

Wood's (De V.) Elements of Analytical Mechanics.	8vo,	3 00
Wood's (M. P.) Rustless Coatings: Corrosion and Electrolysis of Iron and Steel.	8vo,	4 00

STEAM-ENGINES AND BOILERS.

Berry's Temperature-entropy Diagram.	12mo,	1 25
Carnot's Reflections on the Motive Power of Heat. (Thurston.).	12mo,	1 50
Dawson's "Engineering" and Electric Traction Pocket-book.	16mo, mor.,	5 00
Ford's Boiler Making for Boiler Makers.	18mo,	1 00
Goss's Locomotive Sparks.	8vo,	2 00
Hemenway's Indicator Practice and Steam-engine Economy.	12mo,	2 00
Hutton's Mechanical Engineering of Power Plants.	8vo,	5 00
Heat and Heat-engines.	8vo,	5 00
Kent's Steam boiler Economy.	8vo,	4 00
Kneass's Practice and Theory of the Injector.	8vo,	1 50
MacCord's Slide-valves.	8vo,	2 00
Meyer's Modern Locomotive Construction.	4to,	10 00
Peabody's Manual of the Steam-engine Indicator.	12mo,	1 50
Tables of the Properties of Saturated Steam and Other Vapors.	8vo,	1 00
Thermodynamics of the Steam-engine and Other Heat-engines.	8vo,	5 00
Valve-gears for Steam-engines.	8vo,	2 50
Peabody and Miller's Steam-boilers.	8vo,	4 00
Pray's Twenty Years with the Indicator.	Large 8vo,	2 50
Pupin's Thermodynamics of Reversible Cycles in Gases and Saturated Vapors. (Osterberg.).	12mo,	1 25
Reagan's Locomotives: Simple Compound, and Electric.	12mo,	2 50
Rontgen's Principles of Thermodynamics. (Du Bois.).	8vo,	5 00
Sinclair's Locomotive Engine Running and Management.	12mo,	2 00
Smart's Handbook of Engineering Laboratory Practice.	12mo,	2 50
Snow's Steam-boiler Practice.	8vo,	3 00
Spangler's Valve-gears.	8vo,	2 50
Notes on Thermodynamics.	12mo,	1 00
Spangler, Greene, and Marshall's Elements of Steam-engineering.	8vo,	3 00
Thurston's Handy Tables.	8vo,	1 50
Manual of the Steam-engine.	2 vols., 8vo,	10 00
Part I. History, Structure, and Theory.	8vo,	6 00
Part II. Design, Construction, and Operation.	8vo,	6 00
Handbook of Engine and Boiler Trials, and the Use of the Indicator and the Prony Brake.	8vo,	5 00
Stationary Steam-engines.	8vo,	2 50
Steam-boiler Explosions in Theory and in Practice.	12mo,	1 50
Manual of Steam-boilers, their Designs, Construction, and Operation.	8vo,	5 00
Weisbach's Heat, Steam, and Steam-engines. (Du Bois.).	8vo,	5 00
Whitham's Steam-engine Design.	8vo,	5 00
Wilson's Treatise on Steam-boilers. (Flather.).	16mo,	2 50
Wood's Thermodynamics, Heat Motors, and Refrigerating Machines.	8vo,	4 00

MECHANICS AND MACHINERY.

Barr's Kinematics of Machinery.	8vo,	2 50
* Bovey's Strength of Materials and Theory of Structures.	8vo,	7 50
Chase's The Art of Pattern-making.	12mo,	2 50
Church's Mechanics of Engineering.	8vo,	6 00
Notes and Examples in Mechanics.	8vo,	2 00
Compton's First Lessons in Metal-working.	12mo,	1 50
Compton and De Groodt's The Speed Lathe.	12mo,	1 50

Cromwell's Treatise on Toothed Gearing	12mo,	1 50
Treatise on Belts and Pulleys	12mo,	1 50
Dana's Text-book of Elementary Mechanics for Colleges and Schools	12mo,	1 50
Dingey's Machinery Pattern Making	12mo,	2 00
Dredge's Record of the Transportation Exhibits Building of the World's Columbian Exposition of 1893	4to half morocco,	5 00
Du Bois's Elementary Principles of Mechanics:		
Vol. I. Kinematics	8vo,	3 50
Vol. II. Statics	8vo,	4 00
Mechanics of Engineering. Vol. I.	Small 4to,	7 50
Vol. II.	Small 4to,	10 00
Durley's Kinematics of Machines	8vo,	4 00
Fitzgerald's Boston Machinist	16mo,	1 00
Flather's Dynamometers, and the Measurement of Power	12mo,	3 00
Rope Driving	12mo,	2 00
Goss's Locomotive Sparks	8vo,	2 00
* Greene's Structural Mechanics	8vo,	2 50
Hall's Car Lubrication	12mo,	1 00
Holly's Art of Saw Filing	18mo,	75
James's Kinematics of a Point and the Rational Mechanics of a Particle	Small 8vo,	2 00
* Johnson's (W. W.) Theoretical Mechanics	12mo,	3 00
Johnson's (L. J.) Statics by Graphic and Algebraic Methods	8vo,	2 00
Jones's Machine Design:		
Part I. Kinematics of Machinery	8vo,	1 50
Part II. Form, Strength, and Proportions of Parts	8vo,	3 00
Kerr's Power and Power Transmission	8vo,	2 00
Lanza's Applied Mechanics	8vo,	7 50
Leonard's Machine Shop, Tools, and Methods	8vo,	4 00
* Lorenz's Modern Refrigerating Machinery. (Pope, Haven, and Dean.)	8vo,	4 00
MacCord's Kinematics; or, Practical Mechanism	8vo,	5 00
Velocity Diagrams	8vo,	1 50
Maurer's Technical Mechanics	8vo,	4 00
Merriman's Mechanics of Materials	8vo,	5 00
* Elements of Mechanics	12mo,	1 00
* Michie's Elements of Analytical Mechanics	8vo,	4 00
Reagan's Locomotives: Simple, Compound, and Electric	12mo,	2 50
Reid's Course in Mechanical Drawing	8vo,	2 00
Text-book of Mechanical Drawing and Elementary Machine Design	8vo,	3 00
Richards's Compressed Air	12mo,	1 50
Robinson's Principles of Mechanism	8vo,	3 00
Ryan, Norris, and Hoxie's Electrical Machinery. Vol. I.	8vo,	2 50
Schwamb and Merrill's Elements of Mechanism	8vo,	3 00
Sinclair's Locomotive-engine Running and Management	12mo,	2 00
Smith's (O.) Press-working of Metals	8vo,	3 00
Smith's (A. W.) Materials of Machines	12mo,	1 00
Smith (A. W.) and Marx's Machine Design	8vo,	3 00
Spangler, Greene, and Marshal's Elements of Steam-engineering	8vo,	3 00
Thurston's Treatise on Friction and Lost Work in Machinery and Mill Work	8vo,	3 00
Animal as a Machine and Prime Motor, and the Laws of Energetics	12mo,	1 00
Warren's Elements of Machine Construction and Drawing	8vo,	7 50
Weisbach's Kinematics and Power of Transmission. (Herrmann—Klein.)	8vo,	5 00
Machinery of Transmission and Governors. (Herrmann—Klein.)	8vo,	5 00
Wood's Elements of Analytical Mechanics	8vo,	3 00
Principles of Elementary Mechanics	12mo,	1 25
Turbines	8vo,	2 50
The World's Columbian Exposition of 1893	4to,	1 00

METALLURGY.

Egleston's Metallurgy of Silver, Gold, and Mercury:		
Vol. I. Silver.	8vo,	7 50
Vol. II. Gold and Mercury.	8vo,	7 50
** Iles's Lead-smelting. (Postage 9 cents additional).	12mo,	2 50
Keep's Cast Iron.	8vo,	2 50
Kunhardt's Practice of Ore Dressing in Europe.	8vo,	1 50
Le Chatelier's High-temperature Measurements. (Boudouard—Burgess.)	12mo,	3 00
Metcalf's Steel. A Manual for Steel-users.	12mo,	2 00
Minet's Production of Aluminum and its Industrial Use. (Waldo.)	12mo,	2 50
Robine and Lenglen's Cyanide Industry. (Le Clerc.)	8vo,	
Smith's Materials of Machines.	12mo,	1 00
Thurston's Materials of Engineering. In Three Parts.	8vo,	8 00
Part II. Iron and Steel.	8vo,	3 50
Part III. A Treatise on Brasses, Bronzes, and Other Alloys and their Constituents.	8vo,	2 50
Ulke's Modern Electrolytic Copper Refining.	8vo,	3 00

MINERALOGY.

Barringer's Description of Minerals of Commercial Value. Oblong, morocco.	2 50
Boyd's Resources of Southwest Virginia.	8vo, 3 00
Map of Southwest Virginia.	Pocket-book form.
Brush's Manual of Determinative Mineralogy. (Penfield.)	8vo, 4 00
Chester's Catalogue of Minerals.	8vo, paper, 1 00
	Cloth, 1 25
Dictionary of the Names of Minerals.	8vo, 3 50
Dana's System of Mineralogy.	Large 8vo, half leather, 12 50
First Appendix to Dana's New "System of Mineralogy."	Large 8vo, 1 00
Text-book of Mineralogy.	8vo, 4 00
Minerals and How to Study Them	12mo, 1 50
Catalogue of American Localities of Minerals.	Large 8vo, 1 00
Manual of Mineralogy and Petrography.	12mo, 2 00
Douglas's Untechnical Addresses on Technical Subjects.	12mo, 1 00
Eakle's Mineral Tables.	8vo, 1 25
Egleston's Catalogue of Minerals and Synonyms.	8vo, 2 50
Hussak's The Determination of Rock-forming Minerals. (Smith.)	Small 8vo, 2 00
Merrill's Non-metallic Minerals: Their Occurrence and Uses.	8vo, 4 00
* Penfield's Notes on Determinative Mineralogy and Record of Mineral Tests.	8vo, paper, 50
Rosenbusch's Microscopical Physiography of the Rock-making Minerals. (Iddings.)	8vo, 5 00
* Tillman's Text-book of Important Minerals and Rocks.	8vo, 2 00

MINING.

Beard's Ventilation of Mines.	12mo, 2 50
Boyd's Resources of Southwest Virginia.	8vo, 3 00
Map of Southwest Virginia.	Pocket-book form. 2 00
Douglas's Untechnical Addresses on Technical Subjects.	12mo, 1 00
* Drinker's Tunneling, Explosive Compounds, and Rock Drills.	4to, hf. mor., 25 00
Eissler's Modern High Explosives.	8vo, 4 00

Fowler's Sewage Works Analyses.....	12mo,	2 00
Goodyear's Coal-mines of the Western Coast of the United States.....	12mo,	2 50
Ihlseng's Manual of Mining.....	8vo,	5 00
** Iles's Lead-smelting. (Postage 9c. additional.).....	12mo,	2 50
Kunhardt's Practice of Ore Dressing in Europe.....	8vo,	1 50
O'Driscoll's Notes on the Treatment of Gold Ores.....	8vo,	2 00
Robine and Lenglen's Cyanide Industry. (Le Clerc.).....	8vo,	
* Walke's Lectures on Explosives.....	8vo,	4 00
Wilson's Cyanide Processes.....	12mo,	1 50
Chlorination Process.....	12mo,	1 50
Hydraulic and Placer Mining.....	12mo,	2 00
Treatise on Practical and Theoretical Mine Ventilation.....	12mo,	1 25

SANITARY SCIENCE.

Bashore's Sanitation of a Country House.....	12mo,	1 00
Folwell's Sewerage. (Designing, Construction, and Maintenance.)....	8vo,	3 00
Water-supply Engineering.....	8vo,	4 00
Fuertes's Water and Public Health.....	12mo,	1 50
Water-filtration Works.....	12mo,	2 50
Gerhard's Guide to Sanitary House-inspection.....	16mo,	1 00
Goodrich's Economic Disposal of Town's Refuse.....	Demy 8vo,	3 50
Hazen's Filtration of Public Water-supplies.....	8vo,	3 00
Leach's The Inspection and Analysis of Food with Special Reference to State Control.....	8vo,	7 50
Mason's Water-supply. (Considered principally from a Sanitary Standpoint) 8vo,	8vo,	4 00
Examination of Water. (Chemical and Bacteriological.).....	12mo,	1 25
Ogden's Sewer Design.....	12mo,	2 00
Prescott and Winslow's Elements of Water Bacteriology, with Special Reference to Sanitary Water Analysis.....	12mo,	1 25
* Price's Handbook on Sanitation.....	12mo,	1 50
Richards's Cost of Food. A Study in Dietsaries.....	12mo,	1 00
Cost of Living as Modified by Sanitary Science.....	12mo,	1 00
Richards and Woodman's Air, Water, and Food from a Sanitary Standpoint.....	8vo,	2 00
* Richards and Williams's The Dietary Computer.....	8vo,	1 50
Rideal's Sewage and Bacterial Purification of Sewage.....	8vo,	3 50
Turneure and Russell's Public Water-supplies.....	8vo,	5 00
Von Behring's Suppression of Tuberculosis. (Bolduan.).....	12mo,	1 00
Whipple's Microscopy of Drinking-water.....	8vo,	3 50
Winton's Microscopy of Vegetable Foods.....	8vo,	7 50
Woodhull's Notes on Military Hygiene.....	16mo,	1 50

MISCELLANEOUS.

De Fursac's Manual of Psychiatry. (Rosanoff and Collins.)....	Large 12mo,	2 50
Emmons's Geological Guide-book of the Rocky Mountain Excursion of the International Congress of Geologists.....	Large 8vo,	1 50
Ferrel's Popular Treatise on the Winds.....	8vo,	4 00
Haines's American Railway Management.....	12mo,	2 50
Mott's Fallacy of the Present Theory of Sound.....	16mo,	1 00
Ricketts's History of Rensselaer Polytechnic Institute, 1824-1894. Small 8vo,	8vo,	3 00
Rostoski's Serum Diagnosis. (Bolduan.).....	12mo,	1 00
Rotherham's Emphasized New Testament.....	Large 8vo,	2 00

Steel's Treatise on the Diseases of the Dog.8vo.	3 50
The World's Columbian Exposition of 18934to,	1 00
Von Behring's Suppression of Tuberculosis. (Bolduan.)12mo,	1 00
Winslow's Elements of Applied Microscopy12mo,	1 50
Worcester and Atkinson. Small Hospitals, Establishment and Maintenance; Suggestions for Hospital Architecture: Plans for Small Hospital. 12mo,		1 25

HEBREW AND CHALDEE TEXT-BOOKS.

Green's Elementary Hebrew Grammar.....	.12mo,	1 25
Hebrew Chrestomathy.8vo,	2 00
Gesenius's Hebrew and Chaldee Lexicon to the Old Testament Scriptures. (Tregelles.)	Small 4to, half morocco,	5 00
Letteris's Hebrew Bible.8vo,	2 25















LIBRARY OF CONGRESS



0 021 218 400 7