

The Natural History
of Animals

E 88 A 403



NUTHATCHES (*SITTA CAESIA*) FEEDING YOUNG

NUTHATCHES (*Sitta casia*) FEEDING YOUNG

The dominance of Birds in the vertebrate fauna of the world is largely due to their strongly developed parental instincts, by which the safety of eggs and young are secured. Such care is essential in cases where the nestlings are helpless, as in Perching Birds (*Passeres*), of which the Nuthatch is here taken as an illustration. This species is essentially a tree-form, and feeds upon insects during the greater part of the year, but when nuts, beech-mast, &c., are ripe, these constitute the chief article of diet. A nut is opened by being placed in a suitable crevice, and then cleft by the strong pointed beak. For nesting purposes a cavity in a trunk or branch is selected, and the opening plastered up with clay, leaving only a small round hole by way of door. The eggs are laid upon a heap of leaves or bark-scales within this cavity, and the parental duties of the old birds terminate soon after the young are fledged.

The
Natural History
of Animals

The Animal Life of the World in its various
Aspects and Relations

BY

J. R. AINSWORTH DAVIS, M.A.

TRINITY COLLEGE, CAMBRIDGE

PROFESSOR IN THE UNIVERSITY OF WALES, AND PROFESSOR OF ZOOLOGY AND
GEOLOGY IN UNIVERSITY COLLEGE, ABERYSTWYTH

HALF-VOL. VI

LONDON
THE GRESHAM PUBLISHING COMPANY
34 SOUTHAMPTON STREET, STRAND

CONTENTS

HALF-VOL. VI

ANIMAL MOVEMENT (*Continued*)

CHAPTER LI.—ANIMAL LOCOMOTION—PARACHUTING AND KITE-FLYING

PARACHUTING

| | Page |
|--|------|
| MAMMALS (MAMMALIA) AS PARACHUTISTS.—Insect-eating Mammals (Insectivora) —The Colugo or “Flying-Lemur” (<i>Galeopithecus</i>). Gnawing Mammals (Rodentia)—Asiatic “Flying”-Squirrels, Brown Flying-Squirrel (<i>Pteromys</i> <i>petaurista</i>); Small “Flying”-Squirrels, American Flying-Squirrel (<i>Sciuropterus</i> <i>volucella</i>); African “Flying”-Squirrels (<i>Anomaluridæ</i>), Gold Coast Species (<i>Anomalurus peli</i>), Non-parachuting Species (<i>Aëthurus glirinus</i>). Pouched Mammals (Marsupialia)—“Flying” Phalangers—Sugar Squirrel (<i>Petaurus</i> <i>sciureus</i>), Taguan (<i>Petauroides volans</i>), Flying-Mouse (<i>Acrobates pygmaeus</i>) - | 281 |
| BIRDS (AVES) AS PARACHUTISTS—Pigeon (<i>Columba livia</i>) - - - - - | 286 |
| REPTILES (REPTILIA) AS PARACHUTISTS—Fringed Gecko (<i>Ptychozöön homalo-</i> <i>cephalum</i>), “Flying”-Dragons (<i>Draco volans</i> , &c.) - - - - - | 286 |
| AMPHIBIANS (AMPHIBIA) AS PARACHUTISTS (?)—“Flying”-Frogs (<i>Rhacophorus</i>) - | 287 |
| FISHES (PISCES) AS PARACHUTISTS—“Flying”-Fishes (<i>Exocoetus</i>) - - - | 288 |
| SPIDERS (ARACHNIDA) AS PARACHUTISTS—Australian “Flying”-Spider (<i>Attus</i> | 289 |

KITE-FLYING

| | |
|--|-----|
| Wings and Parachutes as Kites. Larva of a Fly (<i>Hirmonoura obscura</i>) blown away by the wind - - - - - | 289 |
| SPIDERS (ARACHNIDA) AS KITE-FLYERS—Gossamers - - - - - | 290 |
| TWO-WINGED FLIES (DIPTERA) AS KITE-FLYERS—Dancing-Flies (<i>Empidæ</i>), Species of <i>Hilara</i> - - - - - | 291 |

CHAPTER LII.—MUSCULAR LOCOMOTION—FLYING MAMMALS
(MAMMALIA), BIRDS (AVES), AND REPTILES (REPTILIA)

| | Page |
|--|------|
| THE FLIGHT OF BATS (CHIROPTERA)—Structure of Flying-Organs and Mode of Flight. Evolution of the Habit. Wide Distribution | 292 |
| THE FLIGHT OF BIRDS (AVES)—Structure of Birds in Relation to Flight: Comparison with Bats. Evolution of the Habit, <i>Archæopteryx</i> . Feathers. Skeleton. Muscles of Flight | 295 |
| Active Flight: The Flying Mechanism in Action. Steering and Stopping. Speed and Endurance—Pigeons (<i>Columba livia</i>), Swallows (<i>Hirundo</i>), Swifts (<i>Cypselus</i>), American Golden Plover (<i>Charadrius Virginicus</i>) | 302 |
| Passive Flight: Gliding, how effected—Gulls, Pigeons, Falcons. Soaring of Birds of Prey, Crows, Pelicans, and Storks. Theories of Soaring | 305 |
| THE FLIGHT OF REPTILES (REPTILIA)—Extinct Flying Reptiles (<i>Pterosauria</i>) | 308 |
| THE FLIGHT OF INSECTS (INSECTA)—Structure in Relation to Flight. The Flying Mechanism in Action. Modification of the Wings in different Insects—Dragon-Flies, Bees, Moths, Flies, Beetles, Stylops, Fleas, Lice. Evolution of the Wings | 309 |

ANIMAL DEVELOPMENT

CHAPTER LIII.—ANIMAL DEVELOPMENT—GENERAL
PRINCIPLES—VEGETATIVE REPRODUCTION

| | |
|---|-----|
| GENERAL PRINCIPLES—New Individuals Produced by Overgrowth. Gradual Development to Adult Stage by Processes of Growth | 316 |
| VEGETATIVE PROPAGATION—Nature of Cells. Contrast between Animalcules or One-celled Animals (Protozoa) and Many-celled Animals (Metazoa) | 317 |
| VEGETATIVE PROPAGATION IN ANIMALCULES (PROTOZOA)—Splitting (Fission)—Proteus Animalcule (<i>Amæba</i>), Trumpet-Animalcule (<i>Stentor</i>), Bell-Animalcule (<i>Vorticella</i>). Budding (Gemination)—External Buds of Suctoria, <i>Ephelota gemmipara</i> ; Internal Buds of Suctoria, <i>Tokophrya quadripartata</i> . Spore-Formation—Multiple Fission, Spores, Cysts; Spore-Animalcules (Sporozoa); Fungus-Animalcules (Mycetozoa); Life-History of <i>Colpoda cucullus</i> . Conjugation of Animalcules—Slipper-Animalcule (<i>Paramæcium</i>), Bell-Animalcule (<i>Vorticella</i>) | 318 |
| VEGETATIVE PROPAGATION AND REGENERATION IN SPONGES (PORIFERA)—Production of Colonies. External Buds of <i>Polyophus</i> , &c. Internal Buds of Freshwater Sponge (<i>Spongilla</i>). Artificial Cuttings of Bath Sponge (<i>Euspongia</i>) | 325 |
| VEGETATIVE PROPAGATION AND REGENERATION IN ZOOPHYTES (CÆLENTERATA)—Budding of Freshwater Polype (<i>Hydra</i>). Colonial Hydrozoa. Budding, Fission, and Laceration of Sea-Anemones. Simple and Colonial Corals. Regenerative Powers of Freshwater Polype (<i>Hydra</i>), &c. | 327 |
| VEGETATIVE PROPAGATION AND REGENERATION IN HEDGEHOG-SKINNED ANIMALS (ECHINODERMATA)—Regenerative Powers. "Comet" Star-Fishes. Fission in certain Star-Fishes (<i>Linckiida</i>) | 328 |

CONTENTS

vii

Page

| | |
|--|-----|
| <p>VEGETATIVE PROPAGATION AND REGENERATION IN FLAT-WORMS (PLATY-HELMIA)—Flukes and Tapeworms. Planarian Worms—<i>Microstomum</i> - -</p> | 329 |
| <p>VEGETATIVE PROPAGATION AND REGENERATION IN BRISTLE-WORMS (PODA)—Possible Meaning of Segmentation. Regenerative Powers. Chains Formed by Budding. Lateral Budding of <i>Syllis ramosa</i> - - - -</p> | 329 |
| <p>•VEGETATIVE PROPAGATION AND REGENERATION IN MOSS-POLYPPES (POLYZOA)—Formation of Colonies by Budding. External Winter-Buds, Internal Winter-Buds (Statoblasts). Regenerative Powers - - - -</p> | 330 |
| <p>VEGETATIVE PROPAGATION AND REGENERATION IN THE HIGHER GROUPS OF MANY-CELLED ANIMALS (METAZOA)—Regenerative Powers of Molluscs, Arthropods, and Vertebrates. Budding of Ascidians or Sea-Squirts (Urochorda)</p> | 331 |

CHAPTER LIV.—ANIMAL DEVELOPMENT—PROPAGATION BY MEANS OF EGGS

| | |
|---|-----|
| <p>DEVELOPMENT FROM EGGS IN ANIMALCULES (PROTOZOA)—Origin of Many-celled Animals (Metazoa) from Colonial Animalcules (Protozoa). Division of Physiological Labour. Evolution of Tissues. Life-History of <i>Volvox</i>, a Colonial Animalcule - - - -</p> | 333 |
| <p>DEVELOPMENT OF EGGS IN MANY-CELLED ANIMALS (METAZOA)—Ontogeny and Phylogeny. Preformation and Epigenesis. Polar Bodies. Law of Recapitulation. Cleavage or Segmentation of the Embryo. The Blastula. Development of the Freshwater Polype (<i>Hydra</i>). The Gastrula,—Gastræa Theory. Development of a Sponge. Development of the Lancelet (<i>Amphioxus</i>). Influence of Food-Yolk on Development - - - -</p> | 335 |

ANIMAL LIFE-HISTORIES—PROTECTION OF EGGS AND YOUNG—ANIMAL DWELLINGS

CHAPTER LV.—LIFE-HISTORIES, &c., OF BACKBONELESS ANIMALS (INVERTEBRATA)

| | |
|---|-----|
| <p>LIFE-HISTORIES, &c., OF ZOOPHYTES (CÆLENTERATA)—Alternation of Generations in Hydroid Zoophytes. Evolution of Jelly-Fishes (Medusæ), and Stages in their Degeneration. Life-History of <i>Aurelia</i>. Nursing of Eggs and Embryos in Jelly-Fishes, Sea-Anemones, and Corals. The Planula Larva -</p> | 349 |
| <p>LIFE-HISTORIES, &c., OF HEDGEHOG-SKINNED ANIMALS (ECHINODERMATA)—Larval Forms. Life-History of Brittle-Stars (<i>Ophiuroidea</i>): the Pluteus Larva: Direct Development and Nursing of Embryos in certain Brittle-Stars (e.g. <i>Amphiura squamata</i>). Pluteus Larva of Sea-Urchins (<i>Echinoidea</i>): Nursing of Embryos in <i>Hemiaster</i>: Burrowing Sea-Urchins. Ordinary Star-Fishes (<i>Asteroidea</i>): Bipinnaria and Brachiolaria Larvæ: Nursing Arrangements in <i>Pterasterida</i> and <i>Leptoptychaster</i>. Sea-Cucumbers (Holothuroidea): Auricularia Larva: Nursing of Embryos in <i>Psolus ephippifer</i> - - -</p> | 354 |
| <p>LIFE-HISTORIES, &c., OF SEGMENTED WORMS (ANNELIDA)—<i>Bristle-Worms</i> (<i>Chaetopoda</i>)—Care of Eggs in Scale-Worms (Polynoids), <i>Autolytus prolifer</i>,</p> | |

CONTENTS

| | Page |
|---|------|
| and Tube-Dwellers (e.g. <i>Spirorbis</i>). Trochosphere Larva. Life-History of <i>Polygordius</i> . Direct Development in Earthworms; their Cocoons - - - | 358 |
| <i>Leeches (Discophora)</i> —Direct Development; their Cocoons. Nursing of Young in <i>Glossiphonia</i> - - - - - | 361 |
| LIFE-HISTORIES, &C., OF CRUSTACEANS (CRUSTACEA)— <i>Lower Crustaceans (Entomostraca)</i> —Leaf-footed Crustaceans (Phyllopoda)—Brood-Pouches of <i>Apus</i> and Water-Flea (<i>Daphnia pulex</i>); Winter- and Summer-Eggs of the latter. Fork-footed Crustaceans (Copepoda)—Egg-Bags and Brood-Pouches. Barnacles (Cirripedia)—Care of Eggs in Ship-Barnacle (<i>Lepas</i>) and Acorn-Barnacle (<i>Balanus</i>). Mussel-Shrimps (Ostracoda)—Care of Eggs. The Nauplius Larva; its Relation to the Trochosphere - - - - - | 362 |
| <i>Higher Crustaceans (Malacostraca)</i> —Mud-Shrimps (Leptostraca)—Direct Development. Sessile-eyed Crustaceans (Arthrostraca)—Sand-Hopper (<i>Gammarus</i>), Brood-Pouch; Direct Development. Stalk-eyed Crustaceans (Thora-costraca)—Opossum-Shrimp (<i>Mysis</i>), Brood-Pouch, Direct Development; Care of Eggs in Lobsters, &c.; Life-History of the Edible Crab (<i>Cancer pagurus</i>), Zoæa Larva, Megalopa Stage; Life-History of Crayfish (<i>Astacus fluviatilis</i>)—Direct Development - - - - - | 365 |
| <i>Crustacean Dwellings</i> —Crabs, Rock-Lobster (<i>Palinurus</i>); Mantis-Shrimp (<i>Squilla mantis</i>), Alima Larva; Caddis-Shrimps (<i>Corophiidae</i>) - - - - - | 368 |
| LIFE-HISTORY, &C., OF KING-CRABS (XIPHOSURA)—King-Crab (<i>Limulus</i>) and its Trilobite Larva - - - - - | 369 |
| LIFE-HISTORIES, &C., OF PRIMITIVE TRACHEATES (PROTOTRACHEATA)— <i>Peripatus</i> ; Viviparous Development; Variations in Amount of Food-Yolk - - - - - | 370 |
| LIFE-HISTORIES, &C., OF CENTIPEDES AND MILLIPEDES (MYRIAPODA)—Care of Eggs in the Thirty-Foot (<i>Lithobius forficatus</i>), the Earth Snake-Millipede (<i>Julus terrestris</i>), and <i>Polyzonium Germanicum</i> - - - - - | 370 |
| LIFE-HISTORIES, &C., OF SPIDER-LIKE ANIMALS (ARACHNIDA)—Scorpions (Scorpionidae). Spiders (Araneidae)—Wolf-Spiders (<i>Lycosidae</i>), House-Spiders (<i>Tegenaria</i>), Hedge-Spiders (<i>Agalena</i>), <i>Theridium nervosum</i> , Water-Spider (<i>Argyroneta aquatica</i>), Trap-door Spiders (<i>Ctenizidae</i>) - - - - - | 373 |
| LIFE-HISTORIES, &C., OF INSECTS (INSECTA)—Varying Degrees of Metamorphosis. Length of Life - - - - - | 377 |
| <i>Primitive Wingless Insects (Aptera)</i> —Tassel-tails and Spring-tails - - - | 377 |
| <i>Straight-winged Insects (Orthoptera)</i> —Earwig (<i>Forficula auricularia</i>), Cock-roach (<i>Periplaneta orientalis</i>), Soothsayers (<i>Mantida</i>), Stick- and Leaf-Insects (<i>Phasmida</i>), Locusts and Grasshoppers (<i>Acridiidae</i>), Green Grasshoppers (<i>Locustidae</i>); Crickets (<i>Gryllidae</i>)—Mole-Cricket (<i>Gryllotalpa campestris</i>) - - - | 377 |
| <i>Bugs (Hemiptera)</i> —Tree-Bugs (<i>Cicadida</i>)—Seventeen-Year Cicada (<i>Cicada septendecim</i>); Scale-Insects (<i>Coccida</i>); Aphides or Plant-Lice (<i>Aphida</i>)—He-terogeny; Care of Eggs in Aquatic Bugs— <i>Halobates</i> , <i>Diplomachus</i> , <i>Nepa</i> , <i>Ranatra</i> - - - - - | 380 |
| <i>Net-winged Insects (Neuroptera)</i> —Dragon-Flies (<i>Odonata</i>); Caddis-Flies (<i>Phryganeida</i>) - - - - - | 383 |

Membrane-winged Insects (Hymenoptera)—Wood-Wasp (*Sirex gigas*);
 Corn Saw-Fly (*Cephus pygmaeus*); Saw-Flies Proper (*Tenthredinidæ*)—Rose
 Saw-Fly (*Hylotoma rosæ*), Turnip Saw-Fly (*Athalia spinarum*). Carpenter Bee
 (*Xylocopa violacea*), Leaf-cutting Bees (*Megachile*), Poppy Bee (*Anthocopa
 papaveris*). Solitary Wasps (*Eumenidæ*)—*Odynerus* and *Eumenes*; Solitary
 Digging-“Wasps” (*Fossores*) - - - - - 386

Beetles (Coleoptera)—Long-horned Oak-Beetle (*Cerambyx heros*), Birch-
 Weevil (*Rhynchites betulæ*), Burying-Beetles (*Necrophorus*), Great Black Water-
 Beetle (*Hydrophilus piceus*) - - - - - 393

Scale-winged Insects (Lepidoptera)—Cabbage Butterfly (*Pieris brassicae*),
 Lappet-Moths (*Lasiocampidæ*), “Basket-Worms” (*Psychidæ*), Fritillaries, &c.
 (*Nymphalidæ*), Silver-Y Moth (*Plusia gamma*), Silkworm Moth (*Bombyx mori*),
 Heart-and-Dart Moth (*Agrotis exclamationis*), *Brephos notha*, Aquatic Cater-
 pillars (*Palustra*), Puss-Moth (*Cerura vinula*), Burnet-Moths (*Zyganidæ*),
 Indian Skipper Butterfly (*Badamia exclamationis*) - - - - - 399

Two-winged Flies (Diptera)—Hover-Flies (*Syrphus*), Drone-Fly (*Eristalis
 tenax*), Ringed Gnat (*Culex annulatus*) - - - - - 402

LIFE-HISTORIES, &c., OF MOLLUSCS (MOLLUSCA)—*Primitive Molluscs (Amphi-
 neura)*—Mail-Shells (*Chiton*, &c.)—Eggs and Trochosphere Larva - - - - 404

Bivalve Molluscs (Lamellibranchia)—Protection and Incubation of Eggs
 in Common Oysters (*Ostrea edulis*), and Freshwater Forms (*Unio*, *Anodon*,
Cyrena, and *Cyclas*); Veliger Larva; Life-History of Freshwater Mussels (*Unio*
 and *Anodon*); Glochidium Larva. Dwellings of Bivalves; Byssus of Edible
 Mussel (*Mytilus edulis*), *Tridacna*; Nests of File-Shells (*Lima*); Saddle-Oyster
 (*Anomia ephippium*), Scallops (*Pecten*), Thorny Oysters (*Spondylus*); Boring
 Forms—Piddocks (*Pholas*), *Pholadidea*, *Jouannetia*, Ship-Worm (*Teredo
 navalis*), Date-Shells (*Lithodomus*) - - - - - 405

Tusk-Shells (Scaphopoda)—Trochosphere Larva - - - - - 411

Snails and Slugs (Gastropoda)—Laying and Protection of Eggs—Limpet
 (*Patella*) and Sea-Ear (*Haliotis*); Spawn of Sea-Hare (*Aplysia*) and Sea-Lemon
 (*Doris*); Egg-Capsules of Purple-Shell (*Purpura lapillus*), Whelk (*Buccinum
 undatum*), Dog-Whelk (*Nassa*); Egg-Bands of *Natica*; Egg-Raft of Violet-
 Snail (*Anthina*); Care of Egg-Capsules in Bonnet-Limpets (*Crepidula*) and
 Worm-Snails (*Vermetus*). Spawn of Pond-Snails (*Limnæa*) and Trumpet-
 Snails (*Planorbis*); Viviparous River-Snail (*Paludina vivipara*). Spawn of
 Land-Slugs (*Limax*, &c.); Eggs of Land-Snails (*Helix* and *Bulinus*). Gastro-
 pod Larva—Trochosphere and Veliger, *Onchidium*. Gastropod Dwellings—
 Burrowers; Types of Shell; “Scars” of Limpet (*Patella*); Threads of *Pota-
 mides* - - - - - 412

Head-Footed Molluscs (Cephalopoda)—Spawn of Squid (*Loligo*); Egg-
 Capsules of Cuttle-Fish (*Sepia*) and Octopods (*Eledone* and *Octopus*). Care of
 Eggs in Paper Nautilus (*Argonauta*). Egg-Capsules of Pearly Nautilus
 (*Nautilus*) - - - - - 417

LIFE-HISTORIES, &c., OF NEMERTINE WORMS (NEMERTEA)—Pilidium Larva.
 Dwellings - - - - - 419

CHAPTER LVI.—LIFE-HISTORIES, CARE OF EGGS AND
YOUNG, AND DWELLINGS, IN BACKBONED ANIMALS
(VERTEBRATA)

| | Page |
|--|------|
| LIFE-HISTORIES, &c., OF PRIMITIVE VERTEBRATES (PROTOCHORDATA).—Worm-like Protochordates (Hemichorda)—Acorn-headed Worm (<i>Balanoglossus</i>), Simple Larva, Tornaria Larva. Sea-Squirts, Ascidians, or Tunicates (Urochorda)—Life-History of <i>Ascidia</i> ; Metagenesis in Salps - - - - - | 420 |
| LIFE-HISTORIES, &c., OF FISHES (PISCES)— <i>Round-Mouths</i> (<i>Cyclostomata</i>)—Lampreys and Lamperns (<i>Petromyzon</i>), Ammocoetes Larva - - - - - | 422 |
| <i>Sharks and Rays</i> (<i>Elasmobranchii</i>)—Egg-Capsules of Skate (<i>Raia</i>), Dog-Fish (<i>Scyllium</i>), and Port Jackson Shark (<i>Cestracion</i>); Embryo and Food-Yolk | 424 |
| <i>Ordinary Bony Fishes</i> (<i>Teleostei</i>)—Size and Number of Eggs; Floating Eggs of Sea-Bass (<i>Serranus</i>), &c.; Adhesive Eggs of Herring (<i>Clupeus harengus</i>); Egg-Capsules of Blennies (<i>Bleniida</i>); Viviparous Blenny (<i>Zoarces viviparus</i>). Care of Eggs or Young—Butter-Fish (<i>Centronotus Gunnellus</i>); Fish as Mothers— <i>Aspredo</i> , <i>Solenostoma</i> ; Fish as Fathers— <i>Arius</i> , Greater Pipe-Fish (<i>Syngnathus acus</i>), Sea-Horse (<i>Hippocampus</i>), Nests, &c., of Paradise-Fish (<i>Macropomus viridiauratus</i>) and Sticklebacks (<i>Gasterosteida</i>). Life-Histories of Turbot (<i>Rhombus maximus</i>), Salmon (<i>Salmo salar</i>), and Common Eel (<i>Anguilla vulgaris</i>)—Leptocephalus Larva - - - - - | 425 |
| LIFE-HISTORIES, &c., OF AMPHIBIANS (AMPHIBIA)— <i>Tailed Amphibians</i> (<i>Urodela</i>)—Newts or Efts. Moored Eggs of <i>Spelerpes bilineatus</i> ; Egg-Bags of <i>Salamandrella Keyserlingi</i> . Maternal Care in Three-toed Salamander (<i>Amphiuma means</i>), <i>Desmognathus fuscus</i> , and <i>Autodax lugubris</i> . The Axolotl (<i>Amblystoma tigrinum</i>). Viviparous Development in Spotted Salamander (<i>Salamandra maculosa</i>) and Black Salamander (<i>S. atra</i>) - - - - - | 434 |
| <i>Tailless Amphibians</i> (<i>Anura</i>)—Spawning of Common Toad (<i>Bufo vulgaris</i>), Grass Frog (<i>Rana temporaria</i>), and <i>Leptodactylus mystacinus</i> ; Egg-Cases of <i>Phyllomedusa Jheringi</i> . Nurseries of the Ferreiro (<i>Hyla faber</i>). Tadpoles of Ordinary Frogs and Toads. Care of Eggs in <i>Rhacophorus Schlegeli</i> and <i>Hylodes Martinicensis</i> . Egg-Carrying by Males— <i>Alytes obstetricans</i> , <i>Rhinoderma Darwini</i> . Egg-Carrying by Females—Surinam Toad (<i>Pipa Americana</i>), <i>Rhacophorus reticulatus</i> , <i>Hyla Goeldii</i> , and <i>Nototrema</i> - - - - - | 436 |
| <i>Limbless Amphibians</i> (<i>Gymnophiona</i>)—Care of Eggs and Life-History in Cæcilians— <i>Ichthyophis glutinosa</i> , <i>Hypogeophis</i> , <i>Typhlonectes compressicaudata</i> | 442 |
| REPTILES (REPTILIA)— <i>Tuatara</i> s (<i>Rhynchocephala</i>)—Care of Eggs in the Tuatara (<i>Hatteria punctata</i>) - - - - - | 443 |
| <i>Snakes</i> (<i>Ophidia</i>)—Eggs of Grass-Snake (<i>Tropidonotus natrix</i>); "Egg-Tooth"; Care of Eggs by Female Pythons; Viviparous Habit of Adder (<i>Pelias berus</i>) and Marine Snakes (<i>Hydrophinae</i> , - - - - - | 444 |
| <i>Lizards</i> (<i>Lacertilia</i>)—Eggs and "Egg-Tooth"; Nesting Habits of Common Iguana (<i>Iguana tuberculata</i>), Eyed Lizard (<i>Lacerta ocellata</i>), Spanish Sand-Lizard (<i>Psammotromus Hispanicus</i>), and Common Chameleon (<i>Chamaeleo vulgaris</i>). Viviparous Lizard (<i>Zootoca vivipara</i>) and Blind-Worm (<i>Anguis fragilis</i>) | 445 |
| <i>Turtles and Tortoises</i> (<i>Chelonia</i>)—Care of Eggs in European Pond-Tortoise (<i>Emys orbicularis</i>) and Edible Turtle (<i>Chelone mydas</i>). Dwellings of the Gopher Tortoise (<i>Testudo polyphemus</i>) - - - - - | 446 |

Crocodiles (Crocodiles)—Nests of the Nile Crocodile (*Crocodilus Niloticus*) and American Alligator (*Alligator Mississippiensis*) - - - - - 447

LIFE-HISTORIES, &C., OF BIRDS (AVES)—Eggs and Incubation; Care of Young; Nestlings (*nidicolæ*) and Precocious Young (*nidifugæ*) - - - - - 448

Running Birds (Ratitæ)—African Ostrich (*Struthio camelus*), American Ostriches (*Rhea*), Cassowaries (*Casuaris*), Emeu (*Dromæus*), Kiwi (*Apteryx*) - 449

Flying Birds (Carinata)—Megapodes (*Megapodiidæ*)—Eggs deposited among Rotting Leaves (*Megapodius Layardi*), or in Sand (*M. eremita*); Scrub-Turkey (*Cathetus* or *Talegalla Lathamii*); Mound-Builder (*Megapodius tumulus*). Exposed Eggs—Guillemot (*Uria troile*), Tern (*Sterna fluviatilis*), Kentish Plover (*Ægialitis Cantiana*), Nightjar (*Caprimulgus Europæus*). Eggs laid in Burrows or Holes—Sand-Martin (*Cotile riparia*), Kingfisher (*Alcedo ispida*), Hoopoe (*Upupa epops*), Woodpeckers, Nuthatch (*Sitta cæsia*). Primitive Ground-Nests—Lapwing (*Vanellus cristatus*), Golden Plover (*Charadrius pluvialis*). Rough Nests of Sea-Birds—Gannet or Solan Goose (*Sula Bassana*), Kittiwake (*Rissa tridactyla*). Fairly well-constructed Nests on or near the Ground—Skylark (*Alauda arvensis*), Coot (*Fulica atra*). Floating Nests of Dabchick (*Podiceps fluviatilis*) and White Swan (*Cygnus olor*). Well-finished Cup-Nests built near the Ground—Grey Wagtail (*Motacilla melanope*), Common Thrush (*Turdus musicus*). Stick- or Fibre-Nests in Trees, &c.—Wood-Pigeon (*Columba palumbus*), Reed Warblers (*Acrocephalus*), Long-tailed Tit (*Acredula caudata*), Penduline Tit (*Ægithalus pendulinus*). Sewn Nests—Tailor-Bird (*Orthotomus sutorius*), Fan-tail Warbler (*Cisticola cursitans*). Plastic Nests—Common Flamingo (*Phænicopterus roscus*), Swallow (*Hirundo rustica*), House-Martin (*Chelidon urbica*), Oven-Birds (*Furnarius*). Cemented Nests—Common Swift (*Cypselus apus*), Guatemalan Swift (*Panyptila Sancti Hieronymi*), Edible Nests of *Collocalia*. Birds that nest in Company—Rook, Heron, Fieldfare, Sociable Grosbeak (*Philhæterus socius*). Great Variety of Nests among the American Tree-Creepers or Picucules (*Dendrocolaptidæ*) - 450

Incubation and Care of Young in Flying Birds (Carinata)—Woodpeckers, Dotterel (*Eudromias morinellus*), Hoopoe (*Upupa epops*), Hornbills (*Bucerotidæ*), Swallows and Martins, Skylark (*Alauda arvensis*), Chaffinch (*Fringilla cælebs*), House-Sparrow (*Passer domesticus*), Tree-Sparrow (*P. montanus*), Linnet (*Linaria cannabina*), Pigeon (*Columba livia*), Black Cormorant (*Phalacrocorax carbo*). Sanitation of Nests. Protective Colours and Habits of Young Birds—Stone-Curlew (*Ædicnemus scolopax*), Lapwing (*Vanellus cristatus*), Hoatzin (*Opisthocornis*) - - - - - 464

LIFE-HISTORIES, &C., OF MAMMALS—Energy and Intelligence. Milk-Glands. Advantages of Internal Development - - - - - 474

Mammals (Prototheria)—Spiny Ant-Eater (*Echidna*)—Temporary Pouch of Female. Duck-Bill (*Ornithorhynchus*); Nest and Burrow - 475

Pouched Mammals (Metatheria)—Young born in Imperfect State. Position and Structure of Pouch. Rock-Wallaby (*Petrogale*), Koala (*Phascolarctos*), Mouse Opossum (*Didelphys murina*), Azara's Opossum (*Didelphys Azaræ*), Wombat (*Phascolomys*), Lesueur's Kangaroo-Rat (*Bettongia*), Red Kangaroo-Rat (*Æpyprymnus rufescens*) - - - - - 478

Higher Mammals (Eutheria)—Mammals Poor in Teeth (*Edentata*)—Sloths, Great Ant-Eater (*Myrmecophaga*), Armadilloes. Gnawing Mammals (Rodentia)—Rabbit (*Lepus cuniculus*), Hare (*L. timidus*), Harvest-Mouse (*Mus*

minutus), Common Squirrel (*Sciurus vulgaris*). Insect-eating Mammals (Insectivora)—Hedgehog (*Erinaceus Europæus*), Mole (*Talpa Europæa*), Flying-“Lemur” (*Galeopithecus*). Bats (Chiroptera)—*Molossus Bonariensis*. Hoofed Mammals (Ungulata)—Tapirs (*Tapirus*), Rhinoceros (*Rhinoceros*), Horses, &c. (*Equus*). Babirussa (*Porcus babirussa*), Peccaries (*Dicotyles*), Hippopotamus (*Hippopotamus amphibius*), Ruminants. Elephants (Proboscidea). Sea-Cows (Sirenia)—Dugong (*Halicore*) and Manatee (*Manatus*). Whales, Porpoises, &c. (Cetacea). Flesh-eating Mammals (Carnivora)—Dogs (Canidæ), Cats (Felidæ), Bears (Ursidæ). Aquatic Carnivores (Pinnipedia)—Northern Fur-Seal (*Otaria ursina*). Lemurs (Lemuroidea). Apes, Monkeys, and Men (Primates)—Marmozets; Old World Monkeys and Baboons; Orang, Chimpanzee, and Gorilla - - - - - 480

LIST OF ILLUSTRATIONS

HALF-VOL. VI

COLOURED PLATES

| | PAGE |
|--|--------------|
| NUTHATCHES (<i>Sitta cæsia</i>) FEEDING YOUNG. From a Drawing by A. Fairfax Muckley..... | Frontispiece |
| SWALLOWS AND MARTINS CHASING INSECTS. From a Drawing by A. Fairfax Muckley..... | 302 |
| FAMILY OF COMMON SQUIRRELS (<i>Sciurus vulgaris</i>). From a Drawing by Friedrich Specht..... | 370 |
| LIFE-HISTORY OF THE COMMON FROG (<i>Rana temporaria</i>). From a Drawing by A. Fairfax Muckley..... | 436 |

BLACK-AND-WHITE ILLUSTRATIONS

| | Page | | Page |
|---|------|---|------|
| PARACHUTING ANIMALS - - - - - | 282 | Wings of Insects - - - - - | 313 |
| African Flying-Squirrel (<i>Anomalurus peli</i>) | 284 | A Marine Worm (<i>Myrianida</i>) dividing (after Milne Edwards) - - - - - | 318 |
| Australian Flying-Mouse (<i>Acrobates pyg- maeus</i>) - - - - - | 285 | Fission of a Proteus Animalcule (<i>Amaba</i>) (after Schulze) - - - - - | 318 |
| Instantaneous Photographs of a Pigeon descending to the Ground (after Marey) | 286 | Fission of Ciliated Animalcules (after Johnson and Bütschli) - - - - - | 319 |
| Fringed Gecko (<i>Ptychozoon homalocephala</i>) - - - - - | 287 | Budding Animalcules (after R. Hertwig and Bütschli) - - - - - | 320 |
| Australian Flying-Spider (<i>Attus volans</i>) | 289 | A Spore-forming Animalcule (<i>Colpoda</i>) (after Rhumbler) - - - - - | 321 |
| Young Spider spinning a "Gossamer" Thread (from Graber) - - - - - | 290 | GUENONS (<i>Cercopithecus sabæus</i>) RETREAT- ING FROM A MAIZE-FIELD - - - - - | 322 |
| Pipistrelles (<i>Vesperugo pipistrellus</i>) - - - | 293 | Conjugation of Slipper-Animalcule (<i>Para- macium caudatum</i>) (after Maupas) - - - | 323 |
| Skeleton of Bat - - - - - | 294 | Diagram of ditto - - - - - | 324 |
| Extinct Toothed Bird (<i>Archaeopteryx</i>) (after Döderlein) - - - - - | 296 | Conjugation of Bell-Animalcule (<i>Vorticella</i>) (after Wallengren) - - - - - | 325 |
| Shoulder-girdles and Breastbone of Pigeon | 298 | Cup-Sponge (<i>Polylophus</i>) budding (after Schulze) - - - - - | 326 |
| Wing-bones of Pigeon - - - - - | 298 | Gemmule of Freshwater Sponge (<i>Spongilla</i>) (after Goette) - - - - - | 326 |
| Structure of Pheasant's Wing - - - - - | 300 | Freshwater Polype (<i>Hydra</i>) budding - - - | 327 |
| Diagram of Wing-Action (after Alix) - - - | 302 | Vegetative Propagation of Sea-Anemones - | 327 |
| Photographs of Phases in Flight (after Marey) - - - - - | 304 | Vegetative Propagation, &c., in Star-Fishes (after Haeckel and Sarasin) - - - - - | 329 |
| A Falcon Swooping - - - - - | 306 | | |
| Restoration of Paddle-tailed Pterosaur (<i>Rhamphorhynchus</i>) (after Zittel) - - - | 308 | | |
| Cross-section of a Butterfly (from Graber) - | 310 | | |
| Wasp flying in the Sun (after Marey) - - - | 311 | | |

| | Page | | Page |
|---|------|--|------|
| Fission-Chain of Planarian Worms (<i>Microstomum</i>) (after von Graff) - - - | 329 | Alima Larva (after Claus) - - - | 368 |
| Part of Branching Colony of an Annelid (<i>Syllis ramosa</i>) (after M'Intosh) - - | 330 | Larva of King-Crab (<i>Limulus polyphemus</i>) (after Kingsley) - - - | 369 |
| Winter-Buds of Moss-Polypes (after Kraepelin and Allman) - - - | 331 | Nest of House-Spider (<i>Tegenaria domestica</i>) (after Hermann) - - - | 374 |
| Volvox (after Bütschli and Cienkowski) - | 334 | Water Spiders (<i>Argyroneta aquatica</i>) and Nests - - - | 375 |
| Formation of Polar Bodies - - - | 336 | Trap-door Spiders (<i>Ctenisa camentaria</i>) and Nests - - - | 376 |
| Freshwater Polype (<i>Hydra</i>) (after Vogt and Yung) - - - | 339 | Life-history of Earwig (<i>Forficula auricularia</i>) - - - | 378 |
| Development of Freshwater Polype (<i>Hydra</i>) (after Braner) - - - | 340 | Praying Mantis - - - | 378 |
| Development of a Sponge (after Haeckel)- | 343 | Red-legged Locust (<i>Melanoplus femurrubrum</i>) (after Fletcher) - - - | 379 |
| Young Embryos of Lancelet (<i>Amphioxus</i>) (after Hatschek) - - - | 344 | A Green Grasshopper (<i>Decticus verrucivorus</i>) laying her Eggs - - - | 380 |
| Older Embryos of Lancelet (<i>Amphioxus</i>) (after Hatschek) - - - | 345 | Home of Mole-Cricket (<i>Gryllotalpa campestris</i>) - - - | 381 |
| Influence of Food-yolk on Development (after Selenka) - - - | 346 | Apple Scale-Insect (<i>Mytilaspis pomorum</i>) (after Howard) - - - | 381 |
| Section through a Hen's Egg (after A. Thompson and Balfour) - - - | 347 | Turnip-Flower Aphis (<i>Aphis floris-rapae</i>) (from Curtis) - - - | 382 |
| Life-history of Syncoryne (after Perrier) - | 350 | Eggs of Water-Bugs (from Vosseler) - - | 383 |
| Life-history of Campanularia (after Allman) | 351 | Life-history of a Dragon-Fly (<i>Libellula depressa</i>)- - - | 384 |
| Gonophores of various Zoophytes (after Hatschek and Gegenbaur) - - - | 351 | Caddis-Moth (<i>Phryganea striata</i>) and its Larva - - - | 385 |
| Life-history of Aurelia (after Perrier) - | 352 | Larva and Pupa of a Caddis-Moth (<i>Oxyethira costalis</i>) (from Vosseler) - - - | 385 |
| Creeping Eggs of a Jelly-Fish (<i>Amalthea amabiligera</i>) (after Haeckel) - - - | 353 | Land-Caddis (<i>Enoicyla pusilla</i>) (after Ritsema) - - - | 386 |
| Egg-cell of a Coral (<i>Corallimorphus rigidus</i>) (after R. Hertwig) - - - | 353 | Ovipositor of Female Wood-Wasp (<i>Sirex gigas</i>) (from Graber) - - - | 386 |
| Life-history of a Brittle-Star (from Ziegler's models) - - - | 354 | Cross-section through Ovipositor of Wood-Wasp (<i>Sirex gigas</i>) (from Graber) - - | 387 |
| Nursing of young Sea-Urchins (<i>Hemiaster cavernosus</i>) (after A. Agassiz) - - - | 355 | Corn Saw-Fly (<i>Cephus pygmaeus</i>) (from Curtis)- - - | 388 |
| Sea-Urchins burrowing (after Walther) - | 356 | Ovipositor of Rose Saw-Fly (<i>Hylotoma rosae</i>) (after Lacaze-Duthiers) - - - | 388 |
| Heart-Urchin (<i>Amphidotus cordatus</i>) in its Burrow (from Graber) - - - | 357 | Turnip Saw-Fly (<i>Athalia spinarum</i>) (from Curtis)- - - | 389 |
| Nursing of young Star-Fishes (<i>Leptoptychaster Kerguelensis</i>) (after the "Challenger" Reports) - - - | 357 | Carpenter Bee (<i>Xylocopa violacea</i>) - - - | 390 |
| Auricularia (after J. Müller) - - - | 357 | Nests of Solitary Wasps (after André) - | 392 |
| A Female Bristle-Worm (<i>Autolytus prolifer</i>) carrying her Eggs (after Perrier) - - - | 358 | Long-horned Oak-Beetle (<i>Cerambyx heros</i>) | 394 |
| Spirorbis (after Claparède) - - - | 359 | Birch-Weevil (<i>Rhynchites betule</i>) (after Sharp and Debey) - - - | 395 |
| Trochospheres of Polygordius (after Fraipont) - - - | 359 | Sexton-Beetles (<i>Necrophorus</i>) - - - | 397 |
| Larva of a Bristle-Worm (after A. Agassiz) | 360 | Great Black Water-Beetle (<i>Hydrophilus piceus</i>) - - - | 398 |
| Cocoons of Earth-Worms (after Vejdovsky) | 361 | Cabbage Butterfly (<i>Pieris brassicae</i>) (from Curtis) - - - | 399 |
| Brood-pouch of Apus (after Ray Lankester) | 362 | Silver-Y Moth (<i>Plusia gamma</i>) (from Curtis) | 401 |
| Water-Flea (<i>Daphnia</i>) with Eggs (after Claus and R. Hertwig) - - - | 363 | Heart-and-Dart Moth (<i>Agrotis exclamationis</i>) (from Curtis) - - - | 401 |
| Female Cyclops with Egg-bags (after Claus) | 364 | Indian Skipper Butterfly (<i>Badamia exclamationis</i>) (after Dudgeon) - - - | 402 |
| Nauplius Larva (after Nordmann) - - - | 364 | Hover-Flies (from Curtis) - - - | 402 |
| Female Sand-Hopper (<i>Gammarus neglectus</i>) carrying Eggs (after Sars) - - - | 365 | | |
| Life-history of Edible Crab (<i>Cancer pagurus</i>) | 366 | | |
| Just-hatched Crayfishes (after Huxley) - | 368 | | |

LIST OF ILLUSTRATIONS

xv

| | Page | | Page |
|--|------|--|------|
| Life-history of Ringed Gnat (<i>Culex annulatus</i>) (from Vosseler) - - - - | 403 | Female <i>Desmognathus fuscus</i> with Eggs (after Wilder) - - - - | 435 |
| Larva of Mail-Shell (<i>Chiton</i>) (after Kowalevsky) - - - - | 404 | Egg-case of Brazilian Tree-Frog (<i>Phyllomedusa Jheringi</i>) (after von Jhering) - | 437 |
| Diagrammatic Cross-section through a Bivalve Mollusc - - - - | 405 | Nests of the Ferreiro (<i>Hyla faber</i>) (after Goeldi) - - - - | 438 |
| Veliger Larva (12 days old) of an Edible Mussel (<i>Mytilus edulis</i>) (after Wilson) - | 406 | Development of West Indian Tree-Frog (<i>Hylodes Martinicensis</i>) (after Peters) - | 439 |
| Glochidium of Freshwater Mussel (<i>Anomonta</i>) (after Goette) - - - - | 406 | Male Alytes, carrying the Eggs - - - - | 440 |
| Glochidia of Freshwater Mussel (<i>Unio</i>) (after Schierholtz) - - - - | 407 | Male of Chilian Toad (<i>Rhinoderma Darwini</i>) (after Howes) - - - - | 441 |
| Edible Mussel (<i>Mytilus edulis</i>) (after Moebius) - - - - | 408 | Female of Surinam Toad (<i>Pipa Americana</i>) carrying Young - - - - | 442 |
| Shells of Saddle-Oyster (<i>Anomia</i>) (after Morse) - - - - | 408 | Development of a Cæcilian (<i>Ichthyophis glutinosa</i>) (after Sarasin) - - - - | 443 |
| Piddocks (<i>Pholas</i>) - - - - | 409 | Egg-tooth of Embryo Lizard (after Wiedersheim) - - - - | 446 |
| Ship-Worms (<i>Teredo navalis</i>) (after Moebius) - - - - | 410 | GANNETS OR SOLAN GEESE (<i>Sula Bassana</i>) (from photos by R. A. L. van Someren) - - - - | 448 |
| Date-Shells (<i>Lithodomus</i>) - - - - | 411 | Mound of a Megapode (<i>Megapodius tumulus</i>) (after Gould) - - - - | 452 |
| Trochosphere of Tusk-Shell (<i>Dentalium</i>) (after Kowalevsky) - - - - | 412 | Eggs of Tern (<i>Sterna fluviatilis</i>) (photo by R. A. L. van Someren) - - - - | 453 |
| Egg-capsules of Purple-Shell (<i>Purpura lapillus</i>) - - - - | 412 | Nest of a Woodpecker, in section - - - - | 454 |
| Spawn of Whelk (<i>Buccinum undatum</i>) - - - - | 413 | Young Kittiwake (<i>Rissa tridactyla</i>) (photo by R. A. L. van Someren) - - - - | 455 |
| Spawn of Natica - - - - | 413 | Nest of a Skylark (<i>Alauda arvensis</i>) (from R. and C. Kearton) - - - - | 455 |
| Violet-Snail (<i>Ianthina</i>) and Raft - - - - | 413 | Nest of Coot (<i>Fulica atra</i>) (photo by R. A. L. van Someren) - - - - | 456 |
| Gastropod Larvæ (after various authors) - | 415 | White Swan (<i>Cygnus olor</i>) and Nest (photo by R. A. L. van Someren) - - - - | 456 |
| Purple-Shell (<i>Purpura lapillus</i>) - - - - | 416 | Nest of Grey Wagtail (<i>Motacilla melanope</i>) (photo by R. A. L. van Someren) - - - - | 457 |
| Limpet (<i>Patella vulgata</i>) leaving its Scar at Low Tide - - - - | 417 | Nest of Common Thrush (<i>Turdus musicus</i>) (photo by R. A. L. van Someren) - - - - | 457 |
| Spawn of Squid (<i>Loligo</i>) - - - - | 418 | Nest of Wood-Pigeon (<i>Columba palumbus</i>) (photo by R. A. L. van Someren) - - - - | 458 |
| Egg-capsules of Cuttle-Fish (<i>Sepia</i>) - - - - | 418 | Nest of Great Reed Warbler (<i>Acrocephalus arundinaceus</i>) - - - - | 458 |
| Pilidium Larva (after Metschnikoff) - - - - | 419 | Penduline Tit (<i>Egithalus pendulinus</i>) and Nest - - - - | 459 |
| Larvæ of Acorn-headed Worms (<i>Balanoglossus</i>) (after Bateson and Metschnikoff) | 420 | Nest and Young of Tailor-Bird (<i>Orthotomus sutorius</i>) - - - - | 460 |
| Adult and Tadpole Larva of Simple Ascidian - - - - | 421 | Brooding Flamingo (<i>Phaenicopterus roseus</i>) | 461 |
| Life-history of a Salp (after Grobben) - | 422 | Nest of an Oven-Bird (<i>Furnarius</i>) - - - - | 461 |
| Front End of Ammocoetes (after W. K. Parker) - - - - | 423 | Edible Nests of Collocalia - - - - | 462 |
| Egg-capsules of Elasmobranchs (partly after Waite) - - - - | 424 | Nest of Sociable Grosbeak (<i>Philhetarus socius</i>) - - - - | 463 |
| Advanced Embryo of Dog-Fish (from Selenka) - - - - | 424 | Female Dotterel (<i>Eudromias morinellus</i>) - | 465 |
| Floating Egg of Sea-Bass (<i>Serranus atrarius</i>) (after Wilson) - - - - | 425 | Wild Duck defending her Brood against a Brown Rat - - - - | 467 |
| Embryo of a Blenny (<i>Blennius</i>) (after Guitel) - - - - | 425 | Skylark (<i>Alauda arvensis</i>) at her Nest (from R. and C. Kearton) - - - - | 468 |
| Male Sea-Horse (<i>Hippocampus</i>) - - - - | 427 | Cock Chaffinch (<i>Fringilla cælebs</i>) at Nest (from R. and C. Kearton) - - - - | 469 |
| Sticklebacks (<i>Gasterosteus</i>) and Nest - | 428 | | |
| Larvæ of Turbot (<i>Rhombus maximus</i>) (after McIntosh) - - - - | 431 | | |
| Turbot (<i>Rhombus maximus</i>) - - - - | 432 | | |
| Life-history of Salmon (<i>Salmo salar</i>) - | 433 | | |
| Larval Eel (<i>Leptocephalus brevirostris</i>) (from Selenka) - - - - | 434 | | |

| | Page | | Page |
|---|------|---|------|
| House Sparrows (<i>Passer domesticus</i>) feeding their Young - - - - - | 470 | Azara's Opossum (<i>Didelphys Azarae</i>) carry- ing her Young (from Hudson) - - - | 480 |
| A Nest of Linnets (<i>Linaria cannabina</i>) - | 470 | Three-toed Sloth (<i>Bradypus tridactylus</i>) carrying her Young - - - - - | 481 |
| Black Cormorant (<i>Phalacrocorax carbo</i>) feeding its Young - - - - - | 471 | Harvest-Mice (<i>Mus minutus</i>) and Nest - | 483 |
| Female Lapwing (<i>Vanelhus cristatus</i>) and Young - - - - - | 472 | Fortress of Mole (<i>Talpa Europaea</i>) - - | 484 |
| Wings of Young and Adult Hoatzin (<i>Opis- thocomus</i>) (after Pyecraft) - - - - | 473 | Brazilian Tapirs (<i>Tapirus Americanus</i>) and Young - - - - - | 487 |
| Female Spiny Ant-Eater (<i>Echidna</i>) showing Pouch and Milk-glands (after Haacke) - | 476 | Hind and Fawn of Roe-Deer (<i>Capreolus caprea</i>) - - - - - | 489 |
| Pouch and Pouch-Embryo of Spiny Ant- Eater (<i>Echidna</i>) - - - - - | 477 | Cubs of Brown Bear (<i>Ursus arctos</i>) at Play - - - - - | 491 |
| Yellow-footed Rock-Wallaby (<i>Petrogale xanthopus</i>) - - - - - | 479 | Lemur (<i>Lemur rufifrons</i>) carrying Young - | 493 |

CHAPTER LI

ANIMAL LOCOMOTION—PARACHUTING AND KITE-FLYING

The present chapter is not headed “muscular” locomotion, as are those which precede it, because it deals with two kinds of progression which are of a passive nature, or mainly so.

PARACHUTING

The word “parachute” is applied by aeronauts to an umbrella-like arrangement by means of which perilous descents are made from balloons, &c. The opening out of the parachute offers so large a surface of resistance to the air that the fall is thereby broken.

In what may be called PARACHUTE ANIMALS we find expansions of the body which answer a similar purpose. As might be anticipated, it is among arboreal forms that we must chiefly look for examples of this kind of adaptation. Its practical use is obvious, for descent from one tree-branch to another, or even to the ground, is thus rendered comparatively safe and easy. And parachuting is of great evolutionary interest, for it probably constituted a prelude to flight. Unfortunately, however, our geological knowledge is as yet too incomplete to enable us to form any clear idea of the way in which wings were evolved from parachutes.

MAMMALS (MAMMALIA) AS PARACHUTISTS.—Striking instances of this adaptation are to be found in certain members of the following orders:—Insect-Eating Mammals (Insectivora), Gnawing Mammals (Rodentia), and Pouched Mammals (Marsupialia).

Insect-Eating Mammals (Insectivora) as Parachutists.—Only one species here included can claim to be a thorough-going parachutist. This is the Colugo or Flying “Lemur” (*Galeopithecus*) of South-east Asia, a much larger animal than its con-

genera, being about the size of a cat. In structure it is so peculiar that there is some doubt as to its classificatory position. But the Colugo is generally held to be an aberrant Insectivore, though, as a mark of its isolated position, it is placed in a distinct sub-order (*Dermaptera*). All the ordinary Insectivores (such as Shrews, Hedgehogs, Moles, &c.) are grouped in a second sub-order as True Insectivora (*Insectivora vera*).

The parachute consists of folds of hairy skin which run from neck to arm, connect the sides of the body with both pairs of limbs, and bind together hind-limbs and tail. Both feet and hands are webbed, but of course this simply means further extension of surface for parachuting, and has nothing to do with swimming. Comparatively little is known about the habits of this remarkable creature, but Wallace (in *The Malay Archipelago*) gives the following account of one which he observed in Sumatra:—"Once, in a bright twilight, I saw one of these animals run up a trunk in a rather open place, and then glide obliquely through the air to another tree, on which it alighted near its base, and immediately began to ascend. I paced the distance from the one tree to the other, and found it to be seventy yards; and the amount of descent I estimated at not more than thirty-five or forty feet, or less than one in five. This, I think, proves that the animal must have some power of guiding itself through the air, otherwise in so long a distance it would have little chance of alighting exactly upon the trunk."

Gnawing Mammals (Rodentia) as Parachutists.—So-called "Flying"-Squirrels inhabit the Northern Hemisphere and Africa. Of these the largest and best-known (species of *Pteromys*) are native to South and South-east Asia. A typical form is the Brown Flying-Squirrel (*Pteromys petaurista*), which may be as much as 18 inches in length, exclusive of the large bushy tail. In general appearance this creature is not unlike a common squirrel, were it not for the presence of parachute folds, resembling those of the Colugo. But only the base of the tail is in this case united with the hind-limbs, and the edge of the fold at the side of the body is supported in front by a bar of gristle stretching back from the wrist. The nature of the parachuting movement appears to be similar to those already described for the Colugo, and not far short of eighty yards is said to be the maximum length of the downward "flights" that are made through

PARACHUTING ANIMALS

In a number of arboreal backboned animals folds of skin are present that serve as parachuting arrangements, which facilitate progress from one branch or tree to another, and are useful in the search for food as well as in retreat from enemies. Three Parachuting Mammals are represented in the plate: 1, the Malayan Flying-Squirrel (*Pteromys petaurista*), native to south-east Asia; 2, the Colugo or Flying-"Lemur" (*Galeopithecus volans*), which is also from the Malay region; and 3, the little Sugar-"Squirrel" or Flying Phalanger (*Petaurus sciureus*) of eastern Australia. All these have a certain amount of steering power.

At 4 is depicted a Parachuting Reptile, the beautiful little Flying-Dragon (*Draco volans*) of the Malay region, in which there is a movable fold on either side of the body, supported by the ribs.

In the Common Flying-Fish (*Exocoetus volitans*) the pectoral fins are immensely large, and serve both as parachutes and kites. The peculiar shape of the tail gives an upward bias to the body in the water, greatly helping the fish to slide up, as it were, into the air.



J.M.

PARACHUTING ANIMALS

the air. These squirrels are also credited with a certain amount of steering power as they descend in graceful curves from branch to branch or tree to tree.

The smaller Flying-Squirrels (species of *Sciuropterus*), represented in Asia, North-east Europe, and North America, are extremely graceful and pretty animals, which in most respects resemble their larger relatives. But the eyes are much larger, and even the base of the large tail is perfectly free. Being flattened from above downwards, this organ adds considerably to the area of the surface presented to the air. Audubon and Bachman thus describe the movements of the American Flying-Squirrel (*Sciuropterus volucella*), a community of which came under their observation:—"At times one would be seen darting from the topmost branches of a tall oak, and with wide extended membranes and outspread tail gliding diagonally through the air, till it reached the foot of a tree about fifty yards off, when, at the moment we expected to see it strike the earth, it suddenly turned upwards and alighted in the body of the tree. It would then run to the top, and once more precipitate itself from the upper branches and sail back again to the tree it had just left. Crowds of these little creatures joined in these sportive gambols; there could not have been less than two hundred. Scores of them would leave each tree at the same moment, seeming to have no other object in view than to indulge a playful propensity." This account certainly seems to furnish some evidence of steering power.

The African Flying-Squirrels (species of *Anomalurus* and *Idiurus*) are of somewhat smaller size than the Brown Flying-Squirrel and the species related to it. Notwithstanding an agreement with these both in general build, and especially as regards the nature and arrangement of the parachute folds, there are differences of sufficient importance to justify the inclusion of the African forms in a special family (*Anomaluridae*). One of these is the absence of a piece of gristle stretching from the wrist along the front edge of the lateral fold. But the place of this is taken by a rod of similar character that runs from the elbow to the side of the fold. The other characteristic feature is the presence of a series of overlapping scales on the under side of the tail at its base. These would appear to be used as a help to climbing. In fig. 823 a drawing is given of a Gold Coast species (*Anomalurus peli*) to illustrate these features.

It may be interesting to notice that one member of the present family (*Aëthurus glirinus*), native to French Congo, is altogether devoid of parachute folds, although it possesses the distinctive climbing scales.

African Flying-Squirrels differ sufficiently from their Asiatic and American cousins to make it certain that the parachute folds

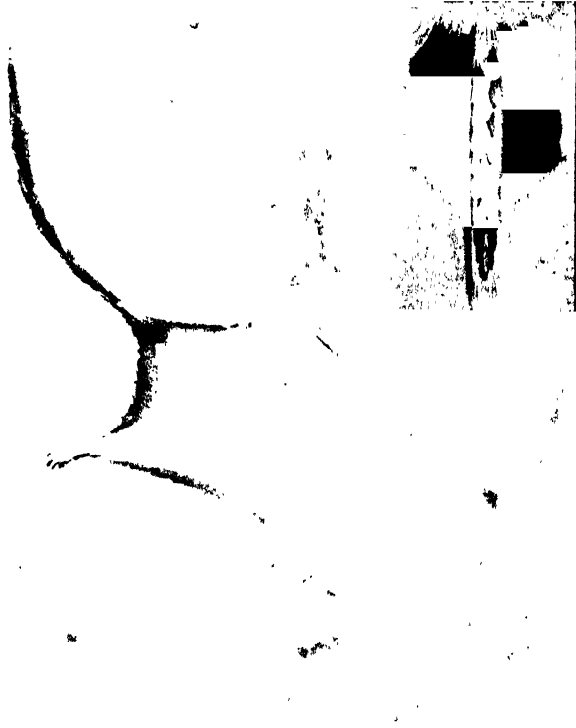

Fig. 823 —African Flying-Squirrel (*Anomalurus peli*). The small drawing shows the climbing-scales at the root of the tail

have been independently evolved in the two cases. And, on this view, the variation in detail already described is only what might be expected.

Pouched Mammals (Marsupialia) as Parachutists.—Different members of this order have adapted themselves to almost every conceivable mode of life, and it is not surprising to find that some of them are expert parachutists. These are the Flying Phalangers of the Australian region. One of the best-known species is the Squirrel Flying Phalanger or Sugar Squirrel (*Petaurus sciureus*) of East Australia, in which there is a well-developed

fold stretching from hand to foot, while the tail is large and bushy. The length of the head and body is about 9 inches. The movements of this animal through the air, as indeed of flying phalangers generally, are much like those already described for other parachute mammals. Semon (in *In the Australian Bush*) gives the following account of the matter for this and an allied but smaller species (*P. breviceps*, variety

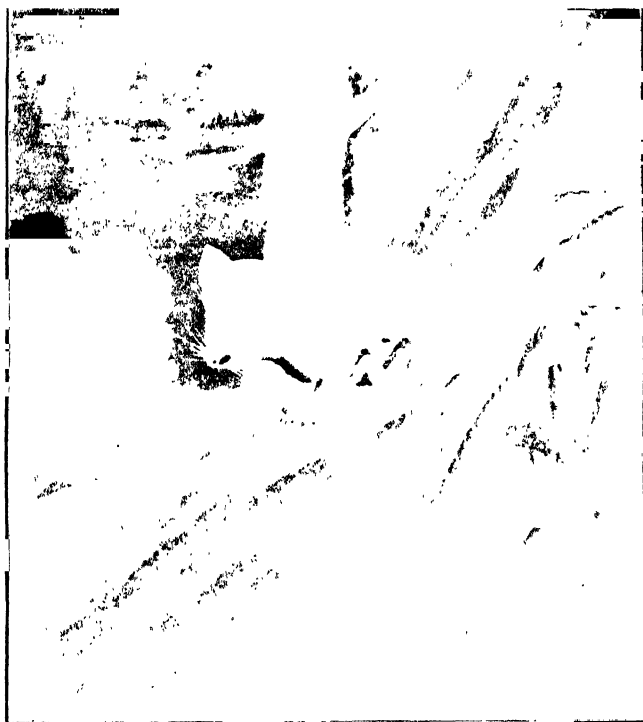

Fig. 824 —Australian Flying-Mouse (*Acrobates pygmaeus*)

typicus):—“With the greatest agility they climb up the trunk of the eucalyptus-trees to the very tops. Then they spread out a fold of skin, which connects their limbs and tail and serves as a parachute, and noiselessly, in gentle flight, float downward towards the foot of a distant tree, to the top of which they immediately ascend. Thus I sometimes saw them float through distances of fifty yards, never failing their goal, and even managing to change their direction in the midst of their downward sweep, and to settle on another tree than that they had first chosen.” We have here clear evidence proving considerable steering power.

The Taguan (*Petauroides volans*) of Queensland and Victoria is rather more than twice the size of the Sugar Squirrel, and the tip of its tail is devoid of hair. Besides this, the lateral parachute fold is very small in the region of the forearm and lower leg.

The smallest and most elegant of the Flying Phalangers is the diminutive Flying-Mouse (*Acrobates pygmæus*, fig. 824) of East Australia. The parachute fold extends only from ankle to knee, but its small extent is partly made up for by the long flat tail, the hair on which is so arranged as to give it the appearance of a feather.

Speaking of these three genera of parachute Marsupials (i.e. *Petaurus*, *Petauroides*, and *Acrobates*), Beddard remarks (in *The Cambridge Natural History*):—"As to these Flying Phalangers, it is exceedingly instructive to observe that the same method of 'flight' has been apparently evolved three times; for the three genera are each of them specially related to a separate type of non-flying Phalanger".

BIRDS (AVES) AS PARACHUTISTS.—The wings of flying birds have passive as well as active uses. They are employed, for example, after the fashion of a parachute during descent from the air. This is illustrated in fig. 825 by a series of instantaneous photographs of a Pigeon taken during its downward course to the ground.

REPTILES (REPTILIA) AS PARACHUTISTS.—One of the Lizards native to the Malay region is a parachuting Gecko (*Ptychozoon homalocephalum*, fig. 826). Its fingers and toes are specialized for climbing, as in the better known members of its family (see p. 268). But it differs from these in possessing parachute folds on the sides of head, trunk, tail, and limbs, while a further increase of surface is afforded by webs which stretch between the digits.



Fig. 825.—Instantaneous Photographs of a Pigeon descending to the Ground. Read from right to left

Still more remarkable inhabitants of the same part of the world are the curious little lizards known as Flying-Dragons (species of *Draco*). But they are by no means so formidable as the name suggests, for the head and body are only some 5 inches in length, to which must be added a slender tail of about the same degree of elongation. These parachute organs consist of a pair of large wing-like folds at the sides of the flattened body, and these are supported by five or six pairs of the hinder ribs, which are of extraordinary length. The "wings" can be either expanded or folded up at will. These little dragons are very attractively coloured. In one well-known species (*Draco volans*), for example, the upper side is brown, with dark bands and flecks, and gleams like metal, while the parachute folds are black and orange. The little pouch (gular sac) under the throat affords an addition to the colour-scheme, for it is blue in the female and orange in the male. As to the habits of these lizards, Gadow (in *The Cambridge Natural History*) makes the following remarks:—"The 'Flying-Dragons' use their wings as parachutes, but their sailing powers are said to be very moderate. Certainly they do not fly by



Fig. 826.—Fringed Gecko (*Ptychozoon homalocephalum*)

moving the wings, but when at rest upon a branch amidst the luxuriant vegetation, and in the immediate neighbourhood of gorgeously-coloured flowers, which partly conceal them by their likeness, they greatly resemble butterflies, especially since they have the habit of opening and folding their pretty wings."

AMPHIBIANS (AMPHIBIA) AS PARACHUTISTS.—A few species of tree-frog native to the East Indies are sufficiently specialized in connection (?) with the parachuting habit as to have earned the name of Flying-Frogs. The first known creature of this sort (*Rhacophorus nigropalmatus*) was seen in Borneo by Wallace, who

makes the following remarks about it (in *The Malay Archipelago*):—"One of the most curious and interesting amphibians which I met with in Borneo was a large tree-frog, which was brought me by one of the Chinese workmen. He assured me that he had seen it come down in a slanting direction from a high tree, as if it flew. On examining it, I found the toes very long and fully webbed to their very extremity. The fore-legs were also bordered by a membrane, and the body was capable of considerable inflation. The back and limbs were of a very deep shining green colour, the under surface and the inner toes yellow, while the webs were black, rayed with yellow. . . As the extremities of the toes have dilated discs for adhesion, showing the creature to be a true tree-frog, it is difficult to imagine that this immense membrane of the toes can be for the purpose of swimming only, and the account of the Chinaman that it flew down from the tree becomes more credible. This is, I believe, the first instance known of a 'flying frog', and it is very interesting to Darwinians, as showing that the variability of the toes, which have been already modified for purposes of swimming and adhesive climbing, has been taken advantage of to enable an allied species to pass through the air like the flying lizard." Grave doubt has recently been thrown on the Chinaman's statement, and for the present the matter must remain undecided. This species also inhabits Sumatra and the Malay Peninsula, and an allied form (*R. Reinwardti*) is found in Java and Sumatra.

FISHES (PISCES) AS PARACHUTISTS.—In the cases so far described the parachuting organs facilitate descent from a height, but in Flying-Fishes (species of *Exocetus*) the object attained is somewhat different. The so-called "wings" are constituted by the enormously enlarged pectoral fins, which, when one of these creatures vigorously projects itself out of the water, act kite-fashion, assisting the body to glide as it were up an inclined plane of air. At the same time the large resisting surface which they present hinders a too rapid return to the water. There is no evidence to show that these fins can be employed as wings, so that it is not a true case of flight. Under favourable circumstances a considerable speed (over 10 miles an hour) is attained, and a distance of some two or three hundred yards traversed: The "flight" is usually longest when directed *against* the wind. The tail of a Flying-Fish is of unusual form, being unsymmetrical,

with the lower part better developed than the upper, and this is an adaptation to the habit of frequently leaving the water. For this particular shape of tail gives the body a bias upwards, and unless this is corrected by means of the pectoral fins the fish rises obliquely to the surface, thence passing into the air when the swimming movements are vigorous. As we have seen (p. 41), the tail of a Shark is also unsymmetrical, with the upper lobe better developed, thus facilitating progress downwards, while the symmetrical tail of an ordinary bony fish, such as a Herring, favours swimming directly forwards.

SPIDERS (ARANEIDÆ) AS PARACHUTISTS.—The Australian Flying-Spider (*Attus volans*, fig. 827), a hunting form, possesses para-



Fig 827.—Australian Flying-Spider (*Attus volans*), showing the triangular parachute-flap on either side of the abdomen

chute organs having a similar use to the enlarged pectoral fins of a Flying-Fish. Either side of the abdominal region is provided with a flap, and when the spider launches itself into the air these flaps are spread out, presumably increasing the length of the leap, and diminishing shock when the ground is once more reached.

KITE-FLYING

We have seen that the wings of flying birds may be passively used as parachutes (p. 286), and they also serve as kites by which their owners are borne aloft without effort, under certain conditions to be spoken of more fully in the section Flight. Much the same thing is true of Flying-Insects, Flying-Fishes, and the Australian Flying-Spider.

A more remarkable case is presented by the larva of a two-

winged fly, which, though unprovided with any special expansions of the body, is carried passively along by the wind, being reminiscent in this respect of certain small marine animals that drift along in the surface currents of the sea. The fly in question (*Hirmonneura obscura*) deposits her eggs in the tunnels which have been excavated in logs by wood-boring insects. When the maggots hatch out they make their way to the outside of the log, and sit up on their tails till they are blown away by the wind. When next met with they are found preying upon certain beetle-grubs which live in turf, but whether they attain their goal by pure chance is not known.

Many Spiders and some few Insects spin threads which present a sufficient surface to the wind to enable them to act as kites, bearing their constructors through the air, or at any rate rendering aerial progress more easy.

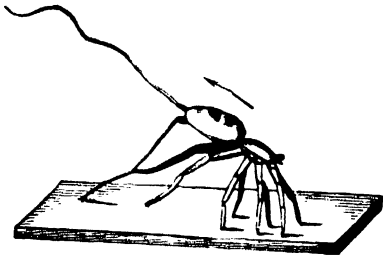

Fig. 828.—Young Spider spinning a "Gossamer" Thread. The arrow shows the direction of the wind

SPIDERS (ARANEIDÆ) AS KITE-FLYERS. — The floating spider-threads familiar to all as "gossamer" were once believed to be produced by one particular kind of spider, but it is now known that they are spun by young individuals of many species. They are particularly abundant in early autumn, at the time associated with the slaughter of Michaelmas geese, and as the word is supposed to be a corruption of "goose-summer", it was possibly originally given on this account.

A young spider desirous of floating through the air by this means stands firmly on its first three pairs of legs (fig. 828), and begins the work of spinning, using the last pair of legs for manipulating the threads. One of these is an anchor-line, and is severed when the gossamer thread is sufficiently long to serve its purpose. Kriehoff gives the following account of the matter (in *Das Tierreich*):—"Webs not only enable spiders to secure their prey, but also serve as a means of locomotion. In autumn young spiders begin to disperse themselves, casting out in any desired direction threads of such wondrous fineness as only to be visible in sunlight. By clinging to these with legs drawn in, these daring aeronauts are able to traverse considerable distances. The object of this procedure

is probably to reach suitable winter quarters, as their weakness unfits them for the struggle for existence with older and stronger relatives in the original home. And by this instinct they unconsciously increase the area of distribution of their species, and contribute to its preservation. On fine autumn days we may see thousands upon thousands of these wind-borne gossamer threads, often compacted into thick web-like masses, some sweeping through the air, some hanging from flowers or other objects, others again spread out over meadows and stubble-fields, where, shining and sparkling in the sun like silver and diamonds, they produce what is known as 'wives' summer' or 'old wives' summer'. As soon as spiders emerge from their winter quarters in spring-time the same appearance repeats itself, though in much less degree, and is then known as 'maidens' summer'. These shimmering meteors in the air, woven of dew and silver, are described by folk-lore as the cunning handiwork of elves, taught by Freya and Holda, the renowned spinners of Asgaard."

TWO-WINGED FLIES (DIPTERA) AS KITE-FLYERS.—One family of this order includes a large number of predaceous forms called by the Germans Dancing-Flies (*Empidæ*), in reference to the complex aerial evolutions which many of them execute. In some of these (species of *Hilara*) small silken nets are carried about by the male, attached to his hind-legs, and probably serving as kites which facilitate the movements in the air. Another use of these singular constructions would appear to be the capture and storage of smaller flies to be used as food. It is suggested that the particular purpose served varies with the species.

CHAPTER LII

MUSCULAR LOCOMOTION—FLYING MAMMALS, BIRDS, AND REPTILES

The Bats (Chiroptera) among Mammals are expert flyers, and so, of course, are the vast majority of Birds, while probably all of them which do not now possess this power are descended from forms which did. One long since extinct order of Reptiles (Pterosauria) included a great variety of species capable of flight.

THE FLIGHT OF BATS (CHIROPTERA)

The Bats are probably an offshoot from the stock in which the Insect-Eating Mammals (Insectivora) took origin, though our knowledge of their past history is far too imperfect to throw any light upon the stages in the evolution of their organs of flight. But the order is one of very considerable antiquity, and such evidence as has been obtained proves that the oldest species so far known were fully equipped with flying membranes.

On examining a typical Bat, such as the Pipistrelle (*Vesperugo pipistrellus*, fig. 829), we find a thin flying-membrane (patagium) in the form of a fold of skin, extending between fore and hind limb on either side. There is also a fold between the neck and the front edge of the fore-limb, and a steering membrane which unites the hind-limbs with one another and the tail. In some bats the latter is partly free. As to their extent, the various folds are very like the parachuting folds of a Colugo (see p. 282), but are much thinner than in that animal. There is a remarkable difference between the two cases as regards structure. For the Bat's forearm is remarkable long, and bent sharply forwards on the upper-arm, and though the hook-bearing thumb is relatively short, the fingers are enormously drawn out, serving as supports to the main part of the flying membrane, and comparable to the ribs of an umbrella. And it may be added that both

bat's wing and umbrella fold up in a similar way. The steering membrane is supported on either side by a gristly spur which projects from the ankle.

Examination of a Bat's skeleton (fig. 830) brings out some of the peculiarities more clearly. It will be seen that the fingers, in spite of their length, only possess three supporting bones apiece,

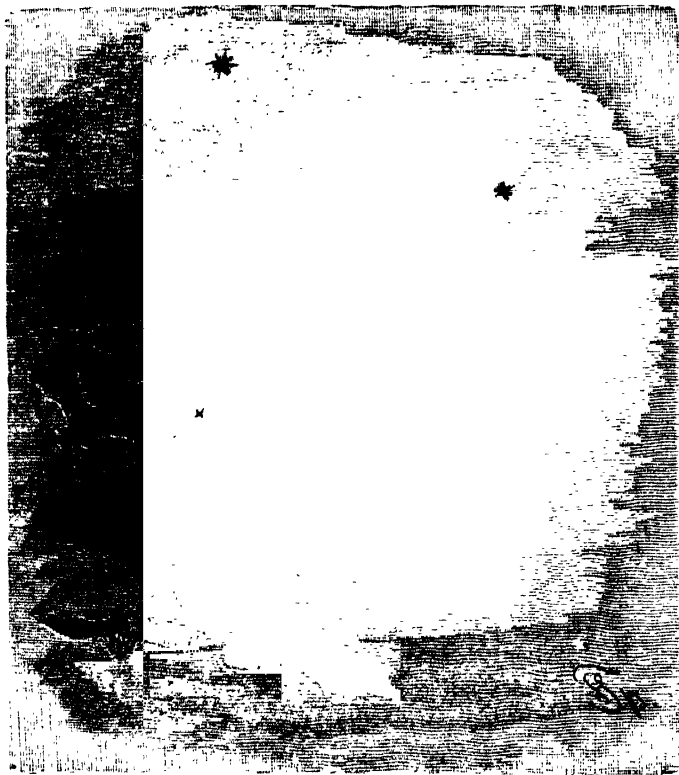

Fig. 829 — Pipistrelles (*Pipistrellus pipistrellus*)

the usual number among Mammals. As in all cases where the fore-limbs have free lateral movements, there are well-developed collar-bones, propping up the shoulders from the inner side. There is a prominent ridge or keel running along the sternum, and correlated with the existence of large pectoral or breast-muscles, the principal agents in moving the wings. The hind-limbs are turned backwards in a remarkable manner, and the size of the flying-membrane is therefore greater in that direction than would otherwise be the case.

The parachuting arrangements in a Colugo (see p. 282) afford

a hint as to the way in which the flying-membranes of bats have been evolved. For in this creature we find that though the fingers are not elongated they are webbed, and the steering-power which is undoubtedly possessed may be associated with up-and-down movement of the arms. Here we probably have the first beginnings of the power of flight, which essentially depends upon movements of the kind. The webbed hands, being the parts brought down upon the air with greatest vigour, would have a very special value even at an early stage. Hence

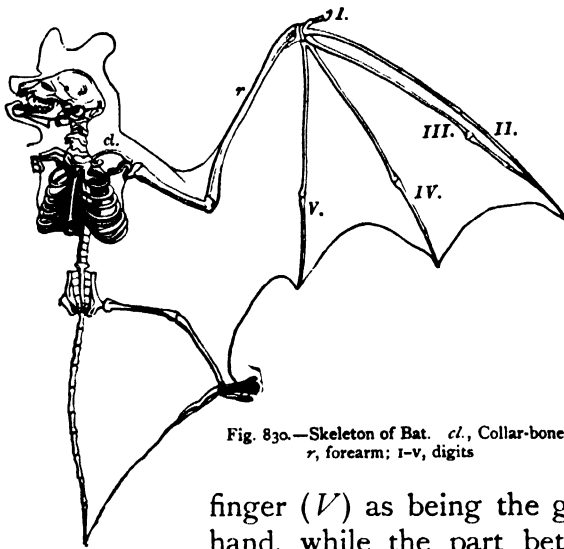

Fig. 830.—Skeleton of Bat. *cl.*, Collar-bone; *r.*, forearm; I-V, digits

we are able to picture a gradual elongation of digits, with corresponding increase of the webs between them, the lateral parachuting membrane being at the same time gradually merged in the enlarging hand. We may, in fact, regard (see fig. 830) that part of the Bat's wing external to the little

finger (*V*) as being the greatly-developed webbed hand, while the part between this and the body is the old lateral parachuting fold.

Considering the very considerable powers of flight which Bats possess, it is not surprising to find that they have a very wide geographical distribution. Speaking of the small forms which make up the largest family (*Vespertilionidae*) of the order, Wallace says (in *The Geographical Distribution of Animals*):—“They range over almost the whole globe, being apparently only limited by the necessity of procuring insect food. In America they are found as far north as Hudson's Bay and the Columbia river; and in Europe they approach, if they do not pass, the Arctic circle. Such remote islands as the Azores, Bermudas, Fiji Islands, Sandwich Islands, and New Zealand, all possess species of this group of bats, some of which probably inhabit every island in warm or temperate parts of the globe.” As to powers of flight, the same author remarks that Bats are capable of tra-

versing considerable spaces of sea, since two North American species either regularly or occasionally visit the Bermudas, a distance of 600 miles from the mainland.

THE FLIGHT OF BIRDS (AVES)

In spite of the many elaborate investigations which have been made on this subject, there are numerous points in regard to which we are comparatively ignorant, and the whole subject is so exceedingly complicated that the space here available will only serve for a brief survey of the more salient facts.

It will be convenient to deal in the first place with the structure of Birds in relation to flight, and afterwards to consider the flying mechanism in action.

STRUCTURE OF BIRDS IN RELATION TO FLIGHT.—The entire organism of Flying Birds has undergone very great specialization as a result of very perfect adaptation to aerial locomotion. The compact boat-shaped body and pointed head are well-suited to cleave the air with a minimum resistance, strongly reminding us of the "lines" of Fishes and Whales, which fit them to pass with ease through the water (see pp. 41 and 83).

The fore-limbs have undergone remarkable modification by which they have been converted into the chief agents of flight, but in spite of this they are merely one more variation on the common plan of structure that can be made out in the long series of land Vertebrates, from Amphibians to Mammals. If we look at the right-hand side of a Bird the partly-extended wing may be diagrammatically represented by a capital Z, the lower horizontal line corresponding to the upper-arm, the slanting stroke to the forearm, and the upper horizontal line to the hand. • The digits have been reduced to three, which are usually considered to be the thumb, first finger, and second finger. The thumb may bear a claw, and this is occasionally the case with the first finger as well. Although a Bird's wing differs in many ways from that of a Bat, *e.g.* in the fact that the digits are not elongated, there are nevertheless certain resemblances between the two. For stretching between upper-arm and forearm there is a fold which may be called the front wing-membrane, while a much smaller hind wing-membrane extends between upper-arm and body (see fig. 834). The former is quite comparable to the front para-

chuting fold of a Bat, and the latter to that part of the "wing" of that animal which occupies the region of the arm-pit. As we shall see later, these folds have a purpose to serve in flight.

The direct evidence so far at our disposal as to the evolution of Birds' wings is unfortunately exceedingly scanty. For in the oldest known extinct member of this class (*Archæopteryx*, fig. 831) the fore-limb was a well-developed wing, though somewhat



Fig. 831.—Extinct Toothed Bird (*Archæopteryx*)

j, Toothed jaws; *cl*, collar-bone; *u*, ulna; 2 and 3, second and third fingers; *s*, shin-bone; *sh*, shank-bone, III, third toe; *t*, axis of tail.

less specialized than in living forms. For example, claws were present on all three digits. Although an undoubted bird, with wings and feathers, this ancient type approximated to reptiles in several respects, notably in the presence of well-developed teeth and a long tail. There are good reasons for thinking that Birds are descended from reptilian ancestors, though none of the known groups of Reptiles can be worked into their pedigree. But it is permissible to picture those ancestors as hopping forms (see p. 185), which first took to climbing and then to parachuting. And it is quite conceivable that the two wing-membranes of a Bird are the last remains of parachuting arrangements, of which

the hinder one has long since been superseded by feathers, the evolution of which was associated with the development of flying powers. This view, however, must only be regarded as a speculation.

Feathers.—The possession of feathers is so eminently characteristic of Birds, that to define these as "Feathered Animals" would suffice to mark them off from all other creatures, living or extinct, of which we have at present any knowledge. As regards flight, the most important of these structures are the "quills" attached to wing and tail. The former are known as "rowing feathers" (remiges) and the latter as "steering feathers"

(rectrices). Wing-quills and tail-quills are respectively covered to some extent by wing-coverts and tail-coverts.

The structure of feathers has already been dealt with (see vol. i, p. 142), and it need only be repeated here that they combine lightness with strength in a remarkable way, and that the little branches which make up the thin expansion on either side of the central shaft are hooked together in an elaborate manner. We have no direct evidence regarding the evolution of feathers, but they may be supposed to have originated by the fraying out of the scales no doubt possessed by ancestral forms. And it is interesting to note that the legs of birds are still partly clothed by overlapping scales.

The body of a Bird is light in proportion to its bulk, for although the bones have a dense external layer, they are otherwise of spongy texture, and commonly more or less traversed by air-spaces, especially in forms which fly well. The lungs communicate with large air-sacs, which take up a good deal of space within the body, and communicate with some of the air-sacs in the bones. Not only is an increase of lightness gained in this manner, but also a larger external surface for the attachment of muscles than would otherwise be the case. Too much stress must not be laid upon the lightness of the body, and it would be entirely erroneous to compare a bird with a balloon. It would be much more correct to draw a parallel between it and a flying-machine, for active flight is a matter of sheer muscular effort. Even here, however, the principles of the kite and parachute are involved, and this is still more the case in those varieties of movement through the air known as passive flight. The heavier parts of the body are placed towards the under surface, and stability is thus secured.

The immense amount of energy displayed by flying birds is associated with great activity of the circulatory and breathing organs, as to which they stand pre-eminent among backboned animals (see vol. ii, p. 426). The chief significance of air-sacs and air-spaces is probably to be found in the fact that they increase the efficiency of the lungs. This activity is of course associated with a rapid wasting of the substance of the body, which has to be made good by a correspondingly large amount of food. And it is therefore not surprising to find that birds are possessed of large appetites and great digestive powers.

The Skeletons of Birds in relation to Flight.—As in the case of the feathers, unusual lightness and great firmness are here combined. The joints of the backbone in the regions of the chest and loins are closely fused together so as to constitute a firm central support, to the front part of which the large breastbone is hung by means of the ribs. And the last few joints of the tail-region are fused into a ploughshare bone, from which the steering feathers radiate like a fan. This is a marked specialization as compared with the extinct toothed bird (*Archæopteryx*) already mentioned (see p. 296) as the oldest known member of its class. For this creature possessed a long tail like that of a lizard, with a series of quill-feathers along either side. Possibly this remarkable organ was used parachute fashion. It would, at

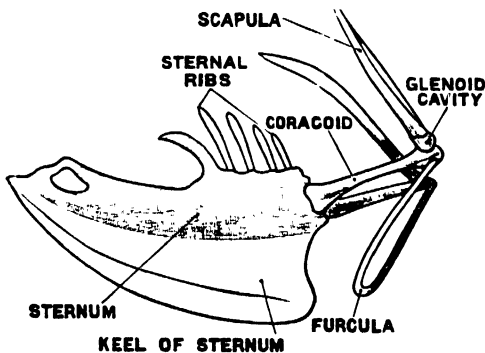

Fig. 832.—Shoulder-girdles and Breastbone of Pigeon

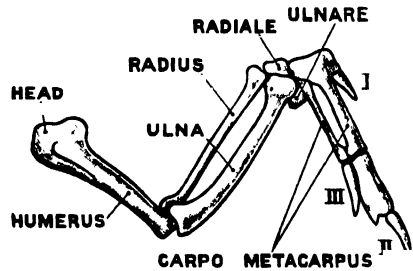

Fig. 833.—Wing-bones of Pigeon. I-III, digits

any rate, be a hindrance rather than a help to active flight, and by gradual shortening became converted long ages since into the stumpy form with which we are familiar in recent birds.

The skeleton of the wing naturally exhibits many modifications in relation to flight. The shoulder-girdle (fig. 832) consists of three bones. One is the sabre-shaped shoulder-blade (scapula), which is firmly bound by muscles to the skeleton of the trunk. From it a stout bone (the coracoid) runs down to the breastbone (sternum), with which it is closely united, thus acting as a prop. The third element of the girdle is the collar-bone (clavicle), which unites with its fellow to make up the "merry-thought" (furcula). This helps to keep the two shoulder-girdles apart, but, being elastic, also permits a certain amount of play. Passing now to the bones of the free part of the wing (fig. 833), we find that the head of the upper-arm bone (humerus) fits into a cup (glenoid cavity) where shoulder-blade and coracoid meet, and

at this joint a good deal of rotatory movement is possible, a matter of great importance in adjusting the wing to advantageous positions for flight. The two usual bones (radius and ulna) are found in the forearm, but no twisting movement is possible at the elbow, as in ourselves. In this case it would detract from firmness and therefore be a disadvantage. A certain amount of fusion has taken place in the hand; here again, no doubt, in the interests of firmness. For though two of the little wrist-bones (radiale and ulnare) are separate, the remainder have united with the elements making up the palm-region (metacarpus). This bears the three digits, of which the middle one is the largest and most important.

The breastbone (sternum) of a flying bird is exceedingly large, and a vertical plate or keel projects from its under surface, giving additional surface for the attachment of the great muscles of flight which make up the flesh of the breast.

Chief Muscles of Flight (fig. 834).—So far we have been concerned with the supporting framework, and, as in other cases, the actual movements are brought about by the shortening or contraction of muscles. Of these the largest and most important are situated entirely or partly in the trunk, and are attached to the bones they move by means of inelastic cords or tendons. There are, however, a large number of smaller muscles situated entirely in the wing itself. And besides tendons there are other fibrous bands known as ligaments, which connect bones, &c., together. The advantageous situation of the large muscles is commented on very graphically in the following passage taken from Headley (*Structure and Life of Birds*):—"It is a strange thing that in these days when it is boasted that machines can be made to do most things that a man can do, that sailors should still have to run up the rigging, be the weather foul or fair, and straddle across the yards, in order to furl or set the sails. It would not seem to be beyond human ingenuity to devise machinery by the aid of which this work should be managed from the deck. Some progress towards this has, I believe, been made. In the bird we find such machinery brought to great perfection. Instead of men we have muscles, and by the machinery of tendons and ligaments these muscles, situated on or near the body, are able to spread the wings and regulate their utmost extremities. It is all-important that it should be so. All the

weighty organs must be accumulated in the body. To speak metaphorically, the wings must be made up of very little besides masts, sails, and cordage."

The two largest muscles concerned with flight are those which make up the great fleshy mass of the breast, and of which the use is to lower and raise the wings (see fig. 834). By far the bigger of the two is the great breast muscle (*pectoralis major*), which is attached to the lower side of the humerus not far from the shoulder-joint, and by its contraction pulls down the wing.

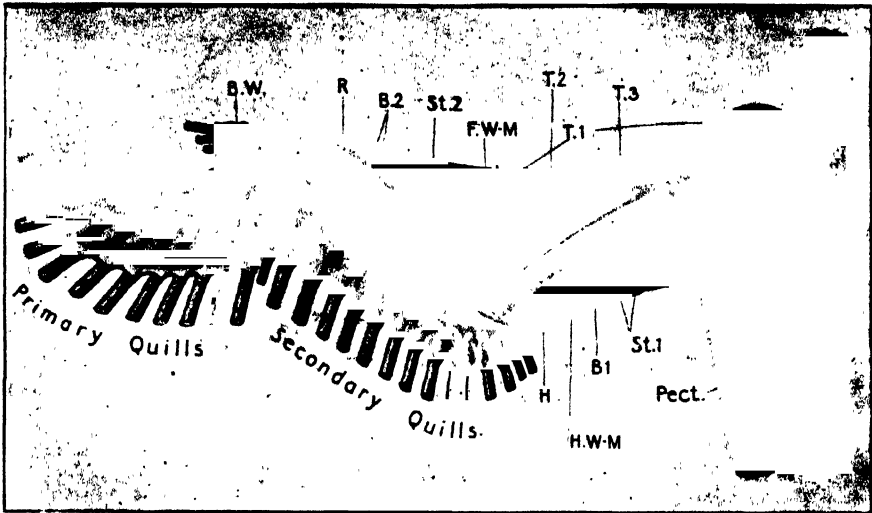

Fig. 834.—Structure of Pheasant's Wing

H, Humerus; R, radius; B.W., bastard-wing; F.W.M. and H.W.M., front and hind wing-membranes; St. 1 and St. 2, straightening muscles; B. 1 and B. 2, bending muscles; T. 1, T. 2, and T. 3, tensor muscles; Pect., part of great breast-muscle (*pectoralis major*).

It covers the smaller elevator muscle (*subclavius*), of which the work is to raise the wing. But being below this, its tendon has to take a rather curious course. It runs through a hole situated where the three bones of the shoulder meet, and then bends down to be attached to the upper side of the humerus not far from the shoulder-joint. We may compare it to a rope that passes over a pulley. Some other important muscles are shown in fig. 834. Among them may be mentioned:—(1) Muscles which straighten out the forearm on the upper-arm (St. 1), and the hand on the forearm (St. 2); (2) Muscles which bend the forearm on the upper-arm (B.1.), and the hand on the forearm (B.2.); (3) Tensor muscles (T.1, T.2, T.3), which keep the

front wing-membrane stretched taut. There is another tendon (not shown in the figure) which performs the same office for the hind wing-membrane. Besides these muscles there are many others which adjust the parts of the wing in various ways. The thumb, for example, is well off in this respect.

One or two other points in the structure of the wing deserve notice here. The long tendon of one of the tensor muscles (T. 1) runs along the edge of the front wing-membrane to be attached to the hand. Unlike tendons in general it is elastic, and is stretched to three times its normal length when the wing is extended. This helps to keep the membrane taut, and the hand in line with the forearm. And when the bird folds up its wing the elasticity of this tendon comes into play and gives considerable assistance.

The large rowing-feathers are divided into two sets—primary quills attached to the hand, and secondary quills borne by the forearm. There is also a tuft of feathers on the thumb, making up the bastard-wing. When the wing is extended the quills spread out to give an expanded surface without muscular effort. This is effected by the agency of an elastic band or ligament which stretches from hand to arm-pit, and is pierced by the bases of all the secondary and some of the primary quills. Its work is aided by a second similar band which runs under the quills nearer their attachment to the wing. A still more beautiful mechanical arrangement affects the secondary quills only, bringing it about that during the down-stroke of the wing they are pressed firmly together so that no air can pass between them, while during the up-stroke they are slightly separated so as to allow of such passage, thereby diminishing the amount of work. Dissection reveals the cause of this. From the back edge of the muscle (B. 2) which bends the hand on the forearm a minute tendon passes to each secondary quill. When the wing is extended these tendons pull the overlapping quills together so that an unbroken surface is constituted. But when the up-stroke is made the hand is bent to some extent upon the forearm, the little tendons relax, and the quills being loosened, permit air to pass between them.

The stumpy tail with its radiating steering-feathers is well provided with muscles, by which it can be raised, lowered, and otherwise adjusted so that it may be able to perform its work

in directing the course of flight. It also possesses elastic ligaments.

ACTIVE FLIGHT.—For a bird, in the absence of wind, to rise from the ground involves very considerable muscular effort. If the legs are fairly long the start is greatly helped by a standing or running jump, but in any case the wings have to be moved rapidly up and down until the bird is fairly under weigh. As will be explained later, the support afforded by the air is dependent upon the speed attained. Let us now suppose that the bird is flying along, its wings having acquired sufficient “purchase” upon the air for propulsive purposes. It will be seen from fig. 835 that each wing may now be considered a lever of the third

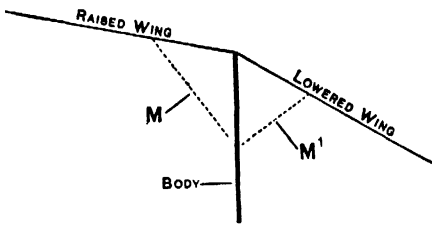

Fig. 835. —Diagram of Wing-Action (end view)

M and *M'*, Great pectoral muscle relaxed and contracted respectively.

order, with the motive power acting between the fulcrum and the weight. The fulcrum here is not a firm fixed point, as in a crowbar used to raise a block of stone, but is constituted by the resistance of the air, and may be conveniently considered as located near the end of the wing. A similar yielding ful-

crum is presented by the water to the blade of an oar used to propel a boat. The weight to be moved is that of the bird, and the power is supplied by the great pectoral muscle. That this is attached very near to the shoulder means great expenditure of force, with corresponding gain in speed, a matter which is of the greatest importance in this case. The most effective part of the wing is clearly that which is furthest from the body, for this moves most rapidly, and therefore gets the best grip upon the air. The near section, though less useful in this respect, is of greater value as a parachute to retard descent between the down-strokes, and the wing-membranes are of considerable use in this respect. It must also be remembered that the wing is not flat, but concave below and convex above, which gives a better hold on the air during the down-stroke and makes the up-stroke more easy. The same ends are furthered by the arrangements for adjusting the quills, of which an account has already been given (p. 301).

The action of the wings has so far been treated as if they

SWALLOWS AND MARTINS CHASING INSECTS

The plate represents our three native species of the Swallow Family (*Hirundinidae*), *i.e.*, (1) the Common Swallow (*Hirundo rustica*); (2) the House-Martin (*Chelidon urbica*); and (3) the Sand-Martin (*Cotile riparia*). These summer visitors are remarkable for great powers of flight, associated with long pointed wings, a forked tail, and short, weak legs. They are untiring in the pursuit of insects, their short broad beaks and wide gape being adaptations for catching these on the wing. As weather-prophets they are justly esteemed, flying high when the air is dry, and low when it is charged with moisture, in accordance with the habits of their prey. The Swallow is the largest of the three species, and its mud-nests, resembling half a saucer in shape, are built by preference under the eaves of houses. Those of the House-Martin are to be seen in similar situations, and differ in being roofed over. The Sand-Martin, as the name indicates, nests in sand-banks, digging out a long burrow for the purpose. Swallows and Martins alike return to the same nest year after year.

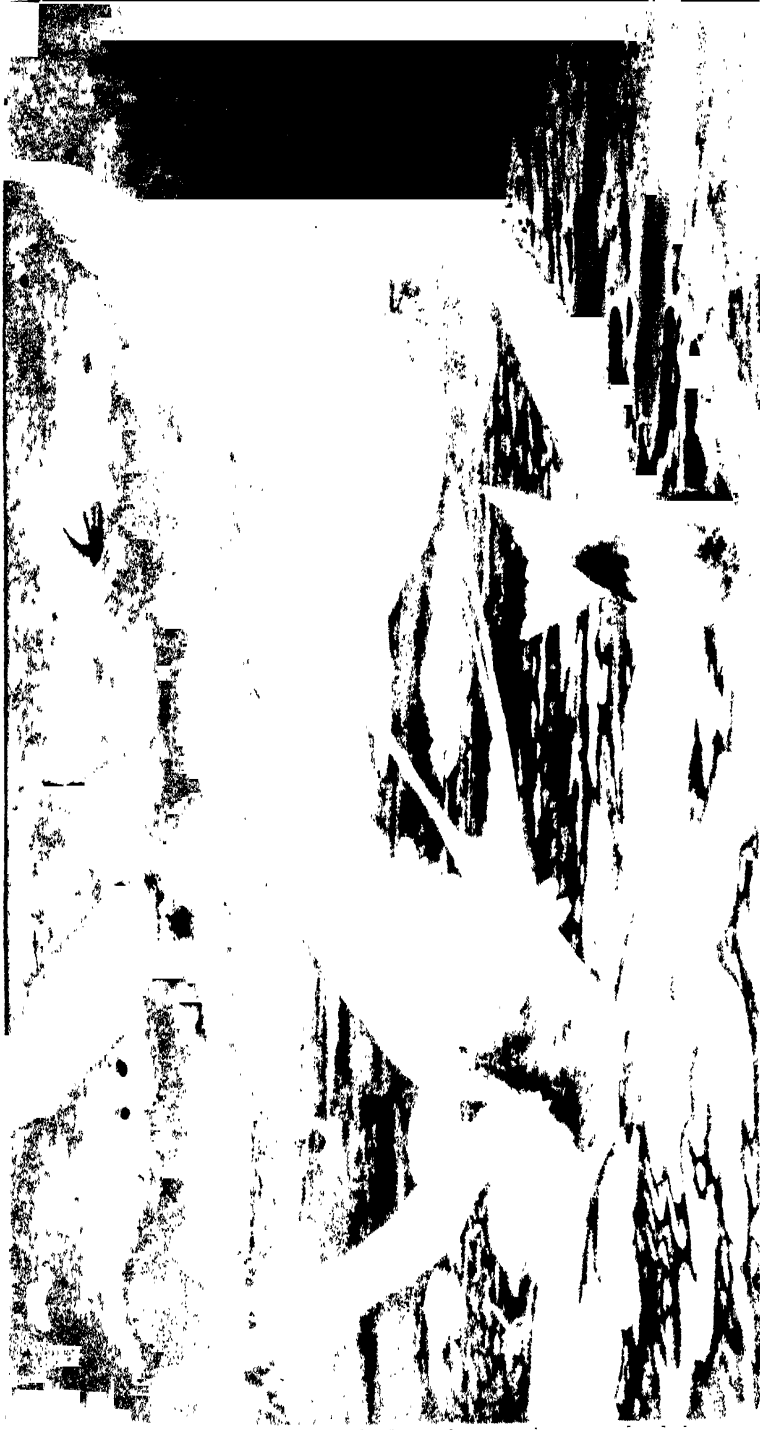

SWALLOWS AND MARTINS CHASING INSECTS

- 1 Swallow (*Hirundo rustica*) 2 House Martin (*H. fuliginosa*) 3 Sand Martin (*Cotile riparia*)

simply raised the body in the air, and this would be the case if they merely moved up and down as though there were hinge-joints at the shoulders. But the joints in question allow of a certain amount of rotation, which actually takes place during onward flight. When the down-stroke is made the wing is brought forwards as well as downwards, its under side being inclined so as to face both downwards and backwards. And as a result of this the push of the wing, instead of being entirely expended in raising the bird and preventing it from falling, is only partly employed for this purpose, the rest of it acting backward, and therefore propelling the body onwards. And the angle of the wings can be so adjusted that the part of the push acting directly downwards is only just sufficient to maintain the height above the ground already attained, in which case the bird progresses in a horizontal direction, and does not continue to rise. Under these circumstances the hinder part of the body is raised by appropriate muscles when the down-stroke is given, which furthers the end in view.

During the up-stroke, which is the more rapid of the two, the wing is partly bent, and moved upwards and backwards, the under surface being now directed downwards and forwards. Some of the details of wing-movement may be gathered by reference to fig. 836, taken from serial photographs of flying birds.

A bird, such as a Lark, rises steeply into the air, not by adjusting the wing horizontally, as might be expected, but by inclining its body strongly, which increases the resistance to horizontal movement, and therefore favours upward progress.

The fact that the wings are not held horizontally but inclined during ordinary flight of course diminishes their efficiency when regarded as organs for preventing the body from falling. If the bird remained in one place this would be a serious matter, but it is in reality of little practical consequence, for it has been shown experimentally that the support given by the air increases very rapidly as speed is got up. Besides which, air-currents may help both in supporting the body and in furthering onward movement.

Steering and Stopping.—This is undoubtedly effected in various ways. The tail is an adjustable rudder, the body can be placed at various angles, and the wings are not of necessity moved together in precisely the same manner.

Some birds are able to stop quite suddenly, and turn with great rapidity. When a Pigeon does this its body assumes a vertical position, and the tail is fully spread out. In this way a maximum resistance to further onward progress is brought into play. It is possible that the bastard-wing may give some help in stopping and turning movements, but further investigation is needed before we can feel certain as to the part it plays in flight.

Powerful and rapid flight is commonly correlated with great

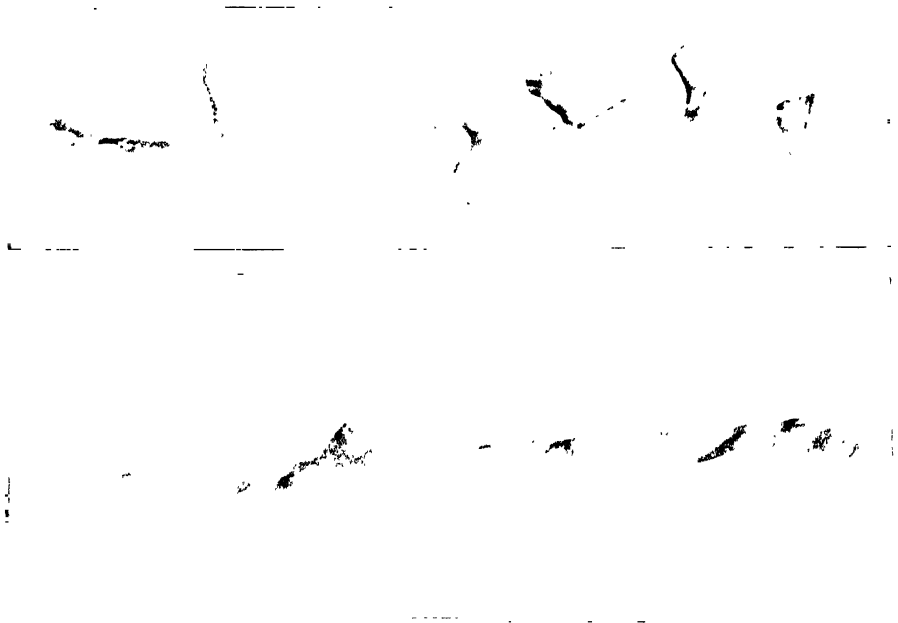

Fig. 836.—Instantaneous Photographs of Phases in Flight. The upper figure gives deliberate flight of a Gull (read from right to left), and the lower shows the rapid flight of a Pigeon (read from left to right). The photographs were taken at very short intervals in the latter case, and therefore overlap.

expanse of wing, but the flying possibilities of any particular bird depend upon many other things besides this. For instance, the shape of the wings is of importance. In expert flyers they are usually long and pointed, as may be seen to perfection in Swallows and Swifts. But short wings moved with great rapidity may also be very effective. And it is sufficiently obvious that long-distance flying and rapid flight for a short time are likely to be associated with arrangements of somewhat different kind.

There appears to be a dearth of accurate observations regarding the speed of various birds, especially the average that can be maintained for long distances. But it appears that 60 miles an

hour is no extraordinary pace for Swallows and Swifts, while 36 miles an hour is a favourable average for Pigeons. Much higher speeds have, however, been recorded, *e.g.* 71 miles per hour (for a distance of 82 miles) in the case of a Pigeon, and 106 miles per hour (for 160 miles) in the case of a Swallow. The achievements of many migrant birds, extended as they often are over enormous distances, are remarkable as illustrating both speed and endurance. The American Golden Plover (*Charadrius Virginicus*), for example, during its autumnal migration to the South, is credited with being continuously on the wing for a distance of some 1700 miles, as it passes oversea from Nova Scotia to South America *viâ* the West Indies. In such a case the speed must be very considerable, as birds cannot remain without food for an indefinite time. Of course it must not be imagined that during a prolonged stay in the air the wings are in constant movement. For having once got up speed a bird is able to glide along for a considerable time without effort, especially by taking advantage of air-currents.

PASSIVE FLIGHT.—Birds may be often observed moving through the air with motionless outspread wings and expanded tail. Two chief kinds of this passive flight may be recognized, known respectively as Gliding and Soaring.

Gliding Flight.—This takes place when a bird simply moves onwards and does not describe the upward spirals that are characteristic of soaring. It is exemplified by many forms possessing considerable spread of wing, among the most familiar being Gulls and Pigeons. The simplest case is seen when one of the latter birds slides down obliquely from a roof to the ground, and this may be described as a parachute movement (see p. 286). Such a descent may also be made by a bird which is actually flying, as when a Falcon swoops steeply down upon its prey (fig. 837).

Gliding may also take place in an upward direction, and here again the Falcon will serve as an illustration. For in the middle of its swoop it can, if necessary, so adjust its wings and body as to utilize the momentum gained for an upward slide. Supposing that a bird which is flying horizontally forwards with considerable speed suddenly ceases to move its wings, but allows them to remain extended. It will then glide on for a considerable distance. And it has been proved experimentally that under

such circumstances the upward pressure of the air is greatest on the front of the wings, tending to tilt up the fore part of the bird, and thus giving an upward bias. Unless this is corrected by some alteration of position an upward glide will result. A comparison may be made with a kite which a boy is sending up by the familiar process of running rapidly in front of it, a friend having previously "let go" at the psychological moment. At first the kite is dragged through the air at a slight inclination



Fig. 837.—A Falcon Swooping

with the ground, but as the pull of the string gradually gives it horizontal velocity an upward bias is developed, the string is paid out, and it glides up obliquely into the air. Birds which take wing from the ground, or from the water, always face the wind, and the assistance which this gives them is partly to be explained on the kite principle, the horizontal velocity required for a start being given by a preliminary leap aided by vigorous wing-flapping. The analogy is only an imperfect one, but the details are too complicated to give here.

It remains to be noticed that a bird which ceases active flight and commences gliding can easily adjust itself so as to correct the upward bias described above. The commonest methods employed appear to be slight folding of the wings and spreading

out of the tail. Horizontal gliding is often the result. If the wings are folded more than necessary to correct the upward bias the bird will at once begin to glide downwards.

Soaring.—A bird is said to sail or soar when with outspread wings it circles up into the sky, describing a course that may broadly be termed spiral. It is only possible in cases where there is a large surface of wing compared to the weight of the body, and is characteristic of many of the Birds of Prey, the larger members of the Crow Family, Pelicans, and Storks. Roy (in *Newton's Dictionary of Birds*) thus summarizes the chief features of this kind of flight as described by competent observers:—"A certain amount of wind appears to be essential, soaring flight not being observed in a dead calm. Observers seem also to agree in this, that the soaring bird, with motionless outstretched wings (having raised itself some distance from the ground or sea by active wing-strokes), describes in its flight curves or circles which lead it to alternately sail up the wind and down the wind. It describes wide curves, and loses in vertical position while it is directed down the wind, while in going up into the wind it rises higher in the air. The bird may, in describing these curves or circles, rise as high or higher than the point from which it started, and may be as far or farther to windward, and this without any very evident expenditure of mechanical work on the part of the bird."

But it is easier to describe these evolutions than to explain how they are performed, and no entirely satisfactory explanation has so far been advanced. Some authorities have attributed them to the action of upward currents of air, and others have tried to explain it by the fact that an air current moves more rapidly in proportion to its height above the ground. But we know too little about the distribution and force of air-currents in the higher regions of the air, to feel sure that either explanation can account for the fact that Adjutants are able to soar up to an altitude of some two miles from the ground.

The following view on the subject is advanced by Headley (in *The Structure and Life of Birds*): "I believe myself that the irregularity of the wind may supply the explanation of soaring. The wind is a 'chartered libertine', and, even when steadiest, blows, as Professor Langley has shown, with great fitfulness. A bird, when soaring, if this explanation be sound, will face a strengthen-

ing breeze: when it begins to slacken, will turn round and go with it until conscious it is strengthening again, when once more he will sweep round and face it, his aim being always to feel the wind blowing in his face—sure evidence that he has momentum that will lift him. To do this, he would have to be perpetually feeling the pulse of the wind, and, moreover, soaring would be a much less regular progress upward than it is supposed to be. Some turns of the helix would be failures. There would be a loss instead of a gain of elevation, or nothing more than a maintenance of level would be achieved. But when we watch a bird circling at a great height, what can we tell of his progress during a particular minute? We only know that his general tendency is upward. Gulls make only partially successful turns when they soar, and it is possible that similar failures in a nobler performer like the Adjutant may remain undetected."

THE FLIGHT OF REPTILES (REPTILIA)

Very few living Reptiles make any attempts at aerial locomotion, and those which do are merely parachutists (see p. 286). But in the remote epoch known to geologists as the Mesozoic or

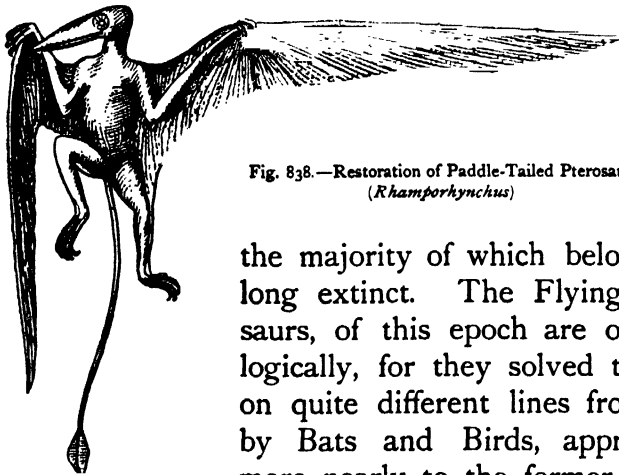

Fig. 838.—Restoration of Paddle-Tailed Pterosaur
(*Rhamphorhynchus*)

Secondary, when Mammals were but a feeble folk, not only the land and sea, but also the air were dominated by Reptiles,

the majority of which belonged to groups now long extinct. The Flying Reptiles, or Pterosaurs, of this epoch are of great interest biologically, for they solved the problem of flight on quite different lines from those exemplified by Bats and Birds, approximating, however, more nearly to the former in this respect. As will be gathered by reference to fig. 838, which represents a restoration of the Paddle-Tailed Pterosaur (*Rhamphorhynchus*), flying membranes connected fore- and hind-limbs, and (in some species) the latter with the tail, which in this particular form, however, was elongated, free, and broadened out at its end. There was also a

fold of membrane in front of the arm. We have seen that the wing of a Bat largely consists of a greatly developed webbed hand, of which all the digits, except the thumb, are much elongated. But the wing of a Pterosaur appears to have been entirely evolved from a lateral parachuting fold, the front end of this being supported by the arm, and also by the little finger, which was of extraordinary length. The species figured possessed very large eyes, and was no doubt nocturnal or dusk-loving.

The skeleton of Pterosaurs was specialized in relation to flight. There were, for example, extensive air-cavities in the bones, and the sternum possessed a strong keel, correlated with well-developed breast-muscles. In many species the tail was very short, and sometimes the jaws were toothless, being in that case no doubt covered by horny sheaths, as in the beak of a bird. The smallest of these creatures were no larger than sparrows, but some of the latest evolved forms, the toothless Pterosaurs (species of *Pteranodon*), which flourished during the Chalk period, attained gigantic dimensions, their spread of wing being sometimes as much as 25 feet.

The Flying Reptiles probably became extinct as a result of competition with the more highly organized Birds and Bats. Their organs of flight were perhaps less efficient than in those groups, but it is not likely that this was the only or even the chief cause of their failure in the struggle for existence. This must probably be sought in less perfect circulatory and breathing organs, but it is impossible to verify this conjecture, as our knowledge of the group is almost entirely limited to what can be deduced from the structure of the skeleton.

THE FLIGHT OF INSECTS (INSECTA)

Insects alone among Backboneless animals have evolved organs of flight, and to this must probably be ascribed their extraordinary abundance, both as regards number of species and number of individuals. In both respects they far surpass all other kinds of land animal taken together.

Structure of Insects in Relation to Flight.—The body of an insect is divided into three regions, *i.e.* head, thorax, and abdomen. The thorax consists of three successive rings, each of which bears a pair of legs, while in typical cases there are two pairs of wings, attached to the second and third ring respectively. These struc-

tures are developed as outgrowing folds of the body-wall, and are quite independent of the limbs, thus differing from the flying organs of backboned animals.

When fully developed, the wing may be regarded as an elastic membrane, horny in texture, and strengthened by a more or less elaborate system of thickened "veins" or "nervures", which have a constant arrangement in the same kind of insect, and are a great aid to classification. They prevent tearing, and the strongest of them run along the front part of the wing, which is thus rendered

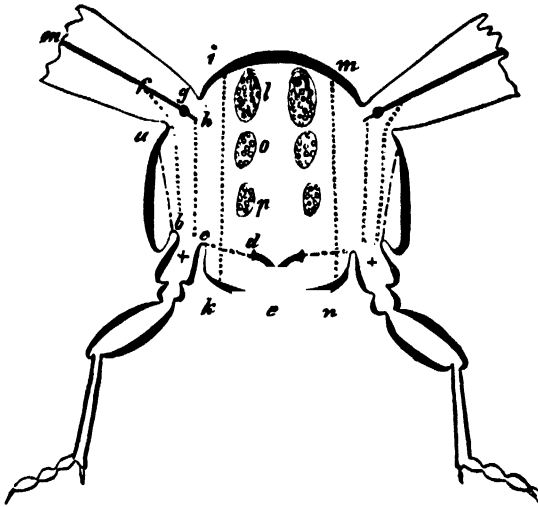

Fig. 839.—Diagrammatic Cross-section of a Butterfly

++ , Thighs; *bw* and *cd*, muscles which pull the legs outwards and inwards. Muscles of flight described in text. The wings have been cut short

specially resistant, and plays the same part with reference to the more flexible region behind it as does the bone-supported front edge of a bird's wing with regard to the quill-feathers. A very young wing can be separated into upper and lower layers, between which run various structures. Each nervure, for example, is traversed by an air-tube, accompanied by a blood-channel. The wing is jointed on to the thorax

in a complex manner, and its base projects into the body as a sort of fold, to which important muscles are attached.

The diagrammatic cross-section through a butterfly represented in fig. 839 indicates the position of the chief muscles of flight. The thickened part of the wing to which some of these are attached may be regarded as a lever (*mh*), of which the fulcrum (*g*) is situated in the wing-joint. To the short arm of the lever internal to this a muscle is attached (*ch*), by which the wing is raised. The effective downward stroke is effected by a more powerful muscle (*bf*), which is attached to the wing a little way outside the fulcrum. Other muscles, which are not attached directly to the wings, but alter the shape of the thorax, help to bring about the upward and downward movements. This region

of the body is flattened by vertical muscles (*ik, mn*), during the contraction of which the wings rise. There are also longitudinal muscles (*l, o, p*), by the action of which the thorax is shortened and the wings lowered. In Dragon-Flies, insects possessing quite extraordinary flying powers, and in which the two pairs of wings are capable of independent action as well as able to work together, the muscular arrangements are very complicated. In addition to elevator and depressor muscles there are others by which the wings can be rotated and otherwise adjusted.

Flight of Insects. — Marey and others have made elaborate experiments on the flight of insects, but the small size of these creatures and the great rapidity of their movements make such investigations exceedingly difficult. By allowing the wing-tips of captive insects to just brush against strips of blackened paper stretched upon revolving cylinders, Marey obtained curves which enabled him to calculate the rate of movement, some of his results being as follows:—

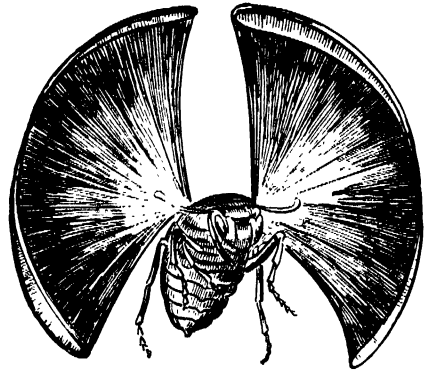

Fig. 840.—Wasp flying in the Sun, showing curves described by wings. To the tip of each a fragment of gold-leaf had previously been attached

| | Wing-beats per Second. | | | |
|-----------------|------------------------|-----|-----|-----|
| Common Fly | ... | ... | ... | 330 |
| Drone-Fly | ... | ... | ... | 240 |
| Bee | ... | ... | ... | 190 |
| Wasp | ... | ... | ... | 110 |
| Humming-Bird | ... | .. | | 72 |
| Moth | ... | ... | ... | 28 |
| Dragon-Fly | ... | ... | ... | 9 |
| White Butterfly | ... | ... | ... | |

The rate is clearly greatest in insects of small size, and no doubt in these captive specimens it was diminished by friction against the blackened paper.

By attaching a fragment of gold-leaf to the tip of the front-wing in a Wasp, the same observer demonstrated the complexity of the actual movement (fig. 840). And by this and other means it has been shown that the wing-tip describes a figure-of-8 curve. Photography is here difficult of application, but it has at least shown that the plane of the wing is inclined during the upward

and downward movements, and hence the body is propelled onwards as well as upwards, on the same principle as in Birds (see p. 303). The comparative rigidity of the front part of the wing conduces to obliquity. There appear to be several ways by which the direction of flight is regulated, and turning, stopping, and even reversing (in some cases) brought about. For example, the wings of opposite sides are capable of independent action, and the abdomen can be moved so as to throw the weight of the body to this or that side.

It is interesting to note that, as in Birds, air-sacs are present within the body, and these are especially large in swiftly-flying forms, such as bees, dragon-flies, moths, and flies (see vol. ii, p. 439). This undoubtedly reduces the weight of the body in proportion to its bulk, but, according to the most recent view, mere lightness is not the chief advantage thus gained. The large air-sacs are now thought to be important mainly because they render vigorous breathing possible, and this is a matter of great moment when muscular exertion is severe and prolonged.

Modification of the Wings in Different Insects (fig. 841).—In Dragon-Flies and some other forms the four wings are of equal or nearly equal size, and capable of acting independently. But in such insects as Bees and Moths there is an arrangement which to a great extent deprives the hind-wings of their independence, and makes them of secondary importance. The arrangement in question consists of an interlocking device, the nature of which varies in insects of different kind, whereby the hind-wings are attached during flight to the fore-wings. In a Moth, for instance, there are usually one or more bristles (*frenulum*) projecting from the front edge of the hind-wing, near its attachment, and capable of being made to catch in a small flap or tuft of scales (*retinaculum*) situated on the under surface of the fore-wing. A more elaborate arrangement fulfils the same purpose in Bees and similar insects, consisting of a series of hooks on the front of the hind-wing, which can be slipped over a ridge on the hinder edge of the fore-wing. The hooks are arranged "in a slightly-twisted or spiral direction along the margin of the wing, so as to resemble a screw, and when the wings are expanded attach themselves to a little fold on the posterior margin of the anterior wing, along which they play very freely when the wings are in motion, slipping to and fro like the rings on the rod of a window-curtain" (Newport).

The subordination of the hind-wings to the fore-wings has led in many cases, *e.g.* Bees, to a diminution in size of the former. And in ordinary Two-winged Flies (Diptera) this reduction has gone so far that the hind-wings have dwindled to a pair of club-shaped "balancers" (*halteres*) which appear to be chiefly useful as sense organs, though they also play a subordinate part in flight.

•But, on the other hand, there are many insects in which the hind-wings are the chief agents

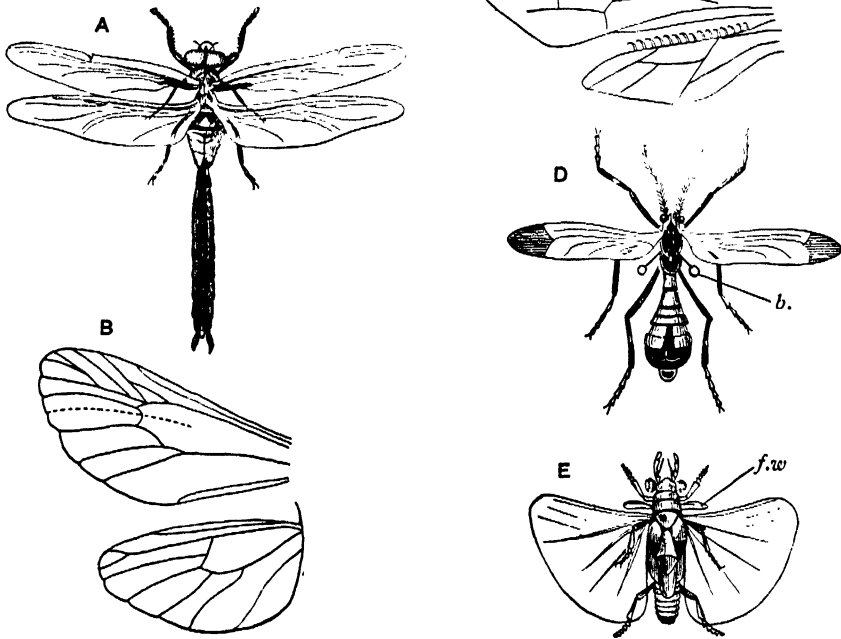

Fig. 841.—Wings of Insects

A, A Dragon-Fly. B, Left fore- and hind-wings of a Moth; note frenulum projecting from base of latter. C, left fore- and hind-wings of a Bee, showing row of hooks on latter. D, Two-Winged Fly; b, one of reduced hind-wings. E, Male Stylops; f.w., reduced fore-wing. The figures have been drawn to various scales.

in flight, the fore-wings having become more or less hard and thick to constitute protective wing-covers. The most familiar case of the kind is afforded by the Beetles (Coleoptera), although it is supposed that in these insects the firm wing-covers (*elytra*) play a passive part in flight by acting as "wind-catchers", or kites. The membranous hind-wings of a Beetle, when not in use, are neatly folded up under the wing-covers, and are so long that they do not merely shut up like fans, but also have to be bent up along a transverse crease. In some Beetles which possess a

long slender abdomen the tip of this is turned over the back to assist in stowing the membranous wings under their covers.

There are some curious little forms (species of *Stylops*, &c.), usually regarded either as aberrant beetles or as the representatives of a distinct order (Strepsiptera), which give us the exact opposite of the arrangement described for two-winged flies. They are parasitic in bees and some other insects, and the females are like minute maggots in appearance. The males, however, can fly with great activity by means of very large hind-wings, while the fore-wings are only represented by little scales, which are probably the last remains of well-developed wing-covers once possessed by ancestral forms.

Some insects have given up flight altogether, and lost both pairs of wings; such as Fleas, in which some little scales on the sides of the thorax are commonly regarded as the vestiges of the wings, and Lice, in which there is no trace of wings at all. In the forms mentioned in the last paragraph the females only have become flightless, and they are by no means the only illustration of this phenomenon that could be given. The Primitive Wingless Insects (Aptera) probably resemble in many ways the early ancestors of the group, which were not provided with organs of flight.

Evolution of the Wings of Insects.—There have been many speculations as to the early stages in the evolution of the wings of insects, and it is obvious that at their first inception they cannot have been flying organs. The most plausible suggestion is the one that has already been made for birds and bats, *i.e.* that the structures which have been gradually specialized into wings arose in the first instance as parachute-folds, in this case by outgrowth from the sides of the thorax. Possibly such folds were first developed as an aid to leaping, in which case comparison may be made with the Australian Flying-Spider (see p. 289). But, on the whole, it is more likely that the development of parachute-folds was a sequel to climbing, and this view becomes more probable when we recollect that the number of legs which insects possess, *i.e.* six, is best explained by reference to the climbing habit. The establishment of joints between the folds and the thorax would be of service in guiding even parachute movements, and from this stage on it is not difficult to imagine the gradual modification of the folds into wings.

Another possibility, however, must be borne in mind. The wings of an insect are traversed by air-tubes, with which blood-spaces are always associated in early stages of development. And there is reason to think that even in some adult insects the blood circulates in the wings to some extent. It is therefore quite possible that the original folds had reference to breathing as well as to parachuting. And this has led some authorities to surmise that wings have been evolved from tracheal gills possessed by primeval aquatic forms (see vol. ii, p. 463). But the evidence in support of this view is of the scantiest description, and it is in the highest degree improbable that the members of the original insect stock were of aquatic habit.

ANIMAL DEVELOPMENT

CHAPTER LIII

ANIMAL DEVELOPMENT—GENERAL PRINCIPLES— VEGETATIVE PROPAGATION

The preceding sections of this work have been devoted to Classification, and to those functions that maintain the life of the individual. We may now instructively consider the various means by which the continuance of the species is provided for. The Development of the individual, of course, includes a consideration of all the stages through which it has to pass before becoming adult, and might with propriety be considered under the heading of Life-Histories. But there are reasons which make it desirable to treat Development and Life-Histories as distinct sections. Under Development will be considered certain general principles as well as facts that can only be studied in the laboratory by means of the microscope, and technical methods associated with its use. The succeeding section on Life-Histories will broadly treat of facts which can be to a large extent made out by field naturalists, though many details can only be fully elucidated by work in the laboratory. And in that section it will also be convenient to deal with such topics as Protection of Eggs and Young, and Animal Dwellings, for these, of course, have an important bearing upon life-histories.

GENERAL PRINCIPLES OF DEVELOPMENT

All the different ways by means of which fresh individuals come into existence can be regarded as varieties of what may broadly be termed *overgrowth*. Every animal in the course of its existence builds up food into living body-substance, and this in its turn manufactures those components of the body which are

not living, *e.g.* firm supporting structures and pigment granules. In early stages more food is taken in and utilized than is necessary to counterbalance the processes of waste that are constantly going on, and the result is *growth*. But when a certain size, varying with the species, is attained, the individual becomes adult, after which the chief use of food is to maintain the weight of the body by preventing the animal from gradually wasting away owing to the constant formation of various products of waste. In other words, the income and expenditure balance one another, in so far as the individual itself is concerned. But in all cases more food than is necessary for this particular purpose is taken into the body, and this is employed to build up living substance that becomes detached from the parent form and develops into new individuals. We have, in fact, a kind of overgrowth. A hen, for example, after it becomes adult, lays eggs, which may be regarded as detached parts of its body, and which, by developing into chickens, prevent the fowl species from becoming extinct.

It will be convenient to consider under separate headings Vegetative Propagation and Development from Eggs.

VEGETATIVE PROPAGATION

We have elsewhere (vol. i, p. 490) had occasion to note that the simple animals known as Animalcules (Protozoa) differ, as a rule, from all higher forms (Metazoa) in one very important particular. For any one of the latter is built up of more or less numerous units of structure technically known as *cells*, each of which is a fragment of living substance or protoplasm, part of this being specialized into a particle known as the *nucleus*. An Animalcule, on the contrary, consists of but one cell, though the parts of this may be very highly specialized. These facts are embodied in the technical statement that Protozoa are one-celled, while the Metazoa are many-celled. Any member of the latter group, *e.g.* a Worm, a Snail, or a Fish, may therefore be regarded as a cell-community, and the physiological work of the body is more or less divided among the members of this community, there being, in other words, a division of physiological labour. It invariably happens that some of the units or cells of the community are especially concerned with propagation, and either produce the eggs which develop into fresh individuals or else

enable this development to take place. But many of the lower Metazoa do not entirely rely upon eggs for the perpetuation of their kind, but also give rise to other individuals by means of

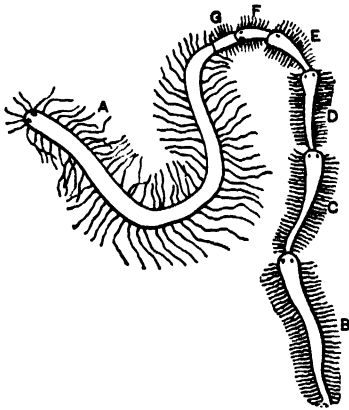

Fig. 842.—A Marine Worm (*Myrianida*) giving rise to a chain of individuals by transverse division. A, The parent worm; B-G, the new individuals, of which B is the oldest and G the youngest

what is termed *vegetative propagation*, with which the egg-producing cells have nothing to do. There are, for example, some marine worms (fig. 842) in which the body becomes transversely divided into a number of sections, each of which ultimately breaks off and becomes a fresh worm. This phenomenon is much on a par with what is seen in many Flowering Plants. Here the production of seeds is related to egg-propagation, but this is frequently supplemented by one or more vegetative methods of multiplication. In Begonias, for example, buds sometimes grow out at the edges

of the leaves, which, after developing into little plants, fall off and take root in the ground.

VEGETATIVE PROPAGATION IN ANIMALCULES (PROTOZOA).—With rare exceptions the body of an Animalcule consists of but one cell, and there is therefore no question of egg-production, propagation being effected vegetatively. Three kinds of this are recognized: Splitting (Fission), Budding (Gemmation), and Spore-Formation. All are cases of cell-division.

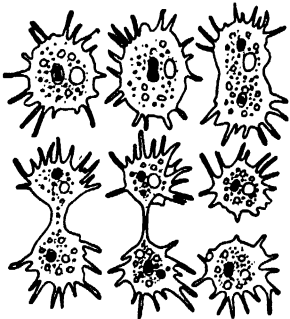

Fig. 843.—Stages in the Fission of a Proteus Animalcule (*Amoeba*), from left the top.

Splitting (Fission).—A simple case of this is afforded by the Proteus Animalcule (*Amoeba*, fig. 843). Division of the body is initiated in the nucleus, which becomes elongated and dumb-bell-shaped, after which the surrounding protoplasm gradually constricts into two, and ultimately there is complete separation, with the

result that two Animalcules take the place of the original one. The parent *Amoeba* is thus merged in its offspring, or at any rate has ceased to exist as a single individual. According to

Weismann, the products of this division later on divide in their turn, and so on indefinitely. And it is upon this belief that the distinguished zoologist in question founds his doctrine of the "immortality of the Protozoa", which involves the statement that death by "natural causes", as a coroner would put it, is unknown among Animalcules. But at present we do not know definitely whether or no division can go on for an indefinite number of generations, as Weismann's doctrine postulates.

We may take as further illustrations of fission (fig. 844) the Trumpet-Animalcule (*Stentor*) and the Bell-Animalcule (*Vorticella*), both of which are much more highly organized than *Amœba*, and belong to the group of Ciliata, in which the body is provided with cilia, *i.e.* short threads of protoplasm capable of movement. The Trumpet-Animalcule is elongated in form, with a narrow attached end, and a much broader free end, provided with a short spiral of cilia, food-bearing current set up in the surrounding water. The nu-

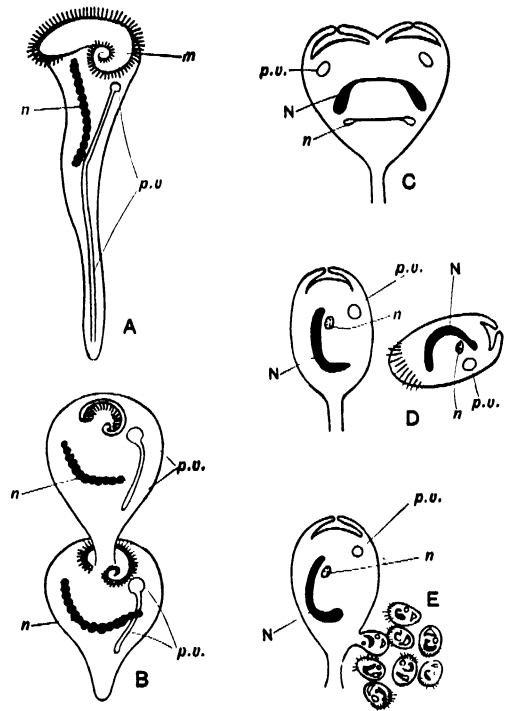

Fig. 844.—Fission of Ciliated Animalcules, enlarged

A and B, Stages in transverse division of Trumpet-Animalcule (*Stentor*); *m*, mouth; *n*, nucleus; *p.v.*, pulsating vacuole. C, D, Stages in equal longitudinal fission of Bell-Animalcule (*Vorticella*), and E, repeated unequal longitudinal fission of same. N, Large nucleus; *n*, small nucleus; *p.v.*, pulsating vacuole.

cleus is elongated, and shaped something like a string of beads. Fission is here transverse, and though each half takes its share of the nucleus, one of the new individuals is constituted by the broad end and the other by the narrow end of the original body. This is of no great moment, as each of them develops the parts which it lacks before separation is completed.

In the Bell-Animalcule fission is longitudinal, so that there is a fairer division of the parent Animalcule between the halves. One, however, keeps the stalk, which does not split, while the

other has to swim away, attach itself to some firm body, and grow a new stalk. In some relatives of the Bell-Animalcule, and certain other Protozoa, colonies are formed by continuous fission, the products remaining united.

Budding (Gemmation).—This differs markedly from fission, because the parent Animalcule does not lose its individuality. One or more projections grow out from its body and receive a part of the original nucleus. These buds then become narrower and narrower at their attached ends, until at last they drop off,

after which they gradually acquire the size and shape of the parent form from which they sprang. Comparatively simple illustrations of budding are afforded by the members of a curious group of Animalcules (Suctoriozoa), which are devoid of mouth, but possess a number of slender outgrowths from the body that serve as a means of catching such prey as other Animalcules, and sucking the juices of these when secured.

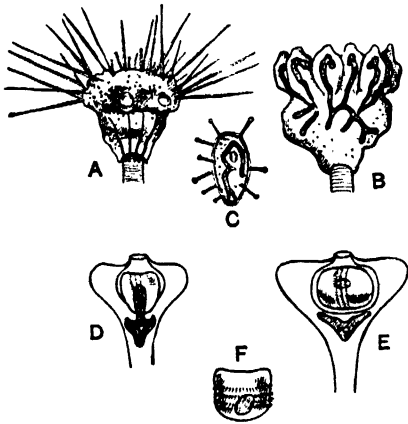

Fig. 845.—Budding Animalcules, enlarged

A-C, External budding of *Ephelota*: A, body of an adult (the stalk is cut short); B, an individual producing buds, each containing an outgrowth from the branching nucleus; C, a detached bud. D-F, Internal budding of *Tokophrya*, diagrammatic: D, young bud with a branch from the nucleus is growing; E, bud lying in the brood-cavity; F, free-swimming bud.

A stalked member of this group (*Ephelota gemmipara*) is depicted in fig. 845, which shows a group of buds growing out from the body, and receiving twigs from the much-branched nucleus of the

parent. A detached bud at a later stage is also represented, and it will be seen that this has begun to develop the curious suctorial projections that are characteristic of the group.

In some cases there may be an internal cavity (brood-cavity), within which a bud is formed. This is exemplified by a stalked Animalcule (*Tokophrya quadripartata*, fig. 845), belonging to the same group as the form last mentioned. Here the bud is provided with a broad ciliated girdle, and, when mature, squeezes out to the exterior through an opening present in the brood-cavity. After swimming about for some time by means of its cilia, the bud settles down, attaches itself to some firm body, loses its cilia, and develops the stalk and suctorial structures which are char-

acteristic of the adult. This comparatively simple life-history appears to be a good illustration of the Law of Recapitulation, of which mention has already been made in this work. Otherwise expressed, the development of the individual epitomizes in a more or less perfect way the evolutionary history of the group to which the individual belongs, recapitulating ancestral stages. It is generally held that these suctorial Animalcules are an off-

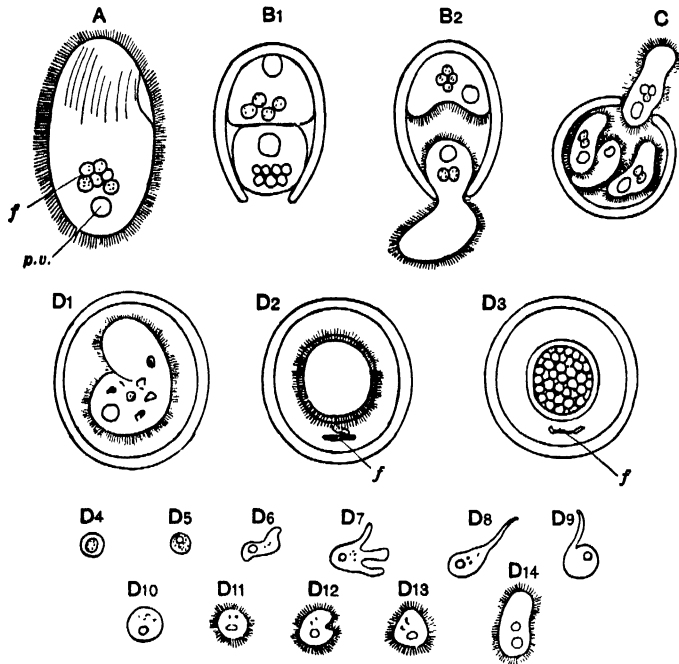

Fig. 84b.—A Spore-forming animalcule (*Colpoda*), greatly enlarged

A, Free-swimming individual. B and C, Encystment followed by division into two and four respectively. D 1-D 3, Encystment and Spore-formation; D 4-D 14, development of a spore. f, Food, p.v., pulsating vacuole.

shoot from the ciliated group in which such forms as the Slipper and Bell-Animalcules are included. And the existence of a ciliated stage in the life-history is not improbably reminiscent of ancestors in which cilia were present throughout life.

Spore-formation.—In the examples selected to give some idea of the nature of fission we saw that the body of the parent divided into two parts only. But many cases are also known of *multiple* fission, where several rapid divisions take place in succession, as a result of which several new individuals are brought into existence. In the Bell-Animalcule and its allies, for example, it often happens that a large fixed individual undergoes rapid unequal

division to produce a number of relatively small free-swimming bells, which are simpler in structure than the parent Animalcule (fig. 844). The fate of these will be described in a later paragraph. Spore-formation is, so to speak, an exaggeration of this process, for where it takes place the body of the original form breaks up into a large number of minute parts, each of which is known as a *spore*. Such spores present a great variety of characters in different cases, and often form part of a remarkably complex life-history, of which something will be said elsewhere. They are developed within a firm capsule or *cyst*, with which the parent form surrounds its body before beginning to divide.

The formation of spores is very characteristic of the parasitic Animalcules known as Gregarines, which constitute the group Sporozoa (*i.e.* Spore-Animals), and also of the Fungus-Animalcules (Mycetozoa). But for our present purpose it will be better to take the simpler case afforded by a little bean-shaped organism (*Colpoda cucullus*) which often abounds in putrefying fluids. Its body is uniformly covered by cilia, by means of which swimming is effected. The life-history has been very carefully studied, and some of the stages passed through are represented in fig. 846. Before the body divides to give rise to offspring a firm case or cyst is formed, but the subsequent events are not always the same. Sometimes the body of the Animalcule, after losing its covering of cilia, simply divides into two (B) new individuals, which once more acquire cilia, and squeeze their way to the exterior through a hole in the cyst. In other cases there is a division into four (C). And lastly there may be spore-formation (D), which is a much more complicated process. After formation of a cyst devoid of any opening, the body of the Animalcule shrinks and becomes spherical, any food present within the body being expelled. The cilia then disappear, and a second firm membrane is formed* outside the body, of which the substance now breaks up into a large number of minute rounded spores enclosed in firm coats. By rupture of the enclosing membranes the spores ultimately escape, and the firm coat of each of these splits open to liberate the tiny mass of living substance within. This at first resembles a minute Amœba, feeding and crawling in similar fashion. One end then grows out into a motile thread or flagellum, by which its owner is able for a time to swim about. Later on, the body assumes

GUENONS (*Cercopithecus sabaeus*) RETREATING
FROM A MAIZE-FIELD

The Guenons, of which one species is represented in the plate, are typical long-tailed African monkeys, native to the tropical parts of that continent. They are eminently arboreal, and live in troops, which make organized raids upon the crops of the natives. They are depicted here as retreating from threatened danger, of which the vigilant sentinel on the fence at the back has given warning. Maternal affection is well developed in monkeys, and in the background is shown the characteristic way in which the mother carries her helpless young one about. In the centre will be noticed another mother helping her partly-grown child over a difficult place. The intelligent individual in the foreground is retreating with a decent share of the plunder.



GUENONS (*CERCOPITHECUS SABAEUS*) RETREATING

a rounded shape, cilia appear on its surface, and the size and shape of the adult are gradually attained.

Conjugation of Animalcules.—The vegetative propagation of Animalcules is commonly promoted by, and often dependent upon, a remarkable process to which the name of *conjugation* has been applied. This has been very carefully studied in some of the ciliated forms, as, *e.g.*, in the Slipper-Animalcule (*Paramecium*) and Bell-Animalcule (*Vorticella*), which will serve as our illus-

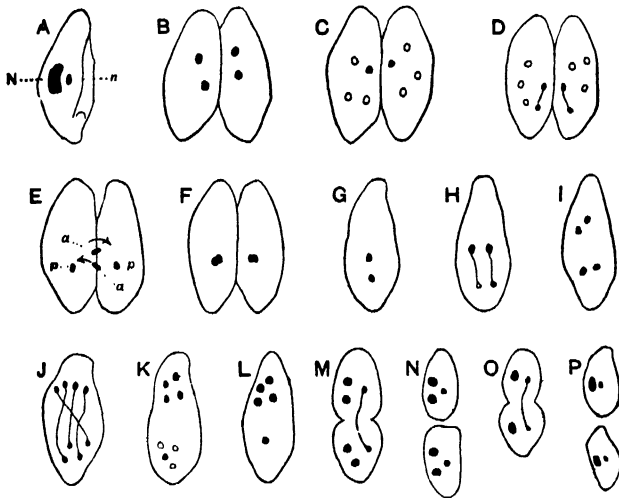

Fig. 847.—Temporary Conjugation of a Slipper-Animalcule (*Paramecium caudatum*), diagrammatic and enlarged

A, A free individual; N, macronucleus; n, micronucleus. B-F, Stages in conjugation, showing successive divisions of micronuclei (macronuclei omitted), the fragments which disappear represented by clear circles—in E the active nucleus (a) of each individual is migrating towards the passive nucleus (p) of the other individual—in F each individual contains a compound nucleus. G-N, Changes in a conjugated individual leading to transverse fission, followed by (O, P) a further division in each half.

trations, though minute details will not be given, as the process is very complicated.

Within the body of one kind of Slipper-Animalcule (*Paramecium caudatum*, fig. 847) two specialized particles of protoplasm can be seen, placed close to each other. The larger is the *macronucleus*, but it is with the smaller, or *micronucleus*, that we are here principally concerned. During conjugation two individuals apply themselves closely together, and remarkable changes take place in the nuclear structures. The macronucleus gradually disintegrates and disappears, but the micronucleus, by two successive divisions, is converted into four fragments, of which three break down and disappear. But the fourth fragment divides once more, and the fates of its halves differ. We may term them the

active half and passive half. The active half, in each individual, migrates into the other Animalcule, and fuses with the passive half there present. After this interchange of nuclear material, which constitutes the essential part of the process, the two conjugating individuals separate, each of them containing what may

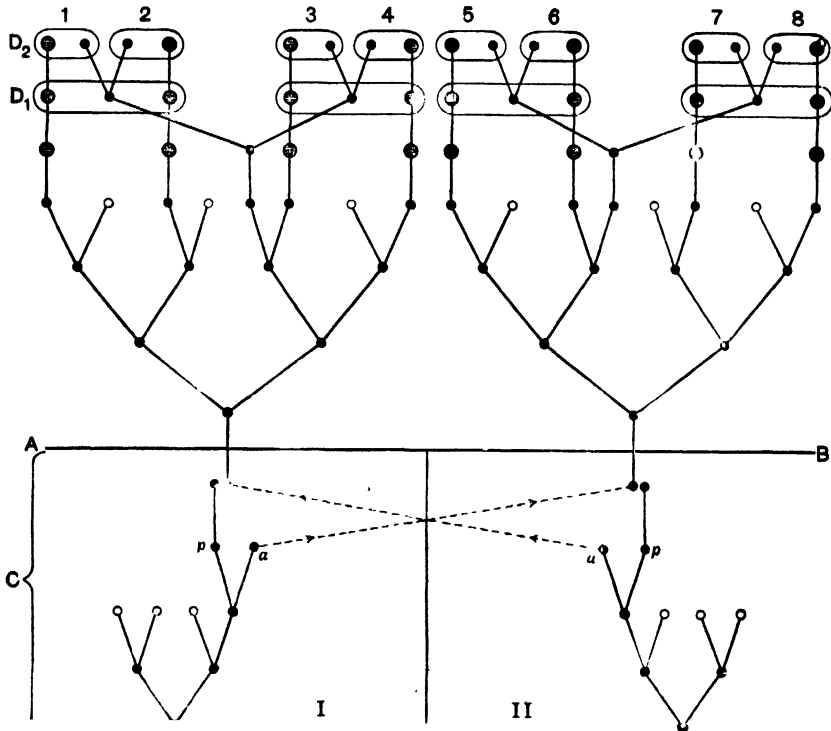

Fig. 848.—Temporary Conjugation of a Slipper-Animalcule (*Paramecium caudatum*)

Diagram to show successive divisions, &c., of micronuclei. Fragments which disappear represented by clear circles, and fragments (of the compound nuclei) which become macronuclei shown as horizontally shaded circles. Read from below upwards. The changes during conjugation (c) of the two animalcules (I and II) are shown below AB: α and β , active and passive nuclei, the migration of the former indicated by dotted lines. The changes after conjugation shown above AB: at D₁, each conjugated animalcule has divided into two, and each of these (at D₂) has again divided, so that there are now eight new animalcules (1-8).

be called a *compound* or *fertilization nucleus*. The fusion of two nuclear masses, derived from different individuals, *i.e. fertilization*, is followed by increased activity in the vital processes. By it the living substance with which life is associated is, so to speak, stimulated and freshened, or, to use a more technical expression, *rejuvenesced*. Why this should be the case is still unknown. In the Slipper-Animalcule conjugation is followed by fission, a mark of increased activity. And it has been shown that without occasional conjugation between individuals not too

nearly related the stock would degenerate and ultimately die out altogether. In this particular instance each of the two Animalcules which have conjugated divides into two, and each half at once divides again, so that multiplication is fourfold. By successive divisions of the fertilized nucleus eight fragments are produced, which become the macronuclei and micronuclei of the four new individuals. There are other fragments which come to nothing. The stages in conjugation and subsequent fission will best be followed by reference to figs. 847 and 848.

In a Bell-Animalcule (*Vorticella*) conjugation, instead of being *temporary*, as in the form just described, where two individuals exchange nuclear fragments and then separate, is *permanent*; *i.e.* two individuals completely fuse together to give a compound cell, which afterwards undergoes active fission. And the process differs in another important respect, for the individuals which fuse are of different size and nature. One is a large fixed bell, the other a small free-swimming individual (fig. 849), the latter being a product of multiple fission (see p. 321). Both conjugation and subsequent division are attended by complicated nuclear changes differing only in detail from those already described for the Slipper-Animalcule.

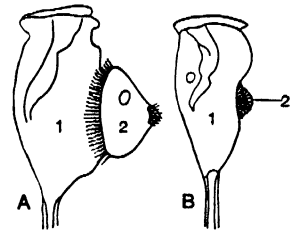

Fig. 849.—Permanent Conjugation of Bell-Animalcule (*Vorticella*), enlarged and diagrammatic

A and B are successive stages in the fusion of a large fixed bell (1) and a small free-swimming one (2).

VEGETATIVE PROPAGATION IN MANY-CELLED ANIMALS (METAZOA).—Some of the lower many-celled animals (Metazoa) regularly propagate by fission or budding, and are also able to regenerate lost parts with ease. The latter phenomenon is also exemplified by animals higher in the scale, and even the most specialized backboned forms are able to repair injuries to some extent.

Vegetative Propagation and Regeneration in Sponges (Porifera).—A simple Sponge is commonly in the form of a cup or vase, the walls of which are perforated by numerous small holes. Sea-water streams through these into the central cavity, and thence to the exterior through the larger opening (*osculum*) at the end of the body. Most Sponges, however, are far more complicated than this, and take all sorts of shapes. Some are compact masses, others flat incrustations attached to stones, &c.; others, again, branch like plants. Such forms as these are usually

to be regarded as *colonies*, produced by budding or fission from a primary individual. A simple case of the kind is represented



Fig. 850.—A simple Cup-Sponge (*Polylophus*) producing External Buds. The curving bands below are bundles of siliceous spicules, bunches of which are also seen projecting from the buds.

in fig. 862, 10, but it often happens that the boundaries between the members of the colony are extremely vague, though possibly each larger aperture (*osculum*) present corresponds to an individual.

In some kinds of Sponge external buds grow out (fig. 850), fall off, and develop into adults. A much more interesting phenomenon is presented by the formation of internal buds in certain species. The greenish Freshwater Sponge (*Spongilla*), common in this country, is a particularly instructive example, for it shows

one way by which the unfavourable winter season can be tided over. The internal buds are here little packets of cells enclosed

in protective coverings made up of peculiar spicules (fig. 851). They are developed on the approach of winter, the cold being fatal to the adult Sponge, which dies and decomposes. The buds (*gemmules*) then fall into the mud, and there remain dormant till the following spring, when the little mass of cells present in each of them creeps out of the protective investment through a hole present in one place, and grows into an adult

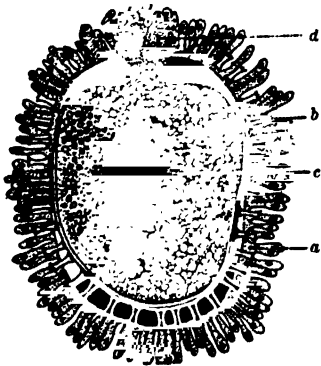

Fig. 851.—Section through Gemmule of Freshwater Sponge (*Spongilla*), enlarged. a, Cells which secrete the protective spi-

If by accident a living Sponge gets cut or broken into pieces, each of these is able to repair its injuries, and continue growth on its own account. Advantage has been taken of this possibility in the case of the Bath Sponge (*Euspongia*), which can be propagated by means of cuttings almost as if it were a plant.

Vegetative Propagation and Regeneration in Zoophytes (Coelenterata).—A simple case of budding is presented by the little Freshwater Polype (*Hydra*) during the summer months (fig. 852). A bud is formed by the outgrowth of a little projection from the wall of the body, which later on develops a mouth and tentacles, ultimately being pinched off from its parent as a new individual. And by vigorous budding a small temporary colony may be produced. The members of the group of Hydroid Zoophytes (*Hydromedusæ*), of which *Hydra* is a degenerate representative, are typically colonial, each colony resulting from the budding of a primary individual developed from an egg. And many kinds of Jelly-Fish are stages in the life-histories of such Zoophytes, from which they bud off.



Fig. 852.—Budding Freshwater Polype (*Hydra*), enlarged. Two buds are shown.

The free-swimming colonies to which the name Compound Jelly-Fish (*Siphonophora*) is given are also the products of budding (see vol. i, p. 481), while other kinds of Jelly-Fish come into existence as the result of transverse splitting or fission of fixed individuals (see p. 352).

Vegetative propagation is eminently characteristic of the marine forms known as Sea-Flowers (*Anthozoa*), among which Sea-Anemones and most Corals are included. The former are familiar

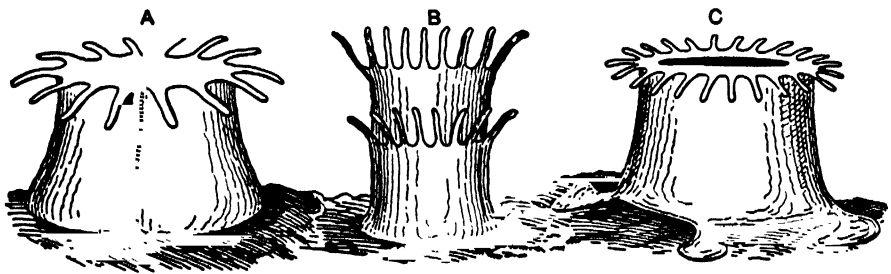

Fig. 853.—Vegetative Propagation of Sea-Anemones, diagrammatic

A, Longitudinal fission. B, Transverse fission. C, Laceration.

objects at the sea-side, and do not form colonies. Budding is known to take place in some species, but fission is a much commoner method of multiplication (fig. 853). When it takes place a groove makes its appearance, which gradually extends right across the Anemone, gets deeper and deeper, and ultimately

splits the animal into two. Or the groove may be transverse, so that the upper and lower halves of the body are converted into separate individuals. In other cases the attached base of the Anemone grows out into little projections, which are pinched off, and grow into adults. This "laceration", as it has been called, is as much budding as fission.

Among Corals and allied forms some species are solitary, and these "cup Corals" chiefly differ from Anemones in the possession of a firm calcareous skeleton by which their basal half is supported. Such forms may propagate by budding or fission. But very many kinds of Coral are colonial, and, as in Hydroid Zoophytes, each colony has arisen by vegetative propagation of a primary individual. Budding and fission are both exemplified, and there is great variety in the shape of the colonies thus produced. Flat, massive, and branching forms abound in coral-reefs, and may be seen in any museum.

The regenerative powers of such creatures as Hydroid Zoophytes and Sea-Flowers are very considerable, so that "accidental death" is scarcely to be reckoned as one of the dangers to which they are exposed in the course of their existence. The best-known example is afforded by the Freshwater Polype (*Hydra*), a creature which can be artificially propagated by the simple device of cutting it into pieces.

Vegetative Propagation and Regeneration in Hedgehog-skinned Animals (Echinodermata).—The regenerative powers of members of this group are very considerable. Some of the Sea-Cucumbers when seized eject their digestive organs, which are afterwards re-developed. Sea-Lilies and Feather-Stars can also survive the loss of their soft parts, quickly replacing them by a new set. Star-Fishes and Brittle-Stars are quite notorious for the rapidity with which they renew lost arms. This is the origin of "comet" forms, in which some of the arms are of small size, being, in fact, new members which have yet to reach their full size.

Fission is definitely known to take place in some of the Star-Fishes and Brittle-Stars, the body being divided into two approximately equal parts. But the most remarkable illustration of vegetative propagation is met with in one family (*Linckiida*) of the former group. In Star-Fishes of this kind one or more arms can be deliberately thrown off. Not only is the original individual able to grow these again, but each detached arm can

develop a disc and other arms, ultimately becoming a symmetrical adult (fig. 854).

Vegetative Propagation and Regeneration in Flat-Worms (Platyhelminia).—The members of this group are commonly able to repair injuries and re-grow lost parts with facility. As we shall see in a subsequent section, vegetative propagation plays an important part in the life-histories of such parasites as Flukes and Tape-Worms, and it will perhaps suffice for our present purpose to mention the transverse fission which regularly takes place in certain Planarian Worms (*Turbellaria*). A typical case is presented by a freshwater form (*Microstomum lineare*) depicted in fig. 855, and in which a temporary chain of individuals results from successive divisions.

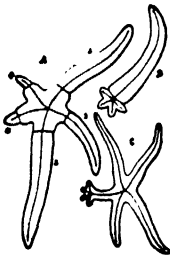

Fig. 854.—Vegetative Propagation, &c., in Star-Fishes, reduced

A, A Star-Fish (*Ophidiaster diplx*), in which two arms (1, 2) are about to be pinched off, and three others (3, 4, 5) are about to be pinched off.
 "Comet" Star-Fish (*Leptasterias*), in which a new arm (1) is sprouting from a wound (2).
 C, A Star-Fish (*L. multiflora*) in which a new individual is growing from a wounded arm.

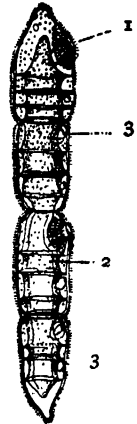

Fig. 855.—Fission-

individuals, numbered according to age.

Vegetative Propagation and Regeneration in Bristle-Worms (Chaetopoda).—

The body of a worm of this kind is made up of a varying number of rings or segments which, broadly speaking, resemble one another in structure. And supposing some of these rings to be accidentally cut off, or to fall a prey to some

predaceous animal, the life of the worm is not thereby brought to an abrupt conclusion, for the injuries are speedily repaired. It has been suggested, with some show of probability, that segmentation of the body has been evolved as a protective measure (see vol. ii, p. 375), but this is rather doubtful, for unsegmented worms, such as Planarians, are also distinguished by great powers of regeneration.

It is not surprising to find ability to replace lost parts associated in some cases with vegetative propagation. This is the case in one of the marine Bristle-Worms already mentioned (p. 318), and the process essentially consists in the rapid growth or budding-out of the region immediately in front of the posterior end of the body. A transverse division is next effected, renewed

growth takes place in front of this, a second division follows, and so on. In the temporary chain of individuals thus formed the youngest is therefore the one immediately behind the original animal. In other species a more complex arrangement may be found.

A more remarkable case is that of a Bristle-Worm (*Syllis ramosa*, fig. 856), in which lateral budding takes place, so that a temporary branching colony is brought into existence. This creature lives within the body of a sort of sponge.

Vegetative Propagation and Regeneration in Moss-Polypes

(*Polyzoa*).—The vast majority of Moss-Polypes are colonial organisms and, as in Hydroid Zoophytes, the colonies result from a process of budding, and differ largely in shape according to the way in which this takes place.

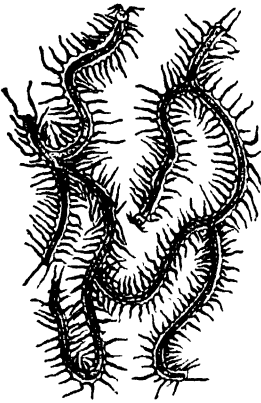

Fig. 856.—Part of Branching Colony of an Annelid (*Syllis ramosa*)

Our native freshwater species die down in autumn, but before this takes place *winter-buds* are produced (fig. 857), which remain dormant till the following spring, when they develop into new colonies. This affords another example of the method of tiding over an unfavourable season, which has already been described

in the case of the Freshwater Sponge (see p. 326).

The winter-buds of Moss-Polypes are sometimes produced externally, but more commonly they arise internally, being known in that case as *statoblasts*. It is usual for these structures to be surrounded by a ring of air-containing cells, and in one case (*Cristatella*) there is also a cirlet of grappling-hooks, which are likely to catch in water-plants or other objects. Harmer (in *The Cambridge Natural History*) makes the following interesting remarks regarding the buoyancy of these winter-buds:—"The production of *floating* statoblasts may seem a strange adaptation to the conditions of freshwater life, since it might be assumed, *a priori*, that these structures would be specially liable to be frozen during the winter. The following experiments made by Braem show, however, that the germinating power of the statoblasts is improved by a certain amount of frost. A number of statoblasts were taken; half of these were placed in water, which

was then frozen; and these were found to germinate readily when afterwards exposed to suitable conditions. The other half were not subjected to the action of frost; and these could not be made to germinate, even though the water had been cooled to a point slightly above the freezing-point. It thus appears that the buoyancy, so far from being a risk, is a means of exposing the stato-

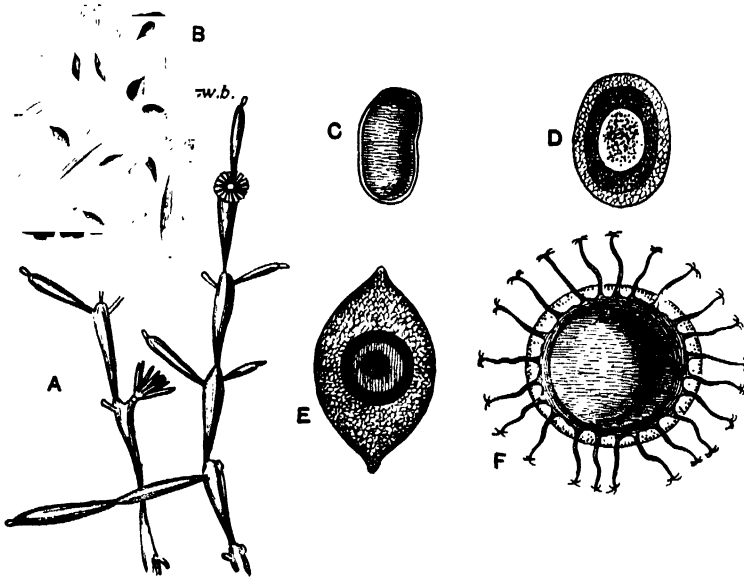

Fig. 857.—Winter-Buds of Moss-Polypes, enlarged to various scales

A, Small part of colony of *Paludicella*, with individuals expanded. B, Remains of part of colony of same, attached to stone and showing external winter-buds (*w.b.*). C, Simple statoblast of *Fredericella*. D, E, F, Floating statoblasts of *Plumatella*, *Lophopus*, and *Cristatella*.

blast to the conditions which are most favourable to its later development."

Moss-Polypes easily replace lost parts, and in most cases a large part of the body degenerates at regular intervals, and is as constantly re-grown from the part which remains. It has been suggested that this may be a radical sort of way of getting rid of waste products.

Vegetative Propagation and Regeneration in the Higher Groups of Many-celled Animals (Metazoa).—With increasing complexity of structure the possibilities in these directions become more and more limited. In Molluscs (Mollusca) and Jointed-limbed Invertebrates (Arthropoda) multiplication by means of budding or fission is no longer possible, though there is often considerable power of re-developing parts of the body which have been lost. The limbs

of Crustaceans are a particularly good illustration of this. It is no infrequent thing to see a Crab or Lobster in which one pair of pincers is of insignificant size, the fact being that it is a new growth replacing an accidental loss. A creature of this kind which is getting the worst of a combat thinks nothing of abandoning a few limbs, leaving them in possession of the enemy, and thus securing a safe retreat.

Among Backboned Animals (Vertebrata) there are some lower types in which vegetative propagation regularly takes place. Of this the best examples are the Sea-Squirts (*Urochorda*), many of which produce colonies by means of budding. But in the higher types, from Fishes to Mammals, development from eggs is the invariable rule. Regeneration of lost parts may, however, take place to a varying extent. Among Amphibians (Amphibia), for instance, the limbs of Newts and other tailed forms, as also those of very young individuals of the tailless species (such as Frogs), can be completely re-grown if lost. The best example in the class of Reptiles (Reptilia) is afforded by those lizards which sacrifice their tails for protective reasons (see vol. ii, p. 371). These members afterwards sprout again, but the internal structures are not renewed in their entirety, and the covering of scales may be of different pattern. In the hot-blooded Birds (Aves) and Mammals (Mammalia) the regenerative processes are practically limited to the healing of wounds and the renewal of patches of skin which have been destroyed. It is obvious that the lives of many individuals would be sacrificed but for the possibilities in this direction. And it is a matter of common knowledge that remarkable results have been attained in modern surgery by "grafting" little bits of living healthy skin into the surface of extensive burns and the like.

CHAPTER LIV

ANIMAL DEVELOPMENT PROPAGATION BY MEANS OF EGGS

DEVELOPMENT FROM EGGS IN ANIMALCULES (PROTOZOA)

The great majority of Animalcules are one-celled, a general rule which is but little upset by the fact that a number of forms are colonial, as the result of vegetative propagation. For in most such cases there is no division of labour between the members of the colony, all being precisely alike, and each of them having to discharge the various vital functions on its own account. For this reason a colony of this sort is said to be *physiologically* one-celled.

There can be no reasonable doubt that the remote ancestors of Many-celled Animals were one-celled forms, resembling Animalcules in essential respects, though many existing species of these have become greatly specialized on lines of their own, as the result of division of labour within the unit masses of living substance of which they are composed. And if this postulate be admitted, the Metazoa may be imagined to have arisen from colonial Protozoa in which the products of fission or budding remained united together. The operation of the principle of division of physiological work between the members of such a colony would ultimately result in the evolution of different *tissues*, *i.e.* groups of cells specialized in accordance with their particular duties, and the colony would then be in effect a simple kind of many-celled animal or Metazoon. Even the highest and most complex Metazoa are after all cell-communities in which division of labour is carried out into minute detail. An industrial illustration may serve to make this clearer. Supposing we take all the numerous processes involved in making boots to represent the sum-total of vital functions. Then a boot-maker who carries out all these processes with his own hands will correspond to a Protozoon. A number of boot-makers working together in the

same house, each making boots on his own account, will correspond to the more usual type of Protozoan colony. But the workmen in a boot-factory, divided into sets, each set doing a different part of the work, and all therefore interdependent, will correspond to a Metazoon. Supposing the division of work to be carried out imperfectly a lower Metazoon will be typified, but

if carried out into detail the nature of a higher Metazoon will be illustrated.

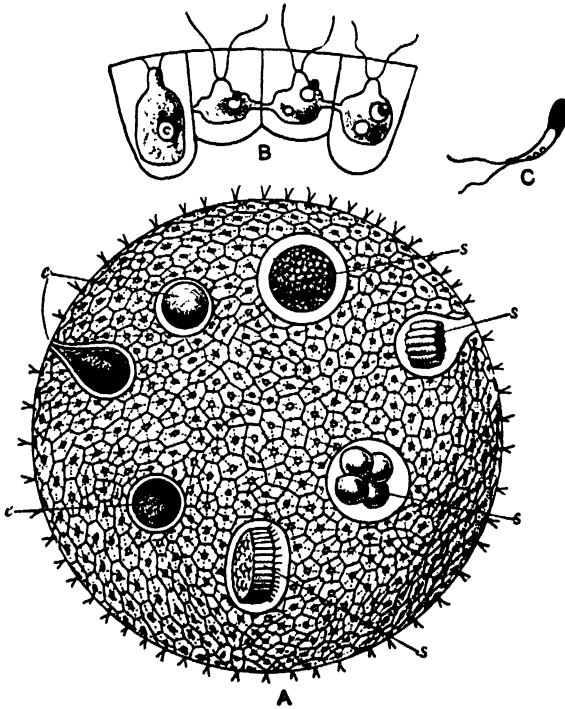

Fig. 858.—Volvox. A, A colony, much enlarged; *e*, egg-cells; *s*, sperms in various stages of development. B, Four individual members of colony in side view, still further enlarged. C, a sperm, greatly enlarged.

are some few colonial forms of Protozoa in which division of labour has already begun to take place, and in which there is propagation by means of eggs as well as by vegetative methods. One such form is a little freshwater organism (*Volvox*, fig. 858), which is about the size of a small pin's head, and of green colour. The colony is a hollow sphere with a gelatinous wall, in which are imbedded a large number of pear-shaped individuals the bodies of which are connected together by threads of living substance, while from each of them two filaments (*flagella*) of similar nature project to the exterior. The flagella execute lashing movements, by means of which the colony swims, at the same time

constantly rotating. Vegetative propagation is effected by budding, some of the individuals dividing repeatedly to constitute daughter-colonies that are set free into the central cavity of the parent colony, which ultimately breaks up and liberates them. But development can also be effected in quite a different manner, *i.e.* by the formation of eggs. Some of the members of the colony increase in size and assume a spherical shape. These are the eggs, or, to speak more accurately, *egg-cells* or *ova*. Other members of the colony exhibit a similar increase, after which they divide into a multitude of small orange-coloured cells, which are set free into the surrounding water, and swim about actively by means of the flagella with which they are provided. They are known as *sperms*. Each ovum is fertilized by the permanent fusion with it of a single sperm, a process which is curiously like what happens during the conjugation of the Bell-Animalcule (p. 325), where a small free-swimming bell is completely incorporated with a large fixed one. And here also the fusion imparts increased vigour, which is manifested by active fission. But in the Bell-Animalcule the products of division separate from one another and become solitary adults, while in *Volvox* the corresponding products remain united together, and collectively make up a new colony.

DEVELOPMENT OF EGGS IN MANY-CELLED ANIMALS (METAZOA)

If vegetative propagation be left out of consideration, we may say that every many-celled animal, from a Sponge to a Vertebrate, begins its life-history as an egg-cell or ovum, which is fertilized, in the vast majority of cases, by fusion with it of a sperm, derived, as a rule, from another individual. The fertilized ovum then actively divides to form a little mass of cells, which, by further divisions and specializations, gradually shape themselves into the tissues and organs of the adult. There is, in fact, a gradual evolution of the individual (*ontogeny*), from a simple unit-mass of living substance, and that this should be so is broadly interpreted by the Law of Recapitulation as the result of inheritance, whereby is repeated the evolutionary history (*phylogeny*) of the particular group of animals to which the developing individual belongs. And if this interpretation be correct, the first stage in the life-

history, *i.e.* the egg-cell, stands for the original one-celled ancestors of the many-celled animals. This gradual building up of the complex body of an animal is one of the most astonishing facts with which zoology has to deal, and can only be explained on an evolutionary basis. The early students of development held views which were totally at variance with the facts as we now know them. They believed, for instance, that the youngest discernible stage in the growth of the chicken within the egg differed from the adult bird only as regards size. This was the doctrine of Preformation, according to which development merely consisted in the enlargement of parts already present, by a process of "unfolding" or "evolution". The last expression was used, it

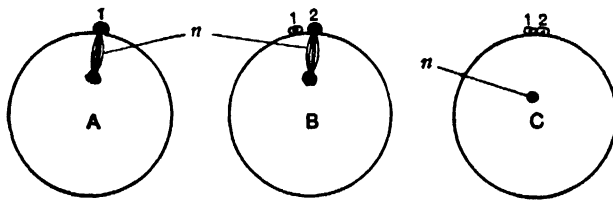

Fig. 859.—Formation of Polar Bodies, diagrammatic

In A and B is shown successive formation of first and second polar bodies (1 and 2). C, Egg-cell ready for fertilization; 1 and 2, first and second polar bodies; n, nucleus.

will be noticed, in quite a different sense from the modern one. The rival doctrine of Epigenesis, according to which the body is gradually built up in the way already indicated,

owes its first inception to the gifted investigator, Caspar Friedrich Wolff, who flourished in the latter part of the eighteenth century. In the realm of botany the errors of the Preformation theory linger even yet. The present writer has had the doubtful privilege of hearing eloquent discourses embellished by such statements as: "The tiny acorn contains in miniature every root, twig, and leaf of the mighty oak, of which it is the parent".

Polar Bodies (fig. 859).—Before an egg-cell is mature and ready to be fertilized it twice undergoes unequal division, of which the smaller products are known as "polar-bodies". They take no part in the development, but sooner or later disintegrate. As a result of their extrusion the egg-cell gets rid of three-quarters of its nuclear substance. The maturation of sperms is associated with a similar process. Why polar bodies should be formed at all is by no means clear, though they have been the object of a large amount of investigation and speculation. It is quite likely that, for one thing, the egg-cell is, so to speak, weakened, and thereby prevented from developing into an adult animal without fertiliza-

tion, which is undoubtedly a process resulting in increased vigour. Presumably individuals developed from unfertilized egg-cells would be less fitted to struggle for existence than those arising in the usual way. The facts ascertained regarding the conjugation of Protozoa throw some light on this (see p. 323). Rare cases are known in which unfertilized ova do develop, and those which are thus distinguished do not as a rule give rise to more than one polar body. It may here be further noted that these bodies very probably have some bearing on the question of heredity, a point which will be dealt with further on.

Law of Recapitulation.—We have seen that certain colonial Animalcules, such as Volvox, help to bridge over the gap between one-celled animals (Protozoa) and many-celled animals (Metazoa), and that in the life-history of one of the latter the egg-cell which constitutes the starting-point is reminiscent of the original one-celled ancestors. But it would be a great mistake to suppose that the Law of Recapitulation enables us to work out in detail the evolutionary history of groups from the stages through which the members of those groups pass in the course of their development. For although, as Milnes Marshall picturesquely put it, an animal may be broadly said to “climb up its own genealogical tree” in the course of its life-history, yet the Law of Recapitulation is by no means the never-failing guide in matters evolutionary that many enthusiastic naturalists once supposed. The expression “*once supposed*” is used advisedly, for at the present time there is a tendency to discount the law in question to an extent which is hardly warranted by the facts. Balfour, the most gifted embryologist of last century, thus expressed the matter (in his *Comparative Embryology*) in his usual clear and vigorous way: “Were it indeed the case that each organism contained in its development a full record of its origin, the problem of phylogeny [*i.e.* evolution of animal groups] would be in a fair way towards solution. As it is, however, the law [of recapitulation] above enunciated is, like all physical laws, the statement of what would occur without interfering conditions. Such a state of things is not found in nature, but development as it actually occurs is the resultant of a series of influences of which heredity is only one. As a consequence of this, the embryological record, as it is usually presented to us, is both imperfect and misleading. It may be compared to an ancient manuscript with many of the sheets lost, others displaced, and with

spurious passages interpolated by a later hand. The embryological record is almost always abbreviated in accordance with the tendency of nature (to be explained on the principle of the survival of the fittest) to attain her ends by the easiest means. The time and sequence of the development of parts is often modified, and finally, secondary structural features make their appearance to fit the embryo or larva for special conditions of existence. When the life-history of a form is fully known, the most difficult part of his task is still before the scientific embryologist. Like the scholar with his manuscript, the embryologist has by a process of careful and critical examination to determine where the gaps are present, to detect the later insertions, and to place in order what has been misplaced."

The difficulties mentioned above at once beset us when we attempt to explain on an evolutionary basis the processes through which the egg-cell goes immediately after fertilization. These consist of a series of divisions, technically known as *cleavage* or *segmentation* (not to be confounded with segmentation of the adult body), by which a little mass of cells, *i.e.* a *blastula*, is brought into existence. Nothing could be easier than to assert that this stage corresponds to the colonies of Protozoa which evolved into the earliest Metazoa, and such an assertion would no doubt be true in a general way. But it is rather disappointing to find that the blastula differs greatly in animals of different kind. Sometimes it is spherical and solid (*morula*), sometimes spherical and hollow (*blastosphere*), or it may be a two-layered plate of cells (*placula*). And occasionally it is not composed of cells at all, but is a mass of protoplasm containing numerous nuclei, which serve as centres round which cells are later on marked out. To decide which of these forms is *primary*, *i.e.* really represents an early ancestral stage, and which are *secondary*, *i.e.* modifications due to the exigencies of development, would puzzle Solomon himself, supposing that worthy to be posted in the facts and methods of modern science. And, as often happens, the triumph of one view over the rest might conceivably be not so much a contribution to fact as a tribute to the ability or ingenuity of some forceful authority. As the late Professor Huxley was wont to remark, in his characteristic way: "Theories which at first blush appear to be the most complete and beautiful are commonly those which are most easily upset". Without attempting to support the claims of any one kind of

blastula to ancestral honours, the present writer would point out that all of them can be more or less completely matched by members of the group of Protozoa, though the placula comes off worst in this respect. And the possibility is by no means excluded that different groups of many-celled animals have arisen independently from colonial Protozoa which did not all conform to the same type.

A brief sketch of the chief stages in the development of a few typical animals will form a fitting conclusion to the present section.

Development of the Freshwater Polype (Hydra).—With the possible exception of Sponges (Porifera), the great group of the animal kingdom (Cœlenterata) of which Hydra is a member may be regarded as the lowest division of many-celled forms (Metazoa). Digestive arrangements are of such great importance to the well-being of animals that we might expect them to be evolved very early in the history of the Metazoa. And it has been remarked with truth that Cœlenterates may be epigrammatically defined as “living stomachs”. This is certainly the case in Hydra, the body of which is a hollow cylinder, with a mouth at one end, surrounded by a circlet of tentacles that catch food, which is taken into the large central cavity and there digested. The numerous cells making up the body are disposed in two layers, and this may be taken to represent commencing division of physiological labour. The inner layer (*endoderm*), lining the central cavity, is concerned with digestion, and the outer layer (*ectoderm*) is not only protective, but also performs the duties which are carried out in higher forms by the nervous system and sense organs. In Hydra there is a thin structureless supporting membrane (*mesogloea*) between the two cell-layers, and in many Cœlenterates, such as jelly-fishes, this may be extremely well developed, and contain various cells which have wandered into it from ectoderm and endoderm. But it is not a continuous sheet of closely-connected cells, as are the two latter, and therefore all Cœlenterates are regarded as being *two-layered*

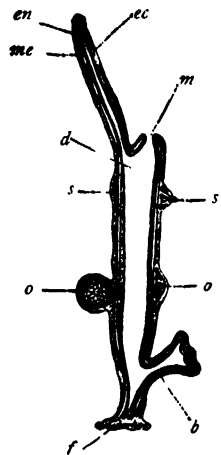

Fig. 86a. — Diagrammatic Longitudinal Section of Freshwater Polype (*Hydra*), enlarged
m, Mouth; *f*, foot; *d*, digestive cavity; *ec*, ectoderm; *en*, endoderm; *oo*, ovaries; *ss*, spermaries.

animals, as contrasted with still higher forms which, as we shall see, are essentially *three-layered*.

During the summer months Hydra propagates by means of budding, but as the autumn approaches, one or more rounded thickenings of the ectoderm appear near the attached end, and several pointed thickenings of the same layer near the mouth end (fig. 86o). Each of the former is an *ovary*, and each of the latter a *spermary*. Within the ovary there are at first a number of little cells, one of which becomes bigger than its fellows, and uses these as food after the fashion of an Amœba. It has now become

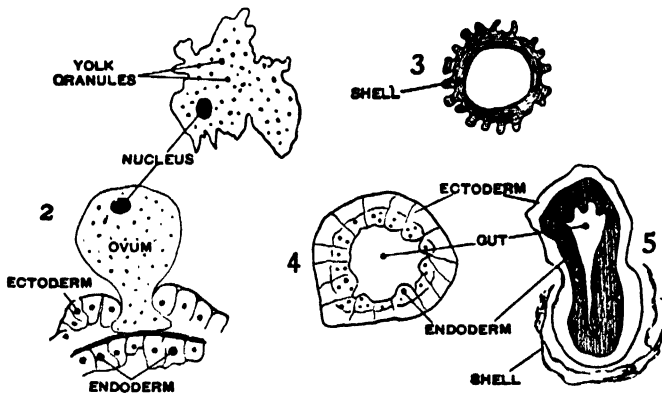

Fig. 86r.—Development of Freshwater Polype (*Hydra*), enlarged

1, Ovum in amoeboid stage. 2, Ripe ovum projecting from body-wall of adult. 3, Section through egg-shell. 4, Section through embryo in two-layered stage (shell omitted). 5, Section through ripe embryo escaping from shell (cells of ectoderm and endoderm not shown).

an egg-cell or ovum, within which are to be seen a number of granules of nutritious substance (yolk) which serve as food to the developing embryo. After a time the covering of the ovary is ruptured, and the egg-cell projects externally. Each spermary also contains a little mass of cells that divide repeatedly to form a large number of minute tadpole-shaped bodies, the sperms, which are ultimately set free into the surrounding water, where they swim about. Precisely as in *Volvox* (p. 335) the egg-cell is fertilized by fusion with it of a single sperm, derived from the same or another *Hydra*. The fertilized egg-cell next surrounds itself with a firm protective coating, and undergoes cleavage to form a mass of small cells (*morula*), which may be called an embryo (fig. 86i). This now becomes detached from the body of the parent, and falls into the mud, where it remains in a dormant state during the winter. Since all or most of the adult animals

die, these dormant embryos enable the species to tide over an unfavourable season, answering the same purpose as the winter buds of freshwater moss-polypes (p. 330) or the seeds of annual plants. During the following spring development is renewed, the changes which take place converting the solid Blastula (*morula*) into a two-layered *Gastrula*, possessing a central digestive cavity. The protective coat is ruptured, the embryo elongates, a mouth and tentacles are developed, and we have now a young Hydra, which feeds actively and grows into an adult.

The two-layered stage in development, *i.e.* the *Gastrula*, is of great interest, and in one form or other represents a stage in the life-history of the members of a great many groups of animals. In its most typical form a mouth is present from the first, and often is used as such, food passing through it into the central digestive cavity (*archenteron*, *i.e.* primitive gut). Some specialists, indeed, would not apply the term *Gastrula* to a two-layered embryo devoid of mouth. We have seen how difficult it is to decide which of the various kinds of Blastula are to be looked upon as representing an early ancestral stage. The *Gastrula*, however, probably repeats a somewhat later phase in the evolutionary history of Metazoa with some approach to accuracy. The Cœlenterates remain throughout life permanent and specialized *Gastrulæ*. And according to the *Gastræa* theory of Hæckel all the higher groups of animals are entitled to place some variety or other of the *Gastrula* in their picture-gallery of ancestors. Other authorities, however, are by no means unanimous on this point, though there seems to be a good deal of truth in Hæckel's view, the weak point in which lies in the assumption that the stage preceding the *Gastrula* was a hollow sphere, which attained the double-layered stage by in-pushing, much as an air-containing india-rubber ball, when collapsed, becomes a double-walled cup. Such a process certainly does not take place in the development of Hydra, but is true for a number of other animals, as we shall presently see.

Development of a Simple Calcareous Sponge.—The Sponges (Porifera) constitute a very problematic group of animals, of which the relationship to other forms is obscure. They are sometimes regarded as a branch of Cœlenterates, but it is more likely that they are a distinct group or phylum which has taken independent origin from Protozoan-like ancestors. It does not fall within the province of this work to discuss so difficult a technical problem,

but the following sketch of the development of a simple typical sponge may not be without interest (fig. 862). The fertilized egg-cell divides repeatedly to give rise to a solid Blastula (*morula*), the cells of which next arrange themselves into two concentric layers (*ectoderm* and *endoderm*), while a central digestive cavity also makes its appearance, very much as in Hydra. The outer cells develop a covering of cilia, by means of which the embryo, or rather larva, which is now of oval form, swims about for a time. The term *larva* has elsewhere been explained, but it may not be superfluous to repeat here that it is applied to an embryo which leads an independent existence, and differs more or less markedly from the adult. This particular sort of larva is known as a Planula, and is also a stage in the life-histories of many Cœlenterates. It is at first mouthless, but a mouth is soon developed, and a typical gastrula stage is thus attained. The larva now fixes itself by the mouth end, and loses its covering of cilia. A new opening makes its appearance at the free extremity, and becomes the osculum of the adult. Further important changes consist in the appearance of a large number of small holes in the body-wall, and the development of a layer (*mesoglæa*) between ectoderm and endoderm. Cells pass into this, and some of them give rise to three-rayed spicules of calcareous nature, each ray taking origin from a separate cell; others become egg-cells. By subsequent budding a colony may be formed.

Early Stages in the Development of the Lancelet (Amphioxus).—While Cœlenterates and Sponges essentially consist of only two continuous sheets of cells (*ectoderm* and *endoderm*), although a third jelly-like layer (*mesoglæa*) afterwards makes its appearance between these, and usually contains cells of various kind, a further stage is reached in higher groups of animals. For in any one of these the embryo, after passing through a two-layered or gastrula stage, develops a third sheet of cells (*mesoderm*) between ectoderm and endoderm. Many difficult problems centre in the mesoderm, but with these we are not here concerned.

The three-layered animals, of which the Lancelet is selected as a type, illustrate the principle of division of physiological labour in a much higher degree than do the two-layered forms, and are consequently of more complex structure. This has already been abundantly illustrated in preceding sections, and will become still more obvious when we have to consider the Nervous System and

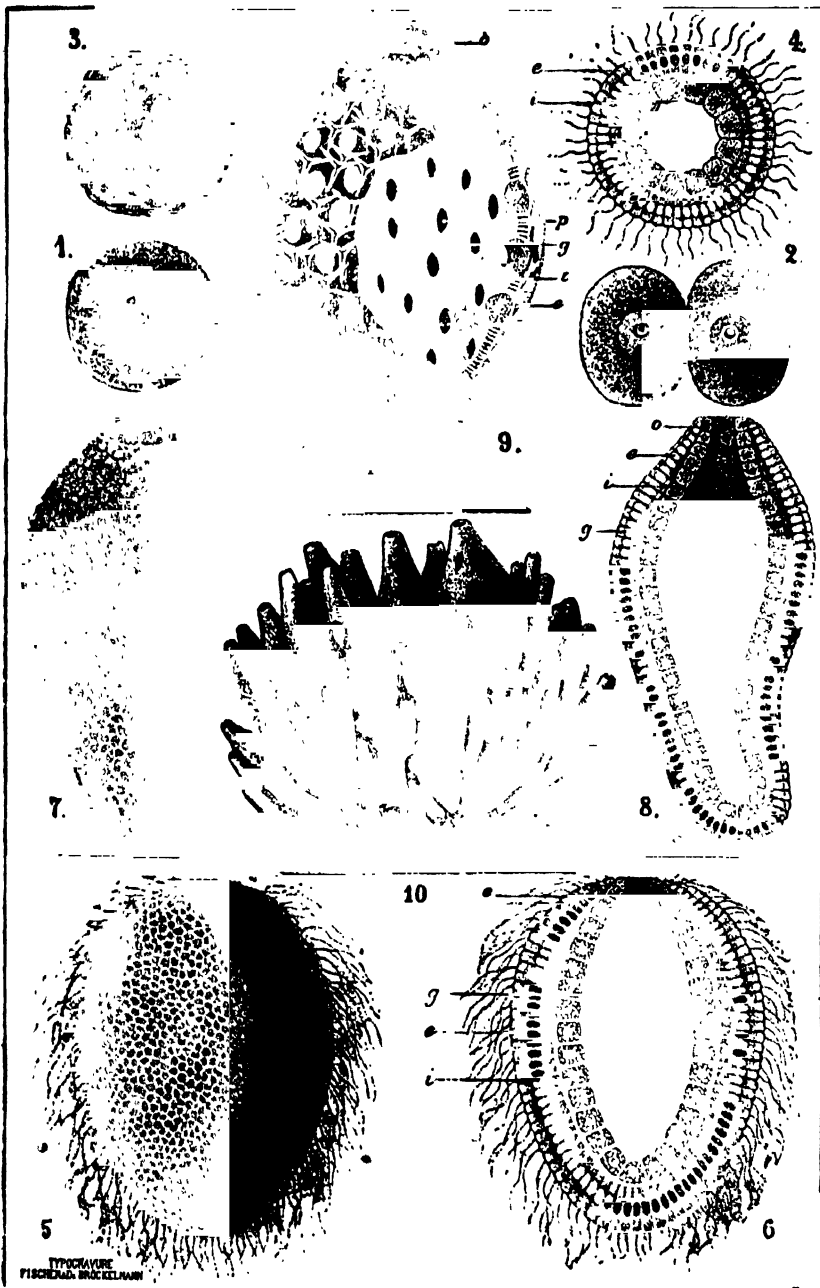

Fig. 862.—Stages in Development of a Sponge, enlarged (except 10) to various scales

e, Ectoderm; *i*, endoderm; *g*, digestive cavity; *o*, main opening (osculum) of digestive cavity; *p*, pore in body-wall. 1, Ovum. 2, First division of ovum. 3, Morula. 4, Two-layered embryo (in section). 5, Ciliated Planula, drawn at 6 in section. 7, Later fixed stage (in section at 8). 9, Adult stage (side-wall partly removed) showing numerous pores and three-rayed spicules. 10, Colony formed by budding.

Sense Organs, by means of which the activities of animals are regulated and directed.

The small egg-cell of the Lancelet passes out of the body, and is fertilized in the surrounding sea-water, after which it undergoes cleavage to become a Blastula, which in this case is a hollow sphere (*blastosphere*), the wall of which is formed by a single layer of cells (fig. 863). These are rather larger on one side of the sphere. The two-layered stage or Gastrula is then reached by a sort of in-pushing of the larger cells to constitute the lining of a large central digestive cavity (*archenteron*), that communicates with the exterior by a mouth, technically known as the *blastopore*. This internal layer of cells is the *endoderm*, while the smaller

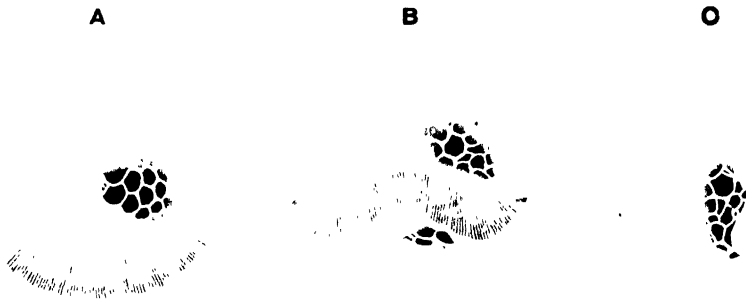

Fig. 863.—Young Embryos of Lancelet (*Amphioxus*), enlarged, and bisected to show interior. A, Blastosphere. B, Commencing gastrula. C, Gastrula. See text.

external cells are collectively known as the *ectoderm*. The two-layered Gastrula next gives rise to a three-layered stage, in a way which may be gathered by reference to fig. 864, which represents cross-sections through four embryos of different age, the youngest being on the left. The wall of the central digestive cavity bulges out at the upper corners, as indicated by dark shading in the figures, and the pouches thus formed gradually get pinched off, coming to lie between the ectoderm and endoderm. They subsequently grow right round the body and constitute the *mesoderm*, or middle embryonic layer. The cavities of the pouches become the body-cavity of the adult, *i.e.* the lymph-containing space, or in this case series of spaces between body-wall and the wall of the digestive tube.

It will be worth while to consider to what parts the three layers of the embryo respectively give rise. 1. The innermost layer (*endoderm*) becomes the thin cellular membrane (*epithelium*) which lines most of the digestive tube and also its outgrowths, such as the

liver, which in the Lancelet is a simple pouch. And the endoderm also gives rise to the elastic rod or notochord, which represents the backbone in this particular animal, and is replaced partly or entirely by the backbone in higher Vertebrates. The origin of this rod is indicated in fig. 864. The wall of the upper part of the digestive cavity is seen to be grooved in B, just between the two mesodermic pouches. In C the groove is better marked, and in D a strip of the wall of the digestive cavity has been pinched off to form a rod, of which the section appears oval. 2. The outermost layer (*ectoderm*) naturally gives rise to the *epidermis*, or external part of the skin. From it the nervous system and the essential parts of the sense organs also take origin. The development of

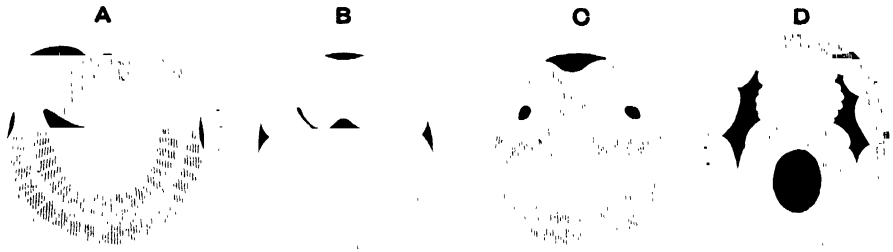

Fig. 864.—Cross-sections through older Embryos of Lancelet (*Amphioxus*), enlarged. Mesoderm darkly shaded. The central space is the digestive cavity. See text.

the hollow dorsal tube which constitutes the central part of the nervous system is seen in fig. 864. A central strip of ectoderm on the upper side of the body is thickened into a sort of plate, which sinks into the body and then folds up into a tube. Examination of the upper parts of A, B, C, and D will make this clear, remembering, of course, that only thin cross-sections of this strip are shown. 3. The middle layer (*mesoderm*) is the parent of all the remaining organs, as, for example, those concerned with circulation and development of eggs. The muscular system and the muscle in the wall of the digestive tube are also products of this layer, as are the deeper part of the skin (*dermis*) and all the supporting fibrous tissue found throughout the body.

The fate of the three embryonic layers, as just summarized, is practically the same in all three-layered animals, from backboneed forms down to Worms and Echinoderms.

Influence of Food-Yolk on Development (fig. 865).—The egg-cells of different animals vary greatly in size, according to the amount of nutritive matter, or food-yolk, which is stored up in

them, to be employed in building up the body of the embryo. The quantity and distribution of this material have much to do with the nature of the cleavage which succeeds fertilization. Unless a great deal of it is present the cleavage is *total*, the whole of the egg-cell taking part in the divisions which produce the blastula. But it happens in many cases that the yolk is not uniformly distributed, being concentrated towards one end (or "pole"), and the

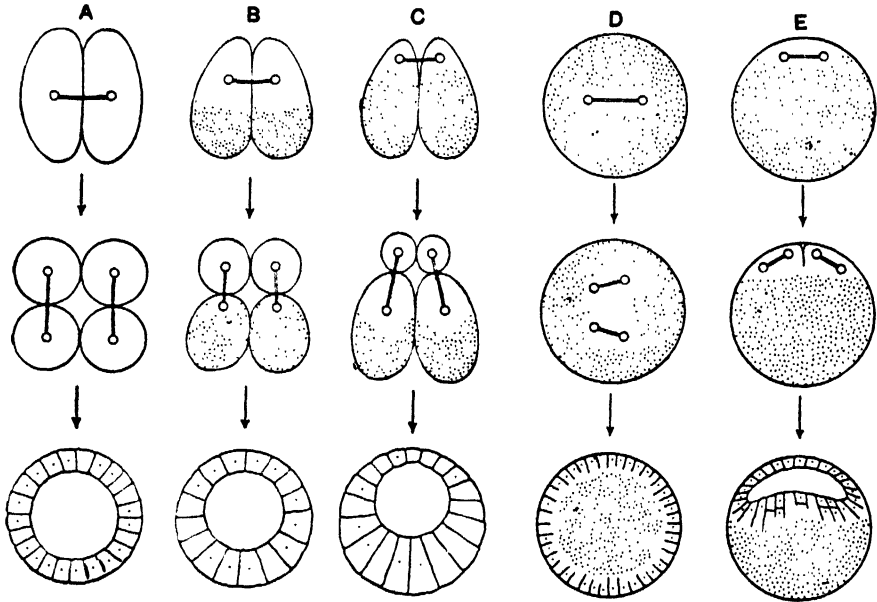

Fig. 865.—Influence of Food-yolk on Development. Diagrammatic sections

Read each column from above downwards. The food-yolk represented by dots. The two upper lines show early stages in division of the ovum, and the bottom line the blastula stage. A, Total equal cleavage (no yolk). B and C, Total unequal cleavage (yolk at one pole). D, Partial cleavage (central yolk). E, Partial cleavage (yolk at one pole). For convenience' sake all the figures are made of the same size, but the size of an ovum is proportionate to the amount of food-yolk it contains, e.g. A would be very small and E very large.

cleavage-cells are larger in this region. From this we pass to egg-cells which are so crammed with yolk that cleavage is *partial*, i.e. only that part of the cell which is not thus encumbered divides. This may be a patch at one pole, as in the eggs of Dog-Fishes and Birds, or it may be a surface layer, as in Arthropods, where the yolk is massed in the centre.

In egg-laying or *oviparous* animals, as opposed to *viviparous* forms, in which the young animal is brought into the world more or less ready to commence independent existence, the time of hatching depends upon the amount of yolk, or of this and other nutritive matters which may be enclosed in a protective covering

with the developing embryo for its use. If these stores of food material are abundant, the changes which go on within the *egg*, as we may term the egg-cell together with accessory structures, may take a considerable time, and the young animal may hatch out in a form not very unlike that of the adult. A familiar example is afforded by the life-history of a Fowl. The egg is of large size, and made up of the developing egg-cell with the nutritive matter stored up in it (the "yolk"), of the extra food-supply known as the *albumen* (the "white"), and of two protective coverings, *i.e.* the double *shell-membrane* and the porous calcareous *shell* (fig. 866). As everyone knows, the chick which emerges from the egg after

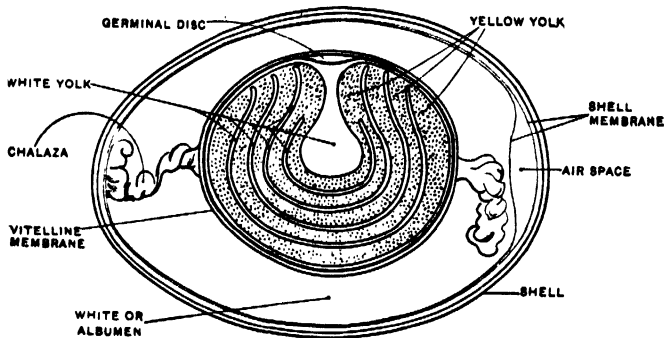

Fig. 866.—Diagrammatic Longitudinal Section through a Hen's Egg

three weeks' incubation is at once able to run about, and soon begins to pick up food.

On the other hand, hatching-out is a comparatively rapid process in the case of eggs which contain a small amount of nutritive matter, and the young animal is consequently in a very immature condition when it is thus prematurely forced to get its own living. It may often be described as a larva, which is very unlike the adult stage to which it ultimately attains. We have seen, for example, that a typical sponge is hatched out as a little ciliated oval Planula, and it may be added that the young Lancelet does not at first resemble the parent form. These, however, are somewhat extreme cases. Larval forms may result from the hatching of eggs containing a fairly large amount of yolk, as in the Frog. And it does not follow that the presence of large stores of nutritive material in the egg is correlated with such perfectly-formed young as those characteristic of Fowls. The nestlings of a Sparrow, for instance, are particularly helpless, and

superficially unlike their parents. But this is largely due to their featherless condition, and they are obviously of bird nature, so not entitled to be called larvæ.

In applying the law of recapitulation to animals possessing a larval stage in their life-history, there is special need to exert care in making deductions as to the characters possessed by ancestral forms. There is great likelihood of organs developing out of their proper order, for those which are absolutely necessary to the life of the larva when it begins an independent existence take precedence of others which are not of such vital importance in the struggle for existence. This is particularly true for organs of locomotion and digestion, while few larvæ would survive if the nervous system and sense organs were not in an efficient state. Such parts of the body have to hurry up, as it were, or in other words there is a "hastening of events". Larvæ are also very apt to possess *secondary* characters, *i.e.* features specially related to the exigencies of larval life, which frequently differs in a marked way from adult existence. And it is obvious that such characters often afford no clue to the nature of ancestral forms.

ANIMAL LIFE-HISTORIES—PROTECTION OF EGGS AND YOUNG—ANIMAL DWELLINGS

CHAPTER LV

LIFE-HISTORIES, &c., OF BACKBONELESS ANIMALS (INVERTEBRATA)

To do full justice to the important question of Life-Histories, and related topics, a complete volume of this work would not afford too much scope. But, as full treatment of the kind would lead to undue limitation of the space to be devoted to equally interesting subjects, it is proposed to deal with only a small number of cases, selected with reference to general principles. Protection of Eggs and Young will include *passive protection* by mechanical devices, and also *active protection* on the part of parents. And it may be remarked that Animal Dwellings commonly owe their importance to the fact that they are employed as nurseries, and some of them are constructed solely for this purpose. Certain life-histories have already been dealt with more or less fully in earlier sections, and others will receive treatment in the later parts of this work, under such headings as Instinct and Intelligence, Parasitism, &c.

LIFE-HISTORIES, &c., OF ZOOPHYTES (CŒLEENTERATA)

A great many of the familiar forms known as Jelly-Fishes are simply stages in the life-history of fixed colonial animals that have been produced by the budding of a single individual. A typical case is represented in fig. 867. We have here a simple illustration of the phenomenon known as *alternation of generations*. In other words the life-cycle does not consist of the continuous gradual growth of an individual from a bud, fission-product, or egg, but comprises at least two stages or generations, one propagating by

vegetative means, and the other by eggs. In this case the former is the fixed branching colony (*hydroid zoophyte*), which not only buds to increase its size, but also produces special buds which are liberated as jelly-fishes or medusæ. These produce eggs, which develop into oval ciliated free-swimming larvæ (*planulæ*), something like those already described for Sponges (see p. 342). After a time each larva fixes itself to some firm body, and becomes an individual essentially resembling a Freshwater Polype (*Hydra*).

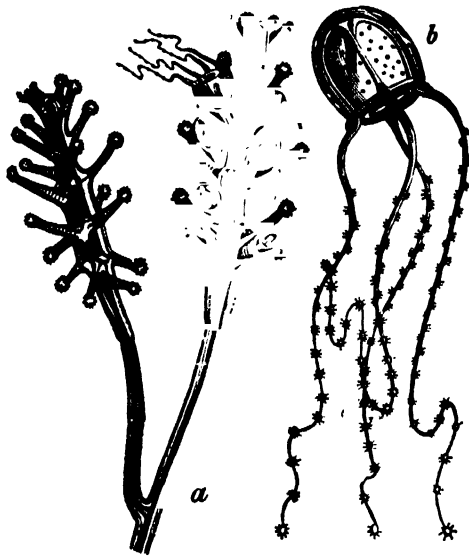

Fig 867.—Life-history of *Syncoryne*

a, Two individuals from the fixed colonial stage (*hydroid zoophyte*) each studded with knobbed tentacles, between which (in one individual) are buds which become liberated as medusæ; *b*, a medusa.

By means of budding, a fixed colony (*hydroid zoophyte*) arises from this; later on, special buds grow into medusæ, and so on. If the hydroid zoophyte or *vegetative stage* be represented by *v*, and the medusa or *egg-producing stage* by *E*, the formula $v-E-v-E-v-E$, &c. will represent the succession of stages, $v-E$ being a single cycle or life-history. But we cannot say that this is the life-history of an individual, since both *v* and *E* are individuals. And the singularity of the matter consists in this, that any given member of the series closely resembles

its grandparents and grandchildren, but differs greatly from its parents and children.

In some of the Hydroid Zoophytes there are special arrangements for protecting the medusa-buds while they are being developed. Instead of projecting freely into the surrounding seawater, a group of them is sheltered in a little horny case (*gonangium*, fig. 868).

It must not be supposed that all of the numerous species of Hydroid Zoophytes give rise to free-swimming jelly-fishes, for the egg-cells and sperms are often produced in special buds (*gonophores*) which are never liberated. These buds may be precisely like jelly-fishes in structure, obscurely like, or quite

unlike (fig. 869). In the last case they are rounded projections known as *sporosacs*, a rather unfortunate name, for spores are certainly not produced in them. The ovaries and spermaries of Hydra (see p. 340) may be regarded as sporosacs of the simplest possible kind. The series of egg-producing buds just outlined, from the free-swimming medusa condition down to Hydra, appear to represent a set of evolutionary stages by which the jelly-fish stage as such has been practically superseded. A fixed colony, such as that represented by a Hydroid Zoophyte, is in some respects at a disadvantage, for if markedly unfavourable changes

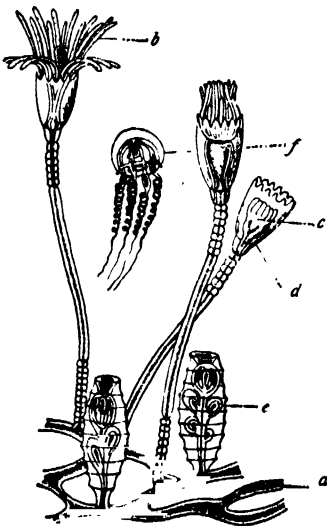

Fig. 868.—Life-history of Campanularia

a, Branching base of fixed colony; b, expanded individual; c, individual retracted into its cup (d); e, case within which medusa buds are developing; f, a free-swimming medusa.

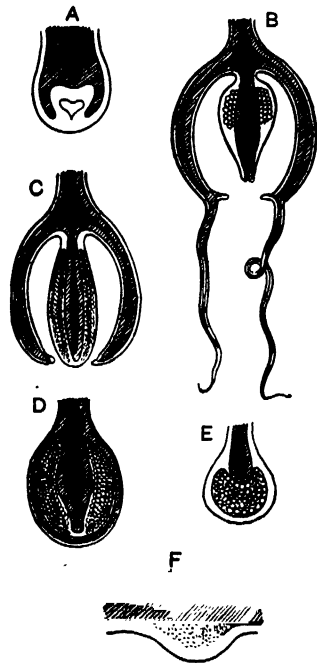

Fig. 869.—Gonophores of various Zoophytes in section—diagrammatic

Digestive cavity black, ectoderm white, endoderm shaded, egg- or sperm-producing cells as small circles. A, Developing gonophore. B-F, Stages in degeneration of gonophores (F is sporosac of Hydra).

take place in the surroundings it is not able to move away in search of a more desirable locality, and if the area occupied by the species were small, such changes might conceivably lead to its complete extinction, if there were no compensating arrangement. Probably the jelly-fish stage was originally evolved as an arrangement of the kind, whereby eggs could be carried to considerable distances, so that a reasonable percentage of the embryos produced from them would have a fair chance of reaching suitable spots for settling down and budding into fixed

colonies of Hydroid Zoophytes. But if this view approximates to the truth, it is rather difficult to understand why some of the Hydroid Zoophytes have given up the jelly-fish stage, which presumably increased their chances in the struggle for existence. It can only be conjectured that since the production of eggs from which free-swimming *larvæ* hatch out takes less time and involves less expenditure of energy than the production of jelly-fishes that serve the same purpose, some Zoophytes have abandoned the latter plan altogether, while others are giving it up.

All jelly-fishes are not developed as buds on a fixed colony. Many of them result from the transverse fission of attached indi-

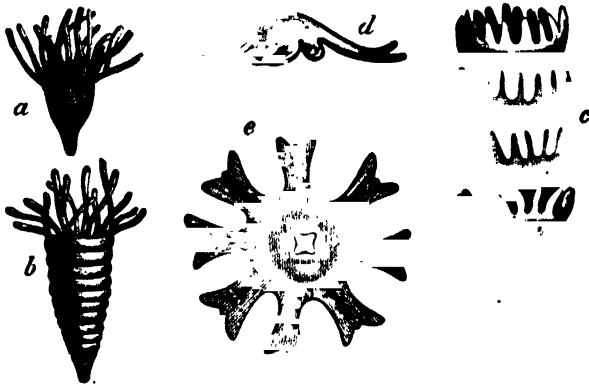

Fig. 870.—Life-history of *Aurelia*, enlarged. *a, b, c*, Stages in transverse division of fixed individual; *d, e*, an Ephyra.

viduals, as, *e.g.*, the common form *Aurelia* (fig. 870), which affords another illustration of alternation of generations. The fixed individual here divides transversely into a number of little flat Ephyræ, each of which grows into an adult Medusa.

Some of the jelly-fishes related to *Aurelia*, and others belonging to certain other groups, have suppressed one stage in the cycle of existence, reminding us of some of the Hydroid Zoophytes. But in this case it is the fixed or vegetative stage which has been eliminated, while the egg-producing Medusa stage has been retained. In these species, which include some of the large forms of jelly-fish common in British seas, there is consequently a succession of Medusæ, instead of an alternation of these with fixed forms.

In some of the groups already mentioned there are interesting arrangements for securing the well-being of egg-cells, or, it may be, embryos. In *Hydra*, for example, as we have seen (p. 340), the single egg-cell in the ovary is the surviving member of a small mass of similar cells, with which it has had literally to struggle for existence. And it has not merely supplanted its sister-cells, but actually eaten them, affording us an illustration of cannibalism the precocity of which it would be hard to beat.

In fig. 871 a jelly-fish is represented in which the egg-cells resemble *Amœbæ*, and creep about in search of food on the outer surface of the mouth-bearing tube which hangs down from the umbrella of the parent.

. In *Aurelia* there are four plaited projections from the corners of the mouth, in the folds of which part of the development takes place.

The life-histories of Sea-Flowers (Anthozoa), such as Sea-Anemones and Corals, are less sensational in character than

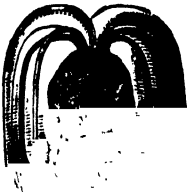

Fig. 871.—A Jelly-Fish (*Amathea amabigera*), showing the eggs creeping on the large mouth-tube; enlarged

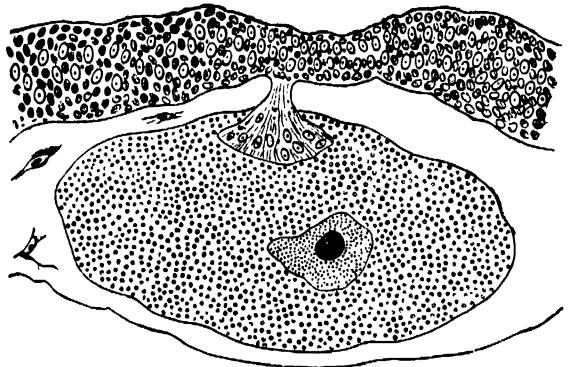

Fig. 872.—Egg-cell of a coral (*Corallimorphus rigidus*), with cells of the nutritive layer (above) projecting into it. Within the egg-cell are seen the large nucleus and numerous yolk-granules. Much enlarged.

those of the Cœlenterates already dealt with under this heading. But they are not lacking in interesting features. In fig. 872 is represented, on a greatly enlarged scale, the egg-cell of a sort of coral, which develops in the proximity of the nutritive layer, from which it is, in fact, derived. A little group of these cells project into its substance, and serve as a means of supplying it with food.

In both Sea-Anemones and ordinary Corals it usually happens that the early stages of development take place within the body of the parent, as far as the free-swimming ciliated larval stage (*planula*). These larvæ are then ejected through the mouth, later on become fixed, and grow into adults. Their locomotor powers prevent the fixed habit of the mature forms from becoming too great a disadvantage to the species.

LIFE-HISTORIES, &c., OF HEDGEHOG-SKINNED ANIMALS
(ECHINODERMATA)

In most members of this group the eggs hatch out into larvæ, which are often of remarkable shape and extremely unlike the parent forms, the characters of which they ultimately acquire by passing through a complicated series of changes constituting a

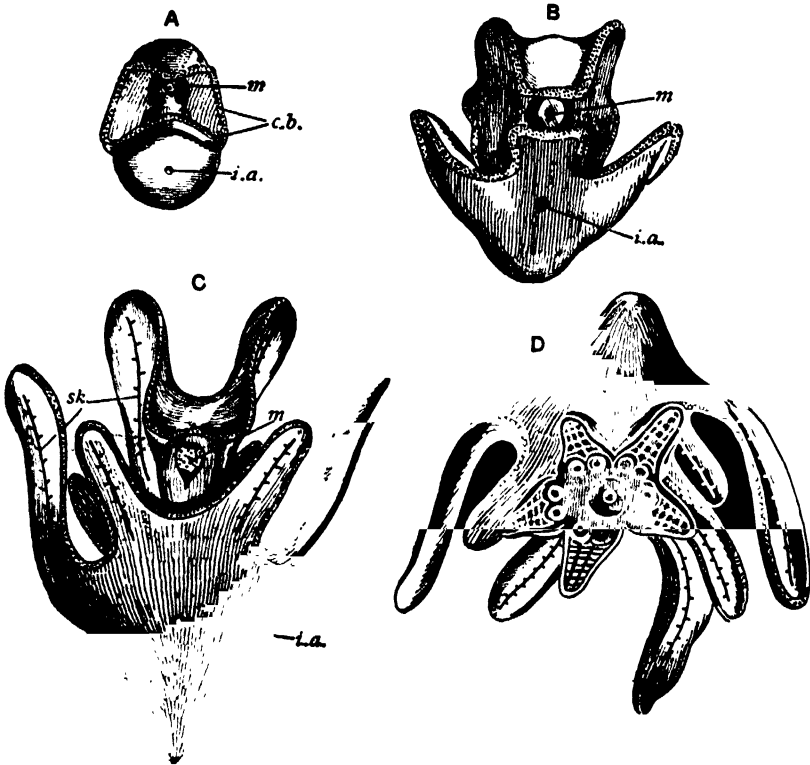

Fig. 873.—Life-history of a Brittle-Star

m, Mouth; *i.a.*, intestinal aperture; *c.b.*, ciliated band; *sk*, calcareous skeleton. A-C. Stages in development of Pluteus. D, Young Brittle-Star developing on the Pluteus. Enlarged.

metamorphosis. Each subdivision of the Echinoderms is characterized by a particular kind of larva, and we may take the Brittle-Stars (*Ophiuroidea*) as one of the most interesting illustrations.

The just-hatched young is oval in shape and bilaterally symmetrical, there being a well-marked distinction between front and back ends, and also between dorsal and ventral surfaces. Both mouth and intestinal aperture are on the ventral surface, and there is a ciliated band by means of which swimming is

effected, and which is arranged as shown in fig. 873. Later on, the body grows out into a number of narrow "arms", on to which the ciliated band is continued. These are directed forwards, and supported by an internal skeleton of calcareous rods, which are united together in the hinder part of the body. The larva is known as a Pluteus. After a time the body of the adult star-fish begins to appear as a thickening in the body-wall of the larva, and as this increases in size the ciliated arms, with their supporting skeleton, are gradually absorbed. The internal organs of the Pluteus become the corresponding parts of the adult Brittle-Star. In some creatures of this kind there is not a free-swimming larva, but the fertilized eggs gradually assume the adult form, being sheltered in the meantime in pouches situated between the bases of the arms, and already spoken of in regard to breathing (see vol. ii, p. 414). This kind of life-history is, however, exceptional among Brittle-Stars, and has resulted from abandoning the method of *indirect development*, i.e. through a larval form, for *direct development*, by which the adult stage is gradually attained without any startling transformations.

The use of free-swimming larvæ is doubtless to help in spreading the species, but the mortality of such immature forms is exceedingly large. The more sheltered direct type of development presents such advantages in this direction that we can understand why, in some species, it has superseded the larval type altogether, as, for example, in our commonest shore form (*Amphiura squamata*). If the eggs of this particular species developed into Plutei the chances of one of these becoming adult and reaching a suitable spot in which to live would be very remote. Direct development is here distinctly more favourable to survival, and as this species may also be said to possess a dwelling, since it is commonly found under stones near low-water mark, the chance of a given egg becoming an adult is still further increased.

Sea-Urchins (Echinoidea) usually have much the same sort of



Fig. 874.—Young Sea-Urchins (*Hemisteria coveri*).

life-history as Brittle-Stars, being hatched out as *Pluteus* larvæ, though these differ in some respects from the kind already described. And in this case the mouth and gullet of the larva do not become those of the adult, which has to develop a second edition of these parts. Some Sea-Urchins resemble the exceptional Brittle-Stars already mentioned in having given up the



Fig. 875.—Sea-Urchins burrowing in Limestone

larval type of development. And here also brood-pouches are present, in which the eggs are sheltered, as in the species represented in fig. 874, where parts of the areas from which the tube-feet project have become deep grooves which serve this purpose. Some Sea-Urchins hollow out dwellings for themselves in limestone rocks by means of their spines (fig. 875), and others attain the same end by burrowing in the sand (fig. 876). But as in both cases the eggs hatch into free-swim-

ming larvæ, it cannot be said that these dwellings serve as nurseries.

Ordinary Star-Fishes (Asteroidea) as a rule present another type of indirect development, in which the larval forms (*Bipinnaria* and *Brachiolaria*) are in many respects unlike the *Pluteus*. Here again we find cases of direct development associated with arrangements for care of eggs or young. A remarkable instance is afforded by the members of one family (*Pterasteridæ*), for in these the upper side of the body forms the floor of a kind of pouch in which the young pass through their development, while the roof of this space is constituted by a special membrane supported on spines, and pierced by numerous small holes and a

large central one. These apertures no doubt enable a free circulation of sea-water through the star-fish nursery to take place, a matter of considerable importance, since developing embryos require a plentiful supply of oxygen for breathing purposes. A simpler case is that of a Star-Fish (*Leptoptychaster*, fig. 877) in which the young are developed in grooves on the upper surface of their mother, on whose back they creep about after hatching out.

In most *Sea-Cucumbers* (*Holothuroidea*) the eggs hatch out into a simple kind of free-swimming larva (*Auricularia*, fig. 878), but in a few species there is direct

In such cases the young are either simply attached to the skin of the parent without any special protective arrangement, or the upper side of the body may bear (as in *Psolus ephippifer*) a number of plate-like spines with narrow stalks.

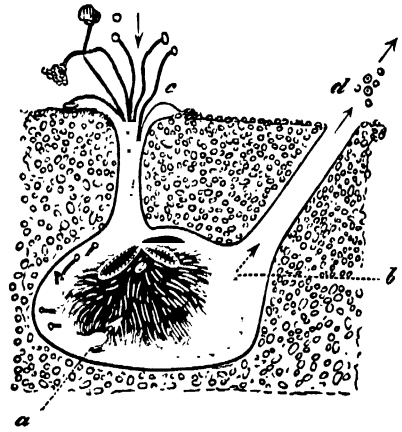

Fig. 876.—Heart-Urchin
in its Burrow

As indicated by the arrows, food is entering by passage on left (through which some tube-feet, *c*, are protruding) to mouth (*a*), and waste matters (*d*) are being discharged through passage on right from intestinal aperture (*b*): *e*, rosette of respiratory tube-feet.



Fig. 877.—Young Star-fishes (*Leptoptychaster Kerguelensis*) creeping on the Body of their Mother

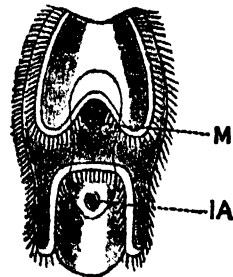

Fig. 878.—Auricularia, enlarged: M, mouth; IA, intestinal aperture.

The broad tops of these overlap, to roof in a space that serves as a brood-pouch.

LIFE-HISTORIES, &c., OF SEGMENTED WORMS
(ANNELIDA)

Special arrangements for protection of eggs or young do not exist in the majority of the marine species of *Bristle-Worms* (*Chaetopoda*), since in these, as a rule, the eggs are simply passed into the surrounding water, where their chance of developing into adults is exceedingly small. Sometimes, however, a mass of jelly-like substance is secreted in which a batch of eggs is deposited. The developing embryos are thus to some extent protected, and when they hatch out the jelly serves as their first food. Greenish masses of spawn of this nature, belonging to some of the burrowing worms, are commonly to be seen in spring on sandy shores.

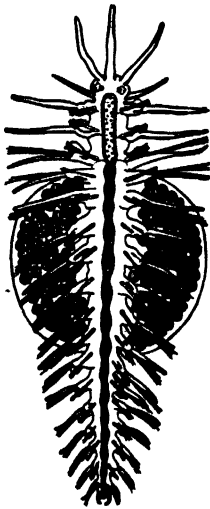

Fig. 879.—A Female Bristle-Worm (*Autolytus prolifer*) carrying Eggs in Pouch

The eggs of some Bristle-Worms are carried about attached to the body of the mother, and there may be special provisions for their shelter. The broad flat Scale-Worms (Polynoids) possess a double series of overlapping breathing-scales on the upper side of the body, and in some species the space underneath these structures is used as a brood-pouch. In one marine worm (*Autolytus prolifer*, fig. 879) the female carries her eggs about in a sort of bag attached to the under side of the body. The wall of this receptacle results from the hardening of a fluid which is secreted at the time the eggs are laid.

In this particular case development is direct, and little worms hatch out from the eggs within the pouch, which resemble the adult, except in the fact that they are very much shorter.

A large number of marine Bristle-Worms may be said to possess dwellings, since they live in tubes of their own manufacture (see vol. ii, p. 339), which vary greatly in shape in different species, and are made up of the most diverse materials. To these tubes the eggs may be attached, either to their external surface, or to their inner surface, which is naturally a safer place. There is an interesting specialization in one worm (*Spirorbis*) (fig. 880) which lives in a flat spiral calcareous tube, for the head of this creature bears a kind of stopper (*operculum*), which

is not only used to close the mouth of its dwelling, but is also hollowed out to serve as a brood-pouch.

Most marine Bristle-Worms hatch out in the larval form known as a Trochosphere, and this is also the case with *Polygordius*, a much elongated and very slender pink form, which is the largest representative of the closely-allied group of Simple Segmented Worms (Archiannelida). Being a typical case, it may well be taken to illustrate the kind of life-history which is usually found among marine Annelids.

The form of a *Polygordius* larva (fig. 881) has been compared to that which would be presented by two blunt cones placed base to base. The broader and more rounded of these is the head-lobe (*prostomium*), which is kept uppermost during swimming, although at the front end of the body. At its base is a double row of long cilia, by which locomotion is effected. The lower

and smaller cone narrows somewhat abruptly to a blunt point, which we may consider to be the tail end of the larva. On one side of the body a mouth is present which marks the under or ventral surface. It leads into a short gullet that is succeeded by a dilated stomach, and this again passes into a short intestine opening at the tail end. The ectoderm at the top of the head-lobe is thickened into a plate, which serves as a brain, and two eye-spots are embedded in it. A circlet of comparatively small cilia surrounds the body a little way below the mouth. With the internal changes that take place in the larva we are not here concerned, but it gradually becomes transformed into the adult by elongation of the tail end, and division of this region into rings or segments. It soon becomes apparent that

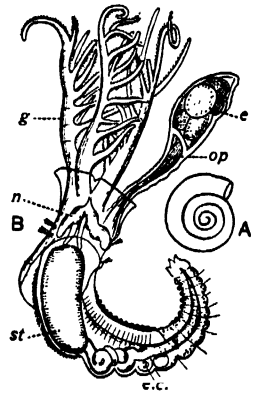

Fig. 880.—*Spirorbis*. A, Shell. B, Animal, enlarged: e.c., egg-cells within body; g, gills; n, kidney tubes (*nephridia*); op, hollow operculum with eggs (e); st, stomach.

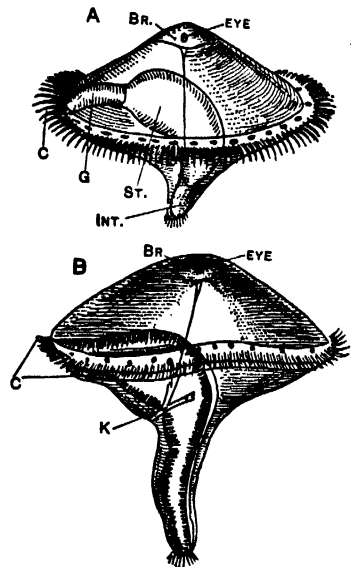

Fig. 881.—Trochospheres of *Polygordius* enlarged. A and B, Younger and older stages. BR., brain; C, ciliated band; G, gullet; ST., stomach; INT., intestine; K, larval kidney.

transformed into the adult by elongation of the tail end, and division of this region into rings or segments. It soon becomes apparent that

this segmented region is destined to form the trunk of the worm, while the head-lobe and broad region immediately below it will together form the head. The latter is at first large out of all proportion, but as it grows more slowly than the trunk this ultimately ceases to be the case. For a long time the segments increase in number, the youngest being always the one adjoining the tip of the tail, while the oldest is next to the head. Among other events which take place before the free-swimming larva is converted into the adult worm may be mentioned: the sprouting of a pair of tentacles or feelers from the head-lobe, loss of the swimming bands of cilia, and degeneration of the eye-spots.

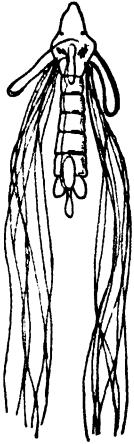

Fig. 88a.—Larva of a Bristle-Worm, with bundles of Bristles.

There are considerable differences between the trochospheres of different Annelids, especially in regard to the number of ciliated bands present, but of these the most constant is the one at the base of the head-lobe described above. In some cases the developing larvæ possess bundles of bristles, which differ greatly as to arrangement and length (fig. 882), but in all cases appear to serve the double purpose of balancing the body during swimming, and affording a certain amount of protection from enemies. They are secondary larval structures, and not retained by the adult.

In the Few-Bristled Annelids (*Oligochata*), which include earth-worms and freshwater forms, as also in Leeches (*Discophora*), development is direct, there being no larval stage in the life-history. The members of the former group lay their eggs in a case of horny consistency (cocoon) formed by the hardening of a fluid that exudes from a glandular band of skin (*clitellum*), which is conspicuous in an ordinary earth-worm, where it is placed not far from the front end of the body, and often erroneously regarded as the result of injury by a spade or other implement.

The cocoons of earth-worms (fig. 883) are deposited either on the surface of the ground, or else buried in the soil. Although a considerable number of eggs are laid in each of them, but few of these—it may be only one—develop into adult worms, the successful members (or member) of any particular brood using the rest as food. As the eggs are very small, and do not contain

much food-yolk (see p. 345), some such arrangement is necessary. It is true that a nutritive albuminous fluid is enclosed in the cocoon, but this is unfortunately not abundant enough to prevent the more vigorous embryos from becoming cannibals.

The small cocoons of freshwater worms are commonly attached to aquatic plants, in many cases near the edge of the native pond or stream. It sometimes happens that a considerable number of young worms emerge from each capsule, but this is exceptional.

The eggs of *Leeches* (*Discophora*) are usually enclosed in cocoons, which are generally deposited in damp places near the water, but not actually in it. Some species, however, do not form cocoons at all, but lay their eggs in gelatinous clumps attached to various objects under water, and the cocoons of other leeches are to be found in similar situations, *e.g.* those of the marine form *Potobdella*. We should scarcely expect to find "nursing" of young among Leeches, but this actually does take place in certain instances (species of *Glossiphonia*). Speaking of this sort of leech Beddard says (in *The Cambridge Natural History*) that it "carries its eggs upon the ventral face of the body, where the young remain for some time after they are hatched, attached by the posterior sucker to their parent's body, and from which situation of safety they make short excursions".

The life-histories of animals belonging to the huge group of Jointed-Limbed Invertebrates (Arthropoda) include so many interesting and varied types that it may be well to consider separately the different subdivisions, *i.e.* Crustaceans (Crustacea), King-Crabs (Xiphosura), Primitive Tracheates (Prototracheata), Centipedes and Millipedes (Myriapoda), Spider-like Arthropods (Arachnida), and Insects (Insecta).

Up to this point the present section has dealt with the life-histories of Lower Invertebrates, in which the comparatively simple adult stage is reached after a correspondingly simple development. And though, as we have seen, there are many

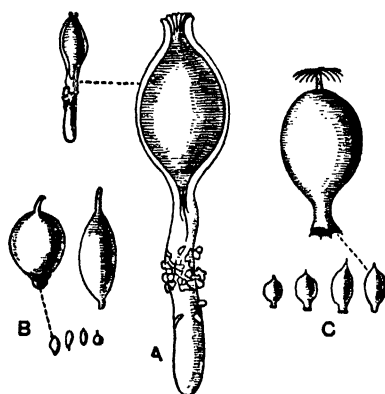

Fig. 883.—Cocoons of Earth-Worms, natural size and enlarged. A, *Lumbricus rubellus*. B, *Allurus*. C, *Allobophora foetida*.

ways by which the early stages of life are protected, extreme fecundity is the most important safeguard against the extinction of species. With Arthropods we commence the study of Higher Invertebrates, which possess an extremely complex structure, and afterwards pass on to Vertebrates, the organization of which is even more elaborate. It naturally follows that in all these higher groups the development is more or less protracted, and there is therefore a greater necessity for elaborate arrangements by which eggs and young are protected. Such arrangements have reached a high degree of perfection in many cases, though marked fecundity is also characteristic of some higher animals. If the eggs or young are well protected, so that they have a good chance of becoming adult, they are produced in comparatively small numbers. But where the survival of the species depends chiefly on fecundity, an enormous number of eggs or young may be brought into existence.

LIFE-HISTORIES, &c., OF CRUSTACEANS (CRUSTACEA)

LOWER CRUSTACEANS (ENTOMOSTRACA).—The eggs and sometimes the newly-hatched young are here for a time protected by a variety of arrangements, which give them a better start in life

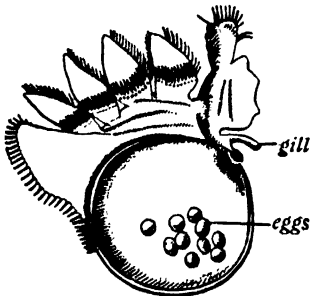

Fig. 884.—Brood-pouch of *Apus*, enlarged

than would otherwise be the case. Some of the *Leaf-Footed Crustaceans* (*Phyllo-poda*) illustrate this point very well. In *Apus*, for example, one pair of limbs are modified into brood-pouches (fig. 884) comparable in appearance to a couple of watch-glasses applied together. These shelter the eggs from the time of laying until the larvæ are hatched out. The little *Water-Flea* (*Daphnia pulex*, fig. 885), so common in fresh water, uses the

space between the upper side of the body and the enclosing shield as a brood-pouch. In this case the development is direct, there being no free-swimming larva, and the comparatively large eggs contain a good deal of yolk, which serves to nourish the embryos. The brood-pouch also contains a nutritive fluid employed for the same purpose. A lucky chance sometimes enables us to see the young *Water-Fleas* hatched out under the microscope, that is if

our observations are made in the summer. Though much smaller than their mother they resemble her in appearance, and may be seen to play around her for some time. The qualification about the time of observation is made because these little creatures produce both summer-eggs and winter-eggs, the fate of which is somewhat different. The former are thin-shelled and develop without fertilization, hatching out during the season from which they get their name. The winter-eggs are fertilized, and, being destined to tide the species over the cold part of the year, are enclosed in firm, resistant shells. By thickening of a part of the parent shell a sort of case, known as a "saddle" (*ephippium*) is formed, which is cast adrift with a couple of eggs inside it, and floats about on the surface of the water. The young Water-Fleas hatch out the following spring. The number of winter-eggs enclosed in each case depends upon the species, varying from one to several.

In *Fork-Footed Crustaceans* (*Copepoda*) the eggs, when laid, usually pass into curious little egg-bags, the material for making which is furnished by special cement-glands. A typical and easily-obtained example is furnished by *Cyclops* (fig. 886) which often abounds in ponds. The two ovoid egg-bags are carried about by the mother till the time of hatching. Some *Copepods* possess but one egg-bag, and these structures are differently shaped according to the species. The eggs of a few members of this group are sheltered in a dorsal brood-pouch, resembling that of a Water-Flea.

The most familiar examples of the group of *Barnacles* (*Cirripedia*) are the stalked Ship Barnacle (*Lepas*) and the stalkless Acorn Barnacle (*Balanus*), which is found in great numbers attached to rocks between tide-marks. In both these cases

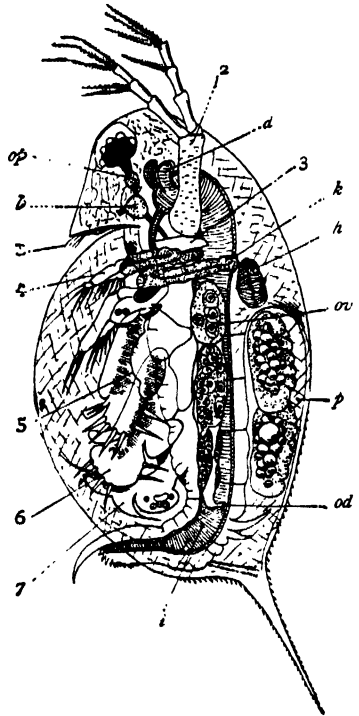

Fig. 885.—Water-Flea (*Daphnia*), with Eggs in Brood-pouch; enlarged

1-7, Appendages; *d*, digestive gland; *i*, intestine; *k*, heart; *k*, kidney; *b*, brain with larval eye (the black spot); *op*, optic ganglion and compound eye; *ov*, ovary; *od*, opening of oviduct; *p*, brood-pouch containing two developing eggs.

there is a protective armour of shelly plates, between which and the body is a considerable space that is made use of as a brood-pouch. The numerous eggs are glued, as it were, into relatively large masses, which are attached to a pair of triangular flaps.

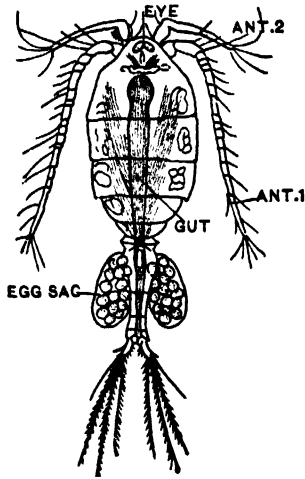

Fig. 886.—Female Cyclops with egg-bags, enlarged. ANT. 1 and ANT. 2, Antennules and antennae.

Among the little *Mussel-Shrimps* (*Ostracoda*) it appears that the eggs may either be attached singly to water-plants, as in the commonest freshwater member (*Cypris*) of the group, or else, as in many marine forms (*Cypridina*, &c.), sheltered within the bivalve shield of the mother until such time as they hatch out.

In all the above groups of Lower Crustaceans, Mussel-Shrimps and most Water-Fleas excepted, development is indirect, the young animals hatching out in the form of a Nauplius larva (fig. 887) with oval unsegmented body and large unpaired eye in the middle of the forehead. The swimming organs are three pairs of appendages, which afterwards become the small feelers (*antennules*), large feelers (*antennae*), and first jaws (*mandibles*) of the adult. Many authorities at one time thought that the Nauplius repeats in its main features the characters of the simple ancestral forms from which all Crustaceans may be imagined to have taken origin, but this view is

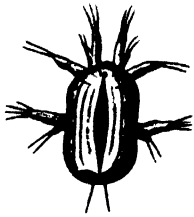

Fig. 887.—Nauplius Larva, enlarged

now practically abandoned. There can be little doubt that Crustaceans are the specialized descendants of animals resembling the recent Bristle-Worms, and an instructive comparison may be made between the Nauplius and the typical Trochosphere larva (p. 359) which is commonly an early stage in the life-history of such worms. If a Trochosphere were to lose its cilia and grow three pairs of appendages it would closely

resemble a Nauplius, and evolutionary changes of the kind are quite conceivable, for such appendages would prove more efficient locomotor organs than the cilia which they superseded, and we are justified in making the general assertion that evolution always tends towards greater efficiency, *i.e.* to an increasingly perfect

adaptation between animals and their surroundings. In this particular instance it is very interesting to find that the trunk of a crustacean develops in relation to the Nauplius in much the same way that the trunk of a worm develops with reference to the Trochosphere (see p. 359). For the hinder end of the Nauplius is a region of rapid growth and elongation, and while this is going on segment after segment comes into existence till the full number are formed. And, as in the worm, the oldest segment is next the head and the youngest next the tail.

HIGHER CRUSTACEANS (MALACOSTRACA).—In *Nebalia* and other *Mud-Shrimps* (*Leptostraca*), which are in some respects intermediate between Higher and Lower Crustaceans, the large shield which grows back from the head to partly cover the trunk affords a shelter to the eggs until the time of hatching. The development is direct, the young mud-shrimps closely resembling the adult form, except in size.

The *Sessile-Eyed Crustaceans* (*Arthrostraca*), including Sand-Hoppers and Slaters, usually incubate their eggs in a brood-pouch on the under side of the thorax, the floor of the pouch being formed by the growth of plates from the inner sides of the legs (fig. 888). There is no free-swimming larva, development being direct.

Stalk-Eyed Crustaceans (*Thoracostraca*) illustrate a number of ways by which the eggs or young are protected. The little Opossum Shrimp (*Mysis*), of which the development is direct, possesses a brood-pouch, as its name indicates. This is of similar character to the one found in Sand-Hoppers and their kindred. In Lobsters, Crayfishes, Crabs, Prawns, Shrimps, and the like, the eggs when laid are cemented to the numerous bristles with which the abdominal appendages of the mother are thickly studded. The material for this egg-glue is furnished by glands which open on the under surface of the thorax. Everyone must have noticed some creature of the kind "in berry", *i.e.* with numerous eggs firmly fixed to the lower side of the tail, in which safe position the early part of the development is gone through.

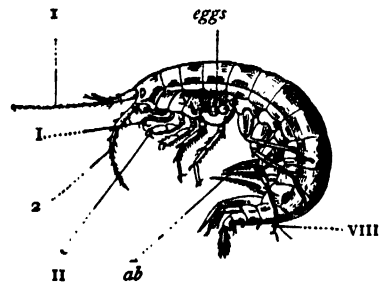

Fig. 888.—Female

I, II, and VIII, first, second, and eighth thoracic limbs; ab, first abdominal limbs.

It will have been gathered from what has already been said, that development is direct in some of the Higher Crustaceans, but the stalk-eyed forms usually hatch out as larvæ. This early free-swimming stage in the life-history is, however, but very rarely

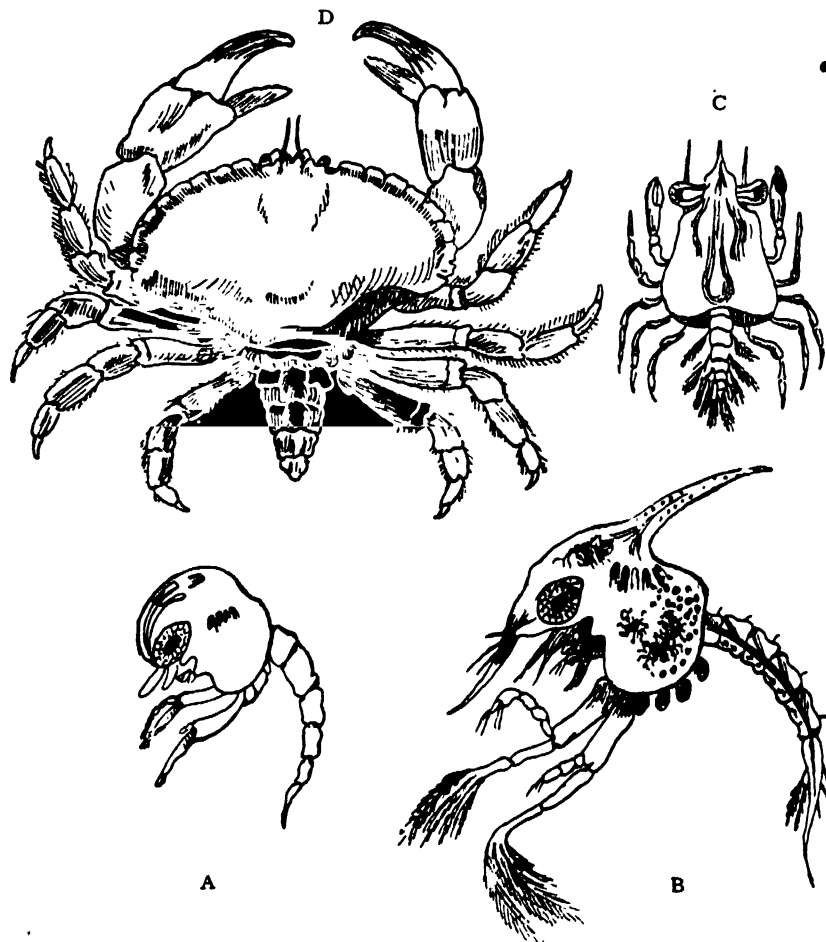

Fig. 889.—Life-history of Edible Crab (*Cancer pagurus*), enlarged. A, Young Zoæa. B, Fully formed Zoæa. C, Megalopa. D, Young Crab (during life the tail is bent up under body).

a Nauplius, the most characteristic variety of larva being the Zoæa, which is partially segmented, and otherwise of more complex nature. In the life-history of the Edible Crab (*Cancer pagurus*, fig. 889), for instance, the just-hatched Zoæa is a rather ungainly-looking little creature, with large rounded cephalothorax (*i.e.* head and thorax fused together) and slender limbless tail (A). The large appendages shown in the drawing are foot-jaws, which

here serve for swimming-organs, and in front of these will be seen the sprouting jaws and feelers. At a somewhat later stage (B) the feelers and jaws have become much larger, the locomotor foot-jaws have attained a relatively enormous size, and behind them stump-like outgrowths have made their appearance which are destined to become pincers and legs. Long spines, that serve to balance the body, are now present on the strong shield which covers the front part of the body. There can be no doubt that Crabs, the most specialized of all Crustaceans, with their broad cephalothorax and absurdly small tail, have been derived from lobster-like forms, in which there was not the same disproportion between these two regions of the body. And the Zoëa, by completion of its set of appendages, loss of its balancing spines, and comparatively slow further growth of the precociously-developed foot-jaws, passes into the Megalopa stage (C), which would certainly seem to be reminiscent of such ancestors. Swimming is now effected lobster fashion, by strokes of the tail, but this mode of progression is soon abandoned in favour of walking. The tail now develops but slowly, while the front part of the body grows vigorously, especially in breadth, and thus the proportions of the adult are at last attained (D). The little tail is represented in the figure as projecting backwards, but is in reality folded up under the front of the body. In the adult female this method of disposal largely conduces to the safety of the eggs.

Particular interest attaches to the development of the Fresh-water Crayfish (*Astacus fluviatilis*). The animal population of rivers has, for the most part, been originally derived from the sea, and this change of habitat has led to a number of special adaptations to new conditions of life. The development, for one thing, has in many cases undergone considerable modification. For marine animals the possession of a larval form presents certain advantages, e.g. it helps escape from unfavourable surroundings and promotes the dispersal of the species. But it would be positively dangerous for creatures which live in rivers to hatch out as larvæ, since these being small and weak would be liable to be swept away by the current, and would certainly perish if they reached the sea, for life in which their species have gradually become entirely unsuited. It is therefore not surprising to find that the freshwater representatives of marine

groups that usually develop indirectly have either suppressed the larval stage in their life-histories, or else made special provision for its safety. The former is what has taken place in the Crayfish, in which the large eggs hatch out into little creatures that resemble their parents in all essential particulars (fig. 890). Nor do they at once leave the mother, but for a time attach themselves to the hardened egg-glue which covers her abdominal appendages, a safe means of attachment being afforded by their pincers, the ends of which are sharply hooked, one of the few points of difference from the adult. And it is said that even when the young begin to swim about on their own account, they at

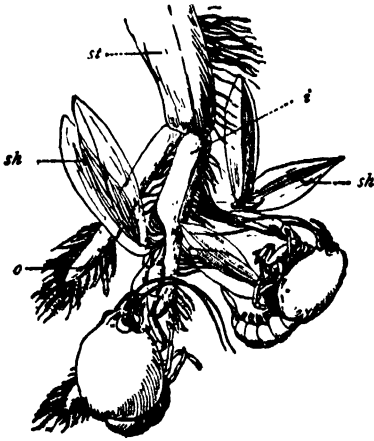

Fig. 890.—Two just-hatched Crayfishes clinging to Abdominal Appendage of their Mother, enlarged. *st*, *i*, and *o*—stalk, outer branch, and inner branch of appendage; *sh*, empty egg-shells.

first make but short excursions, from which they return to the shelter of their mother's tail.

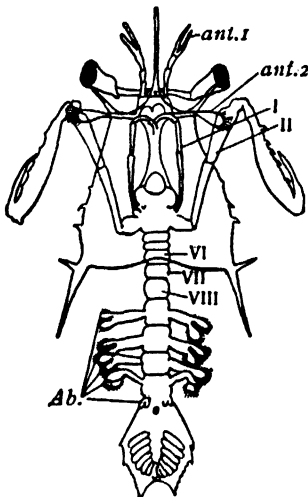

Fig. 891.—Alima Larva, enlarged. *ant. 1* and *ant. 2*, antennules and antennae; *I* and *II*, first and second pair of legs.

Crustacean Dwellings.—Omitting the cases of those forms which obtain shelter by association with other animals, as these will be dealt with elsewhere, there is little that need be said here. Many Crustaceans live more or less in rock crevices, at the openings of which they lie in wait for prey. This is the case with many Crabs, and the Rock-Lobster (*Palinurus*) is distinguished by the same habit. By turning over stones at low tide one is pretty sure to find, in this country a curious little Crab (*Porcellana platycheles*) with hairy pincers, and also species of the Sand-Hopper group. Sea-Slaters shelter in rock crevices, and their terrestrial brethren, the Wood-Lice, are commonly to be found in the crannies

of masonry and also under stones.

Some forms which burrow have already been mentioned

(p. 225), and the Mantis Shrimp (*Squilla mantis*) tunnels in banks covered with marine vegetation (*Zostera*). This creature is of special interest in the present connection, because it lays its eggs in these burrows, instead of carrying them about. The attenuated larva is known as an Alima (fig. 891).

Among Crustaceans of the Sand-Hopper kind (Amphipoda) the Caddis Shrimps (*Corophiidae*) construct tubular or ovoid nests from fragments of sea-weed or other materials. The bodies of these creatures are cylindrical, in correspondence with the shape of their dwellings, and not flattened from side to side as in ordinary Sand-Hoppers.

LIFE-HISTORY, &c., OF KING-CRABS (XIPHOSURA)

The King-Crab or Horse-shoe Crab (*Limulus*), which is the only living representative of this ancient group, lives in

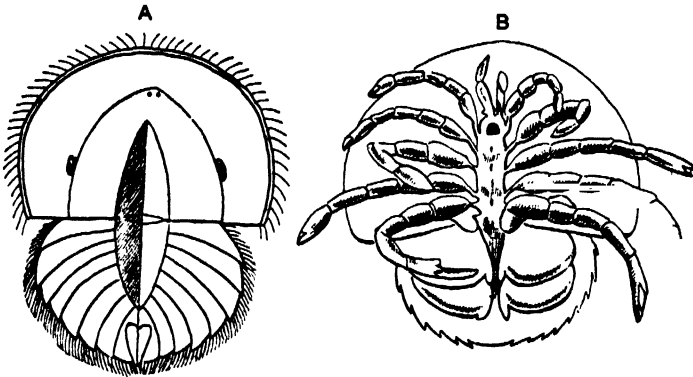

Fig. 892.—Trilobite Larva of King-Crab (*Limulus polyphemus*), enlarged

A, Upper side. B, Under side.

shallow water, and comes as near the coast as possible during spring-tides for spawning purposes. The female digs a hole for the reception of her eggs, which are afterwards covered over with mud by the movement of the water. One reason for choosing a spot near land for this purpose appears to be that incubation may be hastened by the warmth of the sun, at the times when the sea goes down. The eggs hatch out into little Trilobite larvæ (fig. 892), so called because they have a certain resemblance to the extinct animals of that name.

LIFE-HISTORIES, &c., OF PRIMITIVE TRACHEATES
(PROTOTRACHEATA)

We are here only concerned with the archaic and widely-distributed form *Peripatus*, which has already been spoken of in several connections, especially as being a sort of link between Annelids and Arthropods. It is a light-shunning creature, and though in all the numerous species the young are born alive, there is a great deal of variation in respect to the amount of food-yolk contained in the egg. This is large in amount in species which live in the Australian region, much less in those inhabiting South Africa, and practically absent in the American forms. The newly-born young have been observed crawling over the body of their mother, and as she is not entirely devoid of means of defence (see vol. ii, p. 360) this association may be regarded as a protective measure.

LIFE-HISTORIES, &c., OF CENTIPEDES AND MILLIPEDES
(MYRIAPODA)

The love of the beautiful is so marked a human characteristic that it has had a considerable influence upon the course of scientific research, though it has not swayed the professional zoologist to the same extent as the amateur naturalist. But it cannot be denied that the groups which include the more attractive-looking animals have received an undue share of attention. This is the case, for example, with Insects and Birds, while among the former Butterflies have been studied much more exhaustively than Flies or Bugs. Any investigator who desires to find a field of activity likely to quickly yield a rich harvest of results cannot do better than select a group of which the members are superficially unattractive, or, still better, downright repulsive, regarded from the lay stand-point. No animals are "common or unclean" in the light of science, and that any of them should be so regarded is one of the undesirable items of the legacy we have inherited from our prehistoric ancestors, whose stand-point was purely utilitarian. These worthy but uncultured gentlemen early discovered by painful experience that certain creatures could bite, sting, or otherwise cause annoyance, and in this we may discover the beginnings of a tendency to

FAMILY OF COMMON SQUIRRELS (*Sciurus vulgaris*)

As in Birds, parental affection has much to do with the success of Mammals in the struggle for existence. The chances of individual survival in the latter class are also furthered by development being internal (except in the egg-laying Duck-bills and Spiny Ant-eaters), and by the presence of milk-glands for the benefit of the young. In the large and widely-distributed order of Gnawing Mammals (*Rodentia*), fecundity plays a very important part in preventing extinction. The young may be born in a well-developed state, but the contrary is the case when they are brought up in some sort of dwelling or nest, as in the Common Squirrel. The "drey" of this animal is a snug habitation, built in a hole or tree-fork. Dry twigs are woven together into a rounded structure, with a hole on one side. Leaves, moss, lichen, and similar material are used for lining purposes. From three to four blind and naked young are born within this cosy dwelling, usually in June, and remain with their parents till the following spring, when they in their turn undertake family duties.

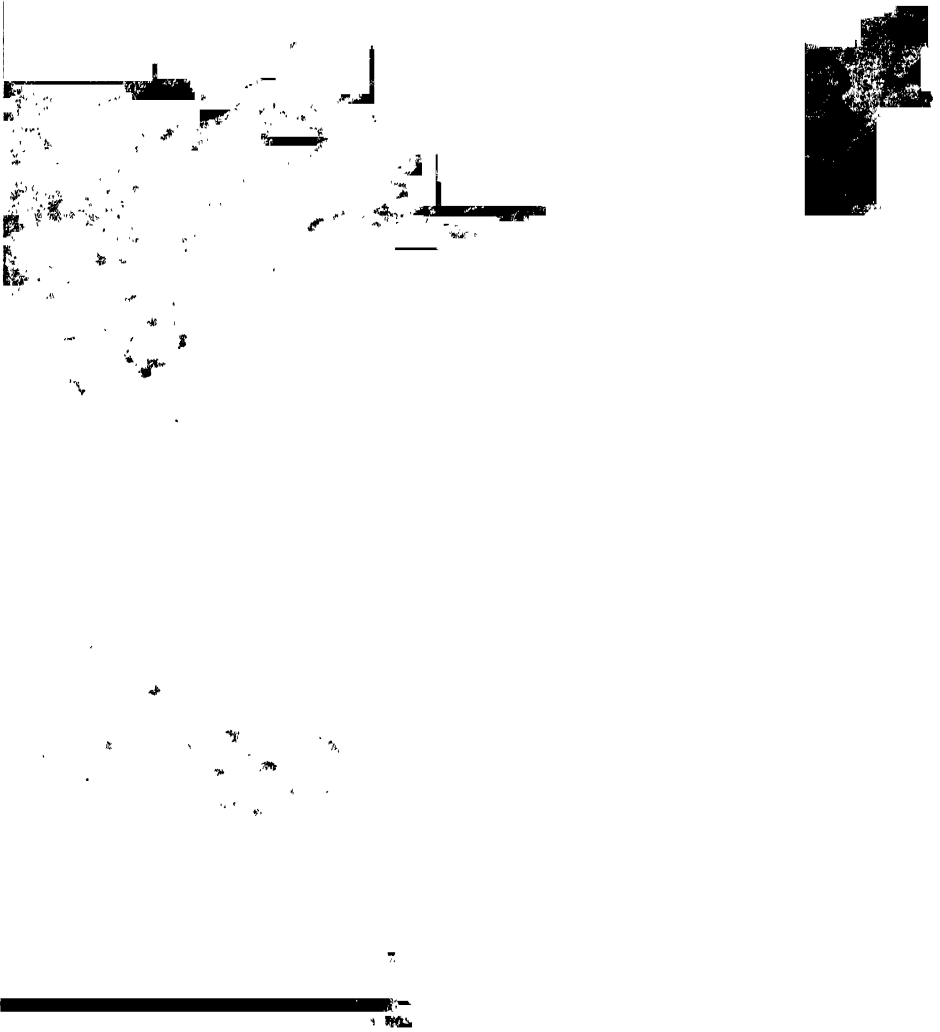

FAMILY OF COMMON SQUIRRELS (*SCIURUS VULGARIS*)

regard as "vermin" all and sundry forms even remotely resembling those actually known to be objectionable.

Centipedes and Millipedes have fallen under this ban, and as a result our knowledge of them is comparatively scanty, and mainly due to a few enterprising investigators. The structure of these creatures is of very great interest, throwing light as it does upon the origin of Insects, and that the habits deserve investigation may be judged from the following accounts which Sinclair gives (in *The Cambridge Natural History*) of two well-known British species, the Thirty-Foot (*Lithobius forficatus*), one of our commonest Centipedes (see vol. i, p. 394), and the Earth Snake-Millipede (*Julus terrestris*), which is even more abundant.

Sinclair speaks as follows of the Thirty-Foot:—"The female *Lithobius* is furnished with two small movable hooks at the end of the under surface of the body close to the opening of the oviduct. These small hooks have been observed by many naturalists, but their use has, so far as I know, never been described before. They play an important part in the proceedings following the laying of the egg. The time of breeding in *Lithobius* . . . begins about June and continues till August. There are first of all some convulsive movements of the last segments of the body, and then in about ten minutes the egg appears at the entrance of the oviduct. The egg is a small sphere (about the size of a number-five shot) rather larger than that of *Julus*, and is covered with a sticky slime secreted by the large glands inside the body, usually called the accessory glands. When the egg falls out it is received by the little hooks, and is firmly clasped by them. This is the critical moment in the existence of the *Lithobius* into which the egg is destined to develop. If a male *Lithobius* sees the egg he makes a rush at the female, seizes the egg, and at once devours it. All the subsequent proceedings of the female seem to be directed to the frustration of this act of cannibalism. As soon as the egg is firmly clasped in the little hooks she rushes off to a convenient place away from the male, and uses her hooks to roll the egg round and round until it is completely covered by earth, which sticks to it owing to the viscous material with which it is coated; she also employs her hind-legs, which have glands on the thighs, to effect her purpose. When the operation is com-

plete the egg resembles a small round ball of mud, and is indistinguishable from the surrounding soil. It is thus safe from the voracious appetite of the male, and she leaves it to its fate. The number of eggs is small when compared with the number laid by *Julus*."

The comparatively large size of these eggs, and their relatively small number, are correlated with direct development; for here, as in Centipedes generally, the just-hatched young closely resemble their parents except in size.

Sinclair's observations on the Earth Snake-Millipede are thus set forth:—" *Julus terrestris* is one of the most common of the English Millipedes, and can be easily obtained. I kept them in large, shallow glass vessels with a layer of earth at the bottom, and thus was able easily to watch the whole process. They breed in the months of May, June, and July. The female *Julus* when about to lay her eggs sets to work to form a kind of nest or receptacle for her eggs. She burrows down into the earth, and at some distance below the surface begins the work. She moistens small bits of earth with the sticky fluid secreted by her salivary glands, which become extraordinarily active in the spring. She works up these bits of earth with her jaws and front-legs till they are of a convenient size and shape, and places them together. When complete the nest is shaped like a hollow sphere, the inside being smooth and even, while the outside is rough and shows the shape of the small knobs of earth of which it is composed. She leaves a small opening in the top. The size of the whole nest is about that of a small nut. When she is ready to lay her eggs she passes them through the hole in the top, and usually lays about 60 to 100 eggs at a time. The eggs, which are very small, are coated with a glutinous fluid which causes them to adhere together. When they are all laid she closes up the aperture with a piece of earth moistened with her saliva; and having thus hermetically sealed the nest, she leaves the whole to its fate. The eggs hatch in about twelve days."

Numerous small eggs are associated in this and other Millipedes with indirect development. The young hatch out as short six-legged larvæ, which undergo a series of moults, increasing in length and number of legs each time, until the adult characters are fully acquired. It is stated that in one common

Continental species of Millipede (*Polyzonium Germanicum*) the female, after laying her eggs, coils her body round them and remains on guard till they hatch.

Sinclair's fascinating observations have been quoted in full in order that amateur naturalists may see the kind of result to which patient investigation may be expected to lead. And if any such are moved to turn their attention to this rather neglected group of animals, they will very likely be able, with a little patience, to make interesting additions to our present somewhat meagre knowledge as regards the habits of creatures of the kind.

LIFE-HISTORIES, &c., OF SPIDER-LIKE ANIMALS (ARACHNIDA)

Most of the animals belonging to this class are oviparous, and there is no metamorphosis, the just-hatched young differing from the adult mainly in respect of size.

Scorpions (*Scorpionidæ*) are distinguished from other Arachnids by being viviparous. The larger species commonly dig large holes in the ground to serve as habitations, while others lurk under stones, beneath the bark of trees, or in any convenient cranny.

The *Spiders* (*Araneidæ*) are of much greater interest in the present connection, and it has been suggested that their spinning powers were originally evolved in reference to the construction of investments for the eggs. However that may be, the eggs are laid in a little web, and a sort of bag is then spun round them. In those species where there is no fixed habitation the female often carries the egg-bag about with her, and defends it if attacked. This is the case, for example, in the *Wolf-Spiders* (*Lycosidæ*), in which the egg-bags are attached to the spinnerets on the under side of the body. Staveley (in *British Spiders*) thus speaks of these forms:—"The *Lycosæ*, or Wolf-Spiders, lead an entirely vagabond life, constructing no snares, and carrying their eggs, and afterwards their young, about their bodies. . . . The female *Lycosæ* will fight boldly for the protection of her cocoon, and it is said that if deprived of it she will conceal herself and die. She hatches two broods in the year, in spring and autumn, and has been known to hatch three. The eggs

are not adherent to each other in the cocoon, which is constructed in a remarkable manner. The two halves of the silken case are strong and compact in texture, and at their suture is a band of much slighter substance. This gives way sufficiently to allow of the growth of the young after their escape from the egg and before they are disengaged each from its membranous envelope, and, in due time, it is at this weakest part that the young escape. Amongst snare-making spiders, the young commence weaving immediately after leaving the egg; but the young *Lycosæ*, requiring no snares, and being incapable of protecting themselves, remain for about a fortnight with the mother, giving rise formerly to a belief that they derived their nourishment from her body."

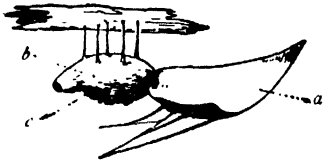

Fig. 893. —Nest of House-Spider (*Tegenaria domestica*). a, Part of web; b, nest with front-door to right and back-door to left; c, sand-grains which keep the nest steady.

The webs which snare-making Spiders construct are, as it were, an extension of a kind of tubular dwelling placed in their immediate neighbourhood. This may be seen in the cobwebs made by the *House-Spiders* (species of *Tegenaria*, fig. 893), where this home is placed in a sheltered corner, and has

both a front-door opening on the web, and also a back-door which serves as a kind of emergency exit. The dense white horizontal webs of the *Hedge-Spiders* (species of *Agalena*) are associated with a similar provision. At the back a vertical tube hangs down, through which the spider retreats when alarmed. Connected with this tube are one or more dwelling-chambers, and in these the egg-bags, one or two in number, are deposited during August.

The domestic arrangements of one pretty little native species (*Theridium nervosum*) are described by Staveley (in *British Spiders*) as follows:—"This beautiful little spider, and her as beautiful snare and nest, are to be easily found in almost any kind of bush or shrub in June or July. The snare is . . . a very light mass of threads crossing each other in every direction, and altogether forming a pyramidal figure, or rather that of a long cottage roof. The nest is a perfect little tent, which is sometimes suspended by itself in the middle of the snare, and sometimes is sheltered under a growing leaf, which has been fastened by silken cords into a dome-like form to serve as roof. The tent is lined with

white silk, and is covered with small dead leaves or flowers, or the stamens of larger flowers, or with anything which has presented itself, and is decorated with the wings and other parts of insects, as the wigwam of an Indian with scalps and other war-trophies. It is remarkable how often, where the insect is not uncommon, the beautiful wing-cases of the green nut-weevil are found among these ornaments. Within this tent is the little round green silk cocoon containing the eggs, and the mother is almost always to be found in an inverted position embracing this



Fig. 894.—Water-Spiders (*Argyroneta aquatica*) and Nests

treasure, and hiding it with her body, which it about equals in size. When the young are hatched, they live with their mother in this tent until they are able to make their own living."

The remarkable Water-Spider (*Argyroneta aquatica*, fig. 894) constructs below the surface a neat nest shaped like a diving-bell, and skilfully moored to some aquatic plant. Within this the cocoon is deposited. In such a spider the air used for breathing purposes is entangled in the downy covering of the abdomen, and, under water, shines like quicksilver. But this has nothing to do with the air-supply of the nest, which is provided for in a somewhat singular manner. We should naturally expect the walls of this elegant structure to be first woven, and air to be afterwards introduced, but this does not appear to be the case. The spider commences operations by protruding the tip of her

tail out of the water, spreading her spinnerets, and entangling a small air-bubble between them. Diving down, she carries the bubble to the stem selected as the site of the dwelling, and leaves it clinging there. By successive additions the mass of air becomes large enough for her purpose, and a web is then spun over it to constitute the lining of the nest. Over this



Fig. 895 — Trap-door Spiders (*Ctenizæ cæmentaria*) and Nests

liquid silk is smeared, which soon hardens into an impervious membrane. Mooring lines complete the structure. The spider is, of course, able to introduce fresh air when necessary.

The *Trap-door Spiders* (*Ctenizidæ*, fig. 895) construct homes in many cases by digging a cylindrical hole in the ground, smoothing its interior, and adding a silken lining. A neat lid is then constructed of a mixture of earth and silk. It is smooth on its under side, but rough externally, so as to exactly match its surroundings, and is provided with a silken hinge. In some

cases a refuge chamber branches out of the nest, from which it is separated by another neatly-made door, and it may also have a direct communication with the exterior of similar kind.

LIFE-HISTORIES, &c., OF INSECTS (INSECTA)

• Many well-known insects, *e.g.* Bees, Butterflies, and Beetles, are striking illustrations of *indirect* development. They hatch out from the eggs as *larvæ*, which are exceedingly unlike the adult form, and pass later on into a quiescent *pupa* stage, from which the perfect insect or *imago* finally emerges. In such cases we may speak of a *complete metamorphosis*. There are also numerous instances where, as in Earwigs and Cockroaches, the just-hatched young differ far less from their parents, the character of which they gradually assume without, as a rule, passing through a quiescent stage. It is then convenient to speak of *nymphs*, not of *larvæ*, and the metamorphosis is said to be *partial*. And there are also some insects which begin life in a form which differs so little from the adult that the use of the term metamorphosis is hardly justifiable.

The time which elapses before an insect's egg hatches out varies greatly in different cases, and so does that consumed in the life-history taken as a whole. Hatching may take place on the day of laying, as in some Flies, or eggs deposited in late summer may remain dormant until the following spring, as in some Moths. The most remarkable case of a protracted life-history is afforded by the Seventeen-year Cicada (*Cicada septendecim*), which exists as a larva for the period indicated by its name (see vol. ii, p. 217).

A.—INSECTS WITH PARTIAL METAMORPHOSIS

PRIMITIVE WINGLESS INSECTS (APTERA).—Little is known as to the life-history of the Tassel-tails and Spring-tails which constitute this order, but many of them, though not all, closely resemble the adult stage at the time of hatching. More observations are badly needed, and might easily be made, for these little creatures are abundant almost everywhere.

STRAIGHT-WINGED INSECTS (ORTHOPTERA).—The appearance of the different stages in the life-history of the Common Earwig

(*Forficula auricularia*) will be gathered from fig. 896. The just-hatched nymph differs from the adult in the absence of wings, and in other particulars. But it quickly increases in size, and

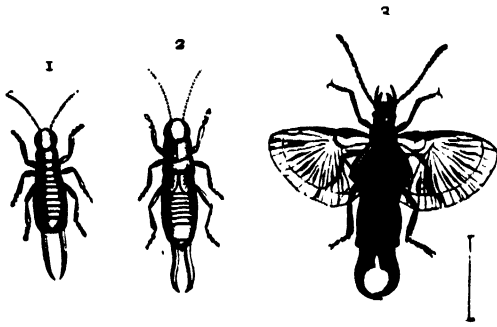

Fig. 896.—Life-history of Earwig (*Forficula auricularia*)

2, Nymphs. 3, Adult.

develops the parts which are lacking, these changes being associated, as in insects generally, with a series of moults or castings of the skin.

It is said that the female Earwig, after laying her eggs, collects them into a heap, over which she broods till the time of hatching. Beyond this

maternal affection does not appear to go.

The eggs of the too familiar Cockroach (*Periplaneta orientalis*) are enclosed in a protective horny capsule, which the mother carries about with her for some time, ultimately leaving it in some safe corner. It is stated that she sometimes helps the young nymphs to make their way out of their tough investment. At this time there is about the same difference between them and the adult as in the case of Earwigs. They are, of course, much smaller.

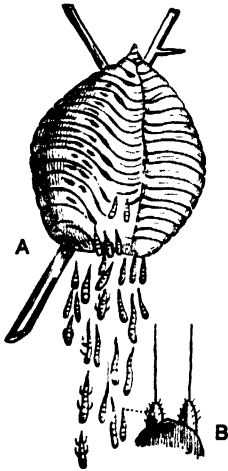

Fig. 897.—Praying Mantis. A, Young escaping from egg-capsule. B, Posterior end of a moulting mantis showing

The *Soothsayers* or *Praying Insects* (*Mantidæ*) construct curious chambered egg-capsules, which are attached to plants or stones. In one species at least, the young, after making their way to the exterior, remain hanging to the capsule for some days by means of threads attached to their tails (fig. 897). They then undergo a moult, and lead an active existence for the rest of their lives.

Extraordinary circumstances attend the egg-laying of the curious *Stick-* and *Leaf-Insects* (*Phasmidæ*), which resemble in shape the objects after which they are named. Each egg is enclosed in a strong sculptured case, which makes it look very much like a seed, and this perhaps increases its chance of

escaping the notice of certain predaceous Ichneumon-Flies which lay their own eggs within those of other insects. But it is known that this ingenious device is not always successful. Sharp (in *The Cambridge Natural History*) makes the following remark about one species:—"These eggs are not deposited in any careful way, but are discharged at random, simply dropping from the female; the noise caused by the dropping of the eggs of *Diapheromera femorata* from the trees on which the insects are feeding to the ground is said to resemble the pattering of rain-drops. The eggs of this species often remain till the second year before they hatch."

The eggs of *Locusts* and *Grasshoppers* (*Acridiidae*) are usually deposited in the ground, a hole being excavated for the purpose. The tip of the abdomen in the female is provided with some hard-tipped rods which serve as spades for doing this work. A number of eggs are laid in the hole (fig. 898), and with them is discharged a sort of

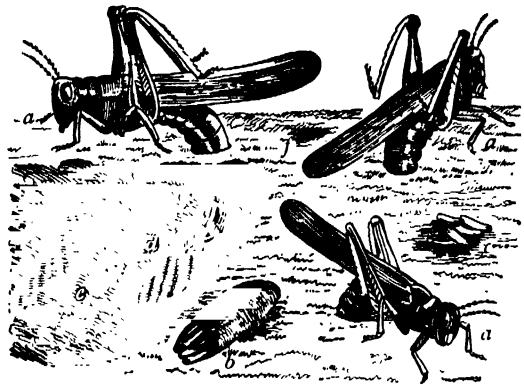

Fig. 898.—Red-legged Locust (*Melanoplus femur-rubrum*)

a, a, a, Females laying their eggs; *b*, egg-case opened; *c*, eggs; *d*, hole in the ground being filled with eggs; *e*, hole filled with eggs and closed above.

fluid, which subsequently hardens to form a protective case. All these devices are very necessary, as the eggs furnish much-appreciated articles of diet to a number of predaceous insects and other animals.

In *Green Grasshoppers* (*Locustidae*), which are distinguished from the members of the preceding family by the great length of their feelers, the female possesses a long protrusible egg-laying tube or ovipositor, which is used for digging a shelter for the eggs, and afterwards directing them into it. The ground is usually selected for this purpose (fig. 899), but in some cases small twigs are chosen.

The *Crickets* (*Gryllidae*) usually possess ovipositors, which are used for the same purpose as those of the Green Grasshoppers. The burrowing Mole-Cricket (*Gryllotalpa campestris*) is an exception to the rule, for in it all the digging is done by

means of the specialized fore-legs (see vol. iii, p. 222). The excavations made in the interests of the young include an incubating chamber, and also a "nursery", in which the newly-hatched progeny can disport themselves (fig. 900). Our knowledge of these domestic details begins with old Gilbert White, who says (in *the Natural History of Selborne*):—" . . . A gardener at a house where I was on a visit, happening to be mowing, on the 6th of May, by the side of a canal, his scythe struck too deep, pared off a large piece of turf, and laid open to view a curious scene of domestic economy. There were many caverns and

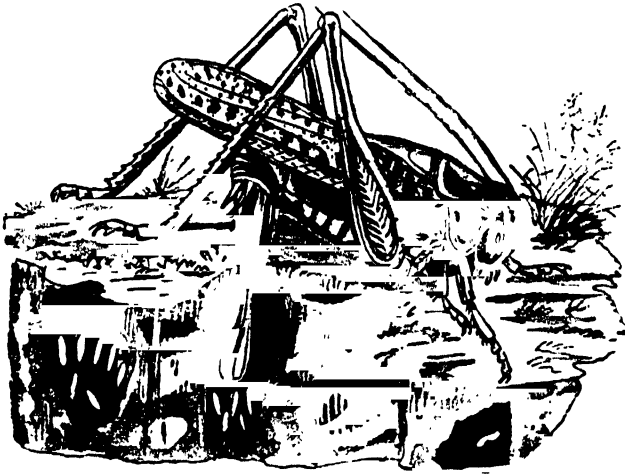

Fig. 899.—A Green Grasshopper (*Decticus verrucivorus*), laying her Eggs. Note the large ovipositor

winding passages leading to a kind of chamber, neatly smoothed and rounded, and about the size of a moderate snuff-box. Within this secret nursery were deposited near a hundred eggs of a dirty yellow colour, but too lately excluded to contain any rudiments of young, being full of a viscous substance. The eggs lay but shallow, and within the influence of the sun, just under a little heap of fresh-moved mould like that which is raised by ants."

BUGS (HEMIPTERA).—The members of this order emerge from the egg in a form which is usually not very dissimilar from the adult, though there is a good deal of variation in this matter. In *Tree-Bugs (Cicadidæ)*, for instance, there is a considerable difference. Some account has already been given of the life-history of one of the most remarkable members of the family, the Seventeen-year Cicada (*Cicada septendecim*), which remains

in the immature condition for an extraordinary length of time (see p. 225). These insects possess a strong ovipositor, and in this case it is used to bore a hole in a twig within which the eggs are laid.

In most of the *Scale-Insects* (*Coccidæ*) the wingless females are covered by a sort of shield (fig. 901), formed by the hardening of a fluid which exudes from the body, and in the construction of which the cast skins of the insect are also worked up. The shape and texture of these "scales" varies greatly according to the species. In most cases the female remains in the same spot, with her sharp beak driven into the plant on which she lives, for the purpose of sucking its juices. She lays numerous eggs, often dying and shrivelling up immediately afterwards, and these hatch out under the shelter of her body.

The nymphs which emerge lead an active life for a time, but ultimately fix themselves by means of their beaks. Those which become females assume the adult shape by a series of gradual changes, but the males pass through a quiescent pupal stage, ultimately becoming, at least in some cases, active insects in which the forewings are present, while the hind-wings are reduced to vestiges, and the mouth-parts entirely absent.

Aphides or *Plant-Lice* (*Aphidæ*, fig. 902), often known as "green fly", are minute insects of astonishing fertility, in which the life-history is complex. During the warm part of the year, when food is abundant, there is a continuous succession of

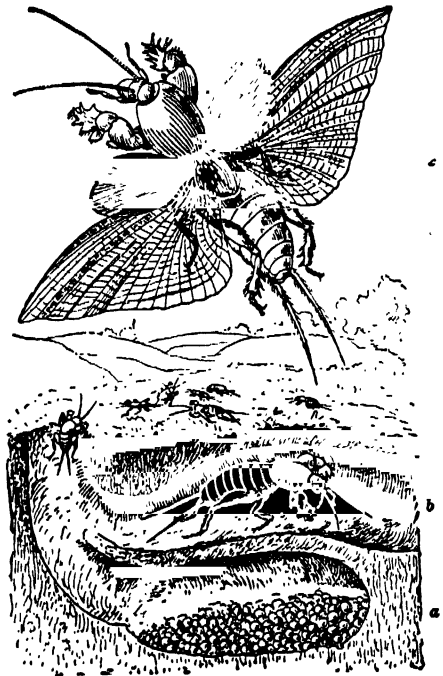

Fig. 900.—Home of Mole-Cricket (*Gryllotalpa*), in vertical section. *a*, Eggs in incubating chamber; *b*, young Cricket in "nursery"; *c*, adult.

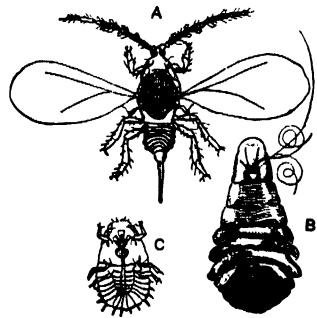

Fig. 901.—Apple Scale-Insect (*Mytilaspis pomorum*), enlarged. *A*, Male. *B*, Female. *C*, Nymph.

generations of females, some wingless, others possessing wings, which bring forth their young alive, *i.e.* are viviparous. These are all produced from unfertilized eggs. But on the approach of winter egg-laying or oviparous females come into existence, and also a certain proportion of males: in either sex wings may be present or absent. Fertilized eggs are now laid, which hatch out into viviparous females the following spring. We have here another example of the phenomenon of "alternation of generations", already illustrated by some of the Cœlenterates (see p. 349). But there is a great difference between the two cases. For in Cœlenterates vegetative propagation and egg-production alternate in the life-cycle (*metagenesis*), while in

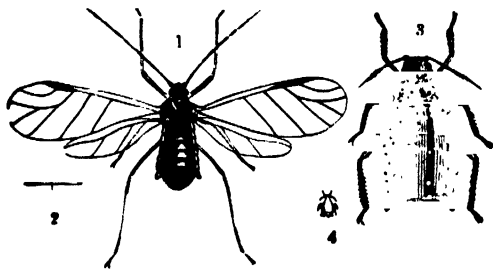

Fig. 902.—Turnip-Flower Aphid (*Aphis florivapa*). 1, 2, Winged female; 3, 4, wingless female. 2 and 4 indicate the natural size.

Aphides there is alternation between two kinds of egg, *i.e.* unfertilized eggs which develop internally, and fertilized eggs which develop externally. A life-cycle of this kind is technically described as a case of *heterogeny*. If we denote the

stage producing unfertilized eggs by E_1 , and that producing fertilized eggs by E_2 , the formula $E_1 E_1 E_1 E_1$, &c. &c., E_2 will represent the life-history, a large number of viviparous generations (E_1) succeeding one another before the single oviparous generation (E_2) is reached.

Some of the aquatic bugs carry about their eggs with them until the time of hatching. This has been observed for one of the very few marine forms (*Halobates*), and has also been described for certain freshwater species (*e.g.* *Diplonychus*). In the latter case the eggs are sometimes, if not always, cemented to the back of the male.

Particular interest attaches to the eggs laid by the members of one family of freshwater Bugs (*Nepidae*, fig. 903). In a Water-Scorpion (*Nepa*) the egg is provided with a tuft of threads at one end, and is deposited in the stem of a water-plant, the threads alone projecting. It has been suggested that they are of use in conducting air to the developing embryo, for they are of spongy nature, and continuous with a layer of the same

character situated just within the egg-shell. But this requires confirmation.

The eggs of some of the slender water-bugs (species of *Ranatra*) are of elongated shape, with a couple of sharply-bent threads at one end. The female insect stands on a floating leaf

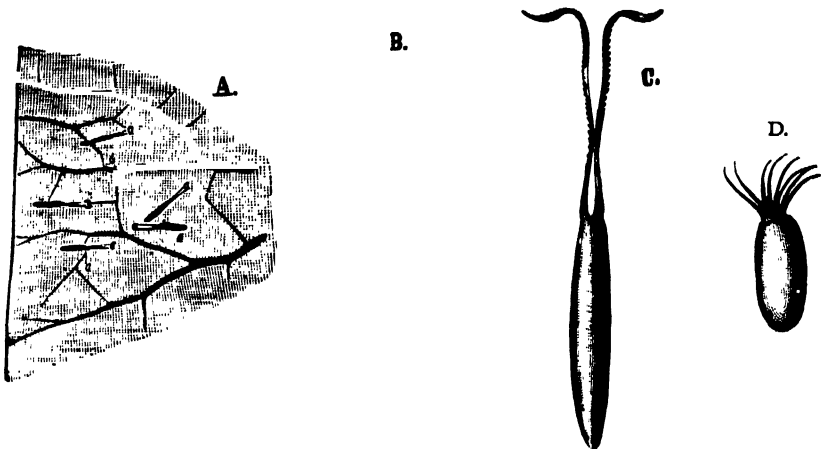

Fig. 903.—Eggs of Water-Bugs

A, Under side of bit of floating leaf, with attached eggs of *Ranatra*. B, Single egg of same with small piece of leaf, $\times 4$. C, Isolated egg of same, $\times 8$. D, Egg of *Nepa cinerea*, $\times 7$.

and makes a small hole through which the egg is passed, when the threads catch at the side of the hole, acting as a suspensory arrangement. The leaf is thus converted into a nursery, and large numbers of these eggs may sometimes be found hanging down from its under side.

B. INSECTS WITH COMPLETE METAMORPHOSIS

NET-WINGED INSECTS (NEUROPTERA).—Of the purely terrestrial forms belonging to this order, the *Termites* or *White Ants* (*Termitidae*), which live together in complex communities, are undoubtedly the most interesting, but these will be dealt with further on, under the heading ASSOCIATION OF ANIMALS.

Many Net-Winged Insects spend the early part of their existence in ponds or streams, and some of their adaptations to an aquatic life have already received attention (see vol. ii, p. 463). We may take the *Dragon-Flies* (*Odonata*, fig. 904) as a typical example. The eggs are laid either in water or upon aquatic plants, a number of them being usually imbedded in a jelly-like



Fig 004.—Life-history of a Dragon-Fly (*Libellula depressa*). A, Perfect insect. B, Young Dragon-Fly emerging from nymph. C, C, Young nymphs. D, Full-grown nymph about to leave the water.

mass. They hatch out into flattened unattractive-looking nymphs, which lead a predaceous aquatic existence for some time, gradually

increasing in size, and developing some of the adult characteristics. The fully-formed nymph ultimately creeps up the stem of some plant till it is out of the water, and then remains motionless. The



Fig 905.—Caddis-Moth (*Phryganea striata*) and its Larva

skin of the back now splits, and the perfect insect makes its way out of the enclosing skin, its wings being at first flabby and shrivelled. They soon expand and assume their proper form, and the dragon-fly then takes wing, commencing a life in the air which is quite as predaceous as the life which its nymph led in the water. The amount of metamorphosis is not nearly so considerable as in some of the other insects to be described, and, as a matter of fact, the order of Net-winged Insects includes so many different kinds of life-history, that it really comes under the last heading as well as under this. But it is thought best to keep them together, so as to prevent confusion.

Caddis-Flies (*Phryganeidae*) are net-winged insects which pass through a complete metamorphosis, hatching out as larvæ, which construct cases for themselves (see vol. ii, p. 337), and as "caddis-worms" are well-known inhabitants of fresh water. After a time the larva passes into a motionless pupa

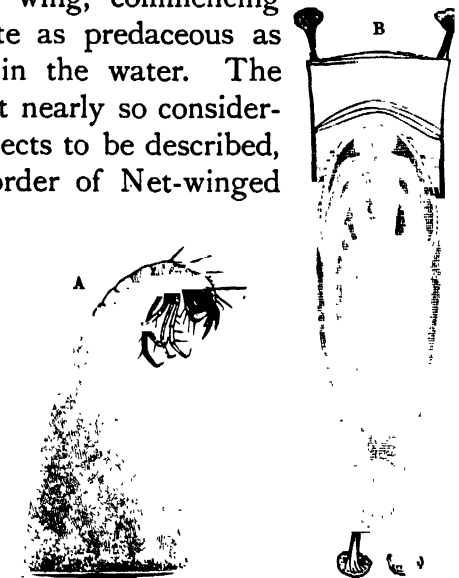

Fig. 906.—Larva and Pupa of a Caddis-Moth (*Oxyethira costalis*). A, Larva and its case, $\times 17$. B, Pupa in its investment, with four anchoring pads, $\times 16$.

stage, from which the moth-like perfect insect or imago ultimately emerges. The larva and imago of a species of Caddis-Fly are represented in fig. 905, the former having been removed from the water and placed on the bank. It is obvious that it would not do for the imago to come out of the pupa under water, and

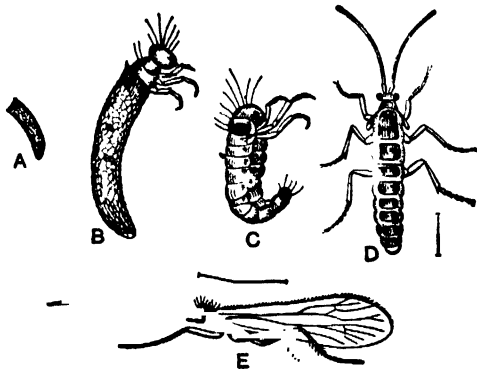
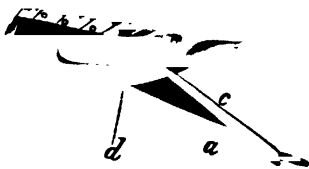

Fig. 907.—Land-Caddis (*Ecnoclyla pusilla*). A, Case of larva. B and C, Larva in its case, and removed from same, enlarged. D, Adult female. E, Adult male. The actual size of D and E is indicated by lines.

there is an interesting adaptation to meet this exigency. The larva, before passing into the motionless stage, closes its case by spinning silken screens, which do not prevent the passage of water, or it may employ bits of stick or stone for the purpose. In some species (fig. 906, B) the case is previously anchored to a floating leaf. It then becomes a pupa, which in general shape is much like

the adult, and possesses a relatively enormous pair of jaws (mandibles). When fully formed it becomes active, bites its way out of the case, and swims on its back till some body is encountered up which it can climb out of the water. This transit to the outer air effected, the skin splits and the imago wriggles out, much as in the case of dragon-flies.

In rare instances the caddis-worms do not live in the water at all. The larvæ and adults of one such species (*Ecnoclyla pusilla*), in which the early part of life is spent in damp moss or among rotting leaves, is represented in fig. 907.



c, d, its sheath,

MEMBRANE-WINGED INSECTS (HYMENOPTERA).—Complete metamorphosis is characteristic of this order, as familiarly

exemplified by the social Ants, Bees, and Wasps, whose complex communal life will receive our attention in a later section. A few simpler cases will suffice to illustrate the nature of the life-history.

The female of the Large Wood-Borer or Wood-Wasp (*Sirex gigas*, fig. 908) possesses a strong ovipositor, by means of which

she bores holes in the trunks of sickly fir-trees, and lays her eggs therein. The structure of this organ is complex, but may be understood by reference to figs. 908 and 909. It consists of two protective pieces, which can be brought together so as to ensheath the part by which the boring is effected. This is made up of three rods, one of which is relatively broad, and provided below with a pair of ridges, on which two boring spines can slide up and down. Each of these is studded with saw-like teeth near its tip. The larva is a pale grub-like creature practically devoid of limbs, though three pairs of little projections near the front end of the body correspond to the legs of the adult. It feeds on the wood of the tree, biting out long galleries, and is said to remain in the larval state for as much as two years. When full grown it travels towards the surface of the trunk or branch, and becomes a pupa, as which it may remain for a long time. The imago, after emerging from the pupal skin, gnaws its way to the exterior. Fabre states that in an allied species (*Sirex augur*) the galleries of the larva are longitudinal, and that it becomes a pupa in one of



Fig. 909.—Cross-section through Ovipositor and Sheath of Wood-Wasp (*Sirex* greatly enlarged. *ab* and *a'b'*, sheath; *e* and *e'*, boring spines, which slide on the ridges of a directing piece *cd*).

these, making no attempt to come near the surface before doing so. When the imago makes its appearance it does not try to get to the open air by travelling along the gallery in which it finds itself, but bores a transverse passage that takes it direct to the exterior. This is only one of many instances in which animals possess a sense of direction far more highly developed than our own somewhat imperfectly developed locality sense. There are possibly special sense organs related to this important faculty, which is here of vital importance, as without it many of the adult insects would never get out of the tree at all.

The Corn Saw-Fly (*Cephus pygmaeus*, fig. 910) passes through a life-history presenting similar stages to those described for the Wood-Wasp. Among cultivated plants wheat and rye are the special objects of its attentions. In such plants the stem or haulm is marked by a series of swollen solid nodes or "knots", from which the leaves grow out, and between which are long hollow internodes. The female Saw-Fly lays about a dozen eggs, de-

positing each of them in the lowest internode of a distinct plant. This takes place in early summer, and the larva spends the rest of this season in gradually working its way up the stem, biting

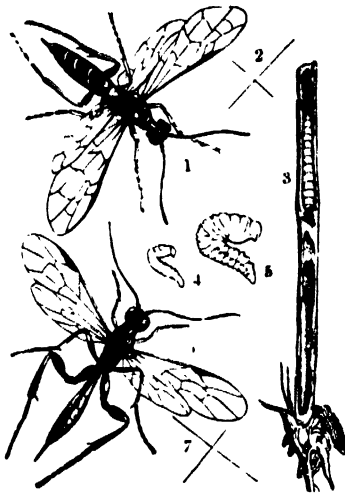

Fig. 910.—Corn Saw-Fly (*Cephus pygmaeus*)

1, Adult female (2 indicates actual size); 3, larva within a haulm of rye; 4 and 5, the same, natural size and enlarged; 6, an Ichneumon-Fly which lays its eggs within the Saw-Fly larvæ (7 indicates actual size).

through the knots as they are encountered. It then travels down again, and is fully grown by the time it gets near the ground. Now follows the most remarkable event, for the larva partly bites through the stem all the way round, about an inch from its base, the object unconsciously obtained being that later on it may be easily broken off by the wind, thus leaving a free means of exit for the fully-formed insect. This accomplished, the larva descends to the neighbourhood of the root and weaves a transparent silken cocoon, in which it remains dormant till the following May, when it becomes a pupa, the perfect insect making its appearance soon afterwards.

The numerous species belonging to the Saw-Flies Proper (*Tenthredinidæ*) are familiar pests, in which the female possesses an ovipositor constructed on much the same principle as that of the Wood-Wasp (see p. 387), but the two saws are elaborate curved plates, with teeth on their edges and sharp ridges on the outer side (fig. 911), the latter having a rasping function.

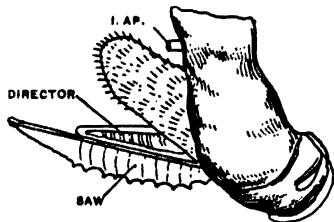

Fig. 911.—Side-view of Ovipositor of Rose Saw-Fly (*Hylotoma rosæ*), much enlarged. I. AP., intestinal aperture.

When in use they are used alternately, sliding on their supporting pieces. Sharp remarks on these insects as follows (in *The Cambridge Natural History*):—

“In the case of some species the Common Saw-Fly (*Hylotoma rosæ*) of our rose-bushes, for instance, there is no

difficulty in observing the operation; indeed, old Réaumur, when speaking of the placid disposition of the Saw-Flies, suggests that it was given them so that we may easily observe their charming operations. We cannot but regret that in these days we are unable to take so complacent a view of the arrangements of nature.

There is much variety in the details of the structure of these saws, so much, indeed, that it is possible to identify most of the species by means of the saw alone." The course of the life-history of a typical species, the Turnip Saw-Fly (*Athalia spinarum*, fig. 912), is as follows. The females lay their eggs during May in the edges of turnip leaves, or those of allied plants, cutting little slits for their reception. From 200 to 300 are deposited by a single turnip-fly. The egg increases in size after being laid, and the larva which hatches out in a few days closely resembles the caterpillar of a butterfly or moth, in the possession of three pairs of jointed legs in front, corresponding to the legs of the perfect insect, and sucker-bearing pro-legs behind these. But the head is rounder and the pro-legs more numerous than in a true caterpillar. The young larva is pale in colour, but with increasing size becomes first green and later on blackish. The full-grown larva creeps down to the ground and enters the earth, where it spins a silken cocoon, to which particles of soil adhere externally. Within this shelter it passes into the pupa stage, and the imago comes out about the end of July. Under favourable conditions a second brood makes its appearance the same year, and in this case the larva remains as such within its cocoon during the winter, completing the stages in its life-history the following May.



Fig. 912.—Turnip Saw-Fly (*Athalia spinarum*). 1, Adult female, enlarged (natural size indicated to left of it); 2, 3, eggs, enlarged and natural size; 4, 5, 6, larvæ; 7, cocoon; 8, pupa in cocoon.

Within this shelter it passes into the pupa stage, and the imago comes out about the end of July. Under favourable conditions a second brood makes its appearance the same year, and in this case the larva remains as such within its cocoon during the winter, completing the stages in its life-history the following May.

Sharp (in *The Cambridge Natural History*) gives the following intensely interesting account of another kind of Saw-Fly:—“Although many kinds of Insects display the greatest solicitude and ingenuity in providing proper receptacles for their eggs, and in storing food for the young that will be produced, there are extremely few that display any further interest in their descendants; probably, indeed, the majority of Insects die before the eggs are hatched, one generation never seeing the individuals of another. It is therefore interesting to find that a fairly well authenticated case of maternal attachment, such as we have

previously alluded to as occurring in Earwigs, has been recorded in *Perga lewisii*, an Australian Saw-Fly. . . . The mother, having deposited about eight eggs on the leaf of a eucalyptus, remains with them until they hatch, after which she sits over her brood with outstretched legs, and with admirable perseverance protects them, so far as she is able, from the attacks of parasites and other enemies; she quite refuses to be driven away from her charges.

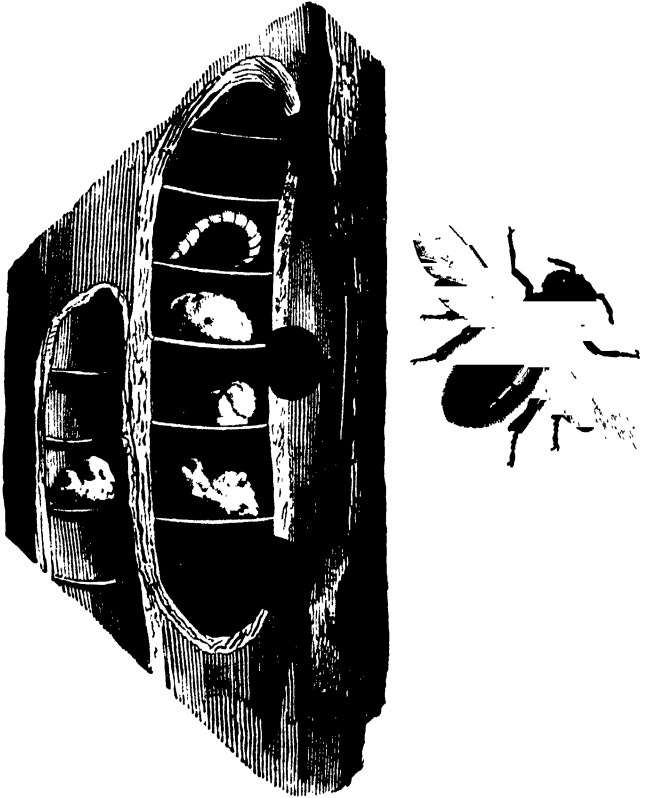

Fig. 913.—Carpenter Bee (*Xylocopa violacea*) and Nest

Mr. Lewis, to whom we are indebted for this account, states that the Saw-Fly does not recognize her own special brood, but will give equal attention to another brood if she be transferred thereto; and he adds that many of the batches of larvæ were destitute of any maternal guardian."

The large purplish insect known as the Carpenter Bee (*Xylocopa violacea*, fig. 913), a European species which does not range into Britain, gnaws into dead wood, and excavates three or four parallel passages, which may be as much as a foot in length.

These are divided into a series of cells by partitions consisting of saw-dust stuck together with saliva, and each cell contains an egg, together with a supply of honey and pollen. The larva, as in bees generally, is a limbless grub, and after using up the food-supply allotted to it, becomes a pupa. The adult insect, after coming out of the pupa, bites through the saw-dust partitions which confine it, and makes its way to the exterior.

The Leaf-cutting Bees (species of *Megachile*) are widely distributed forms, which either excavate holes for their nests, or else use existing hollows for the purpose. These are then lined with pieces of leaf, bitten out for the purpose, and stuck together by a special secretion. Each cell is covered by a circular lid, composed of a number of pieces skilfully cemented together. Several cells are placed end to end, each containing an egg with a supply of food, much as in the Carpenter Bee. The Poppy Bee (*Osmia* or *Anthocopa papaveris*), a rare native form, lines its cells with the scarlet petals of the common poppy. Regarding the habits of this species, Shuckard (in *British Bees*) makes the following remarks:—"The habits of these bees . . . are to excavate vertical cylinders in hard down-trodden pathways and roads, by the sides of fields where corn is grown, and where consequently the common red poppy is abundant. From the petals of the flowers of this plant they cut out semicircular pieces, precisely as is done by *Megachile* with the more rigid leaves of shrubs and trees, and convey them home and line their nests with them, just as is practised by that genus with those leaves—with this difference merely, that a sufficient portion of the upper edge of the pieces of the petals used is left projecting, for the purpose of forming a covercle to the nidus, and which, when filled with provender and the egg deposited, is refolded over it and covered in, and it is closed up with earth. They then proceed to make another excavation, which is treated in the same manner, for they deposit only one larva in a tube. I would urge our collecting entomologists, especially those who have the opportunity of hunting up the west of England, to use due diligence and strive to confirm the native existence of this bee, and add specimens to the cabinets of their fellow-entomologists."

We now come to a number of Solitary Wasps and Wasp-like Insects which provide for their young by placing in the nest a store of caterpillars or other creatures, which they have previously

disabled or killed by stinging. Of *Solitary Wasps* (*Eumenidæ*) we possess reliable information gained by the observations of Fabre. In one species (*Odynerus reniformis*, fig. 914) the nest is a little burrow at the end of which the egg is hung up by a thread. The female wasp next hunts for a small kind of caterpillar which rolls itself up when attacked, and, selecting an individual of suitable dimensions, packs it in the burrow near the egg, probably stinging it first to produce paralysis. A series of twenty or more caterpillars is thus packed away, the members of which are destined to be eaten in regular succession. The just-

hatched larva remains hanging by its thread to devour the first (and weakest) caterpillar, and then descends into the little space at the end of the burrow, after which it polishes off the remaining victims, one after the other. It is suggested that in this and other instances the members of the living larder do not suffer any pain, being stupefied by the stinging process, but this is by no means certain.

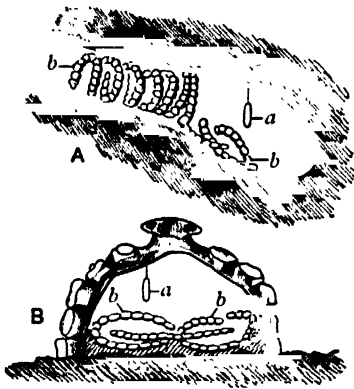

Fig. 914.—Nests of Solitary Wasps, in section

ed egg of Wasp: *b*, caterpillars
! for the larvæ. A, Subterranean
B, Dome-shaped

Fabre describes Solitary Wasps (species of *Eumenes*, fig. 914) of even greater interest, in which the female makes a little dome-shaped nest of mud and tiny stones, from the roof of which

the egg is suspended as before, while a wriggling mass of stupefied caterpillars occupies the lower part. The minute larva is at first able to feed without quitting the egg-shell, and later on this splits into a spiral strip which, by augmenting the length of the thread, enables the occupant of the cell to get at the diminishing store of victims, so that it can make a further series of meals without running the risk of being squeezed or bitten to death. Ultimately the larva grows sufficiently big and strong to descend among its victims with safety, and this happens just at the time when it can no longer reach the diminishing heap of food from its thread.

The exceedingly numerous and widely distributed insects known as Solitary Digging-Wasps (*Fossores*), and which strictly speaking are not wasps at all, provide for the well-being of their young in a similar manner to that described for the last two cases.

Their nesting habits vary largely according to the species, from cases where no nest at all is formed, to others where burrows, or borings, or earthen cells are made for the purpose. There is an equal amount of variation in the nature of the victims selected. These not only include caterpillars, but also cockroaches, beetles, beetle-grubs, ants, flies, aphides, and spiders. The habits of these interesting forms will be reserved for treatment under the heading of Instinct and Intelligence, but the following general remarks of Sharp (in *The Cambridge Natural History*) are well worth quoting here:—"The habits are carnivorous; the structures formed are not for the benefit of the makers, but are constructed and stored with food for the next generation. Their remarkable habits attracted some attention even 2000 years or more ago, and were to some extent observed by Aristotle. The great variety in the habits of the species, the extreme industry, skill, and self-denial they display in carrying out their voluntary labours, renders them one of the most instructive groups of the animal kingdom. There are no social or gregarious forms, they are true individualists, and their lives and instinct offer many subjects for reflection. Unlike the social Insects they can learn nothing whatever from either example or precept. The skill of each individual is prompted by no imitation. The life is short, the later stages of the individual life are totally different from the earlier: the individuals of one generation only in rare cases see even the commencement of the life of the next; the progeny, for the benefit of which they labour with unsurpassable skill and industry, being unknown to them. Were such a solicitude displayed by ourselves we should connect it with a high sense of duty, and poets and moralists would vie in its laudation. But having dubbed ourselves the higher animals, we ascribe the eagerness of the Solitary Wasp to impulse or instinct, and we exterminate their numerous species from the face of the earth for ever, without even seeking to make a prior acquaintance with them. Meanwhile our economists and moralists devote their volumes to admiration of the progress of the civilization that effects this destruction and tolerates this negligence."

BETLES (COLEOPTERA).—Although this is the most dominant order of insects, and represented by the largest number of species, our knowledge of the habits of these is comparatively scanty, though at the same time sufficiently numerous observations have been made to render selection of illustrative cases difficult.

The stages in the life-history may be illustrated by reference to the Long-horned Oak-Beetle (*Cerambyx heros*, fig. 915), an insect of considerable size. The larva is a yellowish grub, which is practically limbless, though it possesses three pairs of little stumps corresponding to the legs of the adult. It lives in the wood of an old oak, which it tunnels in all directions, and passes into the pupa stage after three or four years. As in most beetles, the pupa is soft, and the outgrowths which are to form the append-

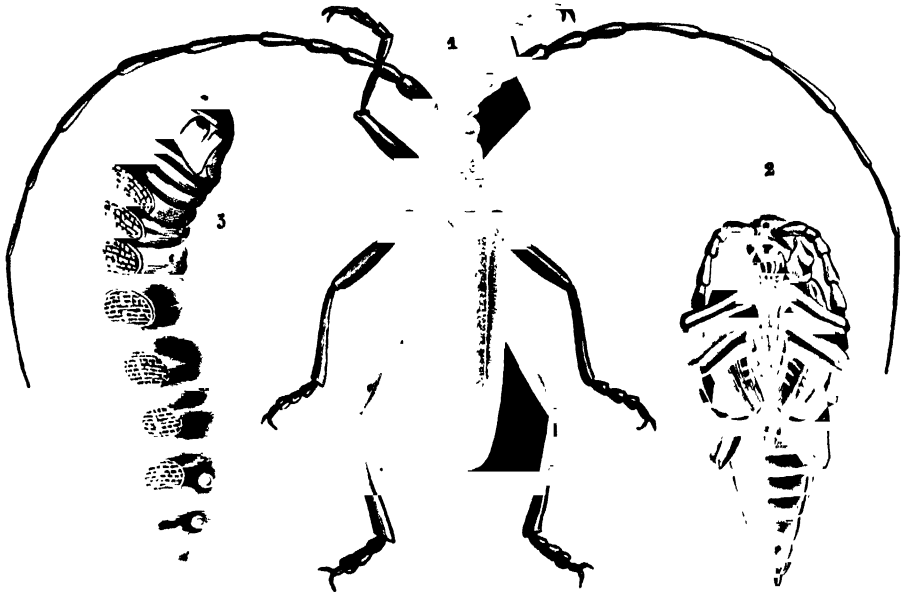

Fig. 915.—Long-horned Oak-Beetle (*Cerambyx heros*). 1, Adult; 2, pupa; 3, larva.

ages of the adult project freely at the exterior. After a short period of rest the skin splits and the imago comes out.

As a rule Beetles do not provide for the welfare of their eggs to anything like the extent which distinguishes the Net-winged Insects, but some of them display considerable solicitude in this direction. An illustration has already been given in the case of the Sacred Scarab (see vol. ii, p. 210). The little leaf-rolling Birch-Weevil (*Rhynchites betulae*) constructs a receptacle for its eggs in a most ingenious manner (fig. 916), displaying an enormous amount of energy. Sharp (in *The Cambridge Natural History*) gives the following account of the operation:—"If young birches, or birch bushes from 5 to 10 feet in height, be looked at in the summer, one may often notice that some of the leaves are

rolled so as to form, each one, a little funnel. . . . An inspection of one of these funnels will show that it is very carefully constructed. The whole of a leaf is not used in the formation of a funnel, cuts being made across the leaf in suitable directions. The beetle, standing on a leaf, as shown in the figure, proceeds to cut with its mandibles an incision shaped like an erect S, commencing at a certain part of the circumference, and ending at the midrib of the leaf; the beetle then goes to the other side of the midrib, and continues its incision so as to form another S-like curve considerably different from the first, being prostrate and less abrupt.

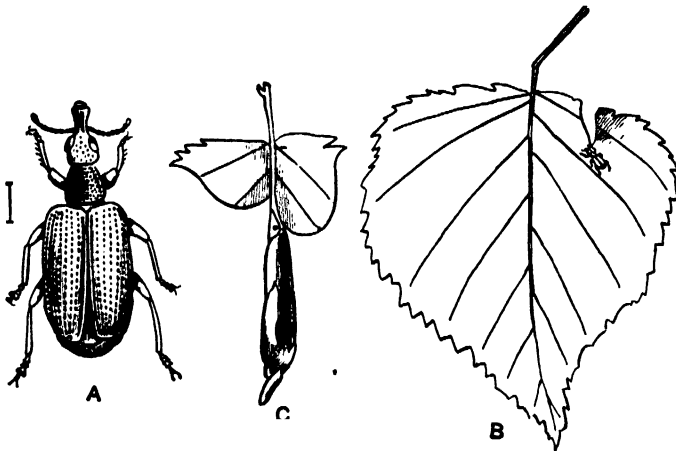

Fig. 916.—Birch-Weevil (*Rhynchites betulae*). A, Adult Weevil (actual size indicated by line to left). B, Weevil constructing egg-case. C, Completed egg-case.

Thus the blade of the leaf is divided into two halves by certain curved incisions, the midrib remaining intact. The little funnel-twister now commences to roll up the leaf to form the funnel; and this part of the work is greatly facilitated by the shape of the incisions. Going back to the spot where it commenced work, by the aid of its legs it rolls one side of the leaf round an ideal axis, somewhat on the same plan as that adopted by a grocer in forming a paper-funnel for sugar. The incisions are found to be just of the right shape to make the overlaps in the rolling, and to retain them rolled up with the least tendency to spring back. After some other operations destined to facilitate subsequent parts of its task, the beetle enters the rolled-up part of the leaf and brings it more perfectly together; it again comes out, and, pursuing a different system, holds on with the legs of one side of the body to the roll, and with the other legs drags to it the portion of the leaf

on the other side of the midrib, so as to wrap this part (*i.e.* the result of its second incision) round the part of the funnel already constructed. This being done, the insect again enters the funnel, bites three or four small cavities on the inside of the leafy wall, and deposits an egg in each. Afterwards it emerges and fits the overlaps together in a more perfect manner, so as to somewhat contract the funnel and make it firmer; then, proceeding to the tip, this is operated on by another series of engineering processes and made to close the orifice; this part of the operation being analogous to the closing by the grocer of his paper-funnel after the sugar has been put in. The operation of the beetle is, however, much more complex, for it actually makes a sort of second small funnel of the tip of the leaf, bends this in, and retains it by tucking in some little projections. The work, which has probably lasted about an hour, being now completed, the creature takes a longer or shorter rest before commencing another funnel. We have given only a sketch of the chief points of the work, omitting reference to smaller artifices of the craft-master; but we may remark that the curved incisions made by the beetle have been examined by mathematicians and dully extolled as being conducted on highly satisfactory mathematical principles." Perhaps the most extraordinary part of the whole thing is that we do not know the purpose of this elaborate arrangement, and closely related species get on quite well by simply laying their eggs in various parts of plants. Here is a good instance of a fascinating problem lying at our very doors, and probably to be solved by ordinary intelligence coupled with unlimited patience.

The grubs of *Burying-* or *Sexton-Beetle* (species of *Necrophorus*, fig. 917) feed on carrion, and the adults bury the corpses of small animals for the delectation of their progeny. The following amusing account of the obsequies of a bird as conducted by these creatures is given by Edward Newman (in *Introduction to the History of Insects*):—"The Sexton-Beetles hunt in couples, male and female; and where six or eight are found in a large animal, they are almost sure to be males and females in equal numbers; they hunt by scent only, the chase being mostly performed when no other sense would be very available, *viz.* in the night. When they have found a bird, great comfort is expressed by the male, who wheels round and round above it, like a vulture over the putrefying carcass of

some giant of the forest—the female settles on it at once, without this testimonial of satisfaction; the male at last settles also, and a savoury and ample meal is made before the great work is begun. After the beetles have appeased the calls of hunger, the bird is abandoned for a while; they both leave it to explore the earth in the neighbourhood, and ascertain whether there is a place suitable for interment; if on a ploughed field there is no difficulty, but if on grass, or among stones, much labour



Fig. 917.—Sexton-Beetles (*Necrophorus*) burying a small Animal.

is required to draw it to a more suitable place. The operation of burying is performed almost entirely by the male beetle, the female mostly hiding herself in the body of the bird about to be buried, or sitting quietly upon it and allowing herself to be buried with it. The male begins by digging a furrow all round the bird at the distance of about half an inch, turning the earth outside. His head is the only tool used in this operation; it is held sloping outwards, and is exceedingly powerful. After the first furrow is completed another is made within it, and the earth is thrown into the first furrow; then a third furrow is made, and this is completely under the bird, so that the beetle, whilst working at it, is out of sight. Now the operation can only

be traced by the heaving of the earth, which soon forms a little rampart round the bird. As the earth is moved from beneath, and the surrounding rampart increases in height, the bird sinks. After incessant labour for about three hours the beetle emerges, crawls upon the bird, and takes a survey of his work. If the female is on the bird she is driven away by the male, who does not choose to be intruded on during the important business. The male beetle then remains for about an hour perfectly still, and does not stir hand or foot; he then dismounts, dives again into the grave, and pulls the bird down by the

feathers for half an hour: its own weight appears to sink it but very little. At last, after two or three hours' more labour, the beetle comes up, again gets on the bird, and again takes a survey, and then drops down as though dead, or fallen suddenly fast asleep. When sufficiently rested he rouses himself, treads

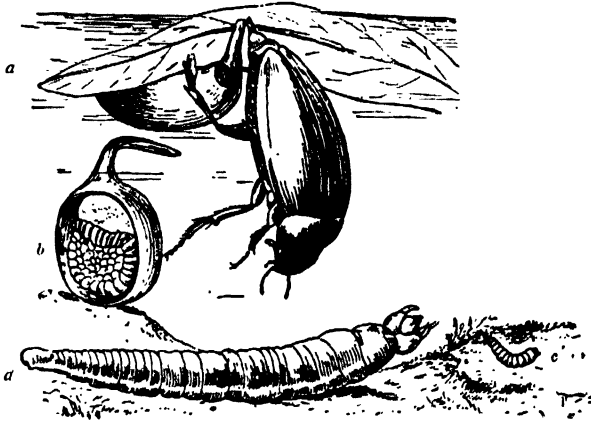

Fig. 918.—Great Black Water-Beetle (*Hydrophilus piceus*). *a*, Adult female, and cocoon attached to leaf; *b*, cocoon opened to show the eggs; *c*, young larva; *d*, full-grown larva.

the bird firmly into its grave, pulls it by the feathers this way and that way, and, having settled it to his mind, begins to shovel in the earth. This is done in a very short time by means of his broad head. He goes behind a rampart of earth and pushes it into the grave with amazing strength and dexterity, the head being bent directly downward at first, and then the nose elevated with a kind of jerk which sends the earth forwards. After the grave is thus filled up the earth is trodden in, and undergoes another keen scrutiny all round, the bird being completely hidden; the beetle then makes a hole in the loose earth, and having buried the bird and his own bride, next buries himself. The female having laid her eggs in the carcass of the bird, in number proportioned to its size, and the pair having eaten as much of the savoury viand as they please, they make their way out and fly away."

Among freshwater forms the Great Black Water-Beetle (*Hydrophilus piceus*) is interesting in regard to its egg-laying arrangements. The hinder part of its body is provided with spinning glands, by the aid of which it constructs a pear-shaped silken case, within which the eggs are deposited, and which is attached to the leaf of a water-plant (fig. 918).

• *Scale-winged Insects (Lepidoptera)*.—The Butterflies and Moths which make up this order are often so attractive in appearance that there has never been a lack of naturalists willing to study them, and a vast amount of information has been collected regarding their structure and habits. The sequence of egg, caterpillar, pupa or chrysalis, and imago, is familiar to everybody.

The large White or Cabbage Butterfly (*Pieris brassicae*, fig. 919) furnishes a common and instructive illustration. The female lays clusters of bright yellow eggs on the under side of the leaves of cabbages, turnips, and allied plants. The external surface of the egg is sculptured in a characteristic



Fig. 919.—Cabbage Butterfly (*Pieris brassicae*). 1, Adult female; 2, eggs; 3, caterpillar; 4, chrysalis.

manner. The caterpillars are gregarious, and when fully grown are bluish-green above and yellow below, with a yellow streak down the middle of the back, a series of large black spots along either side, and a sprinkling of black dots over the body. These colours make the larvæ conspicuous objects, especially as a number are associated together, and they are regarded as an illustration of warning coloration (see vol. ii, p. 301). After attaining its full size the caterpillar attaches itself by the tail to some firm object, spins a silken girdle for the front part of its body, casts its skin, and passes into the chrysalis stage. The observations and experiments of Poulton and others have shown that the colour harmonizes with the surroundings, varying from green to almost black, and this is interpreted as variable protective coloration (see vol. ii, p. 289). There may be several broods during the

warmer part of the year, and the last set of chrysalides remain in a dormant state throughout the winter, the butterflies emerging the following spring.

The eggs of Lepidoptera vary greatly in shape, external markings, and colour, some of them being amongst the most beautiful objects commonly included in cabinets of microscopic slides. They are laid upon an appropriate food-plant, which is by no means the least astonishing fact in the natural history of insects, when we remember that the habits of larva and adult are totally different, the former feeding greedily on leaves or other vegetable matter by means of its powerful jaws, while the latter, if it feeds at all, is usually limited to the sipping of nectar through its suctorial proboscis. It sometimes happens that more elaborate provisions are made for the welfare of the eggs. In some of the *Eggers* or *Lappet-Moths* (*Lasiocampidæ*), for instance, the female covers them with fur taken from her own body.

When we come to consider caterpillars and chrysalides, we are at once encountered with a bewildering variety of adaptations to all sorts of conditions, to which it is impossible to do justice in small space. Among the most interesting are the protective devices found among Stick Caterpillars and others, which have been briefly dealt with in a preceding section (see vol. ii, pp. 287, 293, 297, 307, 313, 359, 374). The caterpillars of one family of small Moths (*Psychidæ*) are reminiscent of caddis-worms, for they construct protective cases of various shape, usually from earth or bits of plants. They are usually known as "basket-worms" on this account. In some instances the case is shaped exactly like a snail-shell, and made of closely-woven silk. The change into a pupa takes place inside the larval dwelling, and the female moth never quits it. Her eggs are laid and hatched out therein, and it is suspected that the young larvæ begin life by devouring their mother, but at present they are entitled to the benefit of the doubt.

In one great family of Butterflies (*Nymphalidæ*), including, among other forms, our native Fritillaries, Tortoiseshells, the Red Admiral, the Painted Lady, and the Peacock Butterfly, the chrysalis is hung up by the tip of its tail, which is provided with sharply curved hooks for that purpose. The caterpillars of a large number of species construct cocoons of various nature before they pass into the helpless chrysalis stage. The pupæ

of the Silver-Y Moth (*Plusia gamma*, fig. 920), for instance, are to be found on the under sides of leaves, enclosed in a loose web of silk. The much denser cocoons of the Silkworm Moth (*Bombyx mori*) and other species are familiar as the source of commercial silk. Many caterpillars descend to the ground before they become chrysalides, an obviously protective habit. We may take as an example of this the Heart-and-Dart Moth (*Agrotis exclamationis*, fig. 921), a common agricultural pest in this country, in which the protective investment is supplemented by an earthen case.

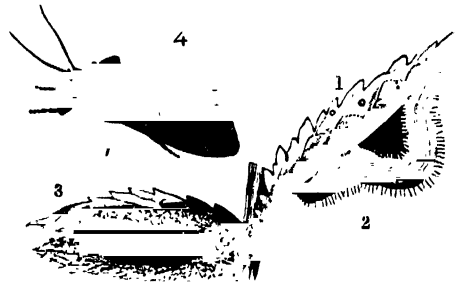

Fig. 920—Silver-Y Moth (*Plusia gamma*)

1, Eggs; 2, caterpillar; 3, chrysalis in cocoon; 4, adult female.

The caterpillar of another British species (*Brephos notha*) belonging to the same family of Owlet-Moths (*Noctuidæ*) adopts quite a different method. During its larval life it lives upon the aspen, the leaves of which it sticks together to form a shelter. When fully grown it bites out a snug receptacle in bark or wood wherein to become a chrysalis, previously spinning one or more partitions of silk across the entrance to its hiding-place. In this way prying enemies are to some extent kept off, while ventilation is at the same time not interfered with unduly.

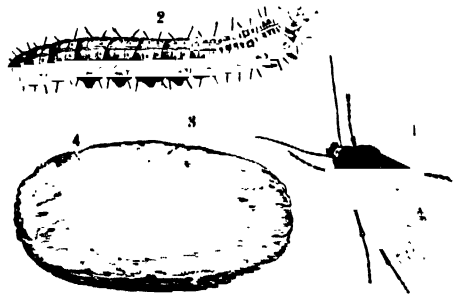

Fig. 921.—Heart-and-Dart Moth (*Agrotis exclamationis*). 1, Adult female; 2, caterpillar; 3, earthen case (cut open) enclosing chrysalis in cocoon (4).

The caterpillars of certain South American Moths (species of *Palustra*) inhabit fresh water, swimming about by alternately coiling and straightening their bodies. In most, but not all, species they construct their cocoons under water, and a number of these are found associated together. The larva of the Puss-Moth (*Cerura vinula*) makes a particularly firm cocoon, leaving, however, a thin place in front of its head, through which the imago later on forces its way. The exit is assisted by the ejection of a fluid containing caustic potash, which softens the barrier between the

insect and liberty, and a piece of the chrysalis skin is used as a head-shield as a protection against the corrosive action of the

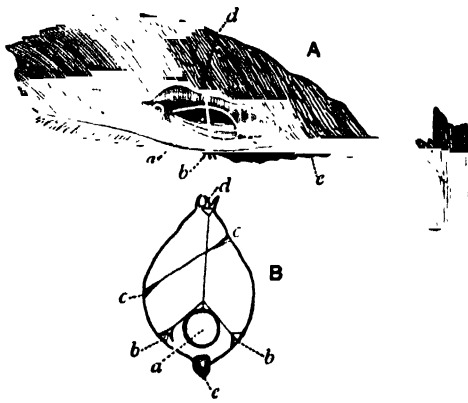

Fig. 922.—Indian Skipper Butterfly (*Badamia exclamationis*)

A, Chrysalis suspended in folded leaf, half of which has been removed. B, Diagrammatic section through same. a, Chrysalis; b, b, d, suspensory threads; c c, cross-thread holding leaf together; e, midrib of leaf.

liquid. In Burnet-Moths (*Zygænidæ*) the chrysalis is enclosed in a tapering, hammock-shaped cocoon, attached to a vertical stem. It is brownish in colour, with a shining surface. The chrysalis partly forces its way through the cocoon before the moth emerges. The caterpillar of an Indian Skipper Butterfly (*Badamia exclamationis*, fig. 922) makes very ingenious arrangements the safety of the chrysalis, by fixing the edges of a leaf

together, and constructing suspensory threads.

Two-winged Flies (Diptera).—The Flies of this order undergo a more profound metamorphosis than any other insects, and as some of them lay their eggs in all sorts of animal food, most

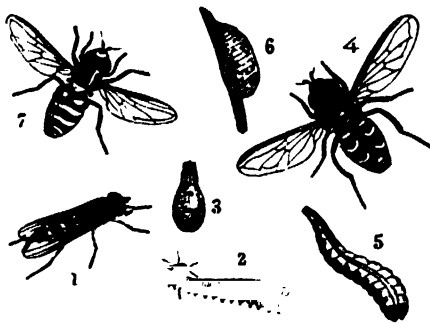

Fig. 923.—Hover-Flies. 1, 2, and 3, Female, larva (sucking an aphid), and pupa of *Syrphus balteata*; 4, 5, and 6, female, larva, and pupa of *S. Pyrastris*; 7, female of *S.*

persons unwillingly acquire a certain amount of information on the subject of their life-history. The eggs of Diptera hatch out into limbless maggots, that later on become pupæ, which are either of firm texture, or else soft, and enclosed in a strong coat.

The *Hover-Flies* (species of *Syrphus*, fig. 923) commence independent existence as maggots which play havoc among

aphides, sucking the soft contents of their bodies, and rejecting the shrivelled skins. The larvæ of a related insect, the Drone-Fly (*Eristalis tenax*), has been described elsewhere (vol. ii, p. 441) under the name of "rat-tailed maggot". This lives in liquid filth, but the larvæ of many flies are truly aquatic, e.g. those of

Gnats (Culicidæ). The life-history of one species (*Culex annulatus*) is represented in fig. 924. The female, when about to lay her eggs, holds firmly to some object by means of the first two pairs of legs, the last ones being stretched out at the back and crossed over one another (see figure). In the angle between their upper ends the elongated eggs are successively deposited, sticking together after leaving the body. As their number increases, the legs are gradually uncrossed and at last lie parallel to one another. The mass of eggs now floats away from between them in the form of a canoe-shaped raft. The wriggling larva makes its way

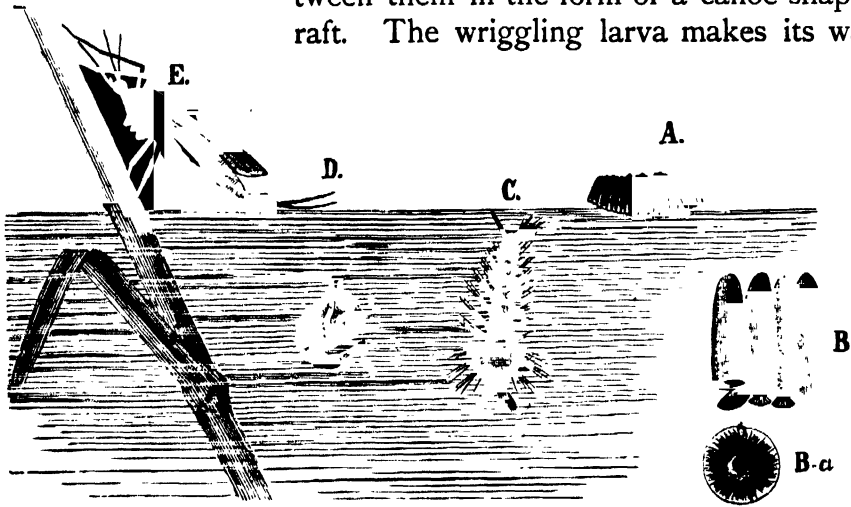

Fig. 924.—Life-history of Ringed Gnat (*Culex annulatus*)

- A. Raft of eggs, $\times 5$; B. separate eggs, $\times 24$; B. a, cup-shaped float attached to lower end of egg, $\times 160$;
C. D. and E. (all $\times 3$), larva, pupa, and female laying eggs.

out from the under side of the egg, which is provided with a kind of lid, and later on becomes a floating pupa. The way in which these stages breathe has already been described (see vol. ii, p. 442). The pupa is able to move when alarmed, on which point Hurst (in *The Pupal Stage of Culex*) makes the following remarks:—"The pupa is sensitive to light, and immediately darts backward when a shadow falls upon it suddenly. The movements, however, though very rapid, are devoid of anything like steering. The larva had to steer in its search for food, but the pupa has simply to get out of the way of danger, and the direction of its flight is of little importance, though, since the movement is always backward with reference to the pupa, it is chiefly downward with reference to the outer world. A sudden very loud

noise, or a very gentle tap upon the vessel containing the pupæ, causes those at the surface to dart downwards, but as slight sounds of various kinds produce no effect upon them, I conclude that the tremor of the surface of the water, and not the sound itself, was recognized by them." The last stage in the life-history is reached when the adult gnat makes its way out of the floating pupa, which splits along its back, and the wings are very quickly ready for use: otherwise there would be considerable danger of drowning.

LIFE-HISTORIES, &c., OF MOLLUSCS (MOLLUSCA)

We have here to successively consider members of the following subdivisions:—(1) Primitive Molluscs (Amphineura), (2) Bivalves (Lamellibranchia), (3) Tusk-Shells (Scaphopoda), (4) Snails and Slugs (Gastropoda), and (5) Head-Footed Molluscs (Cephalopoda).

PRIMITIVE MOLLUSCS (AMPHINEURA).—The only members of this group about which we possess detailed knowledge as regards life-history are the curious flattened Mail-Shells (species of *Chiton*, &c.), most of which live in shallow water, sheltered under stones or in narrow rock-crevices, to which their shape is no doubt an adaptation. The back is protected by eight overlapping shelly plates, and outside these the body-wall is drawn out into a narrow flap (mantle) under which the gills are lodged (see vol. ii, p. 392).

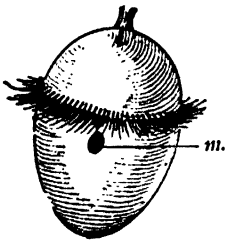

Fig. 925. — Trochosphere

The eggs are covered by firm shells, with spiny projections, and in some species (e.g. *Chiton Polii*) they remain under the shelter

of the mantle till the time of hatching. The development is indirect, and the just-hatched young is a ciliated Trochosphere (fig. 925), which resembles in many ways the larva of the same name characteristic of marine Bristle-Worms (see p. 359). Cuttle-fishes and the like excepted, most molluscs begin independent existence in the form of trochospheres, or else as larvæ which may be regarded as derived from these. This fact has been adduced by some zoologists in support of the view that the remote ancestors of Molluscs resembled marine Bristle-Worms in essential respects. If this "Annelid Theory" of molluscan descent be accepted, molluscs are profoundly different from their ancestors,

for they are now unsegmented, and very unlike annelids in most respects. It is impossible to discuss so difficult and technical a problem here, but we should do well to look with suspicion upon the theory in so far as it is based upon the occurrence of a trochophore larva in both annelids and molluscs. The peculiarities of this kind of larva have arisen as the result of adaptation to a free-swimming life, and they are of so simple a kind that they may quite conceivably have been evolved independently in half a dozen different distinct groups of animals, which have had the same life-problems to solve.

The Mail-Shell larva gradually undergoes a metamorphosis, ultimately losing its ciliated bands, developing shell-plates, foot, &c., and giving up swimming for creeping.

BIVALVE MOLLUSCS (LAMELLIBRANCHIA).

—In most of the marine bivalves which have so far been studied the eggs are simply ejected into the surrounding water, and there pass through the stages of their development. This is the case, for example, in the American Oyster (*Ostrea Virginiana*) and the Edible Mussel (*Mytilus edulis*). But in some marine and most freshwater forms the eggs have a better chance of escaping destruction, for they hatch out between the protective shells of the parent. For such an arrangement the structure of a bivalve offers special advantages, as will be gathered from the diagrammatic cross-section represented in fig. 926. Hanging down on either side, and covering the body like the flap of a coat, is a mantle-lobe, the outer side of which bears a shell. The space between body and mantle-lobes is known as the mantle-cavity, and into this two gill-plates project on either side. Each plate consists of two layers, between which is a space divided into a series of tubes by vertical partitions. As a matter of fact, the gills of bivalves vary greatly in different species, and the statement just made applies to forms in which they are large and complex. Here, then, are a number of sheltered spaces within which eggs can be incubated, and a further advantage is secured by the fact that water is constantly streaming through the mantle-cavity and gills, in relation to the



Fig. 926.—Diagrammatic Cross-Section through a Bivalve Mollusc. *l.*, Ligament; *s.*, shell; *m.*, mantle; *i.g.* and *o.g.*, inner and outer gill-plates.

breathing and feeding of the adult form (see vol. ii, p. 398). The abundant supply of oxygen which developing eggs require is thus provided for. In the Common Oyster (*Ostrea edulis*) the eggs hatch out in the space between mantle-flaps and gills; in

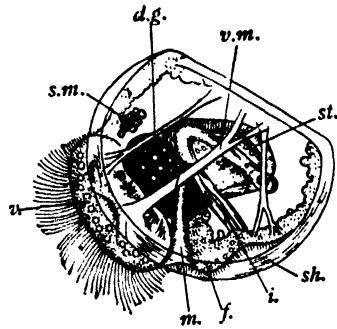

Fig. 927.—Veliger Larva (12 days old) of an Edible Mussel (*Mytilus edulis*), $\times 240$

shell muscle; *m.*, mouth; *st.*, stomach; *i.*, intestine; *d.g.*, digestive gland.

Freshwater Mussels (*Unio* and *Anodon*) the outer gill-plates serve as brood-pouches; while in some other freshwater forms (*Cyrena* and *Cyclas*) the inner gill-plates discharge this office.

The egg of marine bivalves, and more rarely that of freshwater forms, hatches out into a free-swimming larva, which is usually a Veliger (fig. 927). This may be regarded as a modified Trochosphere, for it possesses the circles of cilia, thickening of the skin to form a brain, and some of the other features which characterize a larva of

that kind (see p. 359). But the swimming arrangements are here more efficient, for the base of the head lobe is drawn out into a flap or velum, upon the edge of which the front circlet of cilia is placed. And the velum can be drawn back by special muscle-bands so as to get a purchase upon the water, thus propelling the larva forwards. Slower movements are executed by means of the cilia alone. The fully developed Veliger is obviously a Mollusc, for it has grown a foot and secreted a shell.



Fig. 928.—Glochidium of Fresh-

r., byssus

An unusual and aberrant life-history characterizes most of the Freshwater Mussels (species of *Unio* and *Anodon*). The eggs hatch out in the outer gill-plates as an extraordinary larva known as a Glochidium (fig.

928), the name having been given at a time when it was thought to be an independent species. It possesses a pair of triangular shells with strongly hooked tips, a long trailing sticky thread (byssus), and several peculiar pointed projections believed to be special sense-organs. There is some difference of opinion as to what happens when the Glochidia are ejected from the gills of the parent. It is generally stated that they swim about actively

by flapping their shells, but according to some highly competent observers masses of them remain passive on the surface of the mud with their long byssus threads waving about in the water. It will probably be found that their behaviour varies in different species. In any case the Glochidium's chance of further development entirely depends upon whether its sticky thread happens to touch the skin or gills of a fish. If this piece of good fortune should come about, it attaches itself firmly to the fish by means of the hooks on the shell. The irritation thus set up causes the skin or gill to grow out into a little capsule or cyst enclosing the Glochidium, and within this shelter development is continued. After a time, varying from a few weeks to several months, the form of the adult is fully acquired, and the little mussel falls out of the cyst into the mud. While attached to the fish it is provided not merely with shelter, but also with food, for it absorbs the juices of its unfortunate host. In Anodonta the hooks on the shell of the Glochidium are very well developed, and in this case the skin of the fish is attacked. But in *Unio* the hooks are much weaker, and fix themselves to the softer gills (fig. 929). The remarkable life-history just outlined is evidently an adaptation to freshwater conditions, for it prevents the delicate larvæ from being swept down to the sea, where they would perish, and is also important as regards distribution of the species. Some freshwater bivalves, such as *Cyclas* and *Pisidium*, gain the former end by suppressing the larval stage altogether, developing directly into the adult form by a series of gradual changes.

Dwellings of Bivalve Molluscs.—Most of these creatures live in mud or sand, through which they slowly plough their way; but some dwell in holes or crevices, others bore in various hard substances, and others again attach themselves to stones, &c., or construct a home from foreign bodies.

Attachment to firm objects is often effected by means of silky threads making up what is known as a *byssus*, springing from the back of the foot near its base. A well-known example is afforded by the Edible Mussel (*Mytilus edulis*, fig. 930), of which great numbers may often be seen adhering by their black threads to rocks or piles near low-water mark. But this animal is not necessarily doomed to spend the whole of its adult life glued to the



Fig. 929. — Glochidia of Freshwater Mussel (*Unio*), encysted on gills of Perch, enlarged

same spot, for it is able to cast off the mooring-threads and creep away by means of its foot, which, however, is much smaller than in forms which lead a comparatively active life. Another well-known bivalve (*Tridacna*), which often attains a great size, also possesses a byssus and a small foot, and is common in the fissures of coral reefs with its under side facing upwards. The two openings, by means of which currents of water respectively enter and leave the mantle-cavity, are conveniently placed about the middle of the upturned margin, instead of being situated at the back end, as is usually the case. Some of the File-Shells (species of *Lima*) construct a sort of nest for themselves by fixing bits of stone and other foreign objects to-

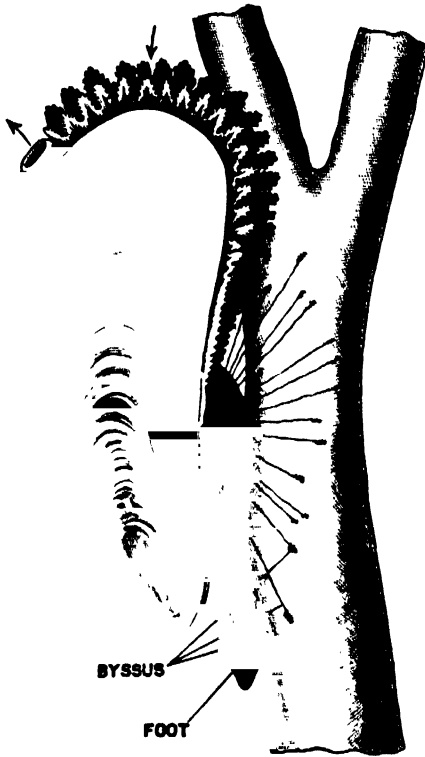

Fig. 930.—Edible Mussel (*Mytilus edulis*). The arrows indicate currents of water entering and leaving the mantle-cavity.

(*Anomia ephippium*) is common on our shores, settle down on their right sides when they leave the larval state, and become very

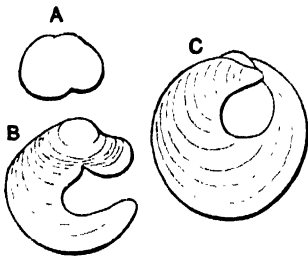

Fig. 931.—Shells of Saddle-Oyster (*Anomia*). A, B, and C, Successive stages of growth.

unsymmetrical, as is usually the case when the two sides of the body are permanently exposed to conditions of different kind. The lower or right valve is here flat, and the upper or left one strongly curved. The flat valve is very closely applied to the underlying surface, to which it is firmly fixed by a hard conical plug that runs from the body of the mollusc through a hole in the shell, and is no other than the calcified byssus. As might be expected, the foot is very small, and its chief use is to act as a byssus-

The curious Saddle- of which one small species

of which one small species

carrier. The perforation of the shell is at first a notch, as will be seen by reference to fig. 931.

The Scallops (species of *Pecten*) afford another example of bivalves with a very small foot, useless for locomotor purposes. Some of the species swim by opening and shutting their shells, while others are attached by means of a byssus, and rest on their right sides. As in Saddle-Oysters, there is well-marked asymmetry in such cases, but here, as usually, the valve which is kept below is strongly curved, while the other one is flat and forms a kind of lid as it were. This is an obviously advantageous arrangement, for the opening and closing of the shell are effected more easily than if the upwardly facing valve were convex and comparatively heavy, as, curiously enough, it is in the Saddle-Oysters. Another character which generally distinguishes bivalves that are permanently fixed on one side is the rounded or irregular shape of the shell, which loses the elongated form seen in so many active species.

The Thorny Oysters (*Spondylus*) are closely related to the Scallops, but all of them are fixed to firm objects by the substance of the right valve, which is relatively very large and thick. The foot is much reduced, and there is no byssus.

The Oysters (species of *Ostrea*) are the most familiar examples of fixed bivalves, and are attached by the substance of the *left* valve. Not only is there no byssus, but the useless foot has entirely disappeared, as an adaptation to the sedentary habit.

Those bivalves which bore into hard substances present a number of very interesting characters related to their mode of life. Some account has elsewhere been given (p. 221) of the habits of the Piddocks (*Pholas*, fig. 932) in this connection, but some interesting facts regarding them may be added or repeated here. There can be little doubt that burrowing is effected by means of



Fig. 932.—Piddocks (*Pholas*). *a*, Burrow of young individual; *b*, *c*, phosphorescent areas; *c*, young piddock; *d*, foot; *e*, shell.

the shell, the front part of which is raised into a system of intersecting ridges with sharp projections. These are brought into action by twisting movements on the long axis, during which the flat surface of the cylindrical foot holds on to the end of the burrow. Chemical action is excluded by the fact that piddocks

are able to bore into hard siliceous rocks as well as into those of calcareous nature. In spite of its use for boring purposes the shell is quite thin, probably because it has not the same value for protective purposes as in non-burrowing forms. The later part of the life-history of a form (*Pholadidea*) closely related to the Piddock is of very great interest. To begin with, it bores into rock after the fashion of its relative, but when full grown loses its foot, closes up the front end of the shell, and remains stationary for the rest of its life. The hinder end of the shell is produced into a sort of hollow cylinder, directed towards the opening of the burrow, and enclosing the two tubes (siphons), through one of which currents bearing food and oxygen continually flow, while the other gives exit to return currents that carry off the various products of waste, and also enable the eggs to make their way to the exterior. Another form (*Jouannetia*), allied to the foregoing, bores into

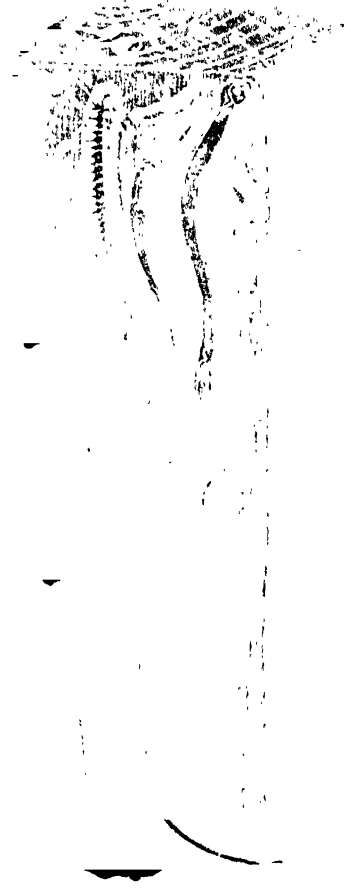

Fig. 933.—Ship-Worms (*Teredo navalis*) A Bristle-Worm has appropriated an empty burrow on the left.

a block of coral, excavating a spherical cavity exactly corresponding to the shape of its body. When adult, the front of the shell is closed up, and the foot lost as in the form last mentioned. If the shell were perfectly round it is clear that there would be a danger of the animal slipping round so that the openings of the siphons were directed away from the exterior, the result of which would be fatal, as there would be no possibility of

moving back to the proper position. Such slipping, however, is impossible, for there is a tongue-shaped projection from the back of the right valve which fits into the opening of the burrow and serves as a holdfast.

The notorious Ship-Worm (*Teredo navalis*, fig. 933), which in the days of entirely wooden vessels played such havoc with their timbers, belongs to a family which is closely related to

that including the Piddocks and their allies. The body is not rounded like that of the last-mentioned bivalve, but resembles a long slender cylinder. The shell is of relatively very small size and placed at the front end of the body, while the two siphons project at the other. The burrow has a smooth calcareous lining, formed by the hardening of a fluid which is exuded from the skin. If



Fig. 934.—Date-Shells (*Lithodomus*)

in the course of its boring operations this mollusc reaches the outside of the wood it closes the opening with a shelly plate.

The Date-Shells (*Lithodomus*, fig. 934) are relatives of the Edible Mussel that burrow only in limestone rocks. In this case the work is supposed to be chiefly done by an acid fluid, which acts as a solvent. The shell is covered by a tough horny layer, and is thus protected from the corrosive action to which its calcareous substance would otherwise be exposed.

TUSK-SHELLS (SCAPHOPODA).—These are burrowing forms with a curved conical shell open at both ends. As to their life-history, it need only be said that the eggs are discharged freely into the water, where they hatch out into trochospheres,

which resemble the larvæ of marine annelids in some respects (fig. 935).

SNAILS AND SLUGS (GASTROPODA).—It will be convenient to consider in succession marine, freshwater, and terrestrial members of this group, afterwards adding some remarks on Gastropod Dwellings.

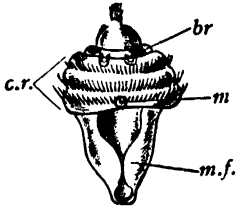

Fig. 935.—Trochophore Larva of Tusk-Shell (*Dentalium*), en-

Egg-laying and Protection of Eggs.—

Among marine forms there are some very careless parents, such as Common Limpets (*Patella*) and Sea-Ears (*Haliotis*), in which the eggs are simply discharged into the surrounding water, where but few of them survive the many dangers by which they are encompassed. This casual arrangement is, however, exceptional, and the eggs are

usually laid in batches, some provision being also made for their welfare up to the time of hatching. In Sea-Slugs, Wing-Footed Snails (Pteropods), and Heteropods, the "spawn" is a jelly-like mass in which numerous eggs are imbedded. Such masses may be either irregular clumps, or else of more definite form. They may be cord-like, as in the Sea-Hare (*Aplysia*), or shaped like a spiral band, as in the Sea-Lemon (*Doris*), or else of some other regular shape. Most of the Sea-Snails lay their



Fig. 936.—Egg-capsules of Purple-

eggs in capsules of various kind, which also contain a nutritious fluid for the benefit of the developing embryos, much as in the cocoons of Earth-Worms (see p. 360). Among the common objects of our shores are the little stalked egg-capsules of the

Purple-Shell (*Purpura lapillus*, fig. 936), of which a large number may be produced by the same

individual. Each of them contains from 400 to 600 eggs, of which, however, only from 10 to 16 attain full development, while the rest are used as food by their successful brethren. More striking objects are the egg-capsules of the Common Whelk (*Buccinum undatum*, fig. 937), of which from 150 to 170 are aggregated together into a rounded mass. Each capsule contains from 5 to 30 eggs, of which only a small number hatch out. In certain other species, *e.g.* the Dog-Whelk (*Nassa*), all the eggs complete their development. Curious spirally-rolled bands, which are not infrequently cast up on the shore, are the

spawn of species of *Natica* (fig. 938), which are originally fixed by one edge, but have been torn from their attachment. They contain a very large number of eggs, imbedded in a hardened secretion, together with innumerable sand-grains, to which the brown colour is due.

The Violet-Snail (*Ianthina*), which swims freely through the

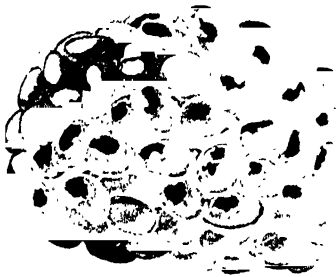

Fig. 937.—Spawn of Whelk (*Buccinum undatum*), $\times \frac{1}{2}$

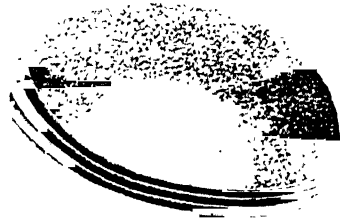

Fig. 938.—Spawn of *Natica*

water on its back, constructs a raft of hardened slime with enclosed air-bubbles (fig. 939), to the under side of which the egg-capsules are attached. The slime is derived from a gland imbedded in the foot, the front part of which during the construction of the raft is alternately raised above the surface and depressed below it, bringing down an air-bubble each time.

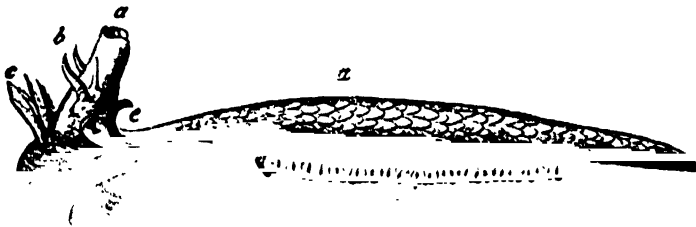

Fig. 939.—Violet-Snail (*Ianthina*) and Raft. *a*, Snout; *b*, tentacles; *c*, gills; *d*, raft; *e*, foot; *f*, eggs.

This snail drifts about for long distances, attached to its floating nursery.

Some of the Bonnet-Limpets (species of *Crepidula*), with a conical shell twisted into a little spiral at the top, appear to remain stationary, holding on to the underlying rock by means of the foot. The egg-capsules are deposited in the space sheltered by the edge of the shell, and possess very thin walls, in relation to their protected situation. In the Worm-Snails (*Vermetus*) the egg-capsules are deposited within the mouth of the shell,

which is a loosely wound spiral tube with only the first few turns in contact.

Among air-breathing Freshwater Snails the spawn is usually gelatinous, common examples being afforded by the Pond-Snails (*Limnæa*), where the mass is elongated and sausage-shaped, and the Trumpet-Snails (*Planorbis*), in which it is oval. These collections of eggs are attached to water-plants, or, in captive specimens, are often fixed to the glass walls of the aquarium. A somewhat exceptional case is presented by our common River-Snail (*Paludina vivipara*), in which the eggs are not laid, but develop internally, and the young snails when they first enter the world resemble the adult except in size.

Of terrestrial forms many of the Land-Slugs (*e.g.* species of *Limax*) deposit gelatinous masses of spawn, in which numerous eggs are imbedded. Land-Snails lay a varying number of eggs, each enclosed in a more or less firm calcareous shell. The common Garden-Snail (*Helix aspersa*) digs a little hole in the earth, deposits from 40 to 100 eggs in this, and then covers them over with soil. Some of the large South American Land-Snails (species of *Bulimus*) lay very large eggs, which superficially resemble those of a pigeon, but have a widely different structure, for the included egg-cell is minute, most of the space within the shell being filled with a nutritive fluid. These eggs are deposited singly, and in the case of the arboreal species each of them is enclosed in a rolled-up leaf.

Gastropod Larvæ.—As in bivalves, the eggs of marine forms usually hatch out as free-swimming larvæ, which may be either trochospheres or veligers. These vary greatly in appearance, as may be gathered from fig. 940, in which a few typical forms are represented. Development is direct in freshwater and terrestrial species, there being no free-swimming larva, though a stage corresponding to it may be passed through before hatching takes place, proving that development was indirect in ancestral forms, and that the existing state of things is an adaptation to changed surroundings. In Onchidium, for example, a curious slug which lives on the upper part of the shore in various parts of the world, a typical veliger is developed within the egg (fig. 940), but this is gradually modified into the adult shape before the time of hatching.

Gastropod Dwellings.—Permanent homes constructed by the

animal itself are exceptional in this group, those forms with a large shell usually finding this a sufficient protection. Many of the creeping marine species shelter in rock-crevices, and others burrow (see p. 217). Some land-snails (species of *Helix*) excavate holes in limestone rocks, and the carnivorous slug *Testacella*, which pursues earth-worms underground, escapes many dangers by its mode of life. Many of the soft-bodied sea-slugs possess

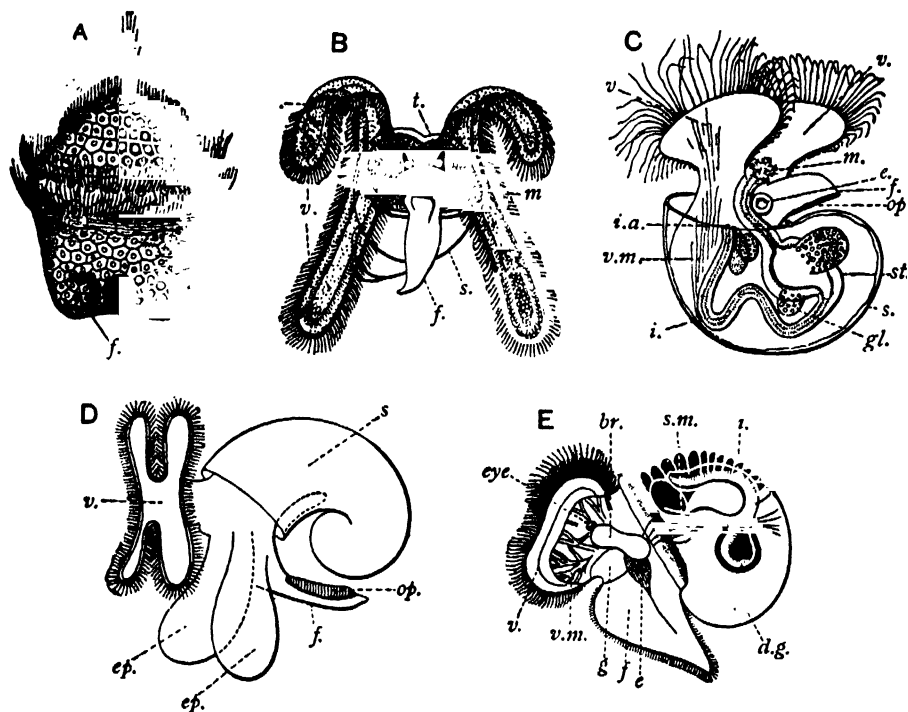

Fig. 94a.—Gastropod Larvæ, much enlarged

A, Trochosphere of Limpet (*Patella*). B-E, Veligers of a Fore-gilled Snail, a Hind-gilled Snail, a Wing-footed Snail, and a Pulmonate (*Onchidium*). *br.*, Brain; *d.g.*, digestive gland; *e.*, ear (otocyst); *ep.*, epipodium; *f.*, foot; *g.*, gullet; *gl.*, gland; *i.*, intestine; *i.a.*, intestinal aperture; *m.*, mouth; *op.*, operculum; *s.*, shell; *s.m.*, shell-muscle; *st.*, stomach; *t.*, tentacle; *v.*, velum; *v.m.*, muscles of velum.

disagreeable properties, which are advertised by warning colours, and some marine gastropods resemble their surroundings so closely as to be inconspicuous (see vol. ii, pp. 306 and 285). These devices largely obviate the necessity for dwellings, while egg-capsules and the like play the part of nurseries.

The typical shape of a Gastropod shell is spiral, and it is commonly large enough to serve as an efficient refuge, the animal completely withdrawing into it, and often possessing a horny or limy plate (*operculum*) which serves as a door to close the weak

place in the defences. But quite a number of sea-snails, and a few freshwater ones, have evolved a different type of shell, correlated with a creeping life on rocks, &c., in pursuit of vegetable food, and sometimes associated with a permanent home. This is the case with all those forms known as "limpets", in which the shell is cap-shaped or conical, sometimes with a small spiral at its tip. There can be no doubt that the ancestors of such species possessed the usual spiral shell, which may indeed be present in early life, recapitulating the former state of things.



Fig. 941.—Purple-Shell (*Purpura lapillus*)

The limpet-shaped shell is correlated with the presence of an unusually large oval foot, and when danger threatens this holds on to the underlying surface with great tenacity, and the shell is pulled down over the body. The two methods of defence just indicated may be seen side by side on 'tween-tide rocks. The Purple-Shell (*Purpura lapillus*, fig. 941) possesses an unusually thick shell and a strong operculum. When withdrawn into its dwelling it can defy most enemies, and stand a good deal of knocking about by the waves. The Common Limpet (*Patella vulgata*, fig. 942), on the other hand, unless it happens to be crawling over a very rough surface, is extremely difficult to detach unless taken unawares. The possession of a smooth place as a permanent residence is here so important that the animal returns to the same spot after every feeding excursion,

and in course of time excavates an oval "scar" by means of the edge of the shell and the action of the foot. As these scars are formed in hard siliceous rocks as well as in calcareous ones, corrosion by an acid secretion plays no part in the matter, as has been suggested by some observers. The conical shape of the shell is calculated to resist the wash of the tide and waves, to which it offers but little purchase. It must not be supposed that all Gastropods with a limpet-shaped shell are of necessity



Fig. 942.—Limpet (*Patella vulgata*) leaving its Scar at Low Tide

closely related. The same arrangements would appear to have been independently evolved in several different groups, as the result of adaptation to similar conditions.

There is one brackish-water snail (*Potamides*) that lives in estuaries, and is reminiscent of those bivalves which attach themselves by means of a byssus (see p. 407). For it spins a number of strong threads, which serve to hold it firmly to the roots of mangrove-trees.

HEAD-FOOTED MOLLUSCS (CEPHALOPODA).—The eggs are here comparatively large and contain a good deal of food-yolk. Those of Squids (*Loligo*, fig. 943) are enclosed in gelatinous tubes, of which a considerable number are associated, and radiate from a stone or other firm body to which they are

attached. Each individual egg is surrounded by a firm investment. In the Common Cuttle-Fish (*Sepia*, fig. 944) each egg is enclosed in a firm spindle-shaped capsule about the size of a hazel-nut, and a number of these are fixed to sea-weeds or

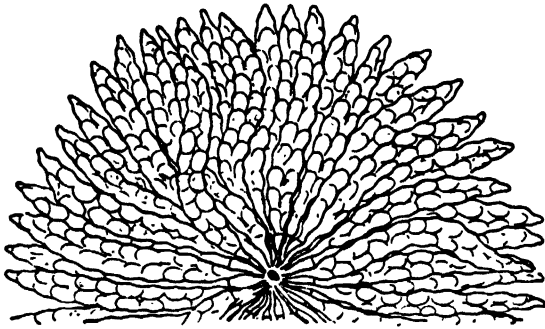

Fig. 943.—Spawn of Squid (*Loligo*), $\times \frac{1}{2}$

stones, looking something like a bunch of grapes.

Among eight-armed forms (Octopods) a common British species (*Eledone moschata*) deposits small groups of egg-capsules, which are attached to various firm substances. The

Poulpes (*Octopus*) lay their eggs in ovoid capsules, of which a large number are united by their stalks into a long necklace-like string. This is fixed to a rock, and the mother broods over it, hastening the development of the eggs by ejecting

streams of water. The beautiful shell of the female Paper Nautilus (*Argonauta*) serves as a nursery, for to its inner side she attaches her grape-like mass of egg-capsules.

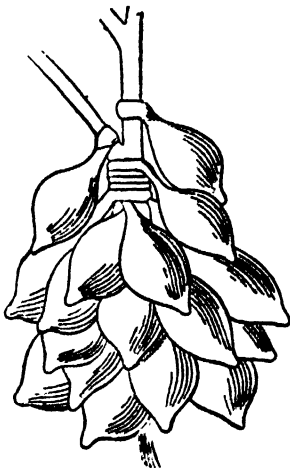

Fig. 944.—Egg-Capsules of Cuttle-Fish (*Sepia*)

The eggs of one species of Pearly Nautilus (*Nautilus macromphalus*), according to the recent observations of Willey in the sea adjoining New Caledonia, are deposited singly during the night, being fixed by a spongy substance to some suitable surface. Each of them is enclosed in a double capsule, of gristly consistency. The inner layer of this forms a regular oval case, but the outer layer is very irregular.

So far as known development is always direct in Cephalopods, the egg containing sufficient yolk to obviate the necessity of premature hatching as a larval form.

Few members of the group can be said to possess dwellings, but creatures of the Octopus kind, which have to some extent given up swimming for creeping (see p. 109), lurk in caves and

holes in the rock. Most readers will recollect the somewhat melodramatic account given by Victor Hugo (in *The Toilers of the Sea*) of an encounter with a gigantic animal of the sort.

LIFE-HISTORIES, &c., OF NEMERTINE WORMS (NEMERTEA)

The unsegmented ciliated worms included in this group are usually of rounded shape, and the vast majority of them are marine, though some few live in fresh water or on the land. Their structure has elsewhere been described (see vol. i, p. 305). Some Nemertines are quite small, but others may be many yards in length.

The marine forms are for the most part oviparous, and lay their eggs either singly or in clumps, surrounded by a gelatinous substance, much as in some of the molluscs. Development may be either direct or indirect, and in the latter case the larva which issues from the egg is often of the kind known as a

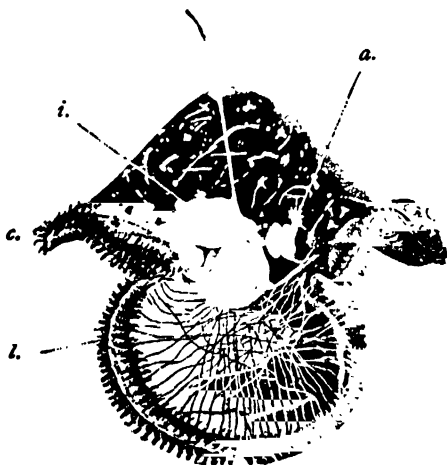

Fig. 945.—Pilidium Larva from the right side, enlarged. *c.*, Ciliated band; *d.*, two of the four disc-like ingrowths to form the young worm (the other two are seen to the left); *i.*, intestine; *l.*, side-lappet.

Pilidium (fig. 945), which resembles an antique helmet in shape, and is like a trochosphere in some respects. The adult worm comes into existence by the ingrowth of four depressions of the skin, which surround the digestive tube. The remaining organs are gradually formed, and the metamorphosis is completed by the larval skin being thrown off. A few Nemertines are viviparous, the eggs developing internally, and in this case there is no larval stage.

The majority of marine forms live in shallow water among corals or sea-weeds, round which they twine their bodies. Many may be found under stones near low-water mark. A few species live in tubes, formed by the hardening of a fluid which exudes from the skin into a membranous or gelatinous substance. Others appropriate the empty shells of molluscs as dwellings, and some kinds excavate burrows for the same purpose.

CHAPTER LVI

LIFE-HISTORIES, CARE OF EGGS AND YOUNG, AND DWELLINGS, IN BACKBONED ANIMALS (VERTEBRATA)

We have here to consider in succession the classes of Primitive Vertebrates (Protochordata), Fishes (Pisces), Amphibians (Amphibia), Reptiles (Reptilia), Birds (Aves), and Mammals (Mammalia).

LIFE-HISTORIES, &c., OF PRIMITIVE VERTEBRATES (PROTOCHORDATA)

WORM-LIKE PROTOCHORDATES (HEMICHORDA).—The widely distributed species of Acorn-headed Worms (*Balanoglossus*) are marine forms which burrow in sand or mud. A viscid fluid exudes

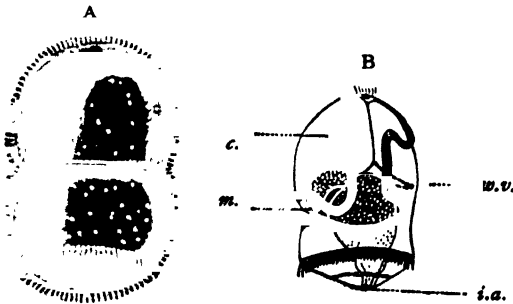

Fig. 946.—Larvæ of Acorn-headed Worms (*Balanoglossus*), enlarged. A, Simple form of larva. B, Tornaria; c., anterior ciliated band; m., mouth; i.a., intestinal aperture; w.v., water-vascular sac.

from the skin and glues the surrounding deposits into a sort of indefinite tube, which, however, is not of a permanent nature. Development is indirect, and two sorts of larva are known (fig. 946). The simpler of the two is somewhat egg- and covered with cilia, there also being a

circlet of longer ones near the hinder end. This larva gradually passes into the adult form without any striking metamorphosis. It first of all increases in length, and becomes divided by transverse furrows into three sections, which are destined to grow into the proboscis, collar, and trunk, of the mature form (see vol. i, p. 300). The gill-slits and other characteristic organs soon begin to make their appearance.

The second type of larva, characteristic of certain species, is known as a Tornaria (fig. 946). It resembles a trochosphere in some respects, while in others it approximates to the larvæ of star-fishes, and was originally believed to be a young Echinoderm. The uniform covering of short cilia and a posterior ciliary circlet, often found in the first-named type, are also present here, but there is in addition a complicated band of similar nature which passes round the mouth, and takes the course shown in the figure. It is comparable to the band of larval Echinoderms (pp. 355 and 357).

The large group of SEA-SQUIRTS, ASCIDIANS, or TUNICATES (UROCHORDA) presents a great variety of life-histories which are of special interest, because they illustrate quite a number of general principles. We may take as a first example a simple fixed Tunicate (*Ascidia*), of which the structure has already been briefly described (see vol. i, p. 297). The egg hatches out into a tadpole-shaped larva (fig. 947), which possesses the three characters which distinguish vertebrate animals from others.

For it has (1) gill-slits, (2) a tubular central nervous system placed near the upper surface of the body, (3) an elastic rod, the notochord (the "forerunner of a backbone"), lying immediately below the nervous system, though in this particular instance limited to the tail-region. After leading a free-swimming life for some time the larva fixes itself by three sticky knobs on its head, and becomes an adult by a series of radical changes in its organization. The tail, with its notochord, shrivels up—the nervous system becomes reduced to a small solid mass or ganglion—and the gill-slits become so numerous as to convert the pharynx into a sort of ciliated basket, by which currents are set up which enable the animal to feed and breathe. A firm protective covering (test) is formed on the surface of the body, and the shape comes to resemble that of a skin flask with two openings, into one of which water streams, afterwards flowing out again through the other. The adult is therefore of lower grade than the larva, and only exemplifies one of the three crucial vertebrate characters, *i.e.* the

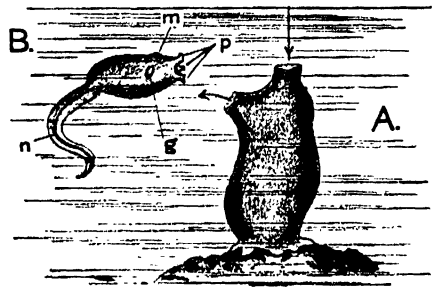

Fig. 947.—Adult (A.) and Tadpole Larva (B.) of Simple Ascidian (A. reduced and B. enlarged). g, Gill-slit; m, mouth; n, notochord; p, adhesive papillæ.

possession of gill-slits. This is a clear case of Degeneration, and is correlated with the fixed habit of life.

Many of the fixed Tunicates are colonial, as the result of a process of budding, though they also produce eggs from which individuals are developed that found fresh colonies. Vegetative propagation is unknown among vertebrates, except in this lowly group, and in certain relatives of the Acorn-headed Worms.

The floating population of the sea includes a number of transparent Tunicates. Among these are the Salps, which illustrate the kind of alternation of generations (metagenesis) elsewhere described for the hydroid zoophytes (see p. 349). In these creatures there are two stages in the life-cycle—(1) an egg-producing stage, and (2) a budding stage (fig. 948). The latter is known as a Solitary Salp, from the hinder end of which a long string

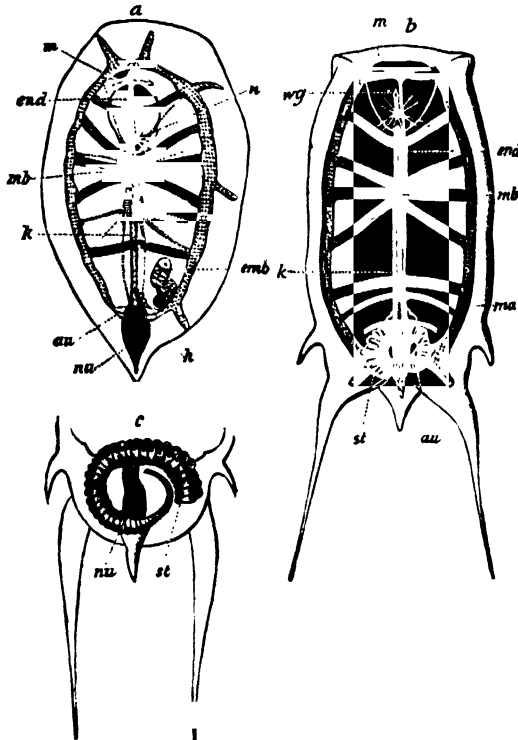

Fig. 948.—A Salp (upper side), enlarged

a, Egg-producing stage; *b*, budding stage; *c*, hinder end of *b* (further enlarged); *au*, atrial opening at hinder end out of which water streams; *end*, endostyle (a groove on floor of pharynx); *emb*, embryo of budding-stage; *h*, heart; *k*, gill; *m*, mouth; *ma*, protective covering; *mb*, muscle-band; *n*, central nervous system; *nu*, stomach and intestine; *st*, chain of egg-producing individuals (budding from *b*); *wg*, sense-organ.

of egg-producing forms grows out, these being called Chain Salps, because they are at first united together. Later on the chains break up, and the eggs of each individual develop into the solitary stage.

LIFE-HISTORIES, &c., OF FISHES (PISCES)

Under this heading will be considered some of the more interesting facts regarding Round-Mouths (Cyclostomata), Sharks and Rays (Elasmobranchii), and Ordinary Bony Fishes (Teleostei).

ROUND-MOUTHS (CYCLOSTOMATA).—The only member of this group of which the life-histories and habits have been carefully studied are the Lampreys (species of *Petromyzon*), of which some are marine, others live in fresh water, while others again spend part of their adult existence in the sea and part in rivers. And even the marine forms enter fresh water for the purpose of spawning. We have three native species, the large Sea-Lamprey (*Petromyzon marinus*), the much smaller River-Lamprey or Lampern (*P. fluviatilis*), and the diminutive Small Lamprey (*P. Planeri*). In all of them the eggs are deposited in a sort of trench which is dug out for their reception, and hatch out in the form of a larva which differs so much from the adult that it was formerly believed to be a distinct species, and received the name of Ammocoetes (fig. 949), by which it is still known. The larva is blind and toothless, and is said to swallow mud for the sake of the contained organic matter. After several years

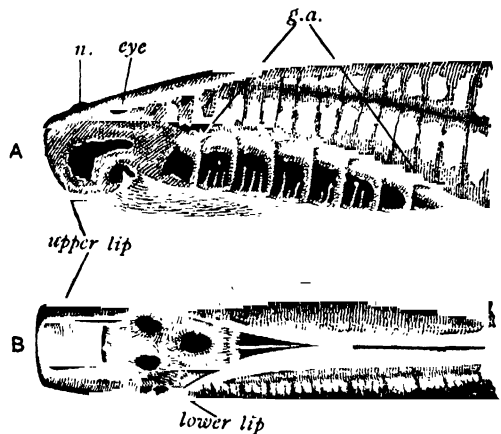

Fig. 949.—Front end of Ammocoetes from Left Side (A) and from below (B), enlarged. n., nostril; g.a. (n), gill apertures.

of larval existence, during which it undergoes a gradual series of changes, it assumes the adult form, and the development of horny "teeth" enables it to adopt a carnivorous habit. The eyes, which are at first useless and covered by the skin, come to the surface, and other changes in the internal structure also take place.

In the case of the Sea-Lamprey and the Lampern, when larval life is over there is a migration to the sea, and there is no return to fresh water except for spawning purposes. It is said that the Lampern usually dies after laying its eggs. Regarding the habits of the Small Lamprey there is considerable divergence of opinion. Some observers believe that its entire life is spent in its native brook or river, while others assert that it migrates to the sea like the other two species. There can be little doubt that it dies after spawning, being thus reminiscent of what takes place in many Insects, where the greater part of life is spent in the larval state.

SHARKS AND RAYS (ELASMOBRANCHII).—Some few members of the order are viviparous, but, as a rule, the eggs are laid in horny cases (fig. 950), within the shelter of which development takes

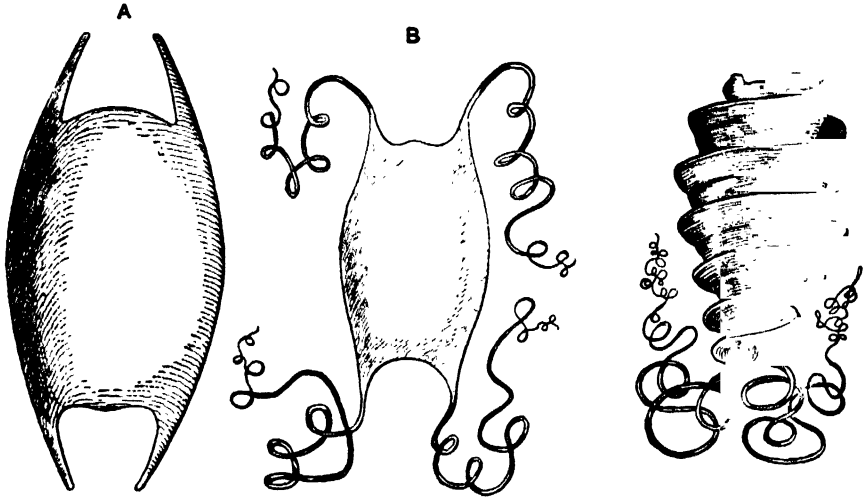

Fig. 950.—Egg-capsules of Skate (A), Spotted Dog-Fish (B), and Port Jackson Shark (C). c reduced.

place, and from which the young fishes ultimately emerge in a form closely resembling that of the adult. There is here no necessity for the early hatching of a larval form, since the egg is large, and contains abundant food-yolk. The egg-cases vary in shape in different species, and are popularly known as “mermaids’ purses”. Those of the Common Skate (*Raia batis*) are flat and squarish, with the corners drawn out into pointed processes, while in the Spotted Dogfish (*Scyllium canicula*) they are somewhat narrower, and provided with four tendril-like threads, by means of which they are attached to sea-weeds. An external spiral fold and two tendrils are present in the case of the Port Jackson Shark (*Cestracion Philippi*).

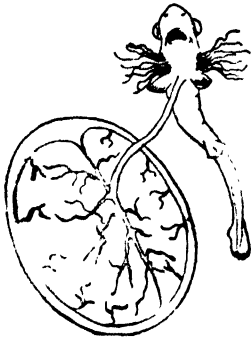

Fig. 951.—Advanced Embryo of Dog-Fish removed from the Egg-capsule. Note the large yolk-sac (with branching blood-vessels) to left. The embryo is provided with long external gills.

The abundant yolk makes up the greater part of the egg, and cleavage is consequently partial (see p. 346), the body of the embryo being developed from a small patch of living substance placed at one end. If the egg-case is cut open after development has gone on for some time the immature fish will be found within,

and attached to its under surface will be seen a sort of bag (yolk sac) in which the yolk is contained, serving as a supply of food until hatching takes place (fig. 951).

ORDINARY BONY FISHES (TELEOSTEI).—A few members of this order are viviparous, but the large majority lay eggs, which are of much smaller size than those of Sharks and Rays, varying from $\frac{1}{25}$ to $\frac{2}{5}$ of an inch in diameter. They are produced in correspondingly large numbers, this fecundity being an important means of protecting the species, since but a very small percentage develop into adults. Günther says, in *The Study of Fishes*, "The small-sized roe in the Herring, Lump-fish, Halibut, and Cod-fish have been estimated at, respectively, 25,000, 155,000, 3,500,000, and 9,344,000". In individual Turbot, weighing 18, 21, and 23 lbs., the number of eggs respectively produced has been estimated at 5,612,000, 10,114,000, and 14,311,000. There is usually no special provision for the protection of the eggs, which in those forms which live in the open sea are usually found floating on the surface (fig. 952). Although so small, the eggs contain a large proportion of food-yolk, and cleavage is consequently partial (see p. 346), the body of the embryo developing from a small patch situated at one end.

It is clearly advantageous that the patch which becomes the embryo should be below, and the egg naturally floats with this part downwards, the lighter yolk being on top, and in many cases containing an oil-drop which ensures the maintenance of this favourable position (fig. 952).

In some marine fishes, notably in the Herring (*Clupeus harengus*), the eggs do not float, but are sticky, and adhere to stones and other substances on the sea-bottom. Some of the fishes known as Blennies (*Bleniidae*), several species of which are common on our shores, lay their eggs in little horny capsules, which are attached to rocks (fig. 953). One of our native species, the Viviparous Blenny (*Zoarces viviparus*), is, as its name indicates, exceptional in the nature of its life-history. It is a comparatively

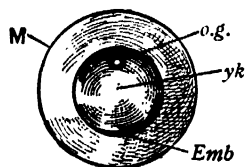

Fig. 952.—Floating Egg of Sea-Bass (*Serranus atrarius*), enlarged. M, Enclosing membrane; Emb, embryonic patch; o.g., oil-globule imbedded in yolk (y \dot{k}).

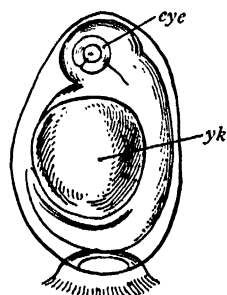

Fig. 953.—Embryo of a Blenny (*Blennius*) enclosed in its Capsule, much enlarged. y \dot{k} , yolk.

SHARKS AND RAYS (ELASMOBRANCHII).—Some few members of the order are viviparous, but, as a rule, the eggs are laid in horny cases (fig. 950), within the shelter of which development takes

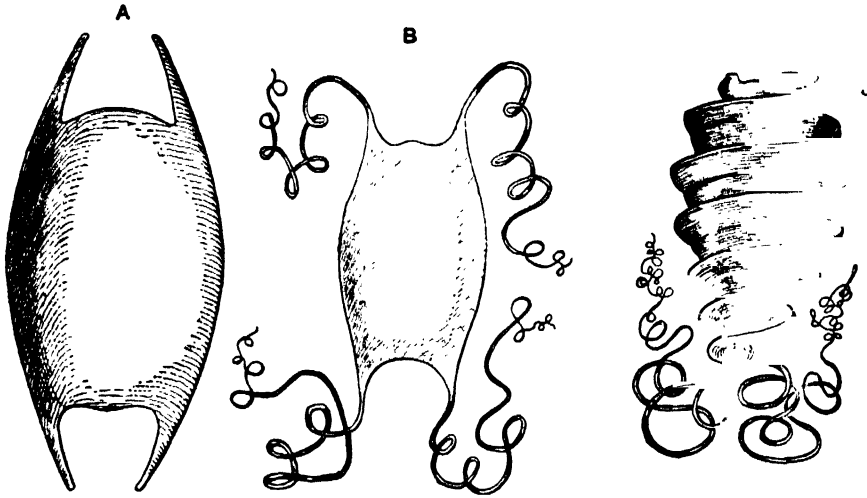

Fig 950.—Egg-capsules of Skate (A), Spotted Dog-Fish (B), and Port Jackson Shark (C). c reduced.

place, and from which the young fishes ultimately emerge in a form closely resembling that of the adult. There is here no necessity for the early hatching of a larval form, since the egg is large, and contains abundant food-yolk. The egg-cases vary in shape in different species, and are popularly known as “mermaids’ purses”. Those of the Common Skate (*Raia batis*) are flat and squarish, with the corners drawn out into pointed processes, while in the Spotted Dogfish (*Scyllium canicula*) they are somewhat narrower, and provided with four tendril-like threads, by means of which they are attached to sea-weeds. An external spiral fold and two tendrils are present in the case of the Port Jackson Shark (*Cestracion Philippi*).

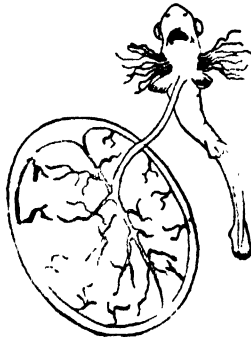

Fig. 951.—Advanced Embryo of Dog-Fish removed from the Egg-capsule. Note the large yolk-sac (with branching blood-vessels) to left. The embryo is provided with long external gills.

The abundant yolk makes up the greater part of the egg, and cleavage is consequently partial (see p. 346), the body of the embryo being developed from a small patch of living substance placed at one end. If the egg-case is cut open after development has gone on for some time the immature fish will be found within,

and attached to its under surface will be seen a sort of bag (yolk sac) in which the yolk is contained, serving as a supply of food until hatching takes place (fig. 951).

ORDINARY BONY FISHES (TELEOSTEI).—A few members of this order are viviparous, but the large majority lay eggs, which are of much smaller size than those of Sharks and Rays, varying from $\frac{1}{25}$ to $\frac{2}{5}$ of an inch in diameter. They are produced in correspondingly large numbers, this fecundity being an important means of protecting the species, since but a very small percentage develop into adults. Günther says, in *The Study of Fishes*, "The small-sized roe in the Herring, Lump-fish, Halibut, and Cod-fish have been estimated at, respectively, 25,000, 155,000, 3,500,000, and 9,344,000". In individual Turbots, weighing 18, 21, and 23 lbs., the number of eggs respectively produced has been estimated at 5,612,000, 10,114,000, and 14,311,000. There is usually no special provision for the protection of the eggs, which in those forms which live in the open sea are usually found floating on the surface (fig. 952). Although so small, the eggs contain a large proportion of food-yolk, and cleavage is consequently partial (see p. 346), the body of the embryo developing from a small patch situated at one end.

It is clearly advantageous that the patch which becomes the embryo should be below, and the egg naturally floats with this part downwards, the lighter yolk being on top, and in many cases containing an oil-drop which ensures the maintenance of this favourable position (fig. 952).

In some marine fishes, notably in the Herring (*Clupeus harengus*), the eggs do not float, but are sticky, and adhere to stones and other substances on the sea-bottom. Some of the fishes known as Blennies (*Bleniidae*), several species of which are common on our shores, lay their eggs in little horny capsules, which are attached to rocks (fig. 953). One of our native species, the Viviparous Blenny (*Zoarces viviparus*), is, as its name indicates, exceptional in the nature of its life-history. It is a comparatively

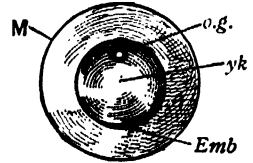

Fig. 952. — Floating Egg of Sea-Bass (*Serranus atrarius*), enlarged. M, Enclosing membrane; Emb, embryonic patch; o.g., oil-globule imbedded in yolk (y.k.).

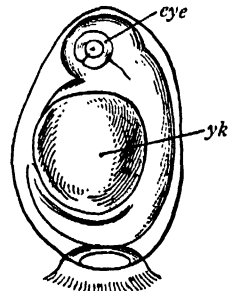

Fig. 953. — Embryo of a Blenny (*Blennius*) enclosed in its Capsule, much enlarged y.k., yolk.

large form, as it may be as much as 2 feet long, and development is entirely internal. A single brood consists of from 50 to 100 individuals, each about $1\frac{1}{2}$ inch in length and resembling the adult in shape. The comparatively small size of the family is correlated with the protective nature of the development, which gives the young fishes a much better chance than usual of attaining maturity.

The fresh waters of the land are largely tenanted by forms which have been driven to take refuge there, as a result of the keen struggle for existence which is always going on in the sea. And some marine fishes increase the chance of survival of their species by using rivers as their nurseries. This has already been illustrated in the case of certain Lampreys (see p. 423), and the Salmon (*Salmo salar*) is a well-known instance of the same thing. These fishes periodically migrate into fresh water for the purpose of spawning, and they excavate by means of the tail a sort of trench in which the eggs are deposited, afterwards being covered by sand or gravel.

The parental duties of Fishes usually terminate when the eggs have been laid, but to this there are some interesting exceptions both among marine and freshwater species. One instance is afforded by the Butter-Fish or Gunnel (*Centronotus Gunnellus*), a slimy and rather eel-like Blenny, often to be found in the rock-pools of our coasts. Cunningham (in *Marketable Marine Fishes*) speaks as follows of it in this connection:—"At St. Andrews Mr. Holt saw the spawning of the Butter-Fish or Gunnel in the aquarium in February. The eggs were adhesive, and the parents were seen to roll the mass of eggs into a ball by coiling their bodies round them, not both parents together, but the male and female in turns. It has been observed by Professor M'Intosh and Mr. Anderson Smith, that in the natural condition the parents are found coiled round the balls of spawn, which are somewhat larger than walnuts and not attached to anything." Female Fishes are not remarkable for any great display of solicitude as regards their offspring, but some honourable exceptions, besides that of the Butter-Fish, have been recorded. In a form (*Aspredo*) native to Guiana, and belonging to the widely distributed freshwater family of Cat-Fishes (*Siluridae*), the under side of the female's body becomes rough and spongy at the time of spawning. After the eggs are laid she presses against them, so that they adhere to this

region, and are carried about till the time of hatching. Another instance is afforded by a curious little Pipe-Fish (*Solenostoma*) which inhabits the Indian Ocean, and, like other related forms, is distinguished by its tubular snout. The large pelvic fins of the female overlap each other, and also fuse with the adjacent skin so as to constitute a backwardly opening brood-pouch, within which the eggs develop. A large number of threads grow out from the inner side of this pouch, and among these the eggs are entangled.

Fishes often make very exemplary fathers, and among the most interesting instances of parental instinct are certain species allied to the two last mentioned. In some of the Cat-Fishes, for example, the male guards the hollows in which the eggs are laid, while in other members of the same family (e.g. *Arius*) he carries them about in his gill-chambers till the time of hatching, a situation which ensures not only protection but a constant supply of fresh oxygenated water. In the Greater Pipe-Fish (*Syngnathus acus*) and the little Sea-Horse (*Hippocampus*, fig. 954) the male possesses a brood-pouch on the under side of his body, rather far back. Within this the eggs hatch out. In the former case it is said that the young fishes make use of the pouch as a refuge for some time after they begin their free existence.

The male fish sometimes constructs regular nests for the reception of the eggs. This is the case, for example, in the beautiful little Paradise Fish (*Polyacanthus* or *Macropomus viridauratus*), distinguished by its bright colours and large forked tail. It has long been domesticated in China, from which country it was introduced into Europe, and probably differs a great deal from the wild parent species, of which nothing is yet known. At the time of spawning, the male constructs a floating nest of froth, bringing down air-bubbles and entangling these in slime to make a bowl-shaped construction. To this he conveys the eggs, and watches jealously over them till the time of hatching, and even afterwards, for it is said that if one of the tender fry escapes from the nursery he carefully takes it back again.

Male Sticklebacks (*Gasterosteidae*) construct muff-shaped nests from bits of weed, glued together by sticky threads which their

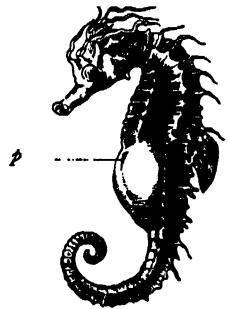

Fig. 954.—Male !
(*Hippocampus*). p, opening
of brood-pouch.

bodies provide, probably as the result of temporary kidney-disease (fig. 955). The matter is thus charmingly described by Fred Smith (in *The Boyhood of a Naturalist*), evidently as the result of first-hand observation, for the Common Three-Spined Stickleback (*Gasterosteus aculeatus*) of fresh water. After describing a combat in which a male stickleback, or "robin" (so



Fig. 955.—Ten-Spined Stickleback (*Gasterosteus pinnigatus*, upper figure), and Three-Spined Stickleback (*G. aculeatus*, lower figure). At the bottom is shown the nest of the latter.

named from his bright courtship colours), has engaged, the writer thus proceeds:—"But what is it all about, why is our friend so pugnacious? Well, I never! Fancy not knowing; even my brother knows that! Why, in that clump of weed the 'robin' has a home, as real a home as any human father has in this world. You may call it a nest if you like, but he considers it his home, so decidedly that no knight, even of King Arthur's Round Table, was ever more jealous of his castle than he is of that. And he has a wife there, perhaps two or more, but I

think only one; and what is more, there is a group of as beautiful little eggs, almost ready to hatch, as anyone could wish to see. I could show them to you, but that would mean the destruction of the house, which I wouldn't have touched for the world. I haven't shown my brother where it is, for he might have a shy at it if I offended him. Now, look here, I must show you with a stick; and see how brave the gallant little 'robin' is—his spines are out, and he doesn't mean to leave his home undefended. See here a kind of green sponge about the size of a hen's egg; it is made up of gathered-up and broken . . . weed, the same as that which forms the clump. You certainly would not have noticed it; but now, if you can, look very closely. What do you see? If you have eyes at all you can see the tip, only the tip, of the tail fins; and if I gently put this weed aside with the stick, you can see the tip of a darling little nose. That is the lady keeping house and minding the prospective offspring. Now if I just apply my stick so, away goes the lady there, but not very far. And what happens? The instant my interfering stick is taken away, the 'robin' takes the lady's place in the nest; and now only the tip of *his* tail and the end of *his* nose is to be seen; and there he will remain till his spouse has the courage to come back, as he always does remain in possession when the lady goes out shopping—dear me! I mean foraging for food. Who told me it was a nest? . . . Why, nobody told me. I've seen them making a nest, *i.e.* working at it, even in this ditch; but I've seen them make one more than once from beginning to end in my own aquarium. There isn't much making about them, though, except with their mouths and their noses. When you see the sticklebacks, especially the 'robin', poking and picking away at bits of green rubbish, and when, every now and then, a whole mouthful of odd bits of anything is suddenly shot out before him, all of which he will catch like a conjurer without letting any fall to the ground, and then disappear, be sure a nest is being built. I think the swallowing, and tossing and turning of fragments of weed or decaying leaves, which I have repeatedly witnessed, is to give such items some property of hanging or attaching themselves together. In any case, a nucleus of the nest will soon be seen, which is added to in the way I describe; and so far as I can make out, nothing like structural arrangement is attempted. All

that is apparently done is to make the ball of oddments sufficiently large—a process which has entailed many wild dartings about, and much poking and arranging with noses; and then one of them, generally again the male, makes a dart at the ball, or they do so in turns, and attempt to wriggle themselves through the middle of it. The object is to make a kind of tunnel right through, which is at last accomplished, and that is the nest. But there is a good deal of fussy procedure after that, or some mysterious arrangement is made inside, since, for a few days longer, material is often shot in or shot out; and sometimes, after it has been completed, it isn't thought sufficiently snug, and material is added on the outside. And they are clever little builders, for a house of theirs might be constructed under your very nose and you would probably not see it." This account may be supplemented by facts which other naturalists have ascertained. The nest has at first only one opening, and is made by the male, who is decidedly polygamous. When the nursery is ready he conducts his consorts to it one after the other, each laying from two to four eggs, after which they swim away and take no farther interest in domestic concerns. The second opening in the nest is made by the first female after laying her eggs, for instead of backing out she forces her way out through the further wall of the cavity. The existence of two apertures is favourable to development, for it promotes a constant flow of fresh water through the nest. When all the eggs have been laid the male stickleback, arrayed in brilliant war-paint, guards the nursery jealously till the young hatch out, which takes place in about ten days. Nor is his task a sinecure, for the time is spent in continual combat with other sticklebacks, especially females, who constantly try to reach the nest for the purpose of eating the developing eggs. After hatching has taken place the father protects the fry till they are large enough to look after themselves.

Sticklebacks have been treated at length, not only because their ways are particularly interesting, but also because anybody can easily stock a small freshwater aquarium for himself, and become an eye-witness of the curious domestic drama above described, which is enacted about mid-spring. Similar habits characterize our smaller native species, the Ten-spined Stickleback, or "Tinker" (*Gasterosteus pungitius*), in which the male

becomes deep black during the spawning season; and also our Fifteen-spined Stickleback (*G. spinachia*), a rather larger form common on the coast, and perhaps also entering some of the rivers, as it does on the Continent.

The members of the present order usually hatch out as transparent larvæ, which are very unlike their parents, and have to go through a well-marked metamorphosis before they attain the adult condition. A particularly instructive case is afforded by the Flat-Fishes (*Pleuronectidæ*), of which we may take the Turbot (*Rhombus maximus*) as an example. No one but an expert would suspect that the larva (fig. 956) which hatches out

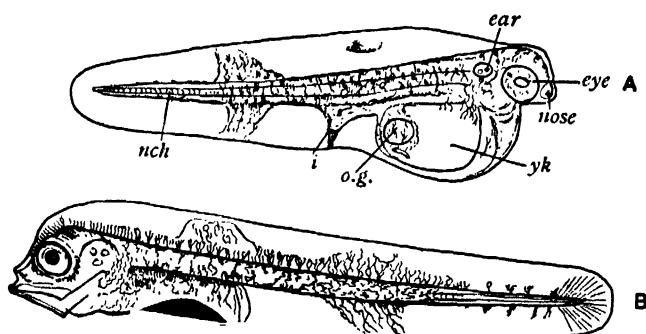

Fig. 956.—Turbot (*Rhombus maximus*). A, Just-hatched larva. B, Larva eight days old: *i*, intestine, *nch*, notochord; *o.g.*, oil-globule; *yk*, yolk. Enlarged.

from the floating egg of this form was destined to become a flat-fish. It is a transparent creature about $\frac{1}{2}$ of an inch long, and, since it possesses no mouth, is incapable of feeding. The food at this stage consists of the nutritive material contained in the bulging yolk-sac on the under side of the body. The second stage represented in the figure was taken from a larva eight days after hatching. Well-developed mouth and jaws were present, and the yolk* was entirely used up. Somewhat later on the right eye begins to move up the side of the body, gradually passing over the top of the head to the left side. As this curious migration goes on the upright swimming position is gradually abandoned for an oblique, and finally for a horizontal one. A swim-bladder is present. Until a length of about an inch is attained the young Turbot lives at the surface, regarding which Cunningham (in *Marketable Marine Fishes*) thus speaks:—"The advantage of this power and habit of swimming at the surface is not difficult to discover. Even at

these early stages the turbot and brill are rapacious, and feed on other fishes smaller than themselves. They might capture such prey when lying like the adult at the bottom, but in summer time the young of other kinds of fishes are much more plentiful in the open water and near the surface than at the bottom. In the aquarium at Plymouth the young turbot have been fed on pieces of dead fish, but both they and the brill much prefer living prey, and when kept with other young fish, such as flounders, speedily devour them or choke themselves in the attempt." Later on these little creatures settle down to a life on the sea-floor, and lose the swim-bladder, which is not



Fig. 957.—Turbot (*Rhombus maximus*)

required by a ground-fish. The left side of the body, which is kept uppermost (fig. 957), is strongly pigmented, while the other side is pale. Some of the points in this life-history are good instances of recapitulation, leading to the conclusion that the asymmetrical

flat-fishes are descended from symmetrical forms in which a swim-bladder was present. While in Turbot and Brill both eyes are on the left side of the body, the right side being kept next the sea-bottom, the reverse is the case in most of our edible flat-fishes, such as Plaice, Flounder, Dab, Halibut, Sole, and Lemon Sole.

Allusion has already been made to the spawning habits of the Salmon (*Salmo salar*). Shoals of these fishes ascend rivers in spring for the purpose of laying their eggs, which event takes place in the autumn. Development is a very slow process, for it is three or four months before the young hatch out. They are then only about $\frac{1}{8}$ of an inch long, and a large yolk-sac projects from the under side of the body (fig. 958). In the second year of life the young salmon, known in this stage as "parr", descend to the sea, apparently returning every year to their native river for the purpose of spawning. Several years elapse before the adult characteristics are fully acquired,

and many different names, which vary with the locality, are given to the successive stages of life. Our knowledge of the habits of the Salmon still leaves much to be desired, especially as to its life in the sea.

The life-history of the Common Eel (*Anguilla vulgaris*) presents us with a curious reversal of events as compared with the Salmon. Until about twenty years ago no male eels had been discovered, but we now know that the so-called "broad-

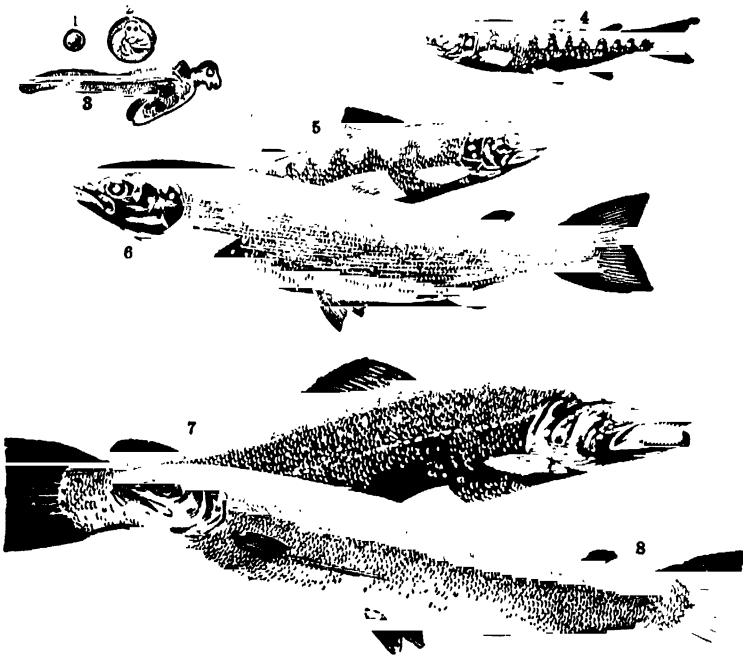

Fig. 958.—Salmon (*Salmo salar*). 1, Egg; 2, egg with embryo (enlarged); 3, young larva with yolk-sac (enlarged); 4, Parr; 5, Smolt; 6, Grilse; 7 and 8, adult male and female.

nosed eels" and "sharp-nosed eels", long believed to be distinct varieties, are respectively the males and females of this species. Thanks mainly to the painstaking observations of Grassi and Calandrucchio, made on the Sicilian coast in 1891-92, the life-history has at last been elucidated as regards its main features. In October and November the adult eels migrate to the deep sea for spawning, after which they most probably die, since there is no reliable evidence of a return to fresh water. The eggs hatch out into larvæ of which the early stages are unknown, and we first meet them as transparent flattened creatures devoid of scales, which have long been familiar to naturalists under

the name of *Leptocephalus*, and supposed to be either a distinct species, or else young fishes which have developed abnormally. The particular sort with which we are here concerned (*L. brevirostris*, fig. 959) is distinguished by the shortness of its snout, and the Italian naturalists named above have been able to show that

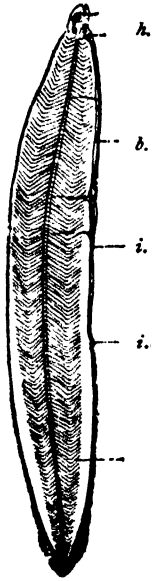

Fig. 959.—Larval Eel (*Leptocephalus brevirostris*); *h.*, heart; *b.*, body-cavity; *i.*, inter-

it gradually assumes a cylindrical though still scaleless form, and undoubtedly grows into an eel. From February to May vast multitudes of these young eels, known as “elvers” or “eel-fare”, ascend our rivers, those of them which survive reaching the adult state in fresh water, never returning to the sea again, except to spawn. It has also been proved that another kind of *Leptocephalus* (*L. Morrisii*) is the larval stage of the marine Conger Eel (*Conger vulgaris*). It is sometimes taken on our own coast, and has received the name of Morris.

LIFE-HISTORIES, &c., OF AMPHIBIANS (AMPHIBIA)

Some few members of this class are viviparous, but the vast majority lay eggs which usually hatch out into aquatic larvæ, familiarly known as “tadpoles” or “pollywogs”. The life-history of the common Grass Frog (*Rana temporaria*) has been briefly described in an earlier section (see vol. i, p. 254). Amphibian eggs contain a considerable amount of food-yolk, and there are not infrequently special protective arrangements, in which case comparatively few are produced. We will consider in succession some of the more interesting facts relating to Tailed Amphibians (Urodela), Tailless Amphibians (Anura), and Limbless Amphibians (Gymnophiona).

TAILED AMPHIBIANS (URODELA).—This group is represented in our country by the familiar Efts or Newts, of which we have three native species (see p. 46). During the spawning season they enter the water for the purpose of laying their eggs, which, as in Amphibians generally, possess gelatinous investments. They are attached to stones or water-plants, and the little tadpoles, which hatch out in a fortnight or so, fix themselves for

a time to water-plants by means of threads that project from the upper jaw.

Among other species of newt-like animals there may be more elaborate provision for the welfare of the eggs. These may be moored to stones by means of threads into which their investments are drawn out, as in one of the forms native to eastern North America (*Spelerpes bilineatus*); others again are deposited in little bags hung up on water-plants, as in a West Siberian species (*Salamandrella Keyserlingi*). Instances have also been described of maternal solicitude. The eel-like Three-toed Salamander (*Amphiuma means*) of the south-eastern United States, for example, coils her body round the string of eggs, which hatch

out into tadpoles about three months later. In one little newt (*Desmognathus fuscus*, fig. 960), native to the east of North America, the stalked eggs are fixed to the body of the mother, who shelters in a hole during their development. Part of the tadpole-stage in the life-history is here passed through within the egg.



Fig. 960.—Female *Desmognathus fuscus* with her eggs

This prepares us for what takes place in a form (*Autodax lugubris*) which lives in the western part of North America. The adult is entirely terrestrial, and the female retires to a hole underground for the purpose of laying her eggs, each of which is fixed to a bit of earth by means of a thread. They number about a score, and when all are deposited the mother coils herself round them until such time as they hatch out, a fortnight or three weeks later. The tadpole-stage is passed through entirely within the egg, and the young closely resemble their parents except in size and colour. This reminds us of the life-history of the slug *Onchidium*, where there is no free-living larva, although this is well represented before hatching (see p. 414). Such a life-history is intelligible when regarded as an adaptation to life on land, with entire abandonment of aquatic existence.

The famous case of the Axolotl, mentioned elsewhere (see vol. i, p. 249) is the exact reverse of what has just been described. For here the adult stage under certain conditions is entirely suppressed, and the animal remains a tadpole. It may therefore be

regarded as a permanent larva, though one that has acquired the power of laying eggs. This peculiar state of things has come about in the absence of surroundings suitable for life on land. When such surroundings exist the Axolotl does become adult, and is then a kind of salamander.

A few Urodeles are viviparous, development taking place internally. This is the case, for example, in the Spotted Salamander (*Salamandra maculosa*), which does not lay eggs, but produces a brood of tadpoles. The Black Salamander (*S. atra*) of the Alpine region is also viviparous, and produces only a couple of young, which make their appearance in the world as minute facsimiles of their parents, though they pass through a tadpole stage before they are born. What has been said above about *Autodax* (p. 435) applies to this case also, except that development is internal instead of being external. The small number of young produced by the Black Salamander is clearly in relation to an improved chance of individual survival resulting from the sheltered nature of the development. It appears, however, that a great many eggs are actually formed, though the large majority of them disintegrate and serve as food for the two which are destined to perpetuate the species.

TAILLESS AMPHIBIANS (ANURA). — The Frogs and Toads which make up this group are very specialized creatures, which differ remarkably among one another in respect of egg-laying and care of eggs.

In the majority of cases a very large number of comparatively small eggs are produced, from which typical tadpoles hatch out that are but ill adapted to cope successfully with the many dangers to which they are exposed. Relatively few of them become adult, and extreme fecundity alone prevents such species from becoming extinct. Comparison may be made with fishes in this respect (see p. 425). In average cases the eggs are laid in water, familiar instances being afforded by the Common Toad (*Bufo vulgaris*) and the Grass Frog (*Rana temporaria*), the jelly-like spawn of the former consisting of long cylindrical strings, while that of the latter is in the form of irregular clumps. Both kinds are to be seen floating in our ponds and ditches in early spring, quite uncared for by the parents, though not altogether unprotected. Examination of frog-spawn will show that each of the black shot-like eggs is inclosed in a sphere of jelly, which is

LIFE-HISTORY OF THE COMMON GRASS-FROG .

(*Rana temporaria*)

This common Amphibian is an admirable illustration of evolutionary principles, for it begins its existence as a fish-like tadpole, which breathes by gills and feeds on vegetable matter, and later on is gradually transformed into a limb-bearing, lung-breathing, carnivorous frog, adapted to a life on land. Spawning takes place in spring, each egg being enclosed in a gelatinous sphere, which buoys it up, prevents overcrowding, and serves as a protection. The just-hatched tadpole is mouthless and tailless, and for a time holds on to a water-weed by means of adhesive discs on the under side of its head. It quickly grows a broad swimming-tail, and develops a mouth. Later on the limbs sprout out, and the bag-like lungs grow from the under side of the gullet. Ultimately the gills disappear, the gill-slits close, and the tail shrivels up. The life-history of the individual Frog gives us some idea of the evolutionary changes which have taken place in the past history of the groups of Reptiles, Birds, and Mammals, the remote ancestors of which were aquatic, fish-like creatures.



LIFE-HISTORY OF THE COMMON GRASS-FROG (RANA TEMPORARIA)

of importance in several ways. For it acts as a buoy, prevents overcrowding, and by concentrating heat upon the egg hastens development. It also serves as a protection against ducks and other birds, owing to its slippery nature and bitter taste.

A good many species lay their small eggs out of the water, this being the case, for example, with a little Brazilian frog (*Leptodactylus mystacinus*), which is purely terrestrial when adult. Spawning takes place before the advent of the rainy season, the mother scooping out a good-sized hole in the neighbourhood of water for the reception of her eggs, which are surrounded by a frothy mass that prevents them from drying up, and also appears to serve as food for the young tadpoles. They are afterwards washed out of their nest by the rain, and thus gain the adjacent pond, where they develop into adults. Should there be a drought the tadpoles live on in the nest till the following rainy season.

Some of the Tree-Frogs deposit their eggs upon plants which overhang the water, one or more leaves being folded together into a sort of protective case. Such an arrangement has been described for a species (*Phyllomedusa Jheringi*, fig. 961) native to South Brazil, in which the eggs and the jelly by which they are surrounded are wrapped up in willow leaves. The tadpoles hatch out in this hanging nest and drop into the water below.

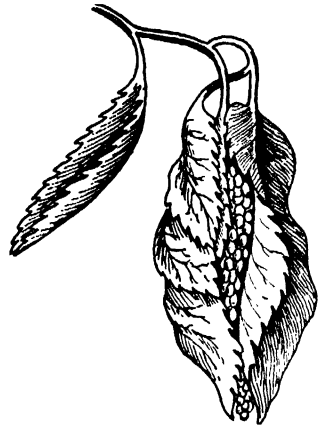

Fig. 961.—Egg-case of a Brazilian Tree-Frog (*Phyllomedusa Jheringi*).

The two species last described display a certain amount of parental care, but are far surpassed in this respect by a Brazilian tree-frog (*Hyla faber*) known locally as the "Ferreiro", *i.e.* "Smith", on account of its curious voice, the sound of which has been compared to that produced by a copper plate beaten with a mallet. The female makes a circular nest in the shallow water at the edge of a pond (fig. 962), one or two nights being required for its construction. We are indebted to Goeldi for our knowledge of this interesting habit, of which he gives the following account, based on observations made in his own garden at Para: "We soon saw a mass of mud rising to the surface carried by a tree-frog, of which no more than the two hands emerged.

Diving again, after a moment's time, the frog brought up a second mass of mud near the first. This was repeated many times, the result being the gradual erection of a circular wall. From time to time the builder's head and front part of body appeared suddenly with a load of mud on some opposite point. But what astonished us in the highest degree was the manner in which it used its hands for smoothing the inside of the mud wall, as would a mason with his trowel. When the height of the wall reached about four



Fig. 96a.—Nests of the Ferreiro (*Hyla faber*)

inches the frog was obliged to get out of the water. The parapet of the wall receives the same careful smoothing, but the outside is neglected. The levelling of the bottom is obtained by the action of the lower surface (belly and throat principally) together with that of the hands." (*Proceedings of the Zoological Society*, 1895.) The parents remain concealed near the nest till the time of hatching, which takes place in four or five days. Within their circular "nursery" the tadpoles live till the adult stage is attained.

When the eggs are small and numerous, as in ordinary Frogs and Toads, hatching takes place comparatively early, and the tadpoles are at first extremely helpless. They cannot even feed, for the mouth is not yet properly developed, and the absence of a tail in the earliest stage adds greatly to their disabilities. Some

means of protection is obviously necessary, and this is found in the presence of one or a pair of modified sticky areas on the under side of the head, by means of which the larva adheres for some time to a water-plant.

We now pass to the consideration of certain tailless forms in which the eggs are less numerous and of larger size, containing indeed so much food-yolk that there is no necessity for early hatching, and the young animals begin their free existence either as advanced tadpoles which have already lost their gills, or else in the adult form. There is often some special provision for the care of such eggs during their development, and a comparison may well be made with those fishes which exert a certain amount of parental care (see p. 426). In the simplest case the eggs are simply deposited in damp places, as in a Japanese species (*Rhacophorus Schlegeli*) of tree-frog, where the female digs a hole near a pond or ditch and lays her eggs in it, also taking care to provide a supply of air by working up the jelly of the spawn into a sort of frothy mass by means of her hind-feet. Tadpoles hatch out from these eggs later on.

A pretty little West Indian tree-frog (*Hylodes Martinicensis*, fig. 963) lays about a score of large eggs upon a leaf, very often in the sheltered angle close to the stem. They are imbedded in a frothy mass of jelly. While development is going on it is said that the mother remains on guard not far off. Minute frogs of about one-fifth of an inch in length emerge from the eggs in about three weeks. The tadpole stage is thus passed through before hatching, and it is noteworthy that there is a certain amount of "hastening of events" in the development, since gills and gill-slits do not make their appearance, there being in fact no need for them.

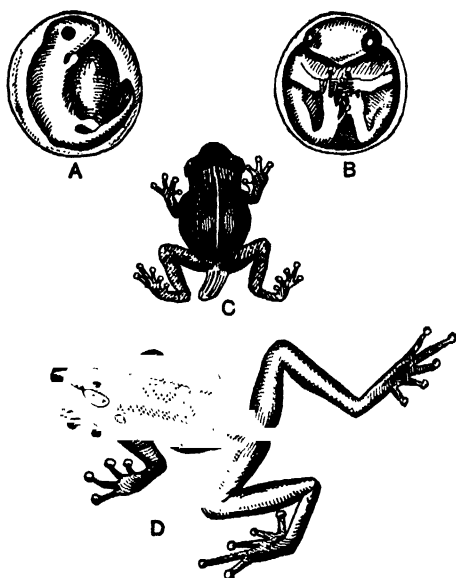

Fig. 963.—Development of a West Indian Tree-Frog (*Hylodes Martinicensis*). A and B, Eggs containing embryos seven and twelve days old; c, just-hatched Frog; d, adult male.

In one species of toad (*Alytes obstetricans*, fig. 964) which ranges from Portugal to Central Germany, the eggs are taken care of by the male, reminding us of what happens in some fishes (see p. 427). They are laid in two long strings folded up into a gelatinous mass, through which he thrusts his legs and carries it about till the tadpoles are ready to hatch out, some three weeks later. During this critical time the father hides during the day in some hole or corner, digging a refuge for himself if necessary. At night he ventures out to feed, and prevents the eggs from drying up by moistening them with water or dew. When the

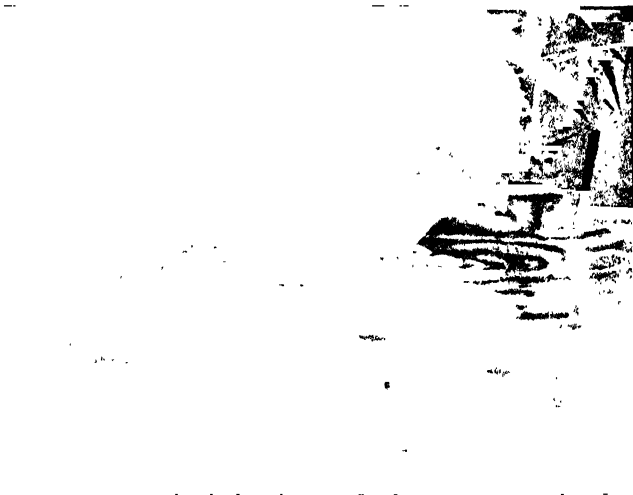

Fig. 964.—Male *Alytes*, carrying the eggs

time for hatching arrives he goes into the water, and the tadpoles wriggle out of their investments. They are well developed, for the eggs are fairly large, and contain a considerable amount of food-yolk, which enables the early part of the larval stage to be passed within the egg.

The male of a small species of toad (*Rhinoderma Darwini*) native to Chili tends the eggs in a still more curious way. He possesses a large croaking sac situated just within the skin on the ventral side of the body. The ordinary use of this, as in such creatures generally, is supposed to be that of a resonator by which the volume of the voice is increased. The pouch opens by a slit on either side of the tongue, and it serves as a receptacle for the eggs, though how they get into it is not known. The whole of the development takes place in this secure shelter, out of which

the young ultimately escape as minute toads (fig. 965). No gills appear to be present in the tadpole stage. When not employed as a nursery the pouch is of modest dimensions, only stretching about half-way down the chest, but as the eggs develop it gradually extends along the whole under surface and round the sides.

In some tailless forms the eggs are carried about by the female, the arrangements made for their safety varying according

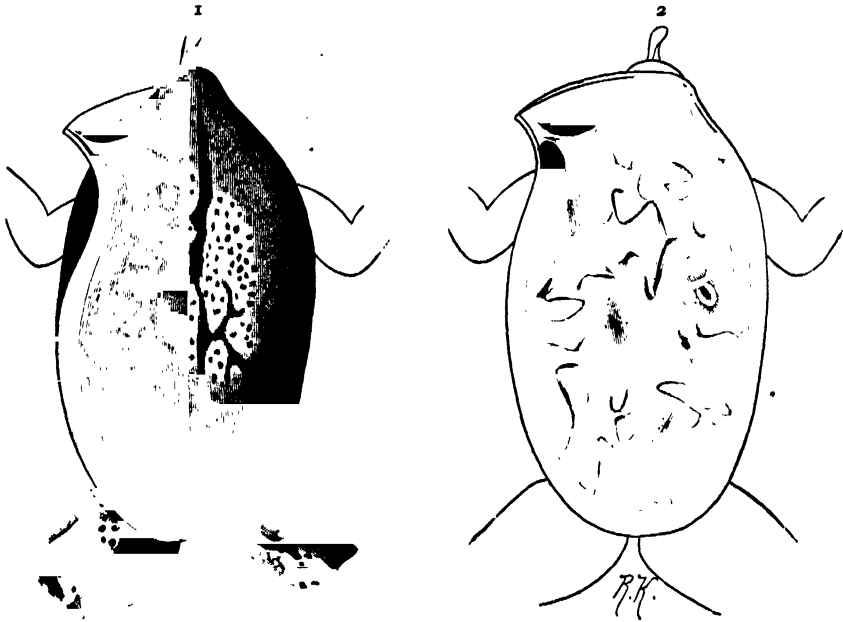

Fig. 965.—Male of a Chilean Toad (*Rhinoderma Darwini*). 1, Skin removed to show brood-pouch; 2, brood-pouch opened.

to the species. A well-known case is that of the Surinam Toad (*Pipa Americana*, fig. 966), in which the sticky eggs are spread by the male over the back of his mate. Where each of them is affixed a little pouch is formed in the skin, exactly how is unknown, and afterwards a lid comes into existence, possibly by hardening of the egg-investment. Within these sheltered recesses the whole of the development takes place, and when the young begin their free existence they have already attained the form of the adult.

In one of the Cingalese tree-frogs (*Rhacophorus reticulatus*) the female places her score or so of eggs on the under side of her body, where they sink into the skin, little pits being formed some-

what as in the form last described. Details are wanting, but the young are said to hatch out as tadpoles.

In some other cases there is a more or less well-developed pouch for the reception of the eggs on the upper surface of the mother's body. In a small Brazilian tree-frog (*Hyla Goeldii*), for example, the skin grows out into a narrow fold surrounding an oval area in which the eggs are placed, presenting an appearance suggestive of a shallow dish full of pale-coloured oranges. There is a large quantity of food-yolk, and the young have almost



Fig. 966.—Female of Surinam Toad (*Pipa Americana*), carrying the developing young on her back

attained the form of the adult at the time they hatch out. In the pouched tree-frogs (*Nototrema*) of tropical South America the female possesses a permanent pouch on the upper side of her body, with an opening at the back. The young sometimes begin their free existence as advanced tadpoles, but in most of the species they have acquired

the adult form before they make their way out of the pouch.

LIMBLESS AMPHIBIANS (GYMNOPIHONA).—The life-histories of these curious burrowing snake-like creatures have not been very exhaustively studied, but there are considerable differences between those species which have so far been the subject of investigation. One of the Cæcilians (*Ichthyophis glutinosa*, fig. 967), native to South and South-east Asia is one of the least aberrant species as regards development. The female excavates a hole in damp earth close to a stream, and lays some two dozen large eggs, round which she coils her body during their development. Shortly before hatching, the tadpole stage within the egg possesses three pair of long plume-like external gills of scarlet colour, and a pair of gill-clefts. There is also a small tail-fin. The gills are lost before the larva emerges, when it at once makes its way into the

water, looking very much like a minute eel. After a somewhat prolonged aquatic existence the young Cæcilian loses its tail-fin, the gill-clefts close up, and other changes in structure take place. It then leaves the water, and spends the rest of its life as a burrowing terrestrial animal.

In certain Cæcilians which inhabit the Seychelles Islands (species of *Hypogeophis*) the free-living tadpole stage is eliminated from the life-history, as in some of the tailless Amphibians already described (see p. 440). As before, the female protects her eggs by coiling round them, and a tadpole stage is passed through

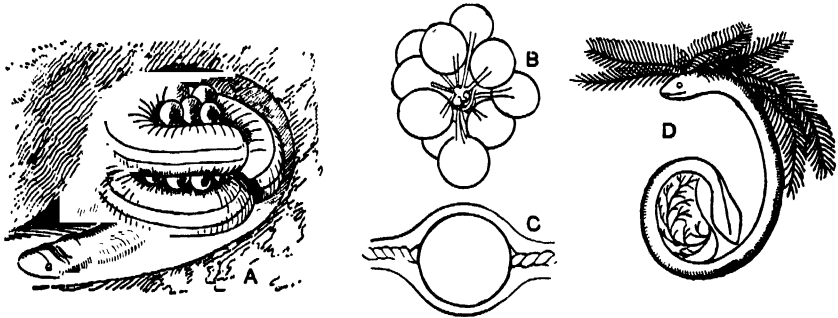

967.—Development of a Cæcilian (*Ichthyophis glutinosa*)

A, Female coiled round her eggs, reduced; B, bunch of eggs; C, an egg, enlarged, showing investing membrane and supporting strings; D, an advanced embryo, with external gills and remains of yolk-sac, enlarged.

before hatching, in which external gills and four pairs of gill-clefts are present, but no tail-fin. When the young animal leaves the egg it resembles the adult in appearance, for the gills have disappeared and the gill-clefts closed up. It at once takes to the burrowing mode of life.

In a large Cæcilian (*Typhlonectes compressicaudata*) which inhabits the northern part of South America, development is entirely internal, and the young when born closely resemble their parents. A tadpole stage with reduced gills is passed through before birth, but, so far as we know, this species spends the whole of its life burrowing in the ground.

LIFE-HISTORIES, &c., OF REPTILES (REPTILIA)

In the higher Vertebrates, including Reptiles, Birds, and Mammals, development is always direct, there being no larval form, though the young are sometimes in a rather embryonic state when they first make their appearance in the world.

Reptiles are for the most part oviparous, and their eggs contain a great deal of food-yolk. Protection is afforded by a tough or it may be calcareous shell. The group is not specially interesting in the present connection, but it will be worth while to briefly review the five orders in which all living species are included, *i.e.*—Tuataras (Rhynchocephala), Snakes (Ophidia), Lizards (Lacertilia), Turtles and Tortoises (Chelonia), and Crocodiles (Crocodiles).

TUATARAS (RHYNCHOCEPHALA).—The only living representative of this ancient and once extensive order is the Tuatara (*Hatteria punctata*) of New Zealand, which lives on some of the small islands in the Bay of Plenty. It digs a burrow in the ground, afterwards adding a lining of grass and other plants. This dwelling is not, however, used as a nest, a hole being scooped in the sand for the reception of the eggs, which thus have the benefit of the sun's heat. They are about ten in number, and closely resemble those of birds. The young hatch out some thirteen months afterwards, but the actual development only takes about half of this long period, the rest of the time being spent in a dormant condition.

SNAKES (OPHIDIA).—The large majority of these creatures lay soft-shelled eggs, which are commonly deposited in earth or among decaying vegetable matter, where the heat generated by the processes of fermentation accelerates the development, which is also furthered by the sun's warmth. Manure-heaps are much favoured for this purpose by our native Grass Snake (*Tropidonotus natrix*), as may be illustrated by the following extract from Frank Buckland (*Log-Book of a Fisherman and Zoologist*):—"Just as I had put the lizard into a bag, I heard the squire's voice signalling me from the distance. He apologized for my want of sport in my snaking expedition, but at the same time he delighted me by promising to guide me at once to a dung-heap, where it was reported that some snakes had laid their eggs. This dung-heap was situated in the middle of a yard where the cows lived in the winter, and was just the very place snakes would choose to lay their eggs. The keeper got a dung-fork, and diligently turned over the straw at the top, while the squire and I worked away at the sides of the dung-heap. . . . I was dreadfully afraid we should draw the dung-hill blank, but at last I gave a view holloa, when, underneath a bit of the straw, I saw something of a milk-white colour.

‘Avancez,’ I said, ‘go ahead; I’m certain that’s a snake’s nest.’ Lifting up the straw most carefully, I was delighted to find first one, then two, then a dozen eggs. The squire and I then proceeded to dissect out the nest with our pocket-knives and a dung-fork most carefully. Snakes’ eggs are not quite so large as a blackbird’s; they are round at both ends like a sugar-plum. They have no hard shell like a hen’s egg, but the shell is composed of a soft elastic substance, like thin wash-leather. Some eggs were lying quite separate. The greater part were, however, stuck firmly together, so tightly that it was almost impossible to tear them apart without breaking the skin. The eggs were not held by a ligature, but appeared pasted together by some strong adhesive gum, end on end. . . . The appearance of the eggs in this dung-heap, just as the parent snake or snakes had placed them, was so striking, that a gentleman, well-known for his artistic talent, took a sketch of the eggs and the nest. When the sketch was finished, I proceeded to examine the eggs more closely; there were sixty-four. I do not know from experience how many eggs the common snake lays, but I should say from twelve to twenty. It is, therefore, possible, even probable, that more than one snake had chosen the spot on the dung-hill to deposit their eggs. . . . The temperature of the spot where the eggs were deposited in the dung-heap was about 84 degrees in the sun, and the nest was buried about 18 inches deep on the southern aspect, as though the mother snake knew that that was the best place for the eggs.” The unhatched snake is provided with a small “egg-tooth” on the tip of its snout, which helps it to make its way into the world.

Parental affection is rarely exhibited by snakes, but the female Python coils her body round her batch of eggs by way of protection. Some few species, such as Vipers, including our native Adder (*Pelias berus*), are viviparous. So also are marine snakes, which come to land for the purpose of producing their young.

LIZARDS (LACERTILIA).—Most of these are oviparous, and deposit their hard or soft-shelled eggs after the fashion of Snakes. Here too, the young animal possesses a sharp “egg-tooth” (fig. 968) on the tip of its upper jaw, and this is best developed in cases where the egg-shells are hard and calcareous. The Common Iguana (*Iguana tuberculata*) of tropical America digs out a deep burrow on a sloping bank for the reception of her eggs, the Eyed Lizard (*Lacerta ocellata*) commonly selects a hollow tree for the

purpose, and the Spanish Sand-Lizard (*Psammodromus Hispanicus*) buries her eggs deeply in hot sand. Gadow (in *The Cambridge Natural History*) thus describes the nesting habits of the Common Chameleon (*Chamaeleo vulgaris*):—"When the eggs are ripe, and this happens with the Common Chameleon about the end of October, the female refuses to take food, and becomes restless. One of my specimens searched about probing the ground for about a week before she dug a hole in some more solid soil. This took two days. In the evening I found her sitting in the hole to the middle of her body. On the following morning she was still there, but busy filling the hole with soil and covering it with dry leaves. A few eggs were lying about outside, two of which at least I saw

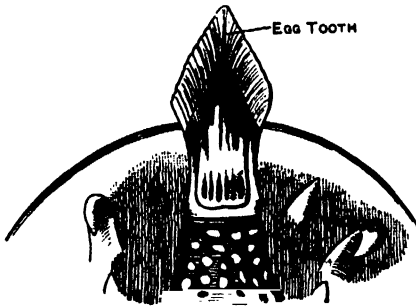

Fig. 968.—Tip of the upper jaw of embryo Lizard, showing Egg-tooth, enlarged

her taking up by the hand and putting them on the nest, which was found to contain some thirty soft-shelled eggs closely packed upon each other. During the whole process she was very snappy, and hissed much when approached."

Some Lizards are viviparous to all intents and purposes, for the eggs hatch out immediately after they are laid. This is the case with two British species, the Viviparous Lizard (*Zootoca vivipara*) and the Blind-Worm (*Anguis fragilis*).

TURTLES AND TORTOISES (CHELONIA).—All the members of this order are oviparous, and deposit their eggs in the ground. As in Lizards the shell may be either hard or simply tough, and there is a good deal of variation in shape. A typical instance is afforded by the European Pond Tortoise (*Emys orbicularis*), in which the female makes a hole in the ground, using first the tail and then the hind-limbs for the purpose. After depositing her eggs she replaces the earth, presses it down, and then scratches it with her claws, the object of this last procedure being to make the nest inconspicuous.

Even the thoroughly marine Turtles come to land for the purpose of egg-laying, regarding which habit in the Edible Turtle (*Chelone mydas*) Gadow makes the following remarks (in *The Cambridge Natural History*):—"The females come to their

breeding-places from afar, reconnoitre the beach carefully, are extremely wary and shy, taking alarm at the slightest disturbance, and at last crawl on land. Well out of the reach of the tide the female scoops out a hole in the sand, deposits about one hundred or more of its round, rather parchment-shelled eggs, covers the nest carefully, obliterating all traces of the dug-out sand, and makes again for the sea by another route. At least they are said to make a sort of circuitous route so that nobody can tell the position of the nest, which may be anywhere beneath the broad trail left by the heavy creature on its way from and back to the sea."

Tortoises sometimes construct definite homes for themselves, as in the case of the Gopher Tortoise (*Testudo polyphemus*), a native of the south-eastern part of North America. Each pair live in a rather long burrow, which expands internally into a sort of dwelling-chamber. The eggs are not deposited in this underground retreat, but a hole is dug for their reception in the immediate neighbourhood. They are of large size, and only five in number.

CROCODILES (CROCODILES).—All the species of the order are oviparous, and the females lay a considerable number of white eggs, covered with firm calcareous shells. Crocodiles and their kind are much more affectionate than any other reptilian mothers.

The Nile Crocodile (*Crocodilus Niloticus*) constructs a nest for her eggs by digging a fairly deep hole in the sand, the floor being larger than the external opening, and somewhat raised in the middle, so that the eggs roll away to the margin. They are from twenty to thirty in number, and are laid in two batches, with a layer of sand between. After all have been deposited the mother fills up the hole, and uses the spot as a sleeping-place, an obviously protective measure. At the end of about three months the young crocodiles hatch out, and they possess a well-developed "egg-tooth" which enables them to break the shell. When ready to make their exit they make a peculiar sound, which has been compared to a hiccough, and it is said that the mother, on hearing this, digs them out of the nest, and leads them to the water.

This Crocodile also makes a sort of lair by excavating a long burrow in the bank of its native river, the entrance being under water. The roof is ventilated by air-holes, and at the inner end there is a fairly large space, to which the animal is supposed to retreat with its prey for the purpose of enjoying a quiet meal.

The somewhat similar habits of the American Alligator (*Alligator Mississippiensis*) are thus described by S. F. Clarke (in *The Journal of Morphology*, 1891):—"The nest of the alligator is very large, and is built by the female. A great quantity of dead leaves and twigs, together with much of the finely-divided humus underlying them, is scraped together into a low mound about 3 feet high; this varies considerably in its other dimensions, being in some instances 8 feet in diameter at the base. The nests are built on the bank of a stream or pool, and the female digs a cave under water in the bank close to the nest. Careful examination of the largest nest found showed a root of a neighbouring palmetto-tree, nearly an inch in diameter, running through it at about a foot above the ground; there were also roots of a grape vine growing near, which extended nearly through the nest. This furnishes strong support to the statement of many of the hunters, that the nests are used for more than one season. I could get no evidence whatever that the nests are used more than once a year. The eggs are laid near the top of the nest, within 8 inches of the surface, are four or five layers deep, and have no regular arrangement or uniform position of their axes in relation to the nest. The number of eggs to a nest varies from twenty to thirty, and averages twenty-eight; the maximum found was forty-seven."

LIFE-HISTORIES, &c., OF BIRDS (AVES)

All Birds, without exception, lay hard-shelled eggs, and at the time of hatching the young are either helpless (*nidicolæ*), as in the House-Sparrow, or else, as in Fowls, able almost at once to run about and feed themselves (*nidifugæ*). The eggs vary greatly in number, size, and appearance, and are commonly, though by no means always, laid in specially constructed nests, the nature of which is even more diverse than their contents. One parent, or each in turn, usually broods over the eggs, thus supplying the heat which is necessary for development. The skin on the under side of an incubating bird is plentifully supplied with blood and sometimes is more or less bare; increased warmth is the result. Sometimes, however, there is no such incubation, and the requisite warmth is otherwise supplied. Parental affection is commonly very strong, especially in those cases where there are helpless nestlings, which would speedily die if not carefully tended.

GANNETS OR SOLAN GEESE (*Sula Bassana*)

This plate reproduces photographs taken by Mr. R. A. L. Van Someren at the Bass Rock, a well-known breeding-haunt of this bird. A general view of part of the rock is given at 1, showing Gannets and nests. Two of the latter are represented on a larger scale in 2, each of them containing a large white egg, while a brooding bird is seen in 3. An unfledged nestling, with feathers beginning to sprout, is shown in 4, and the loose, untidy character of the insanitary nest will be noted. It is very roughly made of bits of sea-weed, pieces of turf, grass haulms, and other available materials. The young Gannets are hatched out as blind, featherless, unattractive-looking creatures, but soon become clothed with a thick covering of pure white down. Later on this is succeeded by speckled brown and white plumage, which, after passing through several other stages, gives place to the almost entirely white attire of the adult. Gannets are not fully mature until they have attained the age of four or five years.



2

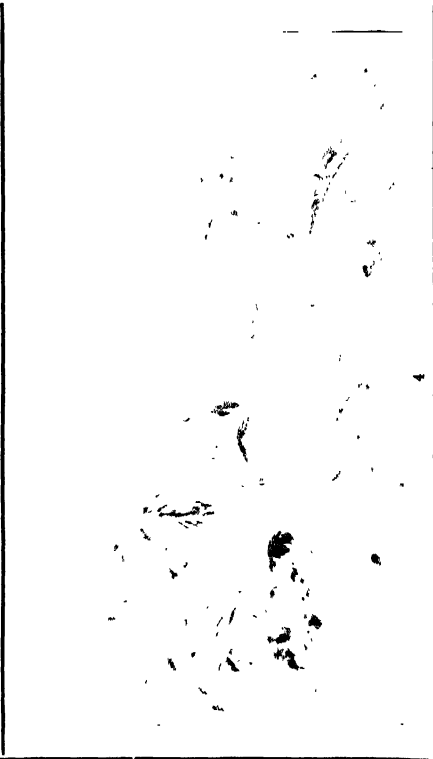

4



1

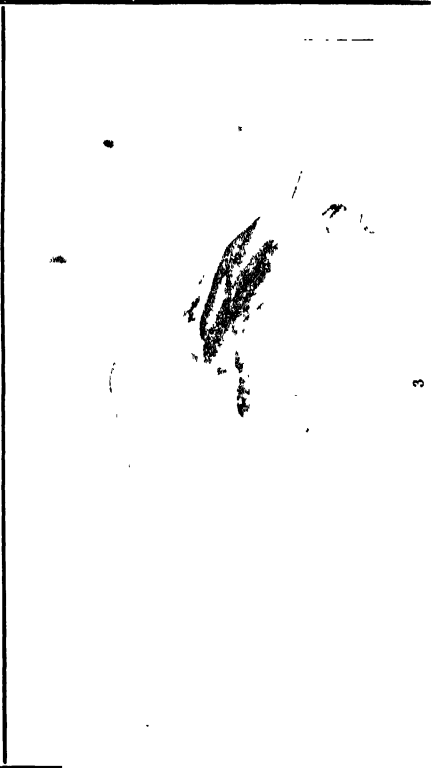

3

GANNETS OR SOLAN GEESE (SULA BASSANA)

The Common Cuckoo is a familiar example of the shirking of such domestic duties. The unhatched bird generally has a little hard knob on the tip of its beak, which helps it to break the shell.

The habits of Birds have proved a never-failing attraction to a very large number of observers, and so much is known about them that choice of material for the present section is very difficult. There is, however, plenty of room for careful scientific investigation, since the work of many so-called ornithologists is extremely superficial, and only to be defined as periodical birds-nesting, undertaken for the purpose of adding rare eggs to a useless and often overstocked collection.

It will be convenient to consider separately the Running Birds (Ratitæ), and Flying Birds (Carinatae).

RUNNING BIRDS (RATITÆ).—In all living species the male bird does most if not all of the work of incubation, and also looks after the chicks when they are hatched. African and American Ostriches are polygamous, but Cassowaries, Emeus, and Kiwis are associated in pairs.

The African Ostrich (*Struthio camelus*) has often been unjustly regarded as a reprehensibly careless parent, an opinion commonly based on the following statement in the Book of Job (xxxix, 14-16):—"Which leaveth her eggs in the earth, and warmeth them in dust, and forgetteth that the foot may crush them, or that the wild beast may break them. She is hardened against her young ones, as though they were not her's: her labour is in vain without fear." In this species the hens of one establishment scratch out a hole in the sand, within which they lay eggs to the number of over thirty, afterwards covering them over. Other eggs are deposited outside the nest, possibly to serve as the first food of the newly-hatched chicks. Incubation lasts for six or seven weeks, and is undertaken by the cock, his duties in this direction being chiefly performed at night. During the day sufficient warmth is supplied by the sun, though it is said that at this time both sexes in turn brood over the eggs in the cooler parts of the area inhabited. Parents and young live together for some time, the father jealously guarding his offspring, and adopting various stratagems for the purpose of luring away inquisitive visitors whose designs appear to him questionable.

The habits of the American Ostriches (*Rhea*) are much the same as those of their African cousins.

Cassowaries (*Casuarinus*) construct a careless nest of vegetation in a sheltered place, and the large eggs vary from three to six in number. They are of pale green colour, and usually rough from the presence of raised dark green spots. The plumage of the chicks is mottled.

The nest of the Emeu (*Dromæus Novæ-Hollandiæ*) is simply a shallow depression scraped out in the ground, and the roughened eggs are smaller and more numerous than those of Cassowaries. Their colour is usually blackish green. It is a common thing for young birds which are able to run about as soon as they are hatched to be protectively coloured, and this is well exemplified by Cassowary and Emeu chicks. Semon thus speaks of the latter (in *In the Australian Bush*):—"The young emeus are very different in colouring from the old birds. They are not of the modest grayish-brown of the latter, but bear a delicate design of a pretty dark gray with numerous stripes on their back and sides. A very similar design is to be seen in the young cassowaries. These stripes of the small birds fulfil a decidedly protective purpose. Young emeus are often pursued by the eagles and hawks so frequent in Australia. When (so my blacks told me) the young emeus see a bird of prey soaring above them they quickly lie down flat upon the ground. A body as big as theirs would surely be much more conspicuous, set off as it is by grass, if it were *evenly*, though ever so modestly coloured, than if its colouring be varied by stripes and spots. I myself have had occasion to notice how difficult it is to discover an emeu in the grass if it nestles to the ground. On an even level of sand its stripes would direct attention towards it, whereas here they render it inconspicuous." (Compare vol. ii, p. 285.)

The little Kiwis (*Apteryx*) of New Zealand have somewhat different nesting habits. The female digs a burrow which expands internally, and here places a thin layer of vegetation, on which she lays her remarkably large eggs. They are usually two in number, and of white or greenish colour.

FLYING BIRDS (CARINATÆ).—The order of Game Birds (Gallinæ) includes one family (*Megapodiidæ*) of which the members do not incubate their eggs, the requisite heat being furnished, as in the case of many reptiles, either by the sun or else by the fermentative processes which go on in decaying vegetation. Birds are undoubtedly of reptilian stock, and it may well be that we

have here an exceedingly ancient habit. The family is very characteristic of the Australian region, but ranges north to the Philippines, and west to the Moluccas. The simplest method adopted is to lay the eggs among rotting leaves, as in a New Hebrides species (*Megapodius Layardi*), or to dig a hole in the sand for their reception, as in a form (*M. eremita*) native to the Solomon and other islands. From this we pass to the "mound-building" species, of which a typical example is afforded by the Scrub-Turkey (*Catheturus* or *Talegallus Lathamii*), native to East Australia, of which the domestic arrangements are thus described by Semon (in *In the Australian Bush*):—"Within the scrubs one will look in vain for any bright colour, a sombre green reigning everywhere. The ground between the trees is almost bare of vegetation, strewed only with fallen trunks, dead branches, and fragments of plants. Here the 'scrub-turkey' . . . builds its nest by scraping together with its powerful claws great quantities of vegetable substance, mould, grass, leaves, branches, and mushrooms, out of which it builds an enormous mound of a flattish shape. The diameter of these mounds varies from 4 to 5 yards at their base, their height from $1\frac{1}{2}$ to 2 yards, so that the material they represent would make up several cart-loads. It is undecided as yet whether one pair or a whole party of birds combine to construct these mighty nests. The circumstance of one's occasionally finding more than thirty eggs buried in one mound leads me to suppose the latter. The eggs are laid into these hills at a depth of one or of half a yard, and are incubated by the warmth arising from fermentation of the rotting vegetable substances. The parent birds do not abandon their brood entirely during this process, but appear once or several times during the day to air their eggs. They examine whether the places they occupy have an appropriate temperature, or whether this has grown either too hot or too cool, and they help the chickens ready to slip out from the depths of this hatching oven. In these scrubs I was able to note the interesting fact that the birds began to build their mounds already in August, while the laying of eggs takes place only about Christmas-time. . . . The facts that the hills are so extensive, and the decay of material in the lower parts of the nest is already so far advanced when the laying of the eggs commences, has led to the conclusion that the same mound is employed several years successively, being fitted up every time by

the addition of new material. As to my own observations, the birds scrape together a new heap every year, as a rule, if not always. They, however, begin this work four or five months before laying the eggs, a provision which is very much to the purpose. For mighty erections of this sort, the material for which has to be carefully so gathered and chosen that the right temperature may develop in their interior, cannot be raised at a moment's

bidding. Plausible as this appears to ourselves, we must admire the wonderful instinct prompting the animals to make such preparation for eggs to be laid more than three months later." In New Guinea and North-east Australia the place of the Scrub-Turkey is taken by another mound-builder (*Megapodius tumulus*, fig. 969), of smaller size, the mounds of which may be as much as ten feet high, with a correspondingly large diameter. The

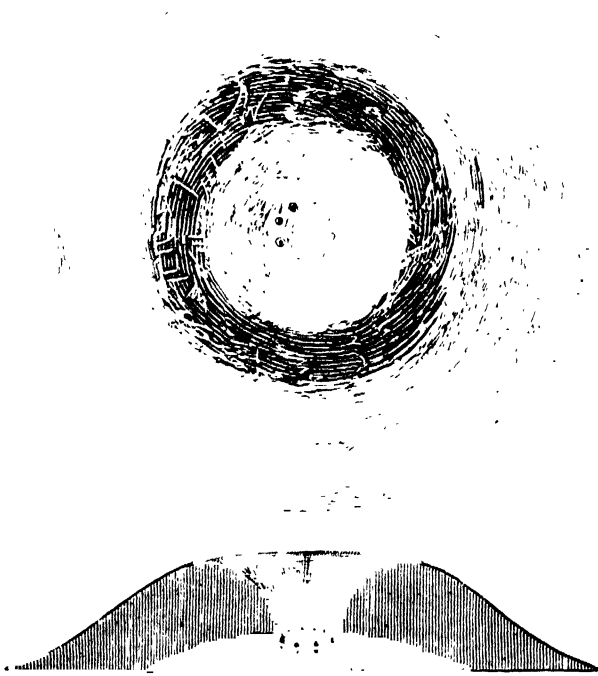

Fig. 969.—Mound of a Megapode (*Megapodius tumulus*), much reduced, as seen from above and in section

nest is largely made of sand, and Semon describes one he observed in Wednesday Island, which appeared to be constructed of this material only. He suggests that the greater heat of the sun in this warmer latitude renders the employment of vegetable matter unnecessary. The chicks of all these non-incubating birds emerge from the egg in a very perfect condition, and are soon able to fly.

The vast majority of flying birds incubate their eggs, the old reptilian plan having been superseded. This is one of many results which have followed from the successful solution of the

problem of separating the pure and impure blood in the circulation, a feat which reptiles have not yet accomplished. Hence the hot-bloodedness of birds, and the evolution of the incubatory habit.

Some birds make no nest at all, but simply lay their eggs in situations which are more or less exposed. The Common Guillemot (*Uria troile*), for example, lays her single egg on a ledge of rock or in a crevice, situated on a cliff or stack, the inaccessibility of which is a sufficient protection from most enemies, man excepted. The Common Tern (*Sterna fluviatilis*) lays two or three mottled eggs among shingle (fig. 970), and it will be seen from the illustration that it is scarcely possible to speak of a nest. The eggs are protectively coloured, as is usually the case when they are exposed to view, and by no means easy to detect. The Kentish Plover (*Ægialitis Cantiana*) affords another illustration of the same thing. Dixon (in *Among the Birds in Northern Shires*) says of the Nightjar or Goat-sucker (*Caprimulgus Europæus*):—"It makes no nest, but the hen bird lays her two curiously oval eggs on the bare ground, sometimes beneath a spray of bracken or a furze bush, less frequently on the flat low branch of a convenient tree. These eggs are very beautiful, and he who finds them cannot confuse them with those of any other species that breeds in our islands. They are generally white and glossy, the surface mottled, blotched, streaked and veined with various shades of brown and gray."

Fig. 970.—Eggs of the Common Tern (*Sterna fluviatilis*)

Many birds make a burrow or hole in which to nest, or take advantage of an existing cavity, and the eggs are white, which is the general rule where they are not exposed to view. The Sand Martin (*Cotile riparia*) tunnels out a long (up to nine feet) and fairly horizontal gallery on the side of a steep bank often overlooking a stream. The inner end of this is enlarged, and the four to six eggs laid upon a layer of grass and neatly-arranged feathers. The Kingfisher (*Alcedo ispida*) digs out an upwardly

slanting passage in an overhanging river-bank, and enlarges its end much after the fashion of a Sand-Martin. For a considerable time before laying this excavation is used for sleeping and feeding purposes, the result being an evil-smelling heap of fish-bones and other garbage upon which the six to eight pearly eggs are deposited. This has given rise to the erroneous idea that the bones are a special provision for the comfort(!) of the young. The beautiful Hoopoes are even more insanitary in their nesting-habits. The female lays her eggs in a hole in a tree or in rocks,



Fig. 971.—Nest of a Woodpecker, in section

and has sometimes been known to select a coffin or decomposing body for the purpose. A sort of lining is previously constructed of twigs, feathers, or hair, to which a liberal amount of filth is added. It is remarkable that the oil-gland of the nesting-female and also of the nestlings secretes an intolerably smelling fluid. This is perhaps a protective arrangement. The hen remains on this undesirable nest for practically the whole time of incubation, and is assiduously fed by her partner.

Woodpeckers either nest in a ready-made hollow, or dig out a suitable cavity in the trunk of a tree, working at first horizontally and then vertically downwards (fig. 971). The white eggs are deposited on a layer of chips. The Nuthatch (*Sitta cæsia*) generally selects a hole in a decaying branch for its nesting-place, into which dead leaves or thin flakes of bark are taken to serve as a bed. The opening of the cavity is plastered up with clay, leaving only a round hole to serve for entry and exit.

We next have to consider nests of various degrees of complexity constructed from sticks, twigs, moss, and other plant material, to which feathers, wool, or hairs are frequently added. Many of the most familiar of these rest upon some firm support, and are circular in shape, with no roof except that which the surroundings may provide. Such nests may be of extremely primitive character, as in the Peewit or Lapwing (*Vanellus cristatus*), and the Golden

Plover (*Charadrius pluvialis*), where it is simply a slight hollow in the ground, with a scanty lining of dry herbage. Many sea-birds heap together such materials as are available into a somewhat rough nest, without any special attempt at concealment, as the inaccessible position gives a reasonable amount of security. Unfortunately the perverse ingenuity of man is difficult to baffle, and he is not the only egg-collector. Jackdaws, for example, are described by Dixon as making regular plundering expeditions around the Bass Rock, transfixing eggs with their beaks, and thus carrying them off to serve as food. The most prominent sea-bird in this famous spot is of course the Gannet or Solan Goose (*Sula*

Bassana), and it is computed that not less than twelve thousand adult birds of this species find nesting-places there. The domestic arrangements are thus described by Dixon (in *Among the Birds in Northern Shires*)—"The nests are made almost anywhere—

at the top of the cliffs amidst the broken rocks and crags, lower down the cliffs where any ordinary climber can reach them, and, most numerous of all, on the ledges far below which are only accessible with the aid of a rope. To say the least, the nest is not a very attractive

one; it is often trodden out of all semblance to such a structure, and frequently covered with droppings and slime, whilst around it are dead and decaying fish, many of them disgorged when partly digested. The hot sun soon completes the work of decomposition, and generates a fearsome stench which it requires all the fortitude



Fig. 972.—Young Kittiwake (*Rissa tridactyla*)
on Nest



Fig. 973.—Nest of Skylark (*Alauda arvensis*)

of an enthusiastic ornithologist to tolerate. The nests are made of sea-weed, turf, straws, and scraps of moss, the soil from the turf being trampled into a mortar-like mass and binding the whole together. In a shallow cavity at the top of this cone-like structure a single egg is laid, originally white and coated thickly with lime, but soon becoming stained into a rich brown from contact with the big webbed feet of the parent birds. Numbers of nests in some spots are crowded together, often so closely that the cliff is literally white with sitting birds." The nest of our smallest native gull, the Kittiwake (*Rissa tridactyla*)

Fig. 974.—Nest of Coot (*Fulica atra*)

is a massive structure of similar kind (fig. 972). The illustration shows a young bird on the nest, as photographed by Mr. Van Someren at the Bass Rock.

Some birds build fairly well constructed nests in sheltered spots on or near the ground, as in the Skylark (*Alauda arvensis*, fig. 973), where dried grass, herbs, moss, and a little hair are used for the purpose. The Coot (*Fulica atra*, fig. 974) constructs a bulky nest of sedges, rushes, or

flags, among the vegetation of its native stream. The illustration shows part of a sort of "road" trodden down by the birds in going to and from the nest. Sometimes this home is a floating one, as

Fig. 975.—White Swan (*Cygnus olor*) building a floating Nest

is regularly the case with the Little Grebe or Dabchick (*Podiceps flavriatilis*), which employs similar materials. The White Swan (*Cygnus olor*) frequently constructs a large floating nest of sticks and straw, though it often prefers an islet, when one is available. The former state of things is illustrated by fig. 975, taken at Duddingstone Loch, near Edinburgh, and showing building operations in progress.

The cup-shaped nests of many common species built in various situations near the ground are more carefully finished than the domestic arrangements so far described. That of a Grey Wagtail (*Motacilla melanope*), shown in fig. 976, was built in a wall on the Pentlands. On this species Dixon (in *Among the Birds in Northern Shires*) makes the following remarks:—"Not every wanderer by the water-side is fortunate enough to get a peep at this bird's domestic arrangements. It has, fortunately perhaps, a happy way of concealing its nest under some large stone or overhanging rock, not necessarily in a secluded spot, but often close by the wayside, where the very audacity of the selection proves a source of safety. A scrappy little nest it is, dry grass and roots and such like litter thrown carelessly together, and lined with hair, or more rarely a few feathers; artless, yet possessing a rustic beauty if wanting that elaborate finish of more painstaking nest-builders. The five or six eggs are as unassuming as the nest that holds them, grayish-white freckled with brown, and perhaps with here and there a scratch of darker hue. . . . This pretty wagtail still further endears



Fig. 976.—Nest of Grey Wagtail (*Motacilla melanope*)



Fig. 977.—Nest of Common Thrush (*Turdus musicus*)

itself to us by its attachment to a certain breeding-place, returning in many cases year by year to build its nest in one particular

spot." A much neater nest is constructed in a hedge or bush by the Common Thrush, (*Turdus musicus*, fig. 977), grass being the chief building material, while mud is used as a cement. An inner layer of finer material is added, and the whole is completed by a lining of cow-dung, decayed wood, or mud.

Fig. 978.—Nest of Wood-Pigeon (*Columba palumbus*)

We have next to consider nests made of sticks or fibres, and placed in trees or other precarious situations, often in such a way

as to necessitate very considerable constructive skill. One of the least elaborate is the loose stick-nest of the Wood - Pigeon (*Columba palumbus*, fig. 978), through the crevices in which the two eggs can easily be seen from below. Contrary to the usual rule these are white in colour, and it has been suggested that they are thus rendered less conspicuous when seen from below against the bright sky.

Much more elegant are the deep woven nests of the Reed Warbler (*Acrocephalus streperus*) and Great Reed



Fig. 979.—Nest of Great Reed Warbler (*Acrocephalus arundinaceus*)

Warbler (*A. arundinaceus*, fig. 979), constructed of vegetable fibre, while moss, wool, feathers, and hair serve as materials for lining. It will be seen from the illustration how cleverly the stems of

reeds are used as a support. Many woven nests are roofed over, and have an opening at the side, as in the case of the Long-tailed Tit (*Acredula caudata*), which has a more elaborate home than any other British bird. Compared to the owner it is of large dimensions, and ovoid in shape. Moss, wool, and cobwebs are the chief materials used, all carefully interwoven. The outside is studded with bits of lichen, while the inside is lined with hair and feathers. One observer had the curiosity to count the number of the latter embodied in a single nest and made a total of 2379, so that this item only must involve an enormous amount of patient labour. When the parents are "not at home" the aperture is said to be closed by a feather. Some of the glands of the mouth secrete a sticky fluid, which is of importance in softening and working up the material used in neat and elaborate nests like this one; cobwebs, too, prove useful as an adhesive. The Penduline Tit (*Ægithalus pendulinus*, fig. 980) of South Europe constructs an equally elaborate hanging nest, which is entered by a sort of passage, that has suggested comparison with a bottle, though a better simile would be afforded by a short-necked retort.



Fig. 980.—Penduline Tit (*Ægithalus pendulinus*) and Nest

The Indian Tailor-Bird (*Orthotomus sutorius*, fig. 981) constructs a hanging nest with extraordinary ingenuity, by sewing together a couple of long leaves into a sort of funnel, within which a soft bed of cotton is placed for the reception of the eggs. The sewing material is made of cotton, and sometimes, at least, is twisted by the bird itself, which is also credited with making a knot for the usual purpose. The Fan-tail Warbler (*Cisticola cursitans*) of South Europe builds a globular nest

among grass, and makes a sort of awning by sewing together the leaves and stems above it. This bird too is said to make a knot at the end of its thread.

The nests of a good many birds are plastic structures made from earth or clay, with which bits of other material may be mixed. That of the Common Fla-



Fig. 981.—Nest and Young of Tailor-Bird
(*Orthotomus sutorius*)

mingo (*Phœnicopterus roseus*, fig. 982) is built on the ground, and shaped like a broadly truncated cone, upon which the bird sits with its long legs folded up in an uncomfortable-looking position. Chapman and Buck (in *Wild Spain*) give the following interesting description:—"On reaching the spot we found a perfect mass of nests. The low, flat mud plateau was crowded with them as thickly as its space permitted. These nests had little or no height above the flat surface of the mud—some were raised an inch or two, a few might be five or six inches in height; but the majority were merely circular bulwarks of mud barely raised above the general level, and having the impression of the bird's legs distinctly marked upon them. The general aspect of the plateau was not unlike a large table covered with plates. In the centre was a deep hole full of muddy water, which, from the gouged appearance of its sides, appeared to be used as a reservoir for nest-making materials.

Scattered all round this main colony were numerous single nests, rising out of the water and evidently built up from the bottom. Here and there two or three of these were joined together—'semi-detached', so to speak: these separate nests stood six or eight inches above water-level, and as the depth was rather over a foot, the total height of the nests would be some two feet or thereabouts, and their width across the hollow top some fifteen inches."

Most persons are familiar with the little clay nests of the Common Swallow (*Hirundo rustica*), commonly built against a wall immediately under the eaves, and comparable in shape to half a saucer. Their construction involves much labour, for the material has to be brought in the bill in successive pellets. Consistency is given by bits of straw or stick, while in this and similar cases the sticky secretion of the mouth is probably of importance by way of cement. A lining of feathers



Fig. 982.—Brooding Flamingo (*Phaenicopterus roseus*)

is added. The nest of the House-Martin (*Cheidon urbica*) is made of similar materials, but roofed over.

The Oven-Birds (species of *Furnarius*, fig. 983) of South America build on the branches of trees, their clay nests having

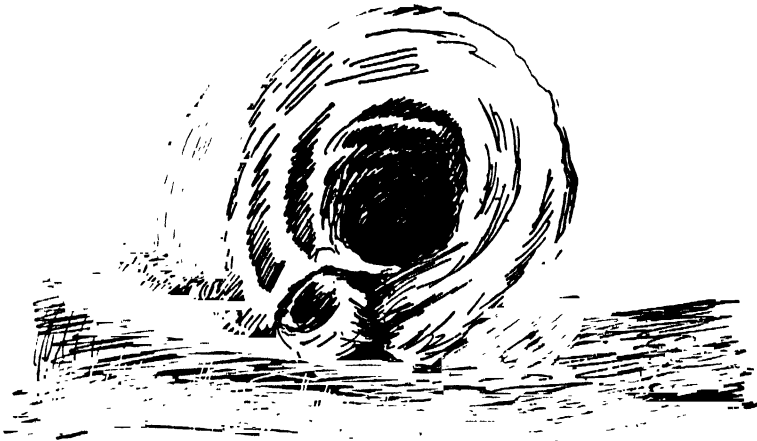

Fig. 983.—Nest of an Oven-Bird (*Furnarius*)

the shape which has suggested the popular name. A partition runs from back to front, dividing a cavity in which the eggs are contained from a sort of ante-chamber that communicates with the exterior.

The glands of the mouth, which are so often of importance in nest-building on account of their sticky secretion, are particularly well-developed in Swifts (*Cypselidae*), birds which are often erroneously mistaken for Swallows. In our Common Swift (*Cypselus apus*) this secretion is used to glue straw, dry grass, and the like, into a flattish nest, which is built in some hole or cranny. A lining of feathers is added. A kind of Swift (*Panyptila Sancti Hieronymi*) native to Guatemala glues seeds together



Fig. 984.—Edible Nests of Collocalia

into a long hanging nest, shaped something like a knobbed walking-stick. The entrance is at the lower end, and the eggs are lodged in the "knob" at the top. Perhaps the most remarkable of all bird's nests, so far as the building material is concerned, are those which the Chinese prize as an article of diet. They are constructed by certain Swifts (species of *Collocalia*, fig. 984) which range from Madagascar eastwards to the Marquesas Islands. In form they resemble those of the Swallow, but are entirely composed of the sticky fluid secreted by the glands of the mouth, with an occasional admixture of other substances. They are mostly to be found in caves.

The majority of birds do not associate for nesting purposes, though a very large number are social in this respect, and several examples have already been described. Among British species Rooks, Herons, and Fieldfares may be added to the list. The most extraordinary instance of this kind is afforded by the Sociable Grosbeak (*Philhetærus socius*, fig. 985) of South Africa. By the combined efforts of a large number of these birds a huge structure resembling the top of a mushroom is built round a tree,

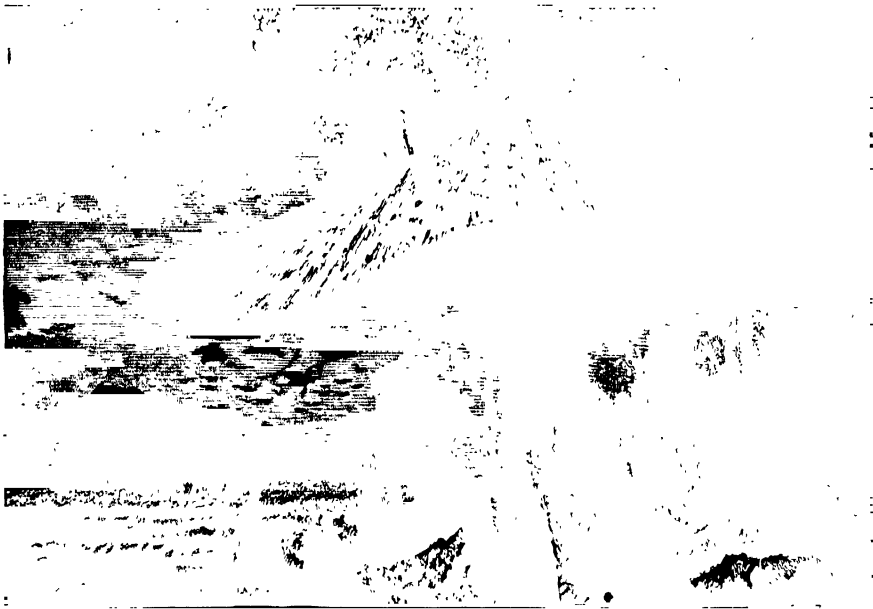

Fig. 985.—Nest of Sociable Grosbeak (*Philhetærus socius*)

grass being the material employed. It consists of from 100 to over 300 associated nests.

Related species not infrequently differ greatly as regards their nesting-habits, the most remarkable case being that of the South American Tree-Creepers or Picucules (*Dendrocolaptidæ*), which include the Oven-Birds already noticed. These Tree-Creepers differ remarkably among themselves in appearance and structure, as the result of adaptation to various modes of life. And that they provide for the welfare of their eggs in widely different ways will be obvious from the following account given by Hudson (in *The Naturalist in La Plata*):—“In the nesting habits the diversity is greatest. Some ground species excavate in the earth like kingfishers, only with greater skill, making cylindrical

burrows often four to five feet deep, and terminating in a round chamber. Others build a massive oven-shaped structure of clay on a branch or other elevated site. Many of those that creep on trees nest in holes in the wood. The marsh-frequenting kinds attach spherical or oval domed nests to the reeds; and in some cases woven grass and clay are so ingeniously combined that the structure, while light as a basket, is perfectly impervious to the wet and practically indestructible. The most curious nests, however, are the large stick structures on trees and bushes, in the building and repairing of which the birds are in many cases employed more or less constantly all the year round. These stick nests vary greatly in form, size, and in other respects. Some have a spiral passage-way leading from the entrance to the nest cavity, and the cavity is in many cases only large enough to accommodate the bird; but in the gigantic structure of *Homoris gutturalis* it is so large that, if the upper half of the nest or dome were removed, a condor could comfortably hatch her eggs and rear her young in it. The nest is spherical. The allied *Homoris lophotis* builds a nest equally large, but with a small cavity for the eggs inside, and outwardly resembling a gigantic powder-flask, lying horizontally among the lower branches of a spreading tree. *Pracellodomus sibilatrix*, a bird in size like the English house-sparrow, also makes a huge nest, and places it on the twigs at the terminal end of a horizontal branch from twelve to fifteen feet above the ground; but when finished, the weight of the structure bears down the branch-end to within one or two feet of the surface. . . . *Synallaxis phryganophila* makes a stick nest about a foot in depth, and from the top a tubular passage, formed of slender twigs intertwined, runs down the entire length of the nest, like a rain-pipe on the wall of a house, and then becoming external, slopes upwards, ending at a distance of two to three feet from the nest." It must not be supposed that in this family the species of the same genus necessarily build in the same way. For example the Oven-Birds (*Furnarius*) are so named on account of the shape of the clay nests constructed by three species, but another species makes a stick nest, and still another lays its eggs in a burrow.

A nest having been constructed, both parents take part in the care of eggs and young. Probably in the majority of cases incubation is entirely or mostly performed by the mother, though

the father may take his turn in brooding over the eggs, as in some Woodpeckers. More rarely, as in some of the Plover kind, the relations appear to be reversed, reminding us of what happens in the case of the Running Birds. Dixon thus speaks of the Dotterel (*Eudromias morinellus*, fig. 986) in this connection (in *Among the Birds in Northern Shires*):—"The Dotterel is one of the very few species in which the hen bird is larger and more brightly coloured than the cock, and the latter con-

Fig. 986.—Female Dotterel (*Eudromias morinellus*)

sequently incubates the eggs and takes the greater share in the task of rearing the young. The hen is even said to take the initiative in courtship, but we have yet to learn that the 'new woman' has quoted the fact in support of her advanced opinions! But then the Dotterel is widely known by the accompanying and preceding epithet of 'foolish', and its English name is said to be the diminutive of 'Dolt'; while its Latin name of *morinellus* is said by some to have been derived from *morus*, a fool—facts which those interested in so-called 'sex-problems' will also do well to bear in mind."

When the mother bird displays great devotion to the task of incubation, brooding on her eggs for long periods, she is diligently fed by her mate, as in the case of Hoopoes (see p. 454). The

habits of some at least of the Hornbills (*Bucerotidae*) are very remarkable in this respect. These birds range from Africa through South Asia into the East Indies. Evans thus summarizes what is known of the nesting habits (in *The Cambridge Natural History*):—"A hole in a tree or a cavity at the junction of two branches serves for the nest, wherein the hen is enclosed by a plaster of dung or like material; there, under penalty of death, she remains until she emerges, dirty, wasted, and enfeebled, when the brood is hatched. From one to four 'dingy' white eggs with coarse pores are deposited upon the debris or a few feathers. Contrary to expectation, observations seem to show that the female walls herself in; but, however that may be, the cock feeds her through the small opening left, and is even said to knock with his bill to attract her attention as he clings to the bark. He shows great anxiety about his charge, and the hen screams and bites if molested."

The parental task of birds is by no means over when their eggs have hatched out, for the young are fed with anxious care, and jealously guarded from enemies. This is, of course, especially necessary when the nestlings are helpless. The devotion of birds to their offspring is well known, and they are often quite regardless of personal danger when the welfare of the brood is in question (fig. 987). Gilbert White (in *The Natural History of Selborne*) thus speaks in his own inimitable way of the solicitude which birds display for their young:—"This affection sublimes the passions, quickens the invention, and sharpens the sagacity of the brute creation. Thus a hen, just become a mother, is no longer that placid bird she used to be, but with feathers standing on end, wings hovering, and clocking note, she runs about like one possessed. Dams will throw themselves in the way of the greatest danger in order to avert it from their progeny. Thus a partridge will tumble along before a sportsman in order to draw away the dogs from her helpless covey. In the time of nidification the most feeble birds will assault the most rapacious. All the *Hirundines* [*i.e.* birds of the Swallow kind] of a village are up in arms at the sight of a hawk, whom they will persecute till he leaves that district. A very exact observer has often remarked that a pair of ravens nesting in the rock of Gibraltar would suffer no vulture or eagle to rest near their station, but

would drive them from the hill with an amazing fury; even the blue thrush at the season of breeding would dart out from the clefts of the rocks to chase away the kestrel or the sparrowhawk. If you stand near the nest of a bird that has young, she will not be induced to betray them by an inadvertent fondness, but will wait about at a distance with meat in her mouth for an hour together." The same naturalist describes as follows the way



Fig. 987. — Wild Duck defending her Brood against a Brown Rat

in which the House-Martin (*Chelidon urbica*) feeds its young in their later stages:—"As the young of small birds presently arrive at their . . . full growth, they soon become impatient of confinement, and sit all day with their heads out at the orifice, where the dams, by clinging to the nest, supply them with food from morning to night. For a time the young are fed on the wing by their parents; but the feat is done by so quick and almost imperceptible a flight that a person must have attended very exactly to their motions before he would be able to perceive it." White also observed young Swallows (*Hirundo*

rustica) being fed on the wing, and says:—"In a day^u or two more they become *flyers*, but are still unable to take their own food; therefore they play about near the place where the dams are hawking for flies; and, when a mouthful is collected, at a certain signal given, the dam and the nestling advance, rising towards each other, and meeting at an angle, the young one all the while uttering such a little quick note of gratitude and complacency, that a person must have paid very little regard to the wonders of Nature that has not often remarked this feat." It must be added to these extracts that both in the Swallow and the House-Martin the father performs his full share of the arduous work of feeding the young.

R. and C. Kear-ton of recent years have made many remarkable photographs of bird-life, and by means of artificial rubbish-heaps and other ingenious devices have been able to hide them-

Fig. 988.—Skylark (*Alauda arvensis*) at her Nest

selves sufficiently near to the nests of a number of familiar forms to observe all the details of their domestic economy. The following passage (from *Wild Life at Home*) vividly describes the way in which a particular mother Skylark (*Alauda arvensis*) fed and tended her young (fig. 988):—"In a few minutes along came the lark, and hovering over her chicks for a few seconds, like a toy-bird suspended on the end of a bit of elastic, called to them in twittering notes, at which signal of her presence they all shot up their heads and opened their orange-coloured mouths ridiculously wide. She quickly alighted, and running up, gave each a small worm, which she appeared to fetch from the back of her throat. Generally, one of the worms which she brought was visible in her bill, but this was by no means always the case. When she had distributed her supply of food she waited for a moment, and then, thrusting her head into the depths of the nest, attended to its sanitary arrangements

and flew away. . . . She heralded her return every time by a twittering call that was answered by her offspring, which she fed on an average once every quarter of an hour. . . . She did not appear to receive the slightest assistance from her mate, although I must say he sang very blithely over our heads on several occasions." All bird fathers, however, are not so careless as the Skylark, for in this same book we find the statement:— "A closer study of the domestic life of birds by means of our hiding appliances has resulted in the discovery that the males of many species share family cares to a far greater extent than I ever supposed. One day I erected our rubbish-heap close to a chaffinch's nest containing a brood of five half-grown young ones, and took up my station inside. The male bird fed the chicks four times for the female's once, and when he had distributed his harvest of caterpillars most impartially amongst his clamorous sons and daughters he attended to the sanitary requirements of his little establishment"



Fig. 989.—Cock Chaffinch (*Fringilla caelebs*) at Nest

(fig. 989). The frontispiece to the work from which the two last quotations are taken is a particularly charming picture of a male Bearded Tit feeding his young.

In many vegetarian birds the food of the adult is unsuitable for the young brood, and this is especially the case with some of the finch kind, which largely subsist on hard seeds and the like. There is more than one way of getting over this difficulty. The adult House-Sparrow (*Passer domesticus*, fig. 990), for example, lives chiefly on various plant parts, but feeds its young on worms, grubs, caterpillars, and other small creatures.

This is also true of the Tree-Sparrow (*P. montanus*). During the nesting season the Chaffinch (*Fringilla cœlebs*) abandons its diet of seeds and berries in favour of animal food, devoting

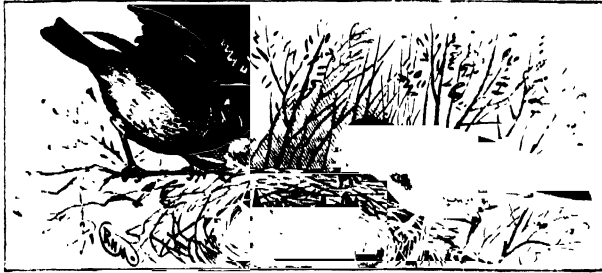

Fig. 990.—House-Sparrows (*Passer domesticus*) feeding their Young

special attention to the little caterpillars found in buds and flowers, which are also adapted to the tender digestions of the nestlings. Linnets (*Linaria cannabina*, fig. 991) are consistent vegetarians, but the seeds and other vegetable matters, with



Fig. 991.—A Nest of Linnets (*Linaria cannabina*)

which the young are fed, first undergo a softening process in the crops of the parents. A curious adaptation for the benefit of the young is found in Pigeons, which produce a special sort of "infants' food" popularly known as "pigeons' milk". This is not, however, a secretion, but consists of curd-like flakes

derived from the lining of the crop, which undergoes rapid growth during the nesting season.

When the young bird is fed from the crop it sometimes makes the operation more easy by thrusting its head into the mouth of its parent, as in the case of the Black Cormorant (*Phalacrocorax carbo*, fig. 992).

The sanitation of the nest is sometimes entirely neglected, as in Gannets and Kingfishers, necessarily so in the case of Hornbills (see p. 466). But in probably the majority of birds it is attended to by the parents with scrupulous care, as will have been gathered from the accounts already given of the Skylark and Chaffinch. Sometimes, as in the House-Martin, the old birds teach the young ones how to avoid fouling the nest.

Young birds which may almost be said to run from the egg are usually protectively coloured, and crouch when alarmed, as already described for the

Emeu (see p. 450) and, in an earlier section, for some of the Plovers (see vol. ii, p. 285). Apparently the first case of the kind to attract observation was that of the Stone-Curlew (*Œdicnemus scolopax*), described, so long ago as 1768, by Gilbert White (in *The Natural History of Selborne*):—"The history of the stone-curlew . . . is as follows. It lays its eggs, usually two, never more than three, on the bare ground, without any nest, in the field; so that the countryman, in stirring his fallows, often destroys them. The young run immediately from the egg like partridges, &c., and are withdrawn to some flinty field by the dam, where they skulk among the stones, which are their best security; for their feathers are so exactly of the colour of our grey-spotted flints, that the most exact observer, unless he catches the eye of the young bird, may be deluded." Another familiar example is that



Fig. 992.—Black Cormorant (*Phalacrocorax carbo*) feeding its Young

of the Peewit or Lapwing (*Vanellus cristatus*, fig. 993), the chicks of which are exceedingly difficult to find, and when accidentally discovered are apt to disappear in the twinkling of an eye. The parent birds are adepts in the art of deceiving inquisitive strangers as to the exact whereabouts of their eggs or brood.

Remarkable arrangements exist for the safety of the young in a primitive South American bird, the Hoatzin (*Opisthocomus*),



Fig. 993.—Female Lapwing (*Vanellus cristatus*) and Young

which appears to be a distant relative of the Game-Birds (*Gallinae*). Of these Headley gives the following interesting account (in *The Structure and Life of Birds*):—"Apparently about as large as a rather under-sized pheasant, the Hoatzin is really considerably smaller; his long tail, his large wings, and his crest suggest a larger bulk of body than he really possesses. . . . Among the trees and bushes that form a jungle-growth along the banks of the Berbice, and often overhang its waters, Hoatzins are plentiful. When a boat passes they will generally remain concealed among the leaves. . . . The nest is formed of a few sticks intertwined. When the birds' nester comes, cutting a way for his boat through the bushes, or wading thigh-deep through the mud, the old bird makes off upon the

wing. The nestling, unless very recently hatched, crawls off on all-fours, making much use of not only his enormous feet, but of the great claws that grow at the ends of the two first digits of his hand (fig. 994). If you try to pull him from the nest by the legs, he holds fast by means of these wing-claws and his beak. Often a young bird may be found clawing his way onward some distance from the nest. If he tumbles into the water he proves to be a born swimmer and diver. . . . In the nestling Hoatzin the hand is longer than the forearm; gradually it grows shorter, while the other parts of the wing

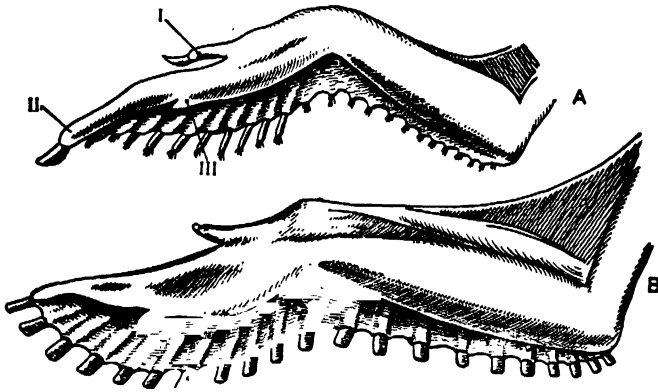

Fig. 994.—Wings of Young (A) and Adult (B) Hoatzin (*Opisthocomus*). The quills of the latter have been cut short. I, II, III, digits.

lengthen, till, in the fledged bird, the forearm surpasses it (fig. 994). The feathers, too, adapt themselves to changing circumstances; in the nestling the growth of the two outermost primaries is completely arrested, so that the use of the claws may not be impeded; when it is fledged and can fly, they begin again to grow and attain their full length. With maturity, too, the claw on digit No. 1 grows small, while that on No. 2 is lost altogether."

Before leaving Birds it may be well to remark that in the early history of the group precocious young were no doubt the rule, and it is interesting to note that they are characteristic of many species in which the organization is relatively low. The associated evolution of greater intelligence and increased parental affection is apparently responsible for the appearance of helpless nestlings. And we can only suppose that these have, on the whole, a better chance of surviving the struggle for existence than young birds which are soon able to take care

of themselves, though this chance entirely depends upon the devotion of their progenitors. Such a conclusion is strengthened by a study of Mammals, the highest group of Vertebrates in many respects.

LIFE-HISTORIES, &c., OF MAMMALS (MAMMALIA) .

Mammals agree with Birds in being of reptilian origin, and like them are hot-blooded, as a result of the perfect adaptation of their organs of circulation to air-breathing (see vol. ii, p. 426). The geological record shows us that Amphibians were the first backboned animals to become fitted for a life on land, where, in the absence of more specialized competitors, they were long dominant. But the evolution of Reptiles, still better suited to terrestrial life, deprived them of their supremacy, and these in their turn have been superseded by Birds and Mammals. Amphibians and Reptiles are still handicapped by the inheritance from fish-like ancestors of circulatory organs originally evolved in the interests of gill-breathing, and in none of them are these organs fully adapted to life on land. But Birds and Mammals, having finally overcome this initial difficulty, are thereby profoundly influenced in many ways. Increased energy and increased intelligence have resulted among other things, one manifestation of the latter being found in a remarkable solicitude for the welfare of their young, which is a factor of the first importance in the struggle for existence. Insects alone afford a parallel, and it is especially interesting to note that in them also the arrangements whereby the blood is purified are highly efficient, though very different in nature from those existing in land Vertebrates (see vol. ii, p. 437).

Birds, of course, are dominant in the realms of air, Bats alone among Mammals entering into competition with them. The fact that we ourselves belong to the Mammalia is enough to justify us in describing that class as the dominant one on land, though Birds flourish exceedingly, and there is still abundant foothold for both Reptiles and Amphibia. The prominent position which Mammals now occupy is largely bound up with two features in their life-history. One is the possession of milk-glands for the benefit of their young, and the other is the viviparous or internal development by which the vast majority

of them are characterized. In both respects they contrast markedly with Birds, and have a decided advantage over them. For, given parents able to defend themselves, the sheltered nature of viviparous development increases the chance of survival, and feeding the young on milk is a simpler matter than collecting suitable nutriment for them, as so many birds have to do, with expenditure of an enormous amount of energy.

The three great groups of Mammals, beginning with the lowest, are: Egg-laying Mammals (Prototheria), Pouched Mammals (Metatheria), and Higher Mammals (Eutheria). By successively reviewing these we shall obtain some idea of what has taken place in the evolution of the class.

EGG-LAYING MAMMALS (PROTOTHERIA).—The one family (*Monotremata*) included in this group contains only the Duck-Bill or Duck-Billed Platypus (*Ornithorhynchus*) and the Spiny Ant-Eaters (*Echidna* and *Proëchidna*) of the Australian region. There can be no doubt that Australia was at one time continuous with the mainland mass of the Old World, but became isolated before any of the higher Mammals migrated into it, owing to which fortunate circumstance the lower members of the class have been able to maintain themselves there, in the absence of serious competition. Duck-Bills and Spiny Ant-Eaters alike are of comparatively lowly structure, and possess many reptilian characters, one of the most remarkable being that they lay large tough-shelled eggs containing a great deal of food-yolk, serving as a store of food for the developing embryo.

The domestic economy of the best-known species of Spiny Ant-Eater (*Echidna aculeata*) has of late years been the subject of careful study, and is of unusual interest. The milk-glands which distinguish Mammals from all other creatures almost always have teats, from which circumstance, indeed, the name of the class is derived (L. *mamma*, a teat). The Spiny Ant-Eater does not possess these, although it has two milk-glands, differing, however, in nature from those of other Mammals, the allied Duck-Bill excepted. It commonly happens that when "new" organs make their appearance they are in reality "old" structures which have undertaken new work, and been correspondingly modified (see vol. ii, p. 421). This appears to be the case with milk-glands. We find in the skins of various Mammals two important varieties of glandular structures, one



Fig 995 - Female Spiny Ant-Eater (*Echidna*), reduced. A, under surface, showing pouch; B, dissection (from above), showing pouch, and two bunches of milk-glands opening into it.

for the secretion of sweat, the other for producing a greasy substance that acts as a sort of natural pomade. It appears that the milk-glands of Spiny Ant-eaters and Duck-Bills have

been derived from the former (sweat-glands), those of other Mammals from the latter (sebaceous glands).

During the egg-laying season a sort of pouch develops on the under side of the Spiny Ant-eater, into which the milk-glands open (fig. 995). To this the single egg (about $\frac{3}{8}$ inch long) is transferred by the mother, by means of her snout. After a short incubation the young animal breaks through the egg shell with the aid of a little knob on its nose, something like that present in a young bird, and the mother is also said to give assistance. The little creature is entirely devoid of hair and not much like the adult (fig. 996). It is sheltered

in the pouch till about three inches long, and feeds by licking up the milk which is secreted. The preceding facts are chiefly due to the investigations of Semon, who gives the following account of subsequent events (in *In the Australian Bush*):—"From the middle of October



Fig. 996.—Pouch (c, in section), bunch of milk-glands (a), and Pouch-Embryo (e) of Spiny Ant-Eater (*Echidna*). The openings of the glands into the pouch are shown.

my blacks found several such older specimens outside the maternal pouch in little hollows of the ground. . . . The blacks all told me that the 'old woman' (as the natives call the mother animal) during the first weeks often returns to the young one to take it into her pouch and suckle it. On entering upon her nightly rambles, however, she deposits her weighty and inconvenient youngster, digging a little burrow for it, where she stows it away until her return from her roamings. I was able to substantiate this account. . . ." The very intimate relation between mother and offspring which suckling entails has probably played an important part in the evolution of the pronounced maternal affection for which Mammals are remarkable.

The aquatic Duck-Bill (*Ornithorhynchus*) digs out a burrow of from 20 to 50 feet in length, the inner end of which is enlarged, much as in the dwelling of a Kingfisher or Sand-Martin. The main opening is under water, but there is a second one above the surface, which appears to promote venti-

lation, though it may perhaps be used as an emergency exit as well. The milk-glands are comparable to those of the Spiny Ant-Eater, but there is no pouch, and the eggs are deposited in a rough sort of nest, lodged within the burrow, and made up of dry vegetation. Professor Gregg Wilson was the first naturalist to find this nest, and owed his success to the discovery that when the mother Duck-Bill goes out she throws up a little wall of soil between the nest and the rest of the burrow, an obviously protective arrangement. Anyone who dug out a burrow in ignorance of this fact would find that it appeared to end abruptly, whereas a little further excavation would reveal the nest.

POUCHED MAMMALS (METATHERIA).—Here again we are concerned with but one order (*Marsupialia*), the members of this also being limited to the Australian region, with the exception of Opossums (*Didelphyidæ*) and a small mouse-like creature (*Cænolestes*), which are American. Here, as in all Mammals except the egg-laying forms, the ova are minute and develop internally, there being special arrangements compensating for the absence of food-yolk. Young Marsupials are born in an extremely immature condition, and in the majority of cases are at once placed by the mother in her large pouch, and attached to the long teats there present. In Kangaroos the opening of the pouch is in front (fig. 997), obviously the most convenient position for creatures so constantly assuming an upright posture. In other cases it is at the back. A number of forms, *e.g.* most of the Opossums, are entirely devoid of this structure.

The pouch of a Marsupial is supported by two "marsupial bones" (see fig. 734, p. 190) attached to the pelvis, and probably equivalent to similarly-placed "epipubic" elements, often present in Reptiles and Amphibia (see vol. i, p. 241, fig. 149). These bones are also present in the Duck-Mole and Spiny Ant-Eater. It would, however, be a mistake to suppose that the pouch of the last-named animal is equivalent to that of, say, a Kangaroo, for this is only one of many instances where organs of different nature perform the same function.

So helpless is a newly-born Marsupial that it is at first unable to suck properly, and the milk is squirted down its throat by the contraction of a layer of muscle covering the milk-

glands. There is a special arrangement obviating the danger of choking, for the top of the wind-pipe is drawn out into a sort of cone fitting into the back of the nasal passages, but leaving room on either side of it for milk to pass down into the gullet. Even after the young animal is able to run about, it continues for some time to use the pouch as a retreat (fig. 997).



Fig. 997.—Yellow-footed Rock-Wallaby (*Petrogale xanthopus*), with young one in her pouch

The young of climbing Marsupials are in a number of cases carried on their mother's back, after they have grown sufficiently large and strong to hold on with safety (fig. 998). This is the case, for example, in the Koala (*Phascolarctos*) of Australia, and the little Mouse Opossum (*Didelphys murina*) of South America. The numerous offspring of the latter twine their prehensile tails round that of their mother, which greatly conduces

to their safety. Hudson (in *The Naturalist in L'is Plata*) thus describes this habit for a larger species:—"I have seen an old female opossum (*Didelphys Azaræ*) with eleven young, large as old rats—the mother being less than a cat in size—all clinging to various parts of her body; yet able to climb swiftly and with the greatest agility in the higher branches of a tree. . . . The opossum never quitted its hold on the tree, and it also supplemented its

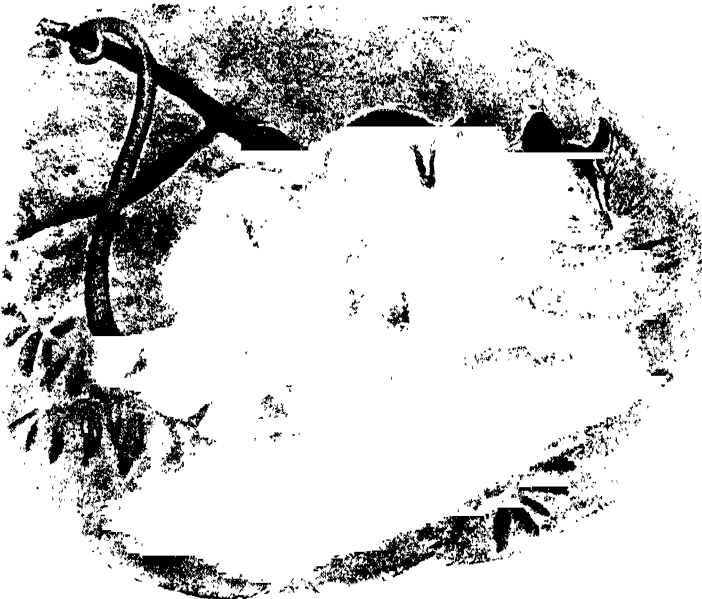

Fig. 998.—Azara's Opossum (*Didelphys Azaræ*) carrying her Young

hand-like feet, furnished with crooked claws, with its teeth and long prehensile tail" (fig. 998).

The bringing up of young ones in safety is sometimes promoted by the existence of special dwellings, as in burrowing forms such as the Wombat (*Phascolomys*) and Lesueur's Kangaroo-Rat (*Bettongia Lesueurii*). The Red Kangaroo-Rat (*Æpyprymnus rufescens*) builds a neat nest under a fallen tree or in some other convenient situation. Maternal affection does not appear to be so strongly developed in some, at least, of the Marsupials as it is in higher Mammals, for cases have been described of female Kangaroo-Rats and Kangaroos which, when pursued, have consulted their own safety by allowing the young ones to slip out of the pouch.

HIGHER MAMMALS (EUTHERIA).—These are divided into

numerous orders, which include the vast majority of mammalian species. Though Marsupials appear to have diverged early from the main line of descent, and have since specialized in so many directions that they give us but little idea of what the remote ancestors of the Eutheria were like, there are good reasons for thinking that these last are descended from pouched forms. At

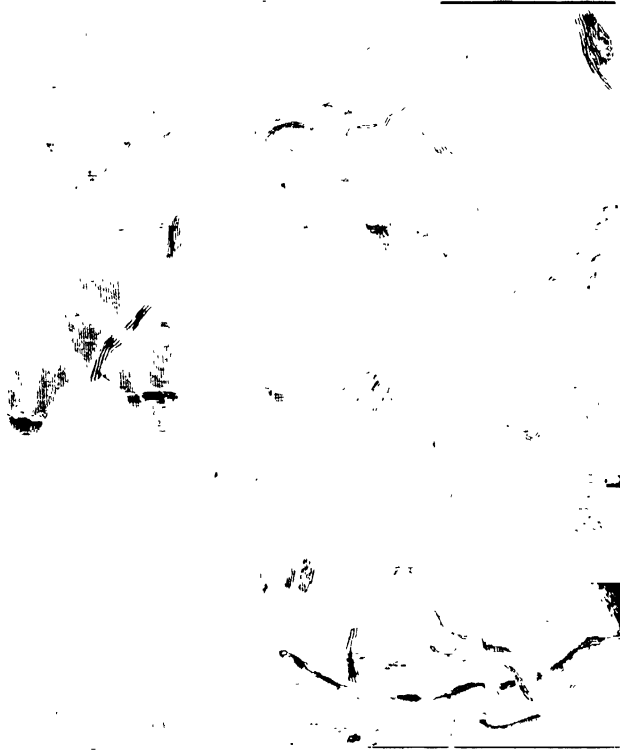

Fig. 999.—Three-toed Sloth (*Bradypus tridactylus*) carrying her Young

any rate, traces of a pouch have been found in some of the higher Mammals, even in adults. •

The young of higher Mammals are always born in a more perfect condition than those of Marsupials, but the amount of parental care they require varies greatly in different forms. There are also marked differences as to the number of young produced, and, broadly speaking, a corresponding variation in the number of milk-glands and teats, the actual position of these organs depending upon the species. Our purpose will be here sufficiently served by a review of some of the more interesting and important facts.

MAMMALS POOR IN TEETH (EDENTATA).—The Sloths of South America have a pair of milk-glands situated on the chest, and produce a single young one at each birth. This is sufficiently well-developed to cling firmly by its curved claws to its mother's back, on which it is carried about (fig. 999). Similar facts have been determined in the case of the Great Ant-Eater (*Myrmecophaga jubata*), native to the same part of the world.

In most of the Armadilloes, which are inhabitants of South and Central America, the young are from two to four in number, although in such species there are but two milk-glands, situated as in Sloths. When born they are blind and helpless, as usually in burrowing mammals, but after being suckled and tended for a few weeks are able to take care of themselves.

GNAWING MAMMALS (RODENTIA).—The members of this large and widely-distributed order differ greatly from one another as regards the number of young, their condition at birth, and the arrangements made for their welfare.

Here again we find, as in Edentates, that helpless young are associated with the existence of burrows or other shelters in which the earliest part of life can be passed in comparative security, while in the absence of such dwellings the condition at birth is decidedly more advanced. This is well illustrated by comparing the Rabbit (*Lepus cuniculus*) and Hare (*L. timidus*), two closely allied species. The former is a typical burrowing animal, and the doe excavates a special dwelling by way of nursery for her blind and helpless young, which number from five to eight as a rule. There is but one opening into this nursery, in which respect it differs from the ordinary burrow, and the mother lines the end of it with some of her own fur, for the greater comfort of her offspring. Like the Duck-Bill (see p. 478) she safeguards them in her absence by throwing up a rampart of earth to hinder weasels and other enemies from approaching the nest. We have elsewhere had occasion to note that extreme fecundity is an important means of preventing ill-defended species from becoming extinct (see vol. ii, p. 345), and the Rabbit is almost proverbial in this respect, littering several times in the same year. The young in their turn often become parents when they are only six months old. In this country there are so many checks to increase that in a

given locality the total number of rabbits may remain practically the same for long periods of time, but, as everyone knows, the introduction of this species into Australia has been followed by an extraordinary increase in numbers, chiefly owing to the absence of predaceous native forms. In respect of fertility the Rabbit is greatly surpassed by some other members of the same order, such as Mice and Voles. Certain species of the latter at times increase at such an alarming rate, both in this country and on the Continent, as to constitute a serious agricultural "plague", to successfully cope with which taxes all the resources of applied science.

Turning now to the Hare, we find that this animal does not burrow, its home being simply a sheltered spot known as a "form". The leverets are from two to five in number, their eyes are open

from the first, and they are fur-covered when born. After being suckled for about three weeks they have to look after themselves.

The blind and naked young of the little Harvest-Mouse (*Mus minutus*, fig. 1000) are born in an elegant globular nest, usually found suspended from the stalks of corn or grass. Gilbert White (in *The Natural History of Selborne*), in his oft-quoted account of these mice, says that "they build their nests amidst the straws of the corn above the ground, and sometimes in thistles. They breed as many as eight at a litter, in a little round nest composed of the blades of grass or wheat. One of these nests I procured this autumn, most artificially plaited, and composed of the blades of wheat, perfectly round, and about the size of a cricket-ball; with the aperture so ingeniously closed, that there was no discovering to what part it belonged. It was so compact and well filled that it would roll across the table without being discomposed, though it contained eight little mice that were naked and blind."

The Common Squirrel (*Sciurus vulgaris*) is another nest-building rodent, and constructs its dwelling either in a hole in

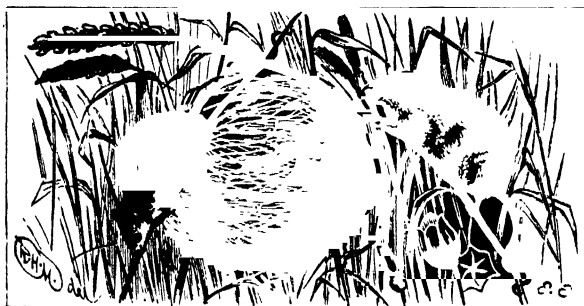

Fig. 1000.—Harvest-Mice (*Mus minutus*) and Nest

a tree or else in a convenient fork of the branches. The framework of this "drey", which is of rounded shape, consists of interwoven twigs, while moss, lichen, and leaves are used as packing and lining materials. The opening is on one side, and, unless a hole has been selected for a residence, its position may be altered from time to time in accordance with the exigencies of the weather. The blind and helpless young are born within this snug habitation, their number being usually three or four, though sometimes there is a much larger family.

INSECT-EATING MAMMALS (INSECTIVORA).—The animals of this large order are usually small and defenceless. Like Rodents they are extremely prolific, and their young are born blind and naked. Several pairs of milk-glands are present. It will perhaps suffice to deal with two of our native forms, the Hedgehog (*Erinaceus Europæus*) and the Mole (*Talpa Europæa*).

The Hedgehog constructs a snug nest of dried leaves under a hedge or in some other sheltered situation, and

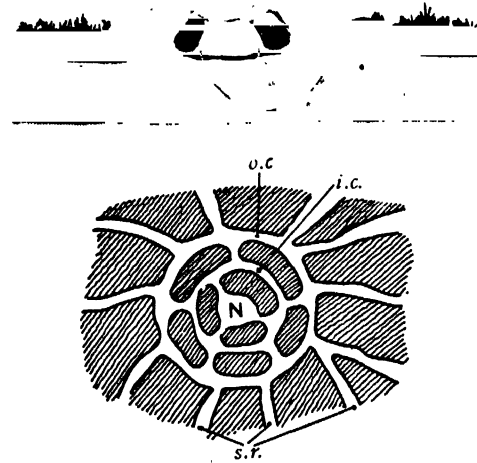

Fig. 1001.—Fortress of Mole (*Talpa Europæa*) in vertical section (above) and plan (below), reduced. N., nest; i.c., inner circular passage; o.c., outer circular passage; s.r., side-roads.

here the young are born, to the number of five or six as a general rule. They are at first blind, practically bare, and devoid of the power of rolling themselves up. Growth is rapid, and these defects are soon remedied.

The Mole is remarkable for the ingenuity and skill it displays in the construction of a comfortable dwelling or "fortress", to which it is said to repair four times in the twenty-four hours, for the purpose of resting after its very considerable labours by way of tunnelling in search of food. This retreat is placed at a distance from the hunting-ground, in some inaccessible place, as under the roots of a tree, in the shelter of a thick hedge, or below a wall. As will be gathered from fig. 1001, it is of decidedly elaborate nature. What we may perhaps call the "home-road" leads into a rounded chamber, cosily lined with moss and dry

grass. • Surrounding this chamber at a little distance is a circular passage, and at a somewhat higher level a narrower gallery of the same shape. This last has some three direct communications with the central chamber, and about five with the larger circular passage, from which radiate a number of "side-roads", that ultimately bend round and open into the home-road. An enemy entering this labyrinth is likely to go wrong, and at the same time the owner of the dwelling has numerous ways of escape. The walls of all these various passages are compacted by pressure, so that they are permanent structures which do not readily fall in. But as in Rabbits (see p. 482), this convenient and well-appointed dwelling is not used as a nursery, for which purpose a sheltered spot not far from the fortress is selected, a suitable chamber being excavated and warmly lined. This is placed where three or more galleries meet, safety from weasels being the chief object attained. The family consists of five young ones in most cases, and these are born in a particularly helpless condition. They are fed and tended by their mother for at least five weeks, by which time they are about half-grown, and during this part of their existence are said to remain in the nest. The affections of the family are apparently distributed in a way that is somewhat reminiscent of the brief notes appended to the cast of a drama. The mother, as usual, is devoted to her young, and her affection is presumably reciprocated. The father is believed to be a noted instance of conjugal attachment, but his feelings towards his family are often expressed by attempts to devour them, and a probable guess might be made as to their feelings in regard to him.

The aberrant Insectivore known as the Colugo or Flying-*"Lemur"* (*Galeopithecus*), remarkable for its parachuting arrangements, is in some respects transitional to Bats. Instead of producing a numerous family, and possessing a proportionate number of milk-glands, it gives birth to only a single young one, so far as known. The milk-glands are two in number, and situated on the chest. Although the young Colugo comes into the world blind and hairless it is nevertheless able to hold firmly to the fur of its mother, and is carried about by her.

BATS (CHIROPTERA).—The milk-glands of Bats correspond to those of the Colugo in number and position; and the one or sometimes two young ones are born in much the same condition

as the offspring of that animal. In the majority of cases the first act of a newly-born Bat is to crawl along the body of its mother till the source of nourishment is reached. The devoted parent carries her progeny about with her for a considerable time, but the power of holding on is so well developed that infant mortality is thereby obviated, so far as accidental death from falling is concerned.

Hudson (in *The Naturalist in La Plata*) gives the following interesting details regarding this habit of carrying about the young:—"While taking Bats one day in December, I captured a female of our common Buenos Ayrean species (*Molossus Bonariensis*), with her two young attached to her, so large that it seemed incredible she should be able to fly and take insects with such a weight to drag her down. The young were about a third less in size than the mother, so that she could carry a weight greatly exceeding that of her own body. They were fastened to her breast and belly, one on each side, as when first born; and possibly the young bat does not change its position, or move, like the young developed opossum, to other parts of the body, until mature enough to begin an independent life. On forcibly separating them from their parent, I found that they were not yet able to fly, but when set free fluttered feebly to the ground. This bat certainly appeared more burdened with its young than any animal I had ever observed. . . . The poor bat had to seek its living in the empty air, pursuing its prey with the swiftness of a swallow, and it seemed wonderful to me that she should have been able to carry about that great burden with her one pair of wings, and withal to be active enough to supply herself and her young with food." This mother-bat was released, and the young ones were found to be already expert climbers; their disposition was decidedly vicious. Maternal affection must have been strongly developed in this instance, and it is gratifying to read the following statement of what happened after the lapse of some hours:—"In the evening I placed myself close to the tree [from which the young were taken and to which they had been restored], and presently had the satisfaction of seeing the mother return, flying straight to the spot where I had taken her, and in a few moments she was away again, and over the trees with her twins".

HOOFED MAMMALS (UNGULATA).—We have seen that the

young of Rodents are either helpless or fairly well developed at birth, in correlation with the particular mode of life. For Insectivores and Bats the former is true, while the latter is the rule for the order now under consideration. The reason is not far to seek, and is thus tersely given by Flower:—"In the great order of Ungulates or Hoofed Mammals, where in the majority of cases defence from foes depends upon fleetness of foot, or upon huge corporeal bulk, the young are born in a very highly-

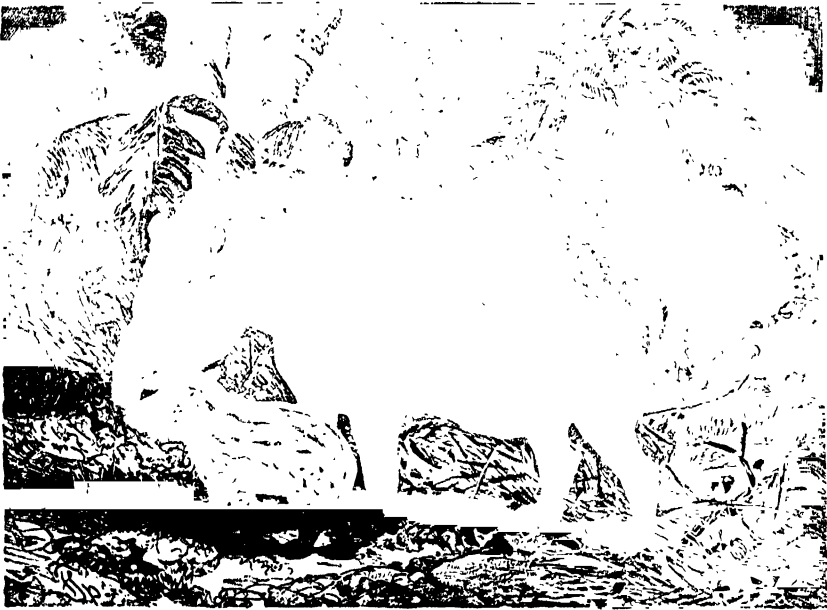

Fig. 1002.—Brazilian Tapirs (*Tapirus Americanus*) and striped Young

developed condition, and are able almost at once to run by the side of the parent". Swine, with the exception of the Peccaries, produce numerous offspring, but in all other Ungulates the number is limited to one, or at most two. In correlation with this the milk-glands are few in number. They are situated in the region of the groin, as familiarly illustrated by Sheep and other domesticated forms. Maternal affection is very strongly developed, nor, as a rule, is the father backward in defending his family. The majority of species are gregarious, and this greatly adds to the possibilities of defence. It will be convenient to consider Odd-toed and Even-toed Ungulates under separate headings.

Odd-toed Ungulates (Perissodactyla).—The three families of this sub-order include Tapirs, Rhinoceroses, and Horses respec-

tively. The Tapirs are solitary animals, which produce a single young one at birth. While the adult is either uniformly coloured, as in the Brazilian Tapir (fig. 1002), or dark with the hinder part whitish, the young are remarkable in being marked with yellowish streaks and spots. All these varieties in coloration would appear to be of protective nature, even that of the adult Malayan species, of which H. N. Ridley states (in *Natural Science*, 1895):—"When lying down during the day it exactly resembles a gray boulder, and as it often lives near the rocky streams of the hill jungles, it is really nearly as invisible then as it was when it was speckled". The peculiar markings of the young are precisely on a par with those so often exhibited by young birds (see p. 471). We learn from Ridley that in the Malayan species it is in the habit of taking its daily siesta under a bush, when "its coat is so exactly like a patch of ground flecked with sunlight that it is quite invisible". The same thing is no doubt true for the Brazilian form. The Rhinoceros produces a single young one, to which the strength of the mother is a sufficient protection. This animal is also of solitary habit.

Horses and their allies are gregarious, and as a rule only a single young one is brought forth at each birth. The chief point of interest in the present connection is afforded by the defensive tactics, which have elsewhere been noticed (see vol. ii, p. 350).

Even-toed Ungulates (Artiodactyla).—We have here to draw a distinction between the Non-Ruminating forms, including the Swine and Hippopotami, and the Ruminating or cud-chewing species, embracing Camels, Deer, Oxen, Sheep, Goats, Antelopes, and Giraffes.

Most wild Swine possess numerous pairs of milk-glands situated in the abdominal region, and their families are large. They live associated together in small droves. The young animals are striped, and this is no doubt a protective arrangement, as in the case of Tapirs. In the remarkable pig known as the Babirusa (*Porcus babirusa*), native to Celebes and certain adjacent islands, the young are more helpless than in other swine, and tax maternal affection considerably. This exceptional state of things is probably to be correlated with isolation on an island area which, in the absence of predaceous forms, minimizes the need for protective arrangements. In South America and the

southern part of North America, the Swine of the Old World are replaced by the more specialized Peccaries. The smaller Collared Peccary (*Dicotyles torquatus*), which has the wider range, associates in small droves, while in the rather larger White-lipped Peccary (*D. labiatus*), a purely South American

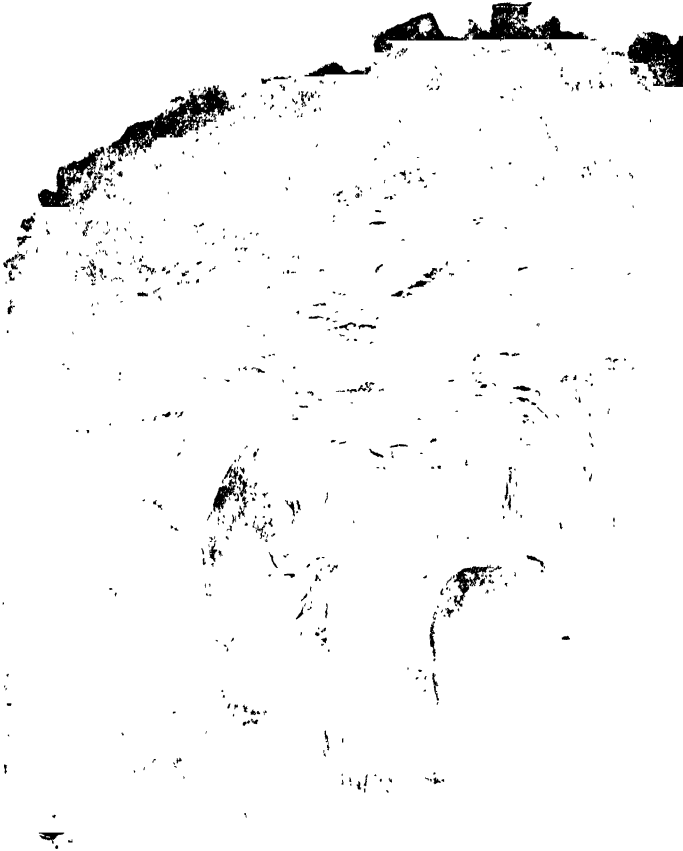

Fig. 1003.—Hind and Fawn of Roe-Deer (*Capreolus caprea*)

form, a very large number of individuals herd together. Both are forest animals and lead a wandering life, and the young of both species are devoid of the stripes so characteristic of Old World Pigs. One, or at most two, young ones are born at a time, and the milk-glands are reduced to a single pair. Possibly the number of young may have undergone reduction as an adaptation to the exigencies of a roaming life.

The gregarious Hippopotamus (*Hippopotamus amphibius*) pro-

duces a single well-developed young one at a birth, which is tended by its mother with the most jealous care. It may frequently be seen riding upon her back, and under these circumstances she comes very frequently to the surface, seeming to be aware that her offspring requires to take a fresh breath more frequently than she does herself.

Ruminants (fig. 1003) usually give birth to a single young one, or more rarely to two. The power of chewing the cud is not at first possessed, since only the fourth or chemical division of the stomach (*abomasum*) is properly developed (see vol. ii, p. 169). This is quite able to deal with milk, to which diet the young animal is necessarily restricted till such time as the digestive organs are fully developed. The social habit, here very typical, is associated with interesting defensive tactics, such as setting sentinels to guard the feeding herd (see vol. ii, p. 365).

ELEPHANTS (PROBOSCIDEA).—As in the case of Ruminants, a single young one as a rule is produced at a birth in these gregarious animals, and from the first it is well able to accompany its mother in her rather extensive wanderings in search of food. It is scarcely necessary to remark that the young animal sucks with its mouth, and not with its trunk, though the contrary was long believed. There are but two milk-glands, placed on the chest.

SEA-COWS (SIRENIA).—Both in the Dugong (*Halicore*) and the Manatee (*Manatus*) there is but a single young one, born in a well-developed state, as might be expected in such thoroughly aquatic animals. There is a single pair of milk-glands, placed on the chest, and the mother has a curious habit of holding her offspring firmly by means of one flipper during the operation of sucking, swimming along at the same time with its head and her own above the surface.

WHALES, PORPOISES, &C. (CETACEA).—Of all Mammals these are by far the best adapted to an aquatic life. There is usually only a single young one, which, from the nature of the case, is born in a well-developed condition, and perfectly able to swim. Flower very justly remarks:—"This state of relative maturity at birth reaches its highest development in the Cetacea, where it is evidently associated with the peculiar conditions under which these animals pass their existence". The two milk-glands are placed far back on the under side of the body, the teat of each

being lodged in a deep pit, an arrangement which is doubtless of a protective nature, besides which it may perhaps render suckling more easy. Maternal affection is very strongly manifested among Cetaceans, as whale-fishers have often found to their cost. At the approach of danger the Greenland Whale shelters her young one under her flippers. Most of the Cetaceans are markedly gregarious, being associated together in large "schools".

FLESH-EATING MAMMALS (CARNIVORA).—

The helpless young which we have so far considered are safeguarded by being brought up in a sheltered dwelling, or it may be that the mother carries them about with her. The young of Carnivores are quite unable to look after themselves when born, as familiarly exemplified by kittens and puppies, but in this case their safety mostly depends upon the natural weapons with which their parents are liberally provided.



Fig. 1004.—Cubs of Brown Bear (*Ursus arctos*) at play

Among land Carnivores (Fissipedia) no general rule can be given as to the number of young, for this varies considerably within the limit of the group. A large family is usually typical of members of the Dog tribe (*Canidae*), while three or four is the common limit in Lions, Tigers, and other large species of the Cat Family (*Felidae*), and in the large Bears (*Ursidae*) the number is usually restricted to one, two, or possibly three (fig. 1004). The safe up-bringing of the young is often furthered by the existence of some sort of dwelling or lair. It will suffice to

instance the "earth" of the Fox and the "holt" of the Otter, the latter being simply a hole in the bank of a stream. That parental affection is strongly developed in Carnivores is a matter of common knowledge. All have had occasion to note this in the case of domesticated Dogs and Cats, and abundant examples are recorded in books on sport.

The Aquatic Carnivores (Pinnipedia) have much smaller families than the majority of their terrestrial cousins, the young being limited to one, or at most two. The Walruses, Seals, and Eared Seals which constitute the group all visit land at certain seasons, and remain there until their young are sufficiently advanced to share the aquatic life for which these forms are so eminently adapted. The crowded "rookeries" established at this time by the Northern Fur-Seal (*Otaria ursina*) on the Pribyloff Islands, in Behring Sea, have been described in detail by Elliott and other observers. The first comers are the mature males, of which vast numbers have arrived by about the first of June, the far more numerous females making their appearance about three weeks or a month later. As, too, many of the younger and weaker males are "bachelors", from compulsion and not from choice, polygamy naturally results. The males who have contracted family ties take once more to the sea at the beginning of August, though a small minority return to the land in September; and the large majority of individuals have left the islands by November. The young seals are born soon after their mothers reach land, and their eyes are open at birth. After their fathers have resumed an aquatic life the cubs make their first attempts in swimming, and though said to be clumsy at first, are efficient in the art after about a month's practice. From observations made on captive Eared Seals in the zoological gardens at Cologne, Wunderlich believes that the current accounts representing the cubs as having to "learn" to swim are somewhat exaggerated, and he says that they are quite at home in the water shortly after birth. But it is certain that fairly prolonged sojourn on land is necessary before they are strong enough to undertake long-distance swimming, the adaptation to an aquatic life being much less complete than in the case of young Cetaceans (see p. 490). Parental affection is said to be far from strong in the Northern Fur-Seals.

LEMURS (LEMUROIDEA).—In these purely arboreal animals

there is a pair of milk-glands situated on the chest, but these may be supplemented by others placed in the abdominal region. In the majority of species the number of young is limited to one, or it may be two, and all Lemurs are born in a helpless condition. In many cases the mother carries her young one about with her, and it holds on firmly to the under side of her body, lying cross-wise, in the position which is of least hindrance to climbing (fig. 1005). One species at least possesses a well-marked vestige of a marsupial pouch, which fact has suggested to Beddard the



Fig. 1005.—Lemur (*Lemur rufifrons*) carrying her Young

following interesting remark (in *The Cambridge Natural History*):—"One is tempted to wonder how far the habit which certain Lemurs have of carrying their young across the abdomen with the tail wrapped round the body of the mother is a reminiscence of a marsupial pouch". The little Mouse-Lemurs somewhat resemble Dormice in appearance and habits. Lydekker (in *The Royal Natural History*) makes the following remarks about the Dwarf Mouse-Lemur (*Microcebus pusillus*), one of the smallest of these:—"The dwarf mouse-lemur builds beautifully-constructed nests of twigs, lined with hair, in the tops of the lofty trees where it delights to dwell. These nests somewhat resemble those of a rook both in form and size, and are used not only as diurnal resting-places, but as cradles for the young."

APES, MONKEYS, AND MEN (PRIMATES).—Even if the human species be left out of consideration we must regard this order

as including the Highest Mammals, if a well-developed brain associated with great intelligence is to be taken as the criterion. The single pair of milk-glands is situated on the chest, and a single young one is the general rule, though an exception is afforded to this by the Marmozets, the lowest members of the order, for in these there is a family of two or three. Parental affection, especially on the part of the mother, is very strongly developed, and necessarily so, for the newly-born young are extremely helpless, and it is a considerable time before they are fully able to look after themselves. One of the most extraordinary features in the evolution of human civilization consists in the relatively late age at which maturity is attained, and the large amount of parental sacrifice which this involves. The altruistic attitude to which this has largely contributed is a factor of no small importance in social progress. And it may be added that the study of biology is, or should be, an indispensable preliminary for those who interest themselves in the as yet imperfect science of sociology.

Most Monkeys are arboreal and social in habit, and the immature young are commonly carried about by their mothers, pretty much as in some of the Lemurs. The extraordinary grasping-power of newly-born human infants has been explained as an inheritance from remote tree-living ancestors (see p. 234). Much sagacity is often shown, especially in Old World forms, in the precautions taken for the safety of the community, on similar lines to those adopted by some of the social Ungulates (see p. 365). This is true not only for the arboreal forms but also for the Baboons, which are typical ground-dwellers (see vol. ii, p. 363).

The highest of the man-like Apes, Orang, Chimpanzee, and Gorilla, do not live in troops, but are associated in family parties. They appear to be in the habit of constructing rough shelters in trees, some 50 or 60 feet from the ground in the case of the Orang, according to Wallace.

