

ELECTRICAL
ENGINEERING

T. Sewell, A.I.E.E.



UNIVERSITY OF CALIFORNIA

**ANDREW
SMITH
HALLIDIE:**

REGENT

1868 1901

THE ELEMENTS
OF
ELECTRICAL ENGINEERING

A First Year's Course for Students

BY
TYSON SEWELL, A.I.E.E.

*Assistant Lecturer and Demonstrator in Electrical Engineering at the
Polytechnic, Regent Street, London*



NEW YORK
D. VAN NOSTRAND COMPANY
23 MURRAY AND 27 WARREN STREETS
LONDON
CROSBY LOCKWOOD AND SON
1902

TK145
S5

HALLIDIE

PREFACE.



THE present volume being based upon courses of lectures given by me during the last few sessions to classes of students desirous of qualifying as electrical engineers, and my aim having been to treat the subject as far as possible on easy and non-mathematical lines, I am hopeful that the work will prove acceptable to the numerous students who are to be found attending evening and other courses of instruction at Polytechnics and Technical Schools.

To those who propose taking up the serious study of Electrical Engineering, and intend obtaining more than a surface knowledge of the subject, I would strongly advise that a concurrent course be taken in the science of Electricity and Magnetism, which underlies all practical applications to Electrical Engineering; and to those whose time for study is strictly limited, this science course may be found sufficient for the first year.

I have avoided a mathematical treatment as far as possible, and the numerical problems have not been worked out to a greater degree of accuracy than is required for practical work. In no case is an example given requiring more mathematics than is taught in the first stage of that subject.

It is of course impossible to describe the whole range

of apparatus to be found in everyday use, without unduly enlarging the book, therefore I have chosen typical well-tried pieces as illustrations in each case.

I am greatly indebted to Mr W. Hibbert, F.I.C., A.M.I.E.E., Principal of the Electrical Engineering and Physics Departments at the Polytechnic, Regent Street, for very great assistance extending over a number of years, and also to my friend Mr E. C. Roche, A.I.E.E., for his kindness in reading the manuscript and proof sheets, and for several suggestions.

T. SEWELL.

POLYTECHNIC, REGENT STREET,
LONDON, W. *July* 1902.

CONTENTS.



| | PAGE |
|------------------------|------|
| INTRODUCTION | ix |

CHAPTER I.

OHM'S LAW.

| | |
|---|---|
| Meaning and Importance of Electrical Pressure and Pressure Regulation—The Electrical Circuit, Water Analogy—Ohm's Law, Practical Problems—Voltage Drop on Simple Circuit—E. M. F. and P. D. | I |
|---|---|

CHAPTER II.

UNITS EMPLOYED IN ELECTRICAL ENGINEERING.

| | |
|---|----|
| C. G. S. System of Units—Absolute Units of Current, Quantity, E. M. F., and Resistance—Practical Units derived from Absolute Units—Units of Work and Power—Practical Problems on Work and Power | 14 |
|---|----|

CHAPTER III.

SERIES AND PARALLEL CIRCUITS—CURRENT DENSITY AND POTENTIAL DROP IN THE CIRCUIT.

| | |
|---|----|
| Simple Circuits, Power Spent at Different Parts—Resistance of Conductors, and Specific Resistance—Practical Problems on Calculating Length, Sectional Area, &c., of Conductors—Conductors in Parallel—Conductivity of Parallel Circuits—Voltage Drop Proportional to Current Density—Drop on Feeders and Mains—Practical Problems | 23 |
|---|----|

CHAPTER IV.

THE HEATING EFFECT OF THE ELECTRIC CURRENT.

| | PAGE |
|---|------|
| Work and Heat—Joule's Equivalent—Quantity of Heat Proportional to C^2Rt —Quantity of Heat and Temperature Rise—Heating and Cooking Apparatus—Practical Problems - - - - - | 44 |

CHAPTER V.

THE MAGNETIC EFFECT OF AN ELECTRIC CURRENT.

| | |
|--|----|
| Magnetic Field due to Straight Current—Shape and Direction of Field—Field of Loop—Attractive and Repellent Fields—Field of Solenoid—E.M.F. Developed in Conductors Cutting Field—Magnetic Potential or Magneto-Motive Force—Magnetic Reluctance—Permeability—Measurement of Field Strength - - - | 55 |
|--|----|

CHAPTER VI.

THE MAGNETISATION OF IRON.

| | |
|--|----|
| Effect of Iron Cores—Permeability of Iron—Magnetic Density—Magnetisation Curves of Wrought Iron, Steel, and Cast Iron—Ampere Turns required for any given Magnetic Density—Effective Area of Air-gaps—Practical Problems - - - - - | 72 |
|--|----|

CHAPTER VII.

ELECTRO-CHEMISTRY—PRIMARY BATTERIES.

| | |
|--|----|
| Faraday's Laws—Chemical Equivalents and Electro-Chemical Equivalents—Copper Refining—Primary Cells—Weight of Zinc Consumed per Ampere Hour—Polarisation—Description of Primary Cells - - - - - | 91 |
|--|----|

CHAPTER VIII.

ACCUMULATORS.

| | |
|---|-----|
| Planté's Cell—Faure's Cell—Chemical Action in Charge and Discharge—Capacity and Discharge Rate—Maximum Discharge Rate—E.M.F. and Acid Strength—Efficiency - - - - - | 105 |
|---|-----|

CHAPTER IX.

INDICATING INSTRUMENTS—AMMETERS, VOLTMETERS, OHMMETERS.

| | |
|---|-----|
| Indicating Instruments—Essential Differences—Points in Design—Instruments depending on the Magnetic Effect—Instruments depending on the Heating Effects—Electro-Static Instruments—Ohmmeter - - - - - | 116 |
|---|-----|

CHAPTER X.

ELECTRICITY SUPPLY METERS.

| | PAGE |
|--|------|
| Points in Design—Ampere Hour and Watt Hour Meters—Meters for Alternating and Direct Currents—Meter Constant and Meter Testing—Description of Modern Meters—Maximum Demand Indicators | 134 |

CHAPTER XI.

MEASURING INSTRUMENTS, AND THE MEASUREMENT OF ELECTRICAL RESISTANCE.

| | |
|--|-----|
| Mirror, D'Arsonval, and Ballistic Galvanometers—High and Low Resistance Instruments—Degrees of Sensitiveness—Construction of Resistance Boxes—Measurement of Small Resistances—Wheatstone Bridge—Shunts and Shunt Boxes—Measurement of Insulation Resistance | 159 |
|--|-----|

CHAPTER XII.

MEASUREMENT OF POTENTIAL DIFFERENCE, CAPACITY, CURRENT STRENGTH, AND PERMEABILITY.

| | |
|--|-----|
| Potentiometers—Standard Cells—Measurement of High E.M.F.—Measurement of Large Currents—Condensers—Measurement of E.M.F. with Condenser—Measurement of Capacity—Measurement of Permeability of Specimen of Iron—Hibbert's Standard Magnet—Ewing's Magnetic Balance—Fisher-Hinnen's Permeability Tester—Thompson's Permeability Tester | 179 |
|--|-----|

CHAPTER XIII.

ARC LAMPS.

| | |
|--|-----|
| Series and Parallel Lamps—Need for Steadying Resistance—Shunt Coil for Feeding—Automatic Cut-out—Advantages and Disadvantages of Enclosed Arc Lamps—Light Absorbed by Different Globes—Alternating and Direct Current Arc Lamps—Hissing—Construction and Action of Typical Lamps | 202 |
|--|-----|

CHAPTER XIV.

INCANDESCENT LAMPS—MANUFACTURE AND INSTALLATION—PHOTOMETRY.

| | |
|--|--|
| Processes in Manufacture—Preparing the Cotton Solution—Squirting the Filaments—Shaping and Carbonising Filaments—Attachment to Platinum and Cementing Joints—Flashing—Mounting in Bulbs—Exhausting—Testing—Capping—Blackening—Development of | |
|--|--|

| | PAGE |
|--|------|
| Spots—Installation of Incandescent Lamps—Wiring Table—Single and Double Pole Fuses—Fuse Table—Photometry—Comparison of Standards of Light—Description of Photometers—Method of Working—Special Precautions for Arc Lamp Photometry - - | 227 |
| CHAPTER XV. <i>THE CONTINUOUS CURRENT DYNAMO.</i> | |
| E.M.F. Developed in Dynamo—Bipolar and Multipolar Machines—Method of Building Armatures—Drum and Gramme Armatures—Heat Developed and Cooling Surface—Slotted Cores—Space Factor—Gramme and Drum Winding—End Connectors for Drum—Single Coil in Field—Split Ring Commutator—Two Coils in Parallel—Speed and Output—Separately Excited, Series, Shunt, and Compound Wound Machines—Characteristic Curves—Armature Reaction—Sparking at the Commutator—Devices to Minimise Armature Reaction—Absorption of Power—Right Hand Rule—Construction of Commutators—Bearings—Shafts—Bed Plates—Magnetic Leakage—Carbon Brushes—Dynamos in Parallel - - | 258 |
| CHAPTER XVI. <i>DIRECT CURRENT MOTORS.</i> | |
| Back E.M.F.—Torque on Armature Conductors—Motor and Dynamo Reversible Machines—Direction of Rotation—Reversing Switches—Electrical Efficiency—Shunt Wound Motors—Alteration of Speed in Shunt Wound Motors—Traction Motors—Traction Motor Control—Controller and Connections—Reasons for Special Starting Devices—Compound Wound Motors—Winding for Four Pole Motors—Practical Problems - - - - - | 303 |
| INDEX - - - - - | 325 |

THE ELEMENTS

OF

ELECTRICAL ENGINEERING.



INTRODUCTION.

WITHIN a remarkably short space of time electrical engineering has been so largely and widely developed that it now stands in the very forefront of engineering industries. We find electricity everywhere supplanting the older forms of power, and it bids fair to revolutionise the older systems of traction in the near future. Already many railways are working, or are about to be worked, electrically, while many more are in course of construction on the same lines.

In the transmission of power there is nothing to compare with the electrical method, for the electrical motor is not only a wonderfully efficient machine, but is very small for the power developed, and its application to the driving of all kinds of machinery in our factories and workshops is now becoming universal. It has many great advantages compared with other motors. First, it is very compact, taking up but little floor space. Secondly, the power is easily conveyed to the motor, for an electric cable can be passed through small spaces and around obstacles where it would be almost impossible to get steam, hydraulic, or pneumatic pipes. Thirdly, when once put down, a motor requires but little attention, and continues to work with high efficiency at all loads for long periods. For these reasons the transmission of power from engine to machines by means of long lines of shafting and belts is practically doomed, while the wastefulness of a number of small steam

engines in a large factory is proverbial, and they are rapidly giving place to electric motors.

Again, the whole of our tramway system—although we are lamentably behindhand as compared with some other countries—is now being electrically equipped with surprising rapidity, and it is not too much to say that before long all our large centres of industry will be connected by a system of electric tramways or light railways, which, besides affording ready and cheap facilities for travelling between those centres, will allow of the conveyance of goods during the night as well as the daytime.

But electrical engineering does not stop here, for the same agent can be utilised with the greatest advantage for lighting both our streets and our dwellings with a light of unequalled power in the one case, and free from the objectionable properties of gas in the other, and in either case more easily managed than any other illuminant.

Again, electrical engineering finds various applications in mining, in extracting gold from the ore, in the cutting-out and the hauling of coal, in pumping and ventilating the mines, and in providing the miner with a light which can be used with safety in the most fiery pits.

We find also certain processes in the great chemical industries revolutionised by the application of electricity, and every year adds to their number.

Copper and other metals are now refined almost exclusively by electricity, and large works have sprung up in several districts owing to the great advantages offered by the electrical process.

In the development of electrical engineering entirely new industries have thus been created. The products of the electric furnace—aluminium, calcium carbide, &c.—were considered rare and costly before the application of electricity, while now they are cheaply produced at the rate of many thousands of tons per annum.

And although the electrical is the latest developed branch of engineering, it is the most exact in its measurements, currents as small as $\frac{1}{10000000}$ ampere and less, up to 2,000 or 3,000 amperes, being easily and accurately measured. The same remark applies to the measurement of electrical pressure and power. Whilst corresponding measurements in other branches of engineering are, to say the least, difficult, in electrical work powers

large enough to operate a train of some hundreds of tons weight, or powers so small that no ordinary mechanical device could measure them, are effected without special precautions or elaborate device.

The oldest branch of electrical engineering, namely, telegraphy, with its sister telephony, have reached now such considerable proportions as to demand separate and independent treatment and study. It is not easy to realise the extent of work now done and the perfection attained in its execution in this branch of electrical engineering, while the possibilities even in the immediate future are very great.

This rapid survey of the ground covered by electrical engineering will perhaps serve to indicate the far-reaching importance and interest of the subject, and possibly help to kindle in the student something of the enthusiasm and eagerness in his work without which he will fail to do justice either to his calling or to himself.



CHAPTER I.

O H M ' S L A W .

IN hydraulic, pneumatic, or steam engineering, the indications of the pressure gauge are of the utmost importance to the engineer; in fact, he is always considering and asking about the pressure, and does not trouble himself much about the water, air, or steam, for none of these would be of any use to him unless they existed under a certain head or pressure. It is simply the pressure under which they exist that gives to them their working power.

In a similar way the electrical engineer is always concerned about the electrical pressure; he does not talk or think so much about the electricity, but the electrical pressure is always in his mind as being of the first importance.

The hydraulic engineer measures his pressures in pounds per square inch, that is to say, his unit of pressure is that exerted by a pound weight. The electrical engineer's unit of pressure is called the volt (from Volta, an Italian electrician), the consideration of which we will leave for the next chapter. It is owing to this pressure that a current of electricity flows round a conducting circuit. No current could possibly flow unless there was a difference of electrical pressure in the circuit, in the same way that no water could possibly flow through a water conductor unless there existed a difference of pressure.

Instead of calling it the electrical pressure, we might call it the electricity-moving force, or the electro-motive force, or, for brevity, the e.m.f., which is the term most commonly applied to the electrical pressure; thus we speak of the e.m.f. of a circuit as being equal to so many volts.

It would perhaps be as well to point out here the engineer's meaning of pressure.

We may exert a pressure and still have no resultant motion ; as, for example, suppose a man applies a pressure (a moving force) at one end of a table, which would of itself be able to move the table along the floor, if now a boy pushes at the opposite end and in the opposite direction, it is certain that the table would not be moved as rapidly as before, providing the man pushes with the same force throughout, while if another man takes the place of the boy and pushes with equal force to the man opposite to him, the table would not be moved at all, although there is now a greater pressure being applied to the table than in the original case. It will therefore be seen that the result obtained does not depend on the pressure, but on the *difference* of pressure, and in all cases where pressure is spoken of it is the difference of pressure that is meant.

Returning to the experiment with the table, we have just seen that before the table can be moved we must provide a table-moving force, but when this is provided it does not follow that the table will move even then—it all depends upon the resistance offered. We can imagine a very heavy table, with rough feet, standing on two rough boards, and the man applying a moving force to it but producing no movement ; whereas when the floor has been smoothly planed he may be able to move it slowly, and by fitting wheels or casters to the feet of the table he may be able to move it rapidly with the same moving force.

We see that the rate of movement of the table depends partly upon the table-moving force applied, and also in part upon the resistance offered by the boards on which the table stands. It is directly proportional to the former and inversely proportional to the latter. That is to say, if we double the moving force while the resistance remains the same, the rate of movement of the table will be doubled, and if we keep the moving force the same and halve the resistance, the rate of movement of the table will be doubled. This could be stated thus—

$$\left. \begin{array}{l} \text{Rate of movement} \\ \text{of table} \end{array} \right\} \text{ is proportional to } \frac{\text{table-moving force}}{\text{resistance}}$$

Therefore the rate of movement of the table is a thing entirely dependent on two other things, and in trying to find its value we have to ask, first, what is the moving force available ? and

second, what is the resistance offered? The same applies to water moving in pipes, and this is perhaps a better analogy to the electrical case. We say there is a current of water flowing through the pipes, but this current is flowing simply because there is a difference of pressure between the two ends of the pipes, and as the pipes offer a certain resistance, while these two things remain constant, the strength of the current will remain constant also. If we desire to alter the rate of flow (the current), we must alter either the water-moving force (the head) or the resistance (the tap). We see now why the engineer is not concerned so much about the current; he may want a certain current to flow, but he gets it by seeing either to the water-moving force, or to the resistances, or to both.

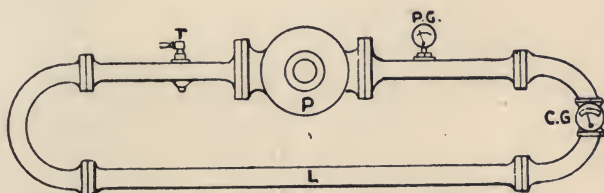

Fig. 1.

If we now apply this to electricity we find the same ideas in the mind of the electrical engineer. If he desires a certain current he asks himself, "What e.m.f. (electro-motive force) have I available?" and then, "What resistance must I have in the circuit?" and he makes all alterations in the current strength by adjusting the one or the other, or both, to suit. If the circuit has a fixed resistance, then he cannot alter the current flowing round it except by proportionally altering the e.m.f., that is to say, if he wishes to have twice the current strength he must put twice the e.m.f. into the circuit. If the e.m.f. has a fixed value, then he cannot alter the current without altering the resistance of the circuit, thus—if he wishes to double the current strength he must halve the total resistance of the circuit.

All the so-called generators of electricity, dynamos, batteries, &c., are simply devices for producing and maintaining an e.m.f. Some dynamos produce high e.m.f.'s from 2,000 to 10,000 volts

and even higher, while battery cells produce low e.m.f.'s from 1 to 2 volts only.

To make the analogy between the water system and the electrical system more correct, we should suppose a closed circuit of pipes, as shown in Fig. 1, completely filled with water, having a rotary pump P in the circuit, and furnished with a tap T, a pressure gauge PG, and a current gauge CG.

Suppose now we turn on tap T and start the pump working, the pressure gauge will indicate a difference of pressure in the circuit, and the current gauge will indicate a current flowing round the circuit. In this case we are not generating water, we are simply putting into motion the water that was already there, and

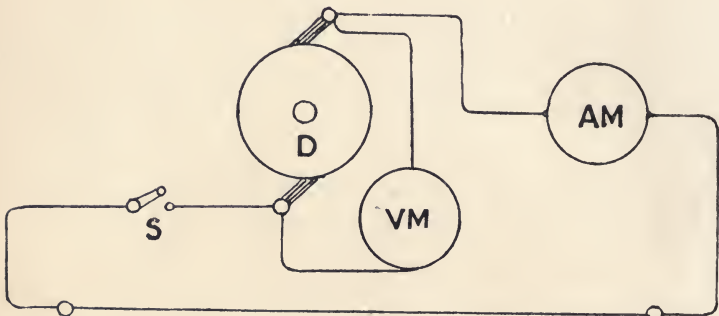

Fig. 2.

this is done by creating a difference of pressure by means of the pump, and by providing a conducting circuit. If we stop the pump, the two indicators will point again to zero, but there is just the same amount of water there as we started with, there has been no consumption of water.

In the same way we have to think of an electrical circuit (Fig. 2). The dynamo D is simply a device for producing a difference of electrical pressure, and is put into the circuit to act exactly as the pump does in Fig. 1. If we switch on S, which is comparable with turning on the tap in Fig. 1, and start the dynamo working, the pressure gauge (called the voltmeter) VM will indicate a difference of electrical pressure or an e.m.f., and the current gauge (called an ampere meter, or for brevity an ammeter) will

indicate a current flowing round the circuit. In this case we are not generating electricity, but simply putting into motion electricity that was already there.

Going back to Fig. 1, suppose we turn off the tap T and keep the pump working, then the current meter will indicate no current, but the pressure gauge will indicate a slightly higher pressure than before. Here we have a water-moving force, but the resistance in the circuit is now exceedingly great, consequently no current can flow.

Similarly in Fig. 2, if we switch off, still keeping the dynamo running, the voltmeter will show a slightly higher pressure, while the ammeter will indicate no current. Here again we have the one essential for a flow of electricity round the circuit, but not the other, for in switching off we have introduced into the circuit an enormous resistance.

We have previously said, with regard to the rate of movement of the table, that it could be stated as being directly proportional to the table-moving force, and inversely proportional to the resistance, or—

$$\left. \begin{array}{l} \text{Rate of movement} \\ \text{of table} \end{array} \right\} \propto \frac{\text{table-moving force}}{\text{resistance}}$$

In the same way we can write—

$$\left. \begin{array}{l} \text{Rate of flow of} \\ \text{electricity} \end{array} \right\} \propto \frac{\text{electro-motive force}}{\text{electrical resistance}}$$

It is evident that we might so choose the values of these units that "equal to" may take the place of "proportional to." This has been done, the units being so chosen that when unit e.m.f. is employed in a circuit having unit resistance, unit current flows through it, or—

$$\text{Current} = \frac{\text{e.m.f.}}{\text{resistance}}$$

This is known as Ohm's law ("Ohm" being the name of an eminent German scientist, to perpetuate whose name the unit of resistance has been called the ohm).

The unit current has been named after an eminent Frenchman, Ampere, so we say, "The current in amperes is equal to

the e.m.f. in volts, divided by the resistance in ohms." Of course—

$$\text{Amperes} = \frac{\text{volts}}{\text{ohms}}$$

is the same thing as—

$$\text{Current} = \frac{\text{e.m.f.}}{\text{resistance}}$$

Both are statements of Ohm's law.

It will be noticed that we have referred throughout to the current as being *not* the movement of the table, or the flow of water or electricity, nor yet the quantity of water or electricity moved, but as *the rate* of movement. Fifty gallons of water is not a current of water, but 50 gallons per minute is a statement of the rate of flow, and consequently is a statement of the current strength. So in electricity, a quantity of electricity is not a current, but a certain quantity passing round the circuit per second is a statement of the current strength. *A current is the rate of flow.*

Ohm's law has such wide and universal application in electrical engineering that there are but few problems that can be worked out without its aid, and the student has to become perfectly acquainted with it before he can get very far. Ohm's law as here stated—

$$\text{Current} = \frac{\text{e.m.f.}}{\text{resistance}}$$

is an equation, and of course, like all simple equations, can be transposed. Thus—

$$\text{Resistance} = \frac{\text{e.m.f.}}{\text{current}}, \text{ and}$$

$$\text{e.m.f.} = \text{current} \times \text{resistance}$$

are only different ways of stating the same thing. To make this clear to a beginner, suppose the current = 6 and the e.m.f. = 12, while the resistance = 2, then—

$$C = \frac{\text{e.m.f.}}{R} \text{ or } 6 = \frac{12}{2}, \text{ and}$$

$$R = \frac{\text{e.m.f.}}{C} \text{ or } 2 = \frac{12}{6}, \text{ and}$$

$$\text{e.m.f.} = C \times R \text{ or } 12 = 6 \times 2.$$

He will see that if one statement be true, then the others must also be true.

Let us return again to our water circuit (Fig. 1) and examine it more closely. Imagine the system to be quite full of water, and remember that water is a practically incompressible fluid. If now we have our pump at work, with the tap turned off, we shall have a difference of pressure between the two sides of the pump but no current. The moment we turn the tap on a current will flow, but this current will be everywhere in the circuit of the same strength, it will *not* be strongest at the pump and get weaker as we go round the circuit, but will instantly have the same strength everywhere, and the current does not get used up in going round the circuit.

This is exactly the case with the current in Fig. 2. If the dynamo be at work we have an e.m.f. in the circuit, but while the switch is off no current can flow. The moment we switch on there is a current in the circuit which is everywhere of the same strength, *not* stronger near the dynamo, and getting used up as it goes round the circuit, but of the same strength everywhere in the circuit.

Let us now consider a few problems on the foregoing.

1. The e.m.f. in a simple circuit (Fig. 2) is = 100 volts, the resistance of the whole circuit = 50 ohms. What current will flow through the circuit?

$$\text{Ohm's law says, current} = \frac{\text{e.m.f.}}{\text{resistance}}$$

$$\text{Therefore in this case } c = \frac{100}{50} = 2 \text{ amperes.}$$

It must be fully realised by the student that while the e.m.f. remains at 100 volts, and the resistance remains at 50 ohms, the current in that circuit will be 2 amperes, no more and no less. It is impossible for any other strength current to flow.

2. The resistance of the circuit being reduced to 10 ohms, while the e.m.f. is kept at 100 volts, what is now the strength of the current?

$$\text{Again current} = \frac{\text{e.m.f.}}{\text{resistance}}$$

$$\text{Therefore } c = \frac{100}{10} = 10 \text{ amperes.}$$

3. It is found that when an e.m.f. of 100 volts is applied to a circuit, a current of 25 amperes flows. What is the total resistance of the circuit?

$$\text{The resistance} = \frac{\text{e.m.f.}}{\text{current}}$$

$$\text{Therefore the resistance} = \frac{100 \text{ volts}}{25 \text{ amperes}} = 4 \text{ ohms.}$$

4. In the same circuit we find that by twisting upon itself some of the wire of which it is composed, the current increases to 50 amperes. What is now the resistance of the circuit, and how much resistance has been cut out by so twisting up the wire?

Again, by Ohm's law—

$$\text{The resistance} = \frac{\text{e.m.f.}}{\text{current}}$$

$$\text{Therefore the resistance} = \frac{100}{50} = 2 \text{ ohms.}$$

It had four ohms previously; we have therefore cut out $4 - 2 = 2$ ohms.

5. In a circuit of 20 ohms resistance, a current of 5 amperes is flowing. What is the e.m.f. in the circuit?

By Ohm's law—

$$\text{The e.m.f.} = \text{current} \times \text{resistance.}$$

$$\text{Therefore the e.m.f.} = 5 \times 20 = 100 \text{ volts.}$$

6. What is the e.m.f. in a circuit whose resistance is equal to 10 ohms when a current flows through it of 20 amperes?

Again as above—

$$\text{The e.m.f.} = \text{current} \times \text{resistance.}$$

$$\text{The e.m.f.} = 20 \times 10 = 200 \text{ volts.}$$

Let us now take another simple circuit and study it in detail.

Fig. 3 represents a dynamo joined to four different conductors *a*, *b*, *c*, *d*, all having different resistances. These conductors joined up in the way indicated are said to be connected in series. In such a case the current has only one path, and the strength of the current must be everywhere the same, consequently the ammeter to measure this current can be put into any part of the circuit. In Fig. 3 it is shown between *a* and *d*. It should be noticed that the ammeter forms part of the circuit, and that consequently all the current goes through it, while the voltmeter

is shown joined by two separate fine wires to the dynamo terminals, and so forms another circuit complete in itself, similar to a small bye-pass, but it is only a very small current that takes this path, for the resistance of that instrument is purposely made large.

Q. What current will flow through such a circuit as represented in Fig. 3?

Ohm's law tells us—

$$\text{The current} = \frac{\text{e.m.f.}}{\text{total resistance}} = \frac{100}{50} = 2 \text{ amperes.}$$

Note.—We are here neglecting the resistance of the dynamo itself. It is always very small, but in many cases it cannot be neglected, as we shall see almost immediately.

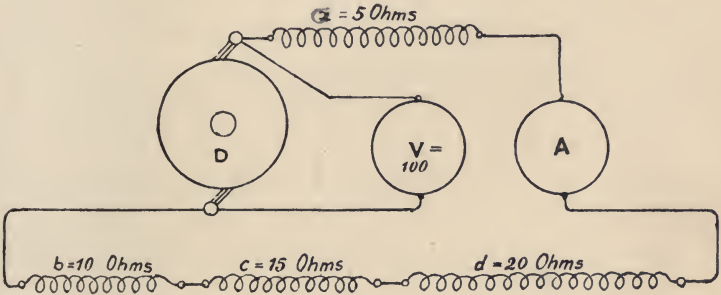

Fig. 3.

The total resistance of the circuit is here made up of $a + b + c + d$, but the same current flows through them all, and is everywhere of the same strength. It must be distinctly remembered that the current flows through the dynamo itself as well as through the external resistances a , b , c , and d . If this is not realised by the student, he should turn back to Fig. 1. Here the current of water does not start at the pump and end there after going round the circuit, but the current of water is everywhere the same, and goes through the pump as well as through the pipes.

Now Ohm's law applies to every part of the circuit as well as to the whole. We might ask, What is the e.m.f. on the ends of a , b , c , and d respectively? Here Ohm's law gives us the solution.

The e.m.f. on a = current in $a \times$ resistance of a .

Therefore e.m.f. on $a = 2 \times 5 = 10$ volts.

The e.m.f. on b = current in $b \times$ resistance of b .

Therefore the e.m.f. on $b = 2 \times 10 = 20$ volts.

The e.m.f. on c = current in $c \times$ resistance of c .

Therefore the e.m.f. on $c = 2 \times 15 = 30$ volts.

And e.m.f. on d = current in $d \times$ resistance of d .

Therefore the e.m.f. on $d = 2 \times 20 = 40$ volts.

If we add these together we get $a = 10$ volts + $b = 20$ volts + $c = 30$ volts + $d = 40$ volts—total 100 volts, which is the value of the e.m.f. generated by the dynamo.

We thus see that the e.m.f. is expended in the circuit, and unlike the current is quite different at different parts. It is, in fact, just proportional to the resistances of the various parts. Ohm's law tells us that this must be so, for if the same current flows through all the conductors, and these have different resistances, it follows that the greater the resistance the greater must be the e.m.f. expended on it to get the current through it, thus:—

c has three times the resistance of a , and we find that it has three times the e.m.f. expended on it. Again, d has twice the resistance of b , and has twice the e.m.f. expended on it, while d being four times greater in resistance than a has four times the e.m.f.

This opens out to us a very simple method of comparing resistances. If we join their ends together in series and send the same current through them, then the e.m.f. in the circuit will divide between them just in proportion to their resistances. If we apply a voltmeter to the ends of each separate resistance the various indications of the voltmeter will be proportional to the various resistances. If we include in the circuit a resistance whose value is known, then we could tell the value of the others by simple proportion.

Q. The same current is sent through two resistances in series A and x . $A = 10$ ohms and x is an unknown resistance. A voltmeter when connected to the ends of A reads 25 volts, and when connected to the ends of x reads 75 volts. What is the resistance of x ?

The voltmeter readings tell us the proportion of the two resistances (as the same current was flowing through both when

the two readings were taken), for the e.m.f. divides up in such a circuit exactly in proportion to the different resistances.

Therefore the two resistances are in the proportion of 25 : 75 or 1 : 3, that is to say, x is three times greater in resistance than Λ .

But Λ is 10 ohms. Therefore $x = 10 \times 3 = 30$ ohms. We could apply the same method to any number of resistances in series, providing the current flowing through them does not vary.

Fig. 4 gives us another example. Here a dynamo is represented as supplying power to some premises at a distance. The current flowing through the mains = 100 amperes. The resistance

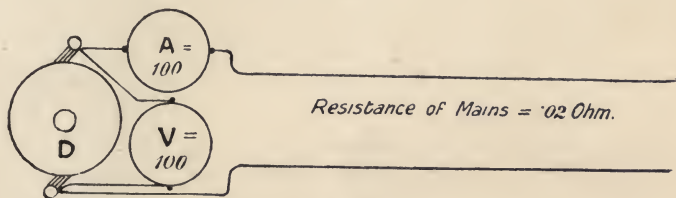

Fig. 4.

of the mains = .02 ohm ($= \frac{2}{100}$ ohm). What will be the e.m.f. spent on the mains in getting the current through them.

Ohm's law again helps us. It says—

e.m.f. spent on mains = current in mains \times resistance of mains.

Therefore e.m.f. spent on mains = $100 \times .02 = 2$ volts.

Suppose this dynamo be able to generate 100 volts when no current is flowing (on open circuit), then when we switch on there will be a distribution of the voltage round the circuit proportional to the resistances of the various parts. We should find 2 volts spent on the mains, and 98 volts in the premises being supplied.

Up to the present we have not considered the resistance of the dynamo itself, but the small resistance at this part leads to many important consequences. For example, in the case of Fig. 4, suppose the dynamo had a resistance of .02 ohm, then when it is delivering 100 amperes we should find 2 volts spent in the mains, and another 2 volts spent in getting the current through the dynamo itself, leaving only 96 volts at the consumer's disposal, and if he had arranged for his lamps, motors, &c., to be

worked at 100 volts, he would not be content with 96 volts instead. Besides, we shall see a little further on that this extra .02 ohm in the dynamo, though apparently such a small amount, means a loss of power, while it continues to deliver 100 amperes, of more than $\frac{1}{4}$ horse-power.

Q. A dynamo on open circuit generates 105 volts. It has a resistance of .01 ohm. It is connected to mains having a resistance of .015 ohm. The ammeter indicates a current flowing of 200 amperes. (1.) What will be the voltage at the further end of the mains? (2.) What will be the voltage spent in getting the current through the dynamo and the mains?

By Ohm's law we know that the e.m.f. spent on the dynamo = current through the dynamo \times resistance of the dynamo.

Therefore e.m.f. spent on dynamo = $200 \times .01 = 2$ volts.

Again e.m.f. spent on the mains = current through the mains \times resistance of the mains.

Therefore e.m.f. spent on mains = $200 \times .015 = 3$ volts.

The dynamo on open circuit generates 105 volts, but when delivering 200 amperes, 2 volts are spent on the dynamo, and 3 volts on the mains. Therefore at the further end of the mains we should have $105 - 5 = 100$ volts.

In such a case as we have just considered, if we joined a voltmeter to the dynamo terminals while it is running on open circuit, it would indicate 105 volts. The ammeter would of course indicate no current, but the moment we switch on, and so allow the current of 200 amperes to flow, the voltmeter would suddenly indicate 103 volts, the other 2 volts being spent in getting the current through the dynamo, owing to its own resistance. To distinguish this latter reading from the former, we call it the potential difference. We say the dynamo is capable of generating an e.m.f. of 105 volts, but the potential difference when delivering 200 amperes is 103 volts. It will be seen that the potential difference depends on the current, and varies with it. From the above it would be quite easy to calculate the resistance of the dynamo, for we see that it loses 2 volts when delivering 200 amperes, and according to Ohm's law—

$$\text{The resistance of dynamo} = \frac{\text{e.m.f. spent in dynamo}}{\text{current through dynamo}}$$

$$\text{Therefore resistance of dynamo} = \frac{2}{200} = .01 \text{ ohm.}$$

The e.m.f. and also the potential difference or p.d. are both measured in volts. The e.m.f. is spoken of when we are considering the whole circuit including the generator, while the p.d. is used when we are considering the circuit outside the generator ; thus, in the above case, we have for the whole circuit an e.m.f. of 105 volts, but for work outside the dynamo only 103 volts.

This is very similar to the indicated and brake horse-power of a steam-engine. With the aid of an indicator we can make a diagram telling us the value of the horse-power generated in the steam-engine cylinder, but some of this power is spent in overcoming the frictions of the moving parts of the engine itself, so that for work outside the engine we must deduct a certain amount depending on the amount of friction in the engine. The horse-power as measured by the brake on the fly-wheel or pulley is the horse-power available for work outside the engine, and is always less than the indicated horse-power.

CHAPTER II.

UNITS EMPLOYED IN ELECTRICAL ENGINEERING.

WE may now consider how the units we have been using, together with others used in electrical engineering, are derived. The original units, known as the "absolute units," were found to be inconvenient for practical work, and consequently the practical units employed are multiples of the absolute units in the decimal system. The absolute units, to which we often must refer, are based on an universal system of units known as the C.G.S. system, or the "Centimetre, Gram, Second" system, the centimetre being the unit of length, and is equal to $\frac{1}{100}$ part of the length of the standard metre kept at the Board of Trade Standards Laboratory. There are 2.54 cm. in 1 in., and therefore 1 cm. is just a little over $\frac{3}{8}$ in. This, then, is our unit of length. The gramme is the unit of weight (sometimes shortened to gram). This again is a very small unit compared with the pound weight. It is the weight of water at 0° C. which will just fill a cube of 1 cm. side. This weight is only $\frac{1}{453.6}$ lb., or there are 453 (or to be exact, 453.6) grams to 1 lb. weight. The second is familiar to all. It is the short space of time represented by $\frac{1}{60}$ minute. All the other units can be built up from these three. For instance, unit area is the area covered by 1 sq. cm. ; unit volume is the volume of a cube of 1 cm. side. We have another unit in this system, not found in mechanical engineering, viz., unit of force, and this has been called the "dyne," which is the Greek for force. This is an exceedingly small unit of force compared with the force exerted by a pound weight. It is the force which, if allowed to act on a mass of 1 gram for 1 second, would impart to it a velocity of 1 cm. per second. To get a more definite idea of the meaning of this force, suppose we have a pulley, very light and easy running, and a very fine cord passing over it supporting a gram weight at each end, then the force of gravity would be balanced, and there would be

no tendency for either weight to move downwards, but if we start one weight moving, it would continue to move with a uniform velocity until damped out by the friction of the air and the pulley. If the pulley were quite free from friction, and the arrangement placed in a vacuum, then the weight would continue to move at a uniform rate, depending on the force applied and the time it is applied, till it touched the bottom of the apparatus. This, then, is made the measure of the force. It is such a force which, if applied for 1 second, makes the small gram weight move with a velocity of 1 cm. per second. This, it will be noticed, is independent of the force of gravity, which varies at different parts of the earth, depending upon the altitude. It would, in fact, be the same force if measured at any place, whereas the force exerted by a pound weight would vary with position. At sea level, 1 gram exerts a force of 981 dynes, or a gram acting on another gram for 1 second would impart to it a velocity of 981 cm. per second. As there are 453 grams in 1 lb., a pound weight would exert a force of 981×453 dynes. The foregoing is here tabulated:—

C.G.S. SYSTEM.

| Unit. | Name. | Relation to other Units. |
|-------------|--------------|---------------------------------|
| Length - - | Centimetre - | 2.54 cm. = 1 in. |
| Area - - - | Sq. cm. - - | 6.45 sq. cm. = 1 sq. in. |
| Volume - - | Cub. cm. - - | 16.5 cub. cm. = 1 cub. in. |
| Weight - - | Gram - - - | 453 grams = 1 lb. |
| Force - - - | Dyne ; - - | 981 dynes = 1 gram. |
| Work - - - | Erg - - - | 13,545,000 ergs = 1 foot-pound. |
| Power - - - | | 1 erg per second. |
| Time - - - | Second - - | 60 seconds = 1 minute. |

Two of the units enumerated above, viz., work and power, must be further considered. Work is done when a force is overcome through a distance, or when a weight is raised against the force of gravity. The amount of work done is measured by the force applied, multiplied into the distance through which it is applied, thus:—Suppose a weight of 50 lbs. be raised 10 ft., then 500 foot-pounds of work are done. The weight in again falling to the ground would do 500 foot-pounds of work also, and we should in this way get back the work done in raising

it. When the weight has been raised, we say it possesses potential energy owing to its position. We have, as it were, stored up so much work. The amount of potential energy possessed by the weight depends on the vertical height through which it is raised. It will be observed that the time taken in raising the weight does not influence the amount of work done. It would be exactly the same if done in one minute or one year.

But the rate of doing work depends on the amount of work done, and the time taken in doing it. The power is the amount of work done in one second or one minute. Suppose it takes 5 minutes to raise the 50 lb. weight through 10 ft. Then work done = $50 \times 10 = 500$ foot-pounds. Work done per minute = $\frac{500}{5} = 100$. Therefore power or rate of doing work = 100 foot-pounds per minute. It will be seen that power can be very large with only a small amount of work done, if the time taken in doing it be very short, or again, we can have a very large amount of work done with a small power, but in this case the time taken in doing the work will be large.

In the C.G.S. system the unit of weight is the gram and the unit of length is the centimetre, and therefore the unit of work is the work done in raising 1 gram vertically through 1 cm. This amount of work has been given a name, the "erg" (Greek for work).

Again with the power, the unit of time being the second, and the unit of work the erg. The unit of power is the rate of doing work equal to 1 erg per second, instead of the mechanical engineer's unit of 1 foot-pound per minute.

The units of work and power in the C.G.S. system are very small, and though very convenient for scientific purposes where the forces employed are of a small order, they are altogether too small for the present engineering work, for we should be often speaking of so many millions or billions of ergs. It would be comparable to using an inch rule to measure the length of England, or to speak of the weight of a battleship as so many pounds. For these large engineering measurements we must use some large multiple of the standard.

In electrical engineering the unit of work is known as the "joule," which is equal to 10,000,000 ergs, or 10^7 ergs. This amount of work is equal to .7373 foot-pound, or nearly three-quarters of the work done in raising 1 lb. through 1 ft. Our

engineering unit of power then becomes 1 joule per second instead of 1 erg per second, and this is known as the "watt."

The mechanical engineer's practical unit of power is known as the horse-power. It was first determined by James Watt, the inventor of the steam-engine, for he was always asked to provide an engine to replace so many horses, and he therefore had to find out the rate of doing work by the best horses throughout the whole working day. After repeated trials he fixed this at 33,000 foot-pounds per minute, or 550 foot-pounds per second.

1 watt is equal to .7373 foot-pound per second.

Therefore 1 h.p. = $\frac{550}{.7373} = 746$ watts, or 746 joules per second.

We have now to consider the electrical units of current, resistance and electro-motive force or potential difference, that we have been using in the last chapter.

The science of magnetism was known earlier than electrical science, and many of the magnetic units were fixed and used long before the phenomenon known as an electric current was discovered. One of the first discoveries in magnetism was that two magnetic poles would attract or repel, and again that the poles pointed approximately north and south, and that two poles which pointed in the same direction repelled each other, and two poles which pointed in opposite directions attracted each other. This attractive and repellent power was made a measure of the strength of magnetic poles in this way:—

Suppose we have two poles, exactly alike, and place them 1 cm. apart with their other poles far removed, then, if the force of attraction or repulsion be unit force (1 dyne), both poles shall be called unit poles.

If now one of these unit poles be placed 1 cm. away from any other pole, the force of attraction or repulsion in dynes is a measure of the strength of that pole.

As soon as it was discovered that an electric current gave rise to a magnetic field, it was seen that we might use the unit magnetic pole to measure also the strength of the current. But the magnetic field so created is continuous with the conductor carrying the current, and therefore the greater the length of the conductor we bring to bear on the unit pole, the greater would be the force exerted by it. We have therefore to take a unit length of

the conductor (1 cm.). But as the magnetic field varies not only with the strength of the current, but also on its distance from the unit magnetic pole, it follows that all parts of the 1 cm. length of the conductor must be at the same distance from the pole, and this distance must again be unit distance (1 cm.). We see, therefore, that to comply with the above requirements we must take 1 cm. length of the conductor, and bend it into an arc of 1 cm. radius, and place the unit magnetic pole at the centre. If now the current be adjusted till the force exerted on the unit magnetic pole be 1 dyne, then we have got the absolute unit current.

The unit so obtained was found to be inconveniently large, and so for practical purposes we take $\frac{1}{10}$ of its value as the unit, and this is known as the "ampere."

The unit of electro-motive force or electrical potential difference is measured indirectly, by measuring the work done in urging the unit quantity of electricity between any two points. This may not be clear at first sight, but let us consider the similar problem in mechanical engineering. Suppose we wish to measure the height of a building or tower, and imagine we have an instrument for measuring work done, then we could measure the height by finding how much work is done in lifting the unit quantity (1 lb.) to the top of the building. Suppose 500 foot-pounds of work are done, then the height is 500 ft.

But what is the unit quantity of electricity? We have seen (Chapter I.) that the current is the rate of flow, and is therefore equal to the quantity divided by the time. Therefore the unit quantity is the quantity of electricity that passes round the circuit in 1 second when a current of 1 *absolute unit* flows. The ampere is only $\frac{1}{10}$ of this current, and therefore the practical unit of quantity is only $\frac{1}{10}$ the absolute unit also. This practical unit is known as the "Coulomb."

The work done is measured by the quantity raised, multiplied into the height through which we raise it. In electrical work the potential difference is the equivalent of the vertical height in mechanics or the head in hydraulics, and therefore if v stands for the potential difference and Q for the quantity, the work done $w = Qv$ ergs (the erg being the unit of work). Therefore absolute unit potential difference exists between any two points when 1 erg of work is done in urging absolute unit quantity of electricity from one point to the other.

But for practical purposes we decided to take a unit for work equal to 10^7 ergs, and a unit for quantity equal to $\frac{1}{10}$ absolute unit, and therefore for practical purposes $\frac{1}{10} Q \times v = 10^7$ ergs.

$$\text{Therefore } v = \frac{10^7 \text{ ergs}}{\frac{1}{10} Q} = 10^8 \text{ absolute units.}$$

That is to say, the practical unit of electro-motive force or potential difference is equal to 100,000,000 absolute units, and this is known as the volt.

By Ohm's law the resistance is equal to $\frac{\text{e.m.f.}}{C}$, and therefore in absolute units a conductor has unit resistance if the absolute unit current flows in it when its ends are maintained at an e.m.f. of absolute unit value. For practical purposes, however, e.m.f. = 10^8 , and the current = $\frac{1}{10}$ absolute unit. Therefore the practical unit of resistance = $\frac{10^8 \text{ e.m.f.}}{\frac{1}{10} C} = 10^9$ absolute units = 1 ohm.

We have seen that work done is equal to Qv , and power is the rate of doing work = $\frac{\text{work done}}{\text{time}}$. Therefore $\frac{Qv}{t} = \text{power}$. But $\frac{Q}{t}$ is the measure of the current, and therefore $\frac{Q}{t} \times v$ is the measure of the power = vc . We have also seen that for practical purposes $v = 10^8$ and $c = \frac{1}{10}$ absolute unit, and the absolute unit of power is 1 erg per second.

Therefore $\frac{Qv}{t} = cv = \frac{1}{10} \times 10^8 = 10^7$ ergs per second, that is, 1 joule per second, or 1 watt.

Therefore the product of the e.m.f. in volts and the current in amperes gives us the power in watts.

This is similar to the mechanical engineer's method of measuring power. It is not sufficient to consider the current or the pressure alone, as we see by referring back to Fig. 1. When the pump is at work and a current flowing through the pipes, the circuit is absorbing a certain amount of power. Suppose we suddenly turn off tap T, the current will stop, and the circuit is now absorbing no power though there is still a difference of pressure in the circuit. We therefore see that a current is necessary before we can speak of the power. But the current that flows is not a measure of the power in the circuit, for it is

possible to have a large current flowing and still very little power, whereas in another circuit the current may be relatively very small while the power in the circuit is very large. The power depends in part on the current strength, and also on the value of the pressure under which the current flows.

This may be further illustrated by considering a hydraulic lift. We have often seen a large heavy cage full of passengers being raised at a certain rate to the top of some building. This is done by allowing water to enter a long narrow cylinder containing a very good fitting rod of steel attached to the under side of the floor of the cage. As the water enters at the bottom, it pushes the rod or ram out of the way, and consequently the lift is raised.

Now, comparatively speaking, very little water is required to raise the lift to its full extent, and therefore the current is small, but the water is forced into the cylinder under a pressure of perhaps 2,000 lbs. on each square inch, and the water is thus given enough working power to enable it to raise the heavy weight of the lift at a fairly rapid rate.

It therefore follows that the power possessed by the water depends on the pressure or head of water, and on the current that flows, for if the current flows under a very small head it possesses but a very small amount of power, and if there be no current we absorb no power, whatever the pressure may be. To get the value of the power we must therefore multiply the current flowing by the pressure.

It will be noticed that if we only partially turn on the tap, water will enter the cylinder at a slower rate, that is to say, the current will be smaller, consequently the lift will be raised at a slower rate, though even at a slower rate we should eventually arrive at the top. But the lift cannot be raised from the bottom to the top without a certain definite amount of work being done, consequently whether we move quickly or slowly to the top will not make any difference in the amount of work done, it is only the rate of working that will be different. Evidently the power we employed in moving the lift when the tap was only partially turned on was less than when the tap was full on, for the current was less while the pressure in the two cases was the same. In the one case we used the smaller power for a longer time, and in the other case the larger power for a shorter time.

Q. 1. An incandescent electric lamp takes a current of .6

ampere when joined to mains at a difference of potential of 100 volts. What power is spent in the lamp?

$$\text{Power} = \text{volts} \times \text{amperes.}$$

Therefore the power spent in the lamp = $100 \times .6 = 60$ watts.

Q. 2. A circuit has a resistance of 5 ohms, and is joined to a dynamo that is generating an e.m.f. of 50 volts.

(1) What is the current flowing through the circuit? and (2) What is the power being absorbed?

$$\text{The current by Ohm's law} = \frac{E}{C} = \frac{50}{5} = 10 \text{ amperes.}$$

The power absorbed is equal to $C \times V$ watts = $10 \times 50 = 500$ watts.

Q. 3. A dynamo is delivering a current of 100 amperes. Its resistance is .02 ohm. What is the amount of power spent in the dynamo itself?

The e.m.f. spent in getting 100 amperes through the dynamo is, by Ohm's law, equal to the current through the dynamo, multiplied by the resistance of the dynamo.

$$\text{Therefore e.m.f. spent on dynamo} = 100 \times .02 = 2 \text{ volts.}$$

The power spent in the dynamo is equal to $C \times V$ watts = $100 \times 2 = 200$ watts.

Q. 4. A resistance of 2 ohms is put into a circuit, which then makes the total resistance of the circuit equal to 10 ohms. The e.m.f. in the circuit is 100 volts. What is the power being absorbed by this added resistance?

The power absorbed in watts is equal to the e.m.f. on the added resistance, multiplied by the current through the added resistance.

The volts spent on the added resistance is, by Ohm's law, equal to the current through it, multiplied by the resistance of it.

Therefore volts spent on added resistance = current through it $\times 2$.

The current through the added resistance is equal to—

$$\frac{\text{e.m.f.}}{\text{resistance}} = \frac{100}{10} = 10 \text{ amperes.}$$

Therefore volts spent on added resistance = $10 \times 2 = 20$ volts.

The power absorbed by the added resistance = e.m.f. on it \times current = $20 \times 10 = 200$ watts.

We might write, for the power absorbed, C^2R instead of e.m.f. $\times C$, because, by Ohm's law, the e.m.f. is equal to the current \times

resistance, and if we put $(C \times R)$ instead of e.m.f. we could write $(C \times R) \times C = C^2R$. In this case, no useful work is done, the power being simply frittered away in heating the resistance, and C^2R is a measure of the heat being developed in any circuit. Useful work is done or energy is stored only when a back e.m.f. is introduced into the circuit. Thus, if we want work done by an electric motor, then the motor must develop a back e.m.f., which it does the moment it starts rotating, otherwise our energy will be spent in simply warming the motor conductors. When the motor rotates

and develops a back e.m.f., the current is then equal to $C = \frac{E - e}{R}$

where E is the e.m.f. used to drive the motor (called the impressed e.m.f.) and e is the back e.m.f. developed by the motor, while R is the resistance of the circuit. If therefore $C = \frac{E - e}{R}$ it follows by

simply transposing the equation that $E = CR + e$, and the power supplied being equal to $E \times C$ is therefore equal to—

$$(CR + e) C = C^2R + eC.$$

C^2R is the fraction of the power being supplied that goes to heat the motor and other parts of the circuit, while eC is the power transformed into mechanical work by the motor = eC watts.

CHAPTER III.

SERIES AND PARALLEL CIRCUITS.

CURRENT DENSITY AND POTENTIAL DROP IN THE CIRCUIT.

IN the simple circuits considered up to this point, all the power put into the circuit is transformed into heat, and unless the heat is utilised for lighting or other purposes, the power is wasted.

Let us consider the absorption of power at the different parts of the circuit. We have seen that the power = vc , and also that v is proportional to R . The current being of the same strength throughout, it follows that the power absorbed at different parts of the circuit is proportional to the resistances of the different parts. Referring again to Fig. 4, and taking the resistance of the dynamo as equal to .02 ohm, the resistance inside the

premises is, according to Ohm's law, $R = \left(\frac{\text{c.m.f.}}{c} \right)$ - resistance of

mains and dynamo. Therefore $R = \left(\frac{1000}{100} \right) - .04 = 1 - .04 = .96$ ohm. How is the power distributed in this circuit? The power at each part = vc . Therefore the power spent on the mains = voltage drop on the mains \times current in mains. But voltage drop on the mains, by Ohm's law, is equal to the current flowing in the mains \times resistance of the mains, and therefore we can write $c \times R$ instead of v .

Therefore power spent on mains = $vc = (c + R)c = c^2R = 100^2 \times .02 = 200$ watts. This amount of power is simply wasted (in this case) in urging the current through the mains, and it manifests itself in heating the mains.

The same applies to the dynamo, for there we have in our supposed case another resistance of .02 ohm, and as the current flows through it we get there another waste of energy of 200 watts = $\frac{200}{748}$ horse-power, which makes the dynamo conductors warm.

Inside the premises we have power utilised equal to $C^2R = 100^2 \times .96 = 9600$ watts or $\frac{9600}{746} = 12.86$ horse-power.

The power spent on the mains and dynamo is of great importance in practice, for it limits the carrying capacity of both.

We have very frequently spoken of the *resistance* of the mains and the resistance of different parts of the circuit, but the resistance can be varied in ways we will now consider.

If we take a piece of wire having a known resistance, and cut it into two equal lengths, we find on measuring that each piece has just half the resistance of the former piece, that is to say, the resistance of a given wire of uniform section is proportional to its length.

But the resistance also depends upon the sectional area. Thus, if we take three pieces of wire made from the *same* material, but having sectional areas in the proportion of $1 : 2 : 3$, and cut them all to the *same* length, we find their resistances to be in proportion of $1 : \frac{1}{2} : \frac{1}{3}$. That is to say, their resistances are *inversely* proportional to their sectional areas.

The student must be careful here to remember that the ratio of the sectional areas is not the same thing as the ratio of their diameters. It will not do to say the resistances of two wires of the same material are as $1 : 2$ because their diameters are as $2 : 1$, for such would be altogether wrong, the area of a circle being proportional to the square of the diameter. As an example, suppose we have two rods, one 3 in. diameter and the other 6 in. diameter, then their diameters are in the ratio of $1 : 2$, but their areas are in the ratio of $3^2 : 6^2$ or $1 : 4$. So that if these rods were of the same material and of equal length, the 3 in. diameter one would have four times the resistance of the 6 in. one.

The resistance of conductors also varies very largely with the nature of the material used. For instance, if we take three different wires, all the same length, and the same in sectional area, but one made of copper, another of iron, and the third of german silver, their resistances would be in the ratio of $1 : 6 : 13$. It is useful to remember these figures as being approximately correct, for the three metals named are in great demand in electrical engineering.

The following is a list of the most commonly used metals, with their relative resistances and specific resistances:—

| Metal. | Relative Resistance. | Specific Resistance. |
|-------------------------|----------------------|----------------------|
| Silver - - - - - | 1.000 | .00000150 |
| Copper, soft - - - - - | 1.063 | .00000160 |
| „ hard drawn - - - - - | 1.086 | .00000163 |
| Aluminium - - - - - | 1.985 | .00000291 |
| Zinc - - - - - | 3.741 | .00000562 |
| Platinum - - - - - | 6.022 | .00000905 |
| Iron - - - - - | 6.460 | .00000971 |
| Lead - - - - - | 13.05 | .00001963 |
| German silver - - - - - | 13.92 | .00002093 |
| Mercury - - - - - | 62.73 | .00009432 |

The third column headed specific resistance is giving the resistance of unit length of the different metals each having unit sectional area. The unit here used is not the English “inch,” but the French “centimetre,” and the area is the square centimetre. There are 2.54 cm. in 1 in., therefore the unit length of metal of unit sectional area would represent a small cube of the metal about $\frac{3}{8}$ in. across the face.

The specific resistance really shows us the influence of the nature of the material spoken of above, for here the metals, when reduced to unit length and unit sectional area, have quite different resistances.

The table is very useful if the specific resistances can be remembered, for we can then calculate at once the resistance of any wire by simply measuring its length and its sectional area. The student should therefore try to remember the specific resistance of the three common metals used, viz., copper = .0000016, iron = .00001, and german silver = .000021. A few examples will show the use of this table.

We have already seen that the resistance of a conductor is proportional to its length and to its specific resistance, and inversely proportional to its sectional area. This can be written in the form of a simple equation, thus—

$$R = \frac{\text{length}}{\text{section}} \times \text{sp. res.}$$

Q. A copper wire .05 sq. cm. in section is 1,000 cm. long. What is its resistance?

$$\text{Here } R = \frac{\text{length}}{\text{section}} \times \text{sp. res.}$$

$$\text{Therefore } R = \frac{1000}{.05} \times .0000016 = .032 \text{ ohm.}$$

Note.—It must be remembered that in using this formula the length *must* be in centimetres, and the sectional area *must* be in square centimetres, because the specific resistance is given as the resistance of 1 cm. length having a sectional area of 1 sq. cm. Of course we could take values for the specific resistance corresponding to 1 in. length having 1 sq. in. sectional area, and this is often done. The values in these units can easily be calculated by multiplying the values given for 1 cub. cm. by 2.54 and dividing the result by 6.45. This is equivalent to multiplying by .393. For copper, this is equal to .00000066.

Q. A coil is wound with 500 yds. of copper wire having a sectional area of .002 sq. cm. What is its resistance?

Here 500 yds. must be brought to centimetres. There are 2.54 cm. in 1 in.; and therefore 36 times 2.54 cm. in 1 yd. = 91.44 cm.; and therefore 500 times 91.44 cm. in 500 yds. = 45720 cm.

$$\text{Again } R = \frac{\text{length}}{\text{section}} \times \text{sp. res.}$$

$$\text{Therefore } R = \frac{45720}{.002} \times .0000016 = 36.5 \text{ ohms.}$$

Q. If we substitute german silver of the same size and length for the copper in the last case, what difference will it make in the resistance?

$$R = \frac{\text{length}}{\text{section}} \times \text{sp. res.}$$

$$\text{Therefore } R = \frac{45720}{.002} \times .00002 = 457 \text{ ohms.}$$

Q. A bobbin is closely wound with copper wire whose sectional area is .01 sq. cm. Its resistance = 2 ohms. What length of wire is there on the bobbin?

$$\text{Again } R = \frac{\text{length}}{\text{section}} \times \text{sp. res.}$$

$$\text{Therefore } 2 = \frac{\text{length}}{.01} \times .0000016.$$

$$\text{Therefore length} = \frac{2 \times .01}{.0000016} = 12500 \text{ cm.}$$

Or if wanted in yards, we divide 12500 by 2.5, the number of centimetres in 1 in., and divide the answer by 36, the number of inches in 1 yd., or—

$$\frac{12500}{2.5 \times 36} = 139 \text{ yds. on bobbin.}$$

Q. A 10 ohm resistance of iron wire has a sectional area of .1 sq. cm., but is found to be too small to carry the required current. It is proposed to replace the iron by german silver wire of twice the sectional area. What length of wire will be required?

$$\text{Here again } R = \frac{\text{length}}{\text{section}} \times \text{sp. res.}$$

$$\text{Therefore } 10 = \frac{\text{length}}{.2} \times .00002.$$

$$\text{Therefore length} = \frac{10 \times .2}{.00002} = 100000 \text{ cm.} = 1111 \text{ yds.}$$

Q. What was the length of the iron wire replaced by the german silver?

The same equation gives us it:—

$$R = \frac{\text{length}}{\text{section}} \times \text{sp. res.}$$

$$\text{Therefore } 10 = \frac{\text{length}}{.1} \times .00001.$$

$$\text{Therefore length} = \frac{10 \times .1}{.00001} = 100000 \text{ cm.} = 1111 \text{ yds.}$$

That is, a certain length of german silver wire replaces the *same* length of iron wire of half the sectional area, leaving the resistance the same. The student will notice that this is only approximately correct, for the values taken for the specific resistance of iron and german silver are not exactly those given in the table, but approximations easy to remember. If it is desired to have the result exact, then .00000971 must be taken for iron, and .00002093 for german silver, but for a large number of cases the figures we have been working with will be found to be sufficiently near at this stage and easy to remember.

Q. Show how you would calculate the length and sectional area of a wire to have a certain resistance, and just fill the winding space of a bobbin of given dimensions, neglecting the space occupied by insulation.

First, imagine the winding space on the bobbin to be filled with solid copper forming one turn. We can calculate the length and cross section of this, and calculate its resistance r —

$$r = \frac{l}{sa} \times \text{sp. resistance.}$$

Calling the required resistance of the wire R we then have—

$$r : R :: \frac{l}{sa} \text{ of solid} : \frac{l}{sa} \text{ of wire.}$$

$$\text{Therefore } \frac{l}{sa} \text{ of wire} = R \times \frac{\frac{l}{sa} \text{ of solid}}{r}$$

Now the required length of wire \times sectional area of the wire is equal to the volume of the solid copper, which has already been calculated.

If we therefore multiply the volume of the solid copper (or length \times sectional area) by the $\frac{\text{length}}{\text{sec. area}}$ we get the length².

Taking the square root and dividing this into the volume, we get the sectional area.

This will perhaps be followed easier by taking a case. Suppose the wire is required to have a resistance of 50 ohms, and the bobbin be 3 in. long in the winding space, 2.5 in. outside and .5 in. inside diameter, then the mean diameter = 1.5 in., and the length of the solid copper = 1.5 \times π in., and its sectional area = 3 \times 1 = 3 sq. in.

Volume of the copper filling the winding space = length \times sectional area = 1.5 \times π \times 3 cub. in.

Resistance of the solid copper

$$= r = \frac{1.5 \times 3.1416}{3} \times .00000066 = .000001038 \text{ ohms}$$

(.00000066 being the sp. res. of copper in cubic inches).

$$\therefore .000001038 : 50 :: \frac{1.5 \times \pi}{3} : \frac{l}{sa} \text{ of wire.}$$

$$\therefore \frac{\text{length}}{\text{sec. area}} \text{ of wire} = \frac{1.5 \times 3.1416 \times 50}{3 \times .000001038} = 77000000.$$

The length \times sec. area = $1.5 \times \pi \times 3 = 14.1372$.

$$\therefore \frac{l}{sa} \times l \times sa = l^2 = 77000000 \times 14.1372 = 1088544000 \text{ in.}$$

$$\therefore l = \sqrt{1088544000} = 32996 \text{ in.} = 916 \text{ yds.}$$

$$\text{Sectional area} = \frac{14.1372}{32996} = .0004 \text{ sq. in.}$$

If we take a piece of wire whose resistance is 1 ohm, and apply an e.m.f. to the ends of it, we find that it is able to conduct electricity. We might say that this piece of wire has unit conducting power, or unit conductivity, as well as unit resistance.

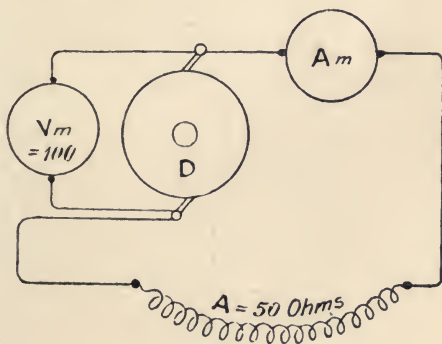

Fig. 5.

If we take another piece of the same wire, but twice the length of the former piece, it will have twice the resistance, that is, it will conduct electricity only half as well as the former piece, consequently we should say this piece of wire has a resistance = 2 and a conductivity = $\frac{1}{2}$. Again, if we take a wire having a resistance of 10 ohms, then it will conduct electricity only $\frac{1}{10}$ as well as the piece having 1 ohm. Therefore we should say its conductivity is $\frac{1}{10}$, and so on.

We thus see that the conductivity of a substance is the reciprocal or the reverse of its resistance. If the resistance of a conductor be 50 ohms, its conductivity is $\frac{1}{50}$. A name has been given to the unit of conductivity which is easy to remember. Seeing that conductivity is the reverse of resistance, the name of the unit of resistance (ohm) has been reversed for that of conduc-

tivity. Thus a wire of 1 ohm resistance has 1 mho conductivity. A wire of 75 ohms resistance has a conductivity of $\frac{1}{75}$ mho, while a wire of $\frac{1}{2}$ ohm resistance has a conductivity of 2 mhos.

Of course it will be understood that if conductivity is the reciprocal of resistance, then resistance is also the reciprocal of conductivity, one the reverse or reciprocal of the other. Therefore a wire of $\frac{1}{50}$ mho conductivity has a resistance of $\frac{1}{\frac{1}{50}} = 50$ ohms.

We have now to consider circuits other than the simple circuits described in the last chapter, known as divided circuits or parallel circuits.

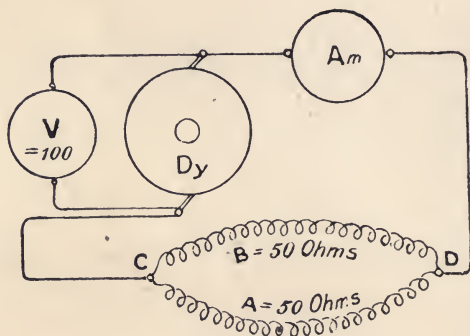

Fig. 6.

Fig. 5 represents a simple circuit in which the principal resistance consists of a conductor A of 50 ohms resistance; the remainder of the circuit consists of a dynamo capable of generating an e.m.f. of 100 volts, and thick connecting wires joining it to the ends of A.

If we neglect for the present the small resistances of the dynamo and connecting wires, then the current flowing $= c = \frac{E}{R} = \frac{100}{50} = 2$ amperes.

Suppose we now join the points C and D with another conductor B exactly similar to A, as in Fig. 6. Will the current through the dynamo be greater or less than before? And will it make any difference to the current flowing through A? Let us

see. A can conduct electricity across between c and D, its conductivity being $\frac{1}{50}$ mho, that is, it will conduct electricity across only $\frac{1}{50}$ as well as a resistance of 1 ohm. But we have now got two paths, each with a conductivity of $\frac{1}{50}$ mho, so the two together can conduct electricity across twice as well as one of them, for now we have a conductivity of $\frac{1}{50} + \frac{1}{50} = \frac{2}{50}$ mho. We have already seen that resistance is the reciprocal of conductivity, therefore the resistance between c and D is now $\frac{1}{\frac{2}{50}} = 25$ ohms. But it was 50 ohms before we joined the second wire across, so that we have reduced the resistance to half its former value, and by

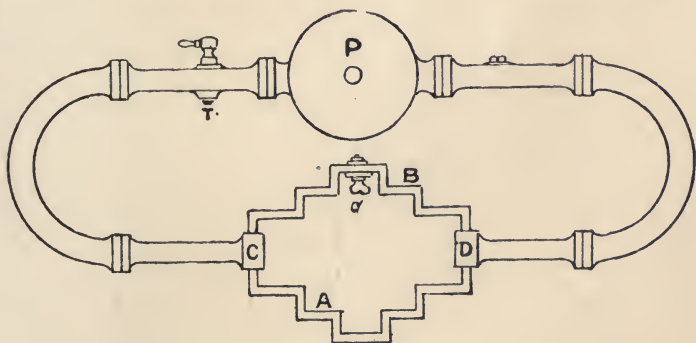

Fig. 7.

Ohm's law the current through the dynamo has doubled, for $c = \frac{E}{R} = \frac{100}{25} = 4$ amperes; 2 amperes through A, and 2 amperes through B.

To make this quite clear, let us take our water analogy again. Fig. 7 represents a water circuit similar to our last electrical circuit. If the pump be working continuously, maintaining a difference of pressure between its ends, then with T turned on and t turned off, we should have a flow of water round the circuit through A, which would offer the principal resistance of the circuit, and the current gauge would indicate a certain current flowing through the pump. If now we turn on tap t , we open up another path for the water to flow in, and consequently, as water will flow in B just as easily as in A, the resistance to the passage of water from c

to D would be halved, and the current gauge would immediately indicate twice the former current. The two pipes in parallel are really equivalent to one pipe of twice the internal sectional area. The same thing would apply to 3, 4, 10, or any number of similar pipes joined between c and D; the resistance would be reduced to $\frac{1}{3}$, $\frac{1}{4}$, or $\frac{1}{10}$ its former value, with a corresponding increase in the current flowing through the pump.

It must be understood that there is no increase in the current flowing through any individual pipe when others are connected across. The current in A, Fig. 7, for instance, would remain practically constant throughout, providing the pump maintained the same difference of pressure.

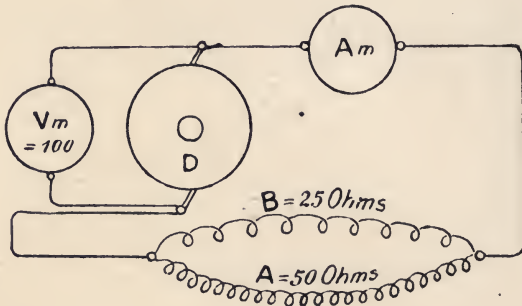

Fig. 8.

It is in this way that we must look upon the electrical current in Fig. 6. The more similar wires we join between c and D, the more are we increasing the conductivity between these points, and the less is the resistance becoming, but providing the dynamo maintains the difference of potential, no alteration would take place in the value of the current in any individual conductor. Each separate conductor would act according to Ohm's law, and each being joined to points, maintained at the same difference of potential, and each being of the same resistance, each must have the same strength of current flowing through it.

The case where all the wires joined across c and D, Fig. 6, have equal resistances, is perhaps the most simple, but it is not a very great stride to pass to the case where the resistances of the conductors vary.

Consider Fig. 8. Here we have c and D joined by two wires, A having a resistance of 50 ohms, and B having a resistance of 25 ohms.

Now we have seen that A has a conductivity or conducting power = $\frac{1}{50}$, similarly B has a conductivity = $\frac{1}{25}$, and therefore the two together have a conductivity of $\frac{1}{50} + \frac{1}{25} = \frac{3}{50}$ mho. The resistance between c and D being the reciprocal of the conductivity

$$\text{is} = \frac{1}{\frac{3}{50}} = \frac{50}{3} = 16.6 \text{ ohms}$$

(less than the smallest resistance).

The current flowing through the dynamo now is—

$$C = \frac{E}{R} = \frac{100}{16.6} = 6 \text{ amperes.}$$

Again, imagine c and D to be connected by three wires, A = 50 ohms, B = 25 ohms, and G = 10 ohms. Then the conductivity between

$$C \text{ and } D = \frac{1}{50} + \frac{1}{25} + \frac{1}{10} = \frac{1+2+5}{50} = \frac{8}{50} \text{ mho,}$$

and the resistance between

$$C \text{ and } D = \frac{1}{\frac{8}{50}} = \frac{50}{8} = 6.25 \text{ ohms}$$

(again less than the smallest resistance joining c and D).

Of course the combined resistance must be less than that of the smallest resistance between the points, for if G were there alone, that part of the circuit would have 10 ohms resistance, and the addition of B and A, though larger than G, is only diminishing the resistance between these points by opening up other paths for the passage of electricity.

Q. 1. What is the resistance of four wires in parallel of 2, 5, 10, and 20 ohms respectively?

The combination has a conductivity of—

$$\frac{1}{2} + \frac{1}{5} + \frac{1}{10} + \frac{1}{20} = \frac{10+4+2+1}{20} = \frac{17}{20} \text{ mho,}$$

and their combined resistance in parallel

$$= \frac{1}{\frac{17}{20}} = \frac{20}{17} = 1.176 \text{ ohms.}$$

Q. 2. Two mains are carrying current for a group of twenty lamps; each lamp has a resistance when incandescent (white hot)

of 160 ohms, and they are all joined in parallel. What is the resistance between the two mains?

Here all the resistances being of equal value, the total resistance is $\frac{1}{20}$ that of one of them or $\frac{160}{20} = 8$ ohms. Or working out as before—

$$\text{Conductivity} = \frac{1}{160} + \frac{1}{160} + \frac{1}{160} \dots \frac{1}{160} = \frac{20}{160}$$

$$\text{and resistance} = \frac{1}{\frac{20}{160}} = \frac{160}{20} = 8 \text{ ohms.}$$

Q. 3. Suppose these mains to be at a p.d. of 100 volts, what current will be flowing through them?

$$\text{Ohm's law says } c = \frac{E}{R}$$

$$\text{Therefore } c = \frac{100}{8} = 12.5 \text{ amperes.}$$

If we have only to deal with two wires in parallel, it will be easier and quicker to remember that the product of the two resistances divided by their sum gives the resistance of the two in parallel.

Q. 4. Two wires of 5 ohms and 20 ohms are in parallel. What is their combined resistance?

$$R = \frac{\text{product}}{\text{sum}} = \frac{5 \times 20}{5 + 20} = \frac{100}{25} = 4 \text{ ohms.}$$

Working by our first method we have—

$$\text{Conductivity} = \frac{1}{5} + \frac{1}{20} = \frac{5}{20}$$

$$\text{Resistance} = \frac{1}{\frac{5}{20}} = \frac{20}{5} = 4 \text{ ohms.}$$

If we have more than two wires in parallel the result could still be obtained by this second method, but it involves more time in comparison with the first method.

Q. 5. Three wires of 5, 10, and 20 ohms respectively are joined in parallel. What is the resistance of the combination?

Take the 5 and the 10 ohms first. The resistance of these two in parallel $= \frac{5 \times 10}{5 + 10} = \frac{50}{15} = 3.33$ ohms. That is to say, a wire of 3.33 ohms could take the place of the 5 and 10 ohm wires in parallel. Next take this equivalent resistance and the 20 ohms

The resistance of these in parallel

$$= \frac{3.33 \times 20}{3.33 + 20} = \frac{66.6}{23.33} = 2.85 \text{ ohms.}$$

Or, 2.85 ohms is equivalent to the 5, 10, and 20 ohms in parallel.

By the first method—

$$\text{Conductivity} = \frac{1}{5} + \frac{1}{10} + \frac{1}{20} = \frac{4 + 2 + 1}{20} = \frac{7}{20}$$

$$\text{Resistance} = \frac{1}{\frac{7}{20}} = \frac{20}{7} = 2.85 \text{ ohms.}$$

Nearly all circuits will be found to have a certain amount of resistance in series with the paralleled conductors. Thus in Fig. 9 we have a dynamo producing an e.m.f. of 100 volts. It is joined to a resistance *A* of 2 ohms, and to a resistance *b* of 3 ohms. The

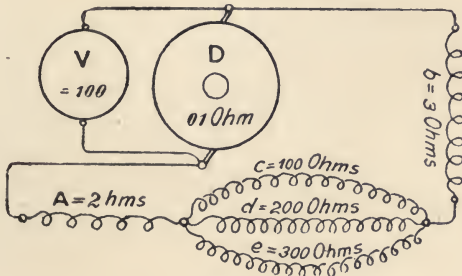

Fig. 9.

ends of *a* and *b* are joined to three wires in parallel, *c* = 100 ohms, *d* = 200 ohms, and *e* = 300 ohms, while the resistance of the dynamo itself = .01 ohm. What is the current flowing through the dynamo?

Ohm's law again helps us: $c = \frac{E}{R}$

$$\text{Therefore } c = \frac{100}{2 + 3 + .01 + (c, d, \text{ and } e \text{ in parallel})}$$

But *c*, *d*, and *e* in parallel

$$= \frac{1}{\frac{1}{100} + \frac{1}{200} + \frac{1}{300}} = \frac{1}{\frac{6 + 3 + 2}{600}} = \frac{1}{\frac{11}{600}} = \frac{600}{11} = 54.545 \text{ ohms.}$$

$$\text{Therefore } c = \frac{E}{R} = \frac{100}{59.555} = 1.679 \text{ amperes.}$$

Q. 6. What is the p.d. spent on the dynamo, on a , on b , and on the three wires in parallel?

p.d. spent on dynamo = resistance of dynamo \times c .

\therefore spent on dynamo = $.01 \times 1.679 = .0168$ volts.

p.d. spent on a = resistance of $a \times c$ through a .

\therefore spent on a = $2 \times 1.679 = 3.358$ volts.

p.d. spent on b = resistance of $b \times c$ through b .

\therefore spent on b = $3 \times 1.679 = 5.037$ volts.

p.d. spent on c, d , and e = resistance of $c, d, e \times c$ through c, d, e .

\therefore spent on c, d , and e = $54.545 \times 1.679 = 91.581$ volts.

If we total up the e.m.f.'s on the different parts of the circuit we find—

e.m.f. spent on dynamo = $.0168$ volts.

e.m.f. spent on a = 3.358 „

e.m.f. spent on b = 5.037 „

e.m.f. spent on c, d, e = 91.581 „

Total 99.9928 „

Note.—The very small difference between this total and the 100 volts given by the dynamo is due to the decimal places not being worked out completely. The student should notice, however, that the difference is exceedingly small, only $\frac{7}{10000}$ volt, and in all such cases it is almost absurd to talk of the difference, for it requires careful measurement with sensitive instruments to measure such a difference.

Q. What is the value of the current flowing in c, d , and e respectively?

The current in $c = \frac{\text{e.m.f. on ends of } c}{\text{resistance of } c}$

Therefore current in $c = \frac{91.581}{100} = .916$ ampere.

The current in $d = \frac{\text{e.m.f. on ends of } d}{\text{resistance of } d}$

Therefore current in $d = \frac{91.581}{200} = .458$ ampere.

The current in $e = \frac{\text{e.m.f. on ends of } e}{\text{resistance of } e}$

Therefore current in $e = \frac{91.581}{300} = .305$ ampere.

Total current in the three

= $.916 + .458 + .305 = 1.679$ amperes.

We here notice that the wires c , d , and e have resistances in the ratio of 1 : 2 : 3, and the same p.d. is applied to the ends of all, therefore by Ohm's law the currents being inversely proportional to the resistances should be in the ratio of $1 : \frac{1}{2} : \frac{1}{3}$, which we find to be the case.

Q. 7. A battery of 53 cells gives an e.m.f. of 106 volts, and has a resistance of .005 ohm. It is joined to mains having a resistance of .2 ohm. At the further end of the mains 50 similar lamps are joined across in parallel. The ammeter indicates a current flowing in the mains of 30 amperes. (1.) What is the total resistance of the circuit? (2.) What is the resistance from one main to the other? And (3.) What is the resistance offered by each lamp?

By Ohm's law—

$$\text{Total resistance of circuit} = \frac{\text{total e.m.f. in circuit}}{\text{total current in circuit}}$$

$$\text{Therefore } R = \frac{106}{30} = 3.533 \text{ ohms.}$$

This 3.533 ohms is made up of—

$$\text{Resistance of battery} = .005 \text{ ohm.}$$

$$\text{Resistance of mains} = .2 \quad ,,$$

$$\text{Resistance of 50 lamps in parallel} = x \quad ,,$$

$$\text{Therefore } x = 3.533 - .205 = 3.328 \quad ,,$$

The resistance of the 50 lamps in parallel being equal to 3.328 ohms, 1 lamp would have a resistance of 50 times 3.328 ohms, seeing that they have all the same resistance, for we have already seen that the resistance of say 50 similar resistances in parallel is equal to $\frac{1}{50}$ that of one of them.

$$\text{Therefore the resistance of 1 lamp} = 50 \times 3.328 = 166.4 \text{ ohms.}$$

Q. What is the p.d. on the ends of the lamps in the last problem, and what is the voltage spent on the mains and on the battery in getting the current through them?

Again by Ohm's law—

p.d. on lamps = current through the lamps \times resistance on the lamps.

$$\text{Therefore p.d. on lamps} = 30 \times 3.328 = 99.84 \text{ volts.}$$

It should be noticed that it does not matter whether we take the lamps collectively or singly in working the problem, but if we

take a single lamp we must remember that the p.d. on the ends of a single lamp (which is the same as on all the lamps) is equal to the current flowing through the single lamp multiplied by the resistance of the single lamp. These lamps being similar, the current through 1 lamp is equal to $\frac{1}{50}$ of the total current, or $\frac{30}{50} = .6$ ampere.

Therefore p.d. on the ends of 1 lamp = $.6 \times 166.4 = 99.84$ volts.

Again, the p.d. spent on the mains = current in mains \times resistance of mains = $30 \times .2 = 6$ volts.

And the p.d. spent on the battery is = current through the battery \times resistance of the battery.

Therefore p.d. spent on the battery = $30 \times .005 = .15$ volt.

It was pointed out previously that the resistance of any conductor R is equal to $\frac{\text{length}}{\text{sec. area}} \times$ specific resistance. Now by Ohm's law the voltage drop on a conductor is equal to current flowing through it \times resistance of it. Therefore the voltage drop

$$= v = c \left(\frac{l}{\text{sec. area}} \times \text{sp. res.} \right)$$

For any given material the specific resistance is constant, and in that case the voltage drop is proportional to the current $\times \frac{\text{length}}{\text{sec. area}}$. Again, for any given length of the same material, the voltage drop is proportional to the current $\times \frac{1}{\text{sec. area}}$ or to $\frac{\text{current}}{\text{sec. area}}$, that is, to the current we send through unit sectional area. This last statement is known as the current density, and therefore in considering the voltage drop in copper mains we say voltage drop per yard (or per foot, or per mile, whichever is most convenient) is proportional to the *current density*.

A very common current density for mains and wiring is 1,000 amperes per square inch. Let us see what is the voltage drop per yard at this current density—

$$v \text{ drop} = c \left(\frac{l}{\text{sec. area}} \times \text{sp. res.} \right)$$

In this case it will not do to use the value for specific resistance given in the table of specific resistances, unless we convert the

yard length to centimetres and the sectional area of 1 sq. in. to square centimetres. In this case, as in many others, it is more convenient to change the specific resistance to that of 1 cub. in. This is equal to .66 microhm or .00000066 ohm. If this value be taken for the specific resistance, then the length (1 yd.) must be expressed in inches, and the sectional area in square inches.

$$\text{Therefore } v \text{ drop} = 1000 \left(\frac{3.6}{1} \times .00000066 \right) = 36000 \times .00000066 = .02376 \text{ volt per yard.}$$

This is the voltage that would be spent on a single length of cable 1 yd. long at 1,000 amperes per square inch. But cables generally run in pairs, for we must make arrangements for bringing the current back as well as taking it from the dynamo, *i.e.*, we must have a complete circuit. Therefore in a pair of mains we have $.02376 \times 2 = .0475$ volt drop per yard at 1,000 amperes per square inch. At any other current density the change in voltage drop will be in proportion to the change in the current density.

It must be properly realised that the current density depends on both the current and the sectional area. The cable may be small in sectional area, but if the current is also small, the current density will not be large. Thus current = 2,000 amperes, sectional area of mains = 2 sq. in., current density = 1,000 amperes per square inch. Again, current = 2 amperes, sectional area of wire = .002 sq. in., current density = 1,000 amperes per square inch, and we should get exactly the same voltage fall per yard in the two cases.

Q. 1. A pair of mains are required to carry 250 amperes to a building 50 yds. away. The maximum allowable voltage fall = 2 volts. What must be the sectional area of the mains?

At 1,000 amperes per square inch the voltage fall would be equal to $.0475 \times 50 = 2.375$ volts. Therefore we cannot run them at so high a current density as this. What, then, must be the current density? We have seen that the voltage fall is proportional to the current density.

Therefore $2.375 \text{ volts} : 2 \text{ volts} :: 1000 \text{ amps. sq. in.} : x \text{ amps. sq. in.}$

$$\text{Therefore } x \text{ amperes per square inch} = \frac{1000 \times 2}{2.375} = 842.$$

At a current density of 842 amperes per square inch we shall have 2 volts fall on the 50 yds.

$$\text{But current density} = \frac{\text{current}}{\text{sec. area}}$$

$$\text{Therefore sec. area} = \frac{\text{current}}{\text{current density}}$$

$$\text{Therefore sec. area} = \frac{250}{842} = .29 \text{ sq. in.}$$

Q. 2. A supply station is 100 yds. from a certain feeding point. Voltage of supply = 100 volts. Find the size of the feeders required to supply 125 amperes, 105 volts being maintained at the station end. Here voltage fall allowable = 5 volts, and at 1,000 amperes per square inch voltage fall = $.0475 \times 100 = 4.75$ volts.

Therefore 4.75 volts : 5 volts :: 1000 amps. sq. in. : x amps. sq. in.

$$\text{Therefore } x \text{ amperes per square inch} = \frac{1000 \times 5}{4.75} = 1052.$$

But current to be delivered = 125 amperes.

$$\text{Therefore sectional area} = \frac{125}{1052} = .118 \text{ sq. in.}$$

Q. 3. Find the diameter of the copper required.

$$\text{Sectional area} = \text{diameter}^2 \times \frac{\pi}{4}$$

$$\text{Sectional area} = \text{diameter}^2 \times .7854.$$

$$\text{Therefore (diameter)}^2 = \frac{\text{sec. area}}{.7854} = \frac{.118}{.7854} = .1502.$$

$$\text{Therefore diameter} = \sqrt{.1502} = .38 \text{ in.}$$

or a little more than $\frac{1}{3}$ in.

Q. 4. In a water-power plant, the dynamo which produces a fixed p.d. between its terminals of 120 volts is 300 yds. away from the house. The usual load consists of 200, 100 volt 35 watt glow-lamps. What size leads should be employed if the resistance of 1 cub. in. of copper be .66 microhm? (C. and G. Electric Light and Power Examination, 1897.)

The volts spent on the leads = current through the leads \times resistance of the leads, or $E_1 = C_1 \times R_1$.

The voltage lost on the leads = 20 volts, and the usual load = 7,000 watts, which at 100 volts gives us the current = 70 amperes.

$$\text{Therefore } 20 \text{ volts} = 70 \times \frac{l}{s} \times \text{sp. res.}$$

The length of the mains (go and return) = 600 yds.

The specific resistance is given as the resistance of 1 in. length 1 sq. in. sectional area, and therefore the length of the mains must be stated in inches. We then get the sectional area in square inches.

$$\text{Therefore } 20 = 70 \times \frac{600 \times 36}{\text{section}} \times \frac{.66}{10^6}$$

$$\text{Therefore sec. area} = \frac{70 \times 600 \times 36 \times .66}{20 \times 10^6} = .05 \text{ sq. in.}$$

Q. 5. Current is required along a street 2,000 ft. long at the rate of 1 ampere per 10 ft. of frontage. Give sectional area of conductor, so that the difference of pressure between any two lamps shall not exceed 2 volts in the following two cases:—

(a.) The current being supplied at one end.

(b.) The current being supplied midway.

[N.B.—The resistance of a copper bar 1,000 ft. long and 1 sq. in. in cross section may be taken at .008 ohm.] (C. and G. Electric Light and Power Examination.)

Case (a).—

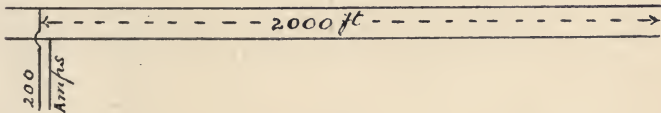

Current in feeders = $\frac{2000}{10} = 200$ amperes, but this current falls off at the rate of 1 ampere per 10 ft. Therefore the mean current in the mains = $\frac{200}{2} = 100$ amperes. The allowable voltage fall on the mains = current in mains \times resistance of mains.

$$\text{Therefore } 2 \text{ volts} = 100 \times \frac{l}{s} \times \text{sp. res.}$$

The specific resistance is given as the resistance of 1,000 ft. 1 sq. in. in section, therefore if we put in the value given our length of mains must be in 1,000 ft. The total length of conductor (go and return) = 4,000 ft.

$$\text{Therefore } 2 = 100 \times \frac{4}{s} \times .088.$$

$$\text{Therefore sec. area} = \frac{100 \times 4 \times .088}{2} = 1.6 \text{ sq. in.}$$

Case (b). Current supplied midway—

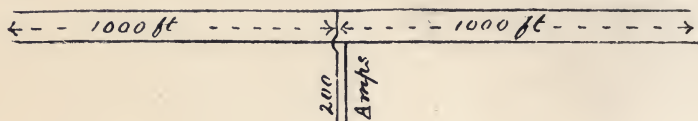

Here the current divides into two halves, 100 amperes on each side. The maximum variation in voltage will be between a lamp at the end and one at the feeding point. The mean current in this half length = 50 amperes, and again $E = C \times R$, therefore 2 volts = $50 \times \frac{l}{s} \times \text{sp. res.}$ The length has now been reduced to half its former value—2,000 ft. for go and return.

$$\text{Therefore } 2 = 50 \times \frac{2}{s} \times .008.$$

$$\text{Therefore sec. area} = \frac{50 \times 2 \times .008}{2} = .4 \text{ sq. in.}$$

Q. 6. A point in a distributing network of conductors is fed by a pair of feeders from a generating station 600 yds. distant. On turning on a motor which allows 25 amperes to flow on the first contact, the pressure at the ends of the feeders falls 5 volts.

(a.) What is the resistance of the feeders?

(b.) What is their cross section?

The resistance of a cubic inch of copper may be taken as 0.66 microhm. (C. and G. Examination in Electric Light and Power, 1900.)

(a.) The resistance of the feeders by Ohm's law = voltage fall in the feeders \div current flowing in the feeders = $\frac{5}{25} = .2$ ohm.

(b.) The resistance of the feeders

$$= \frac{\text{length (go and return)}}{\text{sec. area}} \times \text{sp. res.}$$

$$\text{Therefore } .2 = \frac{1200 \times 36}{\text{sec. area}} \times \frac{.66}{10^6}$$

$$\text{Therefore sec. area} = \frac{1200 \times 36 \times .66}{.2 \times 10^6} = .0124 \text{ sq. in.}$$

Q. 7. In a street, a pair of mains each .2 sq. in. in section (.12 ohm per 1,000 yds.). Demand at the rate of one 30 watt, 100 volt lamp per yard. Give the distance between the feeding

points so that the maximum variation of pressure between any two consumers shall not exceed 3 volts. (C. and G. Electric Light and Power Examination.)

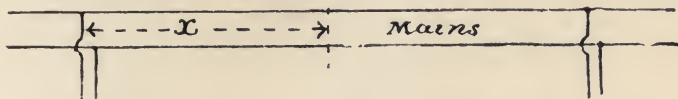

The maximum variation in pressure will be between one feeding point and a point half-way between the feeding points. Call this distance x yards.

$$\text{Then } 3 \text{ volts allowable fall} = c \times R = c \times \frac{l}{s} \times \text{sp. res.}$$

The current for 1 lamp = .3 ampere, and we have this current per yard. Therefore maximum current = .3 x ampere. But this falls off as we go along at a uniform rate, therefore the mean current = $\frac{.3x}{2}$ amperes. The length of the mains = $2x$ yds.

$$\text{Therefore } 3 \text{ volts fall} = \frac{.3x}{2} \times \frac{2x}{.02} \times \text{sp. res.}$$

As we have taken our length in yards and sectional area in square inches, the specific resistance must be in yards and square inches. The question states that the mains 1,000 yds. long .2 sq. in. section has a resistance of .12 ohm, therefore 1 yd. would have a resistance of .00012 ohm, and if this were 1 sq. in. in section instead of .2 sq. in., it would have a resistance of .000024 ohm.

$$\text{Therefore } 3 = \frac{.3x}{2} \times \frac{2x}{.2} \times .000024.$$

$$\text{Therefore } .3x \times 2x = \frac{3 \times 2 \times .2}{.000024} = \frac{1.2}{.000024} = 50000.$$

$$\text{Therefore } .6x^2 = 50000, \text{ therefore } x^2 = \frac{50000}{.6} = 83333.$$

$$\text{Therefore } x = \sqrt{83333} = 288 \text{ yds.}$$

$$\text{Therefore distance between feeding points} = 288 \times 2 = 576 \text{ yds.}$$

CHAPTER IV.

THE HEATING EFFECT OF THE ELECTRIC CURRENT.

IN the last chapter we considered the power expended in different parts of the circuit, and the work done at all points was seen to be transformed into heat. We only get work done by the current or energy stored when there exists in the circuit a back e.m.f., such as that produced by a motor when at work or by a battery of accumulators when being charged. The current in this case = $c = \frac{E - e}{R}$ where E is the e.m.f. urging the current through the circuit, and e is the back e.m.f. established by the motor or cells. In such cases the current may be small, even though the e.m.f. is high and the resistance low, and if the back e.m.f. is equal to the forward or impressed e.m.f., there will be no current at all.

When a back e.m.f. is developed in the circuit $c = \frac{E - e}{R}$, therefore $E = CR + e$. The power is in every case = $E \times c$, and therefore $EC = (CR + e)c = c^2R + ec$. c^2R is energy transformed into heat, and ec is power transformed into mechanical work or stored up. The maximum amount of power is so transformed or stored when the back e.m.f. = e is equal to half the impressed e.m.f., that is to say, when the current flowing is half the maximum current that could flow in the circuit but for the presence of the back e.m.f.

There is a relation between the work done in a circuit and the heat produced, which was first determined by Joule. This relation is such that if 780 foot-pounds of work are done, a quantity of heat is developed sufficient to raise 1 lb. of water 1° F. This is known as the British heat unit, and the relation between the two is called Joule's equivalent.

In electrical work we use neither the British heat unit nor the foot-pound, but instead the heat that would raise 1 gram of water 1° C. for the heat unit, known as the "calorie," and the joule (= .7373 foot-pound) for the unit of work.

It therefore becomes necessary to translate Joule's equivalent to the units employed in electrical engineering.

There are 453 grams in 1 lb., and 1° C. is $\frac{9}{5}$ of 1° F.

Therefore 1 calorie = $\frac{1}{453} \times \frac{9}{5}$ of 1 B.H.U.

„ „ = $\frac{9}{2265}$ of 780 foot-pounds.

„ „ = 3.1 foot-pounds.

But foot-pounds $\div .7373$ = joules.

Therefore = $\frac{3.1}{.7373}$ = 4.2 joules = 1 calorie.

But C^2Rt is also a measure of joules, and therefore $\frac{C^2Rt}{4.2}$ = calories, or, what comes to the same thing, calories = $C^2Rt \times .24$.

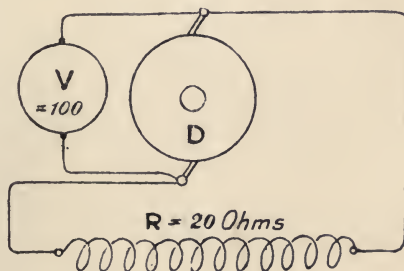

Fig. 10.

This tells us that the heat produced at different parts of a circuit in any given time will be proportional to the resistance if the current be the same at all parts; and also, if we alter the current through any given resistance, the quantity of heat developed in any given time will vary as the square of the current. Let us look into this a little closer, for it is of the utmost importance in electrical engineering, and often leads to disastrous and even fatal results when ignored or not properly understood.

Take a simple circuit again consisting of a dynamo or battery, and a long length of platinum wire, with short copper wires of the same diameter joining the ends of the platinum wire to the dynamo, as represented in Fig. 10. We will suppose the dynamo to be generating an e.m.f. of 100 volts, and the resistance of the platinum wire to be 20 ohms.

We have already seen that the resistance of this wire will be proportional to its length, so that half the length will have a resistance of 10 ohms, quarter the length a resistance of 5 ohms, &c.

When we complete the circuit, a current flows, the strength of which will be practically equal to $\frac{100 \text{ volts}}{20 \text{ ohms}} = 5 \text{ amperes}$. If, after it has been flowing for a minute or so, we touch the wire, we shall find it warm, while the copper wires leading the same current to and from the platinum wire are still cold.

Suppose we now take out of the circuit half the length of the platinum wire, and again touch both the platinum and copper

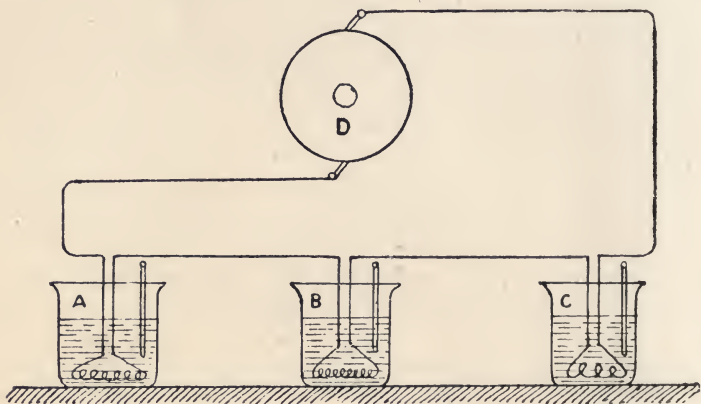

Fig. 11.

after the current has been passing for a short time, we shall find the platinum much hotter, perhaps too hot to touch, while the copper wires are now warm. Lastly, suppose we use only quarter the original length of platinum wire, we may find this red hot, and the copper wires getting decidedly hot, and if we further diminished the length of the platinum wire in the circuit we should see it get brighter and brighter till it finally melted.

Let us see what this means. When we use half the length of platinum wire we have a current flowing of practically twice the original value and this gives us more heat in the remaining half of the platinum wire, and when we reduce the length to quarter its original value we have four times the original strength of current,

and we got a still further increase in the quantity of heat developed in the remaining length of wire. That is to say, the heat developed in unit length of the conductor (say 1 cm. length) depends on the current flowing through it, there being not nearly so much heat developed in unit length of the copper wires as in the platinum, although they both have the same diameter and the same current flowing in them, is due to the different specific resistance of copper and platinum. This can be further experimentally proved by arranging any number, say three, different resistances in series (Fig. 11).

Let $A = 15$ ohms, $B = 30$ ohms, and $C = 10$ ohms. Place each resistance in a vessel containing an equal volume of paraffin oil. When the resistances get hot, due to the passage of a current through them, they will transmit the heat to the paraffin oil, and by means of a thermometer we can then tell the mean rise in temperature per minute of the paraffin oil in each vessel after the current has been flowing for say five minutes, which will be proportional to the quantity of heat developed in each. Here the current is the same in A , B , and C , and consequently if there be any difference of temperature between A , B , and C , it cannot be due to the current being different, but must be due to the different resistance in A , B , and C . Now after the experiment (during which time we have kept the paraffin oil slightly agitated) we shall find that the thermometer in B has risen twice as much as the thermometer in A and three times as much as that in C in the same time, which is also the proportion of the resistances, for B has twice the resistance of A and three times the resistance of C . This again proves that when the same current goes through different resistances, the heat developed in them in a given time is exactly proportional to their resistance. The same apparatus will serve to show how the quantity of heat developed varies when we vary the strength of the current.

Suppose we keep the resistances the same as before, and imagine the current to be reduced to half its former value by halving the e.m.f. in the circuit. If now we repeat the experiment with this reduced current, we shall find that in each vessel the temperature has risen not to half but only to quarter its former value in the same time, which shows us that by reducing the current in any conductor to half its former value we only raise its temperature in a given time to quarter of what it was

previously. That is to say, the quantity of heat developed in any conductor is *not* proportional to the current, but to the *square of the current*.

We should now be able to understand our experiment with the platinum wire better. When we halved the length of the wire we also halved its resistance, and practically doubled the current flowing through it, and we have just seen that if we double the current we get four times the quantity of heat developed in those conductors which carry the doubled current; but if we alter the resistance while the current remains the same we alter the quantity of heat developed in the same proportion, therefore when we halved the resistance of the wire and doubled the current flowing through it we should get half the quantity of heat due to the resistance being halved, and four times the quantity of heat due to the current in it being doubled.

Therefore the quantity of heat developed in it in a given time would be $\frac{1}{2} + 4 = 2$ times as much as in the whole length previously. When we take quarter the length of platinum wire we have quarter the heating effect due to the resistance being reduced to quarter the former resistance, but the current being practically four times greater, the heating effect due to this will be $4^2 = 16$ times as great, therefore the nett result will be $\frac{1}{4} + 4^2 = \frac{1}{4} \times 16 = 4$ times the quantity of heat developed in the same time as was produced in the whole length of wire originally. Of course the student only needs to be told that the heating effect or the quantity of heat developed is proportional to the time the current is flowing, for it is self-evident that if the current produces a certain quantity of heat in one minute, it would produce just twice that quantity in two minutes if it remains of constant strength.

Q. 1. It is proposed to double the e.m.f. in a circuit while everything else remains unaltered. What will be the alteration in the quantity of heat developed in a given time?

If we double the e.m.f. while the resistance remains constant, the current will also be doubled, and the quantity of heat developed in a given time is proportional to the square of the current and to the resistance. Therefore heat developed will be four times as great as before.

Q. 2. It is found desirable to double the resistance of a circuit, and as the current flowing through it must be of the same value as before, the e.m.f. has also to be doubled. Will there be

any difference in the total quantity of heat developed in a given time in (1) the whole circuit, and (2) in the original resistances?

The quantity of heat developed in any conductor in a given time is proportional to c^2R .

Therefore in case (1), as the current is still the same, but the resistance is doubled, the heat developed in a given time in the whole circuit will be doubled.

In case (2), the current is still the same in the original resistances, therefore the quantity of heat developed in them in a given time remains unaltered.

Q. 3. If the resistance of the circuit in *Q. 2* had been halved, and the e.m.f. also halved, what would have been the change in the quantity of heat developed in the whole circuit in a given time?

Here, both the resistance and the e.m.f. being halved, the current remains constant in strength, and therefore the quantity of heat developed in a given time would be directly proportional to the resistance. That is to say, the resistance being halved, the total quantity of heat developed in a given time would also be halved.

Q. 4. If we halve the e.m.f. in a circuit, and at the same time double its resistance, what will be the difference in the total quantity of heat developed in a given time?

If we have half the e.m.f. and double the resistance in a circuit we shall have only quarter the original current flowing.

The quantity of heat developed in a given time is proportional to c^2R , or in this case proportional to $\frac{1}{4}^2 \times 2 = \frac{1}{16} \times 2 = \frac{1}{8}$ its former value.

Q. 5. If we double the e.m.f. and at the same time halve the resistance of a given circuit, what alteration will be made in the quantity of heat developed per minute in the circuit?

If we double the e.m.f. and halve the resistance we get four times the current flowing on it, and the heat developed per minute is proportional to c^2R , or to $4^2 \times \frac{1}{2} = 16 \times \frac{1}{2} = 8$ times its former value.

These examples are given so that the student may become familiar with the way any proposed change in a circuit will affect the quantity of heat produced in it, for this is often a very important consideration.

It will be noticed that up to the present we have spoken of

the *quantity of heat*, but this does not tell us anything about the temperature to which the conductors will be raised. The quantity of heat is an altogether different idea to the temperature. For example, a kettle of boiling water contains a fairly large quantity of heat, but its temperature is comparatively low, viz., 100° C. or 212° F., whereas the quantity of heat in a red-hot pin is exceedingly small, much smaller than that contained in the kettle of boiling water, for if the red-hot pin and the kettle of boiling water were to be each thrown into separate equal volumes of ice-cold water, the quantity of heat in the pin would have practically no effect in raising the temperature of the water, while the kettle of boiling water may raise the temperature of the ice-cold water into which it is placed through several degrees. The temperature of the pin, however, is far higher than that of the boiling water, perhaps seven or eight times as high. The reason why the pin has attained such a high temperature with so small a quantity of heat is that it contains a very small amount of material. Had the pin been twice as thick or twice as long, it would have required twice the quantity of heat to raise it to a red heat.

Suppose we continue to supply heat to the pin at a definite rate, by holding it in a gas flame for instance, we notice that it soon arrives at a fixed temperature, apparently getting no hotter though we still continue to supply it with heat. This is due to the fact that heat always radiates from a hot body to the colder surrounding objects; also cold air coming into contact with the hot body gets heated, and thus becoming lighter, moves upward, carrying away some of the heat and making room for more cold air; and again, some of the heat possessed by the hot body will travel down its support and warm that, for heat always travels from the higher to the lower temperature, just as water always flows from the higher to the lower level, and electricity from the higher to the lower potential.

Now these heat losses go on at a greater rate the greater the difference of temperature, and therefore as we continue giving heat to the pin we are raising its temperature above that of the surrounding objects, and consequently it begins to lose heat more and more rapidly as the temperature rises, till a time comes when it loses heat as rapidly as it is receiving it, and it then remains at a fixed temperature.

If we imagine the pin to be enclosed in a box while heat

is continuously supplied to it as before, the pin would be raised to a higher temperature, for the box, receiving heat from the pin in the ways described, would itself rise in temperature also, and therefore the difference in temperature between the pin and the surrounding objects (the box) would be less, and as the rate at which the pin loses heat depends upon the difference of temperature, it follows that the pin would be raised to a higher temperature before it began to lose heat as fast as it received it.

We thus see that there are a number of things to be considered before we can say what temperature a body will reach, even when we know the exact quantity of heat being supplied per second.

Let us take one of the small incandescent electric lamps that we are all now familiar with. The conducting thread or filament, as it is called, is made of carbon, and usually has a fairly high resistance. Suppose we join one of these lamps to mains that are being maintained at a fixed difference of potential, say 100 volts. Then a current will flow through this filament, and the current will create in it a certain definite quantity of heat per second proportional to c^2R . This heat will raise its temperature to a point where the heat lost by the filament per second, in the ways spoken of above, will be just equal to the heat supplied per second. If this fixed temperature is reached when the filament is at a dull red heat, it would be of no use as far as its light-giving properties are concerned. The question now occurs, could we use a filament that would be raised in temperature to a white heat with the same expenditure of power. Let us see. If we are to keep the expenditure of power unaltered, then we must not alter the product of the e.m.f. and the current; and as in many cases we cannot alter the e.m.f. in the circuit, this means that we could not alter the resistance of the filament either.

But we have seen that the resistance of a conductor is proportional to its length and inversely proportional to its sectional area, and therefore if we double its length and also double its sectional area the resistance of the conductor will be unaltered, for though we double its resistance by doubling its length we halve it again by doubling its sectional area. Or, if we halve its length and also halve its sectional area we still keep it of the same resistance, for in halving its length we halve its resistance, but in halving its sectional area we again double it.

Suppose we do this latter with the lamp filament, viz., halve its length and its sectional area, then we see that the same current will flow through it under the same e.m.f., for the resistance is unaltered, and we should therefore get the same quantity of heat developed in it per second ; but this same quantity of heat has to raise the temperature of only quarter the amount of material as formally, consequently the temperature will rise very considerably, probably to the required white heat.

Q. 1. What would have been the result in the above case if we had kept the resistance constant by doubling its length and sectional area ?

The quantity of heat per second would have been the same, but this being put into four times the quantity of material, would have made its temperature much lower than before.

Q. 2. If we intended the lamp in *Q. 1* to be used on a circuit maintained at 200 volts instead of 100 volts, and still get the same light with the same expenditure of power, in what way would the filament have to be altered ?

If on a 200 volt circuit we require the same expenditure of power, then because we have doubled the e.m.f. we must halve the current, but to get half the current with twice the e.m.f. we must make the resistance four times its former value. The quantity of heat per second will then be unaltered, for being proportional to c^2R , it is proportional to $\frac{1}{2}^2 \times 4 = 1$, its former value.

We see then that the resistance of the filament has to be four times as great. We could get this by making the filament four times as long ; but if we did, we should have the same quantity of heat being put into four times the amount of material, and consequently its temperature would be practically reduced to quarter the previous temperature. But we can also make the resistance of the filament four times its former value by making it twice the length and half the sectional area. We would then have practically the same filament, for what we take from its thickness we add on to its length, and the same quantity of heat being put into the same quantity of material will raise its temperature to the same degree.

The heating effect of the electric current is now used to a certain extent for warming and cooking. It has many advantages over ordinary fires, being cleaner, and always ready for use at a moment's notice ; the heat can also be regulated easily and quickly.

The warming apparatus or radiators often consist of a metallic support with small porcelain insulators arranged in a row top and bottom, and coils of iron wire (like spiral springs) supported by the insulators and connected in series. The resistances are so chosen that they can be joined straight on to the electric light mains, and an arrangement is made whereby part of the resistance may be cut out of the circuit. The more resistance cut out, the greater is the quantity of heat developed per minute. Suppose half the resistance be cut out, then, because the e.m.f. remains constant, the current will be doubled, and the quantity of heat developed in a given time would be equal to $2^2 \times \frac{1}{2} =$ twice its former value.

In cooking apparatus the resistances are often formed of wire having a high specific resistance, so as to get a fairly high resistance in a small space. The resistance wire is in many cases arranged in a close zig-zag form along the bottom and sides of the apparatus, and insulated by embedding it in an enamel which on baking becomes quite hard. False bottoms and sides are then put on to prevent loss of heat as much as possible, and to protect the insulated wire. The amount of resistance can be adjusted in the larger pieces of apparatus, such as ovens, while the smaller kinds, kettles and the like, have a fixed resistance. The time taken to cook depends on the power we employ, for, as we have seen, the quantity of heat produced depends on the work done, and work done is = power \times time. As an example let us take an electrically heated kettle, having a resistance of 10 ohms, joined to mains at 100 volts. How long will it take to boil a pint of water, supposing all the heat developed be given to the water?

In all probability the water at the commencement will be at a temperature somewhere about 15° C. If we take this for the starting temperature, then we have to raise 1 pint = $1\frac{1}{4}$ lbs. of water through $100^\circ - 15^\circ = 85^\circ$ C.

The number of calories required will therefore be $(453 \times 1.25) \times 85$, for the calorie is the heat required to raise 1 gram of water 1° C., but we have 1.25 lbs. of water which is equal to 453×1.25 grams, and we require to raise the water 85° .

$$\text{Now calories} = C^2 R t .24, \text{ and therefore } t = \frac{\text{calories}}{C^2 R \times .24}$$

This is the time in seconds. If we wish it to be in minutes we must divide by 60, or—

$$\begin{aligned} \text{Time in minutes} &= \frac{\text{calories}}{C^2R \times .24 \times 60} \\ \text{'' ''} &= \frac{453 \times 1.25 \times 85}{10^2 \times 10 \times .24 \times 60} \\ \text{'' ''} &= 3.2. \end{aligned}$$

It would really take a longer time than this, because there are certain unavoidable losses of heat due to radiation, &c.

The heat developed in the electric arc lamp raises the temperature of the carbon in the crater to an exceedingly high value, if not the highest known on the earth. This high temperature is now utilised in what are known as electric furnaces for the production of aluminium, carborundum, calcium carbide, and other substances which are only formed at a very high temperature.

CHAPTER V.

THE MAGNETIC EFFECT OF AN ELECTRIC CURRENT.

AN electric current produces another effect not quite so apparent as the heating effect described in the last chapter, but one which is equally as important, if not considerably more so.

When we take the current-carrying wire in our hands, and examine it carefully, we do not detect anything particularly uncommon about it, except that it may perhaps be warm, that depending, as we have seen, on the value of c^2R . But if we place the wire in some fine iron filings and then withdraw it, we find the wire covered with the filings, as though they were sticking to it. When we stop the current the filings immediately fall off, and on trying again, with no current flowing, we find the iron filings will not stick to the wire. We are therefore at once led to the conclusion that the wire, when carrying an electric current, is in some way different to what it is when not carrying a current, and not only that, but the space round it appears to be influenced by the passage of a current through it.

Let us examine more closely into it. If we take a sheet of cardboard and make a hole in its centre, threading our conductor through it so that it stands perpendicular to the cardboard for a short distance above and below it (the cardboard standing horizontally on two blocks of wood), and then sprinkle fine iron filings through a sifter evenly but sparingly all over the cardboard, we find that the filings set themselves in no definite order when no current is flowing, but when we send a fairly strong current through the conductor, and, while it flows, gently tap the cardboard so as to allow the filings freedom to move, we find them arranging themselves very definitely into circles round the conductor. This arrangement of the filings is very marked, and we can see evidence of it at some little distance from the conductor. If we increase the strength of the current, we notice on tapping

the cardboard that the filings have a tendency to be drawn closer to the conductor, while evidence of the circular arrangement of the filings can be detected at a greater distance than before.

Fig. 12 is a diagram of what would be seen looking down on the cardboard.

If we move the wire up or down, so as to bring other parts of it into the plane of the cardboard, and repeat the experiment, we find exactly the same result, so that evidently this peculiar effect extends round all parts of a conductor while it is carrying a current. In fact, the conductor appears to be jacketed throughout its entire length by some specialised condition of the surrounding

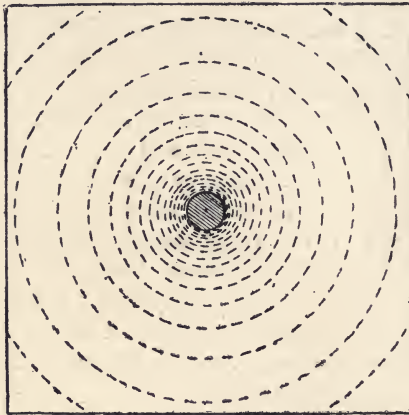

Fig. 12.

space. To make this clear, imagine a circuit of small steam pipes, starting from a boiler, and going through various intricate paths to the exhaust. When a current of steam is passed through it, the space surrounding the conductor (pipes) will be in a specialised condition (heated). We need not touch the pipes to know that a current of steam is passing through them, for if we place our hands near to any part of the conductor we can feel that the space there is different to what it was when no steam was passing through the pipes, and this special state of the surrounding space exists round every part of the steam-carrying conductor, including the boiler, where in all probability the effect is very much greater. If

we increase the current of steam through the pipes the effect is felt at a greater distance.

In our electrical circuit we influence the space surrounding the current-carrying conductors, dynamo as well, not by heating it, but by magnetising it, and we have already seen that it exerts this influence in a circular direction, and that it apparently fades away as we go further from the conductor.

Let us now brush away the iron filings, and arrange a number of small pocket compass needles round the wire, as shown in Fig. 13.

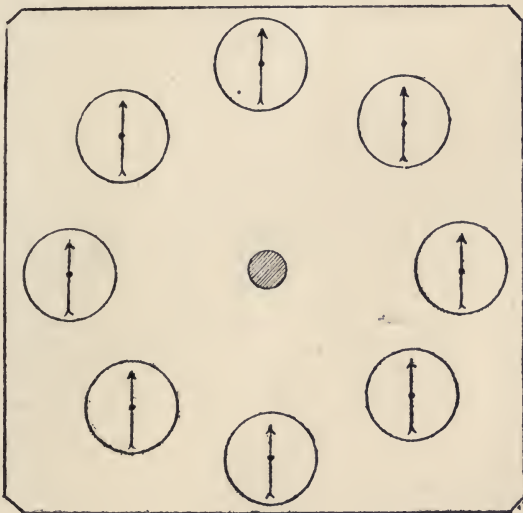

Fig. 13.

When we send a current through the conductor, we see them immediately set themselves as in Fig. 14, where all the north poles appear desirous of going round the conductor in one direction, and all the south poles in the opposite direction.

This tells us a bit more. Not only is the space round the conductor magnetised, but it is magnetised in a certain definite direction. If we reverse the position of the wires joined to the dynamo or battery terminals, we find that the compass needles all point in exactly opposite directions to what they did previously,

as shown in Fig. 15. We therefore see that some difference is made by the way we join our conductors to the dynamo ; evidently by reversing the position of the wires on the dynamo terminals we have reversed the direction of the magnetised space or "field," as it is called, round the conductor.

This shows us that we can speak of the direction of an electric current, and it also points out a method of identifying it at any time, for when a current flows in a particular direction the north pole of a compass needle placed in the magnetic field created by

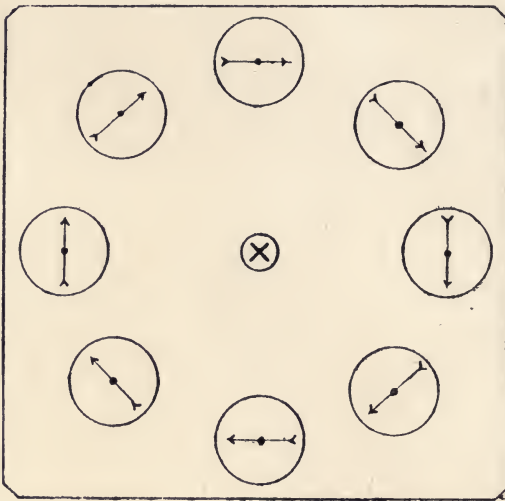

Fig. 14.

the current tends to travel round the conductor in a clockwise or anti-clockwise direction, according to the direction in which the current flows.

Looking again at Fig. 14, we see that all the north poles of the compass needles are being urged in a clockwise direction, as we view them, from the top. In this case the current is said to be flowing away from us, or from the upper to the lower side of the cardboard. This direction can be easily remembered when we remember that it combines the double movement of a screw. If we wish to pass a screw down or through the cardboard in the

same direction that the current is flowing, we must give it a clockwise twist, which corresponds to the clockwise twisting of the north poles of the compass needles when the current flows down, whereas if we wish the screw to be moved up or out of the cardboard we must twist it in an anti-clockwise direction, which again corresponds to the upward movement of the current and the anti-clockwise twisting of the north poles of the compass needles.

This method of finding the direction of a current is very convenient and helpful, though it is not the only method we have of

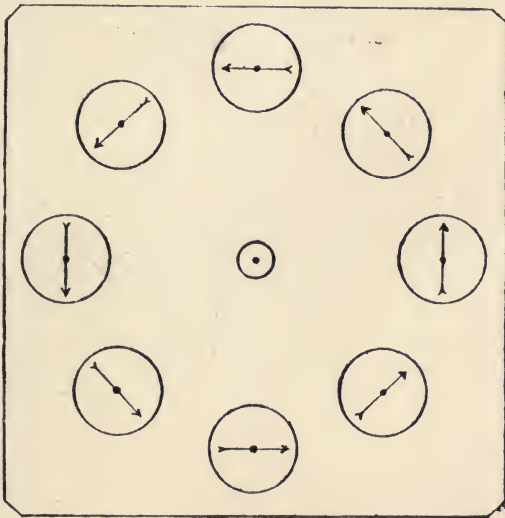

Fig. 15.

finding it, as we shall see. It follows that as a current of electricity always flows from a higher to a lower potential, just as water always flows from a higher to a lower level, we might state at once which of the two dynamo or battery terminals has the higher potential, by simply noticing the direction in which the north pole of a compass needle is urged when placed in the field. This is known as the positive or + terminal, and the other the negative or - terminal.

It is often very important to know in which direction the current is flowing round a circuit, and it is not often convenient

to arrange our compass needles just as indicated in Fig. 13. If instead of so doing we place a compass needle on the table, and notice in which direction it points, then place the conductor over it and along the length of the needle so as to hide it from our view, when we switch the current on we shall find the needle deflected in the endeavour made by the north pole to go round the conductor in one direction and the south pole in the opposite direction, and we can then easily deduce the direction of the current. If, for instance, we put ourselves in line with the conductor, with the compass needle in front of us, and we notice that the north pole is urged to our left, we conclude that the north pole is trying to travel round the conductor in a clockwise direction when viewed from the end nearest ourselves, and therefore the current must be flowing away from us, because in so doing it turns the north pole of the compass needle in the same direction that a screw would have to be turned in moving away from us.

There is a very simple rule, and an exceedingly convenient one to apply in all such cases. If we stretch out the right hand, the thumb normally stands at right angles to the fingers. Now place the fingers on the conductor, pointing in the direction in which the current was found to be flowing, with the palm of the hand facing the compass needle, and it will be seen that the thumb points in the direction in which the north pole of the compass needle was urged. If therefore we wish to find the direction of the current, all we need do is to place a compass needle under the conductor and notice the direction in which the north pole is deflected, then stretch out the right hand over the conductor with the fingers pointing along its length and the thumb pointing in the direction indicated by the north pole of the needle. The fingers are then pointing in the direction in which the current is flowing. A very little practice will soon enable the student to apply this with ease and certainty.

This is known as the right-hand rule. It will be noticed that the left hand will not do, for when outstretched the thumb points in just the opposite direction to that of the right hand.

If instead of threading the conductor only once through the cardboard as in Fig. 12, we were to thread it through a number of times, say ten times, we should find the iron filings arranging themselves in exactly the same way as before, but the effect would be ten times greater, providing the current remained of the same

strength, for, as we shall see further on, the magnetisationⁿ produced in this way is proportional not only to the strength of the current but also to the number of turns of wire carrying the current, that is, to the current turns or ampere turns.

Let us now take another sheet of cardboard, and make two holes in it about 3 or 4 in. apart, and after bending the conductor into Ω shape, pass the limbs through the holes. When we join this to our dynamo or battery a current will flow *up* one limb and *down* the other, that is, in opposite directions in the two limbs. If we now sprinkle the cardboard with iron filings as

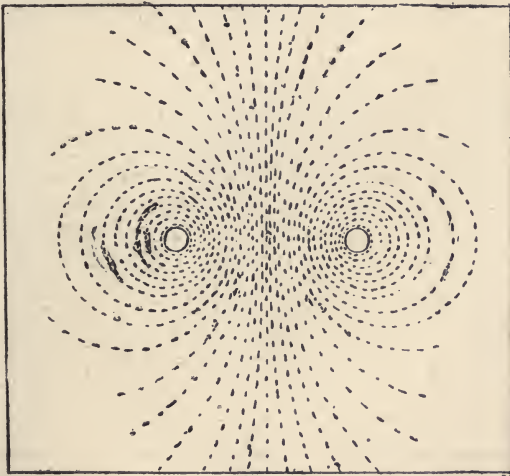

Fig. 16.

before, and get a view of what is happening in the space between the limbs, we find the filings arrange themselves as in Fig. 16.

Here the filings do not embrace the two wires as they did with the ten wires, but the curves formed by the current in one wire appear to be pushing away those formed by the other wire, which causes them to become eccentric and practically straight lines for a short distance midway between the two wires. It will be noticed that the curved lines never cross one another, and also that they all appear to be closed curves or to form closed circuits.

This repulsive action of the magnetism produced by the two

limbs of the conductor is really tending to straighten out the conductor, though the forces are far too small to produce any such effect. We would, however, get exactly the same result if we used two separate conductors carrying currents in opposite directions in place of the two limbs of the same conductor, and if we were to suspend these conductors by threads, so as to allow them freedom of movement, we should actually see the conductors repelling one another when we started the currents flowing in them.

Just the reverse of this takes place when the current flows in the *same* direction in two or more conductors. In the case of the

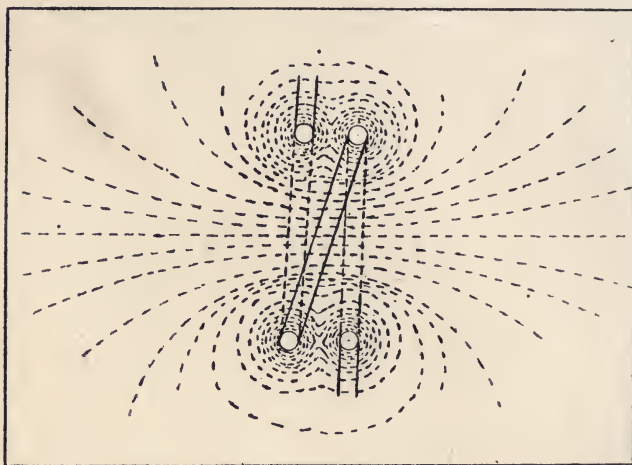

Fig. 17.

ten wires, the field due to the current in any one wire links itself on to that produced by the others so as to produce one field ten times as strong as that of one wire, and in the endeavour made by the field to so link on, attraction takes place between the conductors. The ten wires, when carrying a current, are as it were magnetically sticking together, and if they were free to move, and we separated them a little, we should see them fly back and cling to one another. We sum this up in the statement that “conductors carrying currents in the *same* direction *attract* each other,” and “conductors carrying currents in *opposite* directions *repel* each other.”

Let us now squeeze the two limbs of the conductor closer together, and repeat the experiment with the iron filings. We shall notice that the eccentricity becomes more marked, while the arrangement of the filings cannot be detected at so great a distance. If we continue the experiment until the two limbs are nearly in contact, we shall scarcely detect any arrangement of the filings at all. Evidently all through the magnetic effect of the current in one limb has been opposed to that of the other limb, the one repelling the other, and limiting the distance of each field between the conductors, crowding the lines together at this part.

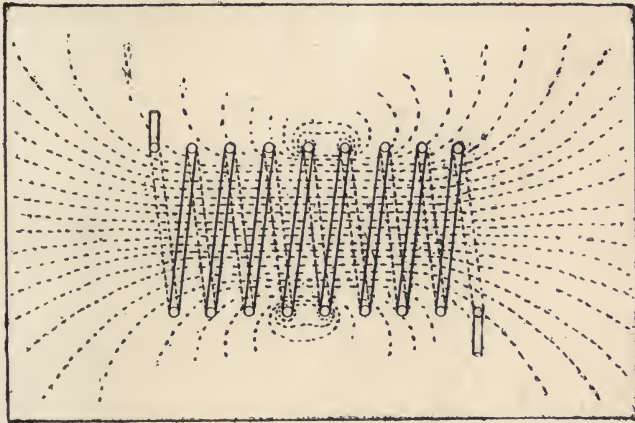

Fig. 18.

Now let us open out the limbs again, so that they stand at their original distance apart, and then thread the conductor through a second time, placing the two turns of wire side by side.

We have now the same strength current as before, but we use it twice instead of once. On again obtaining a picture view of the magnetic field with the iron filings we see what is represented diagrammatically in Fig. 17.

Here the fields of the two wires on either side appear to have linked themselves together, and to be giving an effect double of that produced by one wire, with a proportionally longer straight part at the centre.

Now imagine the wire to be threaded through a large number of times with all the turns placed side by side like a spiral

spring, as represented in Fig. 18. When the same current flows through such a conductor, we notice that the filings appear to be straight inside the spiral for a certain proportion of its length, due to the magnetic field of all the conductors on either side linking on or running one into the other, while the field produced by the conductors on one side is apparently pushing back that produced by the conductors on the opposite side. There is an evident crowding together of the lines inside the spiral and a spreading of the lines outside it.

This spreading of the lines outside the coil is due to all the lines of force being self-repellent, and therefore when they get out of the influence of the coil they repel one another on either side as far as possible. To get them crowded together, as they are represented inside the coil, we must expend a certain amount of energy in overcoming the self-repellent action of the lines of force.

Each of the lines formed by the filings, if carefully traced, is found to complete a circuit. If we start at any point on one of them and follow it carefully, we find that after taking some lengthy path outside the spiral it always returns through the spiral or coil to the starting point. Therefore every line found outside the coil is also to be found inside it.

If we twist the spiral round through any angle, holding the cardboard fixed so as to bring another part of the coil into the plane of the cardboard, we find an exactly similar result at whatever part we try. We therefore conclude that *all* the space inside and outside the spiral is subjected to this magnetic effect due to the current. The effect is somewhat similar to water flowing in a vertical hose pipe, which on reaching the top sprays out in all directions, but in our magnetic circuit, after spraying at one end, they appear to collect together and pass in again at the other end.

It will perhaps have been noticed that we have often spoken of the magnetism produced as the magnetic lines. The filings set themselves into lines, but the reason for their so doing can be shown to be due to each filing being under magnetic attractions and repulsions, which tend to bring them end to end in lines.

It must not be imagined by the student that the magnetic condition of the space round the conductor consists of a number of lines of force or stress with spaces between, as mapped out by

the filings, but rather as a continuous state of stress, getting weaker as we go from the conductor, like the heat surrounding the steam pipes spoken of previously. When we come to measure the strength of magnetic fields, to work with them and compare them, it is found very convenient to speak of the field as containing so many lines of force, and the strength of the field as the number of lines of force that pass through each square centimetre of cross section. The lines as mapped out by the iron filings do not represent the lines of force we mean when speaking of the strength of the field, and so it is impossible to measure its strength by attempting to count the lines produced by the iron filings. We have to work with an universally recognised unit line of force, and one of the iron filings lines may represent any number of such unit lines.

Referring back to Chapter II. it will be seen that a definition of unit magnetic pole was there given. Faraday formulated the idea of magnetic lines of force, and he took the unit magnetic field as containing 1 line of force passing through each square centimetre of the section. If we have 10 lines of force per square centimetre, then the intensity of the field, he would say, was equal to 10 times the unit field.

We have now to see what relation exists between this new unit and the unit magnetic pole used up to Faraday's time. Suppose the unit pole to be surrounded by a sphere of 1 cm. radius, then all parts of the sphere's surface will be at unit distance from the unit pole, and therefore if a second unit pole be placed anywhere on the surface of this sphere it would experience a force of 1 dyne. Now according to Faraday's definition this field at the surface of the sphere is to be called unit field, and to be represented by 1 line of force through each square centimetre. That is to say, a unit magnetic pole placed in a field of strength = unity (= 1 line of force per square centimetre) experiences a force of 1 dyne. Now in such a sphere there are 4π (= 12.56) sq. cm., for the area of a sphere is equal to 4π times the square of the radius, and the radius being unity, there are 4π sq. cm., and as 1 line of force is supposed to pass through each square centimetre, it follows that the unit pole has 4π lines of force radiating from it. It is in this unit, then, that our lines of force are measured.

In Chapter II. we also considered the unit of current, and

there saw that if 1 cm. of the conductor carrying unit current be bent into an arc of 1 cm. radius, it exerted a force on a unit pole placed at the centre of 1 dyne. Now we have just seen that the unit pole creates unit magnetic field all round it at a distance of 1 cm., and as the conductor is bent into an arc of 1 cm. radius, all parts of it must be standing in unit magnetic field (= 1 line per square centimetre). Of course the current-carrying conductor will experience the force of 1 dyne as well as the unit pole, and if the pole be fixed and the conductor free to move, it would move. If the unit pole be replaced by another of 2 units, then it establishes 2 lines per square centimetre at unit distance, and the force acting on the current-carrying conductor is doubled.

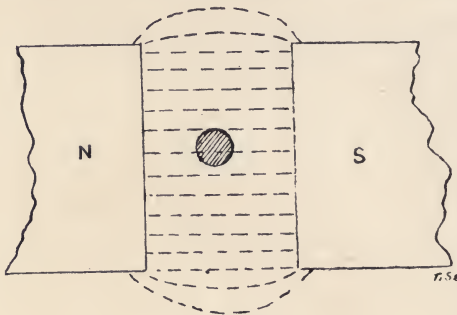

Fig. 19.

Again if the strength of the current in the conductor be doubled, the force acting on it when placed in any given strength of field is also doubled, and therefore the force in dynes acting on a current-carrying conductor depends on (1) the strength of the field it is placed in, and (2) on the strength of the current flowing in the conductor.

It will be quite evident that if we take another centimetre length of conductor carrying the same current and place it in the same strength field, that too would experience the same force; and therefore the force in dynes acting on a conductor carrying a current in a magnetic field is equal to (1) strength of the field in lines per square centimetre; (2) strength of the current in absolute units; (3) the length of the conductor in centimetres, or $F = HcL$, where H represents the strength of field, c the current in absolute units, and L the length of conductor in centimetres.

Suppose we have a uniform magnetic field of strength = 1, or 1 line per square centimetre, and into this field we introduce a conductor carrying absolute unit current (= 10 amperes), then this conductor experiences a force of 1 dyne. If now we move this conductor 1 cm. against the force, we do 1 erg of work, but in so doing we cut through 1 line of force. If the field be increased in strength to any other number of lines per square centimetre, then the force exerted on the conductor will be increased in the same proportion, with corresponding increases in the work done in moving the conductor 1 cm. in the field. Imagine that we take exactly 1 second in moving the conductor 1 cm., then we shall have acted on 1 unit quantity of electricity, for the unit quantity of electricity is that quantity which is conveyed by unit current in 1 second.

Now we have seen that when work is done by a current, a back e.m.f. is produced and that work done = QE , and therefore $E = \frac{\text{work done}}{Q}$. When the intensity of the field is unity, then work done in moving conductor through 1 cm. of the field, and so cutting through 1 line of force, is = 1 erg, and the e.m.f. developed in the conductor = $E = \frac{\text{work done}}{Q} = \frac{1}{1} = 1$ absolute unit.

If we take 2 seconds in moving the conductor through the centimetre length of unit field, then the work done will be still 1 erg, for work done is independent of the time taken, but we shall have acted on 2 units of quantity, for evidently, if the current remains of the same strength, then twice the quantity of electricity passes in 2 seconds as does in 1 second. Therefore $E = \frac{\text{work done}}{Q} = \frac{1}{2}$, or the e.m.f. is then only half its former value.

Again suppose the movement be accomplished in $\frac{1}{2}$ second, then work done = 1 erg, and Q acted on = $\frac{1}{2}$. Therefore $E = \frac{\text{work done}}{Q} = \frac{1}{\frac{1}{2}} = 2$ absolute units (100,000,000 of these units = 1 volt). This

shows us that when conductors cut through lines of force, an e.m.f. is generated in them independent of the current flowing. The e.m.f. generated is proportional to the *rate* of cutting, or in symbols

e.m.f. = $\frac{NT}{t}$, where N represents the total lines cut, T the total

number of turns cutting N lines, and t the time in seconds taken in cutting.

Before we can calculate the intensity of the field in any given case we have to consider two other points, viz., the magnetic potential, and the magnetic resistance or reluctance as it is commonly called.

When we considered the comparable electrical case, we found that before we could say what current would flow in any case we had to consider the electrical potential and the electrical resistance, and we saw that—

$$\text{Electrical effect produced or the current} = \frac{\text{e.m.f.}}{\text{elec. res.}}$$

In much the same way we have to consider the magnetic circuit, for—

$$\text{The magnetic effect produced or total lines of force} = \frac{\text{m.m.f.}}{\text{mag. res.}}$$

where m.m.f. stands for the magneto-motive force or magnetic potential.

What then is the unit of m.m.f. or magnetic potential, and how is it measured? We measure this in a similar way to that employed in the electrical case (see Chapter II.), by measuring the work done in urging a unit quantity of magnetism round the (magnetic) circuit.

Imagine a solenoid or coil of wire (such as is shown in Fig. 18) having any number of turns, say T turns, carrying a current of c absolute units. How much work will be done in urging unit quantity of magnetism round this circuit? Unit quantity of magnetism or unit pole has 4π lines of force, and work done = QE , and E is given by the rate of cutting lines of force = $\frac{NT}{t}$

The number of lines of force cutting = $4\pi T$, and they cut through T turns in say t seconds, therefore the e.m.f. developed is equal to $\frac{4\pi T}{t}$ absolute units.

The quantity of electricity acted upon in this time is equal to the strength of the current multiplied by the time in seconds, or $Q = c \times t$.

Therefore $QE = (c \times t) \times \frac{(4\pi T)}{t} = c \times 4\pi \times T$, and therefore the time taken does not influence the result (work done), for if the

time be long, the e.m.f. developed will be small, but the quantity acted on will be correspondingly large, and *vice versa*.

The work done in urging unit pole round the magnetic circuit = $4\pi CT$ ergs, and the magnetic potential is therefore given as equal to $4\pi CT$. But we measure our current in amperes for practical purposes, and the ampere is only $\frac{1}{10}$ of the value of the absolute unit, and therefore we get for the magnetic potential $\frac{4\pi CT}{10}$ or 1.25 ampere turns. Therefore the magnetic potential of the coil is expressed as $1\frac{1}{4}$ times the ampere turns.

How is the magnetic resistance or reluctance measured? Again in a very similar manner to the electrical case. There we saw that—

$$\text{Resistance} = \frac{\text{length}}{\text{sec. area}} \times \text{sp. res.}$$

We might just as easily have stated it as—

$$R = \frac{\text{length}}{\text{sec. area}} \times \frac{1}{\text{sp. conductivity}}$$

The magnetic resistance is likewise proportional to the length of the magnetic circuit, and also inversely proportional to the sectional area, and inversely proportional to the specific conductivity of the material to be magnetised, or, as it is more commonly called, to the permeability of the material, and therefore the magnetic resistance or reluctance = $\frac{\text{length}}{\text{sec. area}} \times \frac{1}{\text{permeability}}$. The permeability is often symbolised by the Greek letter μ .

We can now write—

$$\left. \begin{array}{l} \text{Magnetic effect produced} \\ \text{or total lines} \end{array} \right\} = \frac{\text{m.m.f.}}{\text{reluctance}} = \frac{1.25 \text{ amp. turns.}}{\text{length} \times \mu}$$

If we symbolise the total lines of force produced by N , then—

$$N = \frac{1.25 \text{ A-T}}{\text{sec. area} \times \mu} = \frac{1.25 \text{ A-T} \times \text{sec. area} \times \mu}{\text{length (in cm.)}}$$

If the coil is fairly long compared with its diameter then the above formula is true, but not so if the coil be short, for the effect of the poles formed at the ends are then of relatively much greater importance. The poles formed in every case tend to demagnetise the arrangement, for if a north pole be formed at one end it would tend to urge a north pole to the other end of the coil, *i.e.*, in just the opposite direction to that exerted by the m.m.f. of the coil,

and similarly for the opposite pole at the other end. The stronger the poles so formed, the stronger is their demagnetising action, this being proportional to the strength of the pole, and inversely proportional to the square of the distance from the pole to the centre of the coil.

If therefore the length of the coil be large, the demagnetising effect is negligible, or again if the coil be bent round to form a circle, there are no poles formed, and again the above formula holds good. The permeability of air is taken as unity, and all other substances are compared with it. If then we are dealing with air only we get—

$$\text{Total lines} = \frac{1.25 \text{ A-T} \times \text{sec. area} \times 1}{\text{length in cm.}}$$

or what comes to the same thing—

$$\text{Total lines} = 1.25 \text{ A-T per cm.} \times \text{sec. area.}$$

But we are often more concerned about the magnetic density than the total lines, for we can get almost any number of lines with any given number of ampere turns, if we allow space enough. But a given number of ampere turns will only maintain a certain magnetic density, and usually we want not only a large number of lines of force, but we want them also in a certain space, that is, we want a certain density of the lines of force. The density

or lines per square centimetre is $= \frac{\text{total lines}}{\text{sec. area}}$, and this in the case

of air is usually symbolised by H to distinguish it from total lines N .

$$\text{Therefore } H = \frac{N}{\text{sec. area}} = \frac{1.25 \text{ A-T per centimetre} \times \text{sec. area}}{\text{sec. area}}$$

or $H = 1.25$ times the ampere turns per centimetre. Therefore to produce any intensity of field in air, we must provide $\frac{4}{5} H$ or $0.8 H$ ampere turns (per centimetre) to get it, for if $H = 1.25$ ampere turns per centimetre—

$$\text{Ampere turns per cm.} = \frac{H}{1.25} = H \times \frac{4}{5} \text{ or } .8 H.$$

Thus, required a field of intensity 100 in a long coil. Maximum current to be 10 amperes. How many turns of wire must be wound on.

Here $H = 100 = 1.25$ ampere turns per centimetre.

Therefore ampere turns per cm. $= .8 \times 100 = 80$.

Maximum current $= 10$ amperes.

Therefore $\frac{80}{10} = 8$ turns per cm. must be wound on coil.

H is seen to be independent of the sectional area of the coil. If we make the section large, we get the same intensity as with a small sectional area, providing we maintain the same m.m.f., and therefore we get many more lines in one case than in the other. It might therefore be supposed that there would be a great advantage in making coils of large sectional area, but the advantage is not so great; thus, suppose we desire a field of 10,000 lines, and we use a long coil having a cross sectional area of 1,000 sq. cm., the intensity of the field will then be $\frac{10000}{1000} = 10$.

The magnetising force required is therefore $.8 \times H = .8 \times 10 = 8$ ampere turns per centimetre length of the space. We need only consider 1 cm. near the middle for our present purpose. If we elect to use a current of say 1 ampere, then we must provide 8 turns in each centimetre length, that is, in our centimetre at the centre the conductor must encircle a space of 1,000 sq. cm. area 8 times. If the space be circular in section, the circumference will be 112 cm. long, and so the length of the conductor for our centimetre length will be $8 \times 112 = 896$ cm.

If we now halve the sectional area, and wind our 896 cm. of wire on the *same* length as formerly, we find we get 14.9 turns instead of 8, that is, say 15 ampere turns instead of our 8 ampere turns on double the sectional area. Now reducing the sectional area to half its former value would, if the ampere turns had remained constant, have reduced the lines of force to 5,000; but we see that with the same length of wire carrying the same current we can get 15 ampere turns on the same length, which are able to maintain a greater density of field than 10 per square centimetre, viz., 18.7 or 1.25 times 15, and therefore the total lines are now = 9,350 instead of the original 10,000. If we wished to produce in this halved sectional area the same number of lines of force as we had in the original case, viz., 10,000, then we have seen that we must provide twice the magnetising force, or 16 ampere turns per unit length, because the lines of force will then be twice as dense as before. To do this the current would have to be increased from 1 ampere to 1.066 amperes, then ampere turns = $1.066 \times 15 = 16$ per centimetre length with the same length of wire.

CHAPTER VI.

THE MAGNETISATION OF IRON.

So far we have been considering the laws governing the magnetisation of the air-space inside a coil. If we fill this space with wood, glass, brass, zinc, or any material other than iron or steel, no alteration is made in the strength or intensity of the field.

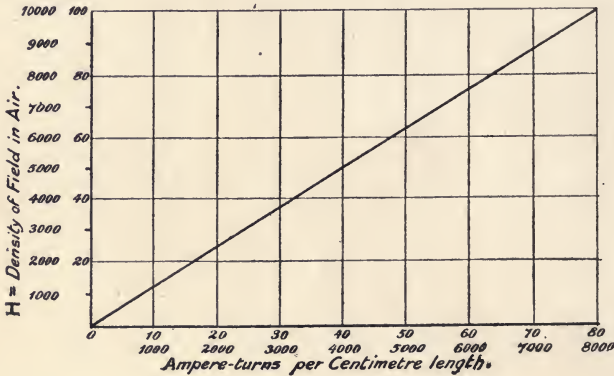

Fig. 20.

The lines of force pass through them as they did through the air-space before they were introduced into the coil, therefore their magnetic resistance is said to be equal to that of air, and we can consider the magnetisation of all such things as if we were magnetising the same length and cross section of air.

We have seen that the magnetising force necessary to produce any intensity of field H in air (and therefore in any substance other than iron or steel) is $= 1.25$ times the ampere turns per centimetre length, that is to say, the ampere turns per centimetre length are numerically $\frac{4}{5}$ that of the field produced. Thus if $H = 50$, then $H = 1.25$ ampere turns per centimetre, and therefore the ampere

turns per centimetre = $\frac{H}{1.25} = \frac{50}{1.25} = 40 = \frac{4}{5}$ of H . This holds good whatever the intensity of the field may be. If $H = 5000$, then we must provide $\frac{4}{5}$ of 5,000 ampere turns for every centimetre length, or 4,000 ampere turns per centimetre. The straight line shown in Fig. 20 is drawn showing the relation between the ampere turns per centimetre and H , the ampere turns per centimetre being $\frac{4}{5} H$ for any value chosen.

Suppose we wish to produce at the centre of a long coil a field of intensity 50, *i.e.*, 50 lines through every square centimetre, then we must provide 40 ampere turns for every centimetre length of the coil. The total number of lines that we get depends on the sectional area, for with this number of ampere turns we produce 50 lines in *every* square centimetre independent of the number of square centimetres we enclose by the turns.

But suppose we place inside this coil a core of soft iron, so that the space is entirely filled by it, we shall find that with the 40 ampere turns per centimetre length we do not get 50 lines per square centimetre, but more like 15,000. Evidently when iron is placed inside the coil the lines of force are able to crowd together very much easier than before. The iron has diminished the magnetic resistance inside the coil enormously. We might say we have replaced one material (air) offering a high magnetic resistance with another material (iron) offering a very much smaller resistance, and consequently with the same magnetising force or m.m.f. we get a very large increase in the magnetisation produced, in much the same way that if we replace a high electrical resistance by a very small one we get with the same e.m.f. a large increase in the current produced. It is for this reason that, where strong magnetic fields are required, the coils always contain iron cores, for we then produce an intense field with but a small expenditure of power. To produce this field of 15,000 lines per square centimetre with an air, wood, copper, or any other core except iron and steel, would require a magnetising force of $\frac{4}{5}$ of 15,000 = 12,000 ampere turns per centimetre length, instead of 40 with the iron core.

We have only to consider the permeability of four different materials, *viz.*, air, and all so-called non-magnetic materials, wrought-iron, cast-iron, and steel. (Nickel and cobalt have slightly different values to air, but the difference is not great, and as they are not

used to any extent in electrical engineering, we will therefore leave them out of account, and confine our attention to the four materials mentioned above.)

But we are now confronted by what may appear at first sight to be a difficulty. We find we cannot state definitely the magnetic resistance of iron or steel, for it varies with the different qualities of these materials, and also with the degree of magnetisation. When we experiment with a piece of iron or steel, by increasing the m.m.f. in small stages, and measuring the intensity of the field produced at each stage, we find that the one is not at all in proportion to the other, as it was without the iron. For a little at the start, when the m.m.f. is very small, the intensity of the field is nearly proportional to the m.m.f., but at a certain point a slight increase in the m.m.f. causes a sudden rise in the magnetic intensity, which continues to increase altogether out of proportion for a time, but as we go on proportionally increasing the m.m.f. we find the increase in the intensity of the field produced begins to fall off, till we reach a point where it again appears to rise in proportion to the m.m.f. With good iron this point is reached when the intensity of the field amounts to something like 16,000 lines per square centimetre, and would be produced by a magnetising force (or magnetic excitation as it is sometimes called) of 47 ampere turns per centimetre length.

The iron, at this degree of magnetisation, apparently multiplies the intensity of the field 272 times, for 47 ampere turns per centimetre without iron would produce a field intensity H of only 58.75 lines per square centimetre, or $1\frac{1}{4}$ times the ampere turns per centimetre. The iron is said to be saturated at this stage, because to get any further increase in the intensity of the field we require an increase in the m.m.f. altogether out of proportion to that required up to this point.

Because of the great difference in the intensity of the field produced by a given number of ampere turns with and without iron or steel, it is common to employ another symbol to represent the intensity in iron, reserving H for the intensity of the field in air and non-magnetic materials. The symbol employed is B , therefore H and B both represent the intensity of the field, but the one tells us we are not magnetising iron or steel and the other indicates that we are so doing.

We have already said that μ (the permeability of the iron

or its multiplying effect) depends upon the quality of the iron and also upon the degree of magnetisation. Let us take another analogy to help us in understanding this last effect. Suppose we require to thread a large number of thin indiarubber rods through the coil, the more we thread through the more difficult it becomes to get others in. We should say the resistance of such a space depends upon its length, and inversely upon its sectional area, and also upon the number of rods we have to put in, for the space becomes less and less permeable to the indiarubber rods the more we thread through. It is, however, comparatively easy to get a certain large number in, but at a certain stage (when the space is about full or saturated without any squeezing together of the indiarubber rods) we have to expend a much larger amount of energy to get any appreciable increase in the number threaded through. If we wished to know the resistance that would be offered by such a space we should have to consider (1) the length of the coil, (2) its sectional area, and (3) the number of indiarubber rods we require to thread through. It is in much the same way that we speak of the magnetic resistance of the iron, for the permeability of the iron is altering with every alteration in the number of lines of force threaded through it. There is, however, one very great difference, that whereas in the case of the indiarubber rods a time comes when it is impossible to get any more in whatever force we bring to bear without injury to the coil, while there is *theoretically* no known limit to the number of lines of force that can be got through the coil, providing we have a large enough m.m.f.

The magnetic resistance of the iron depends therefore on (1) the length, (2) the sectional area, and (3) upon another factor μ , the permeability of the iron, which varies with its quality and with the number of lines of force we put in, so that—

$$N = \frac{\text{m.m.f.}}{\text{mag. res.}} = \frac{1.25 \text{ amp. turns}}{\text{mag. res.}} = \frac{1.25 \text{ amp. turns}}{\frac{\text{length}}{\text{sec. area} \times \mu}}$$

Instead of dividing by the $\frac{\text{length}}{\text{sec. area} \times \mu}$, we can reverse it and multiply, then—

$$N = \frac{1.25 \text{ amp. turns} \times \text{sec. area} \times \mu}{\text{length}}, \text{ and}$$

$$B = 1.25 \text{ amp. turns per cm.} \times \mu.$$

As pointed out in the last chapter, this is only true when the coil is extended a long distance at either end of the part under consideration.

But as μ depends on the quality of the iron as well as on the degree of magnetisation, it is not easy to very accurately specify it. The makers of different brands of iron will usually guarantee a certain permeability for their iron, varying of course with the degree of magnetisation, and will often supply a curve showing the magnetisation produced by varying ampere turns per centimetre length in air, and in their particular qualities of iron or

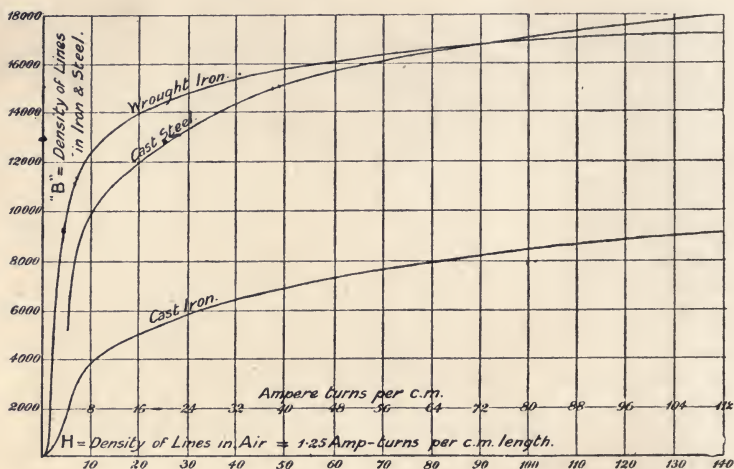

Fig. 21.

steel. That is, the curve shows how much this particular quality of iron or steel will multiply the magnetisation produced by any given m.m.f.

In considering such a curve here, all we can do is to select one that represents a fairly good specimen of what can be procured. Such a curve is given in Fig. 21, in which values of B (lines per square centimetre in iron or steel) are measured in vertical heights or the ordinates as they are called, while values of H (corresponding values of lines per square centimetre in air) are measured by distances to the right of the origin or the abscissæ. If therefore we want $B = 16000$ in this iron, we see

that H would = 58, and therefore $\mu = \frac{B}{H} = \frac{16000}{58} = 275$, or the iron multiplies the effect 275 times, so that to produce 16,000 lines per square centimetre in this iron requires only the same number of ampere turns that would be required to produce 58 lines per square centimetre in air, and, as we have already seen, this will be equal to $\frac{4}{5}$ of 58, or 46.4 ampere turns per centimetre length.

Remembering that $H = 1.25$ times the ampere turns per centimetre length, and therefore the ampere turns per centimetre length = $\frac{H}{1.25}$ or $\frac{4}{5}$ of H , we can easily calculate the number of ampere turns necessary to give any or all the values of H in this curve, and place the number above or below the corresponding values of H on the curve. We can then read direct the number of ampere turns required per centimetre length to produce any value of H or B , and μ can always be found by dividing B by H . This has been done in the curve, Fig. 21.

Let us now take a few problems involving the use of this curve, so that we may become familiar with its extreme utility in calculating all magnetic problems. It must be remembered that we are working with a curve that represents a good mean value for different brands of iron and steel, but certain qualities of iron may come much below the values here taken, and unless the makers of the iron you propose using will supply and guarantee a certain permeability curve, a few preliminary measurements should be made of its magnetic properties.

Q. 1. A coil consisting of 800 turns of copper wire is wound evenly from end to end of a wooden rod 200 cm. long and 10 sq. cm. in cross sectional area. If a current of 2 amperes is passed through the coil—(1.) What is the intensity of the field at the centre? (2.) What is the total number of lines of force? (3.) What alteration would be made in (1) and (2) if the wood be replaced by iron of the same length and sectional area? (4.) What is the permeability of the iron?

$$(1.) \text{ Amp. turns per cm. length} = 2 \times \frac{800}{200} = 8.$$

$$H = 1.25 \text{ amp. turns per cm. length.}$$

$$\text{Therefore } H = 1.25 \times 8 = 10.$$

$$(2.) N = H \times \text{sec. area} = 10 \times 10 = 100.$$

$$(3.) \text{ From curve, with } H = 10, B = 12500.$$

Therefore N with the iron core = $B \times \text{sec. area} = 12500 \times 10 = 125000$.

(4.) The permeability of the iron at this degree of magnetisation = $\frac{B}{H} = \frac{12500}{10} = 1250$.

Q. 2. A rod of iron 5 sq. cm. cross sectional area is wound with a coil of wire from end to end. There are 900 turns in the coil, and the rod is 300 cm. long. What current must be employed so as to produce a total of 80,000 lines at the centre?

$$B = \frac{N}{\text{sec. area}} = \frac{80000}{5} = 16000.$$

From curve to produce $B = 16000$ requires 58 ampere turns per centimetre length.

$$\text{Turns per cm. length} = \frac{900}{300} = 3.$$

$$\text{Therefore current required} = \frac{58}{3} = 19.3 \text{ amperes.}$$

Q. 3. A circular ring of iron has an outside diameter of 30 cm. and an inside diameter of 20 cm., and is wound with 200 turns of wire. If we use a current of 8 amperes in the coil, what will be the total lines of force produced in the iron, and what will be the intensity of the field?

Here we have to find (1) the cross sectional area of the iron, and (2) the mean length of the lines of force, or the mean circumference of the iron ring.

From the figures given, the thickness or diameter of the iron = $\frac{30 - 20}{2} = 5$ cm., and the sectional area = πr^2

$$= 3.14 \times 2.5^2 = 19.62 \text{ sq. cm.}$$

The mean circumference = mean diameter $\times \pi = 25 \times 3.14 = 78.5$ cm.

$$\text{Ampere turns per centimetre length} = \frac{8 \times 200}{78.5} = 20.38, \text{ and}$$

$H = 1.25$ times 20.38, or 25.5. Referring now to curve we find with $H = 25.5$, $B = 14500$.

Therefore the intensity of the field = 14500 lines per square centimetre.

The total number of lines = $B \times \text{sectional area} = 14500 \times 19.62 = 284490$.

Q. 4. Find the current necessary to produce 14,000 lines per square centimetre in a ring of iron the outside and inside diameters of which are 18 and 12 in. respectively, when it is wound with 250 turns of insulated wire.

From our curve we find that to produce 14,000 lines per square centimetre in the iron we require 16 ampere turns per centimetre length. The mean circumference of the ring (and therefore the mean length of the lines of force) = mean diameter $\times \pi = 15 \times 2.54 \times 3.14 = 114.6$ cm.

$$\text{Therefore the turns per cm.} = \frac{250}{114.6} = 2.19.$$

$$\text{Therefore amperes} \times 2.19 = 16.$$

$$\text{Therefore amperes} = \frac{16}{2.19} = 7.3.$$

These examples will be sufficient to show the student that it is comparatively easy to get a large density of lines in iron or steel. If cast-iron is used, then a larger m.m.f. must be employed to produce any required density of field as shown on the curve, Fig. 21. The method of calculating, however, is the same in each case, providing we take our values from the appropriate curve for the material we are using. It is far more difficult to produce a large density in air and other non-magnetic materials. Thus, in the last example, to produce 14,000 lines per square centimetre in air instead of in iron would require $\frac{4}{5}$ of 14,000, or 11,200 ampere turns for each centimetre length. The turns per centimetre were 2.19, and therefore the current necessary would

be $\frac{11200}{2.19} = 5114$ amperes, which is a practicable impossibility,

for the conductors necessary to carry so large a current would occupy more space than is allowed in the problem.

It is, however, necessary in many cases to have a certain large density of lines in a given air-space, and this in every case requires a very large increase in the m.m.f. other than would be required if we could work entirely in iron. Now we have already seen that when the lines of force leave the ends of the coil or iron core their own self-repellent action makes them spread out, and so the density of the lines in the air-space becomes less than it was in the iron. In *Q. 3*, page 78, we considered a ring of iron in which we produced a field of 14,500 lines per square

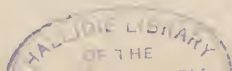

centimetre, with a magnetic excitation of 20.38 ampere turns per centimetre length. Suppose we cut a piece out of this ring, as shown in Fig. 22, and excite it as before with 20.38 ampere turns per centimetre, we shall find that we do not get anything like 14,500 lines per square centimetre, for we have introduced into the magnetic circuit a large increase in its resistance, and to still maintain the same density as formerly the m.m.f. would have to be increased very considerably.

Let us place this ring of iron under a sheet of cardboard and sprinkle iron filings over it. On passing a current through the coil and tapping the cardboard we find the filings arrange themselves between the iron faces, as shown in Fig. 23. Here the

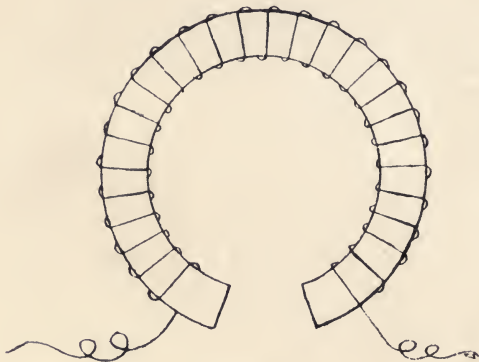

Fig. 22.

lines spread out a good deal after leaving the iron, only a comparatively small number taking the straight path across, and consequently the density of the lines in this air-gap must be considerably less than the density in the iron.

Let us now imagine that the piece of iron has been cut out with a saw $\frac{1}{2}$ cm. in thickness; then when the iron is replaced in the centre of the air-gap there will still remain at either side of it an air-gap equal to the width of the saw, as shown in Fig. 24, which also shows the field we would see mapped out by the iron filings if we tried the experiment. It will be noticed that a fairly large number of the lines of force pass through the piece of iron, which we will call the armature, some

by a straight path from face to face, and others by a curved path, forming as it were a fringe to the iron faces. But all the lines do not go through the armature, for a number, though curving,

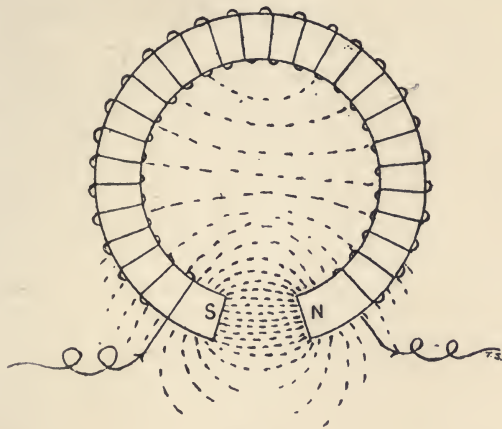

Fig. 23.

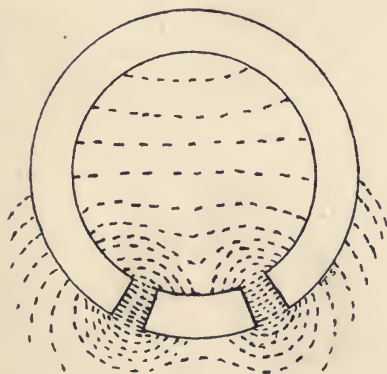

Fig. 24.

as if trying to get into it, are as it were crowded out. If our object be, as it often is, to produce a certain number of lines of force in the armature, all those that do not enter it may be considered as waste lines of force, and to provide our required

number in the armature we must make provision for these waste lines. The number of lines entering the armature depends on the distance between the iron faces or the length of the air-gap, and also on the sectional area of the iron in the armature and the fringe. In the case of dynamo armatures it is usual to allow for 20 to 35 per cent. waste lines.

We have now to consider what magnetic excitation will be required to get a given number of lines of force through such an armature. Let us take a specific case. The ring of iron in *Q.* 3, page 78, has a mean circumference of 78.5 cm. and a sectional area of 19.62 sq. cm. Suppose we cut out a length of 10 cm. with a saw of .5 cm. thickness, therefore the air-gaps will be .5 cm. each. Further, suppose we wish for a total of 200,000 lines in the armature, the question now before us is, how many ampere turns must be provided on the field magnet to produce the required number of lines of force in the armature?

The method to be employed when we are dealing with the iron parts is simple, and has already been explained in full.

$$1. \text{ In the armature, } B = \frac{N}{\text{sec. area}} = \frac{200000}{19.62} = \text{practically}$$

10200. Referring to our curve we find that to produce a field $B = 10200$ in iron, we require 5 ampere turns per centimetre length. There are 10 cm. length in the armature, therefore $10 \times 5 = 50$ ampere turns are required for this part of the magnetic circuit.

2. *In the field magnet* we have to provide for 25 per cent. more lines than in the armature to allow for the waste field. Therefore total lines in the field magnet = 250000, and

$$B = \frac{N}{\text{sec. area}} = \frac{250000}{19.62} = 12740, \text{ and from our curve we find the}$$

ampere turns required for the field magnet = 9 per centimetre length.

The length of the field magnet = 78.5 - 11 (the length of the armature and air-gaps) = 67.5 cm. Therefore total ampere turns required for the field magnet = $67.5 \times 9 = 607.5$.

The only thing now remaining is the air-gaps. The total number of lines passing through these must necessarily be equal to the number in the armature, for the lines of force must pass from the field magnet through these air-gaps before they can pass through the armature. But in so doing they spread out, forming

a fringe ; the amount of spreading depending on the length of the air-gap, and consequently the density of the lines in the air-gaps will be less than in the armature.

From experiments that have been made on this point it has been found that if we increase the sectional area of the iron faces by adding to them .8 time the length of the air-gap all round, we get very nearly the proper sectional area of the air-gaps through which the lines of force will pass on leaving the field magnet and entering the armature. The lines of force that pass outside this enlarged sectional area will not enter the armature, and are therefore counted as waste lines.

Now our air-gaps are .5 cm. long, and .8 time .5 = .4 cm., so we must increase the sectional area of the iron face by adding .4 cm. to the iron all round.

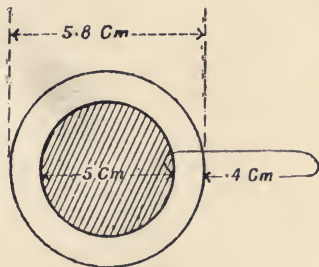

Fig. 25.

Thus if the shaded part of Fig. 25 represents the sectional area of the iron face, then the outer circle represents the sectional area of the air-gap. Our sectional area for the air-gap is therefore equal to $\pi r^2 = 3.14 \times 2.9^2 = 26.32$ sq. cm.

3. In the air-gap, the density of the lines or $H = \frac{N}{\text{sec. area}}$
 $= \frac{200000}{26.32} = 7600$, and we have already seen that the ampere turns per centimetre length in air = $\frac{4}{5}$ of H . Therefore the ampere turns necessary per centimetre length in our air-gaps = $\frac{4}{5}$ of 7600 = 6080, the length of the air-gaps being 1 cm.

Summing up, we have—

| | |
|------------------------------------|--------|
| Ampere turns required for armature | = 50 |
| " " field magnet | = 607 |
| " " air gaps | = 6080 |
| | = |
| Total ampere turns required | = 6737 |

If we propose to use a current of say 3 amperes, then the total number of turns of wire required = $\frac{6737}{3} = 2246$.

Fig. 26 gives a dimensional sketch of the field magnet and armature of a well-designed shunt wound dynamo. Total lines through the armature = 1050000. Magnetising current, 6 amperes. What number of turns of wire are required on the field magnet limbs so as to produce the given number of lines through the armature? N in field magnet = N in armature $\times 1.32$.

From the figures given we find—

| | | |
|--|---|-------------|
| Sectional area of iron in field magnet limbs | = | 980 sq. cm. |
| " " armature | = | 810 " |
| " " yoke | = | 1120 " |
| " " pole piece | = | 1513 " |

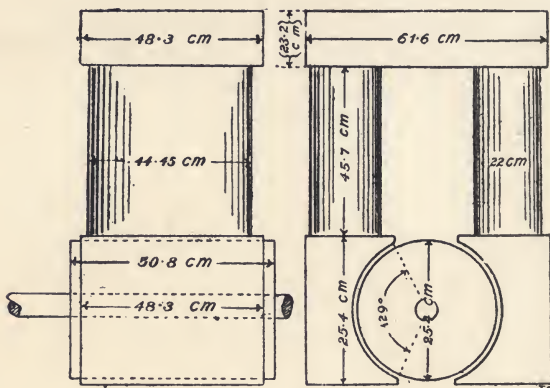

Fig. 26.

The yoke is the piece of iron on the top joining or yoking together the two field magnet limbs. The pole pieces are the larger curved pieces at the lower end of the limbs, usually made in one piece with them, and are bored out to embrace the armature. The difference between the diameter of the bore and the diameter of the armature gives the length of the two air-gaps, which in our case is equal to 2.1 cm.

Also from the dimensions given we get—Length of lines in field magnet limbs, yoke and pole pieces, as shown by the dotted line = approximately 181 cm., or 91 in the two field magnet limbs, 50 in the yoke, and 40 in the two pole pieces.

In the armature we have to estimate the length of a mean line.

Fig. 27 shows eight mean lines through the armature. Evidently the mean length will be something less than the diameter of the armature, say 20 cm. The length of each air-gap = 1.05 cm.

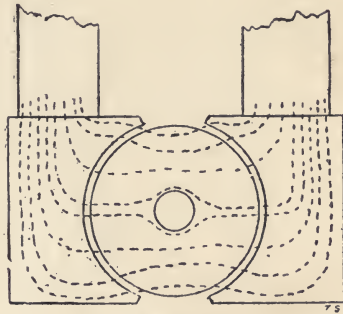

Fig. 27.

We can now calculate the density of the lines in each part, and find from our curve the necessary ampere turns per centimetre length for each. The only dimension not yet settled is the area of the air-gap. We see from the figure that the curved surfaces of the field magnet form part of the circumference of a circle of 27.5 cm. diameter. The circumference of such a circle = $2\pi r = 2 \times 3.14 \times 13.75 = 87.35$ cm. There are 360° in a complete circle, and our pole pieces subtend an angle of 129° , therefore the length of the curved surface = $\frac{129}{360}$ of 87.35 cm. = 31.3 cm. The breadth of this curved surface is the same as the breadth of the pole piece, viz., 48.3 cm., and if we multiply these together we get the area of the curved surface. But we have seen that the lines spread out in the air, and to get the proper sectional area through which lines of force will pass from pole piece to armature we have to add .8 time the length of the air-gap all round the area of the pole piece.

Therefore the sectional area of the air-gap

$$= 32.98 \times 49.98 = 1648 \text{ sq. cm.}$$

$$\text{Density of lines in the armature} = \frac{10500000}{810} = 12963,$$

or say 13000.

$$\begin{aligned} \text{Density of lines in the field magnet limbs} &= \frac{10500000 \times 1.32}{980} \\ &= 14100. \end{aligned}$$

$$\text{Density of lines in the yoke} = \frac{10500000 \times 1.32}{1120} = 12370.$$

$$\text{Density of lines in the pole pieces} = \frac{10500000 \times 1.32}{1513} = 9160.$$

$$\text{Density of lines in the air-gaps} = \frac{10500000}{1648} = 6377.$$

From our curve, with wrought-iron, we find—

| | |
|--|--------|
| Ampere turns per centimetre for field magnet limbs | = 17 |
| " " " armature | = 10 |
| " " " yoke | = 8 |
| " " " pole pieces | = 3 |
| " " " air-gaps = $\frac{4}{5}$ of 6377 | = 5101 |

| | |
|-------------------------------------|----------------------|
| Ampere turns for field magnet limbs | = 17 × 91 = 1547 |
| " " armature | = 10 × 20 = 200 |
| " " yoke | = 8 × 50 = 400 |
| " " pole pieces | = 3 × 40 = 120 |
| " " air-gaps | = 5101 × 2.1 = 10712 |

Total ampere turns required = 12979

Therefore if the magnetising current be 6 amperes, the total number of turns of wire to be put on to the field magnet limbs = $\frac{12979}{6} = 2163$ turns. This of course is calculated on the values given by our curve, and therefore shows the result we would get with one particular quality of iron. If we used magnetically inferior iron, the number of turns necessary would be greater. These turns should be wound in two coils, one placed on each limb.

In continuous current dynamos and many other pieces of electrical apparatus the iron is magnetised up to a certain density, and every time the current is raised to its prearranged value we get the same number of lines of force in the iron. How to get any desired density has just been shown, and the student is recommended to work through several problems similar to those given, so that he may become familiar with the method of working, for it is of the utmost importance in electrical engineering.

But in many cases we find the iron is being magnetised first in one direction and then in the opposite direction continuously, and often at a very rapid rate, the current employed being a rapidly reversing or alternating one.

We have already seen that, starting with a new piece of good iron, we can easily magnetise it up to 14,000 or 15,000 lines per square centimetre, and by doing so in small steps, measuring with each alteration in the m.m.f. the density produced in the iron, we can plot out the result in the form of a curve, as shown in Fig. 21.

If when we reach a value of $B = 14000$, we now decrease the m.m.f. in small stages back to zero, measuring the density at each step as before, we find that the magnetisation does not fall as rapidly as it rose, and when we have reduced the m.m.f. to zero we still have a field of 7,500 lines per square centimetre in the iron.

Let us now reverse the current, and again in small steps apply the reverse m.m.f. We find that for a certain time we are not magnetising but demagnetising the iron, and at a time when the

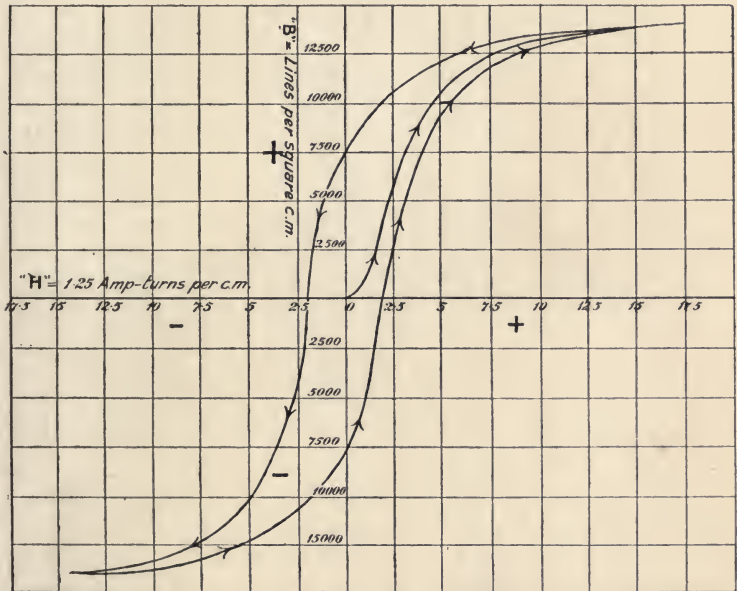

Fig. 28.

m.m.f. or $H = 2$ we have no magnetisation at all. That is to say, we have had to expend a certain amount of power to demagnetise the iron. If we continue increasing the reversed m.m.f. we find B rapidly rising in the opposite direction till it again reaches 14,000 lines per square centimetre, and on again decreasing the m.m.f. to zero we get 7,500 lines per square centimetre left in the iron in the opposite direction. Finally, by again reversing the current, making it similar in direction to what it was in the first case, we reduce B to zero, and then rapidly increase it again in

the first direction to the original maximum value where it appears to close the loop.

All this is shown in the curve, Fig. 28, the arrow heads showing the rise and fall in the magnetisation from 0 through one complete cycle. The figure en-

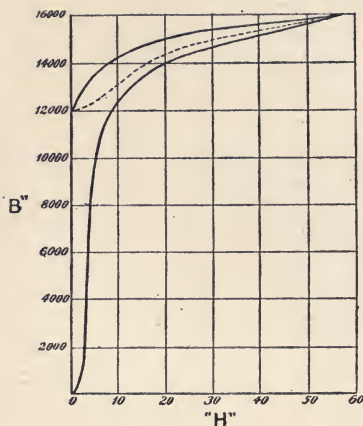

Fig. 29.

encloses a certain space the area of which is a measure of the power we have to expend for each cubic centimetre of the iron in magnetising it first in one direction, then reversing and magnetising in the opposite direction, and again reversing and magnetising in the original direction, or as it is called, in taking the iron through a complete cycle of magnetisation, and every time we repeat the cycle we must expend this amount of energy for every cubic centimetre of the iron in so doing.

The magnetisation produced at any part of the cycle, except at the extreme ends, lags behind the m.m.f., and because of this the curve is known as a hysteresis (or lagging) curve.

If we reverse the current repeatedly in this way the magnetisation will trace out this closed curve at each cycle, and the original curve starting from 0 will never again be repeated. From this it follows that when we magnetise the iron spoken of previously up to say 16,000 lines per square centimetre, we do not lose all the magnetisation when we stop the current; a fairly large amount, say 8,000 lines per square centimetre, or half the total amount, will remain, and when we start the current again the first part of the rise to 16,000 will not be according to the curve given in Fig. 21, but by that shown dotted in Fig. 29. We, however, arrive at 16,000 lines per square centimetre each time we provide the required number of ampere turns, but for any intermediate value of the magnetisation the value we get depends on whether we are increasing or decreasing the m.m.f. If we are starting from 0 and increasing the m.m.f., B will slowly rise (according to the specimen

of iron used) on the dotted part of the curve, Fig. 29, while when we decrease it will fall on the upper part of the curve, so that even though we do not reverse the current we get different values for B according to whether we have been increasing or decreasing the m.m.f. The difference, however, gets less the higher B becomes.

The power spent in magnetising and demagnetising the iron which is measured by the area enclosed by the curved lines, and which will vary with the different qualities of iron, is of very great importance when the magnetisation is reversed continuously

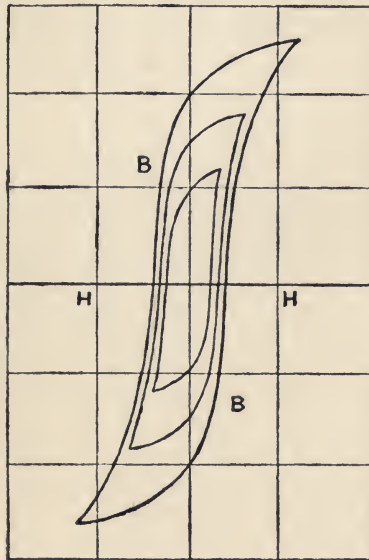

Fig. 30.

and rapidly, and any small diminution in the power absorbed may lead to a large saving in the year's working. Now the area of the figure depends on the degree to which we magnetise the iron, and consequently the smaller we make B , the smaller will be the loss of power in rapidly reversing the magnetisation.

But if the area enclosed was simply proportional to B , we would get no saving of power in working at a lower density, for should we require a certain number of lines, the smaller we make B the more iron we require. Thus, suppose we decide to work to a

density of 5,000 lines per square centimetre, then to carry a given number of lines we should require three times as much iron as we should if working at 15,000 lines per square centimetre, consequently if the area enclosed when $B = 5000$ were just one-third of the area enclosed when $B = 15000$, we should get no saving in power, for though the loss per cubic centimetre is only one-third, we have now got three times the amount of iron, and therefore the loss would remain as before. If, however, we examine the areas of these figures, we find that at 5,000 lines per square centimetre the area enclosed is less than one-third of that enclosed when $B = 15000$. When carefully measured it is found that the loss per cubic centimetre is proportional to the 1.6 power of B (see Fig. 30).

As there is no possibility of consuming energy, all we do in every case is to transform it from one form to another. Where then does the energy that we expend in magnetising and demagnetising the iron go? It goes to warm the iron, and if we work with a high value of B , the heat developed in the iron may become dangerously large, so that the insulation round the copper wires may be burnt and the whole apparatus destroyed. This in itself prevents us from using a high density when we are rapidly and continuously reversing the magnetisation. If we use a lower density, we not only have a saving in the energy spent, but also this smaller amount of energy being put into a larger volume of iron does not raise its temperature to anything like so high a degree as before. We therefore find in practice that with rapidly reversing or alternating currents the density of the lines employed in iron averages about 4,000 or 5,000 per square centimetre instead of 14,000 or 15,000 with steady or continuous currents.

CHAPTER VII.

ELECTRO-CHEMISTRY—PRIMARY BATTERIES.

WE have studied two effects produced by an electric current—first, a heating effect; and secondly, a magnetic effect. But an electric current produces also a third effect, which manifests itself only when it is passed through a liquid. Almost all liquids that we have to deal with are compounds of two or more elements. For instance, water is composed of two gases, hydrogen and oxygen, in the proportion of 2 volumes of hydrogen to 1 volume of oxygen. This is often written in the form of symbols, H_2O . Sulphuric acid is composed of hydrogen, oxygen, and sulphur, in the proportion of 2 parts hydrogen, 4 parts oxygen, and 1 part sulphur, and is commonly written H_2SO_4 . Again, copper sulphate is composed of 1 part copper, 1 part sulphur, and 4 parts oxygen, and is written $CuSO_4$, and we can represent all the solutions we have to deal with in this way.

Now when an electric current is passed through these solutions, they split up into parts, one part being liberated at the point where the current enters, and the other part where it leaves the liquid. If, for instance, we pass a current through water, we find oxygen gas being liberated where the current enters the water, and hydrogen gas where it leaves. The conductors that lead the current into and out of the liquid have been called the electrodes (or electricity doors). The leading-in electrode is called the anode (or entering door), and the leading-out one the cathode (or exit). Therefore we say oxygen is liberated at the anode, and hydrogen at the cathode. If the solution contains a metal it is always liberated at the cathode.

Let us take three vessels of glass or porcelain, containing a solution of copper sulphate ($CuSO_4$), using clean, carefully weighed copper plates as electrodes in each, and connect them as shown in Fig. 31. If a current is passed through the circuit we shall find after a certain time that the cathodes have all had copper deposited on them, and have consequently increased in weight, while the three anodes have diminished in weight to an equal

extent. Not only this, but the cathodes in A and B taken together have increased in weight by exactly the same amount as the cathode in C, while the two anodes in A and B have together lost in weight by exactly the same amount as that in C. But we remember that, in this divided circuit, the currents in the two branches A and B are together equal to the current in C, and the current in all parts must have been flowing for the same length of time, therefore the amount of decomposition produced at different parts of a circuit is seen to be proportional to the quantity of electricity that passes through that part of the circuit, or to the current multiplied by the time in seconds, for we saw in Chapter I. that the current is the rate of flow, or the quantity of electricity

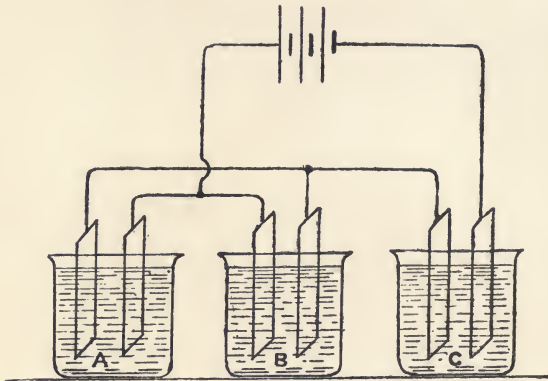

Fig. 31.

passing round the circuit in unit time (1 second). This could therefore be used as a method for comparing different quantities of electricity, and if we at the same time note the number of seconds that have elapsed from the moment we start the experiment to the time of switching off, we can very easily and very accurately determine the strength of the current that has been flowing.

Let us now take a number of vessels, one containing water, having platinum electrodes with long tubes filled with water arranged over them so as to collect the gases, oxygen and hydrogen, and join this in series with another containing copper sulphate with weighed copper plates as electrodes, and this again in series

with a vessel containing silver nitrate with weighed silver electrodes, and this in series with one containing zinc sulphate with zinc electrodes, and still another containing gold cyanide with gold electrodes, and pass a current of say 1 ampere for 5 minutes through the series, we shall find at the end of the experiment that we have produced a certain amount of decomposition in each of the vessels. On weighing the amount of hydrogen liberated we find .003114 gram. Now the quantity of electricity that produced this amount of decomposition was 300 coulombs, for 1 coulomb passes through every second when the current has unit strength, and therefore in 5 minutes 300 coulombs will have passed, therefore 1 coulomb would have liberated $\frac{.003114}{300} = .0001038$ gram of hydrogen. In the copper sulphate vessel the cathode will have increased in weight by .19626 gram, therefore 1 coulomb liberates $\frac{.19626}{300} = .000654$ gram of copper. In the silver nitrate solution the silver cathode will have increased in weight by .3354 gram, and therefore 1 coulomb liberates $\frac{.3354}{300} = .001118$ gram of silver. In the same way 1 coulomb is found to liberate .000337 gram of zinc and .000679 gram of gold.

We see that there is a great difference in the weight of each of these substances liberated by the same quantity of electricity. Now the elements have what is known as atomic weights, or combining weights, so that when any of them combine together they do so in these proportions. The combining weights of all the elements are very well known, and are given in text-books on chemistry. But there is another property attaching to the elements, known as their valency. When we compare the compounds formed with certain elements—hydrogen and chlorine, for instance—we find 1 atom of hydrogen (atomic weight = 1) combines with 1 atom of chlorine (atomic weight = 35.37) and forms 1 molecule of hydrochloric acid, and these two elements always combine in this proportion; thus 1 lb. of hydrogen combines with 35.37 lbs. of chlorine and forms 36.37 lbs. of hydrochloric acid (HCl). But if we take hydrogen and oxygen, we find 1 atom of oxygen combines with 2 atoms of hydrogen to form a molecule of water; thus 16 lbs. of oxygen (atomic weight = 16) combines with 2 lbs. of hydrogen (atomic weight = 1) to form 18 lbs. of water.

We say oxygen is a divalent element, for it requires 2 atoms of hydrogen to as it were saturate it. Similarly with ammonia we have 1 atom of nitrogen combining with 3 atoms of hydrogen to form a molecule of ammonia, consequently nitrogen is called a trivalent element, and it is evident that all the elements can be divided up into groups, monovalent, divalent, trivalent, &c. Of the number of substances we have spoken of above, the first three, viz., hydrogen, copper, and silver, are monovalent, while zinc is divalent and gold is trivalent, and if we examine the quantity of each liberated by 1 coulomb, we find that the weights of the first three substances are in proportion to their combining weights, for these are in proportion of 1 : 63 : 107.66. If therefore we take the amount by weight of hydrogen liberated as unity, we see we have 63 times the weight of copper and 107.66 times the weight of silver liberated by 1 coulomb. When we come to the zinc and gold, we find we have 32.45 times as much zinc and 65.4 times as much gold by weight, while the atomic weight of zinc = 64.9, and that of gold = 196.2. But zinc is a divalent element and gold is a trivalent element, and so we only get an amount equal to the combining weight divided by the valency, which for zinc = $\frac{64.9}{2}$

$$= 32.45 \text{ times the weight of hydrogen, and for gold} = \frac{196.2}{3} = 65.4$$

times the weight of hydrogen, because 1 atom of zinc is equivalent to 2 atoms of hydrogen, and 1 atom of gold to 3 atoms of hydrogen as far as their electrical decomposition is concerned, and if a certain quantity of electricity were capable of liberating a certain quantity of hydrogen, it could only liberate half the equivalent combining weight of zinc and one-third that of gold, but this quantity of zinc is 32.45 times as heavy as the equivalent amount of hydrogen, and the gold is 65.4 times as heavy.

The following table gives for a number of elements their atomic or combining weights, valency, and chemical equivalents where hydrogen is taken as unity. This is followed by the electrochemical equivalent where the amount of hydrogen liberated by 1 coulomb is taken as unity, the values for the other elements being this number multiplied by the chemical equivalent, and indicates the weight in grams of each of the elements liberated by 1 coulomb. The other columns give values for practical use that often save time in calculating.

ELECTRO-CHEMICAL EQUIVALENTS.

| Element. | Symbol. | Atomic Weight. | Valency. | Chemical Equivalent. | Electro-Chemical Equivalent. (Grams per Coulomb.) | Lbs. per 1,000 Ampere Hours. | Ampere Hours per lb. | Kg. per 1,000 Ampere Hours. | Ampere Hours per kg. |
|--------------------------|---------|----------------|----------|----------------------|---|------------------------------|----------------------|-----------------------------|----------------------|
| <i>Electro-positive—</i> | | | | | | | | | |
| Copper (cuprous) - | Cu | 63.0 | 1 | 63.0 | 0.0006542 | 5.192 | 192.6 | 2.355 | 424.6 |
| Hydrogen - | H | 1 | 1 | 1 | 0.0001038 | 0.08242 | 121.30 | 0.03738 | 267.50 |
| Mercury (mercurous) - | Hg | 199.8 | 1 | 199.8 | 0.002075 | 16.47 | 60.73 | 7.469 | 133.9 |
| Potassium - | K | 39.04 | 1 | 39.04 | 0.004054 | 3.218 | 110.8 | 1.459 | 685.2 |
| Silver - | Ag | 107.66 | 1 | 107.66 | 0.001118 | 8.873 | 112.7 | 4.025 | 248.5 |
| Sodium - | Na | 22.99 | 1 | 22.99 | 0.002387 | 1.895 | 527.8 | 0.8595 | 1164 |
| Copper (cupric) - | Cu | 63.0 | 2 | 31.5 | 0.0003271 | 2.596 | 385.2 | 1.178 | 849.2 |
| Iron (ferrous) - | Fe | 55.9 | 2 | 27.95 | 0.0002902 | 2.304 | 434.1 | 1.045 | 957.0 |
| Lead - | Pb | 206.4 | 2 | 103.2 | 0.001072 | 8.506 | 117.6 | 3.858 | 259.2 |
| Magnesium - | Mg | 23.94 | 2 | 11.97 | 0.0001243 | 0.9866 | 1014 | 0.4475 | 2235 |
| Mercury (mercuric) - | Hg | 199.8 | 2 | 99.9 | 0.001037 | 8.234 | 121.5 | 3.735 | 267.8 |
| Nickel - | Ni | 58.6 | 2 | 29.3 | 0.0003043 | 2.415 | 414.1 | 1.085 | 912.9 |
| Tin (stannous) - | Sr | 117.8 | 2 | 58.9 | 0.0006116 | 4.854 | 206.0 | 2.202 | 454.2 |
| Zinc - | Zn | 64.9 | 2 | 32.45 | 0.0003370 | 2.674 | 373.9 | 1.213 | 824.3 |
| Aluminium - | Al | 27.3 | 3 | 9.1 | 0.00009450 | 0.7500 | 1333 | 0.3402 | 2940 |
| Gold - | Au | 196.2 | 3 | 65.4 | 0.0006791 | 5.391 | 185.5 | 2.445 | 409.0 |
| Iron (ferric) - | Fe | 55.9 | 3 | 18.63 | 0.0001935 | 1.536 | 651.2 | 0.6066 | 1436 |
| Tin (stannic) - | Sr | 117.8 | 4 | 29.45 | 0.0003058 | 2.427 | 412.0 | 1.101 | 908.3 |
| <i>Electro-negative—</i> | | | | | | | | | |
| Bromine - | Br | 79.75 | 1 | 79.75 | 0.0008282 | 6.573 | 152.1 | 2.981 | 335.4 |
| Chlorine - | Cl | 35.37 | 1 | 35.37 | 0.0003673 | 2.915 | 343.0 | 1.322 | 756.3 |
| Iodine - | I | 126.53 | 1 | 126.53 | 0.001314 | 10.43 | 95.89 | 4.730 | 211.4 |
| Oxygen - | O | 15.96 | 2 | 7.98 | 0.00008287 | 0.6577 | 1520 | 0.2683 | 3352 |
| Nitrogen - | N | 14.01 | 3 | 4.67 | 0.00004850 | 0.3849 | 2598 | 0.1746 | 5728 |

Therefore .8611 gram of sodium will form—

$$\frac{40 \times .8611}{23} = 1.497 \text{ grams of NaOH.}$$

In all such cases of electrolysis we cannot say what current will flow through the circuit by simply considering the e.m.f. and the resistance, for when a liquid is decomposed the two parts into which it is separated (called the ions) appearing at the electrodes give rise to an e.m.f. which is in opposition to that which produced the decomposition. The current that flows through such a circuit = $\frac{E - e}{R}$, where E is the e.m.f. of the dynamo,

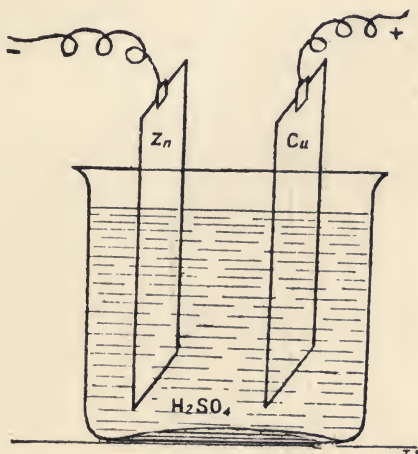

Fig. 32.

e the back e.m.f. of the electrolytic cell, and R the total resistance of the circuit. But we have still another difficulty. The resistance of a liquid is not easy to determine on account of this back e.m.f. put into the circuit by the decomposition of the liquid. Several methods have been tried, but the considerations of these we will leave for the next year's course.

From the above statement regarding the back e.m.f. produced it would seem that, if we place certain materials in certain liquids, they would give rise to an e.m.f. of themselves, and such is the case, forming what are known as primary batteries. If, for in-

stance, we place a piece of zinc and a piece of copper in dilute sulphuric acid (Fig. 32), we produce an e.m.f. between the zinc and copper, and consequently if we complete a circuit between them a current will flow round the circuit, that is to say, a certain amount of electrical energy will be expended, the energy being provided by the zinc, which dissolves in the acid.

The current that flows must necessarily traverse the liquid, and consequently the liquid will be decomposed into two parts, which will appear one at the copper and the other at the zinc. Sulphuric acid being the liquid employed in the above case, it will split up into H_2 and SO_4 , the H_2 being liberated where the

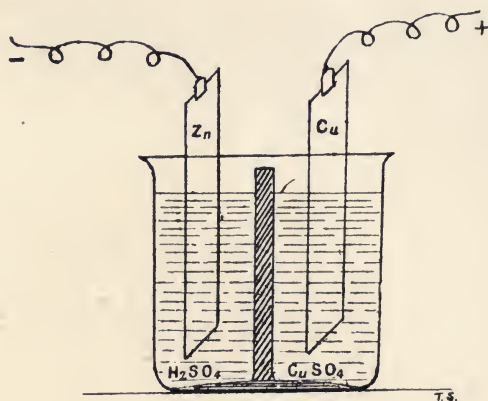
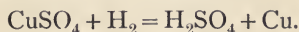

Fig. 33.

current leaves the liquid, viz., at the copper plate, and the SO_4 where the current enters the liquid, at the zinc plate. The SO_4 will combine with zinc, and consequently the zinc dissolves, forming zinc sulphate ($ZnSO_4$). The hydrogen liberated at the copper plate causes a back e.m.f. as we have already seen, and so, as soon as we complete the circuit and allow a current to flow, reactions take place that cause a fall in the e.m.f. due to the decomposition of the liquid, and the consequent liberation of hydrogen at the copper plate. If the current be maintained for any length of time we find it getting weaker, till it finally ceases. This is due to the hydrogen collecting more and more on the copper plate, till it finally completely covers it with a film, and hydrogen being

a non-conductor of electricity, prevents any further flow of electricity round the circuit. The cell is then said to be polarised.

If we divide the vessel into two parts by means of a porous partition of say unglazed earthenware (which is the common material employed), and place the zinc with dilute sulphuric acid in one compartment, and the copper with copper sulphate solution in the other (Fig. 33), we prevent the hydrogen from collecting on the copper plate, for the hydrogen now combines with the copper sulphate to form sulphuric acid, while the copper so liberated is deposited on the copper plate—



If pure zinc is used it will be unacted upon by the acid until a current flows through it, when by the liberation of SO_4 in contact with the zinc, zinc sulphate is formed. The amount of zinc dissolved is proportional to the quantity of electricity passing, or to the current multiplied by the time.

Q. 1. If in this cell a current of 1 ampere is maintained for 1 hour, how much zinc has been converted into zinc sulphate? The atomic weight of zinc = 64.9.

Zinc is a divalent element, and therefore its chemical equivalent = 32.45, and the electro-chemical equivalent = $32.45 \times .0104$ mgm. = .000337 gm. If 1 ampere be maintained for 1 hour, then 3,600 coulombs will have passed through the solution, and therefore $.000337 \times 3600 = 1.21$ grams of zinc will have been dissolved.

Q. 2. In this same cell how much copper will be deposited on the copper plate by 1 ampere in 1 hour? The atomic weight of copper = 63.

Copper being a monovalent element, its chemical equivalent = 63, and its electro-chemical equivalent = $63 \times .0104$ mgm. = .000654 gm.

Therefore, as 3,600 coulombs pass through the solution, we have $.000654 \times 3600 = 2.35$ grams of copper deposited on the copper plate.

This copper has come from the copper sulphate solution, and therefore, if the cell is to go on working, it must be provided with a store of this substance, or the solution would soon be converted into sulphuric acid, all the copper having been deposited on the copper plate, and polarisation would then take place as before.

To prevent this a number of crystals (of CuSO_4) are suspended in the copper compartment and slowly dissolve, keeping the solution always saturated.

If commercial zinc is used it will contain impurities, other metals being present to a certain extent. We therefore have all the requisites for a cell complete in the zinc compartment, viz., two different metals and the liquid and currents will circulate through this local circuit, from the zinc through the liquid to the impurity completing the circuit through the body of the zinc itself, and consequently the zinc will be dissolved even when we have no outside connection between the copper and the zinc plates. This is called local action, and is prevented by either using chemically pure zinc or by amalgamating it with mercury. The amalgamating is accomplished by first cleaning the zinc in acid, and then rubbing mercury over its surface. The mercury amalgamates with the zinc, forming a paste of mercury and zinc which will spread itself over the impurities, preventing them from coming into contact with the liquid, while the zinc is continually brought to the surface as it is required by the mercury amalgamating with more of it. This cell is known as "Daniell's" from the name of its inventor. It gives an e.m.f. of 1.07 volts.

We have seen that SO_4 is liberated at the zinc and copper at the copper plate, and though this reaction must be taking place throughout the whole body of the liquid, it is only at the electrodes that it becomes evident. It is supposed in this, as in every case of electrolysis, that the molecules become polarised, and then an interchange takes place between them, this of course being quite invisible even with the most powerful microscope, for molecules cannot be seen by any known means. This interchange is represented in Fig. 34, where we see, first, the molecules polarised and in line; and second, the interchange that goes on among the many millions of molecules while the current flows.

The resistance of the cell is often of great importance, for since the current that flows in the external part of the circuit must also flow through the cell itself, a large amount of its e.m.f. will be spent on the cell if its resistance is high, and again the maximum current it can deliver will be small.

Q. 1. If the Daniell cell described above gives an e.m.f. of 1.07 volts, and its resistance be 1 ohm, what is the maximum current it can deliver?

$$\text{The current} = \frac{\text{total e.m.f.}}{\text{total resistance}} = \frac{1.07}{1} = 1.07 \text{ amperes.}$$

That is to say, when we join the terminals together by a thick, short copper wire, having in itself a perfectly negligible resistance, the current that would flow through it would be 1.07 amperes.

Q. 2. If a similar cell were used, but one having a resistance of $\frac{1}{4}$ ohm, what would be the maximum current obtainable?

$$\text{Current} = \frac{\text{e.m.f.}}{\text{total R}} = \frac{1.07}{\frac{1}{4}} = 4.28 \text{ amperes.}$$

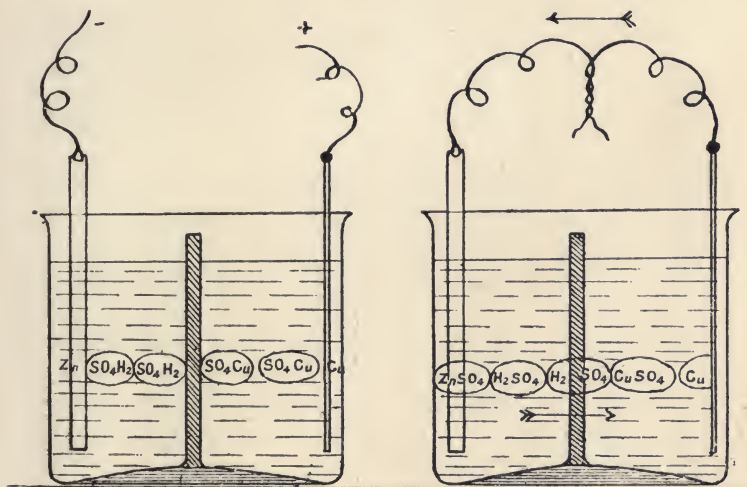

Fig. 34.

Now the resistance of a cell lies chiefly in the resistance of the liquids employed, for all liquids have a much higher specific resistance than metals, and the resistance of liquid conductors, like metallic conductors, is proportional to $\frac{\text{length}}{\text{sec. area}} \times \text{sp. res.}$, so that for any given liquid the resistance will be less the shorter we make the distance between the electrodes, and the larger we make the sectional area through which the current passes, *i.e.*, the larger we make the electrodes. Therefore the resistance of any given cell depends on its size and the distance between the zinc and copper plates.

The e.m.f., however, depends simply on the materials employed, and would have the same value whatever the size may be. A cell made up in a teacup would have exactly the same e.m.f. as one made of the *same materials* in a 10-gallon jar, but the small one would have much more resistance than the large one, and therefore could not deliver so large a current.

A very large number of primary cells have been invented, the object being in every case to increase the e.m.f., decrease the internal resistance, effectually to prevent polarisation, and to minimise the amount of attention required to keep them in good working condition.

When small currents are required for short intervals of time as is used for ringing bells, sending signals, telephoning, &c., the "Leclanché" cell is superior to any, in that it requires no attention whatever for months or even years if put into a suitable place, there being no action in the cell when not delivering a current.

This cell consists of a vessel of glass or earthenware containing a solution of salammoniac (ammonium chloride, NH_4Cl) into which a zinc rod or sheet and a porous pot is placed. The porous pot contains a plate of carbon surrounded by crushed carbon and manganese dioxide (MnO_2), the top being covered with a compound consisting principally of pitch and shellac. The salammoniac solution penetrates through the porous pot and the crushed carbon and manganese dioxide, no second liquid being employed. The only object in having the porous pot is to keep the manganese dioxide and carbon in close contact, and to prevent the zinc and carbon from touching. The e.m.f. of the cell is nearly 1.5 volts.

When we complete a circuit between the carbon plate and the zinc, a current flows from the zinc through the salammoniac solution to the carbon, and from the carbon through the circuit provided back to the zinc. In so doing, the solution of salammoniac is decomposed into ammonia (NH_3), chlorine (Cl), and hydrogen (H). The chlorine attacks the zinc and forms zinc chloride, the ammonia is given off as a gas, and the hydrogen is liberated at the carbon and manganese dioxide mixture. Here the hydrogen decomposes the manganese dioxide, and combines with some of its oxygen, forming water. In chemical symbols this action is represented thus—

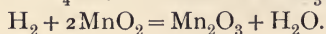
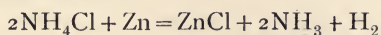

These cells are commonly made in three sizes, the intermediate size having a resistance of about 1 ohm.

They are also made in a form known as dry cells, which is an improvement in some respects on the older form described above. In this the positive element (the zinc) is used to form the containing vessel, which is cylindrical in shape, and made from sheet zinc with a zinc bottom. This is lined inside with plaster of paris, which takes the place of the porous pot. Inside this is placed a carbon plate surrounded by a paste of powdered carbon, manganese dioxide, glycerine, and salammonic solution. The top is then covered in with a compound of pitch and shellac, a very small vent-hole being left. The action of the cell is the same as in the older form, and being made of the same materials, it produces the same e.m.f., but its resistance is less because the sectional area through which the current passes is considerably increased, and the distance between the zinc and carbon is diminished. An intermediate size has a resistance of about .4 ohm, therefore it can deliver a maximum current of nearly 4 amperes instead of 1.5 amperes with the older type. It is also more convenient in many cases, for it can be placed in any position.

Polarisation is prevented in these cells to a certain degree by the manganese dioxide, which being rich in oxygen, parts with some of it to burn up the hydrogen that would otherwise polarise the cell. But manganese dioxide does not part with its oxygen very readily, and therefore if the current be large and is being continued for any length of time, more hydrogen will be liberated than the MnO_2 can deal with, and the cell will begin to polarise. If it is then allowed to rest for a short time, the MnO_2 will burn up the hydrogen remaining, and the cell will be ready for a fresh start. It is for this reason that it is commonly used for intermittent current work.

A cell that has found a certain amount of favour in this country with railway companies and others is that known as the "Fuller bichromate" cell. In this an outer vessel of glass or porcelain contains a plate or plates of carbon in a solution of bichromate of potash and sulphuric acid (1 of acid to 9 of water by volume). In the size most commonly employed, one carbon plate 6 by 2 in. is used, and to about 3 pints of the sulphuric acid solution from 3 to 4 oz. of bichromate of potash

is added. A thick zinc rod with a broad flat base is placed in a porous pot which stands in the outer vessel. Very dilute sulphuric acid is poured in, and about an ounce or so of mercury, which keeps the zinc always well amalgamated (see Fig. 35).

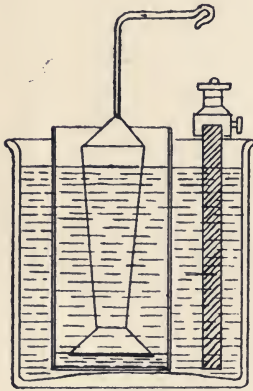

Fig. 35.

The e.m.f. of this cell is high (nearly 2 volts), and it requires but little attention. Fresh crystals are added from time to time (depending on the amount of use), the solution in the outer vessel turning a blue tint instead of the characteristic orange colour of the bichromate of potash when more crystals are required. The porous pot also requires emptying and refilling occasionally owing to diffusion, this action and also the internal resistance depending on the degree of hardness and the thickness of the porous

pot. It, however, is superior to the Daniell cell where large currents are required for long periods, such as is required in railway work. It is also considerably cheaper to make and to maintain, and equally reliable.

In cases where the current is only required for a few seconds; such as in dropping an indicator, releasing an interlocking lever and the like, large-sized Leclanché cells are preferable, in that they require much less attention than any other cell.

The chemical action that takes place in the "Fuller bichromate" cell when a current flows is represented as follows:—

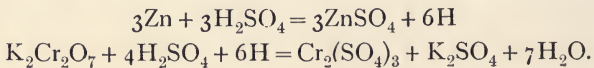

CHAPTER VIII.

ACCUMULATORS.

IF we place two plates of lead into dilute sulphuric acid, keeping them apart, and send a current through the acid from one plate to the other, the acid becomes decomposed, hydrogen being liberated at one plate (where the current leaves the liquid) and SO_4 where it enters the liquid, but SO_4 is able to decompose water, combining with the hydrogen to form sulphuric acid (H_2SO_4) and liberating oxygen. We therefore get the same effect as when we electrolyse water, but the addition of the sulphuric acid decreases the resistance very considerably. If we now reverse the current, we get hydrogen given off at the plate where formerly oxygen was given off, and *vice versa*. We notice, however, a peculiarity about the plates. The last anode (or the plate where oxygen was given off last) has turned a dark brown colour, while the last cathode appears grey coloured. Every time we reverse the current we find the colour of the two plates reversed, but we notice that it takes longer each time to effect the change, and also that the gases (oxygen and hydrogen) are not given off immediately the current is started, but with each reversal of the current a longer time elapses before gas appears at the electrodes. If we continue to reverse the current in this way for some long period of time we shall find eventually that several hours are required between each reversal before gas is evolved.

When we examine the plates of lead we find that the surfaces have entirely changed. They are no longer hard metallic surfaces, but soft, porous, spongy masses. On testing the nature of the materials we find the dark brown substance to be peroxide of lead (PbO_2), and the grey substance on the other plate pure metallic lead in a porous or very finely divided condition. This has come about by the oxygen first eating into or rusting the plate of lead, then the hydrogen being liberated at this plate, combined with the oxygen to form water, leaving the lead in a spongy state,

and every time we repeated the reversal the oxygen oxidised or rusted the plate a little deeper before gas was given off.

Now if we take these two materials, viz., metallic lead in a finely divided state, and peroxide of lead, and place them in sulphuric acid, we find they give an e.m.f. of nearly 2 volts, the finely divided lead taking the place of the zinc in the primary battery, and the peroxide of lead (a substance rich in oxygen, and one that very readily parts with it in presence of hydrogen) taking the place of the carbon with its manganese dioxide or other depolarising agent, and if we join the two plates together by suitable conductors we get a current through them which remains practically constant for a long time, depending on the strength of the current. The current, however, eventually begins to decrease, indicating that the e.m.f. is falling, and if we still keep it connected up it will in a short time give no e.m.f., and the current will fall to zero.

If we examine the plates we shall find that the finely divided lead has turned white, while the peroxide plate is a lighter brown than previously. On testing we find the lead plate has been converted into sulphate of lead (PbSO_4), just as the zinc was converted into sulphate of zinc, but with this difference, sulphate of zinc being soluble in sulphuric acid solution, was found in the body of the liquid, whereas the sulphate of lead is perfectly insoluble, and consequently remains where it is formed.

These two plates can be brought to their original condition again if we send a current through them in the reverse direction to that which we took from them. Oxygen and hydrogen will be liberated at the plates as before, and the hydrogen will combine with the SO_4 to form sulphuric acid, leaving the plate with a surface of finely divided metallic lead, while the oxygen on the other plate will reconvert it into peroxide of lead.

This gives the cell the appearance of storing electricity, for we charge it up with a current for a certain time, and can then take a current from it at some future time, and for this reason it is often called a storage cell or accumulator. This cell is used to a very large extent in electrical engineering, and it is certainly by far the best cell known, for it gives a high e.m.f. compared with many primary cells. Its internal resistance can be made very small, for sulphuric acid is one of the best liquid conductors, and it will not polarise even when delivering large currents. We find them

employed in electric light stations to help with the supply at times when the demand is great, to supply the whole of the power required through the night and early morning, and to act as a stand-by in case of a breakdown to the machinery, being charged up in the mornings and early afternoons. Also in stations supplying electrical energy to trains and tramways we find them run in parallel with the dynamos, helping with the load when it suddenly becomes excessive, and absorbing power when it suddenly decreases, thereby taking many of the injurious strains from

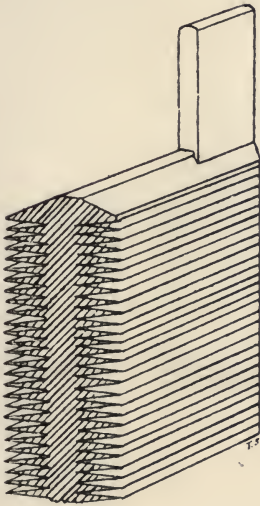

Fig. 36.

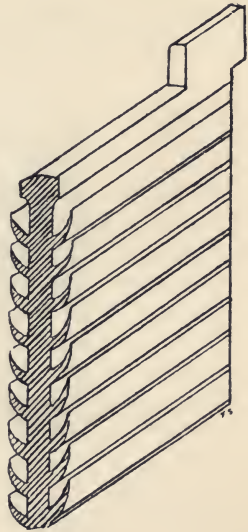

Fig. 37.

the machinery that would otherwise occur. In fact, accumulators are to be found in almost every branch of electrical engineering.

The process of manufacture, as described above, make it both lengthy and costly, though when so made they are stronger and better than when made by the process usually employed, which we will now consider.

We see that what is required is to provide two lead plates, one coated with spongy metallic lead, the other with spongy peroxide of lead, and these can both be made by making a paste of red

lead (Pb_3O_4) and sulphuric acid solution, putting a thickish layer on each of two roughened lead plates, and allowing it to dry. The common practice is to cast the lead plates into various grid shapes, some of which are shown in Figs. 36-38, and to fill the holes with the paste, which should be well mixed, and about as stiff as thick cream. Some time is saved and the same result obtained if we use a paste made of litharge (PbO) for the negative plate, and the red lead paste for the positive plate. When the paste has been well squeezed into the grids, and made flush with the surface of the lead, they must be left till quite dry, preferably standing on end in racks, so that the air may get to every part of the plates. These pasted plates have then to be formed, one into

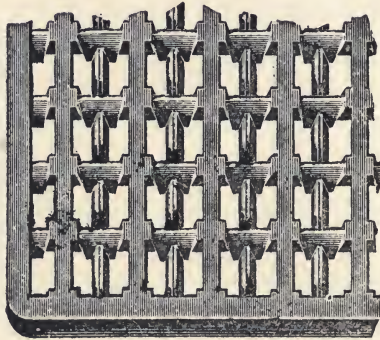
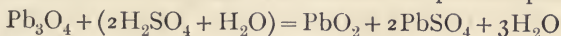

Fig. 38.

peroxide of lead and the other into metallic lead, and this formation is accomplished by sending a current through sulphuric acid solution, using the red lead plate as anode and the litharge plate as cathode. The current must be kept on for a long time at the start, especially if the cells are of large size, say twenty-four hours, for if the plates are allowed to stand in the acid after a slight formation they will be converted more or less into sulphate of lead, and the work will have to be done again. After the first long run, they must be charged each day for as long a time as possible until fully formed. All this time the oxygen and hydrogen, instead of being given off as gas, has been acting on the pasted plates, converting one into metallic lead and the other into peroxide of lead, and when this has been accomplished the gases will be freely given

off, and the formation process is completed. In this case no reversal of the current is required, for the spongy nature of the materials is brought about by originally pasting it on in this form, and not by the action of the current.

When the pastes are made we have for the positive plate—



and for the negative plate, if litharge is used, we have—

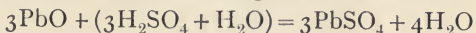

and these are left for ten or twelve days to dry.

In forming, the sulphuric acid is decomposed in presence of water, in the pores of the spongy masses, and we get at the + plate—

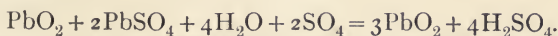

At the - plate we get hydrogen liberated instead of SO_4 , which forms pure lead and sulphuric acid, thus—

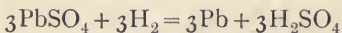

or if red lead be used for - plate also, we have—

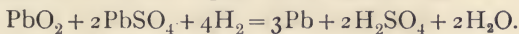

Sulphuric acid is therefore formed at both plates, and so the strength of the acid in the cell increases during the process of formation.

The size of the cell is increased both by making the plates of larger size, and by taking a number of positive (peroxide) plates, and interleaving them with negative plates, joining all the positive plates together to form one large positive, and all the negatives together for the negative plate. Of course it is absolutely necessary that the plates be prevented from touching each other, and therefore insulating strips of ebonite or glass are inserted between the plates. The plates are not joined together by soldering, for with the acid fumes condensing on the joint it would soon be eaten away, owing to the formation of a primary cell at this part, as solder and lead in sulphuric acid will give an e.m.f. of their own, and the local action would soon eat away the joint. The method usually adopted for joining the plates is to burn the lead together, so that no other metal is employed. This process of lead burning requires a skilled workman for its neat and perfect execution, and care has to be taken to make a good joint, so that its sectional area shall not be less than that of the part leading to it. The

plates should be raised from the bottom of the cell by providing insulating strips of glass, ebonite, or paraffined wood for them to stand on, so that any of the paste falling away from the plates may drop to the bottom and not short circuit the cell.

When the cell is fully formed the density of the acid solution should be 1.20, which is the density of a 28 per cent. solution by weight. As we discharge the cell the acid becomes weaker, for the lead plate is being formed into sulphate of lead, while the hydrogen by combining with the oxygen on the peroxide plate forms water, which diffuses through the body of the liquid. The density of the acid solution when discharged should be about 1.178.

In discharge we start with PbO_2 on the positive plate, and we get—



and on the negative plate, starting with pure lead, we get—

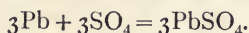

Both plates are thus brought superficially to lead sulphate, and the e.m.f. falls when the acid is no longer able to diffuse through the pores into the interior portions, for the sulphate of lead so formed occupies a greater space than the lead or peroxide of lead, and so the formation of sulphate of lead on the surface closes the pores more or less, and thus restricts the further diffusion of the acid, and consequently the e.m.f. falls, even though there may still be plenty of metallic lead and peroxide of lead inside; but if the acid cannot get to it, it is of no use, and the capacity of the cell is dependent on the extent of diffusion.

The cell has now to be charged up once more, and we get on the + plate—



and on the - plate—

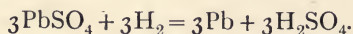

The discharge current should not exceed a certain value, depending on the size of the cell and on the form of the grids. The maximum discharge current for any given cell will be specified by the manufacturer, who will also give the capacity of the cell in ampere hours. Thus a cell may be stated to be of 500 ampere hours capacity, and the maximum discharge current to be 50 amperes. Then this cell should be able to deliver a current of

50 amperes for 10 hours. But the capacity of a cell depends in part on the rate of discharge. If the cell mentioned above be discharged with a current of 10 amperes, it would probably continue delivering this for more than 50 hours, and the smaller the discharge current the larger is its capacity. This is shown graphically on the curve, Fig. 39.

The cell is said to be discharged when the e.m.f. has fallen to 1.8 volts. If we continue to discharge it beyond this point, it rapidly falls to zero, and the plates will become excessively sul-

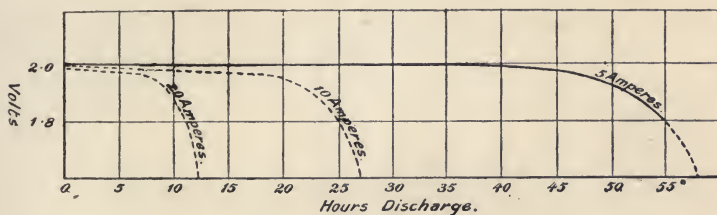

Fig. 39.

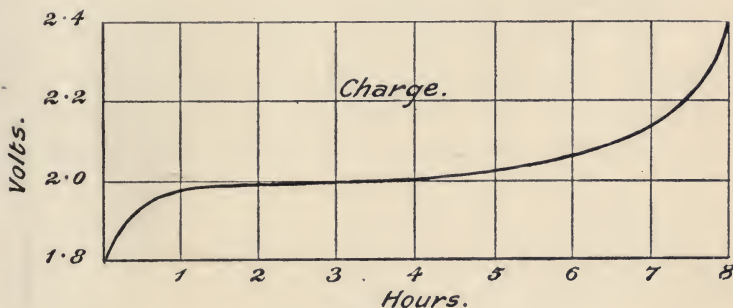
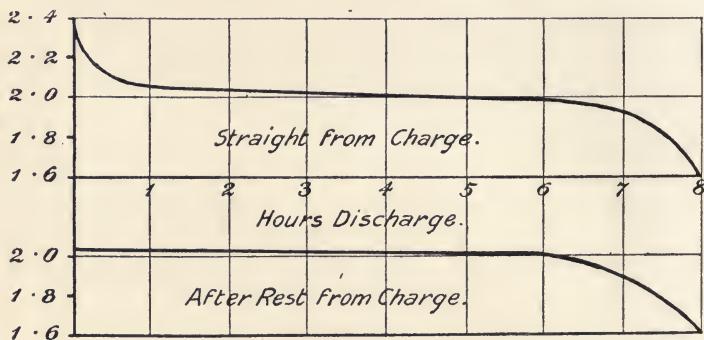

Fig. 40.

phated, and difficult to recharge. Therefore when the e.m.f. of any cell has fallen to 1.8 volts, it should be taken from the discharge circuit and recharged as soon as possible. Fig. 40 represents the curve of e.m.f. of a cell during charge. It starts at 1.8 volts, and quickly rises to a little under 2 volts. It remains practically steady for some hours at this e.m.f., with a slight upward tendency until it is nearly recharged. At this stage the e.m.f. rises again rapidly until it reaches 2.4 volts, and gas is then given off freely, giving the solution the appearance of

boiling. This final rise from a little over 2 to 2.4 volts is due to the concentration of the acid in the pores. When the cell was discharged the plates were more or less converted into PbSO_4 , and now on charging we get hydrogen liberated where the current leaves the liquid, that is, in the pores of the spongy lead plate, and this combines with the SO_4 forming H_2SO_4 —strong sulphuric acid—and the e.m.f. depends not only on the nature of the materials, but in this case on the strength of the acid also, as can be shown by placing a spongy lead plate and a peroxide of lead plate into acids of various strengths, and measuring the resulting e.m.f. It is also borne out by the fact that after the cell has stood long enough for this concentrated acid to diffuse



Figs. 41 and 42.

out, the e.m.f. falls to its normal value. If therefore we use the cell directly after charging, we get an e.m.f. which will be high at the start, and which will rapidly fall to slightly over 2 volts, continuing to fall from this point at a very much slower rate till it reaches 1.8 volts, when it should be again charged up. Fig. 41 gives a curve of discharge, starting from the time the charging current was stopped. If after charging we allow the cell to stand for an hour, we get a curve of discharge as represented in Fig. 42.

These cells should never be allowed to stand for any length of time in an uncharged state, for the plates will become excessively sulphated by standing in the acid in this condition, and then it is a much more difficult task to recharge them, taking a much longer time with a proportionally larger amount of energy. If

they are to be left standing idle at any time they should be first charged up fully, and a further charging current sent through them once a week if possible to keep them in condition.

This weekly charge is necessary because the cells discharge themselves slowly if allowed to stand, owing to local action. On the peroxide plate we have peroxide of lead and metallic lead in sulphuric acid, consequently we have on this plate all the essentials for a cell complete in itself, and currents will circulate from the lead through the acid to the peroxide and back through the lead body of the plate. These local currents will in time discharge the cell, and consequently if they are to be kept in good condition and ready for use at a moment's notice they require a periodical charging for a short time.

The repeated charging and discharging of the cell slowly converts the lead grid into peroxide of lead. This prevents local action to a certain extent, and increases the capacity of the cell, which therefore has the appearance of improving with use. This action continues till a point is reached where the grid is so weakened that it is no longer able to support the weight of the peroxide of lead, and the plate then falls to pieces.

It is for this reason that great care must be taken in handling positive plates which have been in use for some time, for a little rough treatment may entirely destroy them.

When cells have become excessively sulphated it is extremely difficult to recharge them, and a large amount of time is often necessary before any appreciable effect is made. In such cases it is sometimes advisable to take out the acid and put in a solution of sodium sulphate. This under the action of the charging current will soften the plates and bring them to their original colour. The sodium sulphate solution should then be poured off, and the acid replaced in the cell, and the charging continued till the process is complete.

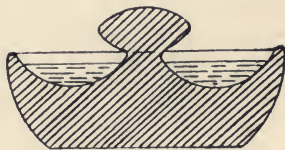

Fig. 43.

The acid has a great tendency to creep over the tops of the cells, and when this occurs the supports soon become coated with the acid, forming a partial short circuit. To prevent this the tops of the cells should be coated with paraffin wax, and the cells

should stand on oil insulators. One of the forms employed is shown in Fig. 43. One of these would be placed at each corner of the cell, and the recess filled with heavy petroleum or other insulating oil.

If the cells are large and the space limited it is usual to arrange them in rows or tiers one above the other, and in this case it is best to allow enough space to take the plates from any cell without moving the cell bodily, for the weight of the whole cell is often very great.

When the cells are fully formed, gas is given off freely, oxygen at one plate and hydrogen at the other. The same occurs at the end of each charging, and the gases carry off some of the acid, which is not only very disagreeable but injurious to the surrounding objects, unless they are protected with some insulating material. To prevent this to some extent, glass plates are often placed over each cell. These catch the acid and allow it to drop back into the cell. The gases should not be allowed to accumulate, for the mixture of oxygen and hydrogen is explosive, therefore the accumulator room should be properly ventilated, and naked lights should not be used for examination of the cells. A small portable incandescent lamp is very convenient for this purpose.

In the absence of the maker's definite figure for the maximum discharge current, we may reckon on say 1 ampere for every 12 sq. in. of positive surface, reckoning both sides of the plate. Thus a positive plate 4 in. square will have 32 sq. in. of surface, and the maximum discharge current for this will be $\frac{32}{12} = 2.7$ amperes. But the different makers give very different figures for the various forms. Some are known as slow discharge and others as rapid discharge cells, and the figure given above would be that of a slow discharge cell, and it would be best to work at this rate until reliable information as to the maximum discharge rate has been obtained.

The cells now being supplied for traction work by the Tudor Accumulator Co., the E.P.S. Co., and others, will have a much higher discharge rate. The positive plates are made in the form shown in Fig. 36, and are not pasted, being formed by the original process of peroxidising the surface of the lead plate itself. It is made in the form shown so that the surface may be as large as possible. Plates made in this way are stronger than the pasted

form, and will allow of a much larger maximum discharge current without injury. The negative plates used with these are of the ordinary pasted form.

If the maximum discharge current is exceeded, the plates will buckle owing to the large amount of chemical action taking place in them. This straining causes the paste to loosen and eventually fall away from the plates. If the plates buckle sufficiently to come into contact the cell will be short circuited, and in all probability entirely ruined. It is therefore of the utmost importance that the maximum discharge current should not be exceeded.

The efficiency of accumulators is measured by the watt hours got out divided by the watt hours put in, not by the ampere hours, because in charging a higher e.m.f. is required than that given by the cells, for we have to overcome their back e.m.f. before we can get a current through them, and the current that flows is equal to the e.m.f. employed (called the impressed e.m.f.) minus the back e.m.f. of the cells, divided by the total resistance of the circuit, or

$$C = \frac{E - e}{R}$$

Q. 1. A compound wound dynamo producing a terminal potential difference of 150 volts is used to charge 60 storage cells, each having an e.m.f. of 2.2 volts and a resistance of .001 ohm. If the leads joining the dynamo and cells have a resistance of .2 ohm, what will be the current generated? (C. and G. Examination Electric Light and Power, 1897.)

$$C = \frac{E - e}{R}$$

$$C = \frac{150 - (60 \times 2.2)}{(60 \times .001) + .2} = \frac{18}{.26} = 69.2 \text{ amperes.}$$

Q. 2. A battery of 55 accumulators is charged with a current of 50 amperes, the p.d. on it being adjusted to keep the current constant. During the charging, which lasted for 8 hours, the mean p.d. employed was 137 volts. In discharging the mean current was 60 amperes, and after 6 hours the e.m.f. had fallen to 99 volts, the mean e.m.f. during discharge being 110 volts. What was the efficiency of the battery?

$$\text{The efficiency} = \frac{\text{watt hours got out}}{\text{watt hours put in}}$$

$$\text{The efficiency} = \frac{110 \times 60 \times 6}{137 \times 50 \times 8} = \frac{99}{137} = 72 \text{ per cent.}$$

CHAPTER IX.

INDICATING INSTRUMENTS—AMMETERS, VOLTMETERS, OHMMETERS.

IN previous chapters we have many times spoken of the ammeter and voltmeter as instruments for measuring the current and the e.m.f. These instruments depend for their action on one of the effects of an electric current.

We have studied three different effects, viz., a magnetic effect, a heating effect, and an electrolytic effect, and either of these might be utilised for indicating the current or e.m.f. The first is used to a very large extent, the second to a less extent, while the third is seldom or never utilised in practical work for indicating instruments.

In all instruments depending on the magnetic effect a coil of wire is employed. The current in passing round the coil creates a magnetic field through the centre, which in some is made to act upon a small piece of iron pivoted inside the coil attached to a pointer, so that by the movement of the piece of iron the pointer is moved over the scale. A controlling force is provided which increases as the magnetic pull on it increases, so that the indications of the pointer may be proportional to the current. This controlling force often takes the form of a fine spiral spring, similar to the hair-spring in a watch, but made of some non-magnetic material. In others the force of gravity is employed as the controlling force.

The one essential difference between the ammeter and the voltmeter is in the resistance of the instruments. The same movement will serve for either, but if it is required for an ammeter the resistance must be made as small as possible, while if it be required for a voltmeter the resistance must be made as large as possible. The reason for this is simple. The ammeter, if it is to measure any given current, must be put into the circuit, and the whole current passed through it, and if it had any appreciable

resistance it would alter the current flowing, owing to the insertion of its own resistance, and again it would cause a large voltage fall on itself, for the voltage lost on the ammeter is (as in any other part of the circuit) equal to the current flowing through the ammeter multiplied by the resistance of the ammeter, and therefore if the resistance is small, the voltage spent on it will also be small, and its insertion in the circuit will consequently cause no appreciable drop in the voltage at any given part of the circuit. We have also seen that the power lost at any part is equal to C^2R , and consequently if R be large, we should have a fair amount of power lost in the ammeter, and as the ammeter commonly remains in the circuit continuously, we should have this continuous loss of power, therefore the resistance of an ammeter should be made as small as possible, which means that the wire on the coil must be made both short and thick. The voltmeter, however, is always connected as a shunt across the points where the difference of potential is to be measured, and is never put into the main circuit. Now we have seen that the voltage between any two points of the circuit depends on the resistance between the points and on the current flowing, and if the voltmeter had a low resistance it would considerably lower the resistance between any two points it may be joined across, and consequently the voltage between the two points would be considerably reduced by the application of the voltmeter, which would prevent a true reading of the voltage being obtained. We see therefore that the voltmeter must have such a high resistance that it will cause no appreciable fall in the resistance between any two points it may be joined across. In some instruments the voltmeter resistance will approximate to 100 ohms per volt, so that a voltmeter to read 100 volts would have a resistance approaching 10,000 ohms, while an ammeter to read to 100 amperes would have a resistance of roughly .001 ohm.

But if the same movement is to serve for both instruments, it is essential to provide the same strength magnetic field for both when indicating the maximum reading. The strength of the magnetic field required depends on the strength of the controlling force and on the friction at the pivots, and when the movement has been designed and settled, then a certain strength field is required to move it over the full range of the scale, and this field has to be provided whether it be used for a voltmeter or an ammeter, or whether it be used for low values or high. Thus,

suppose 300 ampere turns be required to provide the necessary field, then in the ammeter reading to a maximum of 100 amperes,

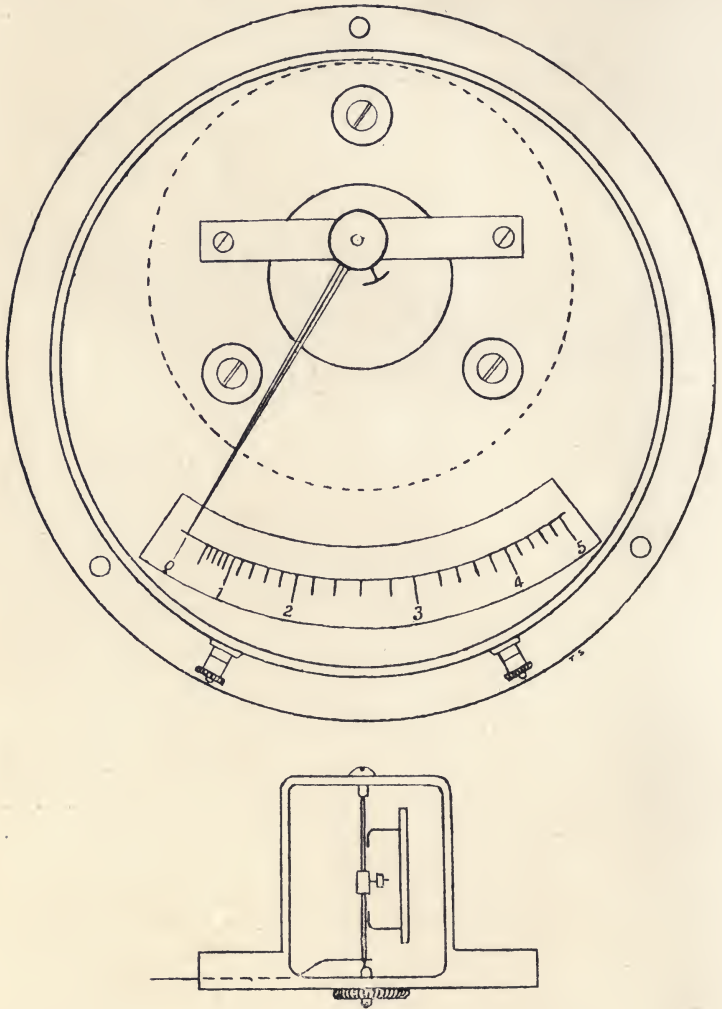

Fig. 44.

3 turns will be required on the coil, so that when a current of 100 amperes flows through it, we get the required 300 ampere turns.

In the voltmeter, reading to 100 volts, and having a resistance of say 5,000 ohms, the current that flows through it when indicating the maximum voltage will be $\frac{100}{5000} = .02$ ampere, and as we want 300 ampere turns we must provide 15,000 turns, and we can only do so by using extremely fine wire, which will have a high resistance, but that is just what we want, and therefore the high resistance of the instrument is best got by using very fine wire on the coil, instead of by adding a resistance in series with it, for with the latter we would not get the required ampere turns with so small a current in many cases.

We will now consider the construction of various types. Fig. 44 shows the details of an ammeter made by Messrs Crompton & Co., which can be used with direct or alternating currents, providing a separate scale is employed for each. The outer case is made of brass, and is pierced all round with holes to ventilate it. The coil *c* which is wound to suit the current to be measured, consists of a brass bobbin insulated from the case by ebonite collets and washers, and wound with insulated copper tape, the winding being in two sections side by side in opposite directions, the inside ends of the two sections being soldered to the bobbin, while the outer ends are connected to the terminals T_1 and T_2 , which are insulated from the outer case by ebonite collets. The currents to be measured flow through the two sections of the coil in similar directions, and create inside the coil a field proportional to the current. This field is strongest close to the wire, and falls off in intensity as we approach the centre.

Inside the coil a brass bridge piece is fixed near the top, carrying an arbor pivoted in jewel-ended screws. The arbor carries a small piece of iron which normally lies near the centre of the coil. It also carries the pointer and a small balance weight seen in the illustration.

When a current passes through the coil, the small piece of iron becomes magnetised, and being very thin, is saturated with a small number of ampere turns. The iron is now attracted to the strongest part of the field, that is, near to the side of the coil, but in so doing it rises against the force of gravity, and the upward pull of the magnetic field (which depends on the strength of the current) and the downward pull due to the action of gravity balance each other, and in this way the movement of the pointer indicates for us the strength of the current.

Of course all these instruments have to be calibrated, that is, known currents must be sent through them, and the movements of the pointer over a temporary scale noted, then after plotting a curve with the values obtained a new scale can be made and fixed.

The known currents may be measured with a voltameter vessel as described in Chapter VII. To do this we could take a silver voltameter with carefully weighed silver electrodes, and place this in series with the ammeter, having first affixed a temporary degrees scale. Now send a current through both from a few accumulator cells, noting the time the current lasts (in seconds), and also the reading of the ammeter. Next take out the cathode, wash it, dry it, and carefully reweigh it. The increase in weight in grams divided by the electro-chemical equivalent of silver = .00118 will give us the number of coulombs passed through the circuit, and this again divided by the time in seconds will tell us the current. The operation can now be repeated with various currents, measuring each in the way indicated, and noting the corresponding indications of the ammeter needle. These values when plotted in a curve give us the indications of the pointer for *even* values of the current, and the new scale can be constructed accordingly.

This instrument when completed could be used to put in series with others for calibrating purposes, in place of the voltameter vessel, and used as a standard, providing it is itself very accurately calibrated, and also providing it be checked frequently with the voltameter to see that it remains correct.

There are other methods of measuring the standardising currents. One involving the use of an instrument called the "potentiometer" is both very accurate and very quickly performed, and is a method commonly employed, but the description of this instrument and the method of using it for the measurement of current strength and e.m.f. will be treated in a subsequent chapter.

Fig. 45 shows an instrument made by the "Weston" Electric Instrument Company with the cover removed. A large permanent magnet of Ω shape is supported by a gun-metal casting screwed to the ends of the limbs, and the whole of the working part is built up on this magnet independent of the case, so that the movement can be removed bodily from the case by simply taking out one screw which holds the gun-metal casting in its place.

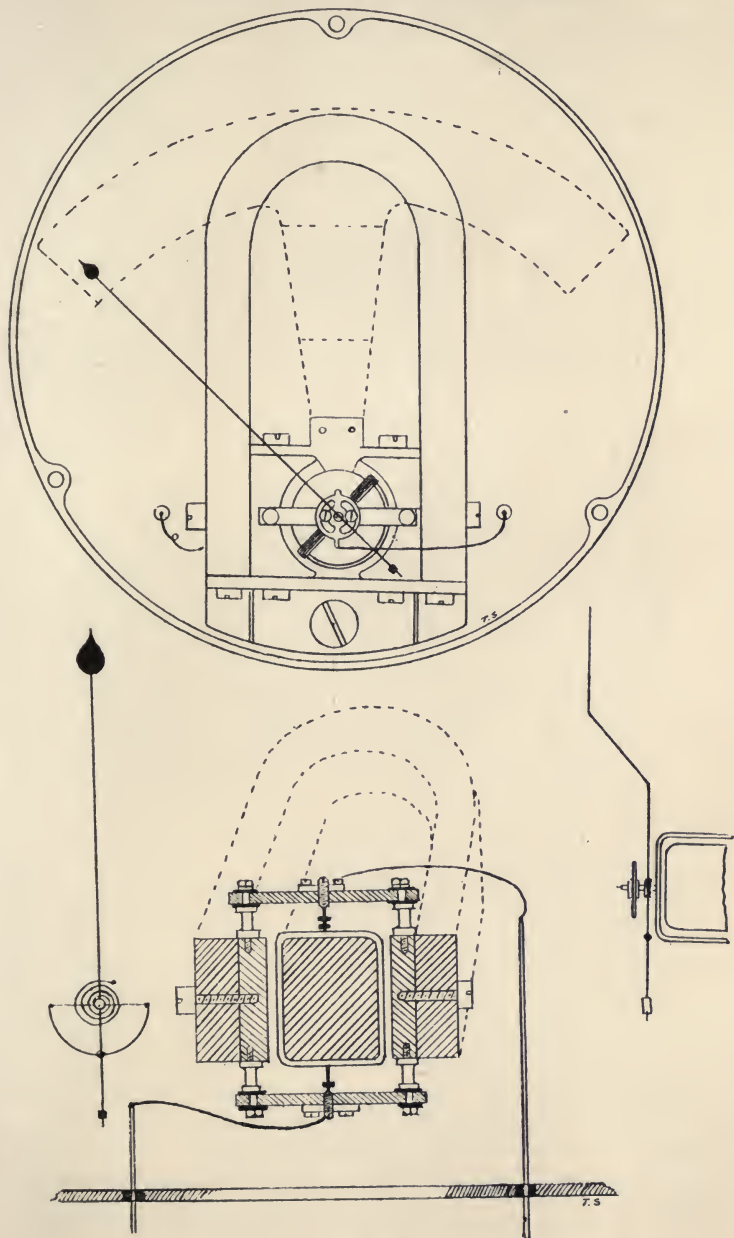

Fig. 45.

The inside polar faces of the magnet are surfaced up so as to come closely into contact with wrought-iron pole pieces which are bored out to about 1 in. diameter, and fixed rigidly in their place with screws passing through the limbs of the magnet. To these pole pieces a second gun-metal casting is screwed, which forms a support for a soft iron cylinder $\frac{3}{4}$ in. diameter inside the bored-out pole pieces, and also a support for the scale. The soft iron cylinder fills up most of the space between the pole pieces, allowing an air space at either side of $\frac{1}{8}$ in., and in this space a fairly strong, uniform, magnetic field exists. A coil of fine insulated copper wire of about twelve turns is wound on a thin brass frame, large enough to embrace the soft iron cylinder, with free-

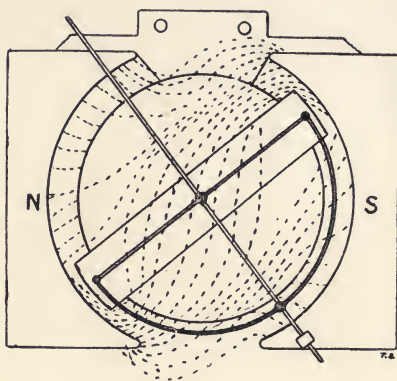

Fig. 46.

dom to move in the space between it and the pole pieces. This is pivoted in jewelled bearings which are screwed to the pole pieces, but insulated from them, forming little bridges across, and the ends of the coil are connected to these bridge pieces by spiral springs, one at the top and the other at the bottom of the coil, the springs being wound in opposite directions, so that when one is twisted up by a movement of the coil the other is untwisted. This arrangement corrects for any variation in temperature, for the effect on one spring would be counteracted by the opposite effect on the other. The coil normally lies at 45° to the line joining the poles of the magnet, and consequently the magnetic field created by a current in the coil will be displaced relatively to

the field of the horseshoe magnet as shown in Fig. 46, and the lines in tending to shorten themselves twist the coil through a certain angle against the reaction of the spiral springs, the angular movement of the coil depending on the strength of the current in the coil and the strength of the field in which it is placed.

To the coil is attached a pointer of aluminium, the whole being balanced so that the instrument can be read in any position, and

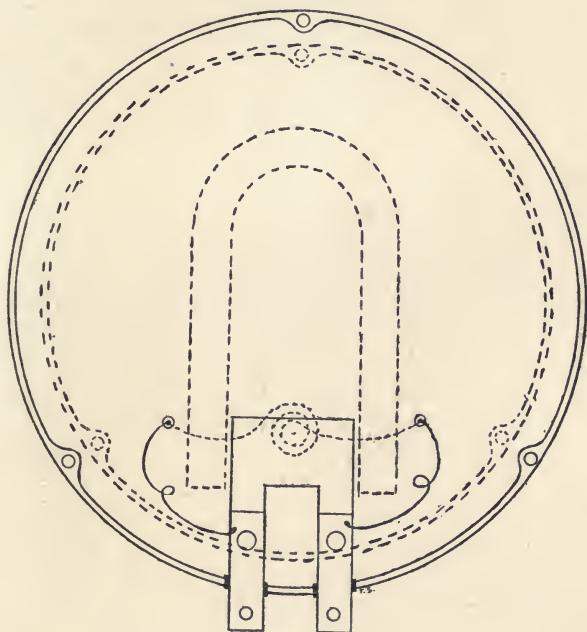

Fig. 47.

the pointer and scale are bent up so as to come near the front of the case.

In this instrument the whole current does not go through the coil, but only a small fraction of it. The main part of the current crosses from one terminal to the other by a broad strip of metal under the base of the instrument, while the coil is placed as a shunt across the terminals, or as a conductor in parallel with the metal strip (Fig. 47), and consequently the ratio of the currents in

the strip and in the coil will be inversely proportional to their resistances (see Chapter III.). Now with a given strength magnetic field due to the magnet, and a given elasticity of the spiral springs, it will require a certain number of ampere turns in the coil to produce the full deflection on the scale. This can be secured by adjusting the resistance of the strip connecting the terminals so that the same movement will do for any instrument. Thus, suppose the instrument were required to read to a maximum of 10 amperes, and we required 1 ampere in the coil to give the maximum deflection, then the resistance of the coil must be 9 times that of the strip, so that the current will divide at the terminals, $\frac{9}{10}$ going through the metal strip and $\frac{1}{10}$ through the coil. If the instrument is required to read to a maximum of 100 amperes, then the metal strip must have 99 times less resistance than the coil, and the current will then divide at the terminals, $\frac{99}{100}$ going through the strip and $\frac{1}{100}$ going through the coil, which will give a reading to the full range of the scale as before. By the arrangement of the pole pieces and wrought-iron cylinder the field due to the permanent magnet is practically uniform over the range of movement of the coil, and so the scale is proportional throughout. Should the permanent magnet vary in strength, the instrument would not read correctly, but the magnets are so treated that the falling off in strength over a number of years is inappreciable.

The voltmeter movement is exactly the same as that for the ammeter, but the terminals are not connected together with a metal strip. In this case the resistance of the instrument has to be as large as possible. A high resistance coil is therefore placed in series with the moving coil, and fixed under the base of the instrument, and the moving coil is wound with very fine wire, having therefore more turns than the ammeter coil. The extreme sensitiveness of these instruments is due to the moving coil being placed in the strong magnetic field of the permanent magnet, the torque or turning effort of the coil depending on the current, on the number of turns, and on the strength of the field, and as this field strength is large, the ampere turns can be made proportionally small. The brass coil frame moving in the field has currents induced in it which tend to stop the motion producing them. This makes the movement perfectly dead beat, the needle coming to rest almost immediately without any vibration whatever.

Fig. 48 shows another type of ammeter, whose indications depend on the heating effect of the electric current, commonly

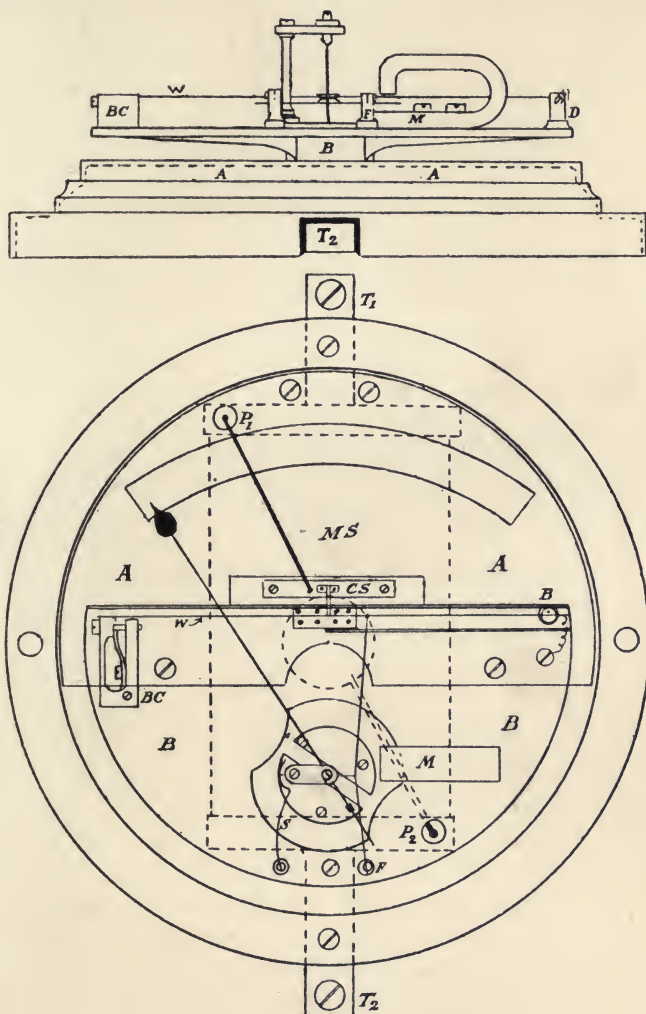

Fig. 48.

known as a hot wire instrument. Under a brass plate A two terminals T_1 T_2 are fixed, and insulated from it. These are joined

by a metal strip *MS*, seen in the illustration in broken lines. Two pins P_1 P_2 rise from opposite corners through holes in plate *A*, and P_1 is connected to an insulated copper strip *CS* fixed on the upper face of *A*. A second brass plate *B* is fixed about $\frac{1}{2}$ in. from *A*, and forms a little more than half a disc, so that it only partially covers *A*. Fixed to the left-hand side of *B* is an adjustable brass clamp *BC* to which one end of the wire *w* is attached, the other end being fixed to a small pillar *D*. This pillar is supported on a strip of ebonite which is rigidly fixed to *B* near the centre, but otherwise free from it, and the pillar is electrically connected to *B* by a wire. The copper strip *CS* is connected to wire *w* by means of a very fine spring curling over the edge of *B*, and making contact about half-way down. A little to the right of this a fine wire is attached, the other end of which is fixed to the insulated pillar *F*, and near the centre of this wire is attached a fine silk thread which passes round a pulley, pivoted in jewels, the other end of the silk thread being fixed to a steel spring *s*. The pivot carrying the pulley also carries an aluminium pointer and an aluminium disc the rim of which moves between the poles of a permanent steel magnet *M* fixed to *B*. A wire is connected from the plate *B* to P_2 .

When the terminals are joined to the circuit a large fraction of the current passes from one to the other across the metal strip *MS*, but a certain fraction passes from P_1 to *CS* through spring to wire *w*, dividing at this point to *BC* and to *D*, uniting again at the brass plate *B*. This shunt current can be made any fraction of the total by adjusting the resistance of the metal strip, as was explained in connection with the Weston ammeter. The current in flowing through the wire *w* heats it, the heat being proportional to the square of the current and to the resistance; the wire consequently expands, and the expansion is taken up by the steel spring *s*, which causes the pointer to move over the scale. The aluminium disc moving between the poles of the permanent steel magnet has eddy currents induced in it which tend to retard the motion which produces them; this brings the pointer to rest without vibration as in the Weston instruments.

The ebonite strip is to compensate for variation in temperature which otherwise would not give the same ratio of expansion of the wire *w* and brass plate B_1 . The ebonite contracts slightly when warmed, and by choosing the right length the tension on the

wire *w* is kept practically constant within certain variations of temperature. If the pointer does not point to zero at any time, it can be made to do so by turning the small screw at the side of *BC*, thus increasing or diminishing the tension on the wire *w*.

This instrument will do for either direct or alternating currents, and is unaffected by external magnetism. Its indications have a certain lag, for time must be given for the whole to reach its final temperature for any given current. Care must be taken in its use, for if too large a current be sent through it, the fine wire *w* will be fused. This of course is prevented by placing in its circuit a piece of fuse wire which will melt with a less current than would be required for fusing the wire *w*.

A well-known voltmeter working on this principle is illustrated in Fig. 49. It is known as the Cardew hot-wire voltmeter. Inside the circular brass box are fixed two pieces of vulcanised fibre VF_1 . The left-hand piece supports two spring clips on its face and two angle pieces of brass on its side. One clip is connected to the insulated terminal T_1 , while the second clip is connected to one of the brass angle pieces. Two german silver spiral springs are attached one to each of the brass angle pieces, and the other ends of the spiral springs are joined to very fine wires of platinum silver .0025 in. diameter. These two wires are connected together at the top by an insulated brass pin running through a four-armed brass casting carrying a pulley set in jewels at its upper end, this piece being screwed to the top of a tube 3 ft. in length, made of brass for two-thirds of its length and of

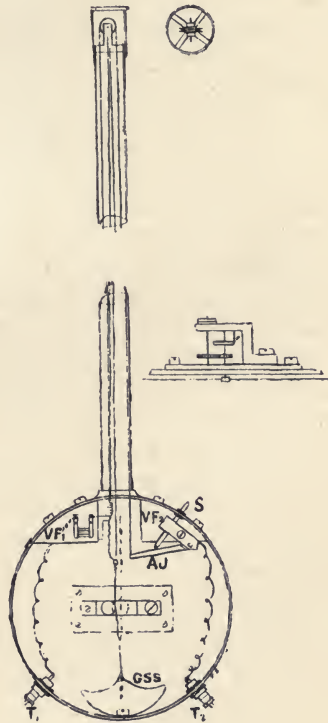

Fig. 49.

spiral springs are attached one to each of the brass angle pieces, and the other ends of the spiral springs are joined to very fine wires of platinum silver .0025 in. diameter. These two wires are connected together at the top by an insulated brass pin running through a four-armed brass casting carrying a pulley set in jewels at its upper end, this piece being screwed to the top of a tube 3 ft. in length, made of brass for two-thirds of its length and of

iron for the remaining length. A connection is made by a very fine flexible wire, from the last spiral spring to a third length of the fine platinum silver wire, which also runs up the tube, over the pulley at the top, and down again to the adjustable brass piece attached to the second vulcanised fibre block VF_2 . Thus all four wires in the tube are in series. A fine silk thread is attached to the free end of the third length of platinum silver wire, which is led round a pulley similar to that described in connection with the hot-wire ammeter, and the end is attached to a german silver spring GSS at the bottom of the circular box. The adjustable brass arm on VF_2 is connected to terminal T_2 , and the two clips on VF_1 are connected by a fuse wire that will melt with a smaller current than would be required for fusing the fine wires in the tube. The pointer in this case is not attached to the pivot carrying the pulley, but to a second one connected to the first with fine spur wheels, so that the movement of the pulley is multiplied up, and to prevent backlash due to any wearing of the teeth the one is pressed against the other with a fine hair-spring.

If now the terminals be connected to any two points at a difference of potential, a current flows from T_1 to fuse, and through the german silver spring up one length of wire, down another to the second spiral spring, then by the fine wire connection to the third length of wire over the pulley, down the fourth length of wire to the adjustable brass arm, and so to T_2 . The current in passing down the two first lengths of wire will heat them and cause expansion, which is taken up by the spiral springs at the bottom. There is also a similar expansion in the other two wires, and this is taken up by the german silver spring GSS at the bottom, and in so doing gives a twist to the pulley, and through the gear to the pointer.

This is calibrated to read in volts, and usually has a degree scale as well. To bring the pointer to the zero on the scale a screw s can be turned which presses against the adjustable arm AJ . This screw is insulated where it comes through the case. The tube is made of two metals in different proportions, so that the tube and wires may expand at the same rate with alterations in temperature. Two out of the four lengths of wire in the tube are put in simply to increase the resistance.

These instruments are found to work best with the tube in a horizontal position, for when vertical the heat from the lower

portions of the wire ascends to the top of the tube, and the upper part of the wires becomes much hotter than they should.

As a specimen of electro-static instrument we may take Lord Kelvin's electro-static voltmeter. These instruments are made in three distinct types, which cover a range from 40 to 100,000 volts. For the smaller values a multicellular arrangement is employed. Here 15 aluminium vanes, butterfly shaped, seen in Fig. 50, are all connected to a vertical spindle at a uniform distance apart. The lower end of the spindle carries a small metal disc which moves in a tube at the base of the instrument containing oil, and forms a very efficient damper. This spindle with the vanes attached is suspended from a support in connection with the outer metal case by a platinum-iridium wire, and a pointer formed of a piece of aluminium wire is rigidly attached to the spindle and lies in a horizontal plane, the end of the pointer being bent at right angles so as to lie over the scale which is fixed in front of the instrument.

Partially embracing the aluminium vanes are 15 sector-shaped boxes made of triangle-shaped brass plates, fixed horizontally to two brass plates at one edge. Two sets of these boxes are very carefully insulated from the case, and supported by it, so that the aluminium vanes are free to move between the sectors against the torsion of the platinum-iridium suspension, and the pair of sector-shaped boxes are connected together and to an insulated terminal on the containing metal case.

The spindle passes through two small guide holes to prevent the moving part from accidentally coming into contact with the fixed sectors, and two plates of insulating material prevent the vanes from swinging too far.

If now the case and therefore the suspended aluminium vanes be connected to one point in a circuit, and the fixed sectors to another point, they take opposite charges depending on the difference of potential between the two points to which they are connected and on the capacity of the instrument. Mutual attraction is thereby set up between the fixed sectors and the aluminium vanes in their endeavour to increase the capacity. The maximum capacity and therefore the maximum deflection is obtained when the aluminium vanes are completely covered by the brass sectors.

The quantity of electricity which goes to charge the brass sectors and aluminium vanes

$$= Q = VC,$$

where v is the difference of potential between them and c is the capacity. The force of attraction between them

$$= F = \frac{Q_1 \times Q_2}{d^2}$$

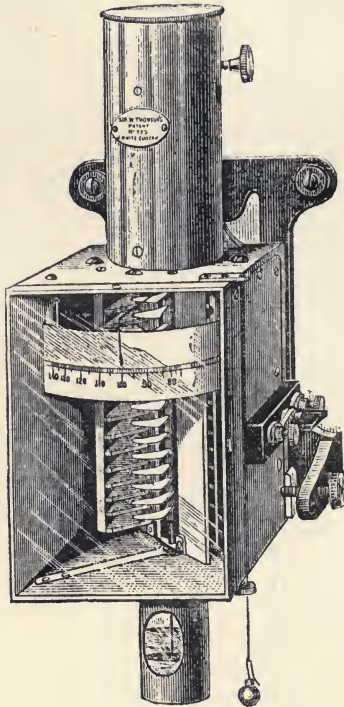

Fig. 50.

where Q_1 and Q_2 are the quantities of electricity on the sectors and vanes respectively, and d is the distance between them.

Suppose now we double v , then both Q_1 and Q_2 will double also. Therefore F will be four times as great as before, which gives rise to a movement of the aluminium vanes till the force of attraction is balanced by the force of torsion on the suspending wire. The

force of attraction is therefore proportional to the square of the potential difference.

The outward appearance of the instrument is shown in Fig. 50, and a diagrammatic view of the working parts in plan is given in Fig. 51.

For the higher values only two sector boxes are employed, and these are arranged in a vertical direction with the aluminium vane supported on knife edges from a horizontal support at the centre, the vane in this case being larger and slightly different in shape. At its lower end a small stirrup is provided on which small weights

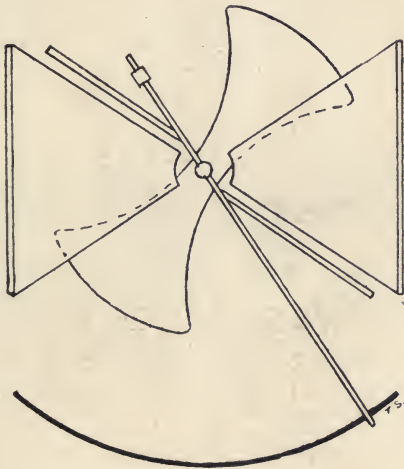

Fig. 51.

of aluminium wire can be hung. These weights increase the range of the instrument by increasing the controlling force, which in this case is due to gravity.

These instruments are arranged in metal cases which screen them from any electro-static disturbances from outside. They are equally accurate with alternating and direct currents, and absorb absolutely no power. They are also independent of changes in periodicity on an alternating current circuit.

The insulation resistance of electric-light wiring, street cables, dynamos, &c., where no great accuracy is required, is often

obtained by direct reading on an ohmmeter. This instrument, made by Messrs Evershed, consists of three coils, the axis of one being between and at right angles to the axis of the other two, as shown diagrammatically in Fig. 52. Inside the centre coil is a small astatic needle of iron magnetised by the current in the coils AB. To the spindle carrying the needle a pointer is attached which indicates on a graduated dial marked direct in ohms and megohms. The two coils A and B are of high resistance, and are connected in series, the ends being connected to two terminals on the top of the instrument *a* and *b*; *a* is also connected to the centre coil, the other end of which is connected to a third terminal *c*. A fourth terminal *d* is also

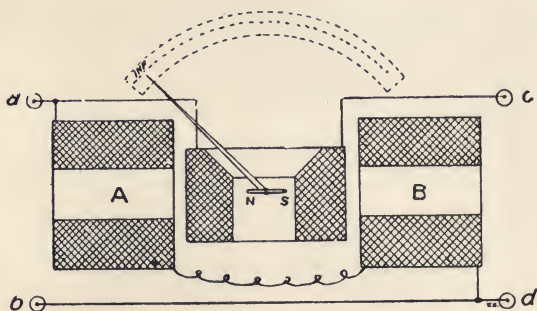

Fig. 52.

provided, which is connected to *b* by a wire under the cover of the instrument.

A small magneto-generator or hand dynamo, with permanent steel magnets, capable of developing an e.m.f. of from 100 to 1000 volts when driven at about 60 or 70 revolutions per minute, is provided with the ohmmeter, and when in use it is connected to terminals *a* and *b*, the + and - mains being connected to *c* and *d* with all lamps out and all switches on.

When the magneto-generator is run up to speed a current flows through coils A and B, creating a field along the axis of the coils, and so holding the needle in the same line. The pointer in this position points to infinity, for when the needle is in this position there can be no current in the coil C, and therefore the resistance of that circuit is infinitely great. But if *cd* be connected up to the

mains in the way described, a small current will flow through the insulation from one main to the other, the strength of which depends on the resistance of the insulation. If therefore we get a large movement of the needle, it follows that the current in c is larger than when the movement is less, and therefore the resistance between c and d is less. It is evident that we could calibrate the scale so that the pointer indicates by its movement the resistance between c and d starting from infinity. Variations in the e.m.f. due to variations in the speed of the magneto-generator do not affect the result, for it affects the deflecting force and controlling force to an equal degree.

This instrument is useful in workshops and places where a Wheatstone bridge is unworkable except by highly skilled operators, for it enables faults to be detected while the work is in progress by wholly unskilled workmen.

The magneto-generator employed should develop an e.m.f. at least equal to the working pressure of the dynamo, cable, &c., under test, and it is better to make the test under twice the normal working pressure if possible.

CHAPTER X.

ELECTRICITY SUPPLY METERS.

WE now turn to consider a different type of instrument, viz., the electricity supply meter. To the engineer it is a very important instrument, for on its accurate reading depends the return for the power supplied, and when it is remembered that many companies have not one but often several thousand meters connected to their mains, it is seen that unless they be accurate and reliable a very fair loss may arise in the annual returns. Of course the instrumental errors may be on the other side, and the meter, if inaccurate, may indicate too much; but this is almost as unsatisfactory to the engineer, for the consumer becomes dissatisfied, and is often sending complaints, especially when the bills are sent in, and he soon gets the idea that electricity is an expensive illuminant. For this reason the meter should be checked occasionally, but not too frequently, say once a year, or, if of a reliable and well-tried make, say once in three years.

In the early days of electrical engineering it was usual to charge so much per lamp per annum, but this soon proved unsatisfactory, for certain consumers required the power for much longer times than others, which made the cost very unequally divided, and led to very great waste of energy, for there was no incentive to turn off the supply when done with, and it was not till a fairly practical meter was invented that an electrical supply to the public became a commercial success.

The supply meter has to measure the power and also the time the power is used, that is, it must record the total work represented by the power consumed, for work done is equal to "power \times time." It has therefore to record the product of volts, amperes, and time in certain units that have been adopted by the Board of Trade. The unit is consequently known as the "Board of Trade" unit, and is equal to 1,000 volt ampere hours or 1,000 watt hours. Thus if we use a current of 10 amperes under a pressure of 100

volts for 1 hour, then we have consumed 1 Board of Trade unit, for which we must pay the price charged by the particular company from which we obtained the supply, this varying considerably according to locality.

Now a meter may be made to record Board of Trade units by simply integrating current and time, for the supply company are bound to keep the pressure practically constant, and therefore the ampere hours can be converted into watt hours by a constant multiplier, 100 or 200, as the case may be. But even this is unnecessary, for the meter can be calibrated and marked in Board of Trade units, which will then be correct for one particular voltage circuit but for no other. Thus, suppose the current be 10 amperes, and it be kept on for 1 hour, then if the supply be at 100 volts, the indication of the meter could be marked "one" Board of Trade unit. If now this same meter be connected to a 200 volt circuit, and 10 amperes again flow through it for 1 hour, it would still read *one* Board of Trade unit, whereas now it should read *two* units. Such meters, which take no account of differences in pressure, are known as ampere-hour meters, while those that indicate true power on any voltage circuit are called watt-hour meters.

Meters of all kinds can be divided into three groups—(1) Those intended for direct current circuits only; (2) those intended for alternating current circuits only; and (3) those intended to work on either direct or alternating current circuits.

A good meter should embody the following conditions—(1) Accuracy at all loads; (2) should start from rest with a very small current; (3) there should be no possibility of tampering with it; (4) it should be unaffected by external magnets, iron masses, and extreme differences of temperature; (5) it should consume very little power and cause no appreciable fall in the pressure; (6) it should be dust proof and damp proof; (7) must not be very expensive.

As already pointed out, the first of these conditions is of very great importance to the consumer and engineer alike. The second is of all importance to the engineer, and of no consequence to the consumer, for if (as was often the case with early forms) the consumer switched on one lamp, and the current taken by it was not sufficient to start the meter, he might keep it alight continuously, and be charged nothing for the power consumed. This in

a single case may not be a large item, but if there are several hundreds or thousands of such meters installed it becomes a very considerable item indeed.

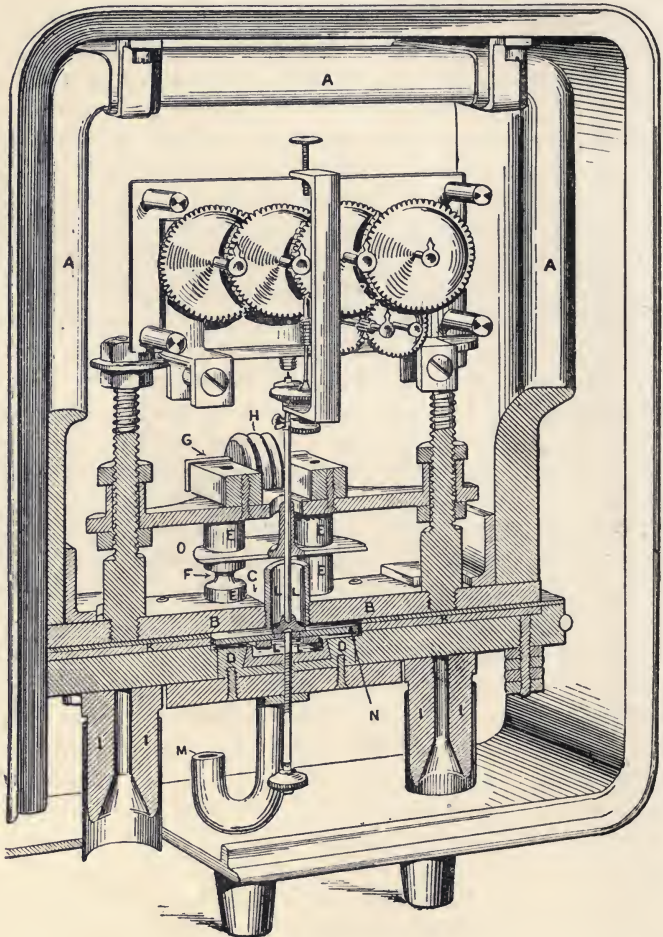

Fig. 53.

Some unscrupulous persons have been known to exercise their ingenuity in arranging a large magnet or piece of iron in such a position close to the meter as to greatly affect its true

indications, hence the importance of the third condition. The remaining conditions will be self-evident.

Let us now consider certain types, and see how far they

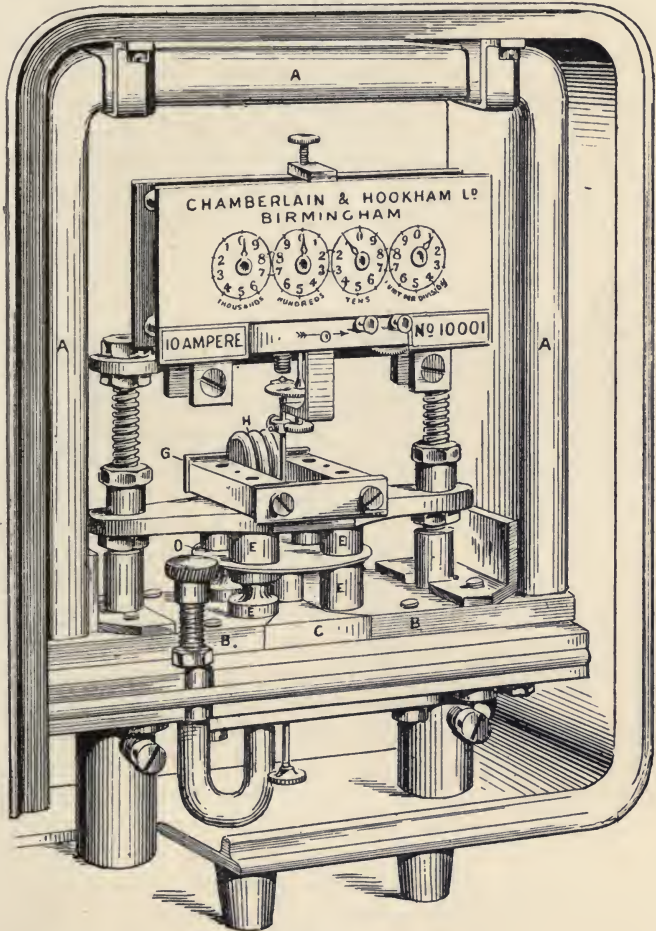

Fig. 54.

conform to the conditions laid down. We will start with a well-known instrument known as the "Chamberlain & Hookham" meter, considering only the latest form, which is shown in section

and elevation in Figs. 53, 54. Here a large permanent steel magnet *A* of \cap shape is supported from the top of the containing case, and the field is led from pole to pole, first by bars of iron *B* to a small chamber *L* containing mercury and a thin disc of copper having radial cuts and insulated all over except at the edge. This copper disc *N* is mounted on a fine spindle which is provided at its lower end with a jewelled bearing. The magnetic field being led to this box, passes in part across it at right angles, and in part across a small space above it, in which a second small disc *O* of aluminium, fixed to the same spindle as carries the lower disc, is free to rotate. The iron pillars *E* conducting the field across this upper space, four in number, are turned down at *F* so that the iron at this part shall be magnetically saturated. The piece of iron *G* having a few turns of thick wire wound on it completes the magnetic circuit from one side to the other.

The magnetic circuit is thus seen to be in parallel, part passing through one half of the lower box in one direction and then through the other half in the opposite direction, while another part of the field passes up through one half of the aluminium disc in one direction and down through the other half in the opposite direction, and so both parts completing their circuit to the other pole by the second iron bar. This is shown diagrammatically in Fig. 55. The small disc of copper in the mercury chamber is faced with vulcanised fibre, and is so adjusted with regard to its weight that it just floats in the mercury when at rest. In future we shall refer

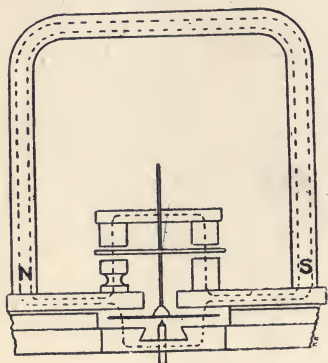

Fig. 55.

to this piece as the armature. The upper disc of aluminium forms a very excellent brake or retarding force which varies with the speed. This is due to the currents which are induced in the disc by its movement in the ununiform magnetic field. The currents so induced, according to Lenz's law, oppose the motion producing them, and consequently the disc experiences a force tending to drive it in the contrary direction to that which gives rise to it.

The current to be metered enters by one terminal ι at the bottom and passes by a strip of copper κ to the mercury chamber. This strip is insulated everywhere except at the edge forming part of the inside wall of the mercury chamber. A second similar strip leads the current to the second terminal. The current therefore flows across the mercury and copper armature at right angles to the direction of the magnetic field. Owing to the deep radial slits in the copper armature the current flows in it across a diameter.

Considering only one half of this armature, there will be a force developed in that half when a current flows tending to urge it at right angles to the direction of the field, the force in dynes being equal to $\frac{HCl}{10}$ (see page 67). Now the same current flows in the other half of the armature, and if the field was in the same direction there would be an equal force on this half tending to urge it in the same direction, and consequently the armature would not move whatever strength current be employed. But as we have seen, the field in the second half is in the opposite direction to that in the first half, and consequently that half of the armature is urged in a contrary direction. Viewed from the top, we can imagine the one half to be urged from left to right, then the second half would be urged from right to left, which is the direction required to make the armature rotate.

This being an ampere-hour meter, the speed of the armature must be proportional to the current strength, for the revolutions of the armature are recorded on a train of dials calibrated in Board of Trade units, and therefore any increase in the current, and so in the power absorbed, must (while it lasts) be recorded by an increase in the armature speed in proportion to the increased rate of power consumption.

Now the driving torque on the armature is proportional to (1) the intensity of the field; (2) the length of the conductor carrying the current in the field; and (3) the strength of the current. (1) and (2) are fixed, and therefore the driving torque is proportional to the strength of the current.

If there were no retarding forces, the smallest possible current would set the armature rotating, and it would soon get up to a high speed, and we would get no measure of the power consumed. But there are several retarding forces, viz., friction at the bearings

and train of wheels, friction between the mercury and walls of the mercury chamber, and air friction, all of which must be compensated for. Then we have the retarding force due to the eddy currents induced in the brake disc which is proportional to the speed. If therefore the other retarding forces are properly compensated for, the speed of the armature will, owing to the brake, be proportional to the current.

The upper end of the armature spindle is furnished with a pinion gearing into a wheel, and the spindle which carries this wheel is also furnished with a worm which gears into the first wheel of the train. The armature spindle is provided at its upper extremity with a very fine pivot which when at rest presses very lightly against a fine jewelled bearing, owing to the armature floating in the mercury. The friction at the bearings would of course be relatively very great at light load, for then the driving force is very small, but at such times the armature is practically floating. At heavier loads, when the armature runs faster, owing to the increased driving torque, the friction is relatively far less important, and owing to the centrifugal action of the mercury, the armature falls on to the lower stronger bearing, and so saves the wear which would otherwise come on the more delicate upper bearing.

The fluid friction is compensated for by winding three or four turns on the iron yoke above the brake disc and leading the current round in a direction tending to reverse the field. At light load, when the friction of the air and mercury is very small, and therefore unimportant, the ampere turns provided are not sufficient to affect the brake field, but as the load increases, and with it the speed of the mercury and armature, the demagnetising influence of this coil begins to weaken the brake field, and cause more lines to cross the armature. Thus the retarding force is slightly lowered and the driving force slightly raised by its action, which can be arranged to completely compensate for the extra friction at higher speeds.

Should the large steel magnet fall off in strength, it would affect both the armature and the brake field, but not in the same way, otherwise the variation in the strength of the magnet would not affect the accuracy of the meter. But an alteration in the strength of the armature field alters the driving torque in the same proportion, whereas the same alteration in the brake field

would cause the brake action to vary proportional to the square of the field, for the power developed in the brake depends on the product of the e.m.f. developed in it and the induced current flowing under this e.m.f., both of which would vary with a given speed if the field strength varied.

This is prevented to a large degree by turning down the lower pillars carrying the brake field, so that, being practically saturated, the field strength at these parts and therefore across the brake disc does not alter in proportion to the alteration in the strength of the magnet, and by so adjusting the amount turned down the accuracy of the meter for a fairly large change in the strength of the magnet is not materially affected.

The length of the air-space in which the brake disc rotates can be adjusted by means of the nuts which clamp the upper pole pieces in position. The bolts on which these clamping nuts screw also carry the train of wheels rigidly fixed at their upper ends.

All meters of this make have the same gearing, and therefore each meter must make the same number of revolutions for one Board of Trade unit. In adjusting a number of them to read correctly, they would all be connected in series, and the same current sent through them, then all ought to be running at the same rate, and by putting a mark on each brake disc the number of revolutions per minute of each can be easily measured. According to the ratio of the gearing employed, the armatures must make a certain definite number of revolutions for one Board of Trade unit, say 3,000, and if the current be say 10 amperes at 100 volts, then the armatures must rotate $\frac{3000}{60} = 50$ revolutions per minute.

Or again, if the current be say 20 amperes at 100 volts = 2000 watts, then this must be kept on for half an hour to consume one Board of Trade unit, and therefore in half an hour the armature must have made 3,000 revolutions, or $\frac{3000}{30} = 100$ per minute.

Suppose one of the meters is found to be running too slow, then it can be made to run faster by increasing the length of the air-gap in the brake field, or it may be shortened if the meter is running too fast.

But when it is adjusted to run correctly at one particular load, it does not follow that it will run correctly at all loads, this de-

pending on whether the variable sources of friction, &c., have been altogether compensated at all loads. This is very difficult to accomplish, and is seldom met with in practice.

Fig. 56 shows a typical curve of constant for a meter which will serve for illustration. If the meter is accurate throughout, we get a straight line for the constant. But here the curved line of constant shows that at light loads the meter runs too slow, owing to the unbalanced friction, which is relatively great at light loads. At about 4 amperes the meter is reading correctly, for there the driving torque has so increased as to render the solid friction negligible. Beyond this part the meter runs slightly too

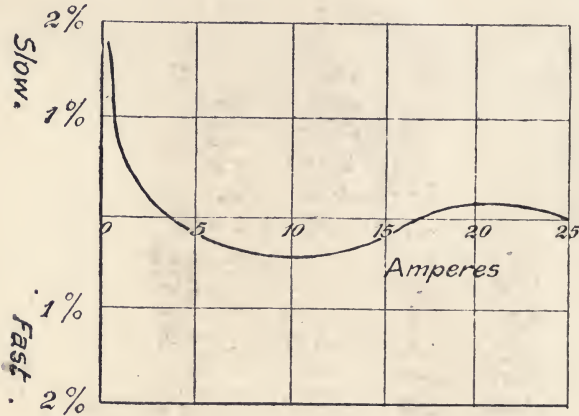

Fig. 56.

fast, owing to over-compensating for fluid friction, which has been found necessary for the higher loads. At about 16 amperes the meter reads correctly once more, while beyond that the readings are again too low, for at the higher loads the fluid friction is relatively much greater, and if completely compensated for at these loads would considerably overdo it for intermediate values. The variation in the constant must be kept within 2 per cent. either way, for that is the limit set by the Board of Trade.

We will now consider another type, known as the "Thomson-Houston" meter (Fig. 57). This is a watt-hour meter, and will serve equally well for either direct or alternating currents. It

approximates more nearly to an ordinary electric motor than the "Chamberlain & Hookham," as will be seen from an inspection of the diagram given in Fig. 58.

An armature Λ is built up on a spindle s without any iron in its construction, the frame consisting of thin cardboard or ebonite, octagonal in section, wound over with fine wire, joined in a series of coils, and the beginning of one coil and the end of the next are connected together, and also joined to one part of a small silver commutator at one end of the armature. This is mounted in a vertical position, and the lower end of the armature spindle rests

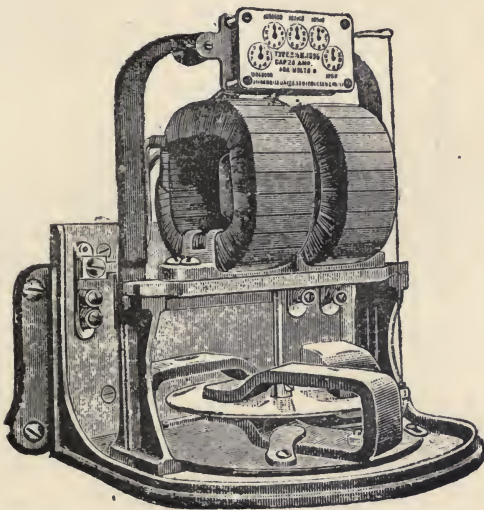

Fig. 57.

on a special jewelled bearing P . Fine silver brushes press lightly on the commutator, and lead the current into and out of the armature, these brushes being insulated and fixed to the back of the instrument.

Embracing the armature are the two thick wire coils c clearly seen in the diagram which carry the main current, and these are fixed on a small bracket of gun-metal projecting from the case. When a current flows in the coils a magnetic field is created through the space occupied by the armature, the strength of the field being proportional to the current flowing in the coils.

The armature is connected through a high resistance R (about 3,000 ohms wound non-inductively, *i.e.*, to produce no magnetic effect, placed at the back of the instrument) to the mains, and therefore carries but a small current which is directly proportional to the potential difference of the mains. This current flows continuously, whether there be a current in the main coils or not.

When a current flows in the field coils, and we get the field established across the armature, the armature conductors carrying the shunt current tend to rotate. In fact, we have in miniature

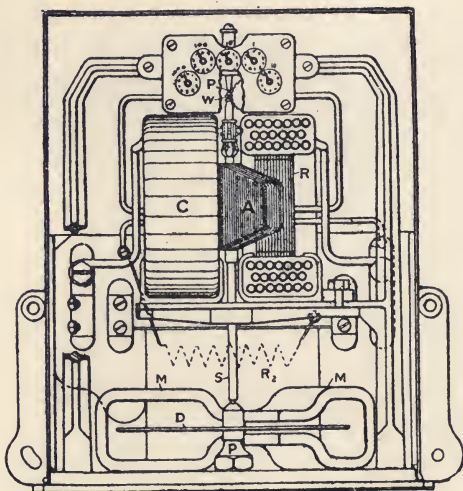

Fig. 58.

every essential found in the ordinary electric motor, but iron is not employed in any part of its construction.

The torque or turning effort depends on (1) the current in the armature conductors; (2) the length of the conductors carrying the current; and (3) on the strength of the magnetic field in which the armature rotates. The current in the armature is proportional to the p.d. of the mains, and varies with it. The strength of the field in which the armature rotates depends on the strength of the current in the field coils, and varies with it, and the length of the armature conductors is fixed once the instrument is wound. Therefore the driving force depends only on the strength of the

current and the p.d., and is proportional to the product of the two, that is, proportional to the watts.

The retarding force or brake, which makes the revolutions of the armature proportional to the power, is produced, as in the "Chamberlain & Hookham," by eddy currents induced in a small aluminium disc D attached to the lower end of the armature spindle, as it rotates between the poles of two or three permanent steel magnets M , which have been specially treated to ensure permanency.

There is a certain amount of friction to be compensated for in the bearings and counting train, in the brushes, and in air friction which is accomplished by placing inside the field coils other coils R wound with fine wire, and connected in the armature or shunt circuit. As this armature current flows continuously, there will always be a certain small field across the armature, the strength of which can be adjusted within certain limits by bringing the coils nearer to or further from the armature. Evidently, then, we can so adjust the position of these coils that the armature is on the point of running without there being any current in the main coils, so that on switching on the smallest current desirable the meter would start off.

But we cannot compensate to such a degree, for if the meter had a slight vibration, or the e.m.f. should rise ever so little, the meter would start running, though there be no current in the main coils, and it would also tend to keep running for some time after the load is switched off, which is technically known as "running on the shunt." The instrument has therefore a rather high starting current, and there is a loss of power in the shunt circuit common to all watt-hour meters. Suppose the resistance of the shunt circuit to be say 3,000 ohms, then the current through it is equal to $\frac{1000}{3000} = \frac{1}{3}$ ampere, which at 100 volts means a loss of $100 \times \frac{1}{3} = 3.3$ watts continuously, or nearly 29 Board of Trade units in the year. It has, however, several advantages. The one instrument will serve for a great variety of work, and measures true power on either alternating or direct current circuits. The variation is constant over most of the range is small, and does not appreciably vary with changes in the declared pressure within 10 per cent. either way.

Another type of instrument is now used very extensively, known as the "Aron" meter. In its earliest form it consisted of two clocks placed side by side in a case, and adjusted to run

synchronously. One of the clocks was furnished with an ordinary pendulum of brass, the other carried a magnet at its lower end arranged so as to swing freely over a coil of thick copper wire. If the coil had no current flowing in it, the magnet pendulum would be uninfluenced, and the two clocks would run at equal rates. If, however, a current be sent through the coil, the magnet pendulum runs faster than the other, for when the magnet is carried past the coil at either end the magnetic field due to the current in the coil

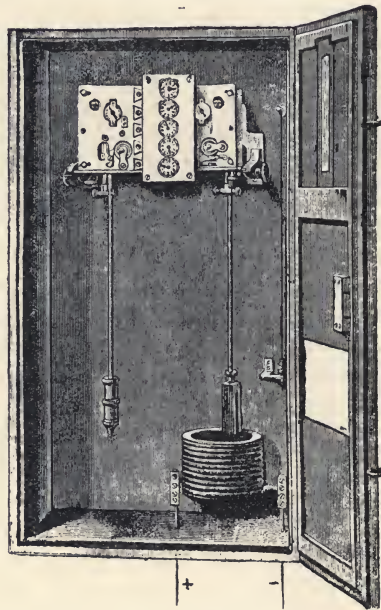

Fig. 59.

tends to draw it back, giving the effect of a shorter pendulum, and the difference in the rate of the two clocks can thus be made a measure of the ampere hours.

The meter so made had several serious drawbacks. It was very difficult to so adjust the two clocks that they would run for any length of time synchronously; then the two clocks required winding up very frequently. The pendulums being long, it was necessary to disconnect them before the meter could be sent by

rail, and therefore the instrument could not be sealed by the maker. Again, the consumer could not read the meter for himself, for the difference in the rate of the two clocks had to be multiplied by a constant to convert the readings into proper units. It was also not uncommon to find one or both of the clocks stopped for some unknown reason. Then again the meters would only serve for direct currents, and they were ampere-hour meters and not watt meters.

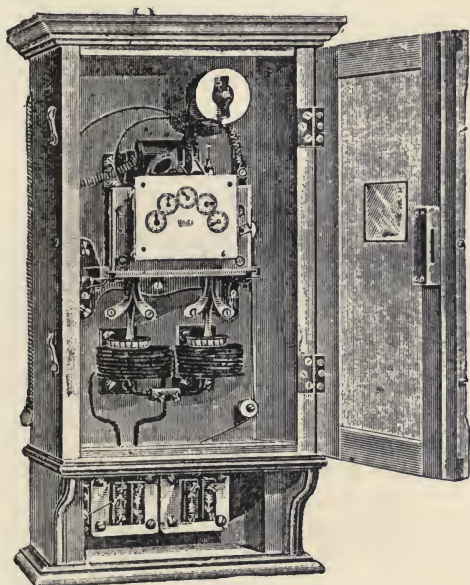

Fig. 60.

A very great improvement was made later by connecting the two clocks with a differential gear, so that only the *difference* in the rate of the two clocks was registered on a single set of dials (see Fig. 59), and a further improvement was effected by replacing the magnet with a coil of fine wire in series with a high resistance, connected as a shunt across the mains. This coil, wound on a wooden rod, created a magnetic field proportional to the pressure, converting the meter into one registering watt hours, and making it suitable for either direct or alternating currents.

Quite recently, however, the inventor (Dr Aron) has brought forward a pattern which appears to have eliminated all the drawbacks enumerated above, the instrument being highly sensitive and very accurate. It automatically winds itself up the moment an e.m.f. is applied to its terminals, one winding mechanism serving for both clocks. The pendulums are very much shorter than formerly, and are rigidly connected to their spindles, which allows of the instrument being sealed before leaving the maker. Any want of synchronism is automatically adjusted, making the clocks almost independent of any initial adjustment. The clocks start off without having to start the pendulums or in any other way interfere with the instrument (see Fig. 60).

The differential driving gear which transmits the power to the two clocks in such a way as to allow of independent motion will

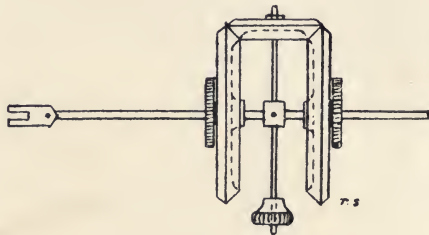

Fig. 61.

be best understood from a study of Fig. 61. The horizontal spindle is connected to the driving spring, and passes freely through the centre of the two crown wheels. At a point between the two crown wheels it is rigidly attached to a second spindle at right angles, on the top of which is placed a planet wheel, free to rotate on the spindle, but which engages into the two crown wheels. If now the horizontal spindle be rotated by the spring, the motion will be transmitted to the crown wheels through the planet wheel, which will remain stationary on its spindle, and the two crown wheels will be urged round with equal force. Each crown wheel is the first of a train of clockwork, and consequently both sets of clockwork will be set in motion with equal force.

But suppose one crown wheel has to overcome a greater friction than the other, or is retarded in any way, it will not affect the

driving of the other clock, for the planet wheel would continue to drive both with equal force by rolling on the slower moving crown wheel, and by so doing would drive the other at a faster rate, thus emphasising the difference in the rate of movement. Should one crown wheel be held fixed, then the planet wheel rolling on this would drive the other at twice the original speed, which is one point in making its indications very sensitive. A view of the arrangement is given in Fig. 62.

Each pendulum carries at its lower end a coil of wire m , and the two coils are connected in series with each other, and with a coil of wire fixed inside the case and wound non-inductively, which forms the shunt circuit of the instrument. Any difference in the rate of the two clocks is due to the pendulums being *both* influenced by the current in the main coils which are placed one under each pendulum, connected up so that the current flows through them in opposite directions. Both pendulums are thus influenced, that is to say, if the current would cause one clock to run fast, it would also cause the other to run slow, which further increases the sensitiveness of the instrument.

At the other end of each train of clockwork a second crown wheel is fixed, exactly similar to the driving crown wheel mentioned above, but made rather lighter, and the two crown wheels are connected through a planet wheel, also exactly similar to the driving planet wheel, and now the action is reversed ;

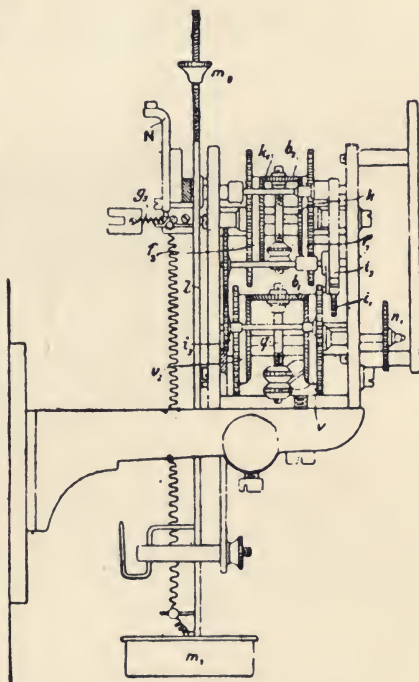

Fig. 62.

the crown wheels drive the planet wheel. But as the two sets of clockwork are driven in the same direction, and as the *recording* differential gear has to show the *difference* in the speed of the two clocks, it is necessary that the crown wheels should move in opposite directions, consequently one set of clockwork has a small change wheel i_3 (Fig. 66), interposed in its gearing, so that the recording crown wheels move in opposite directions. The spindle carrying the recording planet wheel is connected to the first wheel in the recording train, and its revolutions in any given time thereby recorded.

If now both clocks be running at equal rates, the axle carrying the planet wheel would not move, the wheel simply rolling on the two crown wheels. Should, however, one clock run faster

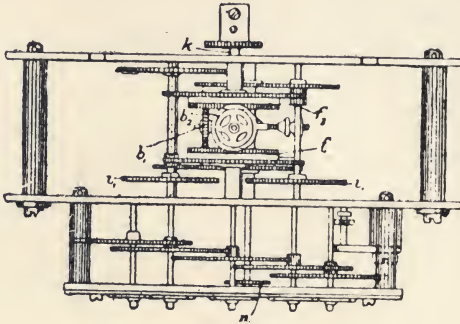

Fig. 63.

than the other, the planet wheel will revolve slowly on its spindle, and will be carried forward by the faster moving crown wheel, with a speed proportional to the *difference* in the speed of the two crown wheels, and consequently this difference in the rate of the two clocks is transmitted to the recording train of wheels.

It would of course be extremely difficult to adjust the clocks so as to run synchronously for long periods, but this difficulty has been entirely overcome by a very ingenious device shown in Figs. 64-67.

Once every twenty minutes the clockwork winds up a small spiral spring l which at the end of its travel is suddenly released by a locking lever r being raised, and the spindle connected to the

spring is suddenly turned through 360° . This is geared through s, t , to a second spindle carrying a commutator which is turned by it through 180° . The commutator is connected to the fine wire coils on the pendulum, and the current is led into and out of them by brushes pressing on the commutator, consequently when the commutator is thrown over in the way described the current in the swinging coils will be reversed. This of course would reverse the recording of the dials, but the record is made continuous by means of a small eccentric a on the end of the commutator spindle throwing over a lever b (Fig. 67), which slides a reversing

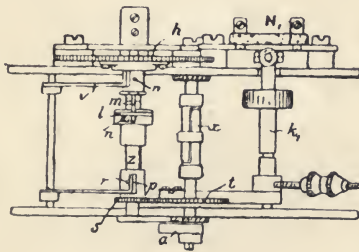

Fig. 64.

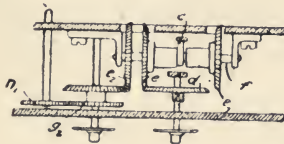

Fig. 65.

bevel wheel e into the recording train at the same time that the current is reversed in the swinging coils by the reversal of the commutator.

Now suppose the two clocks be out of synchronism, then in the first twenty minutes the record would be too large, but in the next twenty minutes it would be as much too little, and so the error would be cancelled.

The electrical winding mechanism is interesting. It consists of a small electro-magnet, having shaped pole pieces as shown in a , Fig. 68. An armature b inside the pole pieces is capable of being

moved through a small angle under the action of the electro-magnet when excited. Inside the armature is placed a small clock spring which is wound up due to the pull on the armature by the electro-magnet once every twenty or thirty seconds, and by means of a ratchet wheel *h* and pawl *f* is made to drive the clocks in recoiling. It is to this spring that the spindle of the driving planet wheel is connected by a detachable connection *c*. Attached

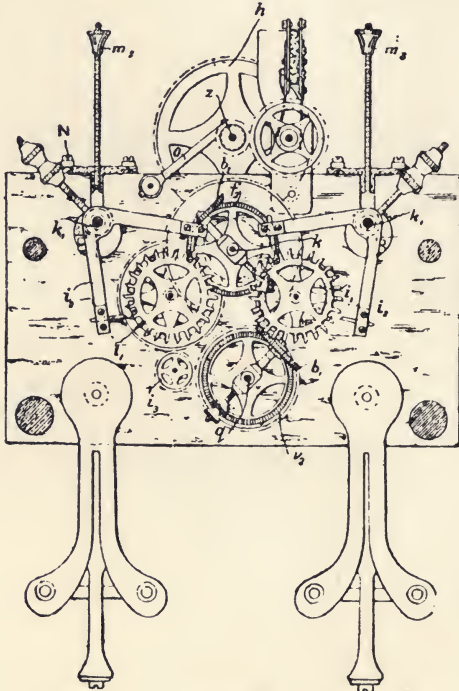

Fig. 66.

to the armature is a contact *x*, which forms a connection to the electro-magnet coil *q*. This contact engages with a small throw-over switch *e*, the position of which is partly controlled by a spiral spring which makes it rest on either one side or the other of a given centre line. As the clock runs down the armature slowly revolves away from the pole pieces, and the contact presses against an insulated spring *k* on the throw-over switch carrying it along.

At a certain point in the journey the throw-over switch has got past the centre, and the spiral spring suddenly pulls it over, so making connection with the contact *l* on the armature and exciting the magnet. The armature is thus drawn over, and with it the throw-over switch, till it reaches the point where the spiral spring causes it to fly over and break the electro-magnet circuit, when the whole operation is again repeated.

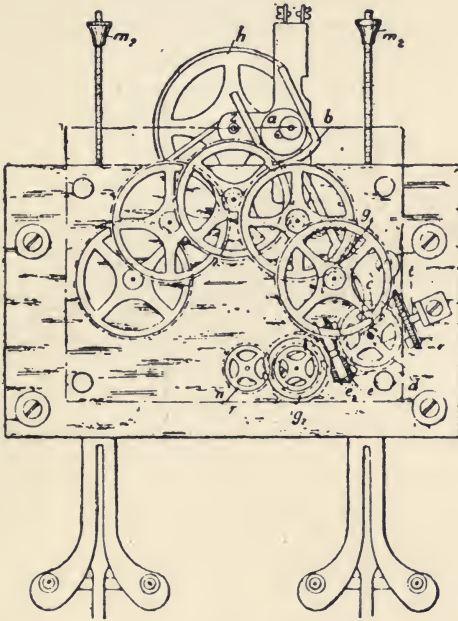

Fig. 67.

A close study of the several illustrations (taken from the *Electrical Engineer*) will give the student a fairly good idea of the instrument as a whole, the mechanism and the ingenuity displayed being very interesting.

Another instrument deserving of special mention is that designed by Mr Evershed. In principle it is similar to the "Thomson-Houston," but instead of a single armature it is provided with two in series, wound in opposite directions. This

makes it astatic, so that any external influence tending to make one armature run fast would affect the other in the opposite sense. The bottom pivot is set in a jewelled bearing, while the remainder of the armature spindle is perfectly free, floating in the air, and kept in an upright position by the pull of a magnet placed above it, which also takes most of the weight off the bottom bearing.

The commutator segments consist of a number of vertical platinum-iridium wires, fixed at their upper ends and free for the remainder of their length, and the brushes are replaced by two delicately pivoted wheels with platinum rims, which revolve by

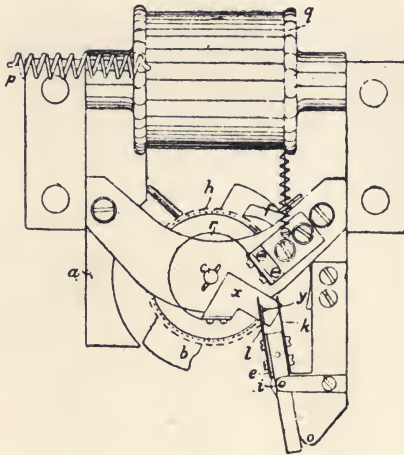

Fig. 68.

engaging with the wire commutator segments, thus overcoming the friction of the brushes, a point of great importance in meters of this type.

The friction of the counting train of wheels is entirely eliminated by a most ingenious device. A small coil fixed to the spindle above the armatures is connected in one of the armature circuits, while a similar coil below it is connected to the second armature circuit. These coils are embraced by the end of a magnetised lever which turns the counting train by means of a ratchet and pawl. Now the current in the armature conductors of all dynamos and motors of this type reverses once in each revolu-

tion, so the current in these coils, and therefore the magnetic field created by them, reverses at every revolution of the armature. The consequence is that the magnetised lever is urged up and down magnetically, in step with the armature as it rotates, and thus drives the counting train without being in any way connected mechanically with the rotating armature. The brake is here provided by eddy currents induced in an aluminium dish-shaped piece revolving between the poles of permanent steel magnets. The great improvements in constructional detail and the extraordinary small amount of friction makes the instrument exceedingly accurate at all loads, and practically no compensation is required. It is an ideal instrument to use as a standard for checking others by, and already a certain number have been purchased for this purpose.

Before leaving the subject of meters, the question of "maximum demand indicators" may be considered. To illustrate the principle, we can imagine two consumers, A and B, each taking 50 units in the same time, A's 50 units being made up of 250 amperes at 100 volts for two hours, while B's 50 units are made up of 25 amperes at 100 volts for twenty hours. In such a case, plant to the extent of 40 h.p. has to be provided in the station to meet A's requirements, while only 4 h.p. is required to supply B. Again A's 40 h.p. is only in use for two hours, while for the remainder of the time it is standing idle. Again, the mains in the street have to be ten times heavier for A than for B.

Now the expenditure in running an electricity supply station is made up under the following heads—(1) Interest on the capital invested; (2) sinking fund; (3) depreciation on plant; (4) management expenses; (5) rent, rates, and taxes; (6) salaries; (7) repairs and maintenance; (8) fuel; (9) oil and stores. The first seven items are called standing charges, for they are the same whatever the load may be, while the last two items vary with the load. But in a modern fully developed station these two last items will not cost more than $\frac{1}{2}$ d. per unit. If now power be required for say one hour per day only, then that hour's supply must pay all the standing charges for the remainder of the twenty-four hours, and consequently the price of the Board of Trade unit will have to be high, while if the power is required for say ten or twelve hours per day, the standing charges will be no more than before, and there will be only the small extra expense for fuel, oil, and stores.

We see therefore that to the engineer the consumer with a large demand for perhaps only half an hour per day is not nearly so good as one who, though perhaps using a much smaller amount of power, requires it for a much greater percentage of the twenty-four hours. It also explains why the supply company will often contract to supply power at a greatly reduced rate to those who can make use of it for long periods, when the plant and mains would otherwise be unloaded, to those for instance who can use the power for driving machinery, or for heating and cooking, or electrolytic work, or in any way take their power in the daytime, and finish before the lighting load comes on, so leaving the machines and mains free to meet the lighting load in the evening. In such a case the whole plant would be loaded for a much longer time, and the standing charges would be distributed over many more working hours.

The indicator which differentiates between good and bad consumers is fixed either in the meter case or close to it. In the case of the "Thomson-Houston" meter and one or two others it is made part of the meter itself.

This modification in the case of the "Thomson-Houston," devised by Messrs Barker & Ewing, consists of suspending the brake magnets from a bracket instead of fixing them to the base plate, the axis of suspension being parallel to the axis of the meter armature. The magnets are therefore free to rotate against the control of a stiff spring through a small angle. Now when a load is switched on there is, as we have already seen, currents induced in the aluminium brake disc which tend to oppose the motion producing them, consequently these currents exercise an attractive influence on the magnets, tending to drag them round in the direction of rotation of the disc, and so prevent lines of force being cut by the disc. The magnets consequently move round slightly, the amount of displacement being proportional to the load on the meter. The small movement of the brake magnets is magnified by a long pointer, the upper end of which indicates on a scale about $2\frac{1}{2}$ in. long directly below the recording dials. A catch is provided which holds the pointer in its position of maximum reading, and while permitting of a further movement should a greater load be switched on, prevents it from moving in the opposite direction. Thus the maximum load taken since the last reading of the meter is seen at a glance.

The cover is provided with a lever which releases the catch, so that the demand indicator can be reset at any time from the outside, and the lever is arranged to be sealed by the supply company's servants every time it is reset.

If desired, the catch may be held off, and the pointer is then free to move in either direction. Its indications then give power being absorbed at any moment.

If the indicator shows a high reading while the meter shows a small amount of power consumed, we have a consumer typified by A above; whereas if the indicator shows a small maximum value while the meter reads a large amount of power consumed, we have a consumer such as represented by B. Consequently the reading of the meter together with the reading of the maximum demand indicator gives us all the information required as to the value of the consumer from the engineer's point of view, and he makes a reduction in the price of the Board of Trade unit accordingly. The higher the reading of the meter and the lower the reading of the demand indicator, the less the cost to him of the power supplied, and it seems only fair to share this with his customer.

This method of charging has in certain instances been found to cause very considerable dissatisfaction, for it often seems well nigh impossible to explain to certain consumers why they have to pay say sixpence per unit while their next-door neighbour was only charged say fourpence. For this reason many engineers prefer a uniform charge, in which case the good consumer helps to pay for the bad one.

As an example of a separate demand indicator, we may take one of the earliest, if not the earliest, as illustration, known as "Wright's" maximum demand indicator, a diagram of which is given in Fig. 69.

It consists of a glass U tube with a cylindrical bulb blown on the top of one limb, the other limb being furnished with a fall

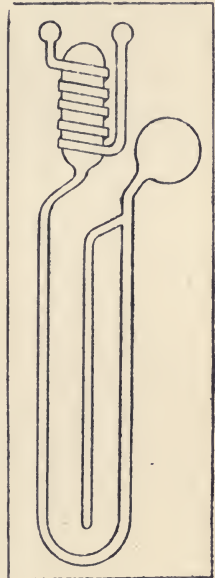

Fig. 69.

tube connected near the top, and a bulb on the end. A thick copper conductor is wrapped a few times round the cylindrical bulb, and the whole current passing at any time traverses this coil as well as the meter coils. The glass U tube is filled to the junction of the fall tube with dilute sulphuric acid, and the current in the coil develops a quantity of heat proportional to the square of the current which causes the air in the bulb to expand, and press on the liquid in that limb, with a consequent overflow into the fall tube. A given current will in this way produce always a definite pressure, and consequently no further overflow will occur unless the current at any time exceeds what has already been taken. The fall tube is graduated, and the maximum demand is read off on the scale direct. This is reset by tilting the instrument when the liquid runs first into the spherical bulb, then by slowly lowering it once more it runs back into the U tube, and is locked in the vertical position.

CHAPTER XI.

MEASURING INSTRUMENTS, AND THE MEASUREMENT OF ELECTRICAL RESISTANCE.

It very often happens that the engineer has to measure very small quantities, and these often with a high degree of accuracy. His indicating instruments are then of no service to him, and he has to make use of much more sensitive instruments. The principal measurements to be made are measurements of (1) resistance, (2) e.m.f., (3) magnetic quantities, and (4) capacity; and in these cases a sensitive galvanometer is employed. There are many types and forms, but the most common is that devised by Lord Kelvin.

In essentials it consists of two coils of very fine wire, having very many turns, placed side by side, with a small space between them, and connected in series. In some, two other coils of low resistance are also provided. These are supported by any convenient frame of brass, and the needle system is suspended between them by a very fine fibre of silk. The coils are wound on ebonite or brass bobbins having a hole through the centre, which tapers outwards from the centre to the front at an angle of about 60° , as shown in Fig. 70. The magnetic needle is made by fixing to the back of a small mirror five or six short pieces of magnetised watch spring, with similar poles adjacent, and the mirror stands normally in the centre of the hole in the bobbin. A wire is attached to the mirror which projects below it to the under edge of the bobbin, or to the centre of the low resistance coils, and there supports another magnet similar to the one above and an aluminium vane for damping the movement. This magnet has its poles pointing in the opposite direction to the magnet inside the coil so as to form what is known as an astatic combination. If the two magnets were of exactly equal strength they would have no tendency to set themselves in the earth's magnetic field, and therefore the controlling force due to this would be *nil*. But the needle inside the coil is usually a little

stronger than the one outside, and the controlling force due to the earth's field is therefore acting on a system which is equivalent to a magnet whose strength is equal to the difference between the

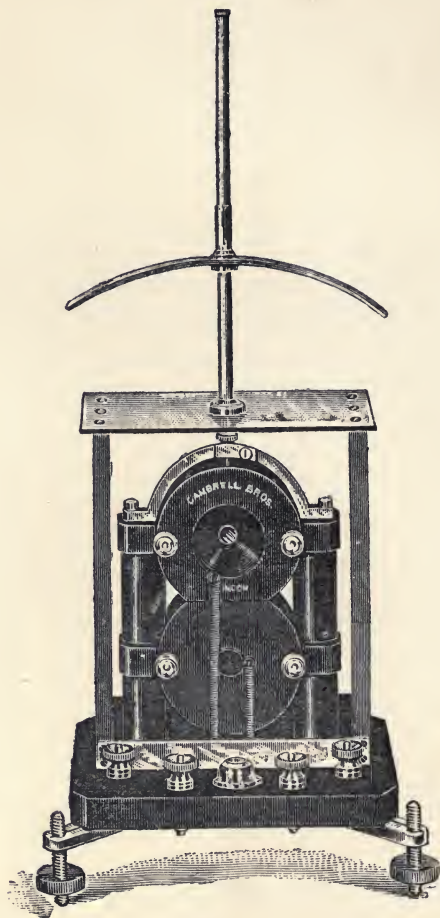

Fig. 70.

strength of the two needles, and therefore the earth's control can be made as small as we please. The magnetic field created by the current in the coil, however, acts on both needles in the same direction, which will be seen at once by considering the circular

field round the conductor, and therefore this astatic combination increases the sensitiveness in two ways, by diminishing the controlling force and by increasing the deflecting force. The movements of the needle are read by projecting a beam of light from an incandescent electric lamp or other suitable lamp through a small hole or slit in a screen, placed about 36 in. from the galvanometer. The mirror reflects this back again, and by adjusting the height of the lamp and slit we can get the reflected image thrown a little above the slit. An accurately divided scale (often in millimetres) is fixed at this point, about 18 in. long, and the movements of the spot or line of light can in this way be measured. With this arrangement we have an exceedingly long pointer without weight, and the slightest possible movement of the needle is read with ease and certainty, for the pointer is equivalent to one 2 yds. long if the scale be 1 yd. from the mirror, for the angular movement of the beam of light over the scale is twice that of the mirror. This is due to the fact that the angle of reflection is equal to the angle of incidence, that is to say, the angle formed by a line perpendicular to the mirror when in its deflected position and the beam of light from the lamp is equal to the angle made from this same perpendicular line and the beam of light reflected from the mirror, and therefore the angle between the two beams of light (called the incident ray and the reflected ray) is twice as great as the angular movement of the mirror. It will be seen therefore that for a movement of the reflected beam over the full range of the scale the angular movement of the mirror is but a very few degrees, consequently the scale readings are practically proportional to the deflecting currents. This proportionality is made more exact by using a straight scale instead of a curved one.

An instrument of this description when well made in every detail will give a deflection of one division on the scale with a current as small as $\frac{1}{100000000}$ ampere or even less. A sliding magnet is placed over the coil which serves to alter the control by moving it nearer to or further from the needle.

Another very common form of galvanometer, and one that is very convenient to use for certain measurements, known as the D'Arsonval galvanometer, is in principle similar to the Weston ammeter and voltmeter movements described in a preceding chapter.

Here, instead of having a magnetic needle for the moving part,

the current to be measured is passed through a suspended coil of fine wire, and its movements are measured by a mirror and beam of light as in the last case.

The coil is usually wound on a frame of thin sheet copper or aluminium, and the whole moving part is made as light as possible. The current to be measured is led into and out of the coil by the suspension, which consists of a very fine phosphor-bronze strip both at the top and bottom attached to adjusting screws, so that the tension on the phosphor-bronze strip may be adjusted. One at least of the supports for these adjusting screws must be insulated, and both are connected respectively to the terminals of the instrument.

This coil is placed in the magnetic field of a strong horseshoe magnet, the field being concentrated at this part and made more uniform by fixing a piece of soft iron inside the coil but in no way connected to it. The coil normally lies with its plane in the plane of the field, so that no lines are threaded through the coil, and the field is fairly strong.

When a current passes through the coil it creates a magnetic field at right angles to the field of the horseshoe magnet, which causes a turning effort to be applied to the coil, owing to the field being distorted, weakening it at one part and strengthening it at another. The angular movement of the coil depends on the strength of the field created by the current in the coil and the strength of the field in which the coil is placed, and again on the strength of the controlling force, which in this case is formed by the torsion of the phosphor-bronze strips (see Fig. 71).

The instrument so made is exceedingly dead-beat in its action, coming to rest almost immediately, for when the coil is moved in the field the copper or aluminium frame moves with it, and in so doing generates a current in it, which tends to stop its movement.

There being no sensitive magnetic needle in its construction enables it to be used near dynamo machinery and other places where a needle galvanometer would be useless.

There is still one other form of galvanometer to be considered, known as the ballistic galvanometer. It is the only one that can be used where transient currents are to be measured, for instance the current created in a coil by thrusting magnetic lines of force through it, or the current discharged from a condenser.

In this instrument the moving part is made heavy so as to

have a large amount of inertia, and no vanes or other damping mechanism is provided. In other respects it resembles the first instrument described. The needle system often consists of small magnets of watch-spring, or small horseshoe magnets with the limbs vertical, supported inside small spheres of lead, one being inside the coil, and the other outside it, as in the former case (see Fig. 72). If provided with independent high and low resistance coils, as shown in Fig. 70, it is equivalent to having two galvanometers in one.

An instrument of this description enables us to measure the quantity of electricity discharged through it by a transient current,

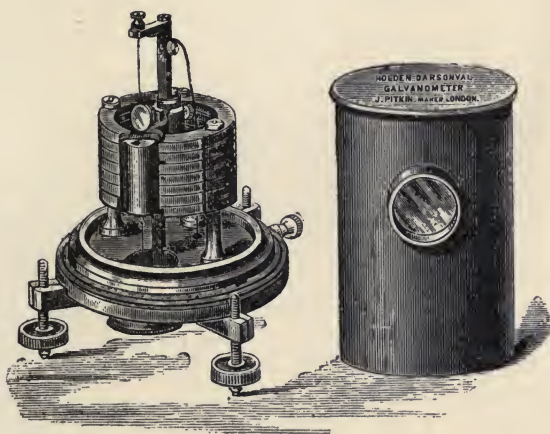

Fig. 71.

for owing to its inertia the whole quantity has passed through it before the needle has time to move from its position of rest. This is equivalent to giving (magnetically) a blow to the needle, which consequently swings for a distance, depending on the blow given. The first swing of the needle, therefore, becomes a measure of the quantity of electricity passed through the galvanometer by the transient current.

It is sometimes found desirable to considerably reduce the sensitiveness of the galvanometer, so as to allow of measuring larger currents, and though we can do this to a small extent by increasing the control, a much better method is to shunt the

galvanometer, so that only a certain known fraction of the total current flows through it.

Many galvanometers have shunts provided, so that by inserting a plug we can connect the galvanometer terminals in parallel with a resistance of $\frac{1}{9}$, $\frac{1}{99}$, or $\frac{1}{999}$ the galvanometer resistance. Suppose we connect the $\frac{1}{999}$ galvo resistance as a shunt, then only $\frac{1}{1000}$ part of the total current would go through the galvanometer coil, the other $\frac{999}{1000}$ going through the shunt, for the current divides always *inversely* proportional to the resistance, and the shunt



Fig. 72.

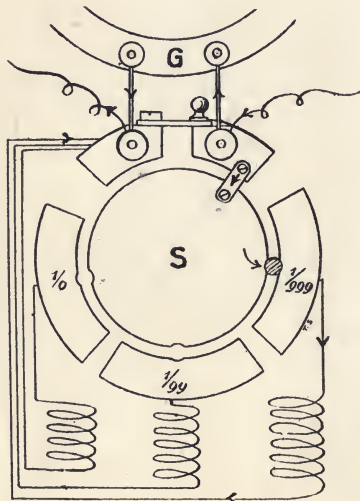

Fig. 73.

having only $\frac{1}{999}$ the resistance of the galvanometer, would take $\frac{999}{1000}$ of the current. With the $\frac{1}{99}$ shunt only $\frac{1}{100}$ part, and with the $\frac{1}{9}$ shunt only $\frac{1}{10}$ part of the current flows through the galvanometer. The connections for such a shunt box are shown in Fig. 73.

But any ordinary resistance box can be used as a shunt, providing we know the resistance of the galvanometer, for the current through the galvanometer can easily be calculated, whatever resistance we use as a shunt. Thus, suppose the resistance of the galvanometer be 5,000 ohms, and it is found to be necessary to

shunt the galvanometer with say 40 ohms, so as to get a readable deflection, then remembering that the main current will divide between these two resistances in inverse proportion to the resistances, we have a fraction of the main current flowing through

the galvanometer = $\frac{S}{G+S}$ where S = resistance of the shunt and G

the resistance of the galvanometer, for if we imagine the current to consist of 5,040 parts, then $\frac{40}{5040}$ will go through the greater resistance (the galvo), and $\frac{5000}{5040}$ through the smaller resistance

(the shunt), and $\frac{S}{G+S} = \frac{40}{5040} = \frac{1}{126}$ = the fraction of the main

current through the galvanometer, and therefore the whole current in passing through the galvanometer would give a deflection 126 times as great.

It should be noticed that by shunting the galvanometer we decrease its resistance, for we then have two resistances in parallel. The combined resistance is therefore less than the smallest of them, and if we wish to keep the resistance of the circuit constant and yet use a shunt on the galvanometer, it is necessary to add a resistance in series with the galvanometer and shunt to keep the resistance constant. Thus in the case given above, where the shunt has a resistance of 40 ohms and the galvo a resistance of 5,000 ohms, the combined resistance

$$= R = \frac{5000 \times 40}{5000 + 40} = 39.68 \text{ ohms,}$$

and therefore to keep the resistance of the circuit constant we must add $5000 - 39.68 = 4960.32$ ohms in series with the galvanometer.

The shunt boxes are often provided with this compensating resistance, so that by inserting the plug we shunt the galvanometer and add the corresponding compensating resistance at the same time.

As a further example in the use of shunts we may consider the following problem:—

Q. A galvanometer of 5,000 ohms resistance, when shunted by a resistance of 500 ohms, gives a deflection of 300 divisions with a certain current. What shunt will be required in order that with the same current the deflection may be reduced to 100 divisions? (S. and A. Honours.)

Here the resistance of the shunted galvanometer in the first case

$$= R_G = \frac{G \times S}{G + S} = \frac{5000 \times 500}{5000 + 500} = 454.5 \text{ ohms,}$$

and if the current is to be kept constant with the new shunt this value must also be kept constant. In this case $\frac{S}{G+S}$ part of the main current flows through the galvanometer, and to reduce the deflection to $\frac{1}{3}$ its former value, only $\frac{1}{3}$ of $\frac{S}{G+S} = \frac{1}{3} \times \frac{500}{5500} = \frac{1}{33}$ of the main current must flow through the galvanometer in the second case. Therefore in second case—

$$\frac{S}{G+S} = \frac{1}{33}$$

$$\text{Therefore } \frac{S}{5000+S} = \frac{1}{33}$$

$$\text{Therefore } 33S = 5000 + S.$$

$$\text{Therefore } 33S - S = 5000.$$

$$\text{Therefore } 32S = 5000.$$

$$\text{Therefore } S = \frac{5000}{32} = 156.25 \text{ ohms.}$$

But the resistance of the galvanometer when shunted with 156.25 ohms = $\frac{GS}{G+S} = \frac{5000 \times 156.25}{5000 + 156.25} = 151.3$ ohms, and to keep the current the same as in the first case we must keep the resistance of the circuit constant, and therefore we must add a compensating resistance. The value of the compensating resistance necessary

$$= 454.5 - 151.3 = 303.2 \text{ ohms.}$$

For measuring very small resistances the best method is that mentioned in Chapter I., page 10, where the resistance to be measured is connected in series with another known resistance of small value, and the potential difference on the ends of each measured, when a current is sent through them.

Now the deflection on the scale of a high resistance galvanometer is proportional to the potential difference on its terminals, for the current that flows through it is proportional to $\frac{V}{R}$, and R remains constant, and therefore the current through it is propor-

tional to v . The galvanometer, being so sensitive, will show very small differences of potential on the ends of the resistances, and therefore we are able to insert in the main circuit a high resistance which will allow only a very small current to flow, with one accumulator cell, and consequently the current will be more constant than it would be if the current were large.

We will now consider a particular case. Suppose we wish to measure the resistance of a dynamo (or motor) armature section. This will be made of stout copper, and will have a very small resistance. We now join up the armature section in series with our standard $\frac{1}{100}$ ohm, and an adjustable high resistance box, key, and one cell, as shown in Fig. 74.

If the section is in position on the armature it must be unsoldered and the ends brought out, and it must be kept at some

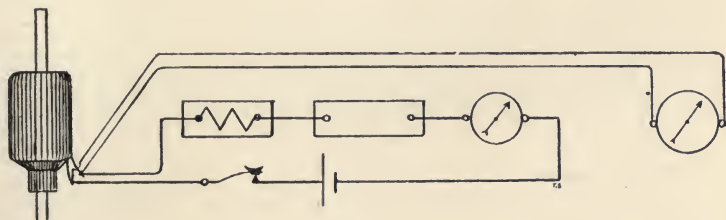

Fig. 74.

distance from the galvanometer, otherwise when a current flows in it the magnetic field so created in the iron of the armature will cause a false reading on the galvanometer. It is best in any case to send a current round the circuit before connecting the galvanometer, and notice if this has any effect. If so it must be rectified by removing the armature further from the galvanometer.

The galvanometer must now be connected to the ends of first one and then the other resistance in a manner which will not disturb the main circuit, otherwise the resistance of the main circuit will probably be altered during the operation. The deflections so obtained are proportional to the potential differences on their ends. Thus, suppose with the armature section we get a deflection of 200 divisions, while with the standard resistance we get 450 divisions, then—

Res. of armature section : standard res. :: 200 : 450.

Therefore res. of armature section = $\frac{200 \times .01}{450} = .0044$ ohm.

The long wires leading from the galvanometer can be of any thickness, for their resistance does not influence the result, being the same for both.

It may happen that when we connect up to one of the resistances we find the spot of light goes right off the scale, meaning that the p.d. we are trying to measure is too high. It can be reduced by increasing the resistances in the adjustable resistance box till we get a suitable deflection.

If the current should vary between the two experiments, owing to the cell polarising, the e.m.f. will vary too, and we will not get the true ratio between them. To make certain on this point, it is advisable to obtain the deflection on one resistance, then on the other, and then again on the first. If there be any difference in the first and last reading this will be due to polarisation, and the mean of the first and last reading will be the more accurate for this resistance. But if the resistance in the adjustable resistance box be fairly large, there should be practically no polarisation errors.

For measuring all resistances that are not very low or extremely high, some form of the Wheatstone bridge is usually employed. This method (which is exceedingly accurate if a little care be taken, and a sensitive galvanometer used) will be best understood by considering the simple diagrams shown in Figs. 75 and 76. Let A and B represent two resistances in series of any value joined to a cell, then a current flows through the two resistances from *a* to *d*, and the current has the same value for A and for B; *a* is therefore at a higher potential than *b*, for the current flows from *a* to *b*, and *b* is at a higher potential than *d* for a similar reason. Therefore *b* is at some intermediate potential between *a* and *d*. The value of the potential difference between *a* and *b* compared with that between *b* and *d* is in proportion to the resistance of A and B, as we saw in Chapter I. Suppose we now connect two other resistances to the points *a* and *d* as shown in Fig. 76, then the same reasoning will apply to these two as did to A and B. The extreme potential difference for the two circuits, viz., A + B and C + D, is the same for both, for they are connected to the same points, maintained at a certain potential difference by

the battery, and if this should vary for one, it will vary equally as much for the other circuit.

Now as the potential difference of the battery is falling equally down the two circuits, and as the point *b* is at some intermediate potential, there must be a point on the other circuit that is at the same potential as the point *b*. In fact, we could find hundreds of points on the two circuits at the same potential, for if we pick any point on the one circuit there must be a point on the other at the same potential. Let us suppose that the point *c* is at the same potential as the point *b*, then there is a certain voltage fall or potential difference between *a* and *b*, and this must be the same as the voltage fall between *a* and *c*, for *b* and *c* are at the same potential and *a* is common to the two. For the same reason the fall in potential between *b* and *d* is the same as that

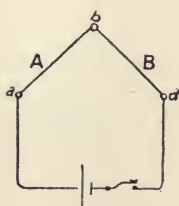

Fig. 75.

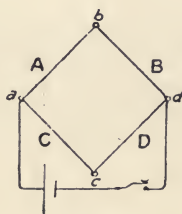

Fig. 76.

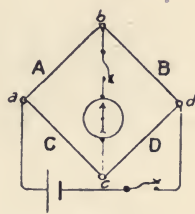

Fig. 77.

between *c* and *d*, and therefore the ratio of the voltage fall on *A* to that on *B* is the same as ratio between the voltage fall on *C* and *D*, and again the ratio of the voltage fall on *A* and *C* is the same as the ratio between the voltage fall on *B* and *D*.

Let us take values for these resistances and voltages. Suppose $A = 100$ ohms, $B = 30$ ohms, $C = 10$ ohms, and $D = 3$ ohms; and further, suppose the voltage fall on $A = 5$, and voltage fall on $B = 3$. Then as we have seen, the voltage fall on C must also = 5, while that on D must = 3. Therefore we have—

v fall on $A = 5 : v$ fall on $B = 3 :: v$ fall on $C = 5 : v$ fall on $D = 3$,
and also—

v fall on $A = 5 : v$ fall on $C = 5 :: v$ fall on $B = 3 : v$ fall on $D = 3$.

Now we have seen (Chapter I.) that the voltage of the circuit falls in proportion to the resistances, and therefore the

ratio of the voltages given above must also be the ratio of the resistances, or—

$$\text{Res. of A} : \text{res. of B} :: \text{res. of C} : \text{res. of D},$$

and also—

$$\text{Res. of A} : \text{res. of C} :: \text{res. of B} : \text{res. of D},$$

and if any three out of the four be known, we can find the fourth by working the simple proportion sum, thus:—Suppose D be an unknown resistance, then—

$$\text{Res. of A} : \text{res. of B} :: \text{res. of C} : x.$$

$$\text{Therefore } x = \frac{\text{res. of B} \times \text{res. of C}}{\text{res. of A}} = \frac{30 \times 10}{100} = 3 \text{ ohms.}$$

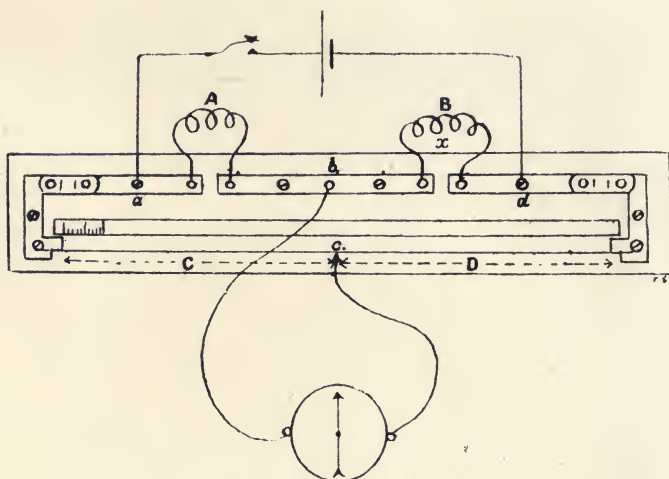

Fig. 78.

The operation then consists of finding a point on the one circuit at the same potential as some fixed point on the other circuit, and this we are easily able to do, for if a galvanometer be joined between the two points a current will flow through it while there is any difference of potential at its terminals, and it is only when we get absolutely no movement of the galvanometer needle when connected that there is no difference of potential.

The galvanometer must therefore be connected to points *b* and *c* as shown in Fig. 77.

One form of this instrument suitable for measuring low values is shown in Fig. 78, connected up ready for the test. It consists

of a straight uniform wire of german silver, manganin, platinum-iridium, or other high resistance metal, exactly 1 metre long, with the scale (graduated from both ends) placed behind it. This is attached at the ends to massive strips of copper having quite a negligible resistance, with certain small gaps for the insertion of resistances. A sliding contact maker is provided which allows of contact being made to the wire without injuring it. The battery and galvanometer are connected to terminals as shown.

When the key is put down a current flows in two circuits (1) through x and the standard resistance, and (2) through the wire, and the potential falls equally on both circuits. The galvanometer is joined to a point between x and the standard resistance, and the operation consists in moving the sliding contact till we get no

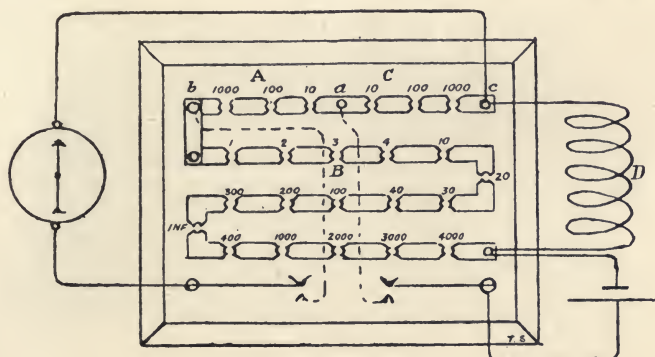

Fig. 79.

deflection on the galvanometer. Suppose this balance is obtained at a point 60 cm. from the right-hand side of the illustration in Fig. 78, and the resistance of the standard be 1 ohm, then we have the wire divided up in the proportion of 60 to 40, and therefore, as the resistance is proportional to the length, and the e.m.f. falls in proportion to the resistance, the e.m.f.'s on these two lengths are also in the proportion of 60 to 40. But this is the proportion of the e.m.f.'s on x , and the standard and the e.m.f.'s on them are proportional to their resistances.

Therefore res. of x : res. of standard :: 60 : 40,
or res. of x : 1 ohm :: 60 : 40.

Therefore res. of $x = \frac{60 \times 1}{40} = 1.5$ ohms.

Another form of this instrument used very largely by the Post Office authorities and most electrical engineers is shown in Fig. 79. Here resistance coils take the place of the slide wire described above, and in addition an adjustable resistance box is provided, containing in this case sixteen different resistance coils, which allow of over 11,000 changes being made in the resistance.

This being a very common form of resistance box for this class of work, it may be advantageous to describe it here in more detail.

On the top of the box (usually of ebonite) are fixed seventeen massive brass blocks, made originally from two or three castings, which are first machined, then divided up into the required



Fig. 80.

number of parts, and a hole drilled through each division. These holes are then rimmed out so as to taper inwards, and the pieces are next sawn across the centre of the holes. Each piece is now fixed in its place on the cover, and tapering plugs made to fit into the holes, so that when the plugs are in, the brass blocks are all connected together, and the resistance of the joints is negligible. The corners of each block are usually filed away, and also the under edge at the ends as shown in Fig. 81. Coils of wire (usually german silver) which have been very accurately adjusted by comparison with a standard are now fixed to the under side of the box cover, and the ends connected to two of the brass blocks by stout pins screwed up into them. The beginning of one coil is thus connected to the end of the last, that is, the coils

are connected in series all the way round, and the junction points connected each to a brass block, as shown in Fig. 81. The coils are wound so as to have little or no magnetisability, by winding the wire on after doubling it. The ends are connected to the pins, and the adjustment of the resistance is made on the middle point of the wire by uncovering a portion (the wire being usually covered with a double layer of silk), twisting up, and soldering the twisted part when the right resistance is obtained.

When all the plugs are inserted the resistance between the

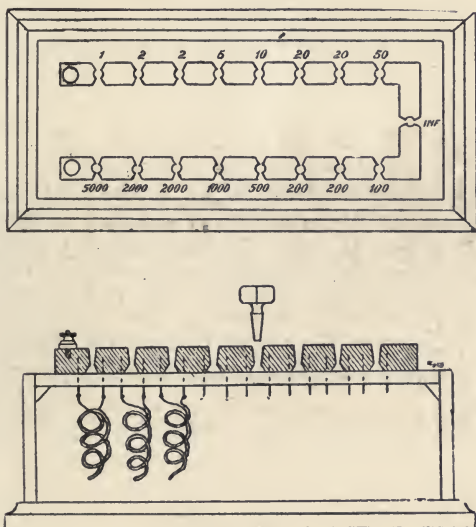

Fig. 81.

terminals at the ends is less than the resistance of all the brass blocks and plugs, for the coils underneath are in parallel with them, and therefore the resistance is some exceedingly small fraction of an ohm, and quite negligible. If we pull out any one plug or plugs, the resistance is increased by an amount corresponding to the resistance of the particular coil that the plug or plugs originally short circuited.

The coils are often arranged to have resistances of 1, 2, 3, 4—10, 20, 30, 40—100, 200, 300, 400—1,000, 2,000, 3,000, 4,000 ohms; and by such an arrangement we can put into the circuit

any resistance from 1 up to 11,110 ohms, that is to say, we can make over 11,000 changes in the resistance. Other combinations will give a similar result, thus 1, 2, 2, 5—10, 20, 20, 50, &c., or 1, 1, 3, 5—10, 10, 30, 50, &c.

In using such a box it is important to remember that the function of the brass plug is to short circuit the particular resistance, and therefore if the plug be dirty it will not properly do this, and we may have an appreciable resistance when the plug is in, which we are ignoring. For this reason the brass shanks of the plugs should never be touched with the fingers, nor even put down on to the table, for the fingers will give them a film of grease which will soon coat the inside of the taper holes, and bad contact must eventually result, while if the same thing does not occur by contact with the table, there is the chance of small pieces of dust and grit sticking to them, which is again ground up in the hole, forming a coating which may prevent a perfect contact being made. The best way of using them is to place them on a sheet of clean paper, with the brass shanks pointing upwards, that is, standing on the ebonite tops, and to remember to always lift them by means of the ebonite tops.

Returning now to the Wheatstone bridge, the top row of block seen in Fig. 79 are connected to resistance coils with values of 1,000, 100, 10, 10, 100, 1,000, and therefore the resistances starting from the centre block are the same on the two sides. These are called the ratio arms. By taking out plugs on both sides of the centre block we can make the ratio of the resistances on the two sides 1 : 1, 10 : 1, 100 : 1, &c., and *vice versa*. These are represented in Fig. 77 by the resistances A and c.

A thick copper connector joins the end of A to the resistance box B, while the resistance to be measured forms the fourth arm D, and is connected between the ends of c and B, and the battery and galvanometer are to be connected to the points shown in Fig. 79.

We have here then essentially the same thing as shown diagrammatically in Fig. 77, for in both cases, starting from the + end of the battery, we go through a key to a point *a* where the current divides. The part going along A is conducted through another resistance B in series with it, while the part going through c is led through another resistance D, where it joins on to the end of B, and this point is connected to the other end of the battery,

thus completing the circuit. The galvanometer in each case is joined to points *b* and *c*, that is, to the point where *A* and *c* join on to *B* and *D*, and a key is used in both cases to connect it to the circuit. Therefore the diagram shown in Fig. 77 will hold for the Wheatstone bridge box we are now considering.

In making a measurement with this instrument we must connect up as shown, and then take out plugs on either side of the central block, thus forming some ratio, say 100 ohms on either side, then the ratio = 1 : 1. Now a plug must be taken out of the adjustable resistance box *B*, thus putting a resistance into this arm, the value of which is anything we please, unless we can (by inspection or examination) tell approximately the resistance we wish to measure, in which case we would make *B* have a value somewhere near our approximation. Now first putting down the right-hand or battery key, and then the galvo key, we shall get a deflection of the galvanometer to the right or left, depending on whether the resistance in *B* is too much or too little. Most boxes are provided with an infinity plug in *B*, that is, a plug is provided similar to the others, but there is no coil connecting the two blocks, and therefore when this plug is out the resistance in *B* is said to be infinitely great, for we have then a complete break in the circuit. We can now pull out this infinity plug, and again put down the battery and galvo keys, and the needle will be deflected vigorously to one side. Now our resistance cannot be infinitely great, and therefore we know that every time the needle is deflected to the same side as when the infinity plug was out the resistance we have put in *B* is too great, and we must therefore reduce it and try again. Thus we may find that with 1,000 ohms in *B* the deflection is in the same direction as when the infinity plug was out, and with 10 ohms in *B* the deflection is in the reverse direction, then we know that to obtain a balance the resistance in *B* must be greater than 10 and less than 1,000 ohms. We now try 500 ohms, and get say the same effect as with 1,000, then we know the required resistance is less than 500 and greater than 10 ohms. Proceeding in this way, we soon reduce the range to a small value, and eventually obtain a balance. Suppose the balance is obtained with 150 ohms in *B*. Then—

$$A : C :: B : x.$$

And therefore $100 : 100 :: 150 : x$, or $x = 150$ ohms.

But we can alter the ratio of A to C , making it say 1,000 ohms in A and 100 ohms in C , or a ratio of 10 : 1. When we obtain a balance, the ratio of B to x will also be 10 : 1. Using this ratio, we may find that to obtain a balance we require in B a resistance of 1,502 ohms. Then—

$$A : C :: B : x.$$

$$\text{Therefore } 1000 : 100 :: 1502 : x.$$

$$\text{Therefore } x = \frac{1502 \times 100}{1000} = 150.2 \text{ ohms.}$$

If the resistance to be measured be very high, for instance the resistance of the insulation on a cable or the insulation resistance of any insulator, another method must be employed. As an illustration let us consider the insulation resistance of a cable.

A certain length of the cable to be tested should be placed in a tank of water, with both ends projecting for some distance, as

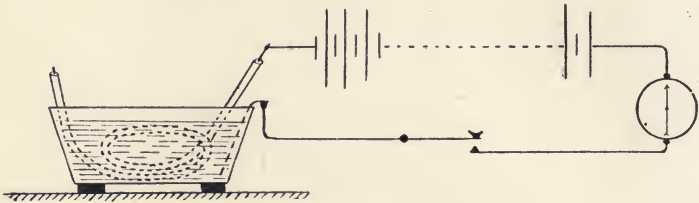

Fig. 82.

shown in Fig. 82, and allowed to remain in it for say twenty-four hours, with the water at a temperature of 60° F., after which the test can be made.

Connection can now be made from the water in the tank (or from the tank itself, if a metal one standing on insulators) through the galvanometer to the core of the cable, putting into the circuit any number of cells found to be necessary for giving a readable deflection on the galvanometer, say ten divisions, noting at the same time the number of cells employed.

Now this deflection is due to a current flowing through the circuit, which consists of the galvanometer, battery, wires, and cable insulation, and the e.m.f. employed to get the current through is known, depending on the number of cells. If we could therefore find the value of the current flowing we could, by Ohm's law, calculate the resistance of the circuit.

This is obtained by an independent experiment, done either before or after the one just described. Connect up the galvanometer to some known high resistance, say 10,000 ohms, and shunt the galvanometer with $\frac{1}{999}$ the galvanometer resistance. Use only one cell, and obtain a deflection of the galvanometer say thirty divisions on the scale. The resistance of the galvanometer unshunted we will suppose to be 5,000 ohms, and therefore when shunted with a resistance equal to $\frac{1}{999}$ of 5,000 ohms, or 5.005 ohms, the resistance is reduced to $\frac{5000 \times 5.005}{5000 + 5.005} = 5$ ohms nearly.

The current flowing through the circuit is therefore

$$= \frac{\text{e.m.f.}}{\text{res.}} = \frac{2}{10000 + 5}$$

and only $\frac{1}{1000}$ part of this current passes through the galvanometer,

therefore current through galvanometer = $\frac{2}{(10000 + 5) \times 1000}$, and

this current gives us a deflection of thirty divisions on the scale, therefore a current of $\frac{1}{30}$ this value would give us one division, or current through galvanometer to give one division on the scale

$$= \frac{2}{10005 \times 1000 \times 30} = \frac{1}{150075000} \text{ ampere.}$$

In our first experiment, with the cable giving a deflection on the unshunted galvanometer of ten divisions, the current flowing would be $\frac{10}{150075000}$ ampere, or ten times the current for one division, and if the number of cells employed in that experiment were say 100 accumulators, then by Ohm's law the resistance

$$R = \frac{\text{e.m.f.}}{\text{current}} = \frac{200}{\frac{10}{150075000}} = 3001500000 \text{ ohms,}$$

which is practically the resistance of the insulation of the given length of cable, for the resistance of the galvanometer and battery is negligible when compared to that of the cable insulation.

Now the insulation resistance decreases with the length of the conductor, for the length of the path of the current *through the insulation* is the same whatever the length of the cable, but the sectional area of the insulation is proportional to the length of the cable, and the resistance of the insulation is (as in every case) proportional to the length and inversely proportional to the sectional area, and therefore the insulation resistance is inversely proportional to the length of the cable. Suppose the length

measured be 100 yds., then the insulation resistance per mile = $\frac{100}{17780}$ of 3001500000 ohms = 170540000 ohms, or practically 170 megohms.

By one or other of the methods given, any resistance, however large or however small, can be accurately measured. But resistance is not the only measurement made by the electrical engineer. Measurements of electro-motive force and current strength have often to be made, and also measurements of the magnetic quality or permeability of different materials form part of the work of many electrical engineers, and these we will consider in the next chapter.

The low resistance coils on the galvanometer should be used when making measurements on low resistance circuits, and the high resistance coils for high resistance circuits, for should the circuit have a low resistance and we connect the high resistance galvanometer coils in it, we may change the value of the external resistance by 100 or 200 per cent. and still make no readable difference in the galvanometer deflection, while if we use the low resistance coils on a high resistance circuit, the galvanometer will again be very insensitive to small changes in the external resistance owing to the small number of ampere turns in the galvanometer. The best effect is obtained in every case when the galvanometer resistance approximates to the resistance of the remainder of the circuit.

CHAPTER XII.

MEASUREMENT OF POTENTIAL DIFFERENCE CAPACITY, CURRENT STRENGTH, AND PERMEABILITY.

ONE of the best methods of measuring electro-motive force is that known as the "potentiometer" method.

In its simplest form the potentiometer consists of a simple straight uniform wire, stretched over a scale, with a sliding contact, so that connection may be made to any point on the wire, as shown in Fig. 83.

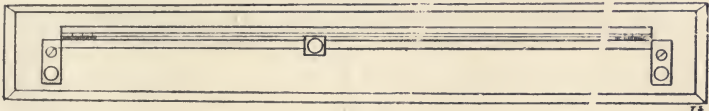

Fig. 83.

When the key is put down a current flows round the circuit and the potential difference of the cell falls proportionally to the resistance, but the resistance of the wire (if uniform) is proportional to its length, and therefore the potential difference on any length of the wire is proportional to that length, and if the connecting wires and cell have a negligible resistance compared with that of the wire, we shall have a range of potential differences from any value up to something little short of the e.m.f. of the cell. We can measure any e.m.f. within this limit by balancing it against the same potential difference on the wire, having first standardised the wire to find the potential difference on unit length of it.

Suppose we have a cell whose e.m.f. is required, and also another whose e.m.f. is known, we can compare the e.m.f. of the unknown to that of the known cell by the potentiometer.

We first connect up one cell to the potentiometer, as shown in Fig. 84, putting a galvanometer in the circuit of this cell, and connecting to the wire a cell or cells having a higher e.m.f. than that of the cell we wish to measure, being careful to join similar poles to the same end of the wire. Now the potential of A, when connected as in Fig. 84, is higher than that of B, and there is therefore a uniform fall in potential from A to B. Suppose the e.m.f. of the cell s be equal to the potential difference between A and c , then if we connect it through a galvanometer to the points A and c no current will flow through the galvanometer, but if we move it ever so little to the right or left of this point a current will flow through the galvanometer in one or the other direction,

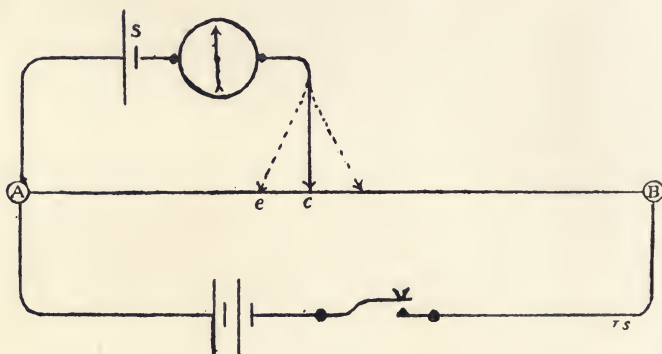

Fig. 84.

depending on whether we join it to points at a higher or lower potential difference than that of the cell.

The operation then consists of finding the point on the potentiometer wire where we get no deflection on a sensitive galvanometer when the cell is connected through it to the wire, and a few trials usually suffices to find this point very accurately. We will suppose the point to be at c in Fig. 84. Then the e.m.f. of our cell is equal to the potential difference between A and c , and we have still to determine this potential difference. We now replace this cell by a cell whose e.m.f. is known, and obtain a balance in exactly the same way. Suppose this to be obtained with the contact at e , and further suppose the e.m.f. of this cell be 1 volt. The potential difference between A and e is then equal

to 1 volt, and the potential difference is proportional to the length of the wire, and therefore the p.d. between ae : p.d. between ac in proportion of the length ae : length ac , which can be read off on the scale, and so the e.m.f. of the first cell determined. Thus, if the length $ae = 30$ cm., and $ac = 40$ cm., then—

$$\begin{aligned} \text{e.m.f. of standard cell} : \text{e.m.f. of cell } x &:: 30 : 40, \\ \text{or } 1 \text{ volt} : \text{e.m.f. of cell } x &:: 30 : 40. \end{aligned}$$

$$\text{Therefore e.m.f. of cell } x = \frac{1 \times 40}{30} = 1.33 \text{ volts.}$$

There are, however, certain disadvantages in using a single (short) length of wire, while if we employ a long length it becomes very inconvenient. The short wire will offer but a small resistance, and therefore the current taken from the battery will be large, and it will consequently quickly run down or polarise; and if we use a very fine wire to get an increased resistance, it is very weak and easily injured, and therefore the increased resistance must be obtained by an increase in length rather than a decrease in sectional area. To obtain this result the potentiometer is sometimes made in the form shown in Fig. 85, where the wire is divided up into a number of short sections all connected in series by stout copper connecting pieces, and a bridge arranged to slide up or down over the length of the wires, the contact maker sliding from right to left, so as to come over any section of the wire.

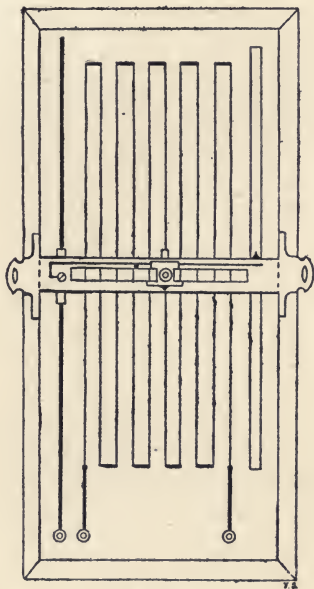

Fig. 85.

This form has the disadvantage of the long length of wire being exposed to injury, and if injured at all, the accuracy of the measurements made with it will of course be inferior whatever care be taken in making them.

The best forms of potentiometer have a working length of wire

about 1 metre long, and the remainder wound on a reel and placed inside a box, with connections from parts having exactly the same resistance as the working wire outside, to a number of contacts on the cover, so that by swinging round a switch lever we can make contact with it on any multiple length of the wire outside the box, the fractions of this length being obtained by moving a sliding contact on the outside wire.

An adjustable resistance can also be inserted in the circuit, so as to bring any fraction of the potential difference of the battery (within certain limits) on to the potentiometer sections, for by cutting out the adjustable resistance we have a higher e.m.f. on the remaining portions of the circuit and *vice versa*.

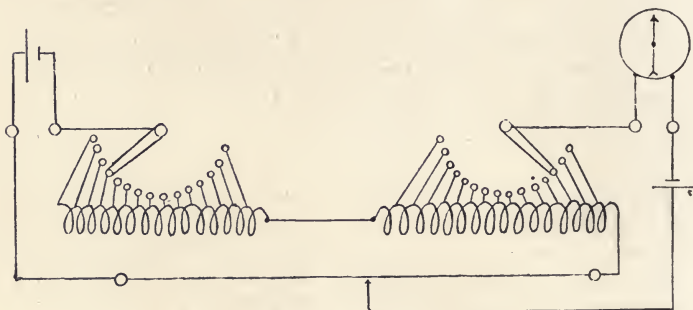

Fig. 86.

In this form each contact of the right-hand switch adds or subtracts a resistance equal to that of the slide wire AB , and therefore if a balance is obtained with the switch arm on say the sixth stud and the slider at 30 cm. from the right-hand end of AB , and if there be say fifteen contact studs altogether, then we have a balance on $\frac{6.3}{15}$ of the total potential difference. In this way we first get to within $\frac{1}{15}$ of the required value by simply switching round on the contact switch, and then add on the extra length required to give a balance by adjusting the position of the slider on the slide wire.

It is evident that, as we can adjust the potential difference operating on the whole fifteen sections of the potentiometer wire by adjusting the value of the resistance in series with it, we might put a scale on the slide wire and on the fourteen additional sections

to read in volts direct, and so save time in calculations, for we could connect on our cell of known e.m.f., first setting the switch and slider to read on the scale provided the e.m.f. of this cell, and then adjust the resistance in series and therefore the p.d. on the slide wire till we get a balance. Then if we do not alter this resistance, and the battery supplying the current remains constant, any balance obtained by other cells may be read off direct in volts. This is done in many potentiometers, one made by Messrs Crompton & Co. being a very excellent example.

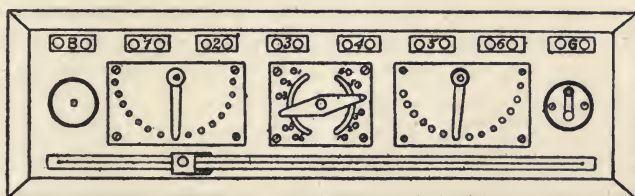

Fig. 87.

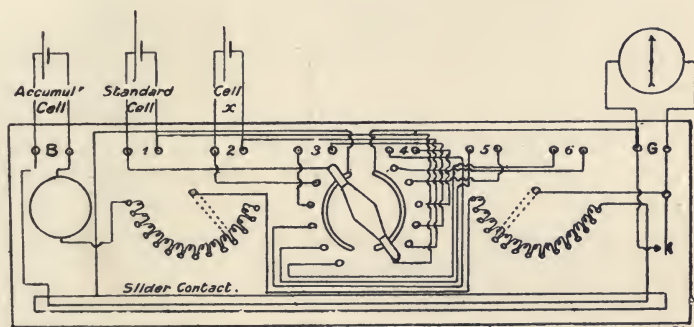

Fig. 88.

A plan view of an instrument of this description is given in Fig. 87, and a diagram of the connections in Fig. 88.

The galvanometer is to be connected to the terminals marked G, and the battery to the terminals marked B, while the standard cell or cell of known e.m.f. and any cell or cells of unknown value may be connected to terminals 1, 2, 3—6. The galvanometer circuit is completed by putting down the slider key, while the battery circuit is complete without a key, for varying contact re-

stances at the key would cause varying potential differences to arise. One or other of the cells connected to 1, 2, 3—6 are brought into the galvanometer circuit by switching the double contact switch at the centre on to the corresponding contacts. It is therefore very easy to change connections from one cell to the other, and to return at any time to the standard cell to see if the e.m.f. on the potentiometer wire is still unchanged is but the work of a few seconds.

The method of using this instrument is simple. Having connected up as shown in Fig. 88, we now switch the centre double contact switch to No. 1 contacts, thus putting the standard cell into the galvanometer circuit. If the e.m.f. of this cell be say 1 volt, then we put the right-hand switch on to contact No. 10, and the slider to the extreme right of the slide wire. We now adjust the resistance in series with the potentiometer wire by switching round the multiple switch on the left till we get a deflection in one direction on one contact, and in the opposite direction on the next contact, when we depress the slider key. A perfect balance is then obtained by adjusting the sliding contact on the extreme left, and now the wire is calibrated to read in volts direct.

The next operation is to change the position of the centre switch to No. 2, 3, or 4, as the case may be, and now move the switch lever on the right till we find two adjacent contacts which give opposite effects on the galvo. Leaving the switch on the smaller of the two, we now get perfect balance by adjusting the position of the slide wire, and then read off the e.m.f. direct. Thus, suppose the switch be on No. 14 contact, and the slider index points to 44.5, then the e.m.f. of the cell = 1.4445 volts.

This of course is a very accurate statement of the e.m.f. of the cell, and could not be accepted unless we knew the e.m.f. of our standard cell correct to the same degree, and this brings us to a consideration of the standard cells employed.

The standard cell that has been most extensively used for a number of years is known as the Latimer-Clark standard, which gives an e.m.f. of 1.434 volts at 15° C. Its e.m.f. varies with the temperature, being lower at a higher temperature and higher at a lower temperature by $\frac{1}{1000}$ volt per degree. Thus at 18° C. its e.m.f. = 1.431 volts, and at 12° C. its e.m.f. = 1.437 volts.

It is made up usually in a small test tube (the size of the cell being unimportant), and consists of, first, a small amount of pure

mercury, a platinum wire being sealed through the glass to make contact with it, or in some cases simply a flat spiral of amalgamated platinum wire sealed in a glass tube, inserted from the top. On top of this is placed a mixture of mercurous sulphate and saturated zinc sulphate solution which forms a stiff paste, and the cell is then about three parts filled with the saturated zinc sulphate solution. A small rod of pure zinc is next fixed into a cork

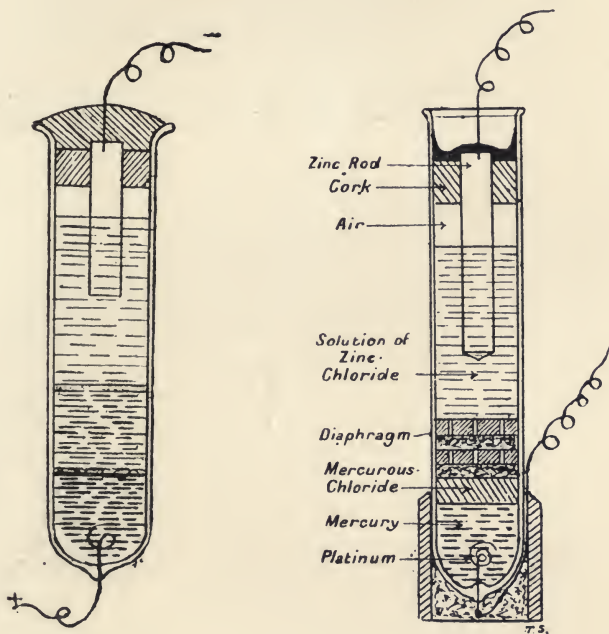

Fig. 89.

Fig. 90.

with a wire soldered to its upper end, projecting through the cork, and this is pushed in till the zinc rod projects a little distance into the zinc sulphate solution, leaving an air-space of about $\frac{1}{2}$ in. or so. The whole is sealed up with marine glue, or some such material, by heating it in a ladle and pouring on while hot. The arrangement is shown in Fig. 89.

Another cell of this description, known as the "Hibbert" cell, has recently been put on the market, and is being sold by Messrs

Crompton & Co. for use with their potentiometers, and also by Messrs Paul, electrical instrument makers, Holborn. It has several advantages over the previous cell described, and is the outcome of the study and experiments of Mr W. Hibbert and the author for several years past.

It is made up in a small test tube, similar to the Latimer-Clark cell, with mercury for the + element. The paste, however, consists of mercurous chloride and zinc chloride solution, and the cell is three parts filled with the zinc chloride solution, which must be adjusted very accurately to a certain density, for the e.m.f. of the cell depends on the density of the solution.

It was found necessary to provide a porous diaphragm to prevent the mercury from moving when the cell is transported, as shown in Fig. 90.

When the solution, which must be perfectly neutral, is properly adjusted in density, the cell gives an e.m.f. of 1 volt at 15° C., and varies with temperature by $\frac{1}{10000}$ volt per degree, rising and falling with the temperature. Thus at 18° C. the e.m.f. = 1.0003 volts, while at 12° C. the e.m.f. is .9997 volt. The changes made by alterations of temperature in this country are therefore very small, and for most purposes can be neglected.

By an adjustment of the density of the zinc chloride solution the cell can be made to give 1 volt at temperatures higher or lower than 15° C. Thus if cells are intended for use in tropical countries where the average temperature is considerably above 15° C., they can be made to give 1 volt at this average temperature.

Should the cell, from any accidental cause, be short circuited for a time, the e.m.f. falls considerably. This applies to the "Latimer-Clark" cell as well as to the "Hibbert" cell, and therefore it is not serviceable as a standard again till it has had time to recover. The recovery of the "Hibbert" cell after one minute short circuit is practically complete in four minutes, whereas the Latimer-Clark cell, similarly treated, has not recovered to an equal extent within two hours, which thus delays the work for that time, unless a second cell be available.

In ordinary use on the potentiometer, these cells, and also the cells whose e.m.f. are to be measured, are delivering no current when the balance is obtained, otherwise the galvanometer connected in their circuit would be deflected, and the current sent through them in one direction or the other in obtaining the

balance is, with an experienced operator, very small, and only lasts for a very small fraction of a second, which is not sufficient to disturb the value of the e.m.f., and therefore a true measure of the e.m.f. is obtained.

If the e.m.f. to be measured is large, say 100 or 200 volts, a modification must be made in the arrangement of the circuit. In this case the two points at the required difference of potential can be connected to a high resistance, say 10,000 ohms, or higher if necessary. A small current will then flow $= \frac{E}{R}$, in this case

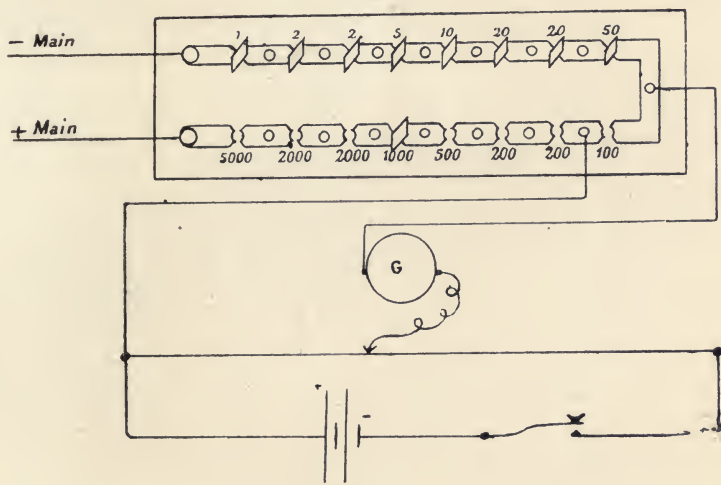

Fig. 91.

$= \frac{100}{10000} = .01$ ampere, and the e.m.f. will fall proportional to the resistances. All we need do, therefore, is to make contact on to such a fraction of the total resistance that the e.m.f. comes within the range of the potentiometer, and this fractional e.m.f. being measured in the usual way, we can from it determine the whole. Thus, suppose we measure the e.m.f. on 100 ohms, and find this to be .997 volt, then as 100 ohms is $\frac{1}{100}$ of 10,000 ohms, and as the e.m.f. falls proportional to the resistance, the total e.m.f. will be $.997 \times 100 = 99.7$ volts. The connections are shown in Fig. 91.

The potentiometer can also be used for measuring currents,

with the addition of certain standard resistances of small value, say $\frac{1}{1000}$ ohm, $\frac{1}{100}$ ohm, and $\frac{1}{10}$ ohm, &c., for according to Ohm's law the current is equal to $\frac{\text{e.m.f.}}{\text{res.}}$, and if we measure the e.m.f. on a known resistance, we can find the value of the current by simply dividing the one by the other.

It is in this way that the very large currents sometimes employed in electrolytic work, copper refining, &c., are measured. The arrangement of the circuit for making such a measurement is shown in Fig. 92.

If the resistance of the standard inserted in the circuit be say

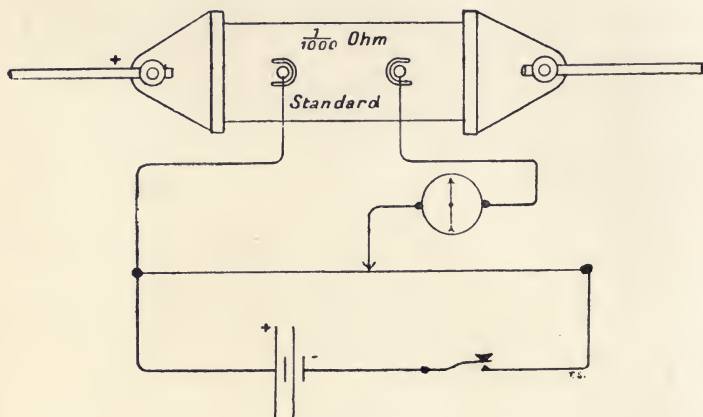

Fig. 92.

$\frac{1}{1000}$ ohm, and the e.m.f. measured by the potentiometer be say .5 volt, then the current flowing in that particular case would be

$$\frac{.5}{\frac{1}{1000}} = .5 \times 1000 = 500 \text{ amperes.}$$

Another method of measuring e.m.f. is one involving the use of a condenser and ballistic galvanometer. The condensers employed in this class of work consist of alternate sheets of tinfoil and mica or paraffined paper. The simplest case is where a single sheet of mica is faced on both sides with tinfoil sheets, smaller in sectional area than that of the mica sheet, so as to be perfectly insulated one from the other. If these two tinfoil sheets be connected, one to the + and the other to the - pole of

a battery, a quantity of electricity will flow from the battery to the plates to charge them to the same difference of potential as that of the battery. This quantity of electricity will be exceedingly small, and the flow will be over in an exceedingly small fraction of a second. The quantity of electricity that flows into the condenser under any given difference of potential depends on (1) the size of the plates of the condenser; (2) inversely to the thickness of the insulating material; and (3) the nature of the insulating material, or as it is called, the "specific inductive capacity" of the material. If therefore we make the area of the plates large and the thickness of the mica or paraffined paper small, we shall have a condenser that will require a larger quantity of electricity to raise it to the potential difference of the battery. That is to say, the capacity of the condenser will be larger.

This is usually accomplished by using very thin insulating material, and placing alternate sheets of tinfoil projecting at opposite corners of the mica or paraffined paper, as shown in Fig. 93. If now all the tinfoil sheets that are projecting at one edge be connected together, and all those at the other edge similarly connected together, they form electrically two sheets of large superficial area insulated one from the other by the mica or paper insulation. When the required number of sheets have been so arranged, they are usually put into a box and fastened down, the two sets of plates being connected to terminals on the lid of the box.

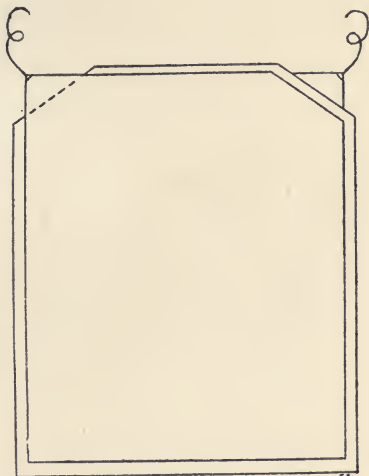

Fig. 93.

A condenser of this description would have unit capacity when unit quantity of electricity raises its potential to unit value. For practical purposes the unit quantity of electricity is the coulomb, and the unit difference of potential is the volt, and therefore the practical unit of capacity, known as the Farad (from the great

English scientist Faraday), is such that 1 coulomb would raise its potential difference to 1 volt. Such a condenser would be very large and costly, and unsuitable for practical purposes, so $\frac{1}{1000000}$ part or 1 micro-farad is the unit commonly adopted.

A submerged submarine cable when disconnected at the ends forms a condenser, the core taking the place of one of the tinfoil conductors, and the sea the second conductor insulated from it by the insulating material of the cable. Certain cables of this description have a capacity of approximately $\frac{1}{3}$ micro-farad per mile.

We have already seen that the quantity of electricity that will be taken by a condenser depends on the capacity of the condenser.

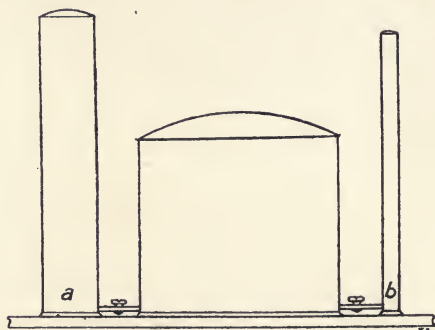

Fig. 94.

It also depends on the potential difference used to charge it. This will be understood best by an analogy. Suppose we have a reservoir of air or other gas under compression, and two vessels *a* and *b* connected to it at the bottom, with pipes and taps as shown in Fig. 94. Each of these vessels has a certain capacity, and the quantity of gas each will take when the tap is turned on depends on their capacity. But if the pressure of the gas in the reservoir be increased in any way the quantity of gas taken by each will increase in the same proportion, for it will in every case take so much as will raise the pressure equal to that in the reservoir.

We may therefore write

$$Q = vC,$$

where *Q* is the quantity of electricity in coulombs, and *v* is the

difference of potential used to charge the condenser, or the potential difference of the condenser when charged with quantity Q , and c is the capacity of the condenser in farads.

It will be as well to note in passing that the work done in charging a condenser is not Qv but $\frac{Qv}{2}$, for in this particular case the whole quantity Q is not raised through a potential difference $=v$, for the first small quantity that flows in does so against practically no back pressure, while the last small quantity had to be forced in against the whole potential difference.

Let us take an analogy similar to the last (Fig. 95). Here a rotary pump is supposed to have been at work and pumped water up the pipe to the height shown. How much work was done in raising the water? Evidently not the weight of water raised multiplied by

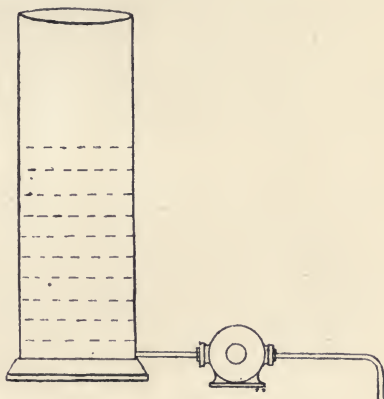

Fig. 95.

the total height in feet, for only a very small quantity at the top has been raised this height, while some at the bottom has not been raised at all. Therefore the average or mean height through which the water is raised is equal to half the total height, and therefore the work done in charging the vessel with water is equal to $\frac{Qv}{2}$, where Q is the quantity of water in pounds weight, and v is the vertical height from the base to the top, or the difference of level.

In the same way the work done electrically in charging a condenser $=\frac{Qv}{2}$, and if Q and v are in absolute units the work done is in ergs, while if Q is in coulombs and v in volts the work done is in joules.

Now if the quantity of electricity taken by a condenser when joined to a cell be discharged through a ballistic galvanometer,

the first swing of the needle is proportional to the quantity discharged, and this quantity is also proportional to vc , therefore the first swing of the needle is proportional to vc . If therefore we use the same condenser, and connect it first to our standard cell, then to the cell whose e.m.f. is required, and discharge the quantity taken by the condenser with each through a ballistic galvanometer, the two swings of the galvanometer needle will be proportional to the e.m.f. of the standard cell, and the cell of unknown e.m.f. from which the unknown value can be determined.

The connections for making such a test are shown in Fig. 96, which allows of a very rapid charge and discharge by simply putting down the key for an instant and then releasing it. Putting down the key connects the cell on to the condenser, and breaks the

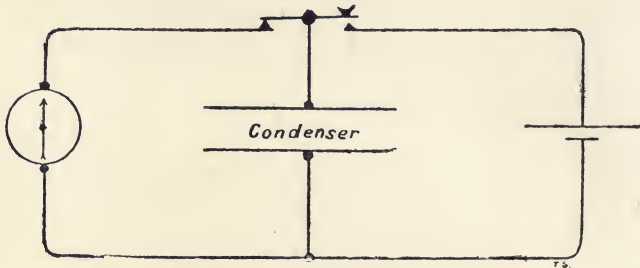

Fig. 96.

connection between the condenser and the galvanometer, while releasing the key breaks the cell circuit, and completes the circuit between the condenser and the galvanometer.

The time occupied in putting down and releasing the key should be as short as possible, for if prolonged the discharge of the condenser is also prolonged, owing to some of the charge penetrating into the insulator and requiring time to again leak out, and in such a case the first swings of the ballistic galvanometer are not proportional to the quantities discharged through it as pointed out in describing the instrument.

Suppose in a certain case with the standard cell = 1 volt, and a condenser of $\frac{1}{3}$ m.f. capacity, we obtain a swing of 200 divisions, and with the same condenser and the cell of unknown e.m.f. we obtain a swing of 300 divisions, then—

$$200 : 300 :: 1 \times \frac{1}{3} \text{ m.f.} : x \times \frac{1}{3} \text{ m.f.}$$

$$\text{Therefore } 200 : 300 :: 1 : x.$$

$$\text{Therefore } x = \frac{300}{200} = 1.5 \text{ volts.}$$

High voltages could be measured by this method if we adopt the device described with the potentiometer for so doing, and also measurements of current strength by measuring the e.m.f. on a standard low resistance placed in the circuit, but care must be taken in such cases that the galvanometer needle is not influenced by the field created by the large current. This is obviated if a D'Arsonval type of galvanometer be employed, which of course would have to be made without the damping coil frame, and with a relatively heavy moving coil. Of course with known e.m.f.'s capacities may be compared in the same manner.

We now turn to consider another measurement, viz., the determination of the magnetic permeability of a specimen of iron.

The piece of iron to be experimented with should either be a long bar, or if short, should be welded into the form of a ring and turned in the lathe so as to be uniform in sectional area. We will consider the sample in the form of a long bar first.

First wind the bar uniformly from end to end with insulated wire, carefully counting the number of turns put on. Accurately measure the length and sectional area of the bar in centimetres and square centimetres respectively. Divide the total number of turns by the length, and so get the number of turns per centimetre length.

If now a current be passed through the coil, the number of lines of force per square centimetre will be equal to $B = 1.25$ ampere turns per centimetre $\times \mu$, and $B = \frac{\text{total lines}}{\text{sec. area}}$

The total lines may be measured by simply noting the deflection produced by the magnetised bar on a sensitive magnetometer, which consists of a small magnetic needle suspended by a single fibre of silk, and furnished with a mirror similar to that described in the case of the galvanometer, but with a single needle instead of the astatic combination. This instrument, protected from draughts by a case of wood, brass, or other non-magnetic material, is placed at any measured distance in millimetres from the bar under test, and so arranged that the needle lies at right angles to the axis of the bar.

A spot of light serves for the index as in the case of the galvanometer.

The bar of iron is placed behind the magnetometer at a fairly large distance from it, and the distance from the needle to the centre of the bar accurately measured. The arrangement is shown in Fig. 97.

Now when the bar is magnetised the needle will be deflected, and the deflection in millimetres must be read on the scale for a number of different values of the current, *i.e.*, for different values of ampere turns per centimetre, and the total lines of force are calculated from the formula—

$$\frac{M}{H} = \frac{d^3 \text{ tangent deflection}}{2}$$

where M is the magnetic moment of the bar, and is equal to the strength of the pole s in unit poles \times length of the bar in centi-

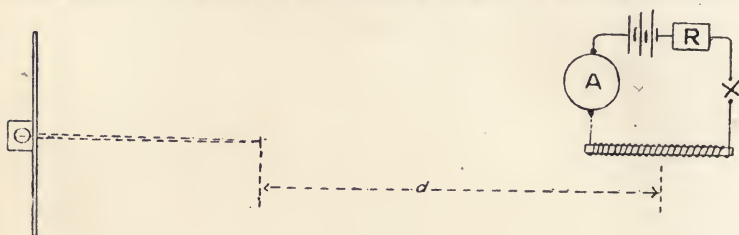

Fig. 97.

metres = l . Therefore $M = s \times l$. H is the intensity of the earth's controlling field on the magnetometer needle, and if the place where the experiment is made be free from large masses of iron, such as iron girders, H will be equal to .16 in England. It however varies with position, but is known very accurately for different places and is tabulated. If not known, it can be easily determined.

d^3 is the distance from the magnetometer needle to the centre of the bar, cubed, and therefore any error in measuring this distance will very materially affect the accuracy of the measurement, as the error will also be cubed.

The "tangent of the deflection" is got by dividing *half* the deflection in millimetres by the distance of the scale from the magnetometer needle in millimetres, for, as already pointed out,

the angular movement of the index is always twice that of the mirror and needle.

The proof of this formula and also the method of determining H are simple, but rather too lengthy to enter on here, and the student will find both in almost any text-book on magnetism.

From this formula

$$\frac{M}{H} = \frac{d^3 \tan a}{2} \text{ we get } M = \frac{Hd^3 \tan a}{2}$$

and all on the right are known quantities, therefore M is easily determined. Now if we divide M by the length of the bar in centimetres we get s , the strength of the pole of the bar formed by a certain number of ampere turns per centimetre. This is the strength of pole in unit poles, which we have seen are each equal to 4π lines of force. Therefore the total lines of force produced in the iron bar = $4\pi s$ lines.

$$B \text{ is now equal to } \frac{4\pi s \text{ lines}}{\text{sec. area}}$$

This can be repeated for any number of values of the current and corresponding values of B obtained. These values can then be plotted in a curve of permeability, or a $B-H$ curve, for the corresponding value of $H = 1.25$ ampere turns per centimetre, as pointed out in Chapter V.

If the iron be welded into a ring and turned up, we can use the ballistic galvanometer in measuring the total lines of force.

First measure the mean length of the iron ring and its sectional area, then closely wind it evenly all over with a coil of wire, counting the turns put on. Connect it up to an adjustable resistance, a reversing key, a few accumulators, and a correct reading ammeter, so as to be able to alter the current strength readily, and reverse it quickly.

Now wind over this coil a second coil of a few turns, and connect this in series with the similar coil of a standard magnet, and with the ballistic galvanometer, as shown in Fig. 98.

When we switch on there will be a sudden kick of the galvanometer needle, due to the lines of force created in the iron threading themselves through the few turns connected to the galvo. This current can now be adjusted to read some small (even) value, and the galvanometer needle brought to rest. If we then suddenly reverse the current by means of the reversing switch, all the lines

of force will be first taken out and then put in in the opposite direction. We therefore use the lines twice, and the value of the first swing of the galvanometer needle must be halved.

The current can now be increased and the operation repeated as many times as we please, taking note of the current flowing and the corresponding *half* deflection of galvanometer (first swing). Now we have to find out what these galvanometer readings mean in lines of force, and this is done with the standard magnet by allowing the coil of a known number of turns to cut through its field of a known number of lines of force. This gives us a swing of the galvanometer needle which enables us to calculate the others.

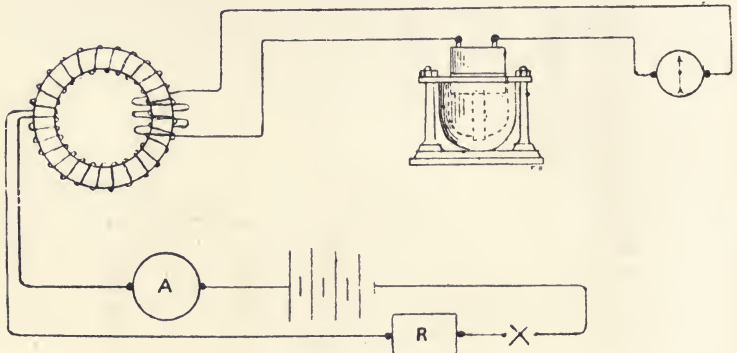

Fig. 98.

The first swings of the needle are proportional to the quantities of electricity urged through the galvanometer, and the quantity of electricity urged round the circuit in this way is proportional to $\frac{NT}{R}$, where N = total lines cut, T = total turns cutting N lines, and R = the resistance of the circuit.

Therefore quantity urged through galvo with standard magnet : quantity urged through galvo with iron ring and coil :: $\left(\frac{NT}{R}\right)$ for standard : $\left(\frac{NT}{R}\right)$ for iron ring and coil. But the first swing of the needle, which we will call d , is proportional to the quantity urged

through, and therefore d_s for standard : d_x for ring :: $\frac{N_s T_s}{R} : \frac{N_x T_x}{R}$, and with the circuit as arranged in Fig. 98, R is the same for both, and therefore cancels out, and we get $d_s : d_x :: N_s T_s : N_x T_x$.

Now both d_s and d_x are known, they being the first swings of the galvanometer for the standard, and for any of the values obtained with the iron ring. Also $N_s T_s$ and T_x are known values, being the known lines and turns of the standard and the turns of

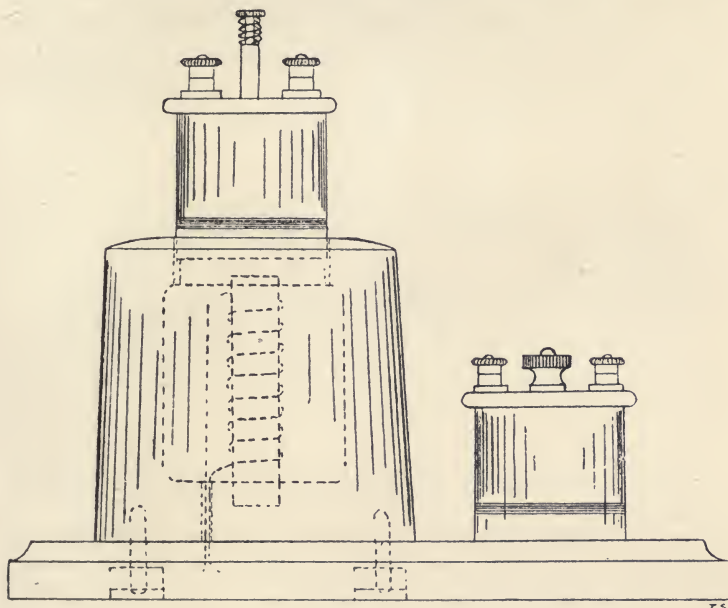

Fig. 99.

the small coil wound on the iron ring, and therefore the only unknown value is N_x , the lines in the ring, and $N_x = \frac{N_s T_s \times d_x}{T_x \times d_s}$, which can now be calculated for each value of the current used in the experiment.

B is got by dividing N_x by the sectional area in each case, and the permeability curve constructed as before, the corresponding value of H being obtained from $H = 1.25$ ampere turns per centimetre for each value of B .

The standard magnet here described is the invention of Mr W. Hibbert, and is most convenient for all such work. One of these has been in use at the Regent Street Polytechnic for over eight years, and absolutely no change in its strength can be detected, and therefore its constancy may be relied on. The instruments are usually provided with two coils, one of ten turns and the other of a hundred turns, which make it serviceable for almost any circuit or instrument. It gives us at any time, without trouble or delay, a definite quantity of electricity urged round any circuit in which it is connected, and this is immediately calculated when the resistance of the circuit is known. It therefore becomes exceedingly useful in many kinds of work as well as the one just described. A sketch of the instrument is given in Fig. 99.

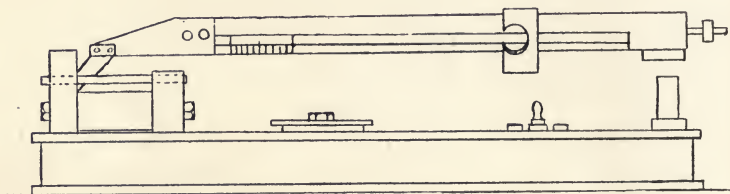

Fig. 100.

If such a standard is not available, we must construct a substitute. This can be done by taking a tube or rod of brass, wood, or other non-magnetic material, perfectly uniform in section, and winding it evenly and carefully from end to end with insulated wire. The length of the rod should be from 50 to 100 times its diameter. At the centre wind on a second coil of say twenty turns, which is to be connected in place of the standard magnet coil in the last experiment.

In using this standard, after obtaining the deflections with the iron ring and coil we must disconnect them from the battery circuit, and connect the battery and ammeter to the long coil of the standard. On now switching on the current we will get a certain number of lines through the second coil at the centre, with a corresponding swing of the galvanometer needle, and the lines of force passing through the coil at the centre can be calculated, for H ($= 1.25$ ampere turns per centimetre) and

the ampere turns per centimetre are known, and total lines = $H \times \text{sec. area}$ (see Chapter V.).

For workshop use, Professor Ewing has invented an instrument for determining the permeability of samples of iron in a very easy, quick, and practical manner. It is known as Ewing's magnetic balance (see Fig. 100). It consists of a long beam which is calibrated to read B direct by a sliding weight with index similar to those used in weighing machines. The beam turns on a fulcrum near one end, and directly under the short arm of the lever an electro-magnet is fixed with pole pieces, the one on the far side

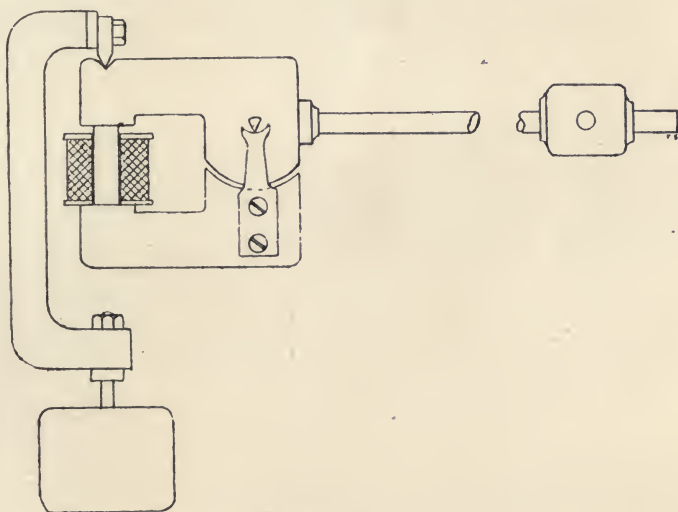

Fig. 101.

from the fulcrum being rounded on the top, while the other has a V groove. A standard sample of iron is supplied with the instrument to compare any other with, in the same way that a standard weight is used to compare with any other weight. The sample to be tested must be turned to the same dimensions as the standard, viz., 4 in. long by $\frac{1}{4}$ in. diameter. The end of the beam projects down on to the rounded pole piece, and is provided with a hole through which passes the standard piece of iron, the far end resting in the V groove. The sliding weight being adjusted to its right position for the standard, the current through the electro-magnet

is adjusted by a resistance till the beam breaks away from the pole piece. We then know that we have the right current for direct reading on the scale, this having been made with reference to the standard piece of iron. We now replace the standard by the sample to be tested, and keeping the current of the same strength, we adjust the position of the slider till the sample is just pulled off as in the case with the standard. The value of B for the sample is then read on the beam, and H is the same as for the standard which is given by the makers, and usually has a value = 20, for with this value the proportion will be practically the same throughout the whole working range.

A very similar instrument due to Fisher-Hinnen is shown in Fig. 101. The samples in this case are to be turned 1 in. in diameter and $3\frac{1}{2}$ in. long, care being taken to make the ends perfectly square.

In this case the sliding weight is fairly massive, viz., $14\frac{3}{4}$ lbs., while the balance weight w with its suspending arm resting on knife edges weighs $49\frac{1}{4}$ lbs. The scale on the beam is calibrated by placing known weights at w , and marking the positions of the slider where balance is obtained. A second scale is also engraved on the beam to be used with the higher values of B , and in this case the weight w is removed, thus enabling a short beam to be used over a wide range. The values of B corresponding to the marks on the scale are calculated from the formula—

$$\text{Pull in dynes} = \frac{B^2 \times \text{area in sq. cm.}}{8\pi}$$

One pound weight exerts a force of 981×453 dynes, therefore—

$$\text{Pull in pounds} = \frac{B^2 \times \text{area in sq. cm.}}{8\pi \times 981 \times 453}$$

If the area be measured in inches we must multiply the area in square centimetres by 6.45, the number of square centimetres to 1 sq. in., and we then get—

$$\text{Pull in pounds} = \frac{B^2 \times 6.45 \times \text{area in sq. in.}}{8\pi \times 981 \times 453}$$

$$\text{Therefore } B = \sqrt{\frac{\text{pull in pounds} \times 8\pi \times 981 \times 453}{\text{area in sq. in.} \times 6.45}}$$

$$\text{Therefore } B = 1317 \sqrt{\frac{\text{pull in pounds}}{\text{area in sq. in.}}}$$

The ammeter used with the instrument is often calibrated in

ampere turns per centimetre or per inch, for the turns in the coil being fixed, H varies directly with the current.

In practice the sample is inserted through the coil, and the short arm of the lever brought down to rest on the top. The slider is now placed to some particular mark on the scale, and a current sent through the coil. The current is then slowly decreased till the short arm of the lever breaks away, and B is read on one scale, and the ampere turns per centimetre on the ammeter. This can be repeated for any number of different values for B , and the permeability curve plotted from the results.

Another instrument for effecting the same thing is due to Professor S. P. Thompson (see Fig. 102). It consists of a block

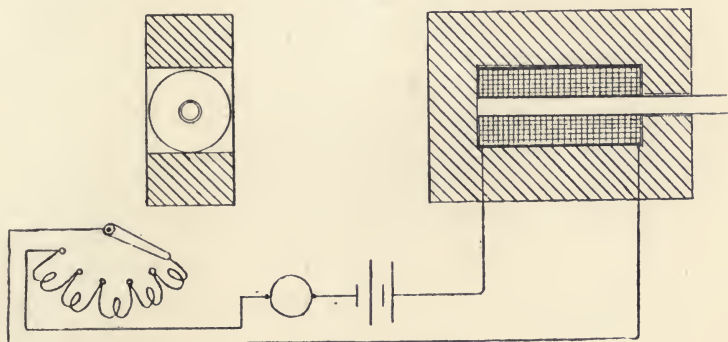

Fig. 102.

of soft iron, rectangular in shape, with the centre cut away, and a coil of known turns wound on a brass tube placed in the centre. A hole the same size as the bore of the brass tube is drilled through the top, and the rod of the iron to be tested, after being turned to fit the hole, and made perfectly square at its lower end, is inserted in the coil so as to rest on the iron block. A current is now sent through the coil, and the pull required to drag the core from its seating on the block is read on a spring balance fixed to its outer end. The current is adjusted in strength, and read on an ammeter in series with the coil, and therefore the ampere turns per centimetre are easily calculated for any values of the pull, and B is calculated as before. These methods are not so accurate as those described earlier, but are often quite accurate enough for commercial purposes.

CHAPTER XIII.

ARC LAMPS.

VERY many arc lamps have been devised since the day when Sir Humphry Davy struck the first arc between two pieces of gas carbon using a large battery of primary cells. The carbons in this case and in many of the following lamps were arranged horizontally, and the current of heated air which arose when the arc was struck caused the glowing carbon vapour which constitutes the arc to arch over from one carbon to the other, whence the name arc. In all modern lamps the carbons are arranged more or less in a vertical position, and the glowing carbon vapour in them has no tendency to arch.

Many of the early arc lamps are extremely interesting, and show a high degree of ingenuity on the part of the inventors. It is not our object, however, to study the history of the subject, but to get a knowledge of the principles underlying the whole, and of certain typical lamps to be found in successful and extensive use at the present time.

All arc lamps of the same type have to do practically the same operations, and the differences in construction are simply different mechanical devices for obtaining the same result. The essentials of them all are, first, they must allow the carbons to come into contact when the current through them is interrupted or cut off; second, they must strike the arc immediately the current is switched on, that is, they must contain some arrangement for separating the carbons when the current is switched on; and third, they must feed the carbons together as they burn away, and so maintain the arc at a constant length.

Arc lamps can be divided into two classes—open and enclosed. The former being the older of the two, will be considered first.

To work well these lamps require a potential difference on

their terminals of from 45 to 50 volts, and unlike the smaller well-known incandescent lamps, they cannot be made to work at all with a less pressure than 39 volts. The current required by any lamp depends on its size, and if the current be large, the carbons employed must also be thicker.

The carbons slowly burn away, and the + carbon, or the one by which the current is led into the arc, burns away practically twice as fast as the other, and therefore some arrangement must be made for feeding one faster than the other. The arrangement commonly adopted is to make the + carbon twice the sectional area of the - carbon. The arc is usually about $\frac{3}{16}$ in. in length, and this constitutes the principal resistance of the lamp, consequently at the moment of switching on a much larger current than the normal will flow till the arc is struck.

Nearly all the light from the arc comes from the intensely white hot crater formed in the end of the positive carbon. The heat at this part is exceedingly intense, measured in thousands of degrees. It is in fact the most intense heat obtainable up to the present, and many substances which cannot be melted in any other way are easily and readily reduced when placed in the arc. This has led to its application for the production of aluminium, carborundum, calcium carbide, &c.

The negative carbon burns away and forms a point at the end, this being made white hot, principally by being roasted, as it were, in the intense heat of the positive crater. The end of the positive carbon burns cone-shaped also, due to the air coming into contact with the outer edges. The appearance of the direct current arc is shown in Fig. 110. We shall consider the modifications due to alternating currents later.

Arc lamps can be run either in series or parallel, providing the necessary precautions be taken. The current through most arc lamps is usually eight or ten times that required for an incandescent lamp of 32 candle-power, and consequently if we have many in parallel the cables required become excessively large. This has led to the practice of putting ten or more lamps in series, for then the cables need only be large enough to carry the current for one lamp, but the e.m.f. has to be ten times that required for one lamp.

In either case we must consider certain details if the lamps are to work well. In the parallel arrangement it will not do to

run our mains at 50 volts and join all the lamps across, for they would be very unsteady, giving an unpleasant fluctuating light. The reason for this is easily seen if we consider a single lamp. The resistance of the lamp being principally that of the arc, this constitutes the principal resistance of the circuit. Now, should one of many possible things occur to cause a slight alteration in the arc, the current will alter accordingly, and as we have already seen, the heating effect will alter as the square of the current, if other things remain unchanged, consequently any slight irregularities in the burning are very marked, and the lamp burns unsteadily.

But suppose we run our mains at say 70 volts, and the power taken by the lamp be 10 amperes at 50 volts, then we must expend 200 watts on a resistance in series with the lamp. This resistance must be able to carry 10 amperes without overmuch heat, and with that current cause a fall in potential on it of 20 volts. Its resistance must therefore be $\frac{20}{10} = 2$ ohms. If now we get the same slight irregularities in the arc, the total resistance of the circuit is not materially altered, for the arc forms only a portion of the total resistance, and to produce the same variations in current strength as in the preceding case without the resistance in series, the arc would have to vary very much more. The arc therefore burns with a much steadier light with this resistance in series, but we only get it by an expenditure of energy in the resistance, for which we get no return, except in the steadier burning of the lamp. This resistance is known as a steadying resistance.

In the case of a 100 volt circuit two lamps may be put in series without a steadying resistance, in which case we waste no power but the lamps do not work quite so steadily as with the steadying resistance, for though one lamp forms as it were a steadying resistance to the other, it often happens that both lamps vary slightly in the same way at the same time, and the special devices necessary for series lamps must be also provided with them.

If we have a number working in series, no steadying resistance is necessary, for any slight alteration in the arc of one lamp causes no appreciable alteration in the current, for the total resistance of the circuit is ten times (if ten lamps be in series) that of one lamp. But we must now provide against another possible contingency, viz., the possibility of one lamp sticking and the arc burning to

such a length that it can no longer be maintained, in which case it, together with the whole number in series, would go out. In a series arrangement of arc lamps it is therefore necessary to provide some automatic cut out which will come into operation whenever the resistance of any lamp exceeds a certain prearranged value, and

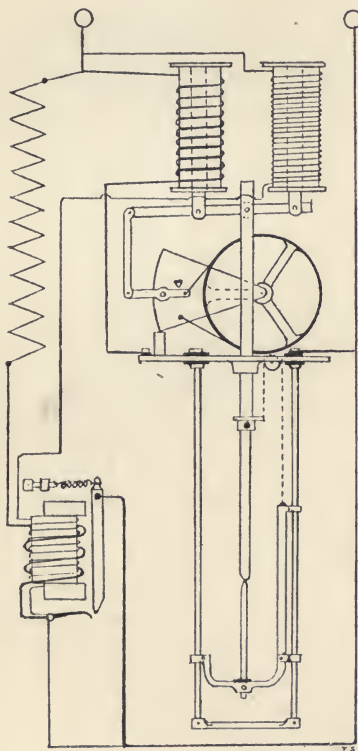

Fig. 103.

also an additional coil is necessary for feeding the carbons, as will be seen almost immediately.

Evidently if the carbons burn away at a rate depending on the current through the arc, the best way of controlling the length of the arc would be by the arc lamp current rather than by clock-work or any similar device, and this is now the universal plan adopted.

Let us first consider the simplest case of an arc lamp intended for parallel running.

Fig. 103 shows a diagram of an arc lamp to be found in fairly extensive use, distorted in places so as to show the relation between the various parts more clearly. This lamp in its completed form is known as the Brockie-Pell, and the mechanism there employed will serve to illustrate the action of all lamps of this type.

Here the circuit, starting at the left-hand terminal, passes round the series coil, wound with a few turns of thick wire, and then to the framework of the lamp, and so to the top carbon holder which is in electrical connection with the framework. From here the circuit is completed through the carbons to the lower carbon holder, which is held in guides insulated from the frame, and from this to the second terminal. The upper and lower carbon holders are connected by an insulating cord, so that as the top carbon holder rises the lower one falls, but the top carbon and holder being the heavier of the two, causes the two carbons always to run together when no current flows in the lamp circuit.

The top carbon holder is provided with a rack into which gears a pinion, and to the same pinion spindle is fixed the brake wheel, and therefore the top carbon holder cannot move up or down without turning the brake wheel. When no current flows this wheel is quite free to move, and consequently the carbons always run together, but when a current is switched on, which will be large while the carbons are together, we get a strong pull upwards of the iron core in the coil, and a corresponding pull on the levers attached to it, which causes the band to grip the rim of the wheel, and the whole is turned through a small angle, thus separating the carbons and striking the arc. The movement need not be great, for if the top carbon be lifted $\frac{1}{16}$ in., the lower carbon falls to an equal degree. The small brass sector, to which one end of the band brake is fixed, is centred on the pinion spindle, but is not fixed to it, its movement being quite independent of the movement of the pinion and brake wheel. When no current is flowing the weight of this sector is carried by a stop, which thus takes the brake off the wheel.

We will now imagine that a current is switched on. Immediately the lever is drawn up by the iron core, the band grips the brake wheel and raises it, the carbons separate, and the arc is struck, with a diminution in current in consequence. But now in

a short time the arc will increase in length owing to the carbons burning away, and the arc lamp is required to feed the carbons together as they burn. As the arc increases in length, so the resistance of the lamp increases, and consequently the smaller the current becomes with a corresponding diminution in the pull of the coil on the iron core. This causes the iron core to drop slowly, and with it the sector, brake wheel, and upper carbon, the lower carbon rising to an equal degree. A point is soon reached in this way when the sector is in contact with the stop, and now it can fall no further; but as the iron core continues to fall the band is slackened until the brake wheel is on the point of slipping, and this is the normal working point for the lamp. Should the arc now increase in length slightly, the band is slackened somewhat, and the brake wheel slips a trifle. If it goes too far, the band again grips the brake wheel, and the whole is raised slightly. Therefore when burning normally, the brake wheel is constantly and almost imperceptibly on the move, feeding the carbons as the arc burns, and still constantly adjusting the length of the arc, keeping it practically the same throughout.

It will therefore be seen that the variations in the current strength caused by variations in the length of the arc are made to regulate the feeding of the lamp, and on parallel circuits, when provided with a steady resistance, this is all that is required.

If it is to be used in series with others, however, we must provide a second coil, which, though not absolutely necessary for parallel working, is often provided in that case as well, for it will work equally well in parallel with this addition, and the lamps are then suitable for either parallel or series working. This coil is wound with fine wire so as to have a high resistance compared with that of the series coil, and is connected direct across the lamp terminals. A second iron core, attached to the first by a rocking lever or see-saw, is provided in this shunt circuit coil, so that as one core is drawn up the other must come down, as shown in Fig. 103.

We now have in the lamp two circuits in parallel, and in such circuits the current always divides inversely proportional to the resistance of the parts, and therefore we now get a control of the arc even though the main current be practically constant in strength. We have already seen that in a series arrangement the alteration in the length of the arc in one lamp, even through a

considerable range, does not materially affect the value of the current, as it forms but a small fraction of the total resistance of the circuit, but being provided with the shunt coil for feeding, each lamp in the series is independent of the remainder. For simplicity, we can imagine the current in the main circuit to be quite constant and equal to say 10 amperes. When the carbons are in contact the resistance of this part of the circuit will be very much less than that of the shunt circuit, consequently almost the whole of the 10 amperes takes the path through the carbons and series coil, and we get a strong pull on the core in this coil, which separates the carbons and strikes the arc. But immediately the arc is struck a resistance is introduced into this part of the circuit, and consequently less current flows through the series circuit and more through the shunt, and the two cores adjust themselves in the two coils, till a balance is obtained between the pull of the series coil and that of the shunt coil. If the arc increases in length, it would not alter the pull of the series coil if it were alone, but now, owing to the increased resistance in the series circuit, the supposed same strength current divides itself between the series and shunt circuits in inverse proportion to their resistances, and consequently a smaller fraction than before goes through the series coil and a correspondingly larger current through the shunt coil, with the necessary alteration in the pull on the cores of the two coils. The pull on the shunt coil core being greater and that of the series coil core less, both help to shorten the length of the arc, and so keep it at constant length. The cores are prevented from moving with a sudden or jumpy action by providing one or both with a dash-pot.

There is still another point to be considered. Should one lamp in the series get out of order, and the arc increase in length very considerably, it will eventually go out, and break the circuit of the remaining lamps, thus putting the whole series out. To prevent this an automatic short circuit must be provided with each lamp, and connected in its shunt circuit, so as to cut out the lamp and put into the circuit an equivalent resistance, should such occur. This can be made separately and connected up in any convenient place, or can be placed inside the lamp itself as a permanent addition. To illustrate the action, consider the arrangement shown in Figs. 103 and 104. Into the shunt circuit is placed a small electro-magnet with pole pieces and an iron-armature. The latter

is held off and out of contact with an insulated stud by an adjustable spring. As the arc increases in length, the current through the shunt circuit increases, and so the pull on the armature increases, till a point is reached where the armature flies over and comes into contact with the stud, both of which should be tipped with platinum at the point of contact to prevent corrosion and bad contact. When this occurs we have another circuit completed through the lamp, viz., from T_1 through a resistance to terminal T_2 , and consequently the current through the shunt circuit would

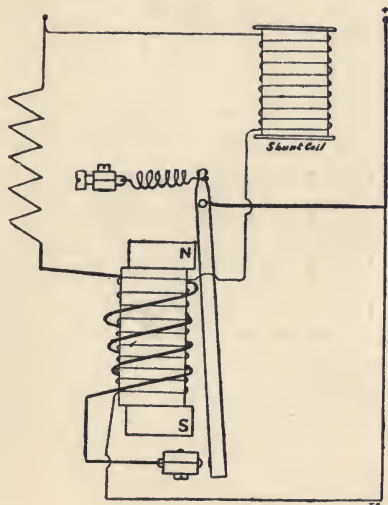

Fig. 104.

again diminish considerably immediately contact was made between the armature and the stud, and the armature would be released, only to be again attracted a moment later, like the armature of a trembling electric bell. To prevent this, the current that flows through the resistance when the contact is made is also led a few times round the electro-magnet, which effectually holds the armature in contact. The point where the automatic cut-out shall come into action (which should in every case be before the lamp actually goes out) can be regulated by adjusting the tension on the armature spring.

A better form of this instrument which has been found to work very satisfactorily in practice is shown in Fig. 105. The shunt circuit coil is here wound on a hollow bobbin of brass fixed to one side of a slate base plate, the ends being furnished with thick cover plates. Through the lower end plate an adjusting screw passes which controls the position of a short rod of iron inside the coil. Through the upper end plate a brass pin is free to move, but is prevented from falling through the coil by a small pin being inserted in a hole near its upper end. On the top of this brass pin rests the end of a lever, held down by the force of

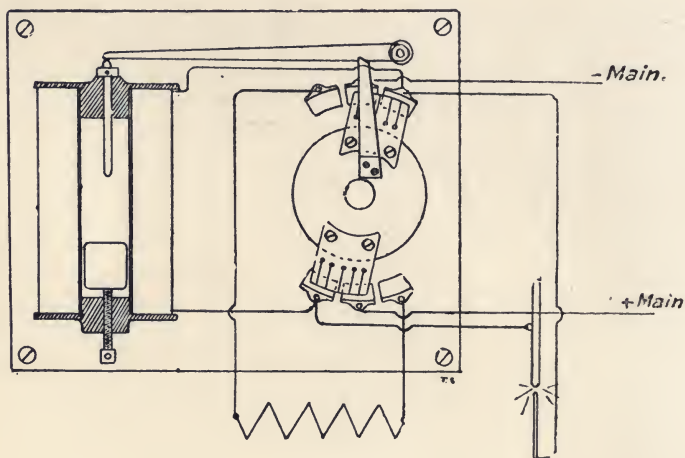

Fig. 105.

gravity, and also with a small spring. Near the centre of the base an insulating ring is arranged so as to be free to rotate through a small angle, and a spring at the centre is adjusted to hold it normally hard over, in the anti-clockwise sense. Fixed to this disc are two wide switch contacts which are arranged to slide over six contacts fixed to the slate base, and each is wide enough to short circuit two of them. The mains are connected to the two centre contacts, while the arc lamp is connected between the left-hand lower and right-hand upper contacts, the coil being also joined to these same two points, and therefore forms a shunt on the lamp. To the other outer contact

a resistance equal to that of the lamp when burning normally is fixed, as shown, but is usually a separate piece of apparatus wound on some insulating fireproof material such as porcelain. To the insulating disc which carries the moving contacts is also attached a lever, the upper end of which engages in a notch in the top lever when it is pulled into that position, and so keeps the switch in the position shown against the action of its spring, which would if free pull it over to the other side.

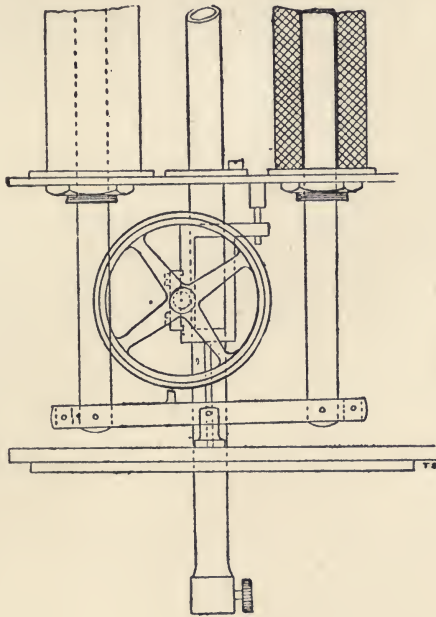

Fig. 106.

If now anything should go wrong with the arc lamp, the current in the shunt coil would increase till it reached a point where it would suddenly pull up the block of iron inside it, and this striking the brass pin, would raise the lever resting on it, and release the switch lever, which would immediately fly over to the other side, and so break the arc lamp circuit, and connect the resistance on to the mains in its place. This is more certain in its action than the form described previously, for it has rubbing

contacts which make a much better connection than a simple touching contact. It is adjusted by means of the screw at the lower end of the coil, which adjusts the position of the iron core. The whole is enclosed in a dust and damp proof iron case, and is often fixed in the base of the arc lamp post, the conductors being taken through holes with insulating bushes, which are then made watertight with marine glue.

Messrs Crompton & Co. make a very good lamp, known as the "Crompton-Pochin," a view of the working parts of which is given in Fig. 106. In this there are two brake wheels, one on either side of the racked carbon holder, and the spindle carrying them and the pinion wheel runs in bearings formed in a small brass block which is free to slide up or down the carbon holder, but of course causing the brake wheels to spin round in so moving. When the series core is attracted by the current in the series coil a pin is brought into contact with each brake wheel, and the further upward movement of the core carries the brake wheels and upper carbon holder bodily, for if the brake wheels cannot spin round the small brass block cannot move up or down the rack rod. In this way the arc is struck, and the whole again descends for feeding, until the brass block carrying the brake wheels comes into contact with a small pin rising from the base. If the series coil now releases its hold on the core still further, the brake pin also releases its hold on the brake wheels, which therefore begin to slip, and the feeding and regulating goes on as described in the case of the Brockie-Pell arc lamp.

Of late years another type of lamp has come into very extensive use, known as the "enclosed" arc lamp, from the fact that the arc is more or less enclosed in a space where access to the air is restricted. The immediate consequence of this is that in a short time after the arc is struck the whole of the oxygen in the enclosure is converted into carbon monoxide gas, which is unable to support further combustion. The carbons then slowly volatilise, and the arc is maintained across the heated carbon vapour. The result of not burning is that the carbons last a very much longer time than in the open type, and this constitutes its chief advantage.

The lamps are not made air-tight, for such an arrangement would be difficult to maintain. It has been accomplished, however, in certain lamps intended for submarine illumination, but is not at all necessary for ordinary work. The access of air is

more carefully restricted about the bottom carbon only, and the heavier carbon monoxide gas formed prevents ingress of air except for any slight amount due to diffusion.

Owing to there being practically no burning of the carbons we can employ a much longer arc than is workable in the open type with a correspondingly higher difference of potential on the lamp terminals. Thus on a 100 volt circuit about 75 volts can be used on the arc, and the remaining 25 volts on the steadying resistance. It is owing to the non-burning of the carbons that they remain practically flat at the ends, instead of the pointed negative and coned positive in the open type.

For a given power these lamps give rather less light than the open form, but as the carbons last such a much longer time (roughly ten times as long), much less attention in trimming and fewer carbons are necessary. But it must be remembered that only carbons of the very first quality will do for enclosed arcs. If certain cheaper carbons (which may give very good results in an open lamp) be used in an enclosed, it is found that after a few hours' run a thick white coating, composed chiefly of silica, has deposited itself over the inner surface of the enclosure,

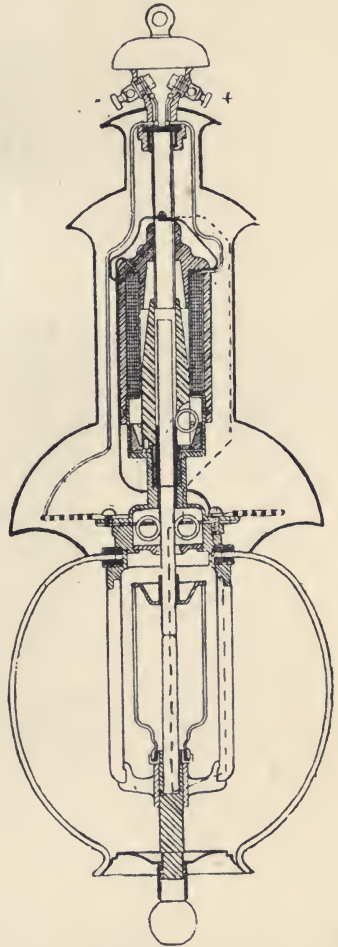

Fig. 107.

which absorbs a large proportion of the light. Therefore there

is not so very much saving in the actual cost of the carbons, but the cost of attention and trimming is largely reduced.

Many of these lamps are provided with the necessary steadying resistance inside the case, so that they may be put direct on to the

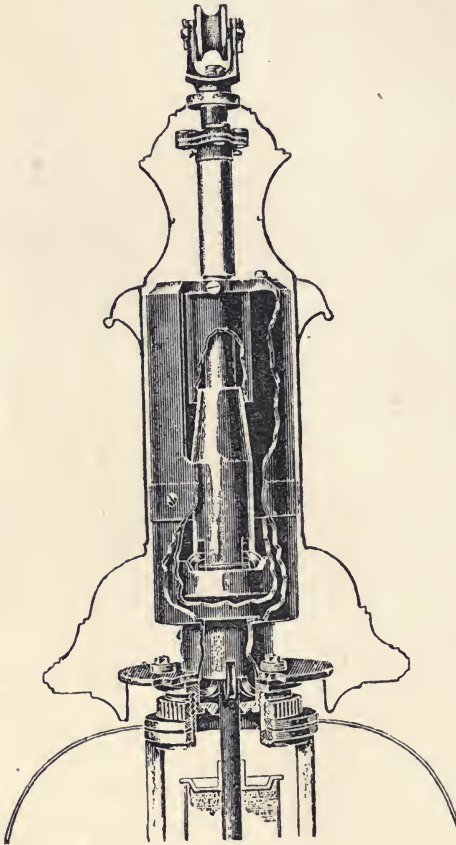

Fig. 108.

mains at 100 or even 200 volts. The length of the arc in the former case is about $\frac{5}{8}$ in., maintained by a potential difference of about 75 volts, while in the latter case the arc often reaches $1\frac{1}{2}$ in. in length with a potential difference of 150 volts on the arc.

One of the first lamps of this type, and one still extensively

employed, is known as the "Jandus." There are, however, many others on the market, and the number is steadily increasing, almost every arc lamp maker selling both the open and enclosed types.

A very good view of this lamp, from Fowler's Electrical Engineer's Year Book, is given in Figs. 107 and 108, from which it will be seen that only one core is provided, the series and shunt coils being wound differentially (*i.e.*, in opposite directions) on the same bobbin. The iron core is consequently magnetised and attracted by the current in the series coil, but as the arc increases in length, and the current in the shunt coil is thereby increased, the field inside the coil and in the iron core is diminished in intensity and the lamp feeds. To understand this action properly it will be necessary to explain its construction and the method of applying the brake.

The series and shunt coils are wound on formers so as to fit inside the upper iron pole piece, which is turned slightly taper on the inside and fixed to the brass tube in the centre. It is thus surrounded by iron on the outside, while the iron core partly completes the magnetic circuit on the inside, being turned at the top end to the same taper as the pole piece. To the lower end of the pole piece is screwed a dish-shaped piece of iron, square on the outer walls, as seen in the section. This fits easily in the brass box in which it moves, and the upper end of the box is fixed with screws to the lower end of the upper pole piece. This forms a very effective dash-pot, the lower iron pole piece attached to the core acting as a piston in the brass cylinder. Into the lower end of the iron core three grooves are cut through, wide enough to admit of three rings, one of them being seen in the section. Other grooved rings are pivoted lower down, and form guides for the upper carbon. The lower carbon is supported in a holder, held in its place by four brass arms, which grip a framework of brass supported by two rods from the top. By giving a quarter turn to the knob at the extreme lower end of the lamp this holder is released, together with the inverted sheet-iron dish, which closes the opening in the outer glass globe at the bottom, and the lower carbon holder and inner glass chimney with its loosely fitting cast-iron cover can be withdrawn from the lamp for cleaning and renewing the carbons.

The upper carbon is usually twice the length of the lower one,

and fits tightly into a thin brass tube at its upper end. This is free to run up and down between the guide rings and the clutch wheels.

When a current is switched on the iron armature is drawn up, together with the box at its lower end, in its endeavour to complete the magnetic circuit, and the clutch rings, rolling on the inclined plane of the box, grip the upper carbon holder, and the whole is thus raised bodily. When the resistance increases, owing to the arc increasing in length, a larger current flows through the shunt coil, and the core is partially demagnetised, which causes it to move down slowly, and the rings release their grip of the carbon holder slightly and allow it to slip, and in this way the automatic regulation of the feed is accomplished.

Fig. 109 represents another lamp, known as the "ark" lamp, made by Messrs Johnson & Philips. It is extremely simple in construction and strongly made. For parallel working it contains only one coil in series with the arc, and a resistance is included inside the case to enable it to be put direct on to mains at 100 volts or higher if necessary.

There is no upper carbon holder of any kind, the clutch gripping the carbon rod direct. The current is led into the carbon by four small copper connectors, which make contact by being pivoted to one side of the centre of gravity. This causes them to press gently but firmly against the carbon rod, and yet allows of its free movement under the action of the clutch above. This, together with the clutch, is clearly seen in the section (Fig. 109).

The clutch consists of four pieces of brass, pivoted at their lower ends to a loose brass plate. These are connected to the movable iron pole piece by means of pins which press on the inclined surfaces of the clutch cams. When the core is raised, these pins press the cams inwards, and cause them to clutch the upper carbon. The whole is then moved up bodily, and the arc struck.

As the carbons burn away the iron core falls, and with it the carbon rod, till finally the loose brass plate to which the clutch cams are pivoted rests on the framework of the lamp. The further downward movement of the core now releases the grip of the clutch cams and the upper carbon begins to slip, and so the feed is regulated.

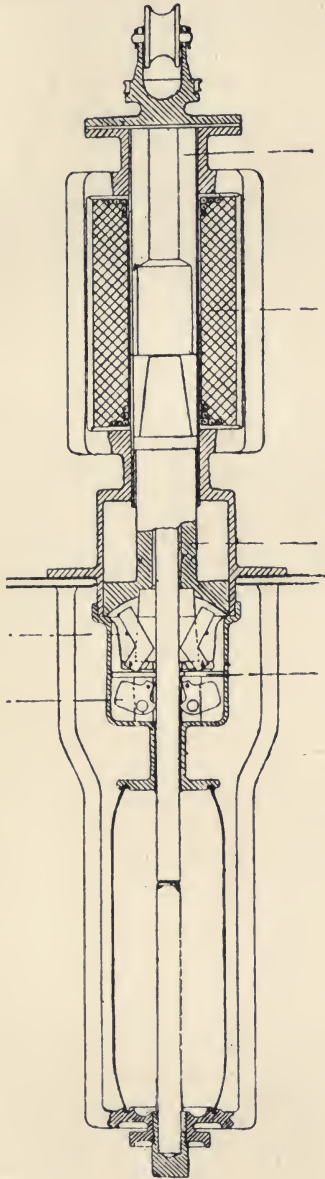

Fig. 109.

The carbons for these lamps are provided with a deep groove near the upper end, so that when they are nearly exhausted the contact pieces engage in the groove, and prevent the further feeding of the carbons.

The lower carbon fits into a substantial holder which can be screwed into and out of an insulated support. A narrow opalescent glass cylinder surrounds the arc, and is pressed between two asbestos washers by screwing in the bottom carbon holder. The lamp is also provided with an opalescent outer globe of large size, conical in section. The resistance coil is wound on a frame of insulating material notched on the outer edge, and surrounds the box containing the iron core. This box is bored to take the enlarged end of the iron core, which therefore acts as a dash-pot.

The one strong point in its favour is its extreme simplicity, the number of moving parts having been reduced to a minimum. The whole lamp is of very solid and durable construction, and strength and rigidity are secured by making the lamp frame in one casting.

With the open type arc lamp the positive carbon becomes slightly coned near the end, while at the extreme end a crater is formed, the size of which depends on the current. The negative carbon burns to a point, and thus allows a certain proportion of the intense light from the surface of the crater to radiate into the surrounding space. With the enclosed arc the carbons remain practically square at the ends, and consequently the lower carbon would, with the same length arc, cut off a large proportion of the light, but this is counteracted by the greater length of arc employed. Figs. 110 and 111 show the outline of the carbons in an open and enclosed arc respectively.

The greater we make the length of the arc, the wider will be the zone of light having maximum illumination. But the arc can only be increased in length by expending on it a larger amount of energy. The remaining space is illuminated by diffusion. With a naked arc, this zone of light round the arc is much more marked than when an opalescent globe is employed. In the open type, with its relatively short arc, some part of the crater surface is always cut off by the tip of the negative carbon, whatever point it be viewed from; but with the enclosed arc, owing to the longer length employed and the small depth of the crater, the whole of the crater surface is visible through a wide angle, and we therefore

get a better distribution of the light with the long enclosed arc. The maximum intensity of light from an open arc lamp is at an angle of about 40° from the horizontal, and $\frac{8}{10}$ of the light is included between 30° and 50° . With the enclosed arc we get the maximum light at an angle of about 55° , while $\frac{8}{10}$ of the light is included between 25° and 60° , but the maximum illumination for a given power for the enclosed is less than for the open type. From figures published by Elihu Thomson we get—

| | | |
|---------------------------------------|---|-------|
| Watts per candle-power with naked arc | = | .5 |
| " " enclosed arc | | = 1.5 |

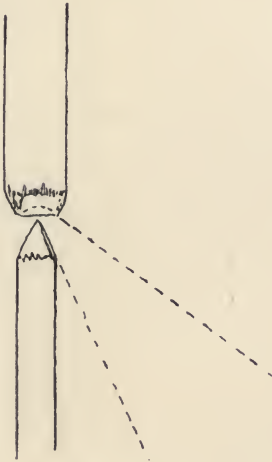

Fig. 110.

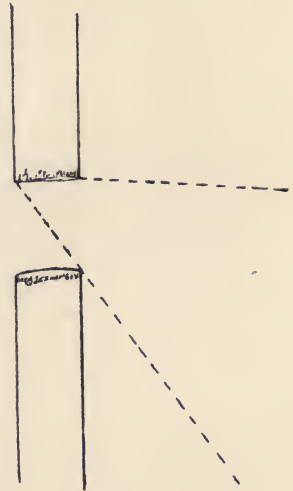

Fig. 111.

But in practice naked arcs are not employed, and with the opalescent globe we should get an efficiency of about .75 watt per candle-power, or half as much energy as is spent on the enclosed arc.

Owing to the carbons lasting a much longer time in the enclosed, there is a tendency to neglect the lamps till they require fresh carbons, and the outer and inner globes becoming coated more or less thickly with silicious deposit, cut off more and more of the light, till the efficiency may fall off to 3 watts per candle-power or even more. If this is to be avoided, the globes must be

regularly cleaned, which takes away the chief advantage of the enclosed arc, for it involves very little extra work to replace the carbons while the lamp is open for cleaning.

In the direct current open type arc lamp the arc burns very steadily once a proper crater is formed, and with a well-made modern lamp the feed is practically continuous, and little or no fluctuation in the light is noticeable. With the enclosed lamp, however, the arc is very unsteady, wandering round the edges and over the faces of the carbon ends, giving a flickering and unsteady light; so much so that both the inner and outer enclosing globes have to be made of opalescent glass in some cases, especially where a steady light is essential.

If the current be increased beyond a certain value for any given size carbons, or if we reduce the length of the arc beyond a certain point, the arc makes a peculiar hissing noise, and the light given suddenly diminishes considerably. This is accompanied by a fall in the potential difference on the lamp, and the hissing continues more or less irregularly till the arc has increased in length or the current diminished.

Mrs Ayrton has thoroughly investigated this phenomenon, and from the results of her experiments, which were published in the *Journal of the Institute of Electrical Engineers* in 1895, it would seem that the effect is due to the crater increasing in area as the current increases, till it finally breaks out at the side of the carbon. Air now having access to the crater, gives rise to the drop in potential and the hissing noise. Fig. 112 is a reproduction of a curve, one of a series given by Mrs Ayrton, showing the drop in potential and the point where hissing begins as the current is increased in an arc of 4 mm. length.

A direct current arc cannot be maintained under 39 volts, and an alternating arc under 33 volts, and this fact, together with others, has led to the belief that the arc gives rise to a back e.m.f., but this has been challenged, and contradicted by some able experimenters. It is certain, however, that the arc does not behave as an ordinary conductor, but more like an electrolytic one, for the resistance of the arc is not at all proportional to its length. When the potential difference is measured between the positive carbon and a point in the arc a little way from the crater, by means of a thin carbon rod inserted in the arc, a large potential difference is found to exist, while from this point to the

negative carbon only a slight potential difference can be detected, even though the length of arc in the latter case be much greater than in the former case, and therefore the e.m.f., which in ordinary conductors falls proportional to the resistance, does not fall proportional to the length of the arc. Again, any alteration in the length of the arc does not give rise to a corresponding change in the strength of the current.

The cause of a back e.m.f. is explained by some as being due to the carbon vapour formed in the crater condensing again on the negative carbon, there giving back the latent energy of vaporisation, and so creating the back e.m.f. The question of the back e.m.f. in the arc, however, has long been and still is an unsolved

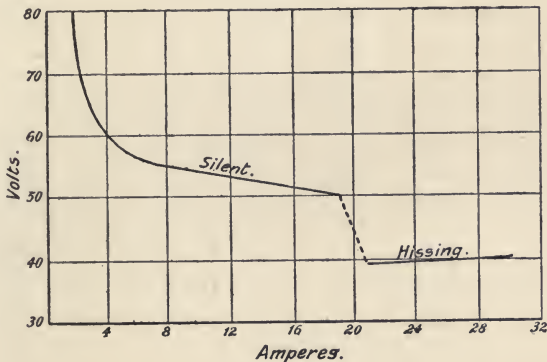

Fig. 112.

problem, the balance of evidence being for its existence; but whether it be so or not does not affect the working or efficiency of the lamp other than limiting the working potential difference, though if the source and nature of the back e.m.f. were proved, it might lead to some important results.

The positive carbon is often made with a core of softer carbon having a lower specific resistance. This not only lowers the resistance of the lamp, but assists in the formation of a good crater, and so ensures steadier and better burning.

The light given by an arc lamp emanating from so small an area gives rise to very dense shadows which are often objectionable. The opalescent globe, if large in diameter, overcomes this to a certain extent, for the light then emanates from a body of much

larger area, and the shadow cast by one portion of the globe is therefore illuminated by the light from other portions. But as has been pointed out, these opalescent globes absorb a large proportion of the light, as much as 30 per cent., where good diffusion is required. This will readily be believed when the illumination through a hole accidentally made in the globe be compared with a similar area with the globe intervening.

With alternating currents both carbons burn at the same rate, and both become pointed. We therefore lose the great illuminating property of the crater in the direct current arc. Furthermore, the light given by the alternating current arc is thrown upwards as much as downwards, and therefore unless a reflector be employed, a large amount of the light is lost.

The carbons for these are always of the same diameter, and practically the same length, except in the enclosed, where the upper carbon is often twice the length of the lower one. In this case, when the lower carbon has burnt out, the upper one has only half burnt out, and can therefore be used for the lower carbon, and a new one of twice its length put in its place. In this way only one size of carbon is required.

All the iron parts in the lamp mechanism when used on alternating current circuits must be made of laminated or subdivided iron, the laminations being along the direction of the lines of force passing through the iron, *not* at right angles to them, so as to prevent eddy currents being induced in the iron cores and pole pieces (see Chapter XV., page 259). The coils must also be wound appropriately, for we must make allowance for what is called the inductance of the circuit as well as the resistance when using alternating currents, and we therefore do not get the same magnetic effect with a given number of ampere turns when using an alternating current as when a direct current is used. The e.m.f. on the ends of the coil urging the current through it is now not equal to $c \times R$, but is equal to $E = c \times \sqrt{R^2 + (2\pi nL)^2}$, where R is the resistance of the circuit and $(2\pi nL)$ is the inductance of the coil, n being the number of alternations made by the current in one second, and L the coefficient of self-induction of the coil, and is equal to

total interlinkings of lines and turns created by absolute unit current

and is always a small fraction. A much smaller density must also be employed in alternating magnetic fields, and therefore larger cores used (see Chapter VI., page 90).

This will probably be unintelligible to the student at this stage, but the consideration of all such problems must be left for the next year's course. It will, however, serve to show that with alternating currents the considerations in the design of the various pieces of apparatus are often very different from those employed in direct current work, and this alteration in the design is necessary

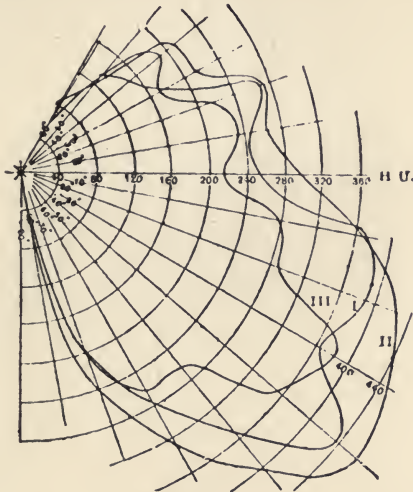

Fig. 113.

- I. Lower Carbon, $1\frac{1}{4}$ in. long. II. Lower Carbon, $3\frac{3}{4}$ in. long.
 III. Lower Carbon, $4\frac{3}{4}$ in. long.

with an arc lamp. Therefore an arc lamp will not serve equally well for both alternating and direct current circuits, but is made for one or the other.

The light given by an alternating arc lamp, even when a reflector is used, is inferior to that given by a direct current arc using the same power. Professor Elihu Thomson gives the efficiency of naked alternating current arc lamps as follows:—

Alternating current arc without reflector = 1.12 watts per c.p.

Alternating current arc with reflector = .8 watt per c.p.

against the .5 watt per candle-power for the direct current arc.

The alternating arc makes a humming noise when working, due among other things to molecular vibration in the iron cores and the heated vapour in the arc. This is very marked in a large size lamp carrying a large current. The pitch of the humming depends on the frequency of alternation, and this averages from 50 to 100 in England, with a tendency to decrease rather than increase.

The results of a series of tests made on enclosed arc lamps by the National Electric Light Association Committee of America are shown in the curves, Figs. 113 to 117. The first, Fig. 113, shows

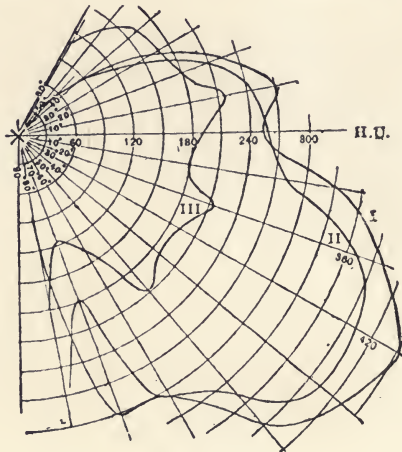

Fig. 114.

- I. Opal Inner, no Outer. II. Opal Inner, Clear Outer.
 III. Opal Inner, Opal Outer. Direct Current.

the influence of change in position of the arc inside the opalescent globe, from which it appears that most light is obtained with the arc at the mid-point in the globe.

In Fig. 114 the effect of the clear outer globe is distinctly seen. It absorbs a certain amount of light, and gives a little better diffusion, while the opalescent outer absorbs a large proportion of light, but gives a diffusion practically constant over a very large area.

The wavy outline of all the curves where opalescent globes are employed is due to the variations in the glass itself, for they vary largely at different parts both in thickness and translucency.

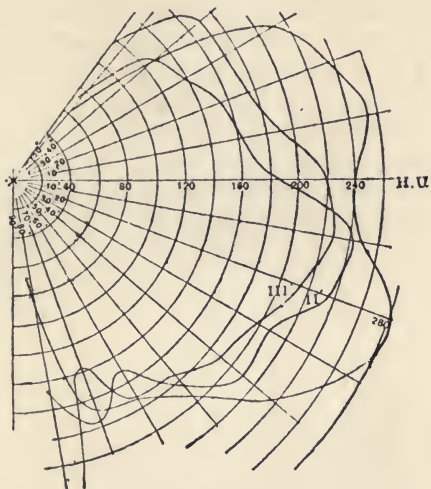

Fig. 115.

- I. Clear Outer, Opal Inner. II. Clear Outer, after 106 hours.
 III. Opal Outer, Opal Inner. Direct Current.

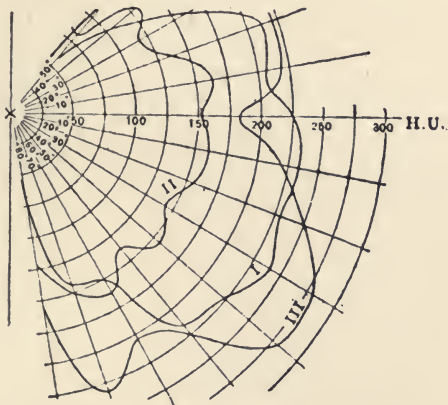

Fig. 116.

- I. Clear Outer, Opal Inner. II. Opal Outer, Opal Inner.
 III. Clear Outer, Opal Inner, coated after 70 hours.
 Alternating Current.

Fig. 115 shows the absorption of light in a continuous current enclosed lamp after 106 hours burning, which amounts to 16.6 per cent., while Fig. 116 shows the light obtained from an alternating current lamp after 70 hours burning, which in this case has increased. This is due to the arc burning to the centre of the globe after 70 hours, and thereby giving a greater percentage light than that absorbed by the ash formed in the same period, and therefore probably the same effect would be obtained with the direct current lamp in the same time.

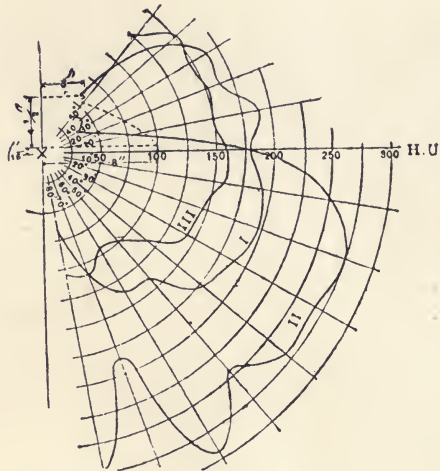

Fig. 117.

I. Clear Outer, Opal Inner. II. Clear Outer, with Shade.
 III. Opal Outer, Opal Inner, no Shade. Alternating Current.

The effect of a shade on the alternating current lamp is clearly shown in Fig. 117, and for outdoor illumination the efficiency of the alternating current lamp is greatly improved by the use of a shade or reflector. The shape of the shade is here shown dotted, its curvature being well chosen for the purpose. The lower edge of the shade normally stands about $\frac{1}{2}$ in. above the arc when the arc is in its lowest position.

In these curves the light is given in "Hefner" units. To convert these to English candle-power we must divide them by .875.

CHAPTER XIV.

INCANDESCENT LAMPS—MANUFACTURE AND INSTALLATION—PHOTOMETRY.

FOR indoor illumination, especially small rooms, the arc lamp is altogether unsuitable. In such cases we want a more distributed light, and this is afforded by incandescent electric lamps. To the uninstructed, these seem remarkably simple, consisting of, as they say, a carbon wire enclosed in a glass bulb. But to get the right carbon thread, and one that will last a fair time in use, and not absorb more than a certain amount of power, demands careful attention to a great many details, as we shall see as we proceed.

The first lamp of this type was constructed by Chief-Justice Grove, who supported a platinum wire inside a glass vessel, and connected it to a number of primary (Grove's) cells till it was raised to a white heat. This form, however, could not be made into a commercial lamp, for not only was it dear (platinum being very expensive), but if raised slightly higher in temperature the platinum would melt, and it was not till Mr Swan proposed carbon in a vacuum that the incandescent lamp became a success. Space will not permit of a history of the lamp down to the present day, and we must therefore leave it, and consider the process as employed at the present time by the leading makers.

To begin with, cotton wool of good quality is placed into barrels of zinc chloride solution, where it dissolves, and sufficient is added to make it of the consistency of syrup. In this state it loses all its fibrous structure, and turns a light brown colour. Standing near one of these barrels is a tank of water containing several strong glass flasks, which are kept hot by passing steam into the water surrounding them in the tank. Each of these flasks is provided with a good fitting indiarubber stopper pierced with two holes into which are inserted two glass tubes. One tube of each flask is connected to a glass tube leading to the cotton solution in the barrel, and the other tube of each flask is connected

to another glass tube in connection with an exhausting pump, and thus the air is slowly drawn from the flasks and the cotton solution sucked in. This is to free the solution from occluded air, and as it enters the flask and slowly dribbles in a fairly large amount of air is drawn from it, which is further effected by being expanded by the heat supplied from outside. This goes on till the flasks are about three parts full, when they are taken away and others put in their place (see Fig. 118).

A flask containing the cotton solution that has been so treated is now connected to a glass tube, from which springs a number of other tubes furnished with glass nozzles of different sizes, each standing over a tall glass jar containing alcohol. The second tube in the indiarubber stopper is now connected to a force pump

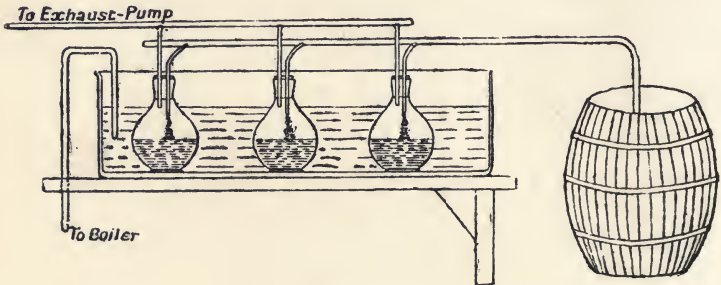

Fig. 118.

which applies a pressure on the surface of the solution of a few pounds per square inch, and forces the cotton solution through the connecting pipes and nozzles as fine continuous threads into the alcohol (Fig. 119). The zinc chloride solution is dissolved out in the alcohol, but to completely free it right to the centre (which is of importance) it must stand in alcohol for about twenty-four hours. After a small amount has been squirted in this manner, forming a coil at the bottom of the tall glass jar about 2 in. deep, another jar is put in its place, and the squirted cotton solution is allowed to remain in the jar for about one hour, so that the surface may harden a little, and allow of taking it out without fear of injuring it, which is done by drawing it up with hooked glass rods. Each coil is then placed in a small stoneware dish pierced with holes all round to facilitate diffusion, and these are stacked up in a

stoneware vessel, large enough to hold about fifty of the smaller pierced dishes. Alcohol is then poured in to fill the whole, and they are left so for about twenty-four hours. Because of the free use of alcohol in this process, the room in which it is done must be perfectly fireproof, and no lights other than electric are allowed in it.

After getting rid of all traces of zinc chloride by the above method, the squirted cotton threads have next to be perfectly freed from alcohol, and for this purpose the alcohol is drawn off, and the large stoneware vessel containing them is next placed in a

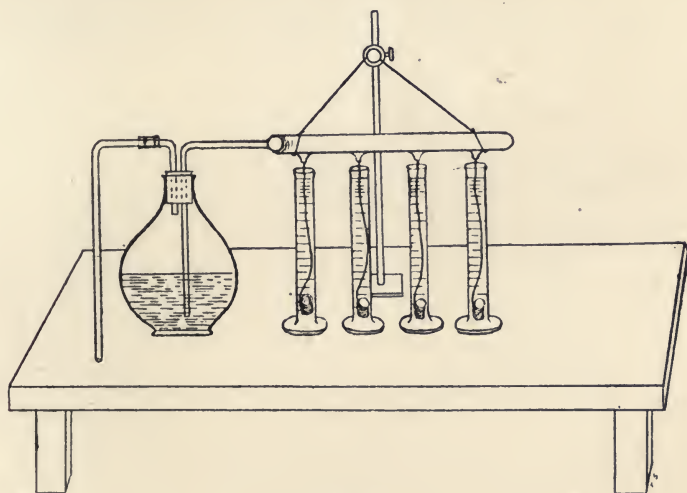

Fig. 119.

sink, and water allowed to run freely through it for about seven or eight hours, and we then have small coils of cotton thread, but perfectly homogeneous and structureless, resembling threads of glass rather than cotton. These are expanded very considerably, and in drying they contract and shrink, and some device has to be adopted to prevent them from breaking up in drying. One method is to wind them loosely on drums which have previously been covered with thick velvet. This allows of the threads sinking into the velvet as they dry and contract.

The next process is to wind these threads on to formers, so

as to give them the required shape, the most common shape being the single loop. The former is made entirely of carbon, and consists of a carbon block with a step at one end, which is grooved on its upper surface to better support the thick carbon rod round which the cotton threads are wound. Fig. 120 shows the former and the method of supporting it, in a small brass frame with thumb screw, the whole being free to turn in the small head-stock fixed to the bench. A number of threads (ten to twenty) are first fixed to the lower edge of the carbon block with sealing wax; they are then wrapped once round the carbon rod, and brought down to the lower edge of the carbon block on the other side, where they are fastened with sealing wax in the same way.

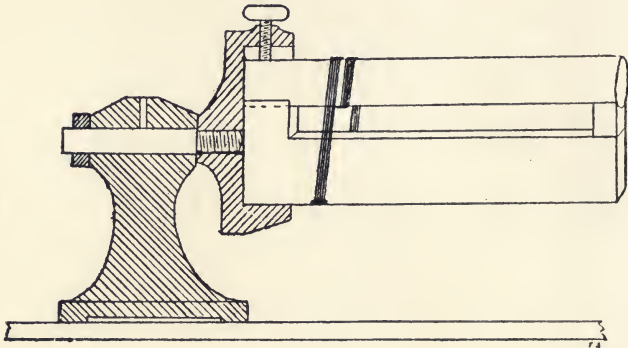

Fig. 120.

Another set is fixed in a similar manner by the side of the first, and so on till the former is full. A small block of carbon is then slipped between the extreme end of the carbon rod and block to hold them in position, and the wound former can then be taken from the brass clamp and another put in its place. The formers are now wrapped round with cotton at a point just above where they are fixed with sealing wax, and the ends then cut through with a knife to release them. This allows freedom for a further contraction during the process of carbonising.

A large number of these formers with their cotton threads are now carefully packed edgewise into carbon crucibles; a thick layer of plumbago is placed in first, and then a number of formers, with spaces between each. Powdered plumbago is now put in to

fill all the spaces, and completely cover them for a depth of about 1 in. A second number of formers are then arranged above the first, and these are packed with plumbago in the same way as the first, and this proceeds till the crucible is full. It is now covered with a carbon lid, first pouring in a small quantity of petroleum, this last precaution being necessary to drive out all the occluded air from the crucible (as it gets hot), and so prevent the filaments from being burnt. When a sufficient number of crucibles are filled in this way, they are placed into a furnace, and the temperature slowly raised to a high degree (about 1,000° F.), and they are then allowed to slowly cool down, the whole operation occupying close on twenty-four hours. When cold, they are opened and carefully unpacked, the formers being taken out one by one, and the filaments put into separate compartments in boxes ready for assortment. The filaments have now entirely



Figs. 121 and 122.

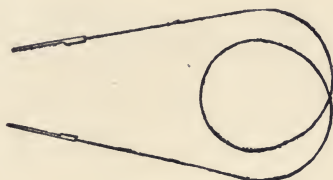

Fig. 123.

changed in appearance ; they are much thinner, and have a shining black metallic appearance, and a fair amount of elasticity. Any that have not this appearance have been burnt, and must be rejected.

The filaments are next gauged in two places by a screw gauge provided with a long pointer over a scale which enables the diameter to be read to $\frac{1}{1000}$ mm. with ease, and they are put into separate boxes according to their thickness, and stocked. When a particular batch of lamps is required, the proper thickness for the filaments is determined from a consideration of the candle-power and efficiency required, and these are taken from the stock and cut to the required length, a gauge being set to facilitate the work. The ends of the filaments have now to be attached to platinum wires, and a good mechanical and electrical joint is absolutely necessary.

The platinum wire is cut up into pieces about 1 in. in length, and the end of each piece is flattened for about $\frac{1}{8}$ in. by passing them singly under steel rolls which are set to move the required distance, but no more (Fig. 121). These are next threaded through a die which turns up the flattened end, forming it into a tube (Fig. 122). One of these is threaded on to each end of the carbon filament, and held there by squeezing it with pliers (Fig. 123). But the joints so made are not nearly good enough, and they have to be cemented together. This is now usually done electrically.

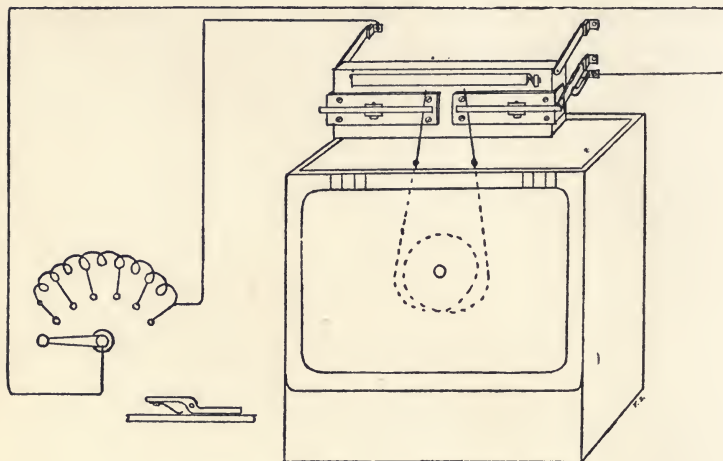

Fig. 125.

Fig. 124.

The apparatus (Fig. 124) consists of a small cast-iron box with a close-fitting lid, pierced with a hole, which is only provided to smother out the flames should the contents of the box catch fire. Over the box a special clamp is supported by a lever which enables it to be raised or lowered. The clamp consists of two pieces of metal, side by side, insulated from each other, each provided with a spring clip which holds the platinum wire attached to the filament (Fig. 125). A strip of metal is free to swing in front of this, and when a filament is placed in the clamp, hanging downwards, supported by the platinum wires in the clips, the strip of metal can be brought into contact with the carbon just below

the junction with the platinum. If now a current be led in by one clip and out by the other, the filament will be short circuited, for the current completes its circuit from one joint to the other across the metal strip. This clamp is built up on a slate base, and everything in the room is made of fireproof material. A large number of these boxes so provided are attached by iron pipes to a large cistern fixed on brackets to the wall outside the building, and the cistern is kept constantly supplied with benzene. This ensures that the small cast-iron boxes shall be always full up to a prearranged mark.

The process consists of first arranging the filament in its clamp, as shown in Fig. 124, then (after placing the short circuiting strip of metal in position) lowering it into the liquid till the joints are well covered by it. A current of electricity is now switched on, which (by means of a regulating resistance at the side of the operator) is adjusted in strength till the joints are seen to be glowing under the liquid. The reason for them glowing is due to the heat developed in overcoming the resistance of this part of the circuit. Now benzene is a substance very rich in carbon, and it is easily decomposed at this high temperature, the carbon being deposited at the point where it is decomposed, consequently in a few seconds after it starts to glow, the current is switched off, the clamp raised, and we find the joints beautifully united with a cement of carbon.

The benzene cannot catch fire while the joint is kept well under the surface, for there is no air or oxygen in contact with it, which would be necessary if the benzene is to burn, but should the operator bring the joint to the surface before switching off the current the benzene would undoubtedly catch fire. To prevent this, which might prove a disastrous accident, the circuit is broken by the clamp lever in raising it, and this is independent of the regulating resistance switch for the operator's use.

If the carbons are examined at this stage under a microscope they will be found to be quite porous, with relatively large gaps in places. This would cause the filament to glow much brighter at the points where the section is smallest, and it would break in a very short time if left in this condition, for the strength of the filament is given by the strength of its weakest part. These holes are caused in the process of carbonising, for during that process a large amount of hydrogen and other gases were driven off, leaving

only carbon behind. To make the filaments serviceable, these pores or holes must be filled up with carbon, so as to give a perfectly uniform sectional area throughout. This is done by the process known as flashing.

The apparatus for flashing is shown diagrammatically in Fig. 126, and consists of a large indiarubber pad on top of which are fixed two clamps similar to those used for cementing the joints, so that the filament may be supported by the platinum wires in an upright position, and these are connected to the mains through a regulating resistance switch. A tube passes air-tight through the

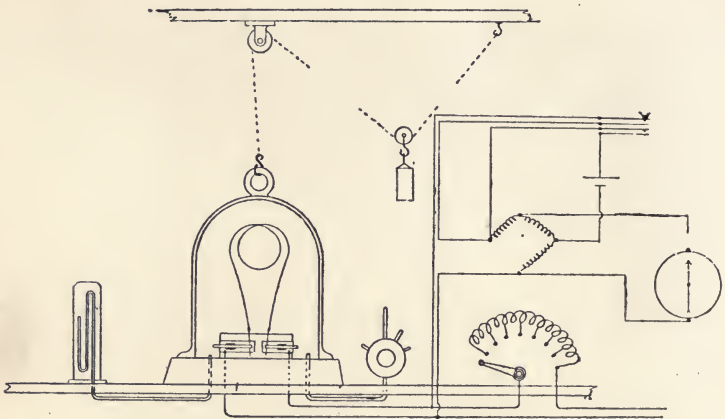

Fig. 126.

rubber pad, and is connected to a three-way cock on the bench. There is also a pressure gauge connected by a small tube through the pad, and a bell jar is arranged so as to be readily drawn down on to the indiarubber, and so enclose the filament and tubes. One of the cocks connects the tube attached to it to an exhausting pump, which very quickly removes most of the air from the space inside the bell jar. The second cock connects the space to a much better vacuum pump which slowly brings down the pressure inside to a small value, as read on the pressure gauge. The third cock connects the space to an air-tight vessel containing benzene, and owing to the low pressure inside the bell jar it immediately fills with benzene vapour. A current is now switched on to the filament till it glows, at first showing bright spots.

These parts being at a much higher temperature, decompose the benzene vapour faster than the remaining portions, and so carbon is deposited at these weak parts most rapidly, and the bright spots soon disappear. The current is then increased, and so carbon is deposited till the filament is perfectly uniform and its resistance brought down to the required value, which is known by putting down a double contact key connecting the filament to a Wheat-

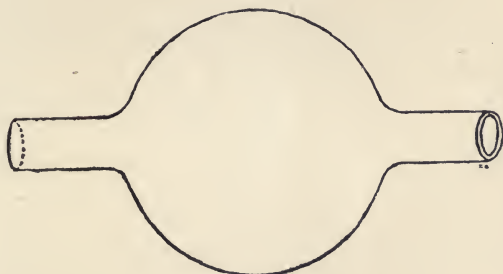

Fig. 127.

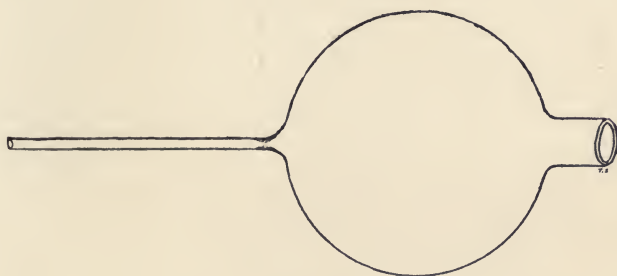

Fig. 128.

stone bridge after switching off the current, and the flashing is repeated till a balance is obtained on the bridge, as seen by a sensitive galvanometer close by. The filaments being all alike in length, it follows that they are also alike in sectional area when they have the same resistance, and will all absorb the same amount of power when connected to the same difference of potential.

The filaments have now to be sealed in glass globes, which are blown from a piece of glass tubing about $\frac{3}{4}$ in. in diameter and

$\frac{1}{8}$ in. thick in the wall, after which a tube is blown on the end, about $\frac{3}{16}$ in. in diameter and 3 in. long, to attach the bulb to the vacuum pump. The junction is constricted so that it may be easily sealed after exhausting, as shown in Fig. 128. The large end of the tube is now sealed up near the bulb, then blown out and expanded with a tool to admit the filament, which partly springs

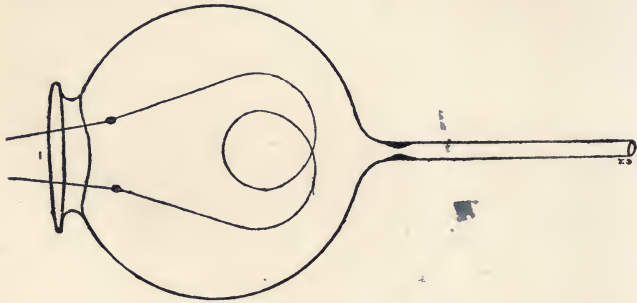

Fig. 129.

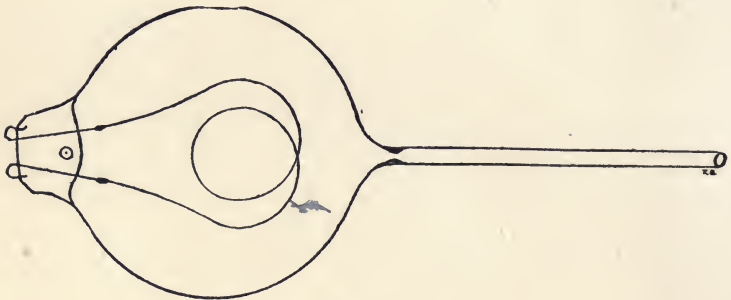

Fig. 130.

in. The platinum ends are stuck on to the side of the opening and adjusted in position so as to put no strain on the filament, and to hold it symmetrically in the bulb (Fig. 129). The opening is then closed by squeezing the sides together, and while the glass is still soft the corners are snipped off. Two small dents are made in the top of the bulb with a blunt tool, and the projecting platinum wires bent round and again sealed in the glass, as shown in Fig. 130.

While this operation has been proceeding a porcelain crucible has been standing over a Bunsen burner, and is now red hot. The bulb with the filament inserted is placed into the crucible and left to slowly cool by swinging it from over the flame on a turntable, while another crucible takes its place to be ready for the next bulb. This is to anneal the joints between the glass and the platinum. If allowed to cool quickly the glass at this point would probably crack.

The bulbs are now connected to the vacuum pump by blowing them on direct, indiarubber tube connections not being admissible, for the bulbs are heated very considerably to facilitate the exhaustion. About six lamps are connected at a time, and a fine wire is twisted round one of the platinum wires of each lamp, thus connecting them all together. A second similar wire connects together the other platinum wires, and the lamps are thus put in parallel.

The pump employed for this work is some form of the "Sprengel" mercurial pump, the action of which will be best understood by considering the simplest form (Fig. 131). Here a long glass tube is furnished with a funnel-shaped top, and a second tube is blown on near its upper end to which the lamps are attached. This tube is supported in a vertical position directly over a receiver, and a constant supply of mercury is kept in the funnel. The mercury runs down the small tube, but in its passage encounters the air contained in the lamps and tube attached, and drives a little in front of it. This causes a partial vacuum behind it, and more air from the lamps rushes in, and the mercury coming behind carries this in front of it down the fall tube, as it is called. This action causes the mercury to divide up into little globules or pistons as it passes the junction to the



Fig. 131.

lamp tube, and each piston of mercury carries a certain quantity of air in front of it. The process would be expedited if the lamps were heated and the air they contain expanded, also if we had more fall tubes connected to the same lamp tube, the time taken to exhaust the lamps would be practically inversely proportional to the number of fall tubes. The mercury that runs down to the receiver can be poured back into the funnel at the top when the mercury in it is getting low, and this is often done automatically.

When the lamps are blown on and connected up in parallel as described, they are first connected to a powerful air-pump which takes a very large proportion of the air from them with a few strokes of an engine installed for this purpose. They are now connected on to the mercury pump to exhaust them to a much higher degree. A sheet-iron cover is then lowered over them, and a large Bunsen burner kept burning under it to heat the bulbs and expand the remaining air. As the exhaustion proceeds, the filaments can be brought to a dull red heat without injury, and later on are brought to incandescence, and the expansion of the residual air thereby increased. At the final stages they are often run at a higher voltage than the normal, and the filaments are glowing with great brilliancy. While this is proceeding a faint blue flame appears at the junction of the carbon and platinum which slowly disappears, and when it vanishes the exhaustion is complete, and the lamps are disconnected from the electrical supply singly, and taken from the pump by blowing off the small tube near the bulb with a small blow-pipe flame, thus sealing the bulb and also the end of the tube from which it has been taken, and so preventing the vacuum in the remaining lamps being destroyed.

The lamps are now tested, to see that the sealing off has been effectually accomplished, by placing them one at a time on a well-insulated metal dish containing brass filings, and connected to one pole of a small transformer which raises the pressure to 1,500 or 2,000 volts. The operation is performed in a dark room, and if the vacuum is good no effect is observed in the lamp. If, however, the vacuum is imperfect, the bulb glows slightly with a red or blue tint, depending on the nature of the rarefied gas inside, and these must be returned to the pump and be exhausted afresh. If found perfect in this respect they are next tested for spots, for a filament which exhibits bright spots at the moment of switching

on will not last long, for these are *weak spots*. They are often undiscernible when the lamp is glowing normally, but show up well at the moment of switching on, for they are the first points to become incandescent owing to their increased resistance. The test is made by connecting the filament to a potential difference above the normal voltage, by means of a carbon plate and carbon block in a suitable handle. By tapping the plate with the carbon block, the spots, if they exist, are very marked. If they are free from spots, the carbon block is held down for a short time to test the filament as a whole on the higher voltage (Fig. 132).

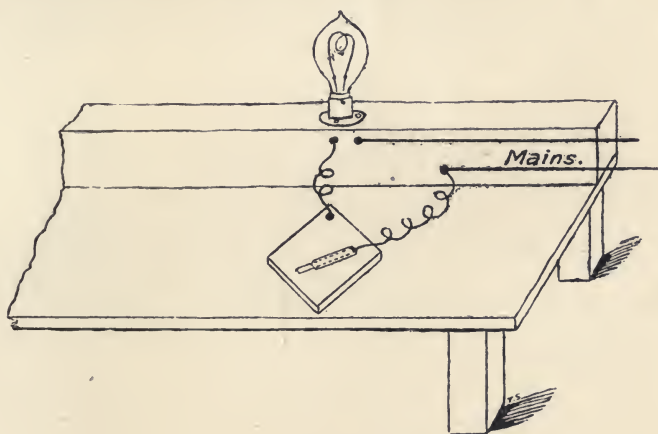
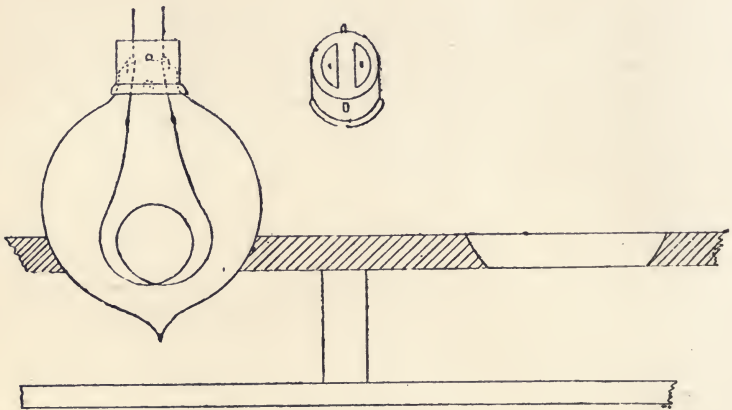

Fig. 132.

The lamps are now transferred to the photometer room, and the candle-power and efficiency of each carefully measured by two independent operators on two different photometers, a record being kept of each (see Photometry), and if the readings obtained by the two operators agree within a certain limit they are passed on to the capping department. Here short lengths of tinned iron wire are soldered to the ends of the platinum wires, and a large number are then arranged in racks, with the wires standing vertically upwards. A brass collar, furnished with pins for the bayonet joint, or a coarse screw for the "Edison" type, is slipped over each, and thin plaster-of-paris poured in to fill the caps (Fig. 133). When the plaster begins to set, a brass contact stud with inwardly

projecting teeth and a small hole in the centre is threaded over each wire, and pressed into the plaster-of-paris till they are flush with the top of the cap. Care must be taken that the two contacts do not touch each other or the cap, and also that the relative position of contacts and pins is correct, the pins in the cap being in line with the space between the contacts (Fig. 134).

After the plaster-of-paris has properly set, the iron wires are bent back on the contacts and soldered, the ends being snipped off close. The capping is now tested by connecting wires from the mains through a second lamp to either contact and the cap. If there be a connection between them this lamp will light up.



Figs. 133 and 134.

Next by connecting the wires to the two caps. If they are short circuiting the filament, the lamp will again light up; but if not, both the lamp being tested and the second lamp will be put in series, and both will glow dull red (Fig. 135).

The lamps are now packed into baskets, which are divided into compartments to hold about fifty lamps each, and these are stacked up in a room kept at a temperature of about 90° F., while a current of air is kept circulating through them by means of a fan. They are left here for four or five days, so that the plaster may thoroughly harden, and they are then tested once more to see that the caps have remained straight while the plaster has been drying.

This is done by inserting them first into one lamp-holder and then into another fixed at right angles to the former, and they must stand approximately upright in both positions, after which they are cleaned with dry cloths, and the proper marks put on.

The marking is often done by means of indiarubber stamps and hydrofluoric acid, which has the property of eating into glass, and must therefore be kept in guttapercha vessels. The usual marks are voltage, candle-power, efficiency, and maker's name.

If the lamps are to be frosted they are held in a sand-blast. The apparatus consists of an iron enclosure with a window in

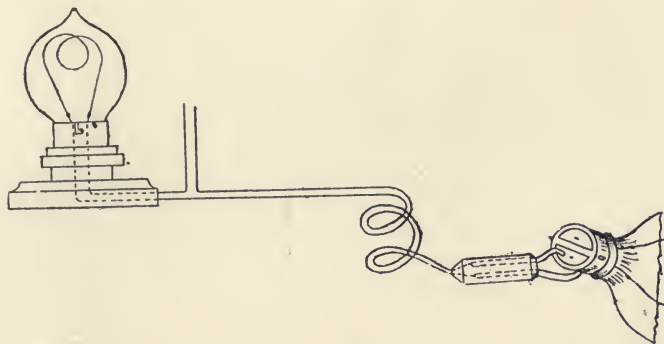

Fig. 135.

front, and armholes. Near the centre is stretched a sheet of indiarubber, and another sheet is stretched a little way below the roof to prevent the lamp from breaking if it should fly out of the operator's hands. At the centre of the lower sheet, a small nozzle projects, through which is forced a fine stream of sharp sand. The lamp is held in this and turned about so that all parts of it are acted upon. The sand very quickly covers it with fine scratches giving it a frosted appearance. If a pattern is required, a stencil has to be put over the lamp, and only the parts of the glass facing the openings in the stencil are then acted upon by the sand.

The lamps are now wrapped up in special wrappers, each of

which is stamped with the voltage and candle-power of the lamp enclosed, and they are then packed up in wood boxes ready for despatch.

These lamps will last for a certain number of hours in use, depending on the care taken in manufacture and on the efficiency. If the vacuum be at all imperfect, it shortens the life of the lamp very considerably. If the filament develops spots, it must necessarily break at the weakest point in a short time, as the carbon tends to leave the filament and deposit itself on the glass, and the weak spot being at the highest temperature, loses most, which makes it still weaker, and a time comes when it reaches such a high temperature that it volatilises completely, and the filament is broken. This tendency of the carbon to deposit itself on the glass, due to imperfect vacuum, is very objectionable, for the blackening of the bulb due to it cuts off a certain percentage of the light, and lowers the efficiency. Again, the carbon leaving the filament uniformly (supposing there be no spots) thins it down, making it of higher resistance. It therefore takes a smaller current, and the light is considerably less, the efficiency being less on this account also because of working at a lower temperature. If the blackening is very pronounced, it often pays to replace the lamp by a new one, for by its use we are paying a high price for the light we get from it. Cheap lamps of inferior quality are greatly addicted to this fault, a certain amount of blackening being noticeable even after the first few hours' use. They also often break away at the junction between the platinum and carbon, for unless care be taken in sealing the filament in, it is very easy to put a slight strain on it, and so weaken it.

At the high temperature to which the filament is brought when working, a certain amount of the carbon is, even in the best, slowly disintegrated, and in course of time the weakest spot in the filament is unduly heated, and slowly gets weaker, depending on the temperature to which the filament is raised. This weak spot, once it manifests itself, develops at a greater and greater rate till it finally breaks. It is evident that the life of any given lamp depends upon the temperature of the filament, which again depends on its efficiency. Lamps can be made to have almost any efficiency we please. Take for example a 16 c.p. 100 volt lamp. If the filament be made thinner and shorter the resistance can still be kept the same, for though we increase the resistance by making it thinner,

we decrease it by making it shorter. It will therefore take the same amount of power when connected to the same difference of potential, but this amount of power is put into a smaller amount of material, and the temperature is consequently much higher, and the light obtained much greater also. But at this higher temperature the filament will be more quickly destroyed, and therefore what we save in efficiency we spend in lamps, consequently we have to decide whether it is cheaper to have high efficiency lamps and more of them, or lower efficiency lamps and a smaller lamp bill. This can only be decided by considering the price of the Board of Trade unit, and the price paid for the lamps. Of late years the last mentioned has been very considerably reduced owing to competition, and at the same time the quality of the lamps has in many cases been well maintained even at the reduced price. This enables us to use higher efficiency lamps than formerly, and the common efficiency employed in towns and places where the power is rather costly is from 3 to 4 watts per candle-power. In places where the cost of power is very low, it pays best to use lamps of a lower efficiency, and so save on the lamp bill more than is spent on the extra power required.

The following table gives particulars of tests made with two 16 c.p. 100 volt lamps, taking the mean value for the two. These were run at 100 volts continuously, and current and candle-power measured at intervals.

| Time in Hours. | Current. | Resistance. | Candle-power. | Watts per Candle-power = Efficiency. |
|----------------|----------|-------------|---------------|--|
| 0 | .60 | 166.6 | 17.0 | 3.50 |
| 100 | .62 | 161.2 | 17.3 | 3.58 |
| 500 | .62 | 161.2 | 17.0 | 3.64 |
| 800 | .61 | 163.9 | 15.0 | 4.00 |
| 1,200 | .61 | 163.9 | 14.8 | 4.12 |
| 1,500 | .60 | 166.6 | 13.3 | 4.51 |
| 1,600 | .60 | 166.6 | 12.3 | 4.87 |

From these tests we notice that the light given increases slightly in the first few hours, but soon begins to fall off at a rapid rate, till after 1,600 run it has reached a point where it pays to replace the lamp by a new one.

The following table is taken from a series of tests made from samples of 100 volt 16 c.p. lamps, of different makes, to test the life with varying voltage :—

| Voltage. | Hours Life. | Candle-power. |
|----------|-------------|---------------|
| 96 | 2,751 | 10 |
| 98 | 1,645 | 12 |
| 99 | 1,277 | 14 |
| 100 | 1,000 | 15.8 |
| 101 | 785 | 18 |
| 102 | 601 | ... |
| 103 | 477 | 20 |
| 104 | 375 | ... |
| 105 | 284 | 22 |
| 115 | ... | 40 |

Several attempts have been made to use incandescent lamps of low voltage in series, but with very little success. The method now adopted almost exclusively is to connect them in parallel at a constant difference of potential. A pair of mains are taken from the basement, where the meter is usually fixed, to a distributing board, these mains being large enough to carry the current for the whole number of lamps to be installed, due allowance being made for a subsequent small addition. The distributing board is made of slate or porcelain, and contains two brass bars, or better still, two separate boards with a single bar on each, to which the mains are connected. From these bars a number of pairs of mains are run to the different floors, each pair being provided with a switch and fuse. The size of the mains depends on the size and number of lamps required for each floor. A similar but smaller distributing board is usually fixed on each floor, and the corresponding pair of mains from the distributing board in the basement is connected to the brass bars or omnibus bars as they are called. From these radiate a number of smaller mains provided with switches and fuses on the distribution board, to which are connected certain groups of lamps on that floor (see Fig. 136). In this way, if anything goes wrong with one circuit, only that part need be interrupted in the supply, and by disconnecting this circuit from the distribution board the fault is easily located and repaired. There is also a minimum of joints to be made, and joints are often weak

points in the installation. The sizes of wires and cables are in practice usually taken from a wiring table, one of which is given below. It can, however, be easily calculated when we fix on the maximum allowable voltage drop in the installation, and measure up the distances and current on each floor thus:—

Suppose a three-floor installation—Current on first floor, 50 amperes; second floor, 30 amperes; and third floor, 20 amperes. Distance from meter to first distribution board = 10 ft.; from first to second distribution board = 30 ft.; from second to third distribution board = 30 ft.; and from third distribution board to furthest lamp = 50 ft.; while maximum allowable voltage drop between any two points = 1.5 volts. The size mains all through can now be calculated from the maximum allowable current density as explained in Chapter III.

The longest distance run in the building = 120 ft. = 40 yds.

At 1,000 amperes per square inch the voltage fall = $.0475 \times 40 = 1.9$ volts.

Therefore $1.9 : 1.5 :: 1000 \text{ amps. sq. in.} : x \text{ amps. per sq. in.}$

Therefore—

$$\text{Current density allowable} = \frac{1.5 \times 1000}{1.9} = 789 \text{ amps. per sq. in.}$$

The mains from meter to first board carry a current of 100 amperes, therefore they must be $\frac{100^2}{789}$ sq. in. in section. The mains from first to second board carry a current of 50 amperes, therefore they must be $\frac{50^2}{789}$ sq. in. in section. The mains from the first to the third board carry 20 amperes, and therefore they must be $\frac{20^2}{789}$ sq. in. in section. The size of the conductors on each floor is found in the same way. For instance, if one pair runs from the board to a group of ten lamps and carries a current of 5 amperes, then these must be $\frac{5^2}{789}$ sq. in. in section, and so on. In this way the current density is kept the same throughout the whole installation, and at that current density we get no more than the allowable voltage fall on the given length. If there is a possibility of subsequent additions to the lighting, larger mains should be put in.

If we had taken the current density as 1,000 amperes per square inch, the voltage drop would have been just under 2 volts on the same installation.

The following table has been made up allowing 1,000 amperes per square inch, which is a very common current density in this

class of work. This gives a voltage drop on the two mains of .0475 volt per yard as shown in Chapter III.

| No. of Wires in Strand. | Size of each Wire, S.W.G. | Sectional Area of Copper, sq. in. | No. of Lamps, 16 c.p., 100 volts. | Outside Diameter in inches. |
|-------------------------|---------------------------|-----------------------------------|-----------------------------------|-----------------------------|
| 1 | 20 | .001 | 1 | .175 |
| 1 | 18 | .0018 | 3 | .191 |
| 3 | 20 | .0031 | 5 | .214 |
| 3 | 18 | .0055 | 9 | .237 |
| 7 | 20 | .0073 | 12 | .262 |
| 7 | 19 | .0089 | 15 | .318 |
| 7 | 18 | .0128 | 21 | .352 |
| 7 | 17 | .0174 | 29 | .384 |
| 7 | 16 | .0229 | 38 | .417 |
| 7 | 15 | .0290 | 49 | .450 |
| 7 | 14 | .0356 | 59 | .482 |
| 19 | 17 | .0479 | 79 | .533 |
| 19 | 16 | .0624 | 104 | .594 |
| 19 | 15 | .0789 | 131 | .654 |
| 19 | 14 | .0975 | 162 | .714 |

Each circuit must be provided with a fuse which will melt if the current exceeds a certain predetermined value. This is found to be absolutely necessary, for should a short circuit occur, the current would immediately rush up to some high value depending on the resistance of the short circuit, and the heat being proportional to the square of the current, would soon melt the insulation on the cables and set fire to the building. By placing a fuse in the circuit we make this by far the weakest spot in the circuit electrically, and therefore this piece will be destroyed long before the cables would have time to get appreciably hot or even warm. The fuses are usually made of tin wire, but sometimes lead or a mixture of tin and lead is employed, and again thin flat strip is sometimes used instead of wire, but the largest proportion at the present time are made of tin wire, which has a definite and low melting point. These should be at least $1\frac{1}{2}$ in. in length, otherwise the terminals will conduct the heat away so rapidly that the current required to fuse the wire may be much greater than is intended. The fuses must be mounted on fireproof supports made usually of glazed porcelain, and one can be placed on each conductor or a single fuse on one conductor only.

The main fuses should be of the double pole type, *i.e.*, one on each main, because certain faults may arise which would allow of a large and perhaps destructive current flowing, which would not be safeguarded by a single pole fuse. For instance, suppose there happen to be an earth connection on the supply company's side of that main which is provided with a fuse, and an earth connec-

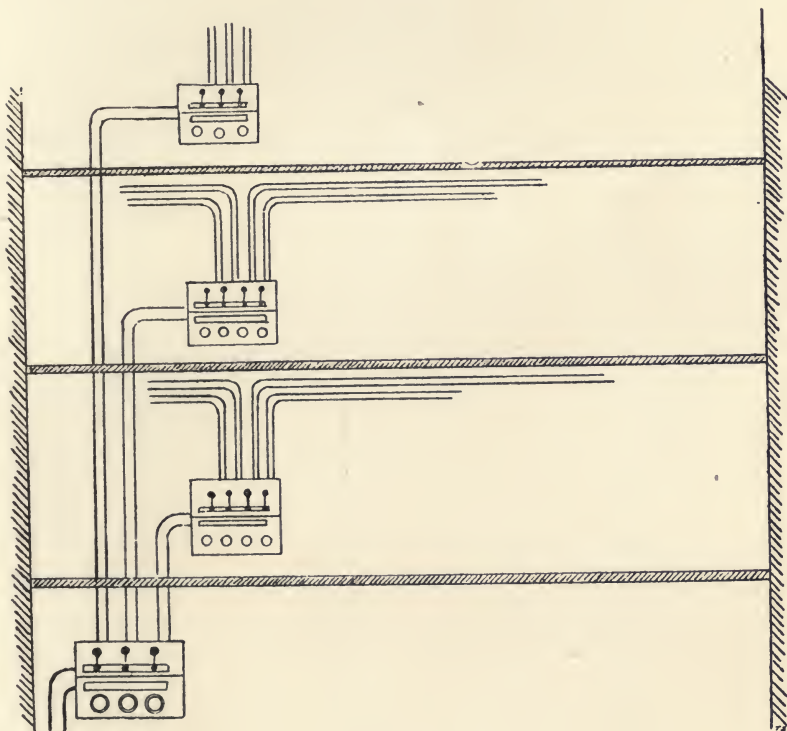

Fig. 136.

tion should now spring up on the other main, a large current would flow without passing through the fuse at all, which may prove dangerous.

On a low resistance short circuit the fuse usually explodes, for the current travels through the body of the wire heating all parts alike, but the outside, being in contact with the air, is always the

coldest part. Therefore the interior portions melt and volatilise while the outside skin is still solid. This effect is often increased by the outside becoming slightly oxidised. If the short circuit be a high resistance one, the wire will only slowly heat to the melting point, and will then break through the weakest point, similar to the lamp filament, and the fuse wire remains with but a short gap in it. In the former case little or none of the fuse wire remains, except for very short lengths under the terminals. A table is given below of the size of different fuse wires which will fuse when the current reaches the value given. Of course any smaller fuse wire can be made to take a much larger current by putting several of them in parallel. Thus, suppose we have 5 ampere fuse wire, then by putting two lengths between the fuse terminals it will go at 10 amperes, three lengths at 15 amperes, and so on, for the current in the mains will divide equally between them if they are carefully inserted, so that all are making good contact with the terminals.

| Current in Amperes to Blow Fuse. | Size of Wires, S.W.G. | | |
|----------------------------------|-----------------------|-------|-----------------------------------|
| | Tin. | Lead. | Tin Lead Alloy. Tin 1, Lead 2. |
| .5 | 40 | 39 | 39 |
| 1.0 | 36 | 35 | 35 |
| 1.5 | 34 | 32 | 32 |
| 2.0 | 31 | 30 | 29 |
| 2.5 | 29 | 28 | 27 |
| 3.0 | 28 | 27 | 26 |
| 3.5 | 27 | 26 | 25 |
| 4.0 | 26 | 25 | 24 |
| 5.0 | 25 | 23 | 23 |
| 10.0 | 21 | 19 | 19 |
| 30.0 | 15 | 14 | 14 |
| 50.0 | 13 | 11 | 11 |
| 100.0 | 8 | 7 | 7 |
| 200.0 | 3 | 2 | 1 |

The fuses should be so chosen that they will melt when the current reaches 1.3 to 1.5 times its normal value.

PHOTOMETRY.

The efficiency of a lamp is expressed in "watts per candle-power," and to measure the efficiency it is therefore necessary to

measure the candle-power obtained with a given expenditure of energy by comparing it with the light given by some standard. Of all things measured in science that of luminosity is perhaps the least exact, for the standards employed are far from perfect. In England a special candle is used as the standard source of light, made of spermaceti, which burns at the rate of 120 grains per hour with a flame 1.8 in. high, but large variations are found to exist when a number of these are tested one against another.

In Germany a lamp, known as the Hefner-Altенck, is largely used. It burns amyacetate with a circular wick of prescribed cross-section, and a flame of a fixed height = 1.6 in. It gives a light of .875 English standard candle. A candle is also used in Germany made of paraffin wax, .8 in. in diameter, the wick consisting of 24 threads, which weigh 10.2 grains per yard, and produces a flame 2 in. high. In France a standard known as the Carcel burner is often used, which burns pure colza oil at the rate of 42 grams per hour, with a flame 4 cm. high. Taking the light given by the English standard candle as 1, the French Carcel lamp gives 9.5 candles. As a substitute for the standard candle in England, a lamp has been tried with more or less success, known as the pentane lamp. Pentane is a volatile liquid, having the composition C_5H_{12} , volatilising at $35^\circ C$. The wick is circular in section, and is moved up and down in the ordinary way. The lamp burns the pentane vapour in a slender jet, and the luminosity of the flame increases with its height. The burner is covered by a divided tube, the distance between them being adjustable by screws at the side. This adjusts the length of the flame used as standard, distance pieces being provided to facilitate this. Two slits in the top tube are used as index for adjusting the length of the flame.

Another standard, commonly employed at present in this country, is that due to Mr J. Methven, and known as the Methven screen. In this a London standard Argand burner is supplied with ordinary coal gas, the flame being adjusted to 3 in. in height, as seen by the tip of the flame being just visible above two horizontal pins projecting from the screen. In the centre of the screen a slot is cut out, covered by a small silver plate with a slit $\frac{1}{4}$ in. wide, through which the light passes to the photometer, this light being equal to 2 candle-power. The lamp is provided with a glass chimney, which must be kept perfectly clean and allowed to

reach a fixed temperature before a reading is taken with it (three or four minutes after lighting the burner being usually sufficient time to allow). There is the objection that the quality of the gas varies, and with it its illuminating properties, but from a long series of experiments made it has been shown that the light passing through the slit varies with the length of the flame very much more than with the quality of the gas, and for all practical purposes the latter is negligible and gives rise to far less variation than is found to exist between different standard candles.

Where the standard candle is employed it is usually arranged to have two supported by a balance arm and weighed at the beginning. At the end of the test the candles are again weighed, and the loss in weight in grains multiplied by 60, and the result divided by the time in minutes taken in making the measurement should = 120. If it burns too fast or too slow a correction can be applied proportional to the difference found in any given case; thus, suppose we find the loss in weight = 44 grains, and the candles were burning during the experiment for 10 minutes, then each candle lost 22 grains.

Therefore $\frac{22 \times 60}{10} = 132$ instead of 120, that is 10 per cent.

too great a rate of burning. We must therefore add on 10 per cent. to the light of the candles, or, instead of calling the standard 2 candle-power, we must take it as 2.2 candle-power.

The method of determining the luminosity of any source of light in terms of the standard is done by means of an instrument known as the photometer. There are many varieties, but the simplest is that known as "Bunsen's." It is made by placing a sheet of clean white absorbent paper (blotting paper will do very well) on the centre of which has been placed a very small piece of perfectly clean paraffin wax, in an oven or in some warm place where the wax can melt without the paper being smoked. When this cools we have a white sheet of paper with a small spot of grease in the centre. Looking at it with the light shining on it, the grease spot looks blacker than the paper, but looking at it with the light shining through it from the back it looks decidedly brighter, and when the light on both sides of it is equal in intensity, the spot of grease is practically invisible, or if not so, the two sides of the paper look exactly alike.

This grease spot screen is arranged in a suitable support on a

scale, so placed that it can only receive light on the one side from the standard, and on the other from the lamp being tested, and the screen is moved till the grease spot is invisible. We then know that the light from the lamp on the screen is equal in intensity to the light on it from the standard candles.

Now the light received on the screen from a given source of light varies as the square of the distance between them. This will be readily understood if we suppose a lamp to be placed in the centre of a globe or sphere. All the light from the lamp is then falling on the inner surface of the sphere, and each unit of area is receiving a certain amount of light. If now we replace the sphere by another of twice the former diameter, it is evident that only the same amount of light is now falling on the inner surface of the second sphere, but this sphere will have four times the amount of surface compared with the smaller one, for the surface of a sphere is proportional to the square of the radius. The same unit of area can therefore only have one-fourth the original amount of light, for the same amount of light is spread over four times the area. The distance of this unit of area is, however, only twice the original distance from the source of light, and therefore at twice the distance we only get one-fourth the amount of light.

Knowing that the light from the two sources on the screen is equal, and that the light falls off as the square of the distance, all we have to do is to determine the position of equal luminosity on the screen, and measure the distances from it to the standard and to the lamp. (The distances are often made direct reading on the scale.) These distances are now to be squared, and

Light of lamp : light of standard ::

(dist. from lamp to screen)² : (dist. from standard to screen)².

Thus, suppose the standard = 2 candle-power, and the distance from screen to standard = 50 cm., while the distance from the screen to the lamp = 141.4 cm., then—

$$2 : x :: 50^2 : 141.4^2.$$

$$\text{Therefore } x = \frac{141.4^2 \times 2}{50^2} = \frac{40000}{2500} = 16 \text{ c.p.}$$

The frame supporting the screen is usually provided with two mirrors, one on either side, arranged on an angle, so that the observer looking straight in front can see both sides of the screen

at the same time, which enables a better adjustment of the balance being obtained.

The whole of the apartment should be painted dead black, so as not to reflect the light, and screens are usually provided with holes to allow only the light in the horizontal line with the screen to come through, otherwise the more powerful light would by diffusion and reflection tend to illuminate the far side of the screen, and cause inaccurate balance.

When balance is obtained the readings of the photometer scale and the power absorbed by the lamp are noted, and the lamp is then numbered to identify it again. It will be evident that a scale could be affixed to the photometer, which with a given standard would read in candle-power direct, and this is often done. The efficiency is then obtained by dividing the power absorbed by the candle-power, which gives the efficiency in terms of "watts per candle-power." Thus, if the lamp takes .6 ampere at 100 volts, and is found to give 16 candle-power, then,

$$\text{efficiency} = \frac{.6 \times 100}{16} = 3.75 \text{ watts per c.p.}$$

These lamps usually give different values when viewed from different positions, therefore they should be measured in two positions at right angles, or better still, the lamp should be measured while revolving rapidly.

A great variety of photometers have been devised from time to time. But "Bunsen's" is still used by the Board of Trade, and in many places in this country. Within the last few years, however, a photometer known as the Lummer-Brodhun has come into fairly extended use. It consists of a brass box with an aperture through one end, arranged in line with the sources of light. An opaque screen of fine white porcelain is inserted in the centre of the aperture, and its surfaces are illumined by the two sources of light. Inside the box is an arrangement of right-angled prisms (see Fig. 137) which enables us to see both surfaces of the opaque screen at the same time, through a small telescope fixed to one side of the box. Directly in line with the telescope are two right-angled prisms, the hypotenusal base of one having been etched except for a small spot at the centre, which is left polished; the other is treated in a similar way, but a larger spot is left polished on its surface. These are placed with their bases together so as to form a cube. The observer looking through the telescope sees straight through the smaller spot in the centre of the

cube, and then by total reflection in the right-angled prism in line with the line of sight he sees the far surface of the screen as a small white disc magnified by the telescope. He is also able to see the other surface of the screen, as a ring round the centre disc, for the half cube having the larger central polished part, acts as a simple total reflecting prism, except for the part at the centre where the two polished surfaces form a continuous transparent path through the two prisms. The observer, therefore, by seeing directly through the cube at the centre, and also by total reflection, from the parts of the half cube surrounding the

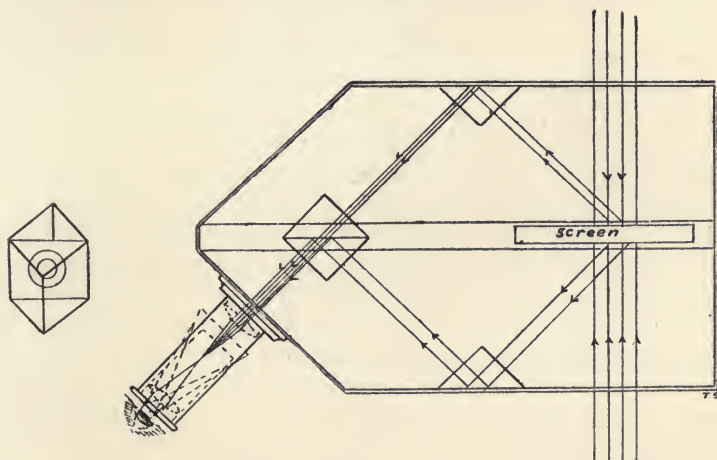

Fig. 137.

clear centre part, and again through the single right-angled prism on his near side, can see both surfaces of the screen, a portion of one forming a disc, while a portion of the other forms a ring round the disc. If one surface be brighter than the other, the ring will appear either brighter or darker than the disc, but when both surfaces are equally illuminated there is no outline between the ring and disc, and we get the appearance of a large evenly illuminated disc in the telescope. It is essential that the two surfaces of the screen be kept perfectly clean, and also the surfaces of the prisms should be free from dust.

Wheatstone, the inventor of the automatic telegraph instrument, and A.B.C. instrument bearing his name, besides the

Wheatstone bridge and many other ingenious and most useful inventions, also invented a photometer, which though not employed much to the author's knowledge, is still very interesting. It consists of a small disc of brass blackened on the surface, and studded with a bright steel ball, which is made to rotate with an eccentric motion at a high speed. If now we have a light shining on this as it rotates, we see a wavy bright line of light owing to the persistence of vision, but if two sources of light shine on it at the same time we see two wavy bright lines intermixing, and one line looks thicker and brighter than the other when the illumination of the two sources differs. The distinction is as definite as some photometers in everyday use, and if mounted on a rigid holder, and rotated by a small motor, it should give very fair results.

In determining the position of balance for the screen, it often happens that two different operators obtain different readings under the same conditions, depending on peculiarities of the eyesight. It is to avoid this personal error that two operators are employed to measure the candle-power of each lamp as mentioned in the consideration of incandescent lamp manufacture. Another source of error is due to the light of the lamp being different in colour to that of the standard, which prevents a perfect balance being obtained by any operator, and for this reason a number of incandescent lamps are often measured with appropriate care, and these are then substituted for the candles. These secondary standards are checked from time to time by again comparing them with the standard candles.

The light given by an arc lamp being so much more intense than that of the small glow lamp, we cannot proceed in the same manner, for we should be working with the screen quite close to the standard, and so get a very uncertain balance, which may mean very large errors. Again, the much larger diffused light from the arc lamp than from the standard would cause further errors, and therefore we must use a much longer photometer with a much higher value for the standard, or make some arrangement to cut off a known fraction of the light from the arc lamp.

In the first method some intermediate lamp is carefully measured by comparison with the standard. This can be a large gas burner, or say a 50 c.p. incandescent lamp (even this being obtained if need be by comparison with a 16 c.p. lamp which has previously been standardised). The arc lamp is now placed at

some distance (8 or 10 yds.) from the 50 c.p. lamp, and the balance obtained in the usual way, the distances being measured up in inches or centimetres (any scale will do, providing we keep the same for measuring both sides).

In the second method it is preferable to use a longer photometer than that required for small incandescent lamps, which need not be more than 2 yds. long. An opaque disc of such a size that half of it cuts off the light of the arc from the photometer is fixed to a horizontal spindle, and is capable of rotation in front of the arc by a motor. One or more sectors are cut in the disc, so that the light from the arc only shines on the photometer when a sector is in front of it. Suppose the width of the screen between the sectors be equal to the width of the sectors, then the screen will cut off half the light, for the light we get on the photometer when the screen is rapidly revolved is a resultant value, the persistence of vision preventing us from seeing any fluctuations when the speed of the disc is above a certain value, depending on the number of sectors. But we can arrange for the sectors to occupy any fraction of the total area we please, and so cut off any fraction of the light, and the candle-power obtained must then be multiplied by the reciprocal of the fraction of light employed. Thus, suppose the screen cuts off $\frac{9}{10}$ of the light, then we are only using $\frac{1}{10}$ of the total light of the lamp, and if on calculating out we find this is equivalent to 85 c.p., then we must multiply 85 by $\frac{1}{\frac{1}{10}} = 10$, so that the candle-power of the whole arc = 850 c.p.

The method adopted for measuring the photometrical value of arc lamps by the National Electric Light Association Committee is interesting, and may be considered as embodying the best practice in this branch of the work. In this case two mirrors are employed, one on either side of the lamp, which gives a much better illumination of the photometer disc when the arc wanders from side to side, as is the case with alternating and enclosed arc lamps. A rotating sector is employed with very narrow angular apertures, revolved by a small motor.

The arc lamp is arranged in line with the photometer, and at a fairly large distance from it, the angle of incidence of the reflected beams of light being $5^{\circ} 54'$, while the direct light from the lamp is cut off by a screen.

Of course there will be a slight error due to the incident rays

not being normal to the screen, but a correction can be made if desired by dividing the intensity as measured by the cosine of the angle of incidence, but if the angle be small, as in this case, the error is negligible.

The arrangement of the photometer and lamp is shown in Fig. 138, but the distance between them should be relatively much greater. The mirrors must be of such a size that the whole of the outer globe is visible when viewed from the photometer. They are supported by balanced arms, so as to be adjustable for various angles of illumination.

With this arrangement it is impossible to move the photometer head, therefore the standard is made movable by connecting it by means of an endless band to a small hand wheel in front of the photometer.

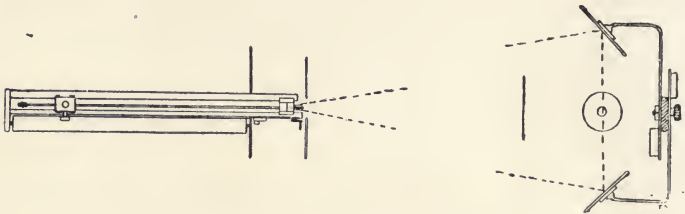

Fig. 138.

On the front of the photometer a scale is fixed, and when balance is obtained a mark is made on the scale at the position of the standard by pressing a key which closes the circuit of an electro-magnet carried on the standard lamp carriage, the armature of which is thereby attracted and records its position on the scale. Thus a record is kept of each test, and the mean of three or four readings can be easily found.

The operator, screened from all external sources of light, sits in front of the photometer, and moves the standard lamp with one hand and presses the key with the other, when balance is obtained.

The standard employed is an ordinary incandescent lamp, and a second reserve standard is fixed to an arm 2 metres away, which can be swung into position by the operator, and the working standard checked from time to time by comparing them. This reserve standard is therefore never burning more than a minute or

so at a time, and is occasionally calibrated very carefully with a Hefner or other standard.

If the arc lamp be particularly weak in any test, the standard can also be reduced in intensity by means of a series of stops, and its value again compared with the reserve standard at the end of the test.

Where great accuracy is not required, it is sometimes sufficient to interpose a sheet or sheets of milky white or smoked glass, and obtain a balance in the ordinary way, after which the amount of light cut off by them can be measured by means of an incandescent lamp and standard candles.

CHAPTER XV.

THE CONTINUOUS CURRENT DYNAMO.

IN Chapter V. it was shown that an e.m.f. is developed in any conductor that cuts through lines of force, and that the value of the e.m.f. so developed is proportional to the rate of cutting. Thus, one conductor cutting one line of force in one second has 1 (absolute) unit of e.m.f. developed in it; one conductor cutting 1,000 lines of force in one second would develop 1,000 absolute units; while if 1,000 conductors cut through 1,000 lines of force in one second, the e.m.f. would be 1,000 times greater than if only one conductor cut them. Again, if these conductors cut the lines of force in $\frac{1}{10}$ second, then the e.m.f. developed is ten times greater; or the e.m.f. is equal to $\frac{NT}{t}$ where N = total

lines of force cut, T = total turns in the conductor cutting N lines, and t = the time in seconds occupied in the operation. But we have seen that the practical unit of e.m.f., the volt, is equal to 100,000,000 absolute units, and to express the e.m.f. developed in this way, in *volts*, we must divide the value obtained by 10^8 .

This is the starting point in the theory and design of modern dynamos, the quantities which determine the e.m.f. being multiplied up to produce any required e.m.f. Suppose it be required to generate 100 volts = 100×10^8 absolute units, then $\frac{N \times T}{t}$ must =

100×10^8 , and if we have say 500 conductors, which we can move through the field in say $\frac{1}{10}$ second, then the total lines to be cut must = 2000000, for $2000000 \times 500 \times 10 = 100 \times 10^8$. Referring to Chapter VI., it will be seen from the curve of magnetisation of iron, given in Fig. 21, that we can get a magnetic density of 16,000 lines per square centimetre without a very large expenditure of energy, and therefore to provide for the 2,000,000 lines of force required in our supposed case, we should provide $\frac{2000000}{16000} = 125$

sq. cm. of iron in which to establish the field at the point where the conductors are to be moved. For mechanical reasons it is found most convenient to move the conductors by a rotary motion, and the rotating part of the dynamo in which the e.m.f. is developed is called the "armature."

The method of calculating the size of the field magnet, or the magnet which has to provide the field of the machine, and the required number of ampere turns for any intensity of field, has been given in Chapter VI.

Continuous current dynamos are made with from one to as many as twelve pairs of poles, depending on the size of the machine. For small sizes, which may be run at a high speed with safety, one pair of poles will suffice, but for larger machines the heat developed in so small a space would raise the temperature to a dangerous value. The current that flows in the armature, when a load is taken from the dynamo, exercises an influence on the field, distorting and weakening it, and with large loads this becomes excessive with two-pole machines. Again with large powers, a multipolar machine is much lighter than a bipolar for the same output, for we can arrange the material more economically. For these reasons we find it unsatisfactory to make machines with a single pair of poles for loads over 150 kilowatts, and the tendency is to make much smaller machines (even as low as 50 k.w.), with three or four pairs of poles. This has another advantage in some cases, the speed being inversely proportional to the number of pairs of poles for any given e.m.f., other things being equal, a much slower speed engine can be employed direct coupled to the dynamo. The large traction generators of 1,500 to 2,000 kilowatts are now universally made with a large number of poles, and are usually arranged between the cranks of a compound engine.

The simplest case, however, and the one we shall consider here, is the two-pole type. In such the armature reaction limits the size of the armature core to something like 24 in. diameter. This is always made of thin iron stampings, either rings or discs, which are supported on a shaft at the centre, and each stamping is varnished with shellac before being put on, to insulate it from the next. The reason for so laminating the iron is to prevent large eddy currents that would otherwise flow round the iron when it is moved in the magnetic field, for any conductor so

moved will develop an e.m.f. depending on the rate of cutting lines of force, and if the iron were solid we should have a conductor with a very small resistance, and even though the e.m.f. developed in it is small, seeing that it would be equivalent to only two conductors cutting through the field, because of its very small resistance, the current may (and would in most cases) be very large, and the iron would soon get hot, besides absorbing a large amount of power by forming, as it were, an electrical brake. The effect of lamination is illustrated in Fig. 139, and in large machines, by the best makers, the iron in the armature does not exceed .01 in.

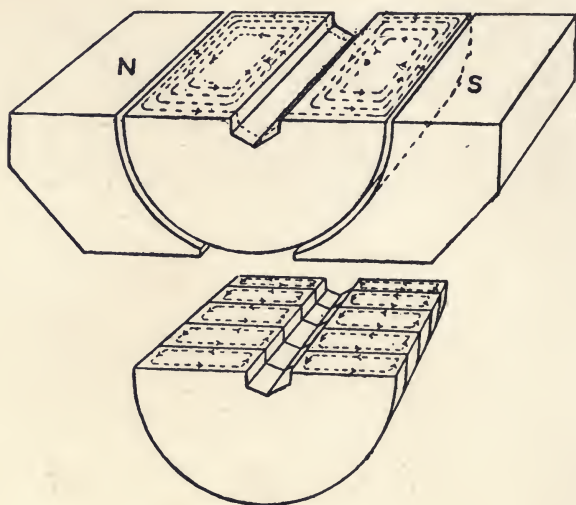

Fig. 139.

in thickness. If the stampings be discs, then they must be provided with a key-way at the centre, or a hexagonal hole, made to fit a similarly shaped shaft at the centre. A stout end-plate presses against a boss on the shaft, and the iron stampings are then threaded on till the required sectional area of iron is obtained (allowing for the space occupied by the insulating varnish whose permeability is unity). A second end-plate is then placed on, and bolted up by nuts screwed on to the shaft and locked in position, as shown in Fig. 140.

If rings are employed instead of discs, then a support made in

brass or gun-metal with radial arms fitting into slots in the inner circumference of the rings must be provided. This support, shown in Fig. 141, is known as the armature spider, and is keyed or otherwise rigidly fixed to the shaft. In both the disc and ring support the object is to give a rigid attachment to the shaft, for the power is applied to the pulley on the end of the shaft, and has to be transmitted to the armature conductors (dragging them through the field) by the shaft and armature core. The armature

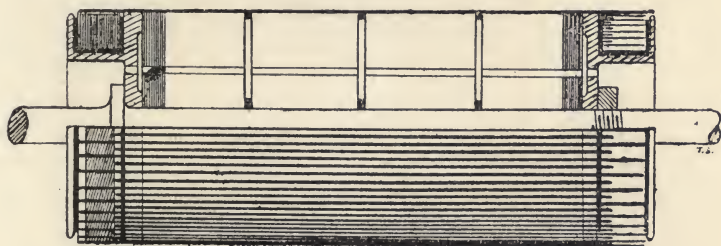

Fig. 140.

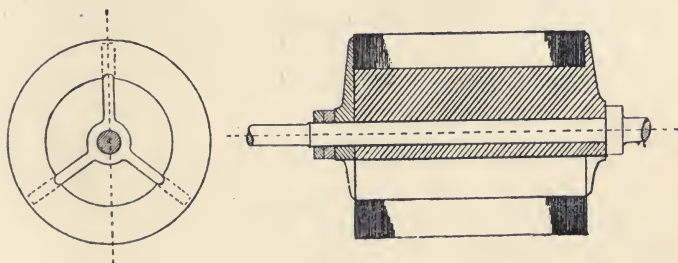

Fig. 141.

when built of discs is known as a "drum," when of rings a "Gramme" armature, from the name of its inventor.

The outer circumference of the stampings are now commonly made with a large number of slots, and the conductors are wound in the slots, both the conductors and the inside walls of the slots being insulated. The size of the conductors depends on the current required, for each conductor on the armature has to carry half the total current, as we shall see immediately. Now the more conductors we get on the armature, the smaller become the other

factors which determine the e.m.f., and therefore the tendency is to make the number as large as is possible from considerations of the maximum allowable heating and armature reaction, and though in the case of mains (where the chief consideration is that of voltage drop) we allow a current density of 1,000 amperes per square inch, we find the current density in most dynamo armatures varying between 1,800 to 2,500 amperes per square inch, depending on the maximum allowable temperature rise at full load, which again depends on c^2R . The Admiralty specify that the temperature difference between the room and the armature face must not exceed 30° F. one minute from the time the machine has been stopped after a continuous six hours run at full load, though twice this amount is often found in many machines.

The heat developed is dissipated principally by radiation from the armature surface, and if no other provision is made for cooling we must allow a certain amount of surface for any given temperature rise.

The heat developed represents so much power wasted, and is equal to c^2R in every case, and this again is proportional to the current density. The higher the current density for a given current, the smaller will be the sectional area of the conductors, and therefore the greater their resistance becomes.

Mr Esson gives a rule for finding the amount of surface necessary for any given temperature rise, thus:—

$$\left. \begin{array}{l} \text{Temperature rise in degrees C.} \\ \text{for drum armatures} \end{array} \right\} = \frac{250 \times \text{watts wasted}}{\text{surface in sq. cm.}}$$

$$\left. \begin{array}{l} \text{Temperature rise in degrees C.} \\ \text{for ring armatures} \end{array} \right\} = \frac{225 \times \text{watts wasted}}{\text{surface in sq. cm.}}$$

and for field magnet winding for a maximum depth of 7 cm.

$$\text{Temperature rise in degrees C.} = \frac{335 \times \text{watts wasted}}{\text{surface in sq. cm.}}$$

Armatures are, however, often ventilated, so that we get cold air drawn in through holes punched in the armature discs, and then by inserting small distance pieces at intervals in building up the armature core, spaces are left so that the cold air can find its way to the conductors on the surface, and so keep them cool. This is shown in the part section, Fig. 140.

The maximum current required from the dynamo being settled, the size of the conductors is also settled. Suppose the current required be 100 amperes, then each conductor must be able to

carry 50 amperes, and at say 2,000 amperes per square inch the sectional area of the conductors must be $= \frac{50}{2000} = .025$ sq. in. The sectional area of the insulated wire will of course be greater. The insulation commonly employed is a double layer of cotton which increases the diameter by about 20 mils. or .02 in., and therefore the sectional area of the wire with its insulation will be increased from .025 sq. in. to .0308 sq. in., and the number of wires we can get into the insulated slot and therefore the total number of conductors we can employ on the armature of given diameter is thereby determined.

We are limited in the width and depth of the slots, for by cutting the iron away at these parts we very considerably increase the density of the lines in the teeth, and consequently the magnetic reluctance in them is much greater than in the armature core below the teeth, and to increase the length and width of the slots unduly would cause the magnetic reluctance of the armature to greatly increase, for the teeth would be saturated with but a relatively small number of lines of force. Where a slotted armature is used, it is necessary when calculating the required excitation to find the density of the lines in the teeth. The ampere turns per centimetre required to produce this high density in the teeth will be much greater than for the remainder of the armature. But by embedding the conductors in the iron in this way it is possible to use a smaller air-gap, and on this account less ampere turns are required, but as we shall see presently where a short air-gap is used, the field should be exceptionally dense in order to obtain good commutation.

The shape and size of the slots vary in practice, depending on the size of the machine and on the voltage. The higher the voltage the larger must be the space allowed for insulation, or what is known as the space factor, that is, the area of the copper in the slot divided by the area of the slot must be greater for high voltages than for low. A common practice is to make the slots and teeth about equal in width, and the depth about $2\frac{1}{2}$ times the width; then, allowing for the space factor (which varies from .25 to .4 depending on the e.m.f.), the number of conductors that can be got on the armature is fixed.

The conductors are wound into a number of coils, the number depending on the allowable variation in e.m.f. per revolution, and on the permissible potential difference between adjacent com-

mutator bars, better commutation being assured by providing a large number with few turns. The number varies in large size, two-pole machines from 60 to 80, and these coils are all connected in series, forming a closed coil on the armature. If the core be built up of rings, the coils are wound by passing the wire through the slot and then inside the ring as shown diagrammatically in Fig. 142. In large machines with stout wire this is not an easy job, and therefore the larger sizes are usually wound with stranded wire. The space inside the ring becomes crowded, and unless wound by a skilful person it gets unsymmetrical, and there is danger of the insulation being injured in drawing the wires through.

It is only the length of conductors in the slots in this case

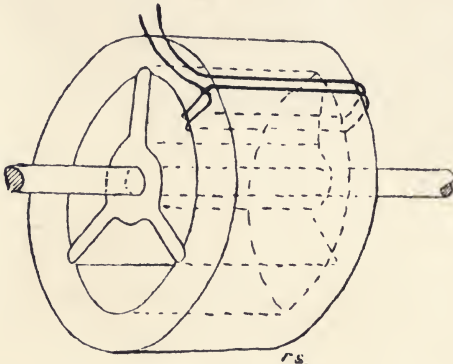

Fig. 142.

that helps to build up the e.m.f. of the machine, the portions of wire at the ends and in the inner part of the ring being simply connecting wires joining the different conductors in the slots in series. These connecting wires are a good deal longer than the active wires on the surface, and therefore add considerably to the resistance of the machine. If the iron in the armature is ample, practically all the lines of force will be conducted by the iron from pole to pole, and very few will cross the central portion, for the air space offers such a large magnetic reluctance compared with the iron of the armature. Any lines which do leak across this space are being cut by the inner connecting pieces, and an e.m.f. is thereby induced in these in opposition to that produced by the conductors in the slots. It is therefore essential to provide

sufficient iron to carry the lines, otherwise the e.m.f. developed at the terminals may be considerably less than we are expecting to get.

In the case of the drum armature, the conductor after passing through a slot is taken to a point near the other end of a diameter, and returns in the slot at that side, then is taken up to the first slot and through it again, and then across to the other side, and so on till the coil is wound up as shown diagrammatically in Fig. 143. In this case the wire at the ends only forms connectors, for each wire in the slots is doing its share at building up the e.m.f., and therefore there is a distinct advantage in making the drum armature longer than the ring, for the increased length of the

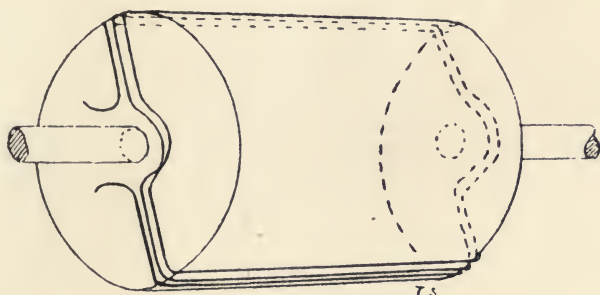

Fig. 143.

armature does not in this case alter the length of the connecting wires, and the percentage of active wire is therefore increased.

But if wound over with wire in the way described the wires must overlap at the ends and bulge round the shaft, not only taking up a large amount of valuable space, but also making it extremely difficult to repair an injured coil, for before any coil can be replaced, the whole of the winding above it at the ends must be removed, which in many cases means a complete unwinding of the armature. This, however, is overcome in the larger machines by employing special end-connectors.

These consist of thin sheet copper stampings nearly semi-circular in shape, shown in Fig. 144, each having a small lug at either end which is turned up at right angles to the main part, the whole piece with the exception of the lugs being very carefully

insulated with shellac varnish and thin pure silk ribbon, so that even when insulated, they take up but little room. If now half as many of these connectors as there are conductors in the slots be placed side by side edge-ways, with the lugs one behind the other, they will form a circle of a certain width, depending on the number of connectors with the lugs forming a spiral round the outside. It is evident that if we twist or stagger the connectors we could arrange the lugs as two circles instead of a spiral as shown in Fig. 140, and in this case there is no overlapping of the connectors. In large machines where this method is adopted the conductors are often made of rectangular bars of stranded copper wire or copper strip, and one or at most two bars per slot constitute the armature inductors.



Fig. 144.

These are arranged so as to overhang the armature at each end with alternate long and short bars in various ways, one of which is shown in Fig. 140. A cast-iron channel or box, circular in shape and wide enough to carry the end connectors, is insulated on the inside and fixed one at each end of the armature core, the diameter of this box being such that when the connectors are in place the lugs are on a level with the straight armature bars, and the bars are connected to their respected lugs. In some cases the box is cast in one piece with the armature end-plates. Consider the winding:—Starting with a long bar on the right, we arrive at the lug connected with it, and then spiral inwards to the lug on the other end of the same connector, which is connected to a short bar nearly opposite the long bar above, then through this short bar to the lug at the other end which spirals outwards, and the outer lug of the same connector is joined to the next long bar from the one we started with, and by continuing this all the way round, the winding will eventually close on itself, forming a continuous or short circuited coil. This is shown in extended form in Fig. 145. Here the armature is supposed to be flattened out, therefore from either end to the centre represents half the circumference of the armature. Fig. 146 gives in the same way another method of connecting where all the bars are of equal length, but alternate bars project, one at one end, and the next at the other end of the armature core.

When the conductors are large in sectional area, it is preferable to use stranded or laminated conductors instead of solid bars, because at the horns of the field magnet the density of the field varies considerably, and the leading and trailing edges of a large conductor may therefore be cutting through fields of different density, with a consequent difference of potential between the two edges. This would cause eddy currents to flow down one face, across the metal at the ends, and up the other face, and these currents are independent of the main current, simply wasting energy, and by heating the conductors, diminish the output of

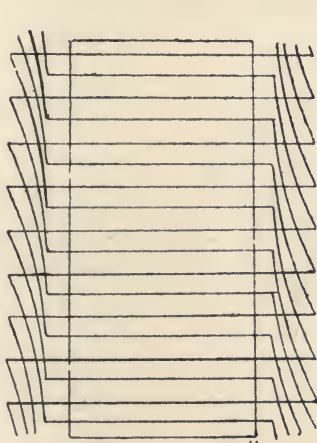

Fig. 145.

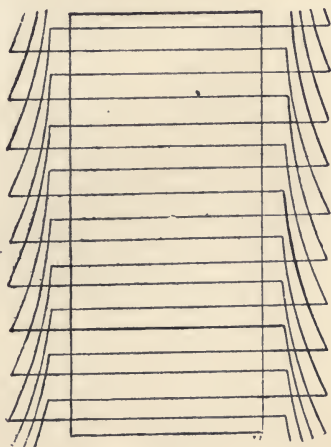

Fig. 146.

the machine. The e.m.f. so developed is very small, and the film of oxide formed on the stranded wire is often sufficient to prevent the eddy currents flowing, and being stranded, any one wire is partly in the stronger and partly in the weaker portion of the field, and the effect is therefore annulled. If copper strips are employed, they should be slightly insulated, and then a twist of 180° put on each conductor near its centre, which effectually prevents eddy currents in the conductor (see Fig 147).

We have now to consider the action of such an armature when revolved in a magnetic field such as that described at the end of Chapter VI. Take first the simplest case, namely, that of a single

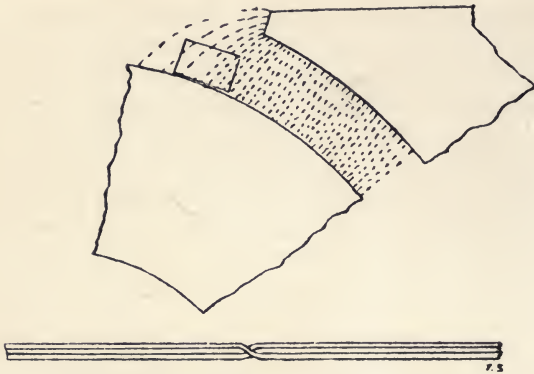

Fig. 147.

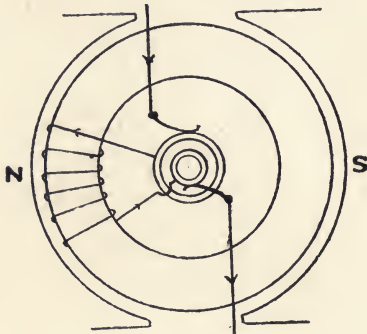
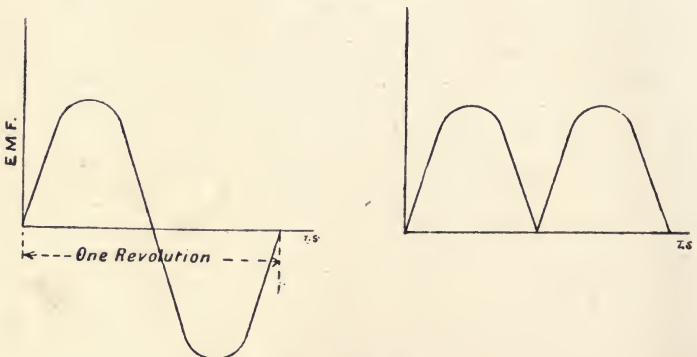

Fig. 148.



Figs. 149 and 150.

coil as shown in Fig. 148. The direction of the induced e.m.f. depends on the direction of cutting lines of force, and it will be noticed that the field is in the same direction on both sides of the armature, and therefore when the coil is rotated, the e.m.f. in it reverses in direction at each half revolution for its direction of cutting through the field reverses. If we should connect the ends of this coil to two insulated rings on the shaft and provide brushes to make contact with them, then in any circuit connecting the brushes we should get an alternating current with one complete alternation or period per revolution. Twice in a revolution the current would be zero, and twice it would have a maximum value, as shown in the curve, Fig. 149.

If, instead of having two insulated rings on the shaft, we pro-

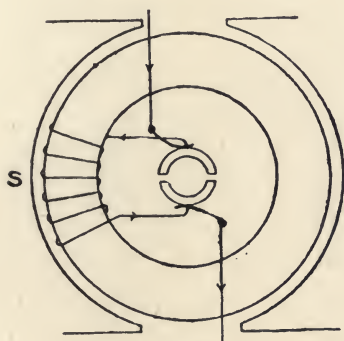

Fig. 151.

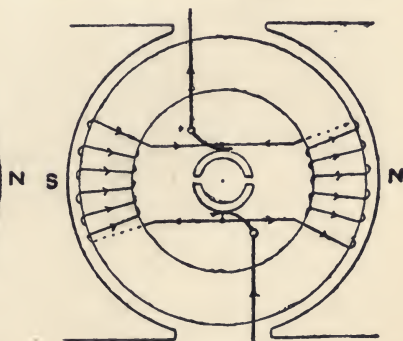

Fig. 152.

vide one only which has been cut across a diameter and the two halves mounted on the shaft to form one ring, but insulated from one another, and connect the ends of the coil to those half rings, we make the current in the external circuit unidirectional, for now when the coil has reached its position of zero e.m.f., the two halves of the split ring are changing contact with the brushes, that is to say, the top half of the split ring which has been in contact with the top brush while the coil has been moving up, now breaks away from the top brush and comes in contact with the bottom brush, remaining so while the coil is moving down, and the moment the coil commences to move up once more, the halves of the split ring change contact again. In this way, though the current in the armature coil reverses at each half

revolution, the current in the external circuit is made constant in direction (Figs. 150, 151).

If we place an exactly similar coil opposite the first, and connected it to the same two half rings (Fig. 152), we should have the two coils in parallel, and the resistance from one half ring to the other reduced to half its former value; and though we should get no increase in the e.m.f., still the capacity of the machine would be doubled, for each coil now carries only half the total current. If the external circuit is switched off, no current flows in the two armature coils, for they are then generating e.m.f.'s of equal value but opposite in direction, exactly as the two similar

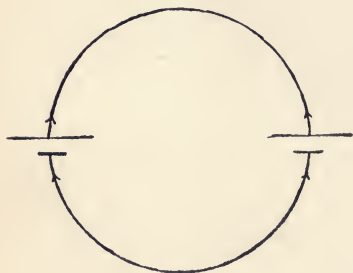

Fig. 153.

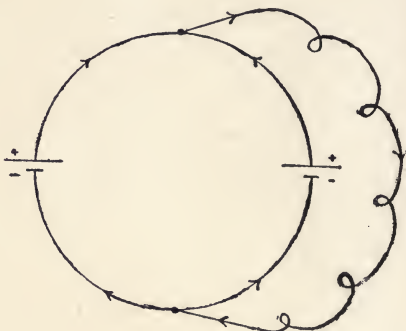

Fig. 154.

cells shown in Fig. 153 cannot send a current round their own circuit. The direction of the e.m.f. in these two coils with raised brushes should be carefully worked out by the student, and he will see that for any position of the coils the e.m.f.'s induced in them will be equal and opposite in direction, that is, tending to urge a current round the armature coils in opposite directions (see page 289). But when the external circuit is completed the two coils are put in parallel in the ordinary way, as represented in the case of the two similar cells in Fig. 154.

The current so obtained in the external circuit is very fluctuating and would be greatly improved by placing two other coils at 90° to the first two, so that when one pair is in its zero e.m.f. position, the other pair is generating its maximum e.m.f. But now the ring must be divided into four parts instead of two, and the coils

connected, as shown in Fig. 155. If we plot a curve of e.m.f. for these two coils we find we get not only a larger e.m.f., but also one that is much steadier, and which never at any part of a revolution falls below the maximum value obtained with a single pair. The curve is shown in Fig. 156, where A and B represent the curves of e.m.f. of the two coils separately, one being quarter revolution behind the other, and the resultant of A and B is shown by the curve C, which represents the variations in e.m.f. at the brushes.

On examination it will be noticed that the four coils on the armature are wound in simple series, the end of one being connected to the beginning of the next. There is no reason why we

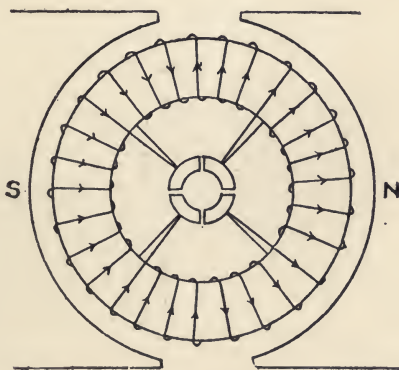

Fig. 155.

should not wind other coils in the spaces between the four coils we have wound on, connecting them up in series with the others in the same way, and providing a corresponding number of subdivisions in the split ring, or commutator as it is called. Every additional coil so put on increases the value and steadiness of the e.m.f. obtained at the brushes, as will be seen by considering the case of eight coils shown in Fig. 157. We might continue this reasoning till we had one commutator segment for every conductor on the armature, and the whole armature completely filled with winding. The latter is always done in practice, and we get our ring or drum wound armature, the construction of which we considered in the early part of this chapter, with all the conductors connected as a closed coil in series. But it is found that by subdividing the con-

ductors into about sixty parts the e.m.f. obtained is steady enough for all ordinary purposes, and consequently if there be say 240 conductors on the armature, then after every four complete turns we make a connection on to one segment of the commutator. In the case of the drum wound bar armature the connection to the commutator is effected by prolonging every second or fourth bar as the case may be, so as to be long enough to make connection to the end connector lug and the commutator lug also.

It has been pointed out that the e.m.f. developed depends not only on the number of lines of force being cut = N , and the number of conductors cutting them = c , but also on the

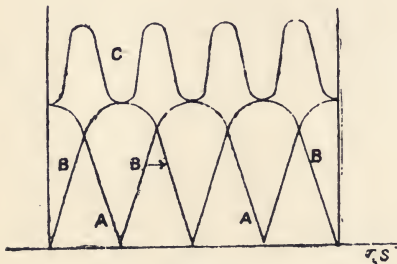

Fig. 156.

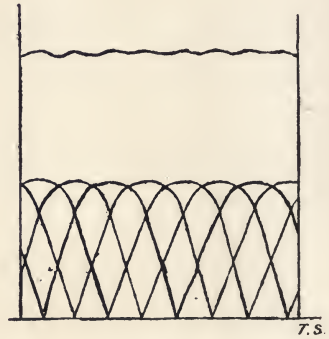

Fig. 157.

time taken in cutting. Now in one revolution of the armature every conductor cuts through the field twice, and therefore if s represents the speed of the armature in revolutions per second we might state the e.m.f. developed in the armature as

$$E = 2N \times c \times S.$$

But the conductors on the armature do not all develop an e.m.f. in the same direction. The two halves being in parallel, the e.m.f. is just half what it would be if the whole of the conductors developed an e.m.f. in the same direction. The e.m.f. developed by half the conductors is in fact as much as that developed by the whole number, so we must write

$$E = 2N \times \frac{c}{2} \times S = NcS.$$

In all practical work the e.m.f. is expressed in volts, and as the e.m.f. represented by NcS is in absolute units, we must divide by 10000000 or 10^8 , which is the number of absolute units equivalent to 1 volt.

$$\text{Therefore, volts} = \frac{NcS}{10^8}$$

(The student must guard against confounding c , which here stands for the total number of conductors counted all round the circumference of the armature, with c which we have used repeatedly to symbolise the current.)

With a given size machine, which is usually expressed in kilowatt units or units of 1,000 watts each, the speed is fixed within certain limits, for the larger the machine the heavier are its moving parts. In modern machines of this type (bipolar) the usual speeds adopted are:—

| | | | | | | | | |
|------|----|---------------|-------|-------|-------|-------------|-----|---------|
| 1 | to | 2.5 kilowatt, | 2,000 | to | 1,500 | revolutions | per | minute. |
| 2.5 | to | 5.0 | „ | 1,300 | to | 900 | „ | „ |
| 3.5 | to | 13.5 | „ | 1,000 | to | 800 | „ | „ |
| 13.5 | to | 35.5 | „ | 800 | to | 650 | „ | „ |
| 35.5 | to | 70 | „ | 700 | to | 500 | „ | „ |
| 70 | to | 150 | „ | 500 | to | 350 | „ | „ |

We have seen that the number of conductors it is possible to get on the armature in any given case is also fixed within certain small limits, and the only quantity variable to any extent is the total lines of force. The required number in any case is determined by transposing the equation $v = \frac{NcS}{10^8}$

$$\text{Therefore } N = \frac{v \times 10^8}{cS} \text{ and this number of lines of force must}$$

be provided in the armature so that all the conductors may cut through them. We cannot get them in the armature without having a large number of leakage lines, and as pointed out in Chapter VI., about 25 or 30 per cent. must be allowed for leakage, The amount of iron necessary and the ampere turns or excitation required to provide this field can then be found by the method explained in Chapter VI.

Presuming that we have the machine completed up to this point, how are we to magnetise the field magnet? The first method that suggests itself is to use a battery of accumulators, and by inserting an adjustable resistance in the field circuit, alter

the current flowing till we get the required excitation. This would form what is known as a separately excited machine (Fig. 158), of which we shall deal to a certain extent later, for it is used to a fairly large extent in central stations, though it is not so often excited from a battery as from auxiliary exciting bus bars as they are called. Another method would be to lead the current in the external circuit round the field magnets, and thus make it self-exciting. In this case, when the external circuit is open, there is no excitation, and consequently no e.m.f., and while there is no excitation there can be no e.m.f. But once a machine of this kind has been strongly magnetised, and in fact even if it has never

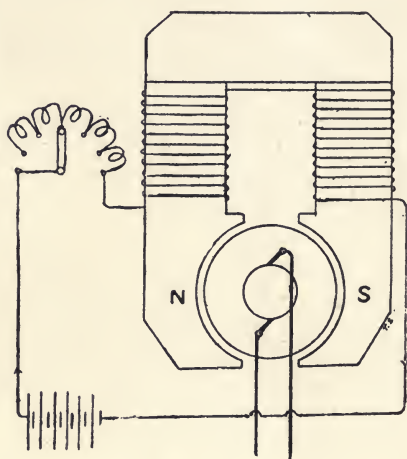

Fig. 158.

been strongly magnetised, such a large mass of iron always retains a certain small field, and when we close the external circuit, the e.m.f. slowly builds itself up, for first a very small e.m.f. is developed by the conductors on the armature cutting through the small residual field, and consequently a very small current flows in the external circuit, and therefore also round the field magnet. This increases the magnetisation slightly, and the e.m.f. and current increases with it, and at a certain stage with a small increase in the current flowing round the field magnets, the field increases at a very rapid rate, rising according to the permeability curve given in Fig. 21, but of course depending in part on the

permeability of the iron employed. The e.m.f. and consequently the current also rises very rapidly at this point, and soon reaches its fixed value for that particular resistance circuit, and the machine could only be used within certain small limits where the iron is saturated, for if used below this point any slight changes in the resistance of the circuit would cause very large changes in the e.m.f. and current, the magnetisation rising and falling rapidly as shown by the magnetisation curve. An increase in the resistance of the circuit with such a machine would of itself cause the current to decrease, and this causes the e.m.f. to fall, which again

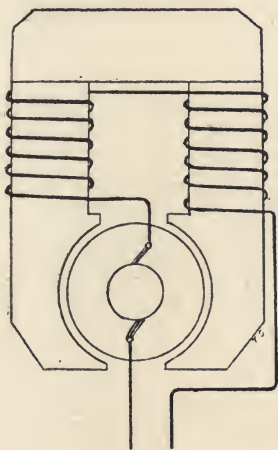

Fig. 159.

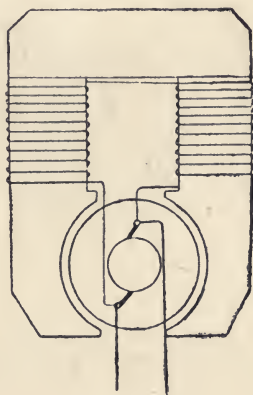

Fig. 160.

decreases the current, and therefore there is really only one particular e.m.f. for any given resistance, but owing to the iron becoming saturated at a certain stage, in which case small changes in the current do not affect the strength of the field to any appreciable degree, it is found practicable to work such a machine with a slight variation of load, though they are intended always for a constant load, and are known as "series" machines, for the field magnet winding is in series with the external circuit (Fig. 159).

We might, however, connect the machine in another way. If we wind the field magnets with coils of many turns having a relatively high resistance, we shall get the required excitation with a

correspondingly smaller current. For instance, if the dynamo develops 100 volts, and the resistance of these coils be 16.6 ohms, then the maximum current would be $\frac{100}{16.6} = 6$ amperes, and if led round 2,000 times would provide 12,000 ampere turns. It would not do to connect this magnetising coil in series with the main circuit, for even on short circuit we could not get more than 6 amperes through, and if we had any resistance in series with the coil we should get a considerably smaller current still. But the magnetising coils so wound can be connected direct to the armature in parallel with the external circuit, or as a shunt to it, in which case the excitation is very largely independent of the current

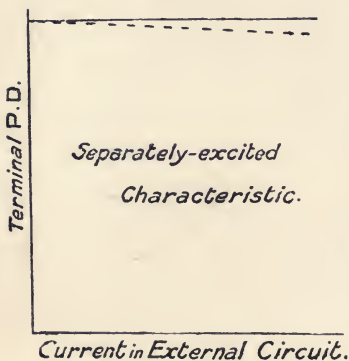

Fig. 161.

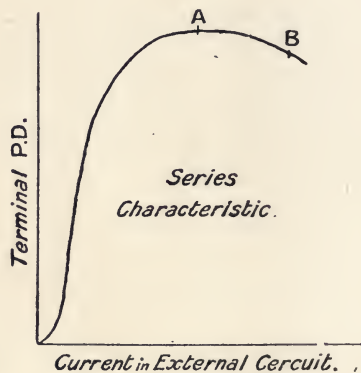

Fig. 162.

in the external circuit. Such a machine is shown diagrammatically in Fig. 160.

Considering these machines in the order in which they have been described, we notice that with the separately excited machine the field is independent of whether the machine is running or not, and consequently the moment it starts running an e.m.f. is developed, and at its normal speed it generates its normal e.m.f. If now a small current be taken from the armature, the p.d. drops owing to the volts spent in getting the current through the armature, and also armature reaction which we shall consider later, and the more the current is increased in the external circuit by reducing its resistance the more volts are spent in the armature.

The characteristic curve for such a machine when the excitation is fixed is a slanting line as shown in Fig. 161. But this can easily be made horizontal by adjusting the regulating resistance in the field circuit to increase the excitation as the load increases, and consequently we can arrange to have a constant difference of potential at the terminals with varying loads which is a strong point in its favour.

Referring now to the series machine. When the current in the external circuit is nought, the e.m.f. is also nought, for there is no field. As the resistance in the external circuit is decreased, the current increases, and with it the magnetisation and the e.m.f. rises on the magnetisation curve. If the load is

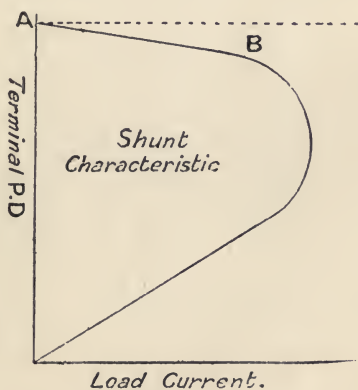

Fig. 163.

still further increased, the e.m.f. begins to fall, for the effects of armature reaction and volts spent in the armature are now—owing to the iron being saturated—not compensated by an increase in the excitation. If we plot the characteristic curve for the series machine, we have the shape shown in Fig. 162, which is the same as that for the magnetisation of iron, but with the top falling instead of rising. It will be noticed that the variations possible in the load are limited to such as come between the points A and B on the curve, for it is only between these points that the e.m.f. could be said to be sufficiently steady, and for loads smaller than these the magnetisation is in a very unstable condition, very largely fluctuating with slight changes in the load.

The characteristic curve of the shunt wound machine is given in Fig. 163. In this case, when the resistance in the external circuit is a maximum and the current in it is nought, the e.m.f. of the machine is also a maximum, for the field magnet winding is connected direct to the armature and is independent of the external circuit. As the load in the external circuit is steadily increased the armature reaction and volts lost in the armature also increases, and the terminal potential difference consequently slowly falls, which causes a smaller current to flow round the field magnets, this being dependent on the terminal p.d. and the resistance of the field magnet winding. While the iron is fairly well saturated, this slight decrease in the field magnet current makes but little differ-



Fig. 164.

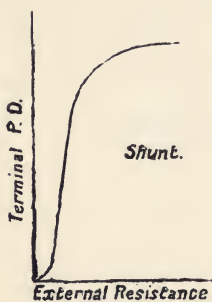

Fig. 165.

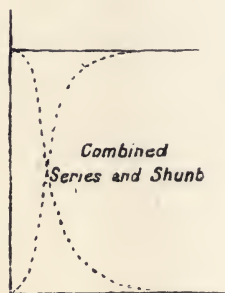

Fig. 166.

ence, but as the resistance of the external circuit is still further decreased and the terminal p.d. further lowered, the armature reaction becomes of relatively greater importance, and the exciting current becoming feebler, a point is eventually reached where the magnetisation is in its unstable condition and the e.m.f. drops to zero. In this case the practical working loads are those between the points marked A and B, and we get a slight fall in voltage with increasing loads from A and B.

If, instead of plotting the characteristic curves with p.d. and current, we take p.d. and resistance in the external circuit, we should get for the series machine the curve shown in Fig. 164. Here, when the external resistance is small, the e.m.f. has its maximum value, and as the external resistance is increased, the e.m.f. falls, at first slowly, then, at a critical point where magnetisa-

tion becomes unstable, at a very rapid rate down to zero. This is in fact the previous characteristic of the series machine reversed.

Plotting the same thing for the shunt machine, we have the curve shown in Fig. 165. Here, when the external resistance is very small, the e.m.f. is nought, for the field magnet winding is short circuited by the external circuit. As the resistance in the external circuit is increased, the current in the field magnet coils increases and the magnets get excited, the magnetisation and therefore also the e.m.f. rising on the magnetisation curve. This curve then is the opposite to that for the series machine, and it is evident that if we could combine the two machines we should have one that would keep a constant p.d. for all changes in the load from zero to the maximum (Fig. 166). This could be effected by running the two machines together connected in series. When the circuit is open, the p.d. due to the series machine is nought, but the shunt machine is generating its maximum p.d. As the load on the external circuit is increased, the p.d. due to the shunt machine falls, but that due to the series increases and keeps the e.m.f. in the external circuit constant. When the load is a maximum, and the e.m.f. due to the shunt machine falls to zero, the series machine would be generating its maximum p.d. The two machines so connected would require to be designed with this in view, but at best it would be a very expensive and inefficient arrangement, for we should be using two machines to supply a load which could be done by one of them apart from pressure regulation.

The same principle can, however, be applied to one machine, and we then obtain what is known as the compound wound machine, a diagrammatic view of which is given in Fig. 167. Such a machine is designed as a slightly under-saturated shunt machine, so that on open circuit we get the required p.d. as in ordinary shunt dynamo. Now as the load comes on, the armature reaction and volts lost in armature would cause the p.d. to fall, but the current which would so affect the voltage is now led round the field magnets a certain number of times and increases the magnetisation through the armature to an extent depending on the load, and so the e.m.f. is maintained constant. We could just as easily arrange for the e.m.f. to increase with increasing load and so allow for volts fall on the mains, thus maintaining a constant pressure at the feeding point though it be some distance from the

machine. This would be done by winding on a few more series turns than are required for maintaining the terminal p.d. constant. This is known as over-compounding the machine.

We have in this way combined the two machines, and we now have a self-regulating machine perfectly automatic in its action, and its characteristic curve can be made either a horizontal line or a steadily rising one as shown in Fig. 168.

Consider the armature when carrying a current, which we shall imagine to be supplied from some external source, while the field magnets are left unexcited. We notice that the conductors on each side carry currents in the same direction, while the conductors

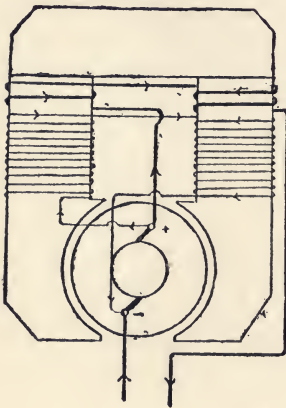

Fig. 167.

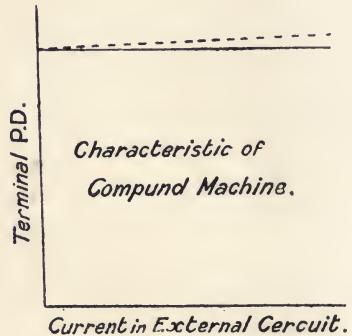

Fig. 168.

on one side carry currents in the opposite direction to those on the other side. The armature as a whole is therefore producing a cross magnetisation or a magnetic field across that which is established by the field magnet (see Fig. 169). Now seeing that we cannot have two magnetic fields in the same place at the same time, the result is that we get a field across the armature which is a resultant of the armature and field magnet fields. The armature field at both top and bottom strengthens at one side and weakens at the other the field due to the magnets with a consequent distortion, and when the machine is running fully loaded, the coils do not reverse in e.m.f. at points directly top and bottom, but at points further round in the direction of rotation, due to this dis-

tortion of the field by the armature currents (see Fig. 170). The brushes have therefore to be moved round to this point or just a little beyond it, otherwise there will be sparking at the contact of commutator and brushes, which has a very detrimental effect. This movement of the brushes which depends on the load (there being no distortion of the field on open circuit) is known as the angle of lead, and necessitates the brushes being provided with an adjustable swinging support called the rocker.

Suppose the armature to be divided up into 60 coils connected to a 60 part commutator in the manner shown in Fig. 155. The brushes will short circuit at least one of these coils, and in some

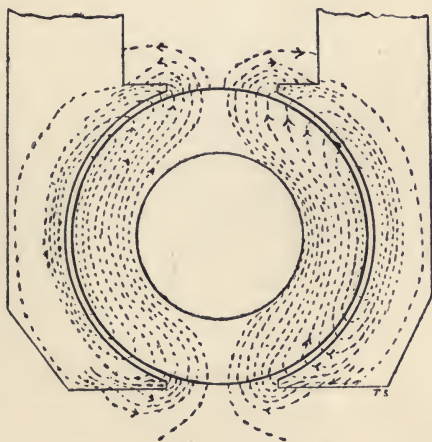

Fig. 169.

cases two together, as they pass from one side to the other. The short circuit on any one coil lasts but a short time, for if the armature be running at say 10 revolutions per second, then one coil forming only $\frac{1}{60}$ of the whole will be short circuited for something like $\frac{1}{600}$ of a second twice in each revolution.

Now up to the moment of its being short circuited by the brush the coil has been carrying a current equal to half the total current flowing in the external circuit, and in the $\frac{1}{600}$ part of a second this current has to be stopped, the e.m.f. in the short circuited coil reversed, and a current equal to half the external current, but in the reverse direction, started in it; and if this be done before

the short circuit is broken the coil will break away from the brush without any sparking, but not otherwise. The only way to accomplish this is to give the brushes a further angle of lead, so that the coil when on the point of being short circuited by the brush is cutting through the field in the reverse direction, so that this particular coil is developing an e.m.f. contrary in direction to that which is urging the current through it. This reverse e.m.f. on short circuit very rapidly stops the current flowing against it and starts another in the opposite direction. If the current in the short-circuited coil has not reversed on the short circuit being

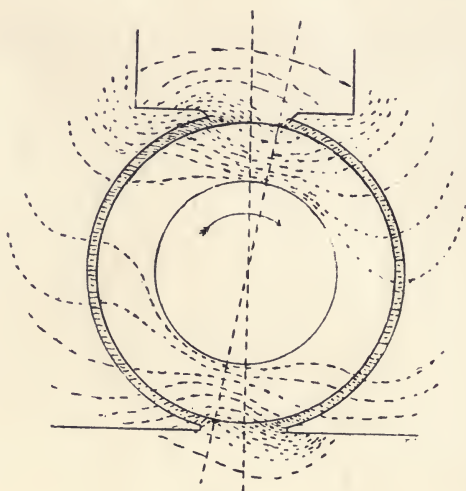

Fig. 170.

broken, the current in it will be opposing the current in the other coils on the side to which it has now been connected, and the two will both tend to arc across from the receding commutator bar to the brush as shown by the arrows in Fig. 171.

Mr Mavor states that for good commutation the number of ampere conductors or ampere bars per pole on the armature should not exceed 10,000 per centimetre length of the air-gap, while Mr Esson gives the rule—

$$\text{Total ampere bars on armature} = \frac{288 I H}{\phi}$$

for sparkless commutation, where l = length of air-gap in centimetre, H = lines per square centimetre in the air-gap, and ϕ = the angle between the pole horns and the centre of armature in degrees.

This angle of lead gives rise to another effect, for now a certain number of conductors are carrying currents in such a direction as to produce a back magnetisation or a magnetisation directly opposed to that of the field magnet. This has the effect of weakening the field, with a consequent fall in the terminal p.d., unless the machine be compounded to make up for the drop in volts. The conductors inside the pole faces can be considered as producing a cross magnetisation, while the remainder, *i.e.*, those between the horns, are carrying currents in such a direction as to

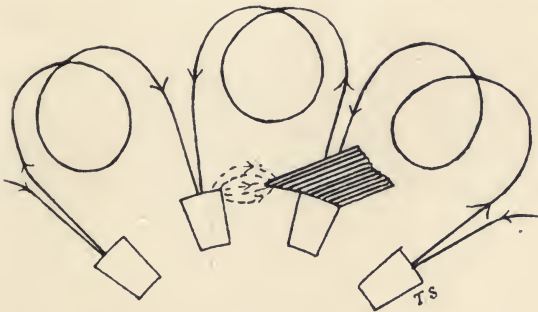

Fig. 171.

produce a back magnetisation. Suppose this number of conductors be 20, and the current in the external circuit be 100 amperes, then as each conductor on the armature carries only half the external current, we have 20 conductors on the armature carrying 50 amperes, which is giving us a back magnetisation of $10 \times 50 = 500$ ampere turns, for it requires 2 conductors to make one turn, and to counteract this, if 100 amperes be the full load current, we must provide an additional 600 ampere turns in the series coil; that is to say, we must wind on six additional series turns, so that with the full load current of 100 amperes we get an extra magnetisation due to $100 \times 6 = 600$ additional ampere turns, which allows for waste lines.

It is evident that if the field magnet was magnetised to a high degree or stiffened the pole tips would be highly saturated, and the

distorting effect of the armature current would be considerably less owing to the high reluctance introduced into the circuit, and the necessity for adjusting the position of the brushes for changes in the load would be decidedly less. In most modern dynamos this is done to a great extent, and we find that in many machines there is no sparking at the brushes within the ordinary variations of load, and in many cases even on a large overload though the brushes be fixed in position.

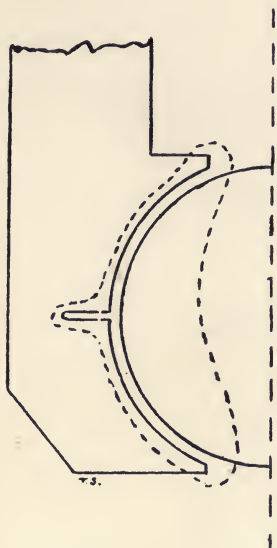

Fig. 172.

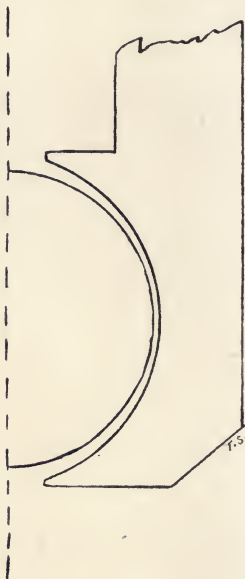

Fig. 173.

Devices have been tried for preventing armature reaction, many with a certain amount of success. In every case the method adopted is to put a large reluctance in the armature cross magnetisation circuit without affecting the main or field magnet reluctance. To effect this in one case a deep cut is put in the field magnet pole pieces, parallel with the lines of force, as shown in Fig. 172. This does not appreciably affect the magnetisation of the field magnet, but considerably increases the length of the lines due to cross magnetisation.

In another case the field magnets are bored to a larger diameter, then when fixed, so as to give a small air-gap at the centre, the air-gap at the pole tips is considerably larger, and the reluctance at these parts is also greater (see Fig. 173).

Still another method is that shown in Fig. 174, where the pole tips are made of cast-iron. Owing to the smaller permeability, the cast-iron tips become highly saturated, and therefore the reluctance at this part is considerably increased.

In the large multipolar machines made for the Blackpool Electric Railways the pole pieces are connected all round by a

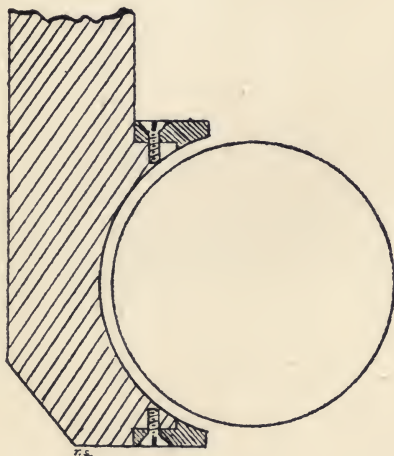

Fig. 174.

thin prolongation, bored out at the centre, as shown at Fig. 175. These polar shoes become highly saturated, being so thin, and so put a large reluctance in the cross magnetisation circuit. These have been found to give very good results.

But where very strong fields are employed the polar tips become highly saturated, even without any of the special devices just described, and this is often quite sufficient to prevent any large amount of armature reaction, consequently it is becoming more and more rare to find machines that require adjustment of the brushes with varying loads. In fact many machines can now

be run from no load to 50 per cent. overload without any sparking worth mentioning, especially where carbon brushes are employed and the ampere turns per commutator bar are small.

With slotted armatures the field at the pole tips suddenly jumps or snaps across from one tooth to the next, and tends to be carried down across the polar tip by the tooth for a short distance before it snaps across to the next tooth. This prevents a steady growth of the reverse e.m.f. in the short-circuited coil under the brush, which therefore makes good commutation more difficult. It also causes eddy currents to be induced in the pole tips owing to the swinging of the field at these points. In smooth core machines there is none of this effect, and to approximate to the

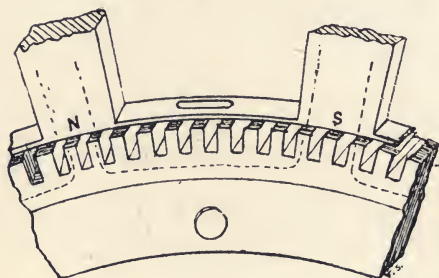

Fig. 175.

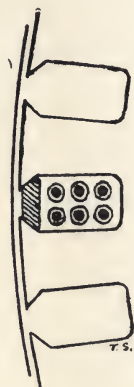

Fig. 176.

smooth core the slots are often made as shown in Fig. 176, space being allowed for the insertion of one wire only at a time. This necessitates the armature being wound by hand, whereas with the larger multipolar machines the armature coils are often wound on formers and dropped into position on the armature.

Some makers cut the pole tips aslant so that one end overlaps the armature more than the other. This causes the field to more gradually jump across a coil at this part; the coil as it were shears through the field rather than snapping across it, with a correspondingly slower rise in the e.m.f. of the short-circuited coil.

Other makers effect the same result by keeping the pole tips straight but staggering the armature slots; the staggering in this

case should not be greater than the distance between one slot and the next.

When the machine is unloaded, the engine driving it is doing very little work, simply overcoming the friction of the bearings and the air, and making up for the hysteresis losses in the armature (see Chapter VI.). The engine is consequently consuming very little steam, and if nicely governed only enough steam passes to run the dynamo at its normal speed. The moment we switch on to the external circuit and take a current, the governor falls, and

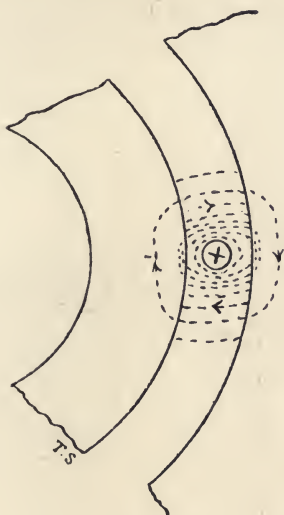

Fig. 177.

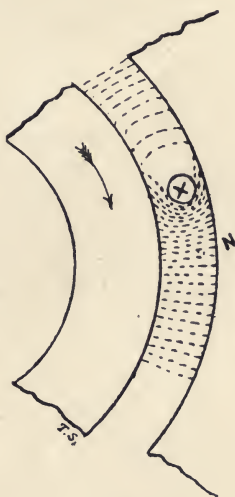

Fig. 178.

more steam is admitted to keep up the speed, and at full load the engine is working at its maximum rate. How is this power absorbed or transformed by the dynamo? We can study this best by considering one conductor only. Fig. 177 shows one conductor on the armature (distorted so as to make the point clear) carrying a current. It therefore creates a magnetic field which is slightly distorted from the circular shape due to the iron of the armature and field magnet. The point to be noticed is that the magnetic field above the conductor due to the current in it is opposite in direction to that below it, as shown by the arrows. If

now the field magnet be excited, we have a further distortion, for the field due to the current in the conductor and that due to the field magnet add together at one part and subtract at another part; that is to say, the field due to the current in the conductor is strengthening the field of the field magnet at one part and weakening it at another part, and we get a crowding of the lines at the part where the two fields are adding their effects and a thinning out where they subtract, as shown in Fig. 178.

The power developed in the engine is spent in dragging the current-carrying conductors in this way through the magnetic field, for the lines of force would of themselves urge such a conductor in the opposite direction, and if with the same direction of field we sent the same current through the armature conductors from some external source, we should get the armature rotating in the opposite direction as a motor. This action takes place with every conductor in the field, and to keep the current flowing we must continue to drag the conductors through the field, overcoming their tendency to go in the opposite direction.

We saw in Chapter V. that when current-carrying conductors are in a magnetic field they exert a force urging them at right angles to the field equal to Hc , where H is the intensity of the field, c the current in absolute units, and l the length of the conductor in centimetres. Suppose in any given case the intensity of the field in the air gap = 12000, and each conductor carries a current of 50 amperes or 5 absolute units, while the length of the conductor in the field = 50 cm., then each conductor experiences a force of $12000 \times 5 \times 50 = 3000000$ dynes. And if there be say 150 conductors in this field (considering only those within the polar faces), the force in dynes exerted by the armature conductors tending to drive them in the opposite direction to that due to the action of the engine is = 450000000 dynes, or 1012 lbs. And if the armature be say 12 in. diameter, and running at 600 revolutions per minute, then in each revolution the conductors are dragged through 3.14 ft., and in one minute the force of 1012 lbs. is exerted through 1884 ft., and the work done = $1012 \times 1884 = 1906608$ foot-pounds per minute, and this is equivalent to working at the rate of $\frac{1906608}{33000} = 57.7$ h.p. The engine must therefore provide in this supposed case 57.7 h.p. in simply dragging the current-carrying conductors through the field against no mechanical

restraint whatsoever, and we therefore see where the power developed in the engine is going. Of course the engine must provide also for the power required to overcome the mechanical frictions and hysteresis losses, but in well-designed machines these will be small.

It may be noticed in passing that a very simple rule connecting together the direction of the field, the direction of motion, and the direction of current, is given by means of the outstretched hand. The thumb normally stands at right angles to the first finger when outstretched, and if now the other three fingers are bent inwards, leaving the thumb and the first finger in their original position, we have three directions indicated, any one of which is at right angles to the plane containing the other two. Let the first finger point in the direction of the field (from *N* to *S*), the thumb in the direction of motion of the conductor in the field, the three fingers then point in the direction in which the current flows in the conductor, or the direction of the induced e.m.f. if the circuit is incomplete.

If the machine be a motor, and the direction of the field and the current be the same as that in Fig. 178, then the conductors will move in the opposite direction to that which is required for generating the same direction current in a dynamo. But it will be noticed that this reverse direction is indicated if we use the left hand instead of the right, and therefore for the dynamo we have the right hand rule, while for a motor we have the left hand rule.

The split ring commutator described earlier, is of course inadmissible, except for very small machines, for with the larger currents required in practice the commutator parts would get very hot owing to the high current density in them. They must therefore be made in a much more massive and substantial manner. Fig. 179 shows half section, half elevation of a commutator, which is built up separately on a cast-iron sleeve and keyed on to the shaft at one end of the armature after the latter is wound. In practice the armature is wound with separate coils, the ends of each projecting, and these are connected in series by the commutator segment being soldered to the end of one and the beginning of the next.

The commutator sleeve on which the whole is mounted has a coned head turned on the inside as seen in the section, and inside this a mica cone is built up by fixing together very thin

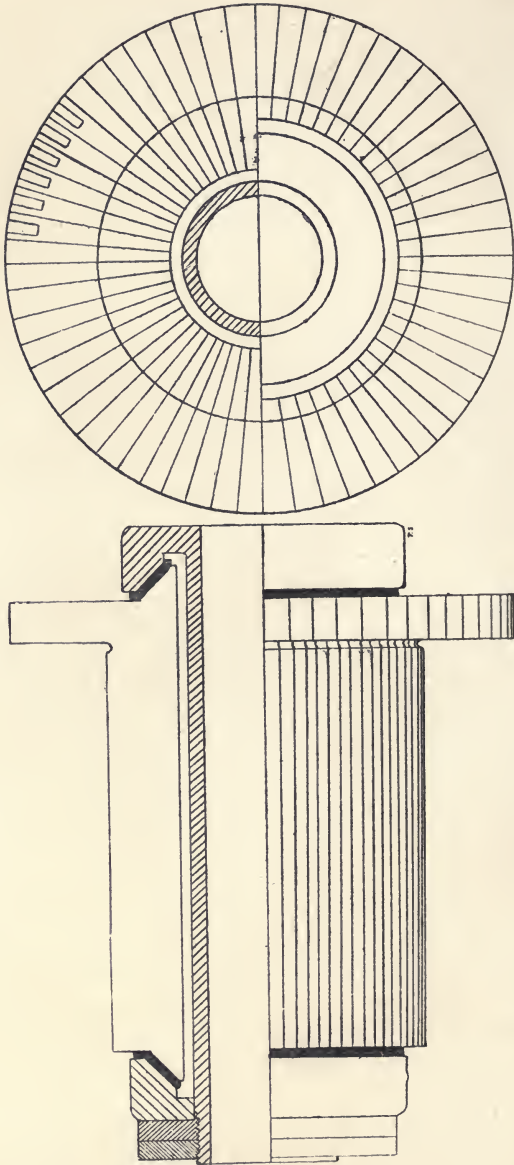

Fig. 179.

strips of mica cut to shape, with shellac varnish, pressing each strip down firmly till the shellac has dried. This is facilitated by keeping the cast-iron sleeve warm. A similar mica cone is built up in a coned washer which slips over the sleeve at the other end of the commutator, and the segments are turned at both ends to the same taper as the mica cones, and are supported by them. Each segment or bar of the commutator has to be insulated from its neighbour, and the insulation universally employed for this purpose is mica. The e.m.f. between any one bar and the next is only that created by one coil of the armature; that is to say, if a sixty-part commutator be employed, and therefore sixty coils on the armature, each side of the armature, or thirty coils, will develop the full e.m.f. of the machine, and one coil will develop $\frac{1}{30}$ of the total e.m.f., supposing all coils to be moving in the same strength field. But we know that a coil generates its maximum e.m.f. when midway between the brushes, consequently it is this maximum e.m.f. that we must provide insulation for, which will be more like $\frac{1}{20}$ of the total in the above case. Even so, the e.m.f. between any two bars connected to a coil developing its maximum e.m.f. is much smaller than that at the terminals, and therefore the thickness of insulation between the segments need not be great, from $\frac{1}{32}$ to $\frac{1}{16}$ in. being commonly employed. Owing to the liability of sparking at the brushes, mica is the only serviceable material that can be used, for ebonite, vulcanised fibre, and such substances would carbonise and become conducting, while glass, porcelain, &c., are far too brittle to withstand the pressure imposed on the commutator. Other very good insulators, such as paraffin wax, are of course out of the question altogether.

The commutator bars are made of copper or gun-metal castings or of hard drawn copper, which is sawn up into the required lengths, the length depending on the maximum current taken from the machine, for whatever this be, we cannot allow more than a certain current density in the contact between the brushes and commutator segments (about 250 amperes per square inch), and the larger the current, the more numerous must be the brushes to collect it from the commutator. These bars are cast or drawn taper in section, as shown in the end half section in Fig. 179, and are machined or filed down to a gauge set to indicate the required taper, so that a given number of bars, when put together with the mica insulation between each, will form a tight compact circle (Fig. 180). This

is very essential, for if a bar or bars be loose, the connections will sooner or later break off with the vibration; there will also be sparking at the brushes, and bits of copper and dust from both brushes and commutator will find a way in and eventually short circuit the coil.

The mica strips are now gauged and thinned down by stripping a little off, or built up by shellacing thin strips together as the case may require, and the bars are then arranged round a mandrel with

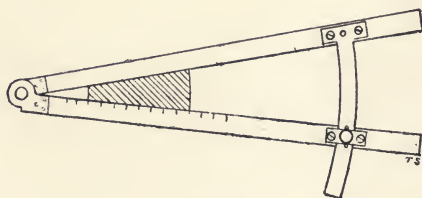

Fig. 180.

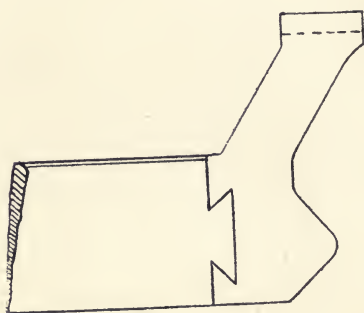

Fig. 181.

the mica between each and bolted together with two strong clamps. It should then be impossible to get the thin edge of a knife-blade in between any segments, and if this is possible, the whole must be taken apart and a very thin strip of mica added with shellac varnish and built up once more. This is then put into the lathe and turned at the ends to fit the mica cones.

If the bars are cast, a lug or connector is cast on the end of each so as to facilitate connecting the armature winding. If made from drawn copper bars, a separate connector must be fixed to

each bar by one of the various methods adopted, some of which are shown in Figs. 181-183, and need no further explanation than to state that in every case they should be mechanically fixed as well as soldered, by pins or dovetailing, this being done before the commutator is built up.

When turned, it is placed on the cone in the head of the cast-iron sleeve, and the second mica cone placed over the other end, then the coned washer slipped on. The whole is firmly clamped together by a nut or nuts screwed on the end of the sleeve, and the commutator is then built up ready to be fixed in place on the shaft. When so fixed, a fine cut is taken from the surface in the lathe to make it quite true.

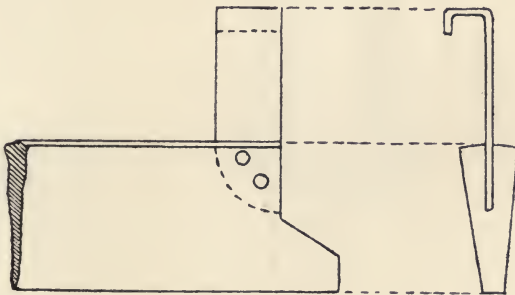

Fig. 182.



Fig. 183.

The shafts of all such machines are made thicker than would be considered necessary for any other machine, for not only is the speed usually fairly high for the weight, but the amount of deflection or bending allowable is practically *nil*, there being usually such a small clearance between armature and pole pieces. Again the whole of the power developed by the engine has to be transmitted through the shaft from the pulley to the armature conductors, and consequently the twisting effect on the shaft is often very large. The armature core, however, forms very good stiffening to the shaft, just at the point where it is most required, and this effect is greater with the drum than the ring armature, and can be taken into account in designing the shaft.

The bearings also require special attention. Seeing that very

little or no wear can be allowed owing to the small clearance, they are often made of the solid type, and where split bearings are used, it is simply to facilitate the inserting or removal of the armature. The weight being great, and the speed high, the length of the

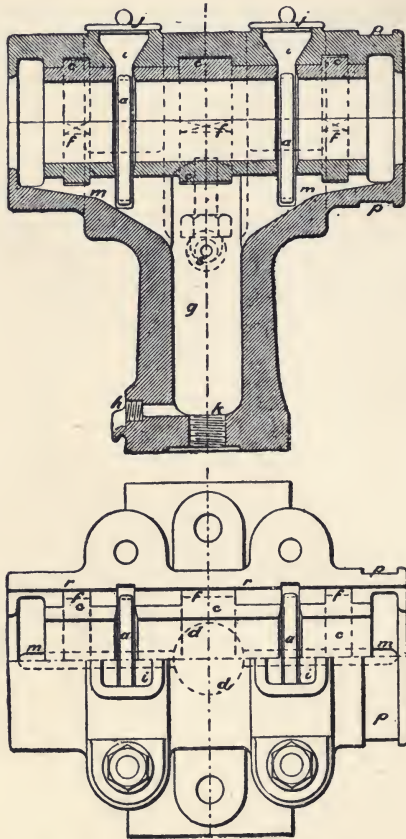

Fig. 184.

bearings should not be less than four times the diameter of the journal (that part of the shaft which rests in the bearing), and the lubrication should be continuous and automatic in its action. In the larger machines the oil is often forced through by a small pump worked from the end of the dynamo shaft, and so while running,

a perfect circulation of the oil is assured. In the smaller sizes the pedestal is often made into an oil tank (*g*, Fig. 184), and the brasses being cut through at the upper surface at one or two points, a ring, or endless chain, is slipped over them, and as the shaft rotates, it carries round the ring or chain, the lower end of which dips into the oil well, and so the oil is carried up by it to the shaft continuously (*a*, Fig. 184).

The brasses are very often lined with white metal, and when worn, can be easily renewed by melting out the old and running in a new lining, the armature being supported temporarily in the centre during the process. Hoods are often provided at the ends of the bearings, and a small ring fixed on the shaft inside the hood throws off any oil which tends to creep along the shaft, and so prevents it getting to the commutator. A section of such a bearing is shown in Fig. 184.

The field magnet coils are usually wound on frames or bobbins made by connecting together two brass or gun-metal end-plates by a sheet-iron strip, the ends of the coil being brought through the end-plates in insulating bushes to terminal boxes, where they are connected in series as required.

There is practically no difference in designing the bed-plates of dynamos to that of any other machine, due allowance being made for the weight, speed, and position of the moving part. They are almost universally made of the inverted box pattern (Fig. 186), which gives a maximum of strength and stiffness with a minimum of material. The bed-plate has to be designed to suit the type of dynamo, there being two distinct types of bipolar machines, the overtyping and the undertyping. In the former, the armature and field magnet are turned upside down with respect to their positions shown in Fig. 158, so that the yoke is on or in the bed-plate, for in this pattern the yoke is very often made of cast iron, and is cast in one piece with the bed-plate, being made larger in section to make up for its lower permeability, the field magnet limbs being bolted on at their lower ends. The cast bed-plate yoke necessitates a further stiffening of the bed-plate, for there is such a great inequality in the distribution of the metal. When cast, the bed-plate proper will have solidified while the mass of metal forming the yoke is still fluid. When this solidifies later, it contracts, and in so doing tends to break away from the thinner portions.

The overtyping machine is only employed for the smaller sizes, for vibration is much greater owing to the length of the pedestals required, and with the larger machines this method is practically impossible. But with the undertyping machine it is essential to support the field magnets on some non-magnetic material, or magnetic insulators as they are sometimes called, for if they be bolted direct on to the bed-plate, we should have a very large portion of the field passing round the bed-plate instead of through the armature. The field magnets are therefore supported by massive brass,

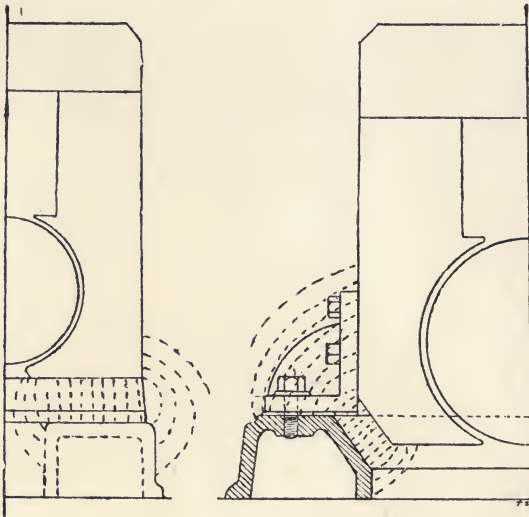

Fig. 185.

Fig. 186.

zinc, or gun metal brackets, so as to stand 3 to 6 in. clear of the bed-plate, and even when so supported we still get a fairly large leakage field through the bed-plate (see Figs. 185 and 186), which is entirely avoided in the overtyping, but the far superior mechanical arrangement of the undertyping for any but small sizes altogether outweighs the extra loss due to magnetic leakage.

Consideration of the larger unit multipolar machines must be left for the next year's course.

The current developed in the armature has to be collected by brushes pressing on the commutator segments. These are made

either of copper or carbon, the brush holders being designed to suit. Arrangements must be made for feeding the brushes forward as they wear, and to allow any brush to be raised, and held off, while the machine is running. Carbon brushes offer more resistance than copper, not only in the specific resistance of the substance, but also, and more particularly, in the contact resistance. This extra resistance, though it makes a very great difference in the resistance of the circuit formed by the coil which is short

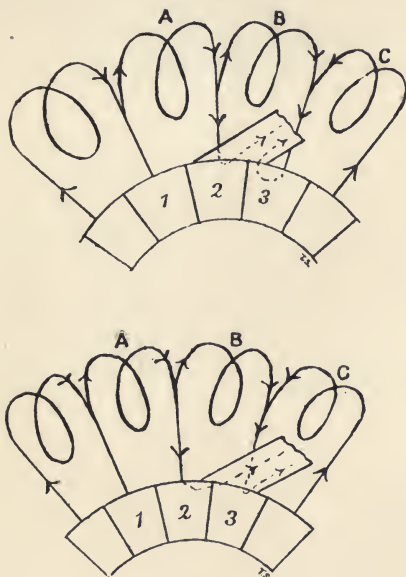

Figs. 187 and 188.

circuited by the brush, does not appreciably affect the resistance of the whole circuit, and it often has a very beneficial effect on the sparkless commutating properties of the machine. Consider Fig. 187. The current is here flowing out by the carbon brush, and the coil B becoming short circuited by the brush, has a relatively high resistance put into its circuit which soon reduces its current to zero. The current from coil A now divides at the brush, the larger portion going through the brush direct, and a small portion passing round coil B to the brush, for the brush and

coil B are in parallel. As the coil moves further round more of the brush comes into contact with segment 3, and less with segment 2, till finally it is only just in contact with segment 2 (Fig. 188). As this proceeds the resistance from 2 to 3 across the brush is steadily increasing, and consequently a larger and larger fraction of the current in A passes through B to the brush, till finally as the brush breaks away from 2, there is little or no current flowing in that segment, and consequently we get no spark at the break. This enables the machine to be run with fixed brushes with large variations in the load, often from zero to full load, and the substitution of carbon for copper brushes has often prevented sparking in machines that before gave trouble in this respect.

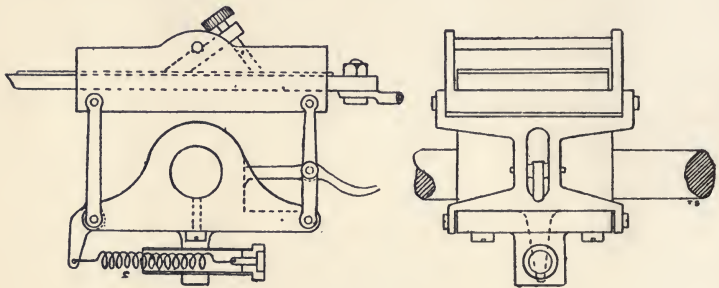

Fig. 189.

There is one disadvantage, however, in using carbon brushes: we cannot allow so large a current density in the brush contact, otherwise they would get exceedingly hot. The maximum allowable current density found in practice is 50 amperes per square inch against 250 amperes with copper brushes, therefore for any given current the commutator must be longer, and this means also a longer shaft and bed-plate, and therefore a more expensive machine.

The brush holders should be designed to feed with a parallel motion, not a circular one, as was common with the earlier machines, for as the brushes wear, we require them to preserve their position on the commutator. A simple form of brush holder used by Messrs Holmes & Co. of Newcastle is shown in Fig. 189. The pressure of the brush on the commutator can be regulated by the spring *s*, the tension of which can be adjusted by turning

the milled head attached to the threaded brass tube. The small trigger on the right enables the brushes to be held off for trimming or resetting. The holder is firmly clamped to its spindle, which is long enough to take 2, 3, 4, &c., brush holders side by side, depending on the current to be collected.

The spindle is fixed to a movable arm which is free to rotate through a small angle, and is insulated from it by ebonite or vulcanised fibre bushes and washers. The rocking arm or lever extends at both sides of the shaft, and carries a brush spindle on

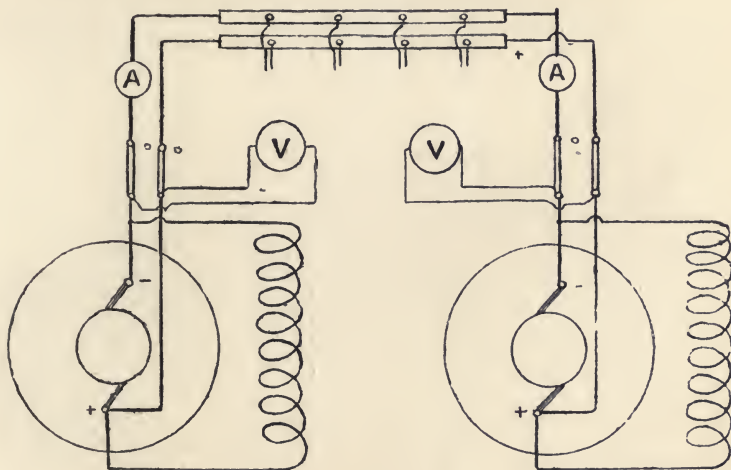

Fig. 190.

both sides. The rocker is supported in a groove turned on the end of the bearing (see *p*, Fig. 184), and is fixed in any desired position by a clamping screw.

We are now in a position to understand why it is that a shunt wound dynamo is the only machine that will do for charging accumulators, as mentioned in Chapter VIII., and also why special precautions have to be taken in connecting two or more series or compound wound machines in parallel. Suppose we have a shunt machine working, and supplying a load to some premises. At a certain point as the load increases it becomes necessary to connect another machine in parallel with it to help with the load. The only precaution necessary in this case is to run up the second

machine till it is giving exactly the same e.m.f. as the loaded one before switching it in. No current then flows either one way or the other through the machine just put in, and the engine valve being now turned full on, and the excitation being increased by adjusting the field resistance, the e.m.f. of the last machine rises till it takes its share of the load, and the two run together without any further trouble. Should one machine tend to slow down for any reason, its e.m.f. falls, and its load is decreased, tending to bring up the speed again, and in an extreme case the load may go

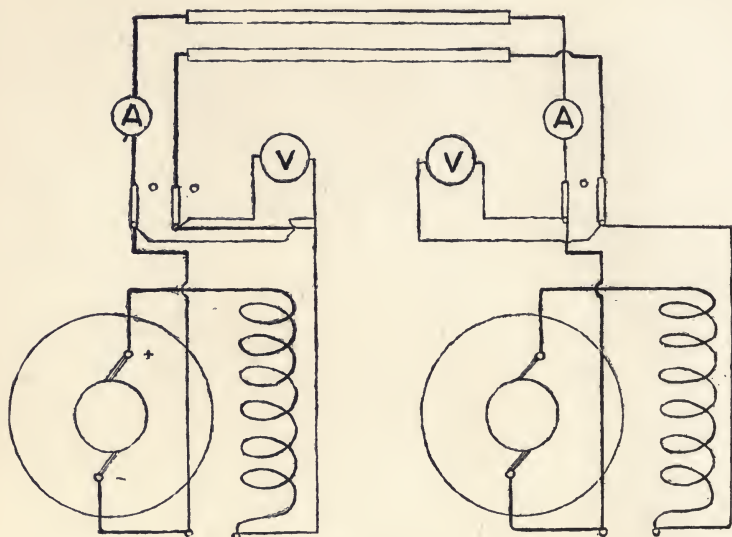

Fig. 191.

altogether and a current from the second machine be sent round it. This drives it as a motor at practically its normal speed, and so develops a back e.m.f. in it nearly equal to its normal e.m.f., which prevents any but a small current flowing round it from the second machine. The connections for this arrangement are shown in Fig. 190.

If two series machines are to be run in parallel, we have to guard against what may be a disastrous effect. Suppose we have the two machines coupled in parallel in the ordinary way, as shown diagrammatically in Fig. 191, and the governor of one engine

failed to act for a short time, or anything should happen to cause one machine to develop a slightly lower e.m.f. than the other, a current will flow in the opposite direction through it from the machine with the higher e.m.f. This will run it as a motor, but in so doing it will reverse the polarity of the field magnet. Now, when the engine starts driving at its normal speed once more, the machine again develops an e.m.f., but it is now in the reverse direction owing to its polarity having been reversed, and conse-

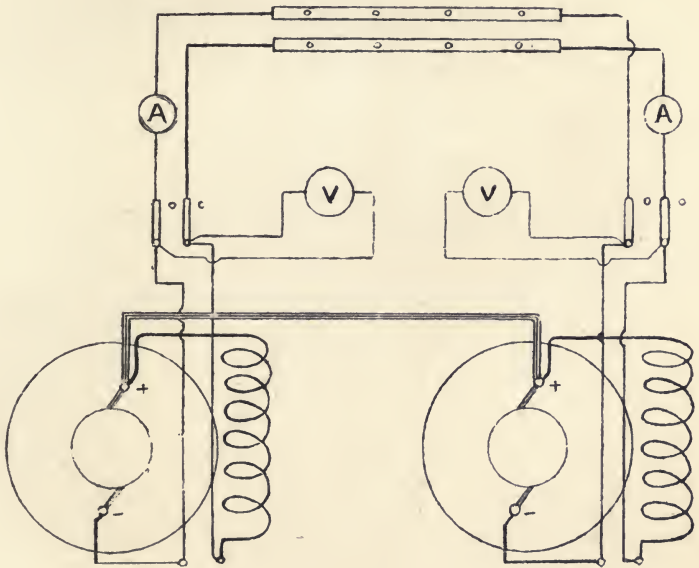

Fig. 192.

quently the two machines are in series instead of in parallel, and the e.m.f. being doubled, while the resistance of the circuit is very small, a very large current flows round both machines till they are burnt out.

Exactly the same action is liable to occur in charging accumulators with a series machine, for should the e.m.f. of the machine fall below the back e.m.f. of the accumulators, its polarity will be reversed, and on speeding up it will be in series with the cells, and both dynamo and cells will be destroyed by the excessive

current that would flow round them. It will be seen on examination that this could not occur with the shunt wound machine, for whether the current be flowing from the machine or to it, the current through the field magnet coil will be in the same direction, and the polarity cannot be reversed.

Two series machines may be run in parallel if we connect the two positive brushes together by a short piece of thick cable (Fig. 192), for should one then fall in e.m.f. below the other, a large current will flow through this connector to the brushes, dividing here through the armature and through the field magnet coil, but in the same direction in the latter as normally. Therefore by providing this low resistance connector we avoid the possibility of a burn out. The same applies to the series winding of the compound machine, and the same remedy is applicable in this case. No connector, however, will prevent the possibility of accident in accumulator charging with series machines, for they are not working in parallel but in opposition to the cells, and the only safe machines to use for this purpose are shunt and separately excited dynamos.

CHAPTER XVI.

DIRECT CURRENT MOTORS.

IF an electric current be sent through such a machine as that described in the last chapter, from some external source, it immediately rotates as a motor, giving mechanical energy at the pulley, for all electric motors and dynamos are reversible machines, and a well-designed dynamo will always make a good motor. But where a motor is required it is often advantageous to considerably alter the design from that of a dynamo for various reasons. When the motor has to run in an exposed position it is common to completely enclose it in iron, making the magnet yoke into an iron case for the armature. Then again, as it is often impossible to attend to the movement of the brushes with changes of load and even with changes of direction of rotation, it is usual to employ stronger fields and carbon brushes, which are fixed permanently in position.

Consider the conductor carrying a current in the field, shown in Fig. 178 in the last chapter. We saw that if the armature were free, it would rotate in the opposite direction to that produced by the engine. Suppose we use a current from another dynamo and join the positive main to the positive terminal of the machine, that is, send a current through it in the reverse direction to that which we obtained from it as a dynamo, then if it be a shunt wound machine, the current in the field magnet coils will still be in the same direction as before, but the current in the armature coils will be in the reverse direction (see Figs. 193 and 194), and therefore the armature will be urged round in the same direction as when we used it as a dynamo. If we reverse the direction of the current, we reverse the direction of the field and also the direction of the current in the armature conductors, and consequently the direction of rotation is still the same. We therefore cannot reverse the direction of motion by simply reversing the current. To do so, it is necessary to reverse only one of the

essentials producing rotation, viz., either the direction of the field or the direction of the armature current, but not both. The same thing applies to the series motor, for by reversing the direction of the current in the armature we also reverse the field magnet. The usual practice is to reverse the direction of the current in the armature only, and this is easily done in either a shunt or series motor by a reversing switch (see Figs. 195 and 196).

The moment the motor begins to rotate it generates an e.m.f., for we have conductors cutting lines of force, and whenever we

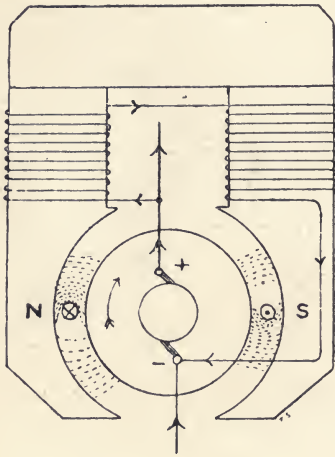

Dynamo.

Fig. 193.

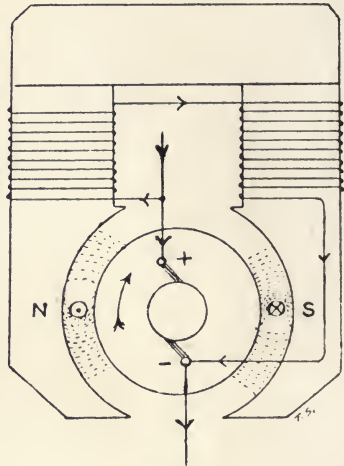

Motor.

Fig. 194.

get this, an e.m.f. is produced. But the e.m.f. so produced is by Lenz's law opposing that which produces it, and therefore acts in a direction directly opposing the flow of the current. The current is therefore equal to $\frac{E - e}{R}$. The *left hand rule* mentioned in the last chapter can be applied to find the direction of rotation with any given direction of current and field.

Now we have seen that the power put into the dynamo by the steam engine is principally expended in overcoming the tendency for the conductors to go round in the opposite direction. The force with which they are urged, depending on the strength of the

field, the strength of the current, and the total length of the conductor in the field carrying the current. This is the same whether the machine be run as a dynamo or as a motor, except that the loss in frictions, heat ($=c^2R$), hysteresis, and eddy currents, in the case of the dynamo, have to be made up by extra power from the steam engine, while in the case of the motor, by extra electrical power supplied. Now if the machine be excited and run at a certain fixed speed, as a motor, it develops a back e.m.f. $=e$, which is the e.m.f. it would develop as a dynamo if excited to the same degree, and run at the same speed by a steam engine. Evidently, if we did the latter, the power we should get from the machine would be equal to ec watts, the product of the e.m.f. developed into the current flowing. It is evident that we must

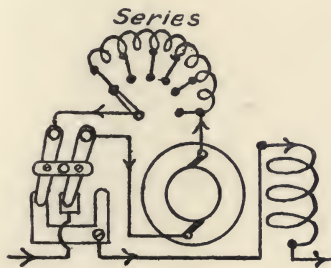

Fig. 195.

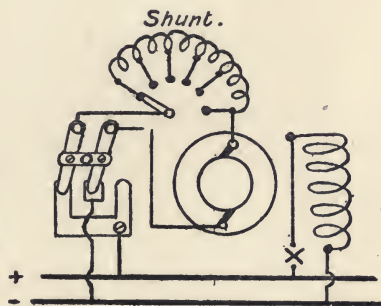

Fig. 196.

supply some extra power to drive it, and the power we put into it is $=EC$, where E is the e.m.f. we impress on the terminals. E is therefore always greater than e , but if the machine is well designed and running unloaded, e will be very nearly equal to E . . . If they were alike it would mean that no power at all is required to drive the machine at no-load full speed, and if e were greater than E it would not only drive itself, but we should also receive power from it as well, which is perfectly absurd, though many have been known to spend a large amount of time and money in trying to make machines to so act.

The power we get out ($=ec$) divided by the power we put in ($=EC$) is the electrical efficiency of the machine, or—

$$\text{Electrical efficiency} = \frac{eC}{EC} = \frac{e}{E}.$$

This tells us the percentage of energy we are converting into something other than heat, and the nearer e approaches E in value, the greater is this efficiency.

But e depends on the speed of the motor, and has its maximum value when the speed is a maximum. The electrical efficiency is therefore higher when running at a high speed, than when running at a lower speed. When running at its highest speed, however, it is doing very little work per revolution, and when the motor is prevented from turning it is doing no work, and all the energy supplied is wasted in heating the conductors. The maximum amount of work per revolution is therefore obtained at some intermediate speed between nought and maximum. This point of maximum work is reached when the motor is developing a back e.m.f. equal to half the impressed e.m.f.

$$\text{The current that flows through the motor} = C = \frac{E - e}{R}.$$

$$\text{Therefore } E = CR + e.$$

The power supplied to the motor

$$\begin{aligned} &= E \times C = (CR + e)C \\ &= C^2R + eC, \end{aligned}$$

C^2R being the fraction of the power going to heat the conductors, and eC being the power transformed.

Consider the above in the case of a motor working at say 100 volts having a resistance of .1 ohm, and running at such a speed as to develop 50 volts ($= \frac{1}{2} E$) for the back e.m.f. Then—

$$C = \frac{100 - 50}{.1} = 500 \text{ amperes.}$$

$$\begin{aligned} \text{And power supplied} &= C^2R + eC \\ &= (500^2 \times .1) + (50 \times 500) \\ &= 25000 + 25000 \end{aligned}$$

That is to say, 25,000 watts are being wasted in heating the conductors, and 25,000 watts are being converted into useful work in the motor. Now suppose the speed be decreased by 10 per cent., the back e.m.f. will also decrease 10 per cent., and we get—

$$C = \frac{100 - 45}{.1} = 550 \text{ amperes.}$$

$$\begin{aligned} \text{Power supplied} &= C^2R + eC \\ &= (550^2 \times .1) + (45 \times 550) \\ &= 30250 + 24750 \end{aligned}$$

or power transformed into useful work = 24750 watts against 25000 watts when the back e.m.f. was equal to $\frac{1}{2}$ E.

Again, suppose the speed increases so that the back e.m.f. is 10 per cent. higher, then—

$$c = \frac{100 - 55}{.1} = 450 \text{ amperes.}$$

$$\begin{aligned} \text{And power supplied} &= c^2R + ec \\ &= (450^2 \times .1) + (55 \times 450) \\ &= 20250 + 24750 \end{aligned}$$

Therefore when the back e.m.f. is equal to half the impressed e.m.f., the motor is developing the maximum amount of useful work, and the same amount of energy is being converted into heat, therefore when a motor is doing the maximum amount of work its electrical efficiency = .5, for only half the energy being supplied is converted into useful work. When the back e.m.f. is less or greater than half the impressed e.m.f. the motor is doing less work and the electrical efficiency is less than .5 in the former case and higher in the latter case.

It therefore follows that we are getting the maximum amount of work from any given motor when the current flowing through it is half that which would flow if it were so fixed as to prevent the armature rotating.

The electrical efficiency is not the same thing as the commercial efficiency, for out of the amount of energy converted into something other than heat, some has to go in overcoming various losses in the machine. These are (1) air and bearing friction, and (2) hysteresis and eddy current loss. Therefore the commercial efficiency of a motor

$$= \frac{\text{output (as measured by a brake)}}{\text{total energy supplied.}}$$

while the electrical efficiency

$$= \frac{\text{output}}{\text{output} + c^2R}$$

The various losses in the machine are not much greater at full load than at light load, and therefore the commercial efficiency will be greater at full load than at light load, the maximum efficiency being usually at about 75 per cent. of full load.

e can be measured when we know the resistance of the motor. If this be not known, it can be found by connecting an accumulator and an ammeter in series with it and measuring the current that flows through it while at rest. The resistance is then equal

to $R = \frac{E}{C} = \frac{2}{C}$, and this will practically be the resistance of the motor if a fairly large accumulator be employed and short thick connecting wires.

When the motor rotates at its full speed on no load, the only power it takes from the circuit is that required to overcome the losses in the machine. The no-load current will be small even though the e.m.f. be high and the resistance of the motor low, for the machine will then be developing a high back e.m.f. and the current that flows = $\frac{E - e}{R}$.

Thus, if $E = 100$ volts, $R = .1$ ohm, and $e = 99.8$ volts, then—

$$C = \frac{100 - 99.8}{.1} = \frac{.2}{.1} = 2 \text{ amperes,}$$

and 2 amperes at 100 volts = 200 watts is the power required to overcome the various no-load losses in the machine. The back e.m.f. can be measured by reading the current taken at any load and multiplying it into the resistance of the motor. If there were no back e.m.f. this product would be equal to the impressed e.m.f., for according to Ohm's law, $E = C \times R$. The difference between E and $(C \times R)$ is the back e.m.f. developed by the motor, or $e = E - (C \times R)$.

The back e.m.f. (being that produced by the machine running as a dynamo) = $\frac{NcS}{10^8}$, and therefore the power got from the motor

$$= eC = \frac{NcSC}{10^8}.$$

The mechanical work per second produced by the motor = $T \times \mu$, where T is the torque or turning effort and μ is the angular velocity = $2\pi s$, s being as before the speed in revolution per second, and 2π the measure of one revolution in radians.

Therefore work per second = $2\pi s \times T$, the torque T being in pound feet, and this divided by 550 gives us the horse-power.

But the power developed in the motor is also equal to

$$\frac{e \times C}{746}$$

$$\text{Therefore } \frac{e \times C}{746} = \frac{2\pi ST}{550}$$

$$\text{Therefore } T = \frac{550 \times e \times C}{746 \times 2\pi \times S} = \frac{e \times C}{S \times 8.5}$$

e being the e.m.f. developed by the machine as a generator, is equal to

$$e = \frac{NcS}{10^8}$$

$$\text{Therefore torque} = \frac{NcS}{10^8} \times \frac{C}{8.5 \times s} = \frac{NcC}{8.5 \times 10^8}$$

That is to say, the torque or turning effort in pound feet is proportional to the total lines of force, the current through the armature, and the number of armature conductors, and in all but very special cases the latter is fixed in any given motor, and therefore the torque is simply proportional to the armature current and the total lines through the armature.

If we put A (amperes) for the current instead of c in the above formula, we have—

$$T = \frac{CAN}{8.5 \times 10^8}$$

which is easily remembered.

It must be understood that T is not the pull in pounds exerted by the current-carrying conductors, but the pull in pounds multiplied by the leverage (radius of the armature) in feet in the same way that the moment tending to turn a lever is not the force used; but this multiplied by the perpendicular distance from the direction of action of the force to the fulcrum.

A few examples will serve to illustrate the way the various problems connected with motor work are calculated.

Q. 1. A two-pole motor is required to develop 10 h.p. when connected to mains at 150 volts. Assuming the armature to work at 86 per cent. efficiency and to run at 600 revolutions per minute, what will be the value of the current, and how many conductors must there be on the armature, if the sectional area of the armature core be 20 sq. in.?

1. The efficiency = 86 per cent.

$$\text{Therefore } \frac{\text{power got out}}{\text{power put in}} = \frac{86}{100}$$

$$\text{Therefore power put in} = \frac{10 \times 100}{86} = 11.6 \text{ h.p.}$$

$$= 11.6 \times 746 = 8653 \text{ watts.}$$

$$\text{Therefore } v \times A = 8653, \text{ therefore } A = \frac{8653}{150} = 57.5$$

or current required = 57.5 amperes.

2. The efficiency = 86 per cent = $\frac{e}{E}$.

$$\text{Therefore } e = \frac{86 \times E}{100} = \frac{86 \times 150}{100} = 129 \text{ volts}$$

$$\text{and } e = \frac{NcS}{10^8}, \text{ therefore } 129 = \frac{NcS}{10^8}$$

Allowing 100,000 lines per square inch, we have $N = 100000 \times 20 = 2000000$, and $s = 600$ per minute = 10 per second.

$$\text{Therefore } 129 = \frac{2000000 \times c \times 10}{10^8}$$

$$\text{Therefore } c = \frac{129 \times 10^8}{2 \times 10^7} = 645$$

Therefore number of conductors required = 645.

Q. 2. A tramcar weighs 10 tons, and it is required to run up an incline of 1 in 100. If 1 ampere corresponds to a tractive effort of 10 lbs., and the tractive force is 30 lbs. per ton, how many amperes will be required to get the tram up the incline, and what is the horse-power corresponding to 4 miles per hour? (C. and G. Examination.)

1. For the level, the tractive force required = $30 \times 10 = 300$ pounds.

For the incline of 1 in 100, 10 tons raised $\frac{1}{100}$ ft. = $\frac{10 \times 2240}{100}$
= 224 lbs.

Therefore total tractive effort required = $300 + 224 = 524$ lbs.

As 1 ampere is equal to a tractive force of 10 lbs., then $\frac{524}{10}$
= 52.4 amperes will be required.

2. Four miles per hour = $\frac{4 \times 5280}{60}$ ft. per minute.

The tractive force = 524.

Therefore $\frac{4 \times 5280}{60} \times 524 =$ foot-pounds per minute.

$$\frac{\text{Foot-pounds per minute}}{33000} = \text{h.p.}$$

$$\text{Therefore } \frac{4 \times 5280 \times 524}{60 \times 33000} = 5.58 \text{ h.p.}$$

is required for 4 miles per hour on the incline.

Shunt wound motors on constant potential mains run at practically constant speed for all loads up to a certain maximum.

If we put on a large load, the speed tends to decrease, and therefore the back e.m.f. also tends to decrease, and no extra torque would be developed, but if the back e.m.f. is reduced, the current through the armature increases in a larger proportion, and therefore with the larger load we get a larger current through the armature to meet it, and so the torque is increased, and the speed kept practically constant. If the machine be of large size, the large currents cause such a large armature reaction that the field is weakened sufficiently by this cause to allow of even a higher speed at full load, but in the smaller machines the volts lost in the armature at full load more than compensate for the opposite effect of armature reaction.

As a general thing, a motor is required to start from rest fully loaded, and to allow of speed variation over a wide range. This is more easily accomplished with the series motor than with the shunt, as we shall see later on.

We might vary the speed of the shunt wound motor, however, by putting a resistance in the armature circuit, but this is very wasteful, and the torque is decreased as well as the speed by so doing. A much better way is to put the resistance in the field circuit; an increase in the resistance here gives rise to an increase in speed and *vice versa*. The added resistance in the field circuit weakens the field, and therefore the back e.m.f. is less, and consequently the current in the armature is greater. If the increase in the armature current had the same percentage alteration as the decrease in the back e.m.f., there would be no increase in the torque, for this is proportional to $e \times c$. But the percentage increase in the armature current is, in this case, larger than the percentage decrease in the back e.m.f. Thus, suppose we take a motor whose armature works with say 85 per cent. efficiency, impressed e.m.f. = 500 volts, then the back e.m.f. = $\frac{500 \times 85}{100} = 425$ volts.

$$\text{Therefore } 425 = \frac{NcS}{10^8}$$

Now suppose we reduce N by 10 per cent., then we also reduce the back e.m.f. by 10 per cent., making it = 382.5 volts.

Now the current in the first case

$$= \frac{E - e}{R} = \frac{500 - 425}{R} = \frac{75}{R}$$

and the current in the second case

$$= \frac{E - e}{R} = \frac{500 - 382.5}{R} = \frac{117.5}{R}$$

which is an increase on the first current of 56 per cent. Therefore at the same speed, by weakening the field 10 per cent., we get an increase in the torque of 56 per cent. due to the increase in the current in the armature, minus 10 per cent. due to the decrease in the field strength, or a total increase in the torque of 46 per cent.

It will be evident that we cannot go far in this direction owing to the current in the armature rising rapidly with a weakening of the field, and where large changes in speed are required with large torque the series motor is far preferable.

The series motor exerts its maximum torque when at rest, for then the strength of the field and the strength of the armature current have both a maximum value. As the motor begins to move, it develops a back e.m.f. which cuts down the current in the armature and in the field winding also, and the torque falls off, but resistance can be slowly cut out of its circuit, so that the maximum current and therefore maximum torque continues until it has reached its normal speed, when all the resistance should by this time be out of the circuit. In this way we can so arrange that the motor will start from rest, under full load, with a very large torque, and continue to exert this torque till it gains full speed, the acceleration, therefore, being very rapid, which is a point of the utmost importance in traction work, where the stopping and re-starting is very frequent.

The resistance to be added at starting absorbs a large amount of power when the re-starting is very frequent, such as is found in the case of tramcars. This has led to an arrangement of the motors in what is known as the "series-parallel" control. The connections to the motors are made inside a small box, one at each end of the car, called the controller (Fig. 197). Inside this is a long spindle, carrying a number of stout brass or gun-metal segments, which make contact for a longer or shorter time (according to the length of each) with a corresponding number of spring contacts. The spindle is provided at its upper end with a substantial handle, and the various contacts are made by turning the handle through about 150°. In this case two motors are provided and a small resistance. The first contact joins both motors and the resistance in series on to the trolley wire, which is usually

at 500 volts difference of potential to the rails. This allows the maximum current to flow, and both motors exert their full torque, but the moment they start they both generate a back e.m.f. which is added together, for the motors are in series, and so the current

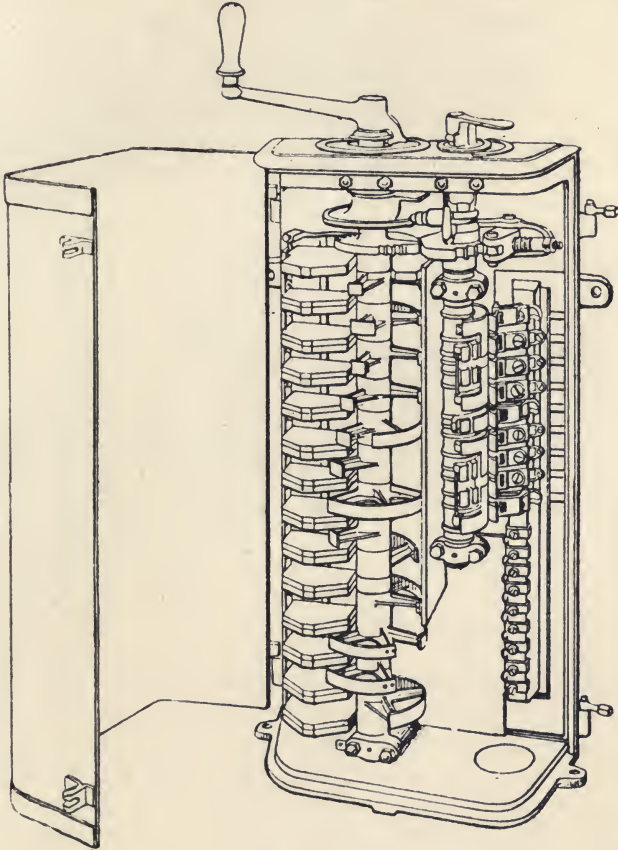

Fig. 197.

begins to decrease. The second contact cuts out half the resistance and keeps the current at its original value, even though there is now a back e.m.f. in the circuit, and the torque still continues at a maximum. The speed therefore increases, and the third contact cuts out all the resistance, and we have the two motors in

series only, with the maximum current still on. The next contact changes the connections from series to parallel, and also inserts the whole of the resistance once more. This is necessary, because in changing from series to parallel the resistance is only one quarter what it was, and the back e.m.f. is also reduced to one half its former value. The maximum current is therefore still kept on the motors, though they may be by this time running at half speed. The next contact cuts out half of the resistance once more, and the final contact cuts out the remaining half, and now the two motors are in parallel with no resistance in their circuit, both developing a back e.m.f., which prevents any but the current

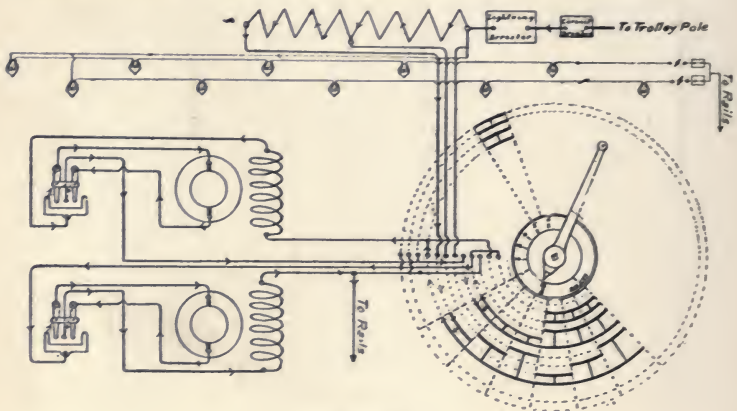

Fig. 198.

required to meet the load from passing through them. The whole operation is completed and the tramcar running at full speed from rest in a few seconds, depending in part on the load and on the experience of the motor-man in changing from one contact to the next at the right time, the average time being about twenty seconds.

The connections of such a controller are given in a diagram designed by the author, in Fig. 198. It is very much distorted, the segments being shown in a horizontal plane instead of one under the other, but this is so arranged that the connections may be seen more clearly. The small switch on the left is the reversing switch, which reverses the current in the armature of both motors, but allows the current to flow in the same direction in the field

magnets. A still further turn of the controller handle cuts both motors from the line, and short circuits them. They then form a very powerful brake. This is only used in cases of emergency, for there is danger of burning out the motors in so doing, owing to the large currents induced in them at a high speed, in running as generators on short circuit. The reversing switch is arranged on a second vertical spindle beside the first or main controller spindle, and the two are interlocked so that the motors cannot be reversed except when the current is off. The two controllers (one at either end of the car) are connected in parallel, that is to say, similar contacts on the two are connected together so that when one is switched off and locked, the car can be controlled from the other.

It will be noticed that in switching off, the reverse operations are gone through, and therefore at the moment of breaking contact with the line, there is only a small current flowing, if the car be running at anything above half speed, owing to the two motors being in series, with all the resistance in, and a high back e.m.f., due to the sum of the back e.m.f.'s of the two motors. There is, however, a certain amount of sparking in breaking from one contact to another, and if the car be heavily loaded the sparking becomes very injurious, and the contacts would soon be burnt out unless precautions were taken to prevent it, and this is done in most cases by magnetically blowing out the spark.

Between each contact a flat coil is fixed with its axis directly in line with the point of contact, and at the moment of breaking the circuit at this point, a strong current is automatically passed through all the flat coils in series. This creates a strong magnetic field across the whole of the contacts, and the spark—acting like a conductor carrying a current—is strongly repelled to one side, and so increased in length that it breaks almost as quickly as it is formed.

In tracing out the connections given in the diagram of the series parallel controller, the row of contacts are supposed to be fixed, while the segments rotate together round the central spindle. The lighting of the cars is usually effected by connecting five 100 volt lamps in series, and two groups, or ten lamps of 16 candle-power each, often constitutes the amount of light allowed for each car, which is all that could be desired. The cars may be also warmed electrically in the winter by the heating effect of the current in

resistance coils, as explained in Chapter IV. The direction of the current on the first contact is shown by arrow heads in the diagram, and the remaining contacts can be traced out by the student in a similar manner.

When motors are used for purposes other than traction, they must also be provided with starting resistances to prevent the very large currents that would flow at the moment of starting, for at this time the motor is not developing a back e.m.f., and its

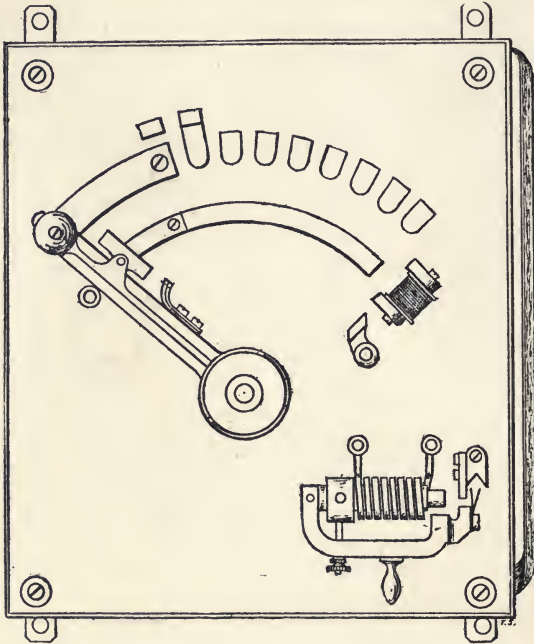

Fig. 199.

resistance, being usually very small, the current that would flow through it without a starting resistance would probably prove injurious, especially if starting under load.

A common form of starting resistance is shown in Fig. 199. It consists of coils of iron wire large enough to safely carry the maximum current, enclosed in a fireproof case and connected to a set of contacts. A switch handle can be rotated over the contacts, which cuts out more and more of the resistance. At the end of

its travel, an iron armature fixed to the switch handle comes into contact with the poles of a small electro-magnet which is excited by the field shunt current, and holds the switch arm in contact against its tendency to fly off, due to the reaction of a strong spring in the boss of the switch arm. Should the current through the motor be broken for a short time, due to any accidental or any other cause, the switch immediately flies off, and the motor cannot be re-started without the resistance being inserted. The motor current also excites a small electro-magnet at the base of the switch board which attracts an armature against the reaction of a spring or

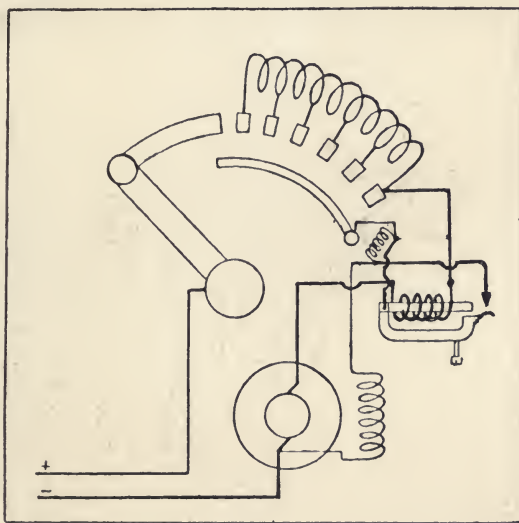

Fig. 199A.

gravity. This can be set so as to go over with any prearranged current. The circuit of first electro-magnet is short circuited through this armature, and when the current reaches a dangerous value, the armature is pulled over, the switch arm released, and the motor saved from injury.

In the case of a shunt wound motor it is essential that the field magnet be excited before the current is switched on to the armature, for without the field the motor cannot start, and therefore cannot develop a back e.m.f. The starting switch in this case is provided with a continuous bar below the row of contacts, and

this is in connection with the field magnet winding and hold-on coil, and comes into contact with the switch arm first. Any further movement of the switch arm regulates the resistance in the armature circuit, but the field remains constantly magnetised. In switching off the field magnet circuit is broken last, and in large size machines this should be done through a resistance also. A diagram showing the connections of such a switch is given in Fig. 199A.

The compound wound dynamo can be run as a motor, but we have to remember that the series turns will, in such a case, be acting as a demagnetising coil, or in opposition to the shunt coil. In many respects it is not so good as the shunt motor, and where it is employed the object is to get a more constant speed for all loads than is given by the shunt machine.

Owing to the demagnetising effect of the series coil, the back e.m.f. falls automatically with increase of load, and a larger current flows through the armature to maintain the speed.

Used in this way it is clear that the machine will take a large starting current, and if the machine be heavily loaded it may refuse to start at all, or even run in the reverse direction, owing to the field due to the series coil being in excess of that produced by the shunt coil. The same effect may be produced while running if a large overload be thrown on to the motor for a short time.

With an increase in the armature current, the torque increases up to a certain maximum, and then (owing to the field becoming excessively weak with the larger currents in the series coil) the torque falls off and finally comes to zero. Any further increase in the current will now run the motor in the reverse direction.

It is therefore seen that a differentially wound compound motor has not such a large overload capacity as the shunt motor, and moreover it takes a much larger starting current. When it is used it is preferable to short circuit the series winding at starting, and when the machine has run up to speed as a shunt motor, to put the series turns into the circuit by removing the short circuit.

If the machine has been over compounded, it will give a higher speed with increase of load, but if the winding is correctly chosen, we get the same speed at no load and full load with very slight alterations for intermediate loads.

In designing the machine for a motor, it is usual to provide about $\frac{1}{10}$ as many series ampere turns at full load as there are

shunt ampere turns. This is about half of what would be required for the same machine run as a dynamo.

These machines are not used to any great extent, for the shunt wound motor can be made to work with but slight change in speed from nought to full load, especially if of large size (over 20 h.p.). With the shunt machine, there are two causes for variation in the characteristic. One is volts lost in the armature ($= c_a \times R_a$), which increases with the load and gives rise to a falling characteristic. The other is armature reaction, producing a weakening of the field, and consequently a rising characteristic. In small machines the former is the most important, and we get a slight fall in speed with increase in load. But with large machines the resistance of the armature is very small, and the armature reaction far outweighs the $c \times R$ drop, and we therefore get—with the large machine—all the advantages of the differential compound wound machine without its disadvantages.

All modern traction motors are waterproof, four-pole, ironclad machines, designed to work at 500 volts. These are connected to the car axle through a single reduction spur wheel gearing, except in a few instances of heavy electric locomotives where the motor armature is connected direct to the car axle without any gearing whatever, in which case the armature should be built up on a hollow spindle surrounding the car axle, and the two connected together through a strong spring coupling to take up the jar at starting. The single reduction gear has, however, certain advantages, and has been found to give such satisfactory results in practice that it is very doubtful whether the direct connected motor will continue. The back e.m.f. of the motor is proportional to $n\phi s$, and if s be small—as it is when the motor is direct connected—the other items must be correspondingly large, which means more iron and copper and therefore a larger and heavier motor.

With a four-pole motor the speed is reduced to one half, for any given back e.m.f., for we have practically two motors in one. The conductors in moving half a revolution cut through the field twice, and with the same strength of field develop the same back e.m.f. as they did in turning through a complete revolution with the two-pole machine. A two-pole motor could, however, be made to run at the same speed and develop the same back e.m.f. as the four-pole motor, but it would be a much heavier machine and not nearly so compact. For with the four-pole motor we get

a much better distribution of the iron circuit, the connecting yokes being formed into the containing case, giving it the appearance of a rectangular iron box, none of the moving parts being visible except the end of the shaft with the spur wheel fixed to it. This magnetic circuit containing case is provided with two bearings at one end which embrace the car wheel spindle and so holds the motor in gear. The other end of the motor is suspended by strong spiral springs from the framework of the car truck which take up any jar at starting.

Q.—A four-pole traction motor, armature diameter = 24 in., series wound, 360 armature conductors, takes a current of 30 amperes at 500 volts. Flux from one pole = 9,000,000 lines. Assuming the field magnets to be separately excited, and the armature to work with 90 per cent. efficiency, find (1) speed, (2) horse-power, (3) tangential pull on the armature conductors.

1. Efficiency = 90 per cent.

Therefore $e = \frac{9}{10} \times 500 = 450$ volts.

$$e = \frac{NCS}{10^8} \quad \text{Therefore } s = \frac{e \times 10^8}{Nc} = \frac{450 \times 10^8}{N \times 360}$$

(There being four poles or two *N* and two *S* poles, the total lines in this case = 9000000 \times 2.)

$$\text{Therefore } s = \frac{450 \times 10^8}{18000000 \times 360} = 6.8 \text{ revolutions per second.}$$

$$2. \text{ Horse-power} = \frac{e \times A}{746} = \frac{450 \times 30}{746} = 18 \text{ h.p.}$$

$$3. \text{ Torque} = \frac{cAN}{8.5 \times 10^8} = \frac{360 \times 30 \times 18 \times 10^6}{8.5 \times 10^8} \\ = \frac{36 \times 3 \times 18}{8.5} = 225 \text{ pound feet.}$$

The radius of the armature being 1 ft., the tangential pull on the armature conductors

$$= \frac{225}{1} = 225 \text{ lbs.}$$

It is evident when we consider the four-pole machine, that diametrically opposite conductors on the armature are cutting through similar fields at the same rate, and are therefore developing similar e.m.f.'s (see Fig. 200). Also that any one conductor has its e.m.f. reversed four times during one complete revolution. Suppose we therefore place brushes at the mid-point between each pair of poles, that is, at each point where the e.m.f. in any one conductor reverses, we should have two pairs of brushes, for the

brushes diametrically opposite would have similar e.m.f.'s. Opposite brushes could therefore be put in parallel, and we should then have the equivalent of two machines in parallel with four brushes on the commutator at 90° apart, alternate brushes being connected together by a piece of cable, or an insulated semicircular band of copper.

In some cases only two brushes are used, 90° apart, in which case diametrically opposite conductors are connected together by a series of connectors slipped over the shaft before the commu-

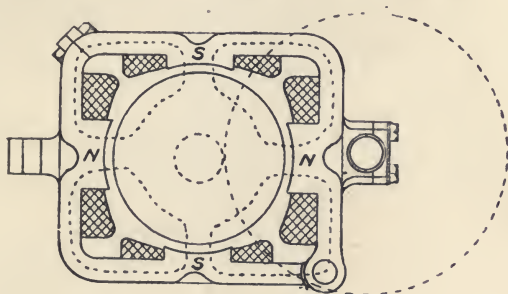

Fig. 200.

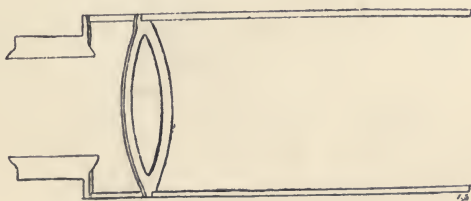

Fig. 201.

tator is put on. These usually consist of rings of thin sheet copper with lugs projecting at both ends of a diameter. As one ring connects together two commutator segments, there will be half as many rings required as there are commutator segments. The method of connecting is shown diagrammatically in Fig. 201. These connectors are clamped in front of the end connectors of the drum winding, for all such motors are drum wound, owing to the ease with which a coil can be disconnected and replaced if damaged.

For tram car motors, however, two circuit single windings are

exclusively employed. With this winding only two brushes are required, and each conductor is connected to another just over 90° ahead. After going round in this way the end is joined to the next but one from the one we started with, then round again and so on; the winding eventually closing on itself. The brushes then connect the winding into two circuits in parallel, instead of four circuits in parallel when four brushes are employed. This is done, first, so that a higher e.m.f. may be employed; secondly,

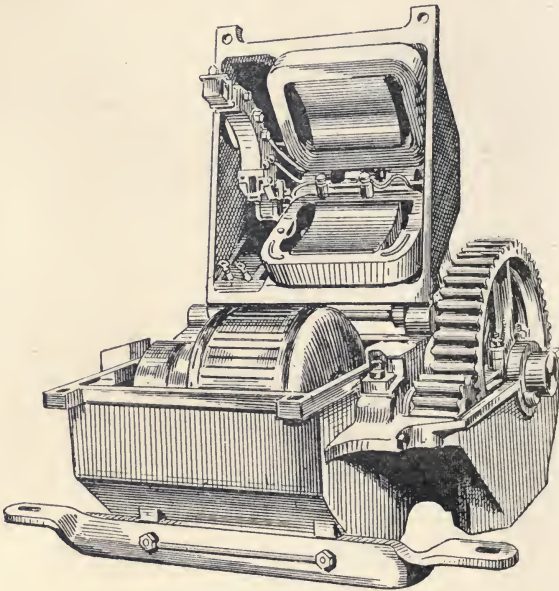

Fig. 202.

because equal e.m.f.'s are induced in the two circuits even though the armature be not central due to wear at the bearings; and thirdly, because the brushes are rather inaccessible, and two can be got at easier than four.

Many different windings are employed on multipolar motors, but these are, in the main, elaborate, and must be left for a subsequent course of study.

Fig. 202 shows a modern traction motor open, and Fig. 203 shows a motor closed, suspended in position from the car frame.

The magnetising coils are very flat, and the pole pieces short, the two vertical pole pieces often being shorter than the two horizontal ones when so arranged, owing to the vertical space under a tram car being limited.

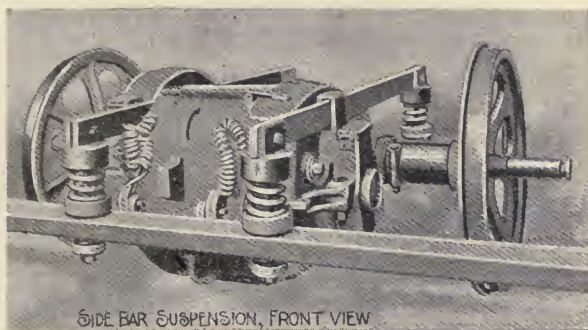

Fig. 203.

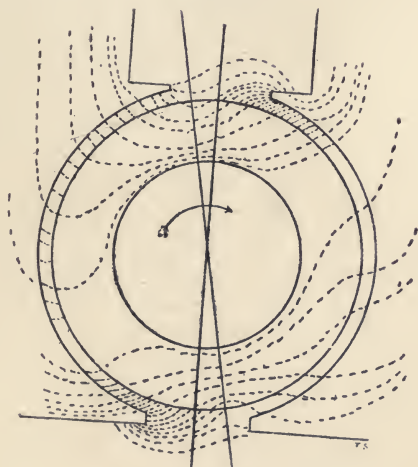

Fig. 204.

In all cases of multipolar machines with multiple circuit windings, it is very difficult, if not impossible, to make the different magnetic circuits exactly alike, and therefore the different sections, in parallel with the brushes, may not be developing exactly similar

e.m.f.'s. This would give rise to local currents, which have a tendency to get up a swing, and cause sparking at alternate brushes. To prevent this, a few cross connectors are often added to act as equalising rings. If now the e.m.f.'s are symmetrical no current will flow in the equalising rings, but if not, the out-of-balance current will flow through them instead of causing sparking at the commutator. These equalising rings are unnecessary for machines up to 150 k.w.

It has been pointed out that by using strong fields and carbon brushes, sparking at the commutator is prevented, and so the brushes can be fixed at points directly midway between the poles, and the motor run equally well in either direction. In cases where the brushes are movable and sparking occurs, it must be remembered that a backward lead is required with increase of load, which is opposite to that required for a dynamo. This will be readily understood by considering Fig. 194, which gives the direction of field, armature current, and motion for the motor.

The magnetisation due to the armature current is in such a direction as to strengthen the field at the top right-hand horn, and the bottom left-hand horn of the pole pieces, while the other two are weakened. This causes a distortion of the field, and the point of commutation is thrown over in the opposite direction to the direction of rotation, as shown in Fig. 204. Comparing this with the similar diagram for the dynamo (Fig. 170), we see that the field distortion is reversed in the two cases.

This gives rise to a number of back ampere turns, which is the same for the motor and dynamo with the same angular displacement of the brushes. If, in the case of the motor, we had a forward lead as in the dynamo, then owing to the armature current being reversed, we should have forward ampere turns instead of back ampere turns, but as the angular displacement of the brushes is backward in the case of the motor we get with the reverse armature current, a similar number of back ampere turns, as in the case of the dynamo.

In the case of the shunt wound motor, it is owing to this backward lead that the machine can maintain a constant speed, and in large machines even an increasing speed for increasing loads, for the backward lead gives rise to back ampere turns, and therefore a weakening of the field, which as we have seen causes an increased torque, due to the increased armature current.

INDEX.

- A**CCUMULATORS, 105-115
— acid density in, 109, 110
— boiling in, 112
— buckling of plates in, 115
— capacity of, 110, 111, 113
— charging, 110, 111
— chemical action in forming, 109
— chemical action in charging, 110
— chemical action in discharging, 110
— current density allowable in, 114
— density of acid in, 109, 110
— diffusion of acid in, 110
— discharge rate, maximum, 114, 115
— discharge, action, 110
— dynamo for charging, 299
— e.m.f. of, 111, 112
— efficiency of, 115
— expansion of paste in, 110
— insulators for, 113
— lead sulphate in, 110
— litharge in, 108
— local action in, 113
— pasted plates in, 108
— peroxide of lead in, 105, 109, 110
— polarisation in, 106
— positive pole and plate in, 106, 108, 109
— resistance of, 106
— solution for, 110
— spongy lead in, 105
— sulphating in, 113
— treatment of new, 109
Action, local, 100, 113
Adjustment of brushes, 281, 324
Air, permeability of, 70
Air-gaps in magnetic circuit, 80
— fringe of, 83
— density in, 80
Air-pump, mechanical, 234, 238
— mercury, 237
Alteration of speed of motor, 311-316
Alternating currents, 86, 90, 222
— arc lamps, 223
Ammeters, points in design of, 116
— Crompton's, 119
— dead beat, 124
— hot wire, 125
— Weston, 120
Ampere, the, 18
Ampere-hour, 96, 99
— meter, 135
Ampere turns in ammeter, 118
— back, 283
— calculation of, 84
— cross, 283
— in voltmeter, 119
— of armature, 280
— of field magnet, 82
— relation to H, 70
Analogy, hydraulic, of electric circuit,
3, 31
— charging condenser, 191
— of electric and magnetic circuit, 68
Amylacetate lamp, 249
Angle of lead, 281
Arc, electric, 202
— apparent resistance of, 220
— back e.m.f. in, 220
— crater of, 203
— e.m.f. required to maintain the, 220
— enclosed, 212
— heat of, 203
— hissing in the, 220
— illuminating power of the, 218, 223
— length of the, 203, 214
— resistance of the, 203, 220
— striking the, 202
Arc lamps, 202
— Brockie-Pell, 206
— candle-power of, 226
— carbons for, 203, 221, 222
— consumption of carbon in, 203, 212
— cored carbons for, 221
— Crompton, 212
— curves of candle-power of, 223-226
— cut-out for, 208, 210

- Arc enclosed, 212
 — lamps, feeding in, 202, 207
 — for alternating currents, 222
 — globes for, 213, 224
 — impurities in carbon for, 213
 — in parallel, 203
 — in series, 204
 — Jandus, 215
 — photometry of, 254
 — power absorbed by, 204
 — quality of carbons for, 213
 — steadying resistance for, 204
 — striking arc in, 202, 206
 — volatilisation of carbons in, 212
- Ark lamp, 216
- Armature conductors, 261, 263-267
 — driving of, 288
 — pull on, 288
 — insulation of, 261
 — lamination of core of, 259
 — reaction, 259, 284
 — resistance of, 264, 270
- Armature bars, 267
 — cores, 259
 — construction of, 259-267
- Armatures of electro-magnet, 80, 256, 317
 — of dynamo, 259
 — types of, 261
 — drum and ring, 261
 — heating of, 260, 262
 — proportions of, 265
 — ampere turns of, 282, 283
- Aron meter, 145-153
- Atomic weight, 93
- Attraction and repulsion between parallel conductors, 62.
- Automatic cut-out, 208, 210
- B**ACK e.m.f. of accumulators, 115
 — of motors, 304, 305, 313
 — ampere turns, 283
- Backward lead in motors, 324
- Ballistic galvanometer, 162
- Batteries, 97
 — bichromate, 103
 — Daniell's, 100
 — dry, 103
 — Fuller bichromate, 103
 — Leclanché, 102
 — primary, 97
 — secondary (see Accumulators)
- Bearings, dynamo, 294
- Bichromate cell, 103
- Board of Trade Unit, 134
- Boiling in accumulators (see Accumulators)
- Bridge, slide wire, 170, 171
- Bridge, Wheatstone's, 168
 — P.O. form, 172
 — measurement of resistance by, 175
- Brockie-Pell arc lamp, 206
- Brush holders, 298
- Brushes, 297
 — sparking at, 298
 — carbon, 297
- Buckling of accumulator plates (see Accumulators)
- Bunsen's grease spot photometer, 250
- C**. G.S. system, 15
 . Calibration, 120
- Calorie, 44
- Candle, standard, 249, 250
- Candle-power of arc lamps, 223, 255
 — of incandescent lamps, 231, 252
 — measurement of, 251
- Capacity of accumulators (see Accumulators)
 — of mains, 24, 38
 — unit of, 189
- Carbon filaments, 231
 — manufacture of, 225-235
 — resistance of, 51, 235, 243
- Carbons for arc lamps, 203, 221, 222
 — consumption of, 203, 212
 — for enclosed arc lamps, 213
 — volatilisation of, 212
- Carcel lamp, 249
- Cardew voltmeter, 127
- Cast-iron field magnets, 285, 295
 — density in, 76
- Cell (see Battery)
 — consumption of zinc in, 99
 — secondary (see Accumulators)
- Characteristic curve of meter, 142
 — of compound dynamo, 280
 — of separately excited dynamo, 276
 — of series dynamo, 276
 — of shunt dynamo, 277
- Charging accumulator, curve of, 111
- Chemical action in charge and discharge, 110
 — in bichromate cell, 104
 — in Daniell's cell, 98, 99
 — in Leclanché cell, 102
- Chemical equivalents, 95
- Circuits, parallel, 30
 — series, 8
 — series parallel, 35
- Classification of arc lamps, 202
 — of meters, 135
- Coils, armature, 263
 — field magnet, 86, 262

- Collectors, 296
 Commercial efficiency, 307
 Commutation, 282, 286
 Commutator bars, 291
 — four part, 271
 — insulation for, 291
 — lugs, 292
 — manufacture of, 289-293
 — mica cones for, 289
 — sleeve, 289
 Compound wound dynamo, 279
 — dynamo, characteristic, 280
 Conductivity, 29
 — name of unit of, 30
 — specific, 69
 Constant current dynamo, 275
 Consumption of carbon in arc lamp,
 203, 212
 — of zinc, 99
 Continuous current dynamo, 258
 Controller for tramway, 312
 Cooking apparatus, 53
 Cooling surface of armature, 262
 — surface of field magnet coils, 262
 Copper conductors, 38
 — refining, 96
 — specific resistance of, 25
 Core armature, 259
 — iron, 73
 Coulomb, 18
 Coupling dynamos, method of, 299-302
 Crompton ammeter, 119
 — arc lamp, 212
 — potentiometer, 183
 Cross ampere turns, 283
 — connections, 312, 323
 Current, absolute unit of, 18
 — magnetic effect of the, 56
 — heating effect of the, 48
 — chemical effect of the, 91
 — density, 38
 — density, maximum allowable, 38
 — strength, measurement of, 188
 Currents, practical unit of, 18
 — alternating, 90, 223
 — eddy, 259
 — direct, 269
 — measurement of large, 188
 Curve, characteristic (see Characteristic Curve)
 — of magnetisation, 76
 Cut-out, automatic, 208, 210
 Cutting of lines of force, 67
- D**ANIELL'S cell, 100
 D'Arsonval galvanometer, 161
 Density, current, 38
 Density, magnetic, 70
 — of acid, 103, 109, 110
 Diameter of armature, 259
 Diffusion of acid in accumulators, 110
 Direct current dynamo, 258
 Direction of field, 57
 Discs, armature, 260
 Discharge of accumulators, 110
 — curve of, 112
 Distortion, field, 280
 Distribution board, 244
 Divided circuits, 30
 Drum armatures, 265
 — construction of, 259
 — heating of, 262
 — winding of, 265
 Dry cells, 103
 Dynamos, compound wound, 279
 — characteristic curve of, 276-280
 — heating in, 262
 — power transformed by, 288
 — separately excited, 274
 — series, 275
 — series, reversal of polarity in, 301
 — series, winding of, 274
 — shunt wound, 276
 — shunt wound, winding of, 275
 — shunt, magnetic leakage in, 296
 — oertype, 295
 — undertype, 296
 Dyne, the, 14
- E**DDY currents, 259
 Efficiency, electrical, 307
 — of accumulators, 115
 — of incandescent lamps, 252
 — of motors, 307
 Electric arc (see Arc, Electric)
 — battery (see Battery)
 Electrical horse-power, 17
 — units, 14
 Electrolysis, 97
 — back e.m.f. in, 97
 Electro-chemical equivalents, 95
 Electro-magnet, 256, 317
 Electro-magnetic instruments, 116
 Electro-motive force and p.d., 12
 — available in external circuit, 13
 — as rate of cutting lines of force, 67
 — cells for comparing, 184
 — direction of induced, 269, 289
 End connections of drum armature, 265
 Energy, dissipation of, 262
 — meters (see Meters)
 Erg, the, 16
 Esson on heat and radiating surface, 262
 Evershed's ohmmeter, 132

Ewing's magnetic balance, 199
 Excitation, magnetic, 74
 Exhausting lamp bulbs, 237
 Expansion of accumulator plates, 110
 External characteristic (see Characteristic Curve)

FALL of potential in cells, 100
 — in mains, 38
 Farad, the, 189
 Faure accumulator (pasted type), 108
 Feeders, 40
 Feeding in arc lamps, 202, 207
 Field excitation, 82
 Field magnet, 82
 — cooling surface of, 262
 — winding, 262, 283
 — ampere turns for, 84, 283
 — strength of, 82
 — weakening of motor, 311
 Field, magnetic, of straight current, 56
 — of loop, 61
 — of solenoid, 63
 — of armature, 280
 — of dynamo, 82
 — waste, 82, 296
 Filaments, incandescent lamp, 231
 Filings, iron, 55
 Flashing, 234
 Foot-pound, 15
 Force, lines of, 65
 — unit of, 14
 Four-pole motor, 319
 Fringe, air-gap, 83
 Fuller bichromate cell, 103
 Fundamental units, 14
 Furnace for carbonising, 231
 Fuse table, 248
 Fuses, 246

GALVANOMETER, ballistic, 162
 — D'Arsonval, 161
 — mirror, 159
 Gassing in accumulators, 111
 Generators, 3
 German silver, specific resistance of, 25
 Glass-blowing of lamp bulbs, 235
 — frosting, by sand blast, 241
 Glass, etching of, 252
 Globes, absorption of light by, 222
 Glow lamps (see Incandescent Lamps)
 Gramme armature, 261
 Gravity control in instruments, 116
 Grease spot photometer, 250
 Gun-metal insulators, 296
 — spider, 261

H MAGNETISING force, 70
 Hand rule for direction of field, 60
 — for dynamos, 289
 — for motors, 289, 304
 Harcourt's pentane lamp, 249
 Heat, quantity and temperature, 50
 — and work, 44
 — and resistance, 45
 — unit of, 44
 Heating apparatus, 53
 — of dynamo armature, 262
 — of conductors, 262
 — of iron by eddy currents, 260
 — of iron by hysteresis, 90
 — as limiting output, 24, 262
 — of field coils, 262
 Hefner-Altенck standard, 249
 Horns of pole pieces, 283
 — cast-iron, 285
 — polar, 283
 — magnetic saturation of, 285
 Horse-power, 17
 Hydraulic analogy of electric circuit, 3-31
 Hysteresis, magnetic, 88
 — magnetic, energy lost by, 89

ILLUMINATING power of arc, 218, 223
 Impressed e.m.f., 115
 Impurities in carbon, 213
 Incandescent lamps, 227
 — efficiency of, 248
 — exhausting, 237
 — filaments for, 231
 — flashing filaments for, 234
 — installation of, 244
 — life of, 244
 — manufacture of, 227-242
 — photometry of, 248
 Instability, magnetic, 277, 278
 Installation of incandescent lamps, 244
 Insulation of armature core, 261
 — of wire, 173
 — of cables, 176
 — of slots in armature core, 261, 263
 — resistance, 131, 176
 — magnetic, 296
 Iron, magnetic properties of, 73
 — magnetisation curve of, 76
 — wrought, for field magnets, 86
 — cast, for field magnet yoke, 295
 — cores, 73
 — discs for armatures, 260
 — rings for armatures, 260
 Ironclad motors, 319

J ANDUS arc lamp, 215
 Johnson & Phillips' "ark" lamp,
 216
 Joints in wiring, 244
 Joule, 16
 Joule's equivalent, 44
 Journals, 294

K ELVIN, 159
 Kilowatt, 273

L AG, magnetic, 88
 Lamination of armature core, 259
 — of armature bars, 267
 Lamp, arc (see Arc Lamp)
 Lamp, incandescent (see Incandescent
 Lamp)
 — pentane, 249
 — standard, 254
 Law, Lenz's, 138
 — Ohm's, 5
 Lead, angle of, 281
 Lead, metallic, 105, 106, 107
 — oxide of (litharge), 108
 — peroxide of, 105
 — red, 108
 — spongy, 105
 Leakage, magnetic, 296
 Leclanché cell, 102
 Left hand rule, 289
 Lenz's law, 138
 Life of incandescent lamps, 242
 Light, beam of, 161
 — measurement of, 249
 Lines of force of straight current, 56
 — e.m.f. due to cutting, 67
 — in armature, 280
 — in iron, 73
 — of loop, 61
 — of solenoid, 64
 — total, 69
 Local action, 100, 113
 Losses in dynamo, 289
 — in mains, 23
 — in resistance, 22
 — in motors, 307
 — hysteresis, 88
 — eddy current, 259

M ACHINES, 259
 Magnet, field of, 65
 — lifting power of, 200
 — pole of, 17, 65
 Magnetic circuit, 64
 — field, 58

Magnetic instability, 278
 — lag, 88
 — leakage, 296
 — pull, 200
 — saturation, 74
 Magnetisation of iron, 73
 — curves of, 76
 Magnetising force, H, 70
 Magneto-motive force, 68
 Magnetometer, 193
 Mains, 11
 Manufacture of commutator, 289-293
 — of incandescent lamps, 227-242
 Maximum demand indicators, 155
 Measurement of capacity, 193
 — of current strength, 187, 188
 — of e.m.f., 179-187, 192
 — of high resistance, 131, 176
 — of permeability, 193
 — of small resistances, 166
 — of resistance by Wheatstone bridge,
 168
 Measuring instruments, 159-201
 Mechanical power, absorption of, by
 dynamo, 288
 — developed in motor, 305
 Megohm, 132, 178
 Mercury pump, 237
 Meter, ampere-hour, 135
 — Aron, 145-153
 — Chamberlain & Hookham, 137
 — energy or watt hour, 135
 — Evershed's, 153
 — Thomson-Houston, 142
 — watt hour, 135
 Methven screen, 249
 Metre bridge, 170
 Mica, 291
 Mirror galvanometer, 159
 Motor armature, 303
 — back e.m.f. in, 305
 — coils, 321
 — compound, 318
 — controller for tramway, 312
 — distortion of field in, 324
 — efficiency of, 307
 — series, 304, 312
 — shunt, 304, 311
 — speed regulation of, 311, 312
 — starting resistance, 312, 316
 — torque developed in, 309
 Multipolar machine, 319, 323

N EEDLE compass, 58
 Negative lead (backward lead),
 324

Non-conductor, 99
North pole, 58

OHM, 19
Ohmmeter, Evershed's, 132
Ohm's law, 5
Oiling of dynamo bearings, 294
Overtypé dynamo, 295

PARALLEL circuits, 30
— compound dynamos in, 302
— lamps in, 37
— series dynamos in, 300
— shunt dynamos in, 299
Pentane lamp, 249
Permanent magnet, standard, 198
Permeability of air, 70
— of cast iron, 79, 295
— of non-magnetic materials, 72
— of wrought iron, 76
Photometer grease spot, 250
— Lummer-Brodhun, 252
— Wheatstone's, 253
Photometry, 248
Planté accumulator, 107
Platinum, 231
Polarisation, 99
Polarity, change of, 301
Pole face, 283
— tips, 283, 285, 286
— tips, eddy currents in, 286
— tips, cast-iron, 285
— pieces, shape of, 84, 286
— pieces, fringe round, 85
— strength, 17
— unit, 17
Positive and negative terminals, 59
— element, 103
Potential difference, 12
— fall in mains, 12
Potentiometer, 179
Power absorbed by dynamo, 21, 288
— developed in motor, 305
— unit of, 19
Practical unit of capacity, 189
— of current, 18
— of e.m.f., 19
— of power, 19
— of resistance, 19
Pressure, electrical, 1
— gauge, 4
Primary battery, 97
Pull, magnetic, 200
Pump, analogy of, to dynamo, 4
— exhausting, 234

Pump force, 228
— mercury, 237

QUANTITY, or ampere - hour
meter, 135
— of heat, 44
— units of, 19

RADIAL depth of armature slots,
263
Rate of cutting lines, 68
— of doing work, 16
Reaction armature, 259, 284
Reflection of light, 161
Regulation of speed of motor, 311, 312
— of e.m.f. of dynamo, 277, 279
Repulsion and attraction of conductors,
62
Resistance, absolute unit of, 19
— and heat, 45
— box, 172
— coils, 173
— instruments for measuring, 131, 166-
178
— insulation, 131, 176
— internal, of dynamo, 11, 21, 264
— measurement of high, 131, 176
— measurement of low, 166, 170
— measurement by fall of potential, 10,
166
— measurement by Wheatstone's
bridge, 168
— of battery cells, 100
— of dynamo, 11, 264
— of liquids, 101
— power expended in, 21
— specific, 25
— steadying, for arc lamp, 204
Reversing polarity of dynamo, 301
Right hand rule, 60, 289
Ring armature, construction of, 260, 264
— internal field of, 264
— proportions of, 265
— winding of, 264
Rise of temperature in dynamo arma-
tures, 262
— in dynamo field coils, 262
Rocker brush, 299

SAFE connection for series dynamo,
302
Saturation of field magnets, 277, 278
Scale, 161
Screen, Methven, 249
Screw analogy of direction of lines, 58

Secondary battery (see Accumulator)
 Separately excited dynamo, 274
 Series, arc lamp, 207
 — arc lamp cut-out, 208, 210
 — dynamo, 275
 Shafts, armature, 293
 Shifting of brushes, 281, 282, 303
 Short circuit, 246, 248, 279
 Shunt box, 164
 — dynamo, 278
 Shunts, 164
 Slide wire bridge, 170
 Solenoid, field of, 63
 Sparking at brushes, 282
 — resistance, 25
 Speed of dynamos, 273
 Split ring commutator, 269
 Standard candle, 249
 — cell, Clark's, 184
 — cell, Hibbert's, 185
 — lamp, 249
 — magnet, Hibbert's, 198
 — secondary, 254, 256
 Standards of light, 249
 — pentane, 249
 Steadying resistance for arc lamp, 204
 Steel, cast, permeability of, 76
 Storage cell (see Accumulator)
 Stranded armature bars, 267
 Strength of field, 70
 — of field, equations for, 70
 — of pole, 17
 System of wiring, 244

TABLE atomic weights, &c., 95
 — fuse wire, 248
 — incandescent lamp, 243, 244
 — specific resistance, 25
 — wiring, 246
 Tangent of deflection, 194
 Teeth, 263
 Temperature and quantity of heat, 50
 — maximum allowable, 262
 — rise of armature, 262
 — rise of field coils, 262
 — of arc, 203
 Terminal p.d., 12
 Terminals, 59
 Testing, 131-133
 Thermometer, 47
 Tin fuse wire, 246
 Toothed or slotted armature, 261, 263
 Torque in motor, 309
 Tramway motors, 312, 319
 — controller for, 312
 — diagram of connections of, 314

Transformation of energy, 288
 Transmission of energy, 39-43
 Twisted armature bars, 267
 Two part commutator, 269

UNDERTYPE dynamo, 296
 Unit, absolute, 14
 — Board of Trade, 134
 — current, 18
 — magnet pole, 17
 — of capacity, 189
 — of e.m.f., 19
 — of heat, 44
 — of light, 249
 — of resistance, 19
 Units, practical, 14

VACUUM pump, 237
 — testing of, 238
 Varnished armature discs, 259
 Ventilation of dynamo armature, 262
 Volatilisation of carbon in arc, 212
 Volt, the, 19
 Voltage of accumulators, 111, 112
 — of dynamo, 258, 272
 — of primary cells, 97, 100, 102, 104
 Voltmeter, considerations in design of,
 116
 — Cardew's hot wire, 127
 — Crompton's, 119
 — electro-static, 129
 — electro-magnetic, 116
 — hot wire, 127
 — Kelvin's electro-static, 129
 — Weston, 120

WASTE of power, heat a, 12
 — of power in resistances, 21
 Water, analogy to electric current, 4
 Watt unit of power, 17
 — hour meter, 135
 Weston instruments, 120
 Wheatstone's bridge, 168
 — slide wire pattern of, 170
 — P.O. pattern of, 172
 Wheatstone's photometer, 253
 Width of brushes, 298
 — of commutator, 291
 — of drum armature, 259, 265
 — of ring armature, 259
 Winding of drum armature, 265
 — of ring armature, 264
 — of field coils, 86, 274-280
 Wire fuse table, 248

Wire, insulation of, 173

Wiring, 244

— table, 246

Work and heat, 44

— and power, 16

— unit of, 16

Wrought iron, magnetisation curve of,
76

Wrought iron, permeability of, 75

ZINC, amalgamation of, 100

— a non-magnetic material, 296

— consumption of, 99

— in primary cells, 97

— local action on, 100

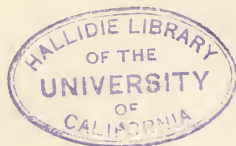

BOOKS ON ELECTRICITY,
MAGNETISM,
AND
ELECTRICAL ENGINEERING,
PUBLISHED BY
CROSBY LOCKWOOD & SON,
7 STATIONERS' HALL COURT, LONDON, E.C.

Just published, Crown 8vo, cloth, 9s. net.

ELECTRICAL
AND
MAGNETIC CALCULATIONS

FOR THE USE OF

*Electrical Engineers and Artisans, Teachers, Students, and
all others interested in the Theory and Application
of Electricity and Magnetism.*

BY A. A. ATKINSON, M.S.,

PROFESSOR OF PHYSICS AND ELECTRICITY IN OHIO UNIVERSITY,
ATHENS, OHIO.

NOTE.—Besides forming an introduction to a course in Electrical Engineering, it is hoped that this volume will be a helpful companion to Electrical Engineers, Superintendents, and all those in the more responsible positions in engineering work. They will find it valuable in its development of the rules and formulæ employed in their profession, and as a handy reference for the methods of application of the rules and formulæ of practical engineering problems.

LONDON: CROSBY LOCKWOOD & SON, 7 Stationers' Hall Court, E.C.

Just published, Large Crown 8vo, cloth, with 202 illustrations,
12s. net.

DIRECT CURRENT MACHINES

BEING THE FIRST VOLUME OF

DYNAMO ELECTRIC MACHINERY

Its Construction, Design, and Operation.

BY

SAMUEL SHELDON, A.M., Ph.D.

PROFESSOR OF PHYSICS AND ELECTRICAL ENGINEERING AT THE POLYTECHNIC
INSTITUTE OF BROOKLYN, MEMBER OF THE AMERICAN INSTITUTE
OF ELECTRICAL ENGINEERS, AND FELLOW OF THE AMERICAN
ASSOCIATION FOR THE ADVANCEMENT OF SCIENCE.

ASSISTED BY

HOBART MASON, B.S.

THIRD EDITION, REVISED.

NOTE.—This book is intended to be used primarily in connection with instruction on courses of Electrical Engineering in Institutions for Technical Education. It is laid out on the lines of the lectures and the instruction as given in the Polytechnic Institute of Brooklyn. It is intended equally as much for the general reader who is seriously looking for information concerning dynamo electrical machinery of the types discussed, as well as a book of reference for engineers.

Just published, Large Crown 8vo, cloth, with 184 illustrations,
12s. net.

ALTERNATING CURRENT MACHINES

BEING THE SECOND VOLUME OF

DYNAMO ELECTRIC MACHINERY

Its Construction, Design, and Operation.

BY

SAMUEL SHELDON, A.M., Ph.D.,

PROFESSOR OF PHYSICS AND ELECTRICAL ENGINEERING AT THE POLYTECHNIC
INSTITUTE OF BROOKLYN, ETC.,

AND

HOBART MASON, B.S., E.E.

NOTE.—This book, like its companion volume on Direct Current Machines, is primarily intended as a Text-Book for use in Technical Educational Institutions. It is hoped also that it will be of use to those Electrical, Civil, Mechanical, and Hydraulic Engineers who are not perfectly familiar with the subject of ALTERNATING CURRENTS but whose work leads them into this field.

A thorough understanding of what takes place in an alternating current circuit is not to be easily acquired. It is believed, however, that one who has mastered the first four chapters of this book will be able to solve any practical problem concerning the relations which exist between power, electro-motive forces, currents, and their phases in series or multiple alternating current circuits containing resistance, capacity, and inductance.

Just published, Third Edition, enlarged, Crown 8vo, cloth,
224 pages, with over 90 illustrations, 9s. net.

POWER TRANSMITTED
BY
ELECTRICITY

AND APPLIED BY
THE ELECTRIC MOTOR

INCLUDING
ELECTRIC RAILWAY CONSTRUCTION

BY
PHILIP ATKINSON, A.M., Ph.D.,
AUTHOR OF "ELEMENTS OF STATIC ELECTRICITY," "THE ELEMENTS OF
ELECTRIC LIGHTING," "THE ELEMENTS OF DYNAMIC ELECTRICITY
AND MAGNETISM," "ELECTRICITY FOR EVERYBODY."

BY THE SAME AUTHOR.

Crown 8vo, cloth, 417 pages, with 120 illustrations, 10s. 6d.

THE ELEMENTS OF
DYNAMIC ELECTRICITY
AND
MAGNETISM

A HANDBOOK FOR STUDENTS AND ELECTRICAL
ENGINEERS.

Just published, Third Edition with Appendix, 690 pages, with nearly 400 illustrations. Large Crown 8vo, cloth, 7s. 6d. net.

THE STANDARD ELECTRICAL DICTIONARY

*A POPULAR ENCYCLOPÆDIA
OF WORDS AND TERMS USED IN THE PRACTICE OF
ELECTRICAL ENGINEERING.*

BY

T. O'CONOR SLOANE, A.M., E.M., Ph.D.,
AUTHOR OF "ARITHMETIC OF ELECTRICITY," "ELECTRICITY SIMPLIFIED,"
"ELECTRIC TOY MAKING," ETC.

Just published, Second Edition, revised and enlarged, Crown 8vo, 260 pages, with 100 illustrations, 4s. 6d., cloth.

THE MANAGEMENT OF DYNAMOS

A Handybook of Theory and Practice

FOR THE USE OF

MECHANICS, ENGINEERS, STUDENTS, AND OTHERS IN
CHARGE OF DYNAMOS.

BY

G. W. LUMMIS-PATERSON,
ELECTRICAL ENGINEER.

"An example which deserves to be taken as a model by other authors. The subject is treated in a manner which any intelligent man who is fit to be entrusted with charge of an engine should be able to understand. It is a useful book to all who make, tend, or employ electric machinery."—*Architect*.

"The book may be confidently recommended."—*Engineer*.

Recently published, Super-royal 8vo, nearly 800 pages, fully illustrated, including a large number of Maps and Folding Plates, strongly bound in cloth. Price £3. 3s. net.

SUBMARINE TELEGRAPHS

*Their History, Construction, and
Working.*

Founded in part on WUNSCHENDORFF'S "Traité de
Télégraphie sous Marine"

AND

Compiled from Authoritative and Exclusive Sources.

BY

CHARLES BRIGHT, F.R.S.E.

OPINIONS OF THE PRESS.

"There are few, if any, persons more fitted to write a treatise on submarine telegraphy than Mr Charles Bright. He has done his work admirably, and has written in a way which will appeal as much to the layman as to the engineer. This admirable volume must for many years to come hold the position of the English classic on submarine telegraphy."—*Engineer*.

"This book is full of information. It makes a book of reference which should be in every engineer's library."—*Nature*.

"Mr Bright's interestingly written and admirably illustrated book will meet with a welcome reception from cable men."—*Electrician*.

USEFUL WORKS FOR ELECTRICIANS.

ELECTRO-PLATING AND ELECTRO-REFINING OF METALS. Being a new edition of ALEXANDER WATT'S "ELECTRO-DEPOSITION." Revised and largely rewritten by ARNOLD PHILIP, B.Sc., A.I.E.E., Principal Assistant to the Admiralty Chemist. Large Crown 8vo, cloth. Just published. Net, 12s. 6d.

"Eminently a book for the practical worker in electro-deposition. It contains practical descriptions of methods, processes, and materials, as actually pursued and used in the workshop."—*Engineer*.

ELECTRIC LIGHT FITTING.

A Handbook for Working Electrical Engineers, embodying Practical Notes on Installation Management. By J. W. URQUHART, Electrician, Author of "Electric Light," &c. With numerous illustrations. Third Edition, revised, with additions. Crown 8vo, 5s., cloth.

"This volume deals with the mechanics of electric lighting, and is addressed to men who are already engaged in the work, or are training for it. The work traverses a great deal of ground, and may be read as a sequel to the author's useful work on 'Electric Light.'"—*Electrician*.

ELECTRIC LIGHT.

Its Production and Use, embodying plain Directions for the Treatment of Dynamo-Electric Machines, Batteries, Accumulators, and Electric Lamps. By J. W. URQUHART, C.E. Sixth Edition, revised, with additions. Crown 8vo, 7s. 6d., cloth.

"The whole ground of electric lighting is more or less covered and explained in a very clear and concise manner."—*Electrical Review*.

DYNAMO CONSTRUCTION.

A Practical Handbook for the use of Engineer Constructors and Electricians-in-Charge. Embracing Framework Building, Field Magnet and Armature Winding and Grouping, Compounding, &c. By J. W. URQUHART. Second Edition, enlarged. With 114 illustrations. Crown 8vo, 7s. 6d., cloth.

"Mr Urquhart's book is the first one which deals with these matters in such a way that the engineering student can understand them. The book is very readable, and the author leads his readers up to difficult subjects by reasonably simple tests."—*Engineering Review*.

ELECTRIC SHIP-LIGHTING.

A Handbook on the Practical Fitting and Running of Ship's Electrical Plant. For the use of Shipowners and Builders, Marine Electricians, and sea-going Engineers-in-Charge. By J. W. URQUHART, C.E. Second Edition, revised and extended. With 88 illustrations. Crown 8vo, 7s. 6d., cloth.

"The subject of ship electric lighting is one of vast importance, and Mr Urquhart is to be highly complimented for placing such a valuable work at the service of marine electricians."—*The Steamship*.

USEFUL WORKS FOR ELECTRICIANS.

THE ELECTRICAL ENGINEER'S POCKET-BOOK.

Consisting of Modern Rules, Formulæ, Tables, and Data. By H. R. KEMPE, M.Inst.E.E., A.M.Inst.C.E., Technical Officer, Postal Telegraphs, Author of "A Handbook of Electrical Testing," &c. Second Edition, thoroughly revised, with additions. With numerous illustrations. Royal 32mo, oblong, 5s., leather.

"It is the best book of its kind."—*Electrical Engineer*.

"Recommended to those engaged in the electrical industries."—*Electrical Review*.

HOW TO MAKE A DYNAMO.

A Practical Treatise for Amateurs. Containing numerous Illustrations and Detailed Instructions for Constructing a Small Dynamo to produce the Electric Light. By ALFRED CROFTS. Sixth Edition, revised and enlarged. Crown 8vo, 2s., cloth.

"The instructions given in this unpretentious little book are sufficiently clear and explicit to enable any amateur mechanic possessed of average skill to build a practical dynamo machine."—*Electrician*.

ELECTRIC LIGHT FOR COUNTRY HOUSES.

A Practical Handbook on the Erection and Running of Small Installations, with Particulars of the Cost of Plant and Working. By J. H. KNIGHT. Third Edition, revised. Crown 8vo, 1s., wrapper.

"The book contains excellent advice and many practical hints for the help of those who wish to light their own houses."—*Building News*.

ELECTRIC LIGHTING (ELEMENTARY PRINCIPLES

OF). By ALAN A. CAMPBELL SWINTON, M.Inst.C.E., M.Inst.E.E. Fourth Edition, revised. With 16 illustrations. Crown 8vo, 1s. 6d.

"Any one who desires a short and thoroughly clear exposition of the elementary principles of electric lighting cannot do better than read this little work."—*Bradford Observer*.

ELECTRICITY AS APPLIED TO MINING.

By ARNOLD LUPTON, M.I.C.E., F.G.S., &c.; G. D. ASPINAL PARR, M.Inst.E.E., Head of the Electrical Engineering Department, Yorkshire College, Victoria University; and HERBERT PERKIN, M.I.M.E., Certificated Colliery Manager, &c. Demy 8vo. With very numerous illustrations. [Nearly ready.]

TABLES AND MEMORANDA FOR ENGINEERS.

By F. SMITH. Sixth Edition, including ELECTRICAL FORMULÆ, &c. Waistcoat pocket size, 1s. 6d., leather.

FACTORY ACCOUNTS.

Their Principles and Practice. A Handbook for Accountants and Manufacturers, including a large number of Specimen Rulings. By E. GARCKE and J. M. FELS. Crown 8vo, 7s. 6d., cloth.

CROSBY LOCKWOOD & SON'S

Catalogue of

Scientific, Technical and Industrial Books.

| PAGE | PAGE |
|--|--|
| MECHANICAL ENGINEERING 1 | CARPENTRY & TIMBER 28 |
| CIVIL ENGINEERING 10 | DECORATIVE ARTS 30 |
| MARINE ENGINEERING, &c. 17 | NATURAL SCIENCE 82 |
| MINING & METALLURGY 19 | CHEMICAL MANUFACTURES 84 |
| COLLIERY WORKING, &c. 21 | INDUSTRIAL ARTS 88 |
| ELECTRICITY 23 | COMMERCE, TABLES, &c. 41 |
| ARCHITECTURE & BUILDING 25 | AGRICULTURE & GARDENING 43 |
| SANITATION & WATER SUPPLY 27 | AUCTIONEERING, VALUING, &c. 46 |
| LAW & MISCELLANEOUS. 47 | |

MECHANICAL ENGINEERING, &c.

THE MECHANICAL ENGINEER'S POCKET-BOOK.

Comprising Tables, Formulæ, Rules, and Data: A Handy Book of Reference for Daily Use in Engineering Practice. By D. KINNEAR CLARK, M. Inst. C.E., Fourth Edition. Small 8vo, 700 pp., bound in flexible Leather Cover, rounded corners 6/0

SUMMARY OF CONTENTS:—MATHEMATICAL TABLES.—MEASUREMENT OF SURFACES AND SOLIDS.—ENGLISH AND FOREIGN WEIGHTS AND MEASURES.—MONIES.—SPECIFIC GRAVITY, WEIGHT, AND VOLUME.—MANUFACTURED METALS.—STEEL PIPES.—BOLTS AND NUTS.—SUNDRY ARTICLES IN WROUGHT AND CAST IRON, COPPER, BRASS, LEAD, TIN, ZINC.—STRENGTH OF TIMBER.—STRENGTH OF CAST IRON.—STRENGTH OF WROUGHT IRON.—STRENGTH OF STEEL.—TENSILE STRENGTH OF COPPER, LEAD, &c.—RESISTANCE OF STONES AND OTHER BUILDING MATERIALS.—RIVETED JOINTS IN BOILER PLATES.—BOILER SHELLS.—WIRE ROPES AND HEMP ROPES.—CHAINS AND CHAIN CABLES.—FRAMING.—HARDNESS OF METALS, ALLOYS, AND STONES.—LABOUR OF ANIMALS.—MECHANICAL PRINCIPLES.—GRAVITY AND FALL OF BODIES.—ACCELERATING AND RETARDING FORCES.—MILL GEARING, SHAFTING, &c.—TRANSMISSION OF MOTIVE POWER.—HEAT.—COMBUSTION: FUELS.—WARMING, VENTILATION, COOKING STOVES.—STEAM.—STEAM ENGINES AND BOILERS.—RAILWAYS.—TRAMWAYS.—STEAM SHIPS.—PUMPING STEAM ENGINES AND PUMPS.—COAL GAS, GAS ENGINES, &c.—AIR IN MOTION.—COMPRESSED AIR.—HOT AIR ENGINES.—WATER POWER.—SPEED OF CUTTING TOOLS.—COLOURS.—ELECTRICAL ENGINEERING.

"Mr. Clark manifests what is an innate perception of what is likely to be useful in a pocket-book, and he is really unrivalled in the art of condensation. It is very difficult to hit upon any mechanical engineering subject concerning which this work supplies no information, and the excellent index at the end adds to its utility. In one word, it is an exceedingly handy and efficient tool, possessed of which the engineer will be saved many a wearisome calculation, or yet more wearisome hunt through various text-books and treatises, and, as such, we can heartily recommend it to our readers."—*The Engineer*.

"It would be found difficult to compress more matter within a similar compass, or produce a book of 650 pages which should be more compact or convenient for pocket reference. . . . Will be appreciated by mechanical engineers of all classes."—*Practical Engineer*.

MR. HUTTON'S PRACTICAL HANDBOOKS.

THE WORKS' MANAGER'S HANDBOOK.

Comprising Modern Rules, Tables, and Data. For Engineers, Millwrights, and Boiler Makers; Tool Makers, Machinists, and Metal Workers; Iron and Brass Founders, &c. By W. S. HUTTON, Civil and Mechanical Engineer, Author of "The Practical Engineer's Handbook." Sixth Edition, carefully Revised, with Additions. In One handsome Volume, medium 8vo, strongly bound. [Just Published. 15/0

The Author having compiled Rules and Data for his own use in a great variety of modern engineering work, and having found his notes extremely useful, decided to publish them—revised to date—believing that a practical work, suited to the DAILY REQUIREMENTS OF MODERN ENGINEERS, would be favourably received.

"Of this edition we may repeat the appreciative remarks we made upon the first and third. Since the appearance of the latter very considerable modifications have been made, although the total number of pages remains almost the same. It is a very useful collection of rules, tables, and workshop and drawing office data."—*The Engineer*, May 10, 1895.

"The author treats every subject from the point of view of one who has collected workshop notes for application in workshop practice, rather than from the theoretical or literary aspect. The volume contains a great deal of that kind of information which is gained only by practical experience, and is seldom written in books."—*The Engineer*, June 5, 1885.

"The volume is an exceedingly useful one, brimful with engineer's notes, memoranda, and rules, and well worthy of being on every mechanical engineer's bookshelf."—*Mechanical World*.

"The information is precisely that likely to be required in practice. . . . The work forms a desirable addition to the library not only of the works' manager, but of any one connected with general engineering."—*Mining Journal*.

"Brimful of useful information, stated in a concise form, Mr. Hutton's books have met a pressing want among engineers. The book must prove extremely useful to every practical man possessing a copy."—*Practical Engineer*.

THE PRACTICAL ENGINEER'S HANDBOOK.

Comprising a Treatise on Modern Engines and Boilers, Marine, Locomotive, and Stationary. And containing a large collection of Rules and Practical Data relating to Recent Practice in Designing and Constructing all kinds of Engines, Boilers, and other Engineering work. The whole constituting a comprehensive Key to the Board of Trade and other Examinations for Certificates of Competency in Modern Mechanical Engineering. By WALTER S. HUTTON, Civil and Mechanical Engineer, Author of "The Works' Manager's Handbook for Engineers," &c. With upwards of 420 Illustrations. Sixth Edition, Revised and Enlarged. Medium 8vo, 560 pp., strongly bound.

[Just Published. 18/0

This Work is designed as a companion to the Author's "WORKS' MANAGER'S HANDBOOK." It possesses many new and original features, and contains, like its predecessor, a quantity of matter not originally intended for publication but collected by the Author for his own use in the construction of a great variety of MODERN ENGINEERING WORK.

The information is given in a condensed and concise form, and is illustrated by upwards of 420 Illustrations; and comprises a quantity of tabulated matter of great value to all engaged in designing, constructing, or estimating for ENGINES, BOILERS, and OTHER ENGINEERING WORK.

"We have kept it at hand for several weeks, referring to it as occasion arose, and we have not on a single occasion consulted its pages without finding the information of which we were in quest."—*Athenaeum*.

"A thoroughly good practical handbook, which no engineer can go through without learning something that will be of service to him."—*Marine Engineer*.

"An excellent book of reference for engineers, and a valuable text-book for students of engineering."—*Scotsman*.

"This valuable manual embodies the results and experience of the leading authorities on mechanical engineering."—*Building News*.

"The author has collected together a surprising quantity of rules and practical data, and has shown much judgment in the selections he has made. . . . There is no doubt that this book is one of the most useful of its kind published, and will be a very popular compendium."—*Engineer*.

"A mass of information set down in simple language, and in such a form that it can be easily referred to at any time. The matter is uniformly good and well chosen, and is greatly elucidated by the illustrations. The book will find its way on to most engineers' shelves, where it will rank as one of the most useful books of reference."—*Practical Engineer*.

"Full of useful information, and should be found on the office shelf of all practical engineers."—*English Mechanic*.

MR. HUTTON'S PRACTICAL HANDBOOKS—*continued.***STEAM BOILER CONSTRUCTION.**

A Practical Handbook for Engineers, Boiler-Makers, and Steam Users. Containing a large Collection of Rules and Data relating to Recent Practice in the Design, Construction, and Working of all Kinds of Stationary, Locomotive, and Marine Steam-Boilers. By WALTER S. HUTTON, Civil and Mechanical Engineer, Author of "The Works' Manager's Handbook," "The Practical Engineer's Handbook," &c. With upwards of 500 Illustrations. Third Edition, Revised and much Enlarged, medium 8vo, cloth . . . **18/0**

THIS WORK is issued in continuation of the Series of Handbooks written by the Author, viz. :—"THE WORKS' MANAGER'S HANDBOOK" and "THE PRACTICAL ENGINEER'S HANDBOOK," which are so highly appreciated by engineers for the practical nature of their information; and is consequently written in the same style as those works.

The Author believes that the concentration, in a convenient form for easy reference, of such a large amount of thoroughly practical information on Steam-Boilers, will be of considerable service to those for whom it is intended, and he trusts the book may be deemed worthy of as favourable a reception as has been accorded to its predecessors.

"One of the best, if not the best, books on boilers that has ever been published. The information is of the right kind, in a simple and accessible form. So far as generation is concerned, this is, undoubtedly, the standard book on steam practice."—*Electrical Review.*

"Every detail, both in boiler design and management, is clearly laid before the reader. The volume shows that boiler construction has been reduced to the condition of one of the most exact sciences; and such a book is of the utmost value to the *fin de siècle* Engineer and Works Manager."—*Marine Engineer.*

"There has long been room for a modern handbook on steam boilers; there is not that room now, because Mr. Hutton has filled it. It is a thoroughly practical book for those who are occupied in the construction, design, selection, or use of boilers."—*Engineer.*

"The book is of so important and comprehensive a character that it must find its way into the libraries of every one interested in boiler using or boiler manufacture if they wish to be thoroughly informed. We strongly recommend the book for the intrinsic value of its contents."—*Machinery Market.*

PRACTICAL MECHANICS' WORKSHOP COMPANION.

Comprising a great variety of the most useful Rules and Formulæ in Mechanical Science, with numerous Tables of Practical Data and Calculated Results for Facilitating Mechanical Operations. By WILLIAM TEMPLETON, Author of "The Engineer's Practical Assistant," &c., &c. Eighteenth Edition, Revised, Modernised, and considerably Enlarged by WALTER S. HUTTON, C.E., Author of "The Works' Manager's Handbook," "The Practical Engineer's Handbook," &c. Fcap. 8vo, nearly 500 pp., with 8 Plates and upwards of 250 Illustrative Diagrams, strongly bound for workshop or pocket wear and tear. **6/0**

"In its modernised form Hutton's 'Templeton' should have a wide sale, for it contains much valuable information which the mechanic will often find of use, and not a few tables and notes which he might look for in vain in other works. This modernised edition will be appreciated by all who have learned to value the original editions of 'Templeton.'"—*English Mechanic.*

"It has met with great success in the engineering workshop, as we can testify; and there are a great many men who, in a great measure, owe their rise in life to this little book."—*Building News.*

"This familiar text-book—well known to all mechanics and engineers—is of essential service to the every-day requirements of engineers, millwrights, and the various trades connected with engineering and building. The new modernised edition is worth its weight in gold."—*Building News.* (Second Notice.)

"This well-known and largely-used book contains information, brought up to date, of the sort so useful to the foreman and draughtsman. So much fresh information has been introduced as to constitute it practically a new book. It will be largely used in the office and workshop."—*Mechanical World.*

"The publishers wisely entrusted the task of revision of this popular, valuable, and useful book to Mr. Hutton, than whom a more competent man they could not have found."—*Iron.*

ENGINEER'S AND MILLWRIGHT'S ASSISTANT.

A Collection of Useful Tables, Rules, and Data. By WILLIAM TEMPLETON. Eighth Edition, with Additions. 18mo, cloth . . . **2/6**

"Occupies a foremost place among books of this kind. A more suitable present to an apprentice to any of the mechanical trades could not possibly be made."—*Building News.*

A deservedly popular work. It should be in the 'drawer' of every mechanic."—*English Mechanic.*

THE MECHANICAL ENGINEER'S REFERENCE BOOK.

For Machine and Boiler Construction. In Two Parts. Part I. GENERAL ENGINEERING DATA. Part II. BOILER CONSTRUCTION. With 51 Plates and numerous Illustrations. By NELSON FOLEY, M.I.N.A. Second Edition, Revised throughout and much Enlarged. Folio, half-bound, net . **£3 3s.**

PART I.—MEASURES.—CIRCUMFERENCES AND AREAS, &c., SQUARES, CUBES, FOURTH POWERS.—SQUARE AND CUBE ROOTS.—SURFACE OF TUBES.—RECIPROCALLS.—LOGARITHMS.—MENSURATION.—SPECIFIC GRAVITIES AND WEIGHTS.—WORK AND POWER.—HEAT.—COMBUSTION.—EXPANSION AND CONTRACTION.—EXPANSION OF GASES.—STEAM.—STATIC FORCES.—GRAVITATION AND ATTRACTION.—MOTION AND COMPUTATION OF RESULTING FORCES.—ACCUMULATED WORK.—CENTRE AND RADIUS OF GYRATION.—MOMENT OF INERTIA.—CENTRE OF OSCILLATION.—ELECTRICITY.—STRENGTH OF MATERIALS.—ELASTICITY.—TEST SHEETS OF METALS.—FRICTION.—TRANSMISSION OF POWER.—FLOW OF LIQUIDS.—FLOW OF GASES.—AIR PUMPS, SURFACE CONDENSERS, &c.—SPEED OF STEAMSHIPS.—PROPELLERS.—CUTTING TOOLS.—FLANGES.—COPPER SHEETS AND TUBES.—SCREWS, NUTS, BOLT HEADS, &c.—VARIOUS RECIPES AND MISCELLANEOUS MATTER.—WITH DIAGRAMS FOR VALVE-GEAR, BELTING AND ROPES, DISCHARGE AND SUCTION PIPES, SCREW PROPELLERS, AND COPPER PIPES.

PART II.—TREATING OF POWER OF BOILERS.—USEFUL RATIOS.—NOTES ON CONSTRUCTION.—CYLINDRICAL BOILER SHELLS.—CIRCULAR FURNACES.—FLAT PLATES.—STAYS.—GIRDERS.—SCREWS.—HYDRAULIC TESTS.—RIVETING.—BOILER SETTING, CHIMNEYS, AND MOUNTINGS.—FUELS, &c.—EXAMPLES OF BOILERS AND SPEEDS OF STEAMSHIPS.—NOMINAL AND NORMAL HORSE POWER.—WITH DIAGRAMS FOR ALL BOILER CALCULATIONS AND DRAWINGS OF MANY VARIETIES OF BOILERS.

"Mr. Foley is well fitted to compile such a work. . . . The diagrams are a great feature of the work. . . . Regarding the whole work, it may be very fairly stated that Mr. Foley has produced a volume which will undoubtedly fulfil the desire of the author and become indispensable to all mechanical engineers."—*Marine Engineer*.

"We have carefully examined this work, and pronounce it a most excellent reference book for the use of marine engineers."—*Journal of American Society of Naval Engineers*.

COAL AND SPEED TABLES.

A Pocket Book for Engineers and Steam Users. By NELSON FOLEY, Author of "The Mechanical Engineer's Reference Book." Pocket-size, cloth . **3/6**

TEXT-BOOK ON THE STEAM ENGINE.

With a Supplement on GAS ENGINES, and PART II. on HEAT ENGINES. By T. M. GOODEVE, M.A., Barrister-at-Law, Professor of Mechanics at the Royal College of Science, London; Author of "The Principles of Mechanics," "The Elements of Mechanism," &c. Fourteenth Edition. Crown 8vo, cloth . **6/0**

"Professor Goodeve has given us a treatise on the steam engine which will bear comparison with anything written by Huxley or Maxwell, and we can award it no higher praise."—*Engineer*.

ON GAS ENGINES.

With Appendix describing a Recent Engine with Tube Igniter. By T. M. GOODEVE, M.A. Crown 8vo, cloth **2/6**

"Like all Mr. Goodeve's writings, the present is no exception in point of general excellence. It is a valuable little volume."—*Mechanical World*.

THE GAS-ENGINE HANDBOOK.

A Manual of Useful Information for the Designer and the Engineer. By E. W. ROBERTS, M.E. With Forty Full-page Engravings. Small Fcap. 8vo, leather. [Just Published. Net **8/6**

A TREATISE ON STEAM BOILERS.

Their Strength, Construction, and Economical Working. By R. WILSON, C.E. Fifth Edition. 12mo, cloth **6/0**

"The best treatise that has ever been published on steam boilers."—*Engineer*.
"The author shows himself perfect master of his subject, and we heartily recommend all employing steam power to possess themselves of the work."—*Ryland's Iron Trade Circular*.

THE MECHANICAL ENGINEER'S COMPANION

of Areas, Circumferences, Decimal Equivalents, in inches and feet, millimetres, squares, cubes, roots, &c.; Weights, Measures, and other Data. Also Practical Rules for Modern Engine Proportions. By R. EDWARDS, M.Inst.C.E. Fcap. 8vo, cloth. [Just Published. **3/6**

"A very useful little volume. It contains many tables, classified data and memoranda generally useful to engineers."—*Engineer*.

"What it professes to be, 'a handy office companion,' giving in a succinct form, a variety of information likely to be required by engineers in their everyday office work."—*Nature*.

A HANDBOOK ON THE STEAM ENGINE.

With especial Reference to Small and Medium-sized Engines. For the Use of Engine Makers, Mechanical Draughtsmen, Engineering Students, and users of Steam Power. By HERMAN HAEDER, C.E. Translated from the German with considerable additions and alterations, by H. H. P. POWLES, A.M.I.C.E., M.I.M.E. Second Edition, Revised. With nearly 1,100 Illustrations. Crown 8vo, cloth **9/0**

"A perfect encyclopædia of the steam engine and its details, and one which must take a permanent place in English drawing-offices and workshops."—*A Foreman Pattern-maker*.

"This is an excellent book, and should be in the hands of all who are interested in the construction and design of medium-sized stationary engines. . . . A careful study of its contents and the arrangement of the sections leads to the conclusion that there is probably no other book like it in this country. The volume aims at showing the results of practical experience, and it certainly may claim a complete achievement of this idea."—*Nature*.

BOILER AND FACTORY CHIMNEYS.

Their Draught-Power and Stability. With a chapter on *Lightning Conductors*. By ROBERT WILSON, A.I.C.E., Author of "A Treatise on Steam Boilers," &c. Crown 8vo, cloth **3/6**

"A valuable contribution to the literature of scientific building."—*The Builder*.

BOILER MAKER'S READY RECKONER & ASSISTANT.

With Examples of Practical Geometry and Templating, for the Use of Platers, Smiths, and Riveters. By JOHN COURTNEY, Edited by D. K. CLARK, M.I.C.E. Third Edition, 480 pp., with 140 Illustrations. Fcap. 8vo . **7/0**

"No workman or apprentice should be without this book."—*Iron Trade Circular*.

REFRIGERATION, COLD STORAGE, & ICE-MAKING:

A Practical Treatise on the Art and Science of Refrigeration. By A. J. WALLIS-TAYLER, A.M.Inst.C.E., Author of 'Refrigerating and Ice-Making Machinery.' 600 pp., with 360 Illustrations. Medium 8vo, cloth.

[Just Published. Net **15/0**

"The author has to be congratulated on the completion and production of such an important work and it cannot fail to have a large body of readers, for it leaves out nothing that would in any way be of value to those interested in the subject."—*Steamship*.

No one whose duty it is to handle the mammoth preserving installations of these latter days can afford to be without this valuable book."—*Glasgow Herald*.

THE POCKET BOOK OF REFRIGERATION AND ICE-MAKING FOR 1902.

Edited by A. J. WALLIS-TAYLER, A.M.Inst.C.E. Author of "Refrigerating and Ice-making Machinery," &c. With Diary and Almanac. Small Crown 8vo, cloth. [Just Published. Net **2/6**

REFRIGERATING & ICE-MAKING MACHINERY.

A Descriptive Treatise for the Use of Persons Employing Refrigerating and Ice-Making Installations, and others. By A. J. WALLIS-TAYLER, A.-M. Inst. C.E. Third Edition, Revised and Enlarged. With Illustrations. Crown 8vo, cloth. [Just Published. **7/6**

"Practical, explicit, and profusely illustrated."—*Glasgow Herald*.

"We recommend the book, which gives the cost of various systems and illustrations showing details of parts of machinery and general arrangements of complete installations."—*Builder*.

"May be recommended as a useful description of the machinery, the processes, and of the facts, figures, and tabulated physics of refrigerating. It is one of the best compilations on the subject."—*Engineer*.

TEA MACHINERY AND TEA FACTORIES.

A Descriptive Treatise on the Mechanical Appliances required in the Cultivation of the Tea Plant and the Preparation of Tea for the Market. By A. J. WALLIS-TAYLER, A.-M. Inst. C.E. Medium 8vo, 468 pp. With 218 Illustrations. [Just Published. Net **25/0**

"When tea planting was first introduced into the British possessions little, if any, machinery was employed, but now its use is almost universal. This volume contains a very full account of the machinery necessary for the proper outfit of a factory, and also a description of the processes best carried out by this machinery."—*Journal Society of Arts*.

ENGINEERING ESTIMATES, COSTS, AND ACCOUNTS.

A Guide to Commercial Engineering. With numerous examples of Estimates and Costs of Millwright Work, Miscellaneous Productions, Steam Engines and Steam Boilers; and a Section on the Preparation of Costs Accounts. By A GENERAL MANAGER. Second Edition. 8vo, cloth. [Just Published. 12/0

"This is an excellent and very useful book, covering subject-matter in constant requisition in every factory and workshop. . . . The book is invaluable, not only to the young engineer, but also to the estimate department of every works."—*Builder*.

"We accord the work unqualified praise. The information is given in a plain, straightforward manner, and bears throughout evidence of the intimate practical acquaintance of the author with every phase of commercial engineering."—*Mechanical World*.

AERIAL OR WIRE-ROPE TRAMWAYS.

Their Construction and Management, By A. J. WALLIS-TAYLER, A.M. Inst. C.E. With 81 Illustrations. Crown 8vo, cloth. [Just Published. 7/6

"This is in its way an excellent volume. Without going into the minutiae of the subject, it yet lays before its readers a very good exposition of the various systems of rope transmission in use, and gives as well not a little valuable information about their working, repair, and management. We can safely recommend it as a useful general treatise on the subject."—*The Engineer*.

MOTOR CARS OR POWER-CARRIAGES FOR COMMON ROADS.

By A. J. WALLIS-TAYLER, Assoc. Memb. Inst. C.E., Author of "Modern Cycles," &c. 212 pp., with 76 Illustrations. Crown 8vo, cloth . . . 4/6

"Mr. Wallis-Taylor's book is a welcome addition to the literature of the subject, as it is the production of an Engineer, and has not been written with a view to assist in the promotion of companies. . . . The book is clearly expressed throughout, and is just the sort of work that an engineer, thinking of turning his attention to motor-carriage work, would do well to read as a preliminary to starting operations."—*Engineering*.

PLATING AND BOILER MAKING.

A Practical Handbook for Workshop Operations. By JOSEPH G. HORNER, A.M.I.M.E. 380 pp. with 338 Illustrations. Crown 8vo, cloth . . . 7/6

"The latest production from the pen of this writer is characterised by that evidence of close acquaintance with workshop methods which will render the book exceedingly acceptable to the practical hand. . . . A practical handbook on a subject which has not hitherto received much attention from those qualified to deal with it in a satisfactory manner."—*Mechanical World*.

PATTERN MAKING.

A Practical Treatise, embracing the Main Types of Engineering Construction and including Gearing, both Hand and Machine-made, Engine Work, Sheaves and Pulleys, Pipes and Columns, Screws, Machine Parts, Pumps and Cocks, the Moulding of Patterns in Loam and Greensand, &c., together with the methods of estimating the weight of Castings; with an Appendix of Tables for Workshop Reference. By JOSEPH G. HORNER, A.M.I.M.E. Third Edition, Enlarged. With 486 Illustrations. Crown 8vo, cloth . . . Net 7/6

"A well-written technical guide, evidently written by a man who understands and has practised what he has written about. . . . We cordially recommend it to engineering students, young journeymen, and others desirous of being initiated into the mysteries of pattern-making."—*Builder*.

"An excellent *vade mecum* for the apprentice who desires to become master of his trade."—*English Mechanic*.

MECHANICAL ENGINEERING TERMS

(Lockwood's Dictionary of). Embracing those current in the Drawing Office, Pattern Shop, Foundry, Fitting, Turning, Smiths', and Boiler Shops, &c. Comprising upwards of 6,000 Definitions. Edited by J. G. HORNER, A.M.I.M.E. Third Edition, Revised. Crown 8vo, cloth . . . Net 7/6

"Just the sort of handy dictionary required by the various trades engaged in mechanical engineering. The practical engineering pupil will find the book of great value in his studies, and every foreman engineer and mechanic should have a copy."—*Building News*.

TOOTHED GEARING.

A Practical Handbook for Offices and Workshops. By JOSEPH HORNER, A.M.I.M.E. With 184 Illustrations. Crown 8vo, cloth . . . 8/0

"We must give the book our unqualified praise for its thoroughness of treatment, and we can heartily recommend it to all interested as the most practical book on the subject yet written."—*Mechanical World*.

FIRES, FIRE-ENGINES, AND FIRE BRIGADES.

With a History of Fire-Engines, their Construction, Use, and Management; Foreign Fire Systems; Hints on Fire-Brigades, &c. By CHARLES F. T. YOUNG, C.E. 8vo, cloth . . . £1 4s.

"To such of our readers as are interested in the subject of fires and fire apparatus we can most heartily commend this book."—*Engineering*.

AËRIAL NAVIGATION.

A Practical Handbook on the Construction of Dirigible Balloons, Aërostats, Aëroplanes, and Aëromotors. By FREDERICK WALKER, C.E., Associate Member of the Aëronautic Institute. With 104 Illustrations. Large Crown 8vo, cloth. [Just Published. Net. 7/6

STONE-WORKING MACHINERY.

A Manual dealing with the Rapid and Economical Conversion of Stone. With Hints on the Arrangement and Management of Stone Works. By M. POWIS BALE, M.I.M.E. Second Edition, enlarged. Crown 8vo, cloth . . . 9/0

"Should be in the hands of every mason or student of stonework."—*Colliery Guardian*.
"A capital handbook for all who manipulate stone for building or ornamental purposes."—*Machinery Market*.

PUMPS AND PUMPING.

A Handbook for Pump Users. Being Notes on Selection, Construction, and Management. By M. POWIS BALE, M.I.M.E. Fourth Edition. Crown 8vo, cloth. [Just Published. 3/6

"The matter is set forth as concisely as possible. In fact, condensation rather than diffuseness has been the author's aim throughout; yet he does not seem to have omitted anything likely to be of use."—*Journal of Gas Lighting*.

MILLING MACHINES AND PROCESSES.

A Practical Treatise on Shaping Metals by Rotary Cutters. Including Information on Making and Grinding the Cutters. By PAUL N. HASLUCK, Author of "Lathe-Work." 352 pp. With upwards of 300 Engravings. Large crown 8vo, cloth 12/6

"A new departure in engineering literature. . . . We can recommend this work to all interested in milling machines; it is what it professes to be—a practical treatise."—*Engineer*.

"A capital and reliable book which will no doubt be of considerable service both to those who are already acquainted with the process as well as to those who contemplate its adoption."—*Industries*.

LATHE-WORK.

A Practical Treatise on the Tools, Appliances, and Processes employed in the Art of Turning. By P. N. HASLUCK. Seventh Edition. Crown 8vo. 5/0

"Written by a man who knows not only how work ought to be done, but who also knows how to do it, and how to convey his knowledge to others. To all turners this book would be valuable."—*Engineering*.

"We can safely recommend the work to young engineers. To the amateur it will simply be invaluable. To the student it will convey a great deal of useful information."—*Engineer*.

SCREW-THREADS,

And Methods of Producing Them. With numerous Tables and complete Directions for using Screw-Cutting Lathes. By PAUL N. HASLUCK, Author of "Lathe-Work," &c. Fifth Edition. Waistcoat-pocket size . . . 1/6

"Full of useful information, hints and practical criticism. Taps, dies, and screwing tools generally are illustrated and their actions described."—*Mechanical World*.

"It is a complete compendium of all the details of the screw-cutting lathe; in fact a *multum-in-parvo* on all the subjects it treats upon."—*Carpenter and Builder*.

TABLES AND MEMORANDA FOR ENGINEERS, MECHANICS, ARCHITECTS, BUILDERS, &c.

Selected and Arranged by FRANCIS SMITH. Sixth Edition, Revised, including ELECTRICAL TABLES, FORMULÆ, and MEMORANDA. Waistcoat-pocket size, limp leather. [Just Published. 1/6

"It would, perhaps, be as difficult to make a small pocket-book selection of notes and formulae to suit ALL engineers as it would be to make a universal medicine; but Mr. Smith's waistcoat-pocket collection may be looked upon as a successful attempt."—*Engineer*.

"The best example we have ever seen of 270 pages of useful matter packed into the dimensions of a card-case."—*Building News*. "A veritable pocket treasury of knowledge."—*Iron*.

POCKET GLOSSARY OF TECHNICAL TERMS.

English-French, French-English; with Tables suitable for the Architectural, Engineering, Manufacturing, and Nautical Professions. By JOHN JAMES FLETCHER. Third Edition, 200 pp. Waistcoat-pocket size, leather . . . 1/6

"It is a very great advantage for readers and correspondents in France and England to have so large a number of the words relating to engineering and manufacturers collected in a lilliputian volume. The little book will be useful both to students and travellers."—*Architect*.

"The glossary of terms is very complete, and many of the Tables are new and well arranged. We cordially commend the book."—*Mechanical World*.

THE ENGINEER'S YEAR BOOK FOR 1902.

Comprising Formulæ, Rules, Tables, Data and Memoranda in Civil, Mechanical, Electrical, Marine and Mine Engineering. By H. R. KEMPE, A.M. Inst. C.E., M.I.E.E., Principal Technical Officer, Engineer-in-Chief's Office, General Post Office, London, Author of "A Handbook of Electrical Testing," "The Electrical Engineer's Pocket-Book," &c. With 1,000 Illustrations, specially Engraved for the work. Crown 8vo, 900 pp., leather. [Just Published. **8/0**

"Kempe's Year Book really requires no commendation. Its sphere of usefulness is widely known, and it is used by engineers the world over."—*The Engineer*.

"The volume is distinctly in advance of most similar publications in this country,"—*Engineering*.

"This valuable and well-designed book of reference meets the demands of all descriptions of engineers."—*Saturday Review*.

"Teems with up-to-date information in every branch of engineering and construction."—*Building News*.

"The needs of the engineering profession could hardly be supplied in a more admirable, complete and convenient form. To say that it more than sustains all comparisons is praise of the highest sort, and that may justly be said of it."—*Mining Journal*.

"There is certainly room for the newcomer, which supplies explanations and directions, as well as formulæ and tables. It deserves to become one of the most successful of the technical annuals."—*Architect*.

"Brings together with great skill all the technical information which an engineer has to use day by day. It is in every way admirably equipped, and is sure to prove successful."—*Scotsman*.

"The up-to-dateness of Mr. Kempe's compilation is a quality that will not be lost on the busy people for whom the work is intended."—*Glasgow Herald*.

THE PORTABLE ENGINE.

A Practical Manual on its Construction and Management. For the use of Owners and Users of Steam Engines generally. By WILLIAM DYSON WANSBROUGH. Crown 8vo, cloth **3/6**

"This is a work of value to those who use steam machinery. . . . Should be read by every one who has a steam engine, on a farm or elsewhere."—*Mark Lane Express*.

"We cordially commend this work to buyers and owners of steam-engines, and to those who have to do with their construction or use."—*Timber Trades Journal*.

"Such a general knowledge of the steam-engine as Mr. Wansbrough furnishes to the reader should be acquired by all intelligent owners and others who use the steam-engine."—*Building News*.

"An excellent text-book of this useful form of engine. The 'Hints to Purchasers' contain a good deal of common-sense and practical wisdom."—*English Mechanic*.

STATIONARY STEAM ENGINES.

Their Care and Management. By CHARLES HURST, Author of "Valves and Valve Gearing." Crown 8vo. [In the press.

IRON AND STEEL.

A Work for the Forge, Foundry, Factory, and Office. Containing ready, useful, and trustworthy information for Ironmasters and their Stock-takers; Managers of Bar, Rail, Plate, and Sheet Rolling Mills; Iron and Metal Founders; Iron Ship and Bridge Builders; Mechanical, Mining, and Consulting Engineers; Architects, Contractors, Builders, &c. By CHARLES HOARE, Author of "The Slide Rule," &c. Ninth Edition. 32mo, leather . **6/0**

"For comprehensiveness the book has not its equal."—*Iron*.

"One of the best of the pocket books."—*English Mechanic*.

CONDENSED MECHANICS.

A Selection of Formulæ, Rules, Tables, and Data for the Use of Engineering Students, &c. By W. G. C. HUGHES, A.M.I.C.E. Crown 8vo, cloth . **2/6**

"The book is well fitted for those who are either confronted with practical problems in their work, or are preparing for examination and wish to refresh their knowledge by going through their formulæ again."—*Marine Engineer*.

THE SAFE USE OF STEAM.

Containing Rules for Unprofessional Steam Users. By an ENGINEER. Seventh Edition. Sewed **6d.**

"If steam-users would but learn this little book by heart, boiler explosion would become sensations by their rarity."—*English Mechanic*

THE LOCOMOTIVE ENGINE.

The Autobiography of an Old Locomotive Engine. By ROBERT WEATHERBURN, M.I.M.E. With Illustrations and Portraits of GEORGE and ROBERT STEPHENSON. Crown 8vo, cloth. [Just Published. Net 2/6

SUMMARY OF CONTENTS:—PROLOGUE.—CYLINDERS.—MOTIONS.—CONNECTING RODS.—FRAMES.—WHEELS.—PUMPS, CLACKS, &c.—INJECTORS.—BOILERS.—SMOKE BOX.—CHIMNEY.—WEATHER BOARD AND AWNING.—INTERNAL DISSENSIONS.—ENGINE DRIVERS, &c.

"It would be difficult to imagine anything more ingeniously planned, more cleverly worked out, and more charmingly written. Readers cannot fail to find the volume most enjoyable."—*Glasgow Herald*.

THE LOCOMOTIVE ENGINE AND ITS DEVELOPMENT.

A Popular Treatise on the Gradual Improvements made in Railway Engines between 1803 and 1896. By CLEMENT E. STRETTON, C.E. Fifth Edition, Enlarged. With 120 Illustrations. Crown 8vo, cloth. [Just Published. 3/6

"Students of railway history and all who are interested in the evolution of the modern locomotive will find much to attract and entertain in this volume."—*The Times*.

LOCOMOTIVE ENGINE DRIVING.

A Practical Manual for Engineers in Charge of Locomotive Engines. By MICHAEL REYNOLDS, Member of the Society of Engineers, formerly Locomotive Inspector, L. B. & S. C. R. Eleventh Edition. Including a KEY TO THE LOCOMOTIVE ENGINE. Crown 8vo, cloth 4/6

"Mr. Reynolds has supplied a want, and has supplied it well. We can confidently recommend the book not only to the practical driver, but to everyone who takes an interest in the performance of locomotive engines."—*The Engineer*.

"Mr. Reynolds has opened a new chapter in the literature of the day. His treatise is admirable."—*Athenaeum*.

THE MODEL LOCOMOTIVE ENGINEER,

Fireman, and Engine-Boy. Comprising a Historical Notice of the Pioneer Locomotive Engines and their Invention. By MICHAEL REYNOLDS. Second Edition, with Revised Appendix. Crown 8vo, cloth. [Just Published. 4/6

"From the technical knowledge of the author, it will appeal to the railway man of to-day more forcibly than anything written by Dr. Smiles. . . . The volume contains information of a technical kind, and facts that every driver should be familiar with."—*English Mechanic*.

"We should be glad to see this book in the possession of everyone in the kingdom who has ever laid, or is to lay, hands on a locomotive engine."—*Iron*.

CONTINUOUS RAILWAY BRAKES.

A Practical Treatise on the several Systems in Use in the United Kingdom: their Construction and Performance. With copious Illustrations and numerous Tables. By MICHAEL REYNOLDS. 8vo, cloth 9/0

"A popular explanation of the different brakes. It will be of great assistance in forming public opinion, and will be studied with benefit by those who take an interest in the brake."—*English Mechanic*.

STATIONARY ENGINE DRIVING.

A Practical Manual for Engineers in Charge of Stationary Engines. By MICHAEL REYNOLDS. Sixth Edition. Crown 8vo, cloth 4/6

"The author is thoroughly acquainted with his subjects, and his advice on the various points treated is clear and practical. . . . He has produced a manual which is an exceedingly useful one for the class for whom it is specially intended."—*Engineering*.

"Our author leaves no stone unturned. He is determined that his readers shall not only know something about the stationary engine, but all about it."—*Engineer*.

ENGINE-DRIVING LIFE.

Stirring Adventure and Incidents in the Lives of Locomotive Engine-Drivers. By MICHAEL REYNOLDS. Third Edition. Crown 8vo, cloth . 1/6

"Perfectly fascinating. Wilkie Collins's most thrilling conceptions are thrown into the shade by true incidents, endless in their variety, related in every page."—*North British Mail*.

THE ENGINEMAN'S POCKET COMPANION,

And Practical Educator for Enginemen, Boiler Attendants, and Mechanics. By MICHAEL REYNOLDS. With 45 Illustrations and numerous Diagrams. Fourth Edition, Revised. Royal 18mo, strongly bound for pocket wear 3/6

"This admirable work is well suited to accomplish its object, being the honest workmanship competent engineer."—*Glasgow Herald*.

CIVIL ENGINEERING, SURVEYING, &c.

LIGHT RAILWAYS FOR THE UNITED KINGDOM, INDIA, AND THE COLONIES.

A Practical Handbook setting forth the Principles on which Light Railways should be Constructed, Worked, and Financed; and detailing the Cost of Construction, Equipment, Revenue and Working Expenses of Local Railways already established in the above-mentioned countries, and in Belgium, France, Switzerland, &c. By J. C. MACKAY, F.G.S., A.M. Inst. C.E. Illustrated with Plates and Diagrams. Medium 8vo, cloth. [Just Published. 15/0

"Mr. Mackay's volume is clearly and concisely written, admirably arranged, and freely illustrated. The book is exactly what has been long wanted. We recommend it to all interested in the subject. It is sure to have a wide sale."—*Railway News*.

TUNNELLING.

A Practical Treatise. By CHARLES PRELINI, C.E. With additions by CHARLES S. HILL, C.E. Including 150 Diagrams and Illustrations. Royal 8vo, cloth. [Just Published. Net 16/0

PRACTICAL TUNNELLING.

Explaining in detail Setting-out the Works, Shaft-sinking, and Heading-driving, Ranging the Lines and Levelling underground, Sub-Excavating, Timbering and the Construction of the Brickwork of Tunnels, with the amount of Labour required for, and the Cost of, the various portions of the work. By FREDERICK W. SIMMS, M. Inst. C.E. Fourth Edition, Revised and Further Extended, including the most recent (1895) Examples of Sub-aqueous and other Tunnels, by D. KINNEAR CLARK, M. Inst. C.E. Imperial 8vo, with 34 Folding Plates and other Illustrations. Cloth. [Just Published. £2 2s.

"The present (1896) edition has been brought right up to date, and is thus rendered a work to which civil engineers generally should have ready access, and to which engineers who have construction work can hardly afford to be without, but which to the younger members of the profession is invaluable, as from its pages they can learn the state to which the science of tunnelling has attained."—*Railway News*.

"The estimation in which Mr. Simms's book has been held for many years cannot be more truly expressed than in the words of the late Prof. Rankine: 'The best source of information on the subject of tunnels is Mr. F. W. Simms's work on Practical Tunnelling.'"—*Architect*.

THE WATER SUPPLY OF TOWNS AND THE CONSTRUCTION OF WATER-WORKS.

A Practical Treatise for the Use of Engineers and Students of Engineering. By W. K. BURTON, A.M. Inst. C.E., Professor of Sanitary Engineering in the Imperial University, Tokyo, Japan, and Consulting Engineer to the Tokyo Water-works. Second Edition, Revised and Extended. With numerous Plates and Illustrations. Super-royal 8vo, buckram. [Just Published. 25/0

I. INTRODUCTORY.—II. DIFFERENT QUALITIES OF WATER.—III. QUANTITY OF WATER TO BE PROVIDED.—IV. ON ASCERTAINING WHETHER A PROPOSED SOURCE OF SUPPLY IS SUFFICIENT.—V. ON ESTIMATING THE STORAGE CAPACITY REQUIRED TO BE PROVIDED.—VI. CLASSIFICATION OF WATER-WORKS.—VII. IMPOUNDING RESERVOIRS.—VIII. EARTHWORK DAMS.—IX. MASONRY DAMS.—X. THE PURIFICATION OF WATER.—XI. SETTLING RESERVOIRS.—XII. SAND FILTRATION.—XIII. PURIFICATION OF WATER BY ACTION OF IRON, SOFTENING OF WATER BY ACTION OF LIME, NATURAL FILTRATION.—XIV. SERVICE OR CLEAN WATER RESERVOIRS—WATER TOWERS—STAND PIPES.—XV. THE CONNECTION OF SETTLING RESERVOIRS, FILTER BEDS AND SERVICE RESERVOIRS.—XVI. PUMPING MACHINERY.—XVII. FLOW OF WATER IN CONDUITS—PIPES AND OPEN CHANNELS.—XVIII. DISTRIBUTION SYSTEMS.—XIX. SPECIAL PROVISIONS FOR THE EXTINCTION OF FIRE.—XX. PIPES FOR WATER-WORKS.—XXI. PREVENTION OF WASTE OF WATER.—XXII. VARIOUS APPLICATIONS USED IN CONNECTION WITH WATER-WORKS.

APPENDIX I. By PROF. JOHN MILNE, F.R.S.—CONSIDERATIONS CONCERNING THE PROBABLE EFFECTS OF EARTHQUAKES ON WATER-WORKS, AND THE SPECIAL PRECAUTIONS TO BE TAKEN IN EARTHQUAKE COUNTRIES.

APPENDIX II. By JOHN DE RIJKE, C.E.—ON SAND DUNES AND DUNE SAND AS A SOURCE OF WATER SUPPLY.

"The chapter upon filtration of water is very complete, and the details of construction well illustrated. . . . The work should be specially valuable to civil engineers engaged in work in Japan, but the interest is by no means confined to that locality."—*Engineer*.

"We congratulate the author upon the practical commonsense shown in the preparation of this work. . . . The plates and diagrams have evidently been prepared with great care, and cannot fail to be of great assistance to the student."—*Builder*.

"The whole art of water-works construction is dealt with in a clear and comprehensive fashion in this handsome volume. . . . Mr. Burton's practical treatise shows in all its sections the fruit of independent study and individual experience. It is largely based upon his own practice in the branch of engineering of which it treats."—*Saturday Review*.

THE WATER SUPPLY OF CITIES AND TOWNS.

By WILLIAM HUMBER, A. M. Inst. C.E., and M. Inst. M.E., Author of "Cast and Wrought Iron Bridge Construction," &c., &c. Illustrated with 50 Double Plates, 1 Single Plate, Coloured Frontispiece, and upwards of 250 Woodcuts, and containing 400 pp. of Text. Imp. 4to, elegantly and substantially half-bound in morocco *Net £6 6s.*

LIST OF CONTENTS.

I. HISTORICAL SKETCH OF SOME OF THE MEANS THAT HAVE BEEN ADOPTED FOR THE SUPPLY OF WATER TO CITIES AND TOWNS.—II. WATER AND THE FOREIGN MATTER USUALLY ASSOCIATED WITH IT.—III. RAINFALL AND EVAPORATION.—IV. SPRINGS AND THE WATER-BEARING FORMATIONS OF VARIOUS DISTRICTS.—V. MEASUREMENT AND ESTIMATION OF THE FLOW OF WATER.—VI. ON THE SELECTION OF THE SOURCE OF SUPPLY.—VII. WELLS.—VIII. RESERVOIRS.—IX. THE PURIFICATION OF WATER.—X. PUMPS.—XI. PUMPING MACHINERY.—XII. CONDUITS.—XIII. DISTRIBUTION OF WATER.—XIV. METERS, SERVICE PIPES, AND HOUSE FITTINGS.—XV. THE LAW OF ECONOMY OF WATER-WORKS.—XVI. CONSTANT AND INTERMITTENT SUPPLY.—XVII. DESCRIPTION OF PLATES.—APPENDICES, GIVING TABLES OF RATES OF SUPPLY, VELOCITIES, &c., &c., TOGETHER WITH SPECIFICATIONS OF SEVERAL WORKS ILLUSTRATED, AMONG WHICH WILL BE FOUND: ABERDEEN, BIDEFORD, CANTERBURY, DUNDEE, HALIFAX, LAMBETH, ROTHERHAM, DUBLIN, AND OTHERS.

"The most systematic and valuable work upon water supply hitherto produced in English, or in any other language. It is characterised almost throughout by an exhaustiveness much more distinctive of French and German than of English technical treatises."—*Engineer.*

RURAL WATER SUPPLY.

A Practical Handbook on the Supply of Water and Construction of Water-works for small Country Districts. By ALLAN GREENWELL, A.M.I.C.E., and W. T. CURRY, A.M.I.C.E., F.G.S. With Illustrations. Second Edition, Revised. Crown 8vo, cloth. [*Just Published. 5/0*]

"We conscientiously recommend it as a very useful book for those concerned in obtaining water for small districts, giving a great deal of practical information in a small compass."—*Builder.*

"The volume contains valuable information upon all matters connected with water supply. . . . Full of details on points which are continually before water-works engineers."—*Nature.*

HYDRAULIC POWER ENGINEERING.

A Practical Manual on the Concentration and Transmission of Power by Hydraulic Machinery. By G. CROYDON MARKS, A.M. Inst. C.E. With nearly 200 Illustrations. 8vo, cloth. [*Just Published. Net 9/0*]

SUMMARY OF CONTENTS:—PRINCIPLES OF HYDRAULICS.—THE OBSERVED FLOW OF WATER.—HYDRAULIC PRESSURES, MATERIAL.—TEST LOAD PACKINGS FOR SLIDING SURFACES.—PIPE JOINTS.—CONTROLLING VALVES.—PLATFORM LIFTS.—WORKSHOP, FACTORY, AND DOCK CRANES.—HYDRAULIC ACCUMULATORS.—PRESSES.—SHEET METAL WORKING AND FORGING MACHINERY.—HYDRAULIC RIVETTERS.—HAND, POWER, AND STEAM PUMPS.—TURBINES.—IMPULSE AND RE-ACTION TURBINES.—DESIGN OF TURBINES.—WATER WHEELS.—HYDRAULIC ENGINES.—RECENT ACHIEVEMENTS.—TABLES.

"We have nothing but praise for this thoroughly valuable work. The author has succeeded in rendering his subject interesting as well as instructive."—*Practical Engineer.*

"Can be unhesitatingly recommended as a useful and up-to-date manual on hydraulic transmission and utilisation of power."—*Mechanical World.*

HYDRAULIC TABLES, CO-EFFICIENTS, & FORMULÆ.

For Finding the Discharge of Water from Orifices, Notches, Weirs, Pipes, and Rivers. With New Formulæ, Tables, and General Information on Rain-fall, Catchment-Basins, Drainage, Sewerage, Water Supply for Towns and Mill Power. By JOHN NEVILLE, Civil Engineer, M.R.I.A. Third Edition, revised, with additions. Numerous Illustrations. Crown 8vo, cloth . 14/0

"It is, of all English books on the subject, the one nearest to completeness."—*Architect.*

HYDRAULIC MANUAL.

Consisting of Working Tables and Explanatory Text. Intended as a Guide in Hydraulic Calculations and Field Operations. By LOWIS D'A. JACKSON, Author of "Aid to Survey Practice," "Modern Metrology," &c. Fourth Edition, Enlarged. Large crown 8vo, cloth 16/0

"The author has constructed a manual which may be accepted as a trustworthy guide to this branch of the engineer's profession."—*Engineering.*

WATER ENGINEERING.

A Practical Treatise on the Measurement, Storage, Conveyance, and Utilisation of Water for the Supply of Towns, for Mill Power, and for other Purposes. By C. SLAGG, A. M. Inst. C.E. Second Edition. Crown 8vo, cloth . 7/8

"As a small practical treatise on the water supply of towns, and on some applications of water power, the work is in many respects excellent."—*Engineering.*

THE RECLAMATION OF LAND FROM TIDAL WATERS.

A Handbook for Engineers, Landed Proprietors, and others interested in Works of Reclamation. By ALEXANDER BEAZELEY, M.Inst. C.E. With Illustrations. 8vo, cloth. *[Just Published. Net 10/6]*

"The book shows in a concise way what has to be done in reclaiming land from the sea, and the best way of doing it. The work contains a great deal of practical and useful information which cannot fail to be of service to engineers entrusted with the enclosure of salt marshes, and to land-owners intending to reclaim land from the sea."—*The Engineer*.

"The author has carried out his task efficiently and well, and his book contains a large amount of information of great service to engineers and others interested in works of reclamation."—*Nature*.

MASONRY DAMS FROM INCEPTION TO COMPLETION.

Including numerous Formulæ, Forms of Specification and Tender, Pocket Diagram of Forces, &c. For the use of Civil and Mining Engineers. By C. F. COURTNEY, M. Inst. C.E. 8vo, cloth. *[Just Published. 9/0]*

"The volume contains a good deal of valuable data, and furnishes the engineer with practical advice. Many useful suggestions will be found in the remarks on site and position, location of dam, foundations and construction."—*Building News*.

RIVER BARS.

The Causes of their Formation, and their Treatment by "Induced Tidal Scour"; with a Description of the Successful Reduction by this Method of the Bar at Dublin. By I. J. MANN, Assist. Eng. to the Dublin Port and Docks Board. Royal 8vo, cloth. *7/6*

"We recommend all interested in harbour works—and, indeed, those concerned in the improvements of rivers generally—to read Mr. Mann's interesting work."—*Engineer*.

TRAMWAYS: THEIR CONSTRUCTION AND WORKING.

Embracing a Comprehensive History of the System; with an exhaustive Analysis of the Various Modes of Traction, including Horse Power, Steam, Cable Traction, Electric Traction, &c.; a Description of the Varieties of Rolling Stock; and ample Details of Cost and Working Expenses. New Edition, Thoroughly Revised, and Including the Progress recently made in Tramway Construction, &c., &c. By D. KINNEAR CLARK, M. Inst. C.E. With 400 Illustrations. 8vo, 780 pp., buckram. *[Just Published. 28/0]*

"The new volume is one which will rank, among tramway engineers and those interested in tramway working, with the Author's world-famed book on railway machinery."—*The Engineer*.

SURVEYING AS PRACTISED BY CIVIL ENGINEERS AND SURVEYORS.

Including the Setting-out of Works for Construction and Surveys Abroad, with many Examples taken from Actual Practice. A Handbook for use in the Field and the Office, intended also as a Text-book for Students. By JOHN WHITE-LAW, Jun., A. M. Inst. C.E., Author of "Points and Crossings." With about 260 Illustrations. Demy 8vo, cloth. *[Just Published. Net 10/6]*

PRACTICAL SURVEYING.

A Text-Book for Students preparing for Examinations or for Survey-work in the Colonies. By GEORGE W. USILL, A.M.I.C.E. With 4 Plates and upwards of 330 Illustrations. Seventh Edition. Including Tables of Natural Sines, Tangents, Secants, &c. Crown 8vo, cloth *7/6*; or, on THIN PAPER, leather, gilt edges, for pocket use. *12/6*

"The best forms of instruments are described as to their construction, uses and modes of employment, and there are innumerable hints on work and equipment such as the author, in his experience as surveyor, draughtsman and teacher, has found necessary, and which the student in his inexperience will find most serviceable."—*Engineer*.

"The latest treatise in the English language on surveying, and we have no hesitation in saying that the student will find it a better guide than any of its predecessors. Deserves to be recognised as the first book which should be put in the hands of a pupil of Civil Engineering."—*Architect*.

AID TO SURVEY PRACTICE.

For Reference in Surveying, Levelling, and Setting-out; and in Route Surveys of Travellers by Land and Sea. With Tables, Illustrations, and Records. By LOWIS D'A. JACKSON, A.M.I.C.E. 8vo, cloth. *12/6*

"A valuable *vade-mecum* for the surveyor. We recommend this book as containing an admirable supplement to the teaching of the accomplished surveyor."—*Athenæum*.

"The author brings to his work a fortunate union of theory and practical experience which, aided by a clear and lucid style of writing, renders the book a very useful one."—*Builder*.

SURVEYING WITH THE TACHEOMETER.

A practical Manual for the use of Civil and Military Engineers and Surveyors. Including two series of Tables specially computed for the Reduction of Readings in Sexagesimal and in Centesimal Degrees. By NEIL KENNEDY, M. Inst. C.E. With Diagrams and Plates. Demy 8vo, cloth. *Net 10/6*

"The work is very clearly written, and should remove all difficulties in the way of any surveyor desirous of making use of this useful and rapid instrument."—*Nature*.

ENGINEER'S & MINING SURVEYOR'S FIELD BOOK.

Consisting of a Series of Tables, with Rules, Explanations of Systems, and use of Theodolite for Traverse Surveying and plotting the work with minute accuracy by means of Straight Edge and Set Square only; Levelling with the Theodolite, Setting-out Curves with and without the Theodolite, Earthwork Tables, &c. By W. DAVIS HASKOLL, C.E. With numerous Woodcuts. Fourth Edition, Enlarged. Crown 8vo, cloth *12/0*

"The book is very handy; the separate tables of sines and tangents to every minute will make it useful for many other purposes, the genuine traverse tables existing all the same."—*Athenæum*.

LAND AND MARINE SURVEYING.

In Reference to the Preparation of Plans for Roads and Railways; Canals, Rivers, Towns' Water Supplies; Docks and Harbours. With Description and Use of Surveying Instruments. By W. DAVIS HASKOLL, C.E. Second Edition, Revised, with Additions. Large crown 8vo, cloth *9/0*

"This book must prove of great value to the student. We have no hesitation in recommending it, feeling assured that it will more than repay a careful study."—*Mechanical World*.

"A most useful book for the student. We strongly recommend it as a carefully-written and valuable text-book. It enjoys a well-deserved repute among surveyors."—*Builder*.

PRINCIPLES AND PRACTICE OF LEVELLING.

Showing its Application to Purposes of Railway and Civil Engineering in the Construction of Roads; with Mr. TELFORD'S Rules for the same. By FREDERICK W. SIMMS, F.G.S., M. Inst. C.E. Eighth Edition, with the addition of LAW'S Practical Examples for Setting-out Railway Curves, and TRAUTWINE'S Field Practice of Laying-out Circular Curves. With 7 Plates and numerous Woodcuts, 8vo, cloth *8/6*

. TRAUTWINE ON CURVES may be had separate *5/0*

"The text-book on levelling in most of our engineering schools and colleges."—*Engineer*.

"The publishers have rendered a substantial service to the profession, especially to the younger members, by bringing out the present edition of Mr. Simms's useful work."—*Engineering*.

AN OUTLINE OF THE METHOD OF CONDUCTING A TRIGONOMETRICAL SURVEY.

For the Formation of Geographical and Topographical Maps and Plans, Military Reconnaissance, LEVELLING, &c., with Useful Problems, Formulæ, and Tables. By Lieut.-General FROME, R.E. Fourth Edition, Revised and partly Re-written by Major-General Sir CHARLES WARREN, G.C.M.G., R.E. With 19 Plates and 115 Woodcuts, royal 8vo, cloth *16/0*

"No words of praise from us can strengthen the position so well and so steadily maintained by this work. Sir Charles Warren has revised the entire work, and made such additions as were necessary to bring every portion of the contents up to the present date."—*Broad Arrow*.

TABLES OF TANGENTIAL ANGLES AND MULTIPLES FOR SETTING-OUT CURVES.

From 5 to 200 Radius. By A. BEAZELEV, M. Inst. C.E. 6th Edition, Revised. With an Appendix on the use of the Tables for Measuring up Curves. Printed on 50 Cards, and sold in a cloth box, waistcoat-pocket size. *[Just Published. 3/6]*

"Each table is printed on a card, which, placed on the theodolite, leaves the hands free to manipulate the instrument—no small advantage as regards the rapidity of work."—*Engineer*.

"Very handy: a man may know that all his day's work must fall on two of these cards, which he puts into his own card-case, and leaves the rest behind."—*Athenæum*.

HANDY GENERAL EARTH-WORK TABLES.

Giving the Contents in Cubic Yards of Centre and Slopes of Cuttings and Embankments from 3 inches to 80 feet in Depth or Height, for use with either 66 feet Chain or 100 feet Chain. By J. H. WATSON BUCK, M. Inst. C.E. On a Sheet mounted in cloth case. *[Just Published. 3/6]*

EARTHWORK TABLES.

Showing the Contents in Cubic Yards of Embankments, Cuttings, &c., of Heights or Depths up to an average of 80 feet. By JOSEPH BROADBENT, C.E., and FRANCIS CAMPIN, C.E. Crown 8vo, cloth 5/0

"The way in which accuracy is attained, by a simple division of each cross section into three elements, two in which are constant and one variable, is ingenious."—*Athenæum*.

A MANUAL ON EARTHWORK.

By ALEX. J. S. GRAHAM, C.E. With numerous Diagrams. Second Edition. 18mo, cloth 2/6

THE CONSTRUCTION OF LARGE TUNNEL SHAFTS.

A Practical and Theoretical Essay. By J. H. WATSON BUCK, M. Inst. C.E., Resident Engineer, L. and N. W. R. With Folding Plates, 8vo, cloth 12/0

"Many of the methods given are of extreme practical value to the mason, and the observations on the form of arch, the rules for ordering the stone, and the construction of the templates, will be found of considerable use. We commend the book to the engineering profession."—*Building News*.

"Will be regarded by civil engineers as of the utmost value, and calculated to save much time and obviate many mistakes."—*Colliery Guardian*.

CAST & WROUGHT IRON BRIDGE CONSTRUCTION

(A Complete and Practical Treatise on), including Iron Foundations. In Three Parts.—Theoretical, Practical, and Descriptive. By WILLIAM HUMBER, A. M. Inst. C.E., and M. Inst. M.E. Third Edition, revised and much improved, with 115 Double Plates (20 of which now first appear in this edition), and numerous Additions to the Text. In 2 vols., imp. 4to, half-bound in morocco £6 16s. 6d.

"A very valuable contribution to the standard literature of civil engineering. In addition to elevations, plans, and sections, large scale details are given, which very much enhance the instructive worth of those illustrations."—*Civil Engineer and Architect's Journal*.

"Mr. Humber's stately volumes, lately issued—in which the most important bridges erected during the last five years, under the direction of the late Mr. Brunel, Sir W. Cubitt, Mr. Hawkshaw, Mr. Page, Mr. Fowler, Mr. Hemans, and others among our most eminent engineers, are drawn and specified in great detail."—*Engineer*.

ESSAY ON OBLIQUE BRIDGES

(Practical and Theoretical). With 13 large Plates. By the late GEORGE WATSON BUCK, M.I.C.E. Fourth Edition, revised by his Son, J. H. WATSON BUCK, M.I.C.E.; and with the addition of Description to Diagrams for Facilitating the Construction of Oblique Bridges, by W. H. BARLOW, M.I.C.E. Royal 8vo, cloth 12/0

"The standard text-book for all engineers regarding skew arches is Mr. Buck's treatise, and it would be impossible to consult a better."—*Engineer*.

"Mr. Buck's treatise is recognised as a standard text-book, and his treatment has divested the subject of many of the intricacies supposed to belong to it. As a guide to the engineer and architect, on a confessedly difficult subject, Mr. Buck's work is unsurpassed."—*Building News*

THE CONSTRUCTION OF OBLIQUE ARCHES

(A Practical Treatise on). By JOHN HART. Third Edition, with Plates. Imperial 8vo, cloth 8/0

GRAPHIC AND ANALYTIC STATICS.

In their Practical Application to the Treatment of Stresses in Roofs, Solid Girders, Lattice, Bowstring, and Suspension Bridges, Braced Iron Arches and Piers, and other Frameworks. By R. HUDSON GRAHAM, C.E. Containing Diagrams and Plates to Scale. With numerous Examples, many taken from existing Structures. Specially arranged for Class-work in Colleges and Universities. Second Edition, Revised and Enlarged. 8vo, cloth 16/0

"Mr. Graham's book will find a place wherever graphic and analytic statics are used or studied."—*Engineer*.

"The work is excellent from a practical point of view, and has evidently been prepared with much care. The directions for working are simple, and are illustrated by an abundance of well-selected examples. It is an excellent text-book for the practical draughtsman."—*Athenæum*.

WEIGHTS OF WROUGHT IRON & STEEL GIRDERS.

A Graphic Table for Facilitating the Computation of the Weights of Wrought Iron and Steel Girders, &c., for Parliamentary and other Estimates. By J. H. WATSON BUCK, M. Inst. C.E. On a Sheet 2/6

PRACTICAL GEOMETRY.

For the Architect, Engineer, and Mechanic. Giving Rules or the Delineation and Application of various Geometrical Lines, Figures, and Curves. By E. W. TARN, M.A., Architect. 8vo, cloth 9/0

"No book with the same objects in view has ever been published in which the clearness of the rules laid down and the illustrative diagrams have been so satisfactory."—*Scotsman*

THE GEOMETRY OF COMPASSES.

Or, Problems Resolved by the mere Description of Circles and the Use of Coloured Diagrams and Symbols. By OLIVER BYRNE. Coloured Plates. Crown 8vo, cloth 3/6

HANDY BOOK FOR THE CALCULATION OF STRAINS

In Girders and Similar Structures and their Strength. Consisting of Formulæ and Corresponding Diagrams, with numerous details for Practical Application, &c. By WILLIAM HUMBER, A. M. Inst. C.E., &c. Fifth Edition. Crown 8vo, with nearly 100 Woodcuts and 3 Plates, cloth 7/6

"The formulæ are neatly expressed, and the diagrams good."—*Athenæum*.

"We heartily commend this really *handy* book to our engineer and architect readers."—*English Mechanic*.

TRUSSES OF WOOD AND IRON.

Practical Applications of Science in Determining the Stresses, Breaking Weights, Safe Loads, Scantlings, and Details of Construction. With Complete Working Drawings. By WILLIAM GRIFFITHS, Surveyor. 8vo, cloth. 4/6

"This handy little book enters so minutely into every detail connected with the construction of roof trusses that no student need be ignorant of these matters."—*Practical Engineer*.

THE STRAINS ON STRUCTURES OF IRONWORK.

With Practical Remarks on Iron Construction. By F. W. SHEILDS, M.I.C.E. 8vo, cloth 5/0

A TREATISE ON THE STRENGTH OF MATERIALS.

With Rules for Application in Architecture, the Construction of Suspension Bridges, Railways, &c. By PETER BARLOW, F.R.S. A new Edition, revised by his Sons, P. W. BARLOW, F.R.S., and W. H. BARLOW, F.R.S.; to which are added, Experiments by HODGKINSON, FAIRBAIRN, and KIRKALDY; and Formulæ for calculating Girders, &c. Arranged and Edited by WM. HUMBER, A. M. Inst. C.E. 8vo, cloth 18/0

"Valuable alike to the student tyro, and the experienced practitioner, it will always rank in future as it has hitherto done, as the standard treatise on that particular subject."—*Engineer*.

"As a scientific work of the first class, it deserves a foremost place on the bookshelves of every civil engineer and practical mechanic."—*English Mechanic*.

SAFE RAILWAY WORKING.

A Treatise on Railway Accidents, their Cause and Prevention; with a Description of Modern Appliances and Systems. By CLEMENT E. STRETTON, C.E., Vice-President and Consulting Engineer, Amalgamated Society of Railway Servants. With Illustrations and Coloured Plates. Third Edition, Enlarged. Crown 8vo, cloth 3/6

"A book for the engineer, the directors, the managers; and, in short, all who wish for information on railway matters will find a perfect encyclopædia in 'Safe Railway Working.'"—*Railway Review*.

"We commend the remarks on railway signalling to all railway managers, especially where a uniform code and practice is advocated."—*Herepath's Railway Journal*.

EXPANSION OF STRUCTURES BY HEAT.

By JOHN KEILY, C.E., late of the Indian Public Works Department. Crown 8vo, cloth 3/6

The aim the author has set before him, viz., to show the effects of heat upon metallic and other structures, is a laudable one, for this is a branch of physics upon which the engineer or architect can find but little reliable and comprehensive data in books."—*Builder*.

THE PROGRESS OF MODERN ENGINEERING.

Complete in Four Volumes, imperial 4to, half-morocco, price **£12 12s.**

Each volume sold separately, as follows:—

FIRST SERIES, Comprising Civil, Mechanical, Marine, Hydraulic, Railway, Bridge, and other Engineering Works, &c. By WILLIAM HUMBER, A. M. Inst. C.E., &c. Imp. 4to, with 36 Double Plates, drawn to a large scale, Photographic Portrait of John Hawkshaw, C.E., F.R.S., &c., and copious descriptive Letterpress, Specifications, &c. Half-morocco . . . **£3 3s.**

LIST OF THE PLATES AND DIAGRAMS.

VICTORIA STATION AND ROOF, L. B. & S. C. R. (8 PLATES); SOUTHPORT PIER (2 PLATES); VICTORIA STATION AND ROOF, L. C. & D. AND G. W. R. (6 PLATES); ROOF OF CREMORNE MUSIC HALL; BRIDGE OVER G. N. RAILWAY; ROOF OF STATION, DUTCH RHENISH RAIL (2 PLATES); BRIDGE OVER THE THAMES, WEST LONDON EXTENSION RAILWAY (5 PLATES); ARMOUR PLATES; SUSPENSION BRIDGE, THAMES (4 PLATES); THE ALLEN ENGINE; SUSPENSION BRIDGE, AVON (3 PLATES); UNDERGROUND RAILWAY (3 PLATES).

HUMBER'S MODERN ENGINEERING.

SECOND SERIES. Imp. 4to, with 3 Double Plates, Photographic Portrait of Robert Stephenson, C.E., M.P., F.R.S., &c., and copious descriptive Letterpress, Specifications, &c. Half-morocco . . . **£3 3s.**

LIST OF THE PLATES AND DIAGRAMS.

BIRKENHEAD DOCKS, LOW WATER BASIN (15 PLATES); CHARING CROSS STATION ROOF, C. C. RAILWAY (3 PLATES); DIGSWELL VIADUCT, GREAT NORTHERN RAILWAY; ROBBERY WOOD VIADUCT, GREAT NORTHERN RAILWAY; IRON PERMANENT WAY; CLYDACH VIADUCT, MERTHYR, TREDEGAR, AND ABERGAVENNY RAILWAY; EBBW VIADUCT, MERTHYR, TREDEGAR, AND ABERGAVENNY RAILWAY; COLLEGE WOOD VIADUCT, CORNWALL RAILWAY; DUBLIN WINTER PALACE ROOF (3 PLATES); BRIDGE OVER THE THAMES, L. C. & D. RAILWAY (6 PLATES); ALBERT HARBOUR, GREENOCK (4 PLATES).

HUMBER'S MODERN ENGINEERING.

THIRD SERIES. Imp. 4to, with 40 Double Plates, Photographic Portrait of J. R. M'Clean, late Pres. Inst. C.E., and copious descriptive Letterpress, Specifications, &c. Half-morocco . . . **£3 3s.**

LIST OF THE PLATES AND DIAGRAMS.

MAIN DRAINAGE, METROPOLIS.—*North Side.*—MAP SHOWING INTERCEPTION OF SEWERS; MIDDLE LEVEL SEWER (2 PLATES); OUTFALL SEWER, BRIDGE OVER RIVER LEA (3 PLATES); OUTFALL SEWER, BRIDGE OVER MARSH LANE, NORTH WOOLWICH RAILWAY, AND BOW AND BARKING RAILWAY JUNCTION; OUTFALL SEWER, BRIDGE OVER BOW AND BARKING RAILWAY (3 PLATES); OUTFALL SEWER, BRIDGE OVER EAST LONDON WATER-WORKS' FEEDER (2 PLATES); OUTFALL SEWER RESERVOIR (2 PLATES); OUTFALL SEWER, TUMBLING BAY AND OUTLET; OUTFALL SEWER, PENSTOCKS. *South Side.*—OUTFALL SEWER, BERMONDSEY BRANCH (2 PLATES); OUTFALL SEWER, RESERVOIR AND OUTLET (4 PLATES); OUTFALL SEWER, FILTH HOIST; SECTIONS OF SEWERS NORTH AND SOUTH SIDES).

THAMES EMBANKMENT.—SECTION OF RIVER WALL; STEAMBOAT PIER, WESTMINSTER (2 PLATES); LANDING STAIRS BETWEEN CHARING CROSS AND WATERLOO BRIDGES; YORK GATE (2 PLATES); OVERFLOW AND OUTLET AT SAVOY STREET SEWER (3 PLATES); STEAMBOAT PIER, WATERLOO BRIDGE (3 PLATES); JUNCTION OF SEWERS, PLANS AND SECTIONS; GULLIES, PLANS AND SECTIONS; ROLLING STOCK; GRANITE AND IRON FORTS.

HUMBER'S MODERN ENGINEERING.

FOURTH SERIES. Imp. 4to, with 36 Double Plates, Photographic Portrait of John Fowler, late Pres. Inst. C.E., and copious descriptive Letterpress, Specifications, &c. Half-morocco . . . **£3 3s.**

LIST OF THE PLATES AND DIAGRAMS.

ABBEY MILLS PUMPING STATION, MAIN DRAINAGE, METROPOLIS (4 PLATES); BARROW DOCKS (5 PLATES); MANQUIS VIADUCT, SANTIAGO AND VALPARAISO RAILWAY, (2 PLATES); ADAM'S LOCOMOTIVE, ST. HELEN'S CANAL RAILWAY (2 PLATES); CANNON STREET STATION ROOF, CHARING CROSS RAILWAY (3 PLATES); ROAD BRIDGE OVER THE RIVER MOKA (2 PLATES); TELEGRAPHIC APPARATUS FOR MESOPOTAMIA; VIADUCT OVER THE RIVER WYE, MIDLAND RAILWAY (3 PLATES); ST. GERMANS VIADUCT, CORNWALL RAILWAY (2 PLATES); WROUGHT-IRON CYLINDER FOR DIVING BELL, MILLWALL DOCKS (6 PLATES); MILROY'S PATENT EXCAVATOR; METROPOLITAN DISTRICT RAILWAY (6 PLATES); HARBOURS, PORTS, AND BREAKWATERS (3 PLATES).

MARINE ENGINEERING, SHIPBUILDING, NAVIGATION, &c.

THE NAVAL ARCHITECT'S AND SHIPBUILDER'S POCKET-BOOK of Formulæ, Rules, and Tables, and Marine Engineer's and Surveyor's Handy Book of Reference. By CLEMENT MACKROW, M.I.N.A. Eighth Edition, Carefully Revised and Enlarged. Fcap., leather.

[Just Published. Net 12/6

SUMMARY OF CONTENTS:—SIGNS AND SYMBOLS, DECIMAL FRACTIONS.—TRIGONOMETRY.—PRACTICAL GEOMETRY.—MENSURATION.—CENTRES AND MOMENTS OF FIGURES.—MOMENTS OF INERTIA AND RADII OF GYRATION.—ALGEBRAICAL EXPRESSIONS FOR SIMPSON'S RULES.—MECHANICAL PRINCIPLES.—CENTRE OF GRAVITY.—LAWS OF MOTION.—DISPLACEMENT, CENTRE OF BUOYANCY.—CENTRE OF GRAVITY OF SHIP'S HULL.—STABILITY CURVES AND METACENTRES.—SEA AND SHALLOW-WATER WAVES.—ROLLING OF SHIPS.—PROPULSION AND RESISTANCE OF VESSELS.—SPEED TRIALS.—SAILING, CENTRE OF EFFORT.—DISTANCES DOWN RIVERS, COAST LINES.—STEERING AND RUDDERS OF VESSELS.—LAUNCHING CALCULATIONS AND VELOCITIES.—WEIGHT OF MATERIAL AND GEAR.—GUN PARTICULARS AND WEIGHT.—STANDARD GAUGES.—RIVETED JOINTS AND RIVETING.—STRENGTH AND TESTS OF MATERIALS.—BINDING AND SHEARING STRESSES, &c.—STRENGTH OF SHAFTING, PULLERS, WHEELS, &c.—HYDRAULIC DATA, &c.—CONIC SECTIONS, CATENARIAN CURVES.—MECHANICAL POWERS, WORK.—BOARD OF TRADE REGULATIONS FOR BOILERS AND ENGINES.—BOARD OF TRADE REGULATIONS FOR SHIPS.—LLOYD'S RULES FOR BOILERS.—LLOYD'S WEIGHT OF CHAINS.—LLOYD'S SCANTLINGS FOR SHIPS.—DATA OF ENGINES AND VESSELS.—SHIPS' FITTINGS AND TESTS.—SEASONING PRESERVING TIMBER.—MEASUREMENT OF TIMBER.—ALLOYS, PAINTS, VARNISHES.—DATA FOR STOWAGE.—ADMIRALTY TRANSPORT REGULATIONS.—RULES FOR HORSE-POWER, SCREW PROPELLERS, &c.—PERCENTAGES FOR BUTT STRAPS, &c.—PARTICULARS OF YACHTS.—MASTING AND RIGGING VESSELS.—DISTANCES OF FOREIGN PORTS.—TONNAGE TABLES.—VOCABULARY OF FRENCH AND ENGLISH TERMS.—ENGLISH WEIGHTS AND MEASURES.—FOREIGN WEIGHTS AND MEASURES.—DECIMAL EQUIVALENTS.—FOREIGN MONEY.—DISCOUNT AND WAGES TABLES.—USEFUL NUMBERS AND READY RECKONERS.—TABLES OF CIRCULAR MEASURES.—TABLES OF AREAS OF AND CIRCUMFERENCES OF CIRCLES.—TABLES OF AREAS OF SEGMENTS OF CIRCLES.—TABLES OF SQUARES AND CUBES AND ROOTS OF NUMBERS.—TABLES OF LOGARITHMS OF NUMBERS.—TABLES OF HYPERBOLIC LOGARITHMS.—TABLES OF NATURAL SINES, TANGENTS, &c.—TABLES OF LOGARITHMIC SINES, TANGENTS, &c.

"In these days of advanced knowledge a work like this is of the greatest value. It contains a vast amount of information. We unhesitatingly say that it is the most valuable compilation for its specific purpose that has ever been printed. No naval architect, engineer, surveyor, or seaman, wood or iron shipbuilder, can afford to be without this work."—*Nautical Magazine*.

"Should be used by all who are engaged in the construction or design of vessels. . . Will be found to contain the most useful tables and formulæ required by shipbuilders, carefully collected from the best authorities, and put together in a popular and simple form. The book is one of exceptional merit."—*Engineer*.

"The professional shipbuilder has now, in a convenient and accessible form, reliable data for solving many of the numerous problems that present themselves in the course of his work."—*Iron*.

"There is no doubt that a pocket-book of this description must be a necessity in the shipbuilding trade. . . The volume contains a mass of useful information clearly expressed and presented in a handy form."—*Marine Engineer*.

WANNAN'S MARINE ENGINEER'S GUIDE

To Board of Trade Examinations for Certificates of Competency. Containing all Latest Questions to Date, with Simple, Clear, and Correct Solutions; 302 Elementary Questions with Illustrated Answers, and Verbal Questions and Answers; complete Set of Drawings with Statements completed. By A. C. WANNAN, C.E., Consulting Engineer, and E. W. I. WANNAN, M.I.M.E., Certificated First Class Marine Engineer. Illustrated with numerous Engravings. Third Edition, Revised and Enlarged. 500 pages. Large crown 8vo, cloth.

[Just Published. Net 10/6

"The book is clearly and plainly written and avoids unnecessary explanations and formulas, and we consider it a valuable book for students of marine engineering."—*Nautical Magazine*.

WANNAN'S MARINE ENGINEER'S POCKET-BOOK

Containing the Latest Board of Trade Rules and Data for Marine Engineers. By A. C. WANNAN. Third Edition, Revised, Enlarged, and Brought Up to Date. Square 18mo, with thumb Index, leather. [Just Published. 5/0

"There is a great deal of useful information in this little pocket-book. It is of the rule-of-thumb order, and is, on that account, well adapted to the uses of the sea-going engineer."—*Engineer*.

SEA TERMS, PHRASES, AND WORDS

(Technical Dictionary of) used in the English and French Languages (English-French, French-English). For the Use of Seamen, Engineers, Pilots, Shipbuilders, Shipowners, and Ship-brokers. Compiled by W. PIRRIE, late of the African Steamship Company. Fcap. 8vo, cloth limp 5/0

"This volume will be highly appreciated by seamen, engineers, pilots, shipbuilders and ship-owners. It will be found wonderfully accurate and complete."—*Scotsman*.
 "A very useful dictionary, which has long been wanted by French and English engineers, masters, officers and others."—*Shipping World*.

ELECTRIC SHIP-LIGHTING.

A Handbook on the Practical Fitting and Running of Ships' Electrical Plant, for the Use of Shipowners and Builders, Marine Electricians and Sea-going Engineers in Charge. By J. W. URQUHART, Author of "Electric Light," "Dynamo Construction," &c. Second Edition, Revised and Extended. 326 pp., with 88 Illustrations. Crown 8vo, cloth. [Just Published. 7/6

MARINE ENGINEER'S POCKET-BOOK.

Consisting of useful Tables and Formulæ. By FRANK PROCTOR, A.I.N.A. Third Edition. Royal 32mo, leather, gilt edges, with strap 4/0

We recommend it to our readers as going far to supply a long-felt want."—*Naval Science*.
 A most useful companion to all marine engineers."—*United Service Gazette*.

ELEMENTARY ENGINEERING.

A Manual for Young Marine Engineers and Apprentices. In the Form of Questions and Answers on Metals, Alloys, Strength of Materials, Construction and Management of Marine Engines and Boilers, Geometry, &c., &c. With an Appendix of Useful Tables. By J. S. BREWER. Crown 8vo, cloth 1/6

"Contains much valuable information for the class for whom it is intended, especially in the chapters on the management of boilers and engines."—*Nautical Magazine*.

MARINE ENGINES AND STEAM VESSELS.

A Treatise on. By ROBERT MURRAY, C.E. Eighth Edition, thoroughly Revised, with considerable Additions by the Author and by GEORGE CARLISLE, C.E., Senior Surveyor to the Board of Trade. 12mo, cloth 4/6

PRACTICAL NAVIGATION.

Consisting of THE SAILOR'S SEA-BOOK, by JAMES GREENWOOD and W. H. ROSSER; together with the exquisite Mathematical and Nautical Tables for the Working of the Problems, by HENRY LAW, C.E., and Professor J. R. YOUNG. Illustrated. 12mo, strongly half-bound 7/0

THE ART AND SCIENCE OF SAILMAKING.

By SAMUEL B. SADLER, Practical Sailmaker, late in the employment of Messrs. Ratsey and Laphorne, of Cowes and Gosport. With Plates and other Illustrations. Small 4to, cloth 12/6

"This extremely practical work gives a complete education in all the branches of the manufacture, cutting out, roping, seaming, and goring. It is copiously illustrated, and will form a first-rate text-book and guide."—*Portsmouth Times*.

CHAIN CABLES AND CHAINS.

Comprising Sizes and Curves of Links, Studs, &c., Iron for Cables and Chains, Chain Cable and Chain Making, Forming and Welding Links, Strength of Cables and Chains, Certificates for Cables, Marking Cables, Prices of Chain Cables and Chains, Historical Notes, Acts of Parliament, Statutory Tests, Charges for Testing, List of Manufacturers of Cables, &c., &c. By THOMAS W. TRAILL, F.E.R.N., M.Inst.C.E., Engineer-Surveyor-in-Chief, Board of Trade, Inspector of Chain Cable and Anchor Proving Establishments, and General Superintendent Lloyd's Committee on Proving Establishments. With numerous Tables, Illustrations, and Lithographic Drawings. Folio, cloth, bevelled boards £2 2s.

"It contains a vast amount of valuable information. Nothing seems to be wanting to make it a complete and standard work of reference on the subject."—*Nautical Magazine*.

MINING, METALLURGY, AND COLLIERY WORKING.

THE DEEP LEVEL MINES OF THE RAND,

And their Future Development, considered from the Commercial Point of View. By G. A. DENNY, M.N.E. Inst. M.E., Consulting Engineer to the General Mining and Finance Corporation, Ltd., of London, Berlin, Paris, and Johannesburg. Fully Illustrated with Diagrams and Folding Plates. Royal 8vo, buckram. [Just Published. Net 25/0

"Mr. Denny by confining himself to the consideration of the future of the deep-level mines of the Rand breaks new ground, and by dealing with the subject rather from a commercial standpoint than from a scientific one, appeals to a wide circle of readers. The book cannot fail to prove of very great value to investors in South African mines."—*Mining Journal*.

The volume will interest all who are concerned in any way with the Witwatersrand Goldfields."—*The Times*.

PROSPECTING FOR GOLD.

A Handbook of Information and Hints for Prospectors based on Personal Experience. By DANIEL J. RANKIN, F.R.S.G.S., M.R.A.S. Author of "The Zambesi Basin," &c.; formerly Manager of the Central African Company, and Leader of African Gold Prospecting Expeditions. With Illustrations specially Drawn and Engraved for the Work. Fcap. 8vo, leather. Net 7/6

"This well-compiled book contains a collection of the richest gems of useful knowledge for the prospector's benefit. A special table is given to accelerate the spotting at a glance of minerals associated with gold."—*Mining Journal*

THE METALLURGY OF GOLD.

A Practical Treatise on the Metallurgical Treatment of Gold-bearing Ores. Including the Assaying, Melting, and Refining of Gold. By M. ESSLER, A.I.M.E., M. Inst. M.M. Fifth Edition, Enlarged. With 300 Illustrations and Folding Plates. Medium 8vo, cloth. [Just Published. Net 21/0

"This book thoroughly deserves its title of a 'Practical Treatise.' The whole process of gold milling, from the breaking of the quartz to the assay of the bullion, is described in clear and orderly narrative and with much, but not too much, fulness of detail."—*Saturday Review*.

"The work is a storehouse of information and valuable data, and we strongly recommend it to all professional men engaged in the gold-mining industry."—*Mining Journal*.

THE CYANIDE PROCESS OF GOLD EXTRACTION.

Including its Practical Application on the Witwatersrand Gold Fields and elsewhere. By M. ESSLER, M.E. With Diagrams and Working Drawings. Third Edition, Revised and Enlarged. 8vo, cloth Net 7/6

"This book is just what was needed to acquaint mining men with the actual working of a process which is not only the most popular, but is, as a general rule, the most successful for the extraction of gold from tailings."—*Mining Journal*.

DIAMOND DRILLING FOR GOLD & OTHER MINERALS.

A Practical Handbook on the Use of Modern Diamond Core Drills in Prospecting and Exploiting Mineral-Bearing Properties, including Particulars of the Costs of Apparatus and Working. By G. A. DENNY, M.N.E. Inst. M.E., M.I.M. and M. Medium 8vo, 168 pp., with Illustrative Diagrams. 12/6

"Mr. Denny deserves grateful recognition for supplying a decided want. We strongly recommend every board of directors to carefully peruse the pages of this valuable volume of eminently practical data, which should be in the possession of those interested in mining."—*Mining Journal*.

FIELD TESTING FOR GOLD AND SILVER.

A Practical Manual for Prospectors and Miners. By W. H. MERRITT, M.N.E. Inst. M.E., A.R.S.M., &c. Fcap. 8vo, leather. Net 5/0

"As an instructor of prospectors' classes Mr. Merritt has the advantage of knowing exactly the information likely to be most valuable to the miner in the field. The work will be a useful addition to a prospector's kit."—*Mining Journal*.

"It gives the gist of the author's experience as a teacher of prospectors, and is a book which no prospector could use habitually without finding it pan out well."—*Scotsman*.

THE PROSPECTOR'S HANDBOOK.

A Guide for the Prospector and Traveller in search of Metal-Bearing or other Valuable Minerals. By J. W. ANDERSON, M.A. (Camb.), F.R.G.S. Ninth Edition. Crown 8vo, cloth, 3/6; or, leather, pocket-book form. 4/6

"Will supply a much-felt want, especially among Colonists, in whose way are so often thrown many mineralogical specimens the value of which it is difficult to determine."—*Engineer*.

"How to find commercial minerals, and how to identify them when they are found, are the leading points to which attention is directed. The author has managed to pack as much practical detail into his pages as would supply material for a book three times its size."—*Mining Journal*.

THE METALLURGY OF SILVER.

A Practical Treatise on the Amalgamation, Roasting, and Lixiviation of Silver Ores. Including the Assaying, Melting, and Refining of Silver Bullion. By M. EISSLER, Author of "The Metallurgy of Gold," &c. Third Edition. Crown 8vo, cloth **10/6**

"A practical treatise, and a technical work which we are convinced will supply a long-felt want amongst practical men, and at the same time be of value to students and others indirectly connected with the industries."—*Mining Journal*.

"From first to last the book is thoroughly sound and reliable."—*Colliery Guardian*.

"For chemists, practical miners, assayers, and investors alike we do not know of any work on the subject so handy and yet so comprehensive."—*Glasgow Herald*.

THE HYDRO-METALLURGY OF COPPER.

Being an Account of Processes Adopted in the Hydro-Metallurgical Treatment of Cupriferos Ores, Including the Manufacture of Copper Vitriol, with Chapters on the Sources of Supply of Copper and the Roasting of Copper Ores. By M. EISSLER, M.I.M.M. Medium 8vo, cloth. [*Just Published*. Net **12/6**

THE METALLURGY OF ARGENTIFEROUS LEAD.

A Practical Treatise on the Smelting of Silver-Lead Ores and the Refining of Lead Bullion. Including Reports on various Smelting Establishments and Descriptions of Modern Smelting Furnaces and Plants in Europe and America. By M. EISSLER, M.E., Author of "The Metallurgy of Gold," &c. Crown 8vo, 400 pp., with 183 Illustrations, cloth **12/6**

"The numerous metallurgical processes, which are fully and extensively treated of, embrace all the stages experienced in the passage of the lead from the various natural states to its issue from the refinery as an article of commerce."—*Practical Engineer*.

"The present volume fully maintains the reputation of the author. Those who wish to obtain a thorough insight into the present state of this industry cannot do better than read this volume, and all mining engineers cannot fail to find many useful hints and suggestions in it."—*Industries*.

METALLIFEROUS MINERALS AND MINING.

By D. C. DAVIES, F.G.S. Sixth Edition, thoroughly Revised and much Enlarged by his Son, E. HENRY DAVIES, M.E., F.G.S. 600 pp., with 173 Illustrations. Large crown 8vo, cloth [*Just Published*. Net **12/6**

"Neither the practical miner nor the general reader, interested in mines, can have a better book for his companion and his guide."—*Mining Journal*.

"As a history of the present state of mining throughout the world this book has a real value, and it supplies an actual want."—*Athenæum*.

MACHINERY FOR METALLIFEROUS MINES.

A Practical Treatise for Mining Engineers, Metallurgists, and Managers of Mines. By E. HENRY DAVIES, M.E., F.G.S. Medium 8vo, cloth, 600 pp. With Folding Plates and other Illustrations. [*Just Published*. Net **25/0**

"Mr. Davies, in this handsome volume, has done the advanced student and the manager of mines good service. Almost every kind of machinery in actual use is carefully described, and the woodcuts and plates are good."—*Athenæum*.

"From cover to cover the work exhibits all the same characteristics which excite the confidence and attract the attention of the student as he peruses the first page. The work may safely be recommended. By its publication the literature connected with the industry will be enriched and the reputation of its author enhanced."—*Mining Journal*.

EARTHY AND OTHER MINERALS AND MINING.

By D. C. DAVIES, F.G.S., Author of "Metalliferous Minerals," &c. Third Edition, Revised and Enlarged by his Son, E. HENRY DAVIES, M.E., F.G.S. With about 100 Illustrations. Crown 8vo, cloth **12/6**

"We do not remember to have met with any English work on mining matters that contains the same amount of information packed in equally convenient form."—*Academy*.

"We should be inclined to rank it as among the very best of the handy technical and trades manuals which have recently appeared."—*British Quarterly Review*.

BRITISH MINING.

A Treatise on the History, Discovery, Practical Development, and Future Prospects of Metalliferous Mines in the United Kingdom. By ROBERT HUNT, F.R.S., late Keeper of Mining Records. Upwards of 950 pp., with 230 Illustrations. Second Edition, Revised. Super-royal 8vo, cloth **£2 2s.**

"The book is a treasure-house of statistical information on mining subjects, and we know of no other work embodying so great a mass of matter of this kind. Were this the only merit of Mr. Hunt's volume it would be sufficient to render it indispensable in the library of every one interested in the development of the mining and metallurgical industries of this country."—*Athenæum*.

POCKET-BOOK FOR MINERS AND METALLURGISTS.

Comprising Rules, Formulæ, Tables, and Notes for Use in Field and Office Work. By F. DANVERS POWER, F.G.S., M.E. Second Edition, Corrected. Fcap. 8vo, leather. [Just Published. 9/0

"This excellent book is an admirable example of its kind, and ought to find a large sale amongst English-speaking prospectors and mining engineers."—*Engineering*.

THE MINER'S HANDBOOK.

A Handy Book of Reference on the subjects of Mineral Deposits, Mining Operations, Ore Dressing, &c. For the Use of Students and others interested in Mining Matters. By JOHN MILNE, F.R.S., Professor of Mining in the Imperial University of Japan. Third Edition. Fcap. 8vo, leather . 7/6

"Professor Milne's handbook is sure to be received with favour by all connected with mining, and will be extremely popular among students."—*Athenæum*.

THE IRON ORES OF GREAT BRITAIN AND IRELAND.

Their Mode of Occurrence, Age and Origin, and the Methods of Searching for and Working Them. With a Notice of some of the Iron Ores of Spain. By J. D. KENDALL, F.G.S., Mining Engineer. Crown 8vo, cloth . . 16/0

MINE DRAINAGE.

A Complete Practical Treatise on Direct-Acting Underground Steam Pumping Machinery. By STEPHEN MICHELL. Second Edition, Re-written and Enlarged, 390 pp. With 250 Illustrations. Royal 8vo, cloth. Net 25/0

SUMMARY OF CONTENTS:—HORIZONTAL PUMPING ENGINES.—ROTARY AND NON-ROTARY HORIZONTAL ENGINES.—SIMPLE AND COMPOUND STEAM PUMPS.—VERTICAL PUMPING ENGINES.—ROTARY AND NON-ROTARY VERTICAL ENGINES.—SIMPLE AND COMPOUND STEAM PUMPS.—TRIPLE-EXPANSION STEAM PUMPS.—PULSATING STEAM PUMPS.—PUMP VALVES.—SINKING PUMPS, &c., &c.

"This volume contains an immense amount of important and interesting new matter. The book should undoubtedly prove of great use to all who wish for information on the subject, inasmuch as the different patterns of steam pumps are not alone lucidly described and clearly illustrated, but in addition numerous tables are supplied, in which their sizes, capacity, price, &c., are set forth, hence facilitating immensely the rational selection of a pump to suit any purpose that the reader may desire, or, on the other hand, supplying him with useful information about any of the pumps that come within the scope of the volume."—*The Engineer*.

ELECTRICITY AS APPLIED TO MINING.

A Practical Treatise for Mining Engineers. By ARNOLD LUPTON, M.Inst.C.E., M.I.E.E., G. D. ASPINALL PARR, M.I.E.E., and HERBERT PERKIN, M.I.M.E. With a large number of Illustrations. Medium 8vo, cloth.

[Just Published. Net 7/6

THE COLLIERY MANAGER'S HANDBOOK.

A Comprehensive Treatise on the Laying-out and Working of Collieries, Designed as a Book of Reference for Colliery Managers, and for the Use of Coal Mining Students preparing for First-class Certificates. By CALEB PAMELV, Mining Engineer and Surveyor; Member of the North of England Institute of Mining and Mechanical Engineers; and Member of the South Wales Institute of Mining Engineers. With 700 Plans, Diagrams, and other Illustrations. Fourth Edition, Revised and Enlarged, medium 8vo, over 900 pp. Strongly bound £1 5s.

SUMMARY OF CONTENTS:—GEOLOGY.—SEARCH FOR COAL.—MINERAL LEASES AND OTHER HOLDINGS.—SHAFT SINKING.—FITTING UP THE SHAFT AND SURFACE ARRANGEMENTS.—STEAM BOILERS AND THEIR FITTINGS.—TIMBERING AND WALLING.—NARROW WORK AND METHODS OF WORKING.—UNDERGROUND CONVEYANCE.—DRAINAGE.—THE GASES MET WITH IN MINES; VENTILATION.—ON THE FRICTION OF AIR IN MINES.—THE PRIESTMAN OIL ENGINE; PETROLEUM AND NATURAL GAS.—SURVEYING AND PLANNING.—SAFETY LAMPS AND FIREDAMP DETECTORS.—SUNDRY AND INCIDENTAL OPERATIONS AND APPLIANCES.—COLLIERY EXPLOSIONS.—MISCELLANEOUS QUESTIONS AND ANSWERS.—Appendix: SUMMARY OF REPORT OF H.M. COMMISSIONERS ON ACCIDENTS IN MINES.

"Mr. Pamelv has not only given us a comprehensive reference book of a very high order, suitable to the requirements of mining engineers and colliery managers, but has also provided mining students with a class-book that is as interesting as it is instructive."—*Colliery Manager*.

"Mr. Pamelv's work is eminently suited to the purpose for which it is intended, being clear, interesting, exhaustive, rich in detail, and up to date, giving descriptions of the latest machines in every department. A mining engineer could scarcely go wrong who followed this work."—*Colliery Guardian*.

"This is the most complete 'all-round' work on coal-mining published in the English language. . . . No library of coal-mining books is complete without it."—*Colliery Engineer* (Scranton, Pa., U.S.A.).

COLLIERY WORKING AND MANAGEMENT.

Comprising the Duties of a Colliery Manager, the Oversight and Arrangement of Labour and Wages, and the different Systems of Working Coal Seams. By H. F. BULMAN and R. A. S. REDMAYNE. 350 pp., with 28 Plates and other Illustrations, including Underground Photographs. Medium 8vo, cloth. [Just Published. 15/0

"This is, indeed, an admirable Handbook for Colliery Managers, in fact it is an indispensable adjunct to a Colliery Manager's education, as well as being a most useful and interesting work on the subject for all who in any way have to do with coal mining. The underground photographs are an attractive feature of the work, being very lifelike and necessarily true representations of the scenes they depict."—*Colliery Guardian*.

"Mr. Bulman and Mr. Redmayne, who are both experienced Colliery Managers of great literary ability, are to be congratulated on having supplied an authoritative work dealing with a side of the subject of coal mining which has hitherto received but scant treatment. The authors elucidate their text by 119 woodcuts and 28 plates, most of the latter being admirable reproductions of photographs taken underground with the aid of the magnesium flash-light. These illustrations are excellent."—*Nature*.

COAL AND COAL MINING.

By the late Sir WARINGTON W. SMYTH, F.R.S., Chief Inspector of the Mines of the Crown. Eighth Edition, Revised and Extended by T. FORSTER BROWN, Mining Engineer, Chief Inspector of the Mines of the Crown and of the Duchy of Cornwall. Crown 8vo, cloth. [Just Published. 3/6

"As an outline is given of every known coal-field in this and other countries, as well as of the principal methods of working, the book will doubtless interest a very large number of readers."—*Mining Journal*.

NOTES AND FORMULÆ FOR MINING STUDENTS.

By JOHN HERMAN MERIVALE, M.A., Late Professor of Mining in the Durham College of Science, Newcastle-upon-Tyne. Fourth Edition, Revised and Enlarged. By H. F. BULMAN, A.M.Inst.C.E. Small crown 8vo, cloth. 2/6

"The author has done his work in a creditable manner, and has produced a book that will be of service to students and those who are practically engaged in mining operations."—*Engineer*.

INFLAMMABLE GAS AND VAPOUR IN THE AIR

(The Detection and Measurement of). By FRANK CLOWES, D.Sc., Lond., F.I.C., Prof. of Chemistry in the University College, Nottingham. With a Chapter on THE DETECTION AND MEASUREMENT OF PETROLEUM VAPOUR by BOVERTON REDWOOD, F.R.S.E., Consulting Adviser to the Corporation of London under the Petroleum Acts. Crown 8vo, cloth. Net 5/0

"Professor Clowes has given us a volume on a subject of much industrial importance . . . Those interested in these matters may be recommended to study this book, which is easy of comprehension and contains many good things."—*The Engineer*.

"A book that no mining engineer—certainly no coal miner—can afford to ignore or to leave unread."—*Mining Journal*.

COAL & IRON INDUSTRIES of the UNITED KINGDOM.

Comprising a Description of the Coal Fields, and of the Principal Seams of Coal, with Returns of their Produce and its Distribution, and Analyses of Special Varieties. Also, an Account of the Occurrence of Iron Ores in Veins or Seams; Analyses of each Variety; and a History of the Rise and Progress of Pig Iron Manufacture. By RICHARD MEADE. 8vo, cloth . . . £1 8s.

"Of this book we may unreservedly say that it is the best of its class which we have ever met. . . . A book of reference which no one engaged in the iron or coal trades should omit from his library."—*Iron and Coal Trades Review*.

ASBESTOS AND ASBESTIC.

Their Properties, Occurrence, and Use. By ROBERT H. JONES, F.S.A., Mineralogist, Hon. Mem. Asbestos Club, Black Lake, Canada. With Ten Colotype Plates and other Illustrations. Demy 8vo, cloth. [Just Published. 16/0

"An interesting and invaluable work."—*Colliery Guardian*.

GRANITES AND OUR GRANITE INDUSTRIES.

By GEORGE F. HARRIS, F.G.S., Membre de la Société Belge de Géologie, Lecturer on Economic Geology at the Birkbeck Institution, &c. With Illustrations. Crown 8vo, cloth . . . 2/6

"A clearly and well-written manual for persons engaged or interested in the granite industry."—*Scotsman*.

TRAVERSE TABLES.

For use in Mine Surveying. By W. LINTERN, Mining Engineer. Crown 8vo, cloth. [Just Published. Net 3/0

ELECTRICITY, ELECTRICAL ENGINEERING, &c.

SUBMARINE TELEGRAPHS.

Their History, Construction, and Working. Founded in part on WÜNSCHENDORFF'S "Traité de Télégraphie Sous-Marine," and Compiled from Authoritative and Exclusive Sources. By CHARLES BRIGHT, F.R.S.E. Royal 8vo, 78o pp., fully Illustrated, including Maps and Folding Plates. *Net* £3 3s.

"There are few, if any, persons more fitted to write a treatise on submarine telegraphy than Mr. Charles Bright. The author has done his work admirably, and has written in a way which will appeal as much to the layman as to the engineer. This admirable volume must, for many years to come, hold the position of the English classic on submarine telegraphy."—*Engineer*.

"Mr. Bright's interestingly written and admirably illustrated book will meet with a welcome reception from cable men."—*Electrician*.

"The author deals with his subject from all points of view—political and strategical as well as scientific. The work will be of interest, not only to men of science, but to the general public. We can strongly recommend it."—*Athenæum*.

DYNAMO ELECTRIC MACHINERY: its CONSTRUCTION, DESIGN, and OPERATION.

By SAMUEL SHELDON, A.M., Ph.D., Professor of Physics and Electrical Engineering at the Polytechnic Institute of Brooklyn, assisted by HOBART MASON, B.S.

In two volumes, sold separately, as follows:—

Vol. I.—DIRECT CURRENT MACHINES. Third Edition, Revised. Large crown 8vo. 28o pages, with 200 Illustrations.

[Just Published. Net 12/0

Vol. II.—ALTERNATING CURRENT MACHINES. Large crown 8vo. 26o pages, with 184 Illustrations.

[Just Published. Net 12/0

Designed as Text-books for use in Technical Educational Institutions, and by Engineers whose work includes the handling of Direct and Alternating Current Machines respectively, and for Students proficient in mathematics.

THE ELECTRICAL ENGINEER'S POCKET-BOOK.

Consisting of Modern Rules, Formulæ, Tables, and Data. By H. R. KEMPE, M.Inst.E.E., A.M.Inst.C.E., Technical Officer Postal Telegraphs, Author of "A Handbook of Electrical Testing," &c. Second Edition, Revised, with Additions. With numerous Illustrations. Royal 32mo, oblong, leather 5/0

"It is the best book of its kind."—*Electrical Engineer*.

"The Electrical Engineer's Pocket-Book is a good one."—*Electrician*.

"Strongly recommended to those engaged in the electrical industries."—*Electrical Review*.

ELECTRIC LIGHT FITTING.

A Handbook for Working Electrical Engineers, embodying Practical Notes on Installation Management. By J. W. URQUHART. With numerous Illustrations. Third Edition, Revised. Crown 8vo, cloth 5/0

"This volume deals with what may be termed the mechanics of electric lighting, and is addressed to men who are already engaged in the work, or are training for it. The work traverses a great deal of ground, and may be read as a sequel to the same author's useful work on 'Electric Light.'"—*Electrician*.

ELECTRIC LIGHT.

Its Production and Use, Embodying Plain Directions for the Treatment of Dynamo-Electric Machines, Batteries, Accumulators, and Electric Lamps. By J. W. URQUHART, C.E. Sixth Edition, Revised, with Additions and 145 Illustrations. Crown 8vo, cloth. *[Just Published. 7/6*

"The whole ground of electric lighting is more or less covered and explained in a very clear and concise manner."—*Electrical Review*.

"A *vade-mecum* of the salient facts connected with the science of electric lighting."—*Electrician*.

DYNAMO CONSTRUCTION.

A Practical Handbook for the Use of Engineer-Constructors and Electricians-in-Charge. Embracing Framework Building, Field Magnet and Armature Winding and Grouping, Compounding, &c. By J. W. URQUHART. Second Edition, Enlarged. Crown 8vo, cloth 7/6

"Mr. Urquhart's book is the first one which deals with these matters in such a way that the engineering student can understand them. The book is very readable, and the author leads his readers up to difficult subjects by reasonably simple tests."—*Engineering Review*.

ELECTRICAL AND MAGNETIC CALCULATIONS.

For the Use of Electrical Engineers and Artisans, Teachers, Students, and all others interested in the Theory and Application of Electricity and Magnetism. By A. A. ATKINSON, Professor of Electricity in Ohio University. Crown 8vo, cloth. [Just Published. Net 9/0

THE ELEMENTS OF ELECTRICAL ENGINEERING.

A First Year's Course for Students and Workmen. By TYSON SEWELL, A.I.E.E., Assistant Lecturer and Demonstrator in Electrical Engineering at the Polytechnic, Regent Street, London. With upwards of 200 Illustrations. Demy 8vo, cloth. [Just Published. Net 7/6

THE MANAGEMENT OF DYNAMOS.

A Handy Book of Theory and Practice for the Use of Mechanics, Engineers, Students, and others in Charge of Dynamos. By G. W. LUMMIS-PATERSON. Second Edition, thoroughly Revised and Enlarged. Crown 8vo, cloth. 4/6
 "An example which deserves to be taken as a model by other authors. The subject is treated in a manner which any intelligent man who is fit to be entrusted with charge of an engine should be able to understand. It is a useful book to all who make, tend, or employ electric machinery."
 —*Architect.*

THE STANDARD ELECTRICAL DICTIONARY.

A Popular Encyclopædia of Words and Terms Used in the Practice of Electrical Engineering. By T. O'CONNOR SLOANE, A.M., Ph.D. Third Edition, with Appendix. Crown 8vo, 680 pp., 390 Illustrations, cloth . . . Net 7/6
 "The work has many attractive features in it, and is, beyond doubt, a well put together and useful publication. The amount of ground covered may be gathered from the fact that in the index about 5,600 references will be found."—*Electrical Review.*

ELECTRIC SHIP-LIGHTING.

A Handbook on the Practical Fitting and Running of Ships' Electrical Plant. For the Use of Shipowners and Builders, Marine Electricians, and Seagoing Engineers-in-Charge. By J. W. URQUHART, C.E. Second Edition, Revised and Extended. 326 pp., with 88 Illustrations, Crown 8vo, cloth . . . 7/6
 "The subject of ship electric lighting is one of vast importance, and Mr. Urquhart is to be highly complimented for placing such a valuable work at the service of marine electricians."—*The Steamship.*

ELECTRIC LIGHT FOR COUNTRY HOUSES.

A Practical Handbook on the Erection and Running of Small Installations, with Particulars of the Cost of Plant and Working. By J. H. KNIGHT. Third Edition, Revised. Crown 8vo, wrapper. [Just Published. 1/0

ELECTRIC LIGHTING (ELEMENTARY PRINCIPLES OF).

By ALAN A. CAMPBELL SWINTON, M.Inst.C.E., M.Inst.E.E. Fourth Edition, Revised. With 16 Illustrations. Crown 8vo, cloth. [Just Published. 1/6

DYNAMIC ELECTRICITY AND MAGNETISM.

By PHILIP ATKINSON, A.M., Ph.D., Author of "Elements of Static Electricity," &c. Crown 8vo, 417 pp., with 120 Illustrations, cloth . . . 10/6

POWER TRANSMITTED BY ELECTRICITY

And applied by the Electric Motor, including Electric Railway Construction. By P. ATKINSON, A.M., Ph.D. Third Edition, Fully Revised, and New Matter added. With 94 Illustrations. Crown 8vo, cloth . . . Net 9/0

HOW TO MAKE A DYNAMO.

A Practical Treatise for Amateurs. Containing numerous Illustrations and Detailed Instructions for Constructing a Small Dynamo to Produce the Electric Light. By ALFRED CROFTS. Sixth Edition, Revised and Enlarged. Crown 8vo, cloth. [Just Published. 2/0

THE STUDENT'S TEXT-BOOK OF ELECTRICITY.

By H. M. NOAD, F.R.S. Cheaper Edition. 650 pp., with 470 Illustrations. Crown 8vo, cloth 9/0

ARCHITECTURE, BUILDING, &c.

PRACTICAL BUILDING CONSTRUCTION.

A Handbook for Students Preparing for Examinations, and a Book of Reference for Persons Engaged in Building. By JOHN PARNELL ALLEN, Surveyor, Lecturer on Building Construction at the Durham College of Science, Newcastle-on-Tyne. Third Edition, Revised and Enlarged. Medium 8vo, 450 pp., with 1,000 Illustrations, cloth. [Just Published. 7/6

"The most complete exposition of building construction we have seen. It contains all that is necessary to prepare students for the various examinations in building construction."—*Building News*.

"The author depends nearly as much on his diagrams as on his type. The pages suggest the hand of a man of experience in building operations—and the volume must be a blessing to many teachers as well as to students."—*The Architect*.

"The work is sure to prove a formidable rival to great and small competitors alike, and bids fair to take a permanent place as a favourite student's text-book. The large number of illustrations deserve particular mention for the great merit they possess for purposes of reference in exactly corresponding to convenient scales."—*Journal of the Royal Institute of British Architects*.

PRACTICAL MASONRY.

A Guide to the Art of Stone Cutting. Comprising the Construction, Setting Out, and Working of Stairs, Circular Work, Arches, Niches, Domes, Pendentives, Vaults, Tracery Windows, &c., &c. For the Use of Students, Masons, and other Workmen. By WILLIAM R. PURCHASE, Building Inspector to the Borough of Hove. Third Edition, with Glossary of Terms. Royal 8vo, 142 pp., with 52 Lithographic Plates, comprising nearly 400 separate Diagrams, cloth. [Just Published. 7/6

"Mr. Purchase's 'Practical Masonry' will undoubtedly be found useful to all interested in this important subject, whether theoretically or practically. Most of the examples given are from actual work carried out, the diagrams being carefully drawn. The book is a practical treatise on the subject, the author himself having commenced as an operative mason, and afterwards acted as foreman mason on many large and important buildings prior to the attainment of his present position. It should be found of general utility to architectural students and others, as well as to those to whom it is specially addressed."—*Journal of the Royal Institute of British Architects*.

MODERN PLUMBING, STEAM AND HOT WATER HEATING.

A New Practical Work for the Plumber, the Heating Engineer, the Architect, and the Builder. By J. J. LAWLER, Author of "American Sanitary Plumbing," &c. With 284 Illustrations and Folding Plates. 4to, cloth.

[Just Published. Net 21/-

HEATING BY HOT WATER.

With Information and Suggestions on the best Methods of Heating Public, Private and Horticultural Buildings. By WALTER JONES. Second Edition. With 96 Illustrations, crown 8vo, cloth Net 2/6

"We confidently recommend all interested in heating by hot water to secure a copy of this valuable little treatise."—*The Plumber and Decorator*.

CONCRETE: ITS NATURE AND USES.

A Book for Architects, Builders, Contractors, and Clerks of Works. By GEORGE L. SUTCLIFFE, A.R.I.B.A. 350 pp., with numerous Illustrations. Crown 8vo, cloth 7/6

"The author treats a difficult subject in a lucid manner. The manual fills a long-felt gap. It is careful and exhaustive; equally useful as a student's guide and an architect's book of reference."—*Journal of the Royal Institute of British Architects*.

"There is room for this new book, which will probably be for some time the standard work on the subject for a builder's purpose."—*Glasgow Herald*.

LOCKWOOD'S BUILDER'S PRICE BOOK for 1902.

A Comprehensive Handbook of the Latest Prices and Data for Builders, Architects, Engineers, and Contractors. Re-constructed, Re-written, and Greatly Enlarged. By FRANCIS T. W. MILLER. 800 closely-printed pages, crown 8vo, cloth 4/0

"This book is a very useful one, and should find a place in every English office connected with the building and engineering professions."—*Industries*

"An excellent book of reference."—*Architect*.

"In its new and revised form this Price Book is what a work of this kind should be—comprehensive, reliable, well arranged, legible, and well bound."—*British Architect*.

THE DECORATIVE PART OF CIVIL ARCHITECTURE.

By Sir WILLIAM CHAMBERS, F.R.S. With Portrait, Illustrations, Notes, and an EXAMINATION OF GRECIAN ARCHITECTURE, by JOSEPH GWILT, F.S.A. Revised and Edited by W. H. LEEDS. 66 Plates, 4to, cloth . . . **21/0**

THE MECHANICS OF ARCHITECTURE.

A Treatise on Applied Mechanics, especially Adapted to the Use of Architects. By E. W. TARN, M.A., Author of "The Science of Building," &c. Second Edition, Enlarged. Illustrated with 125 Diagrams. Crown 8vo, cloth **7/6**

"The book is a very useful and helpful manual of architectural mechanics."—*Builder*.

A HANDY BOOK OF VILLA ARCHITECTURE.

Being a Series of Designs for Villa Residences in various Styles. With Outline Specifications and Estimates. By C. WICKES, Architect. 61 Plates, 4to, half-morocco, gilt edges . . . **£1 11s. 6d.**

"The whole of the designs bear evidence of their being the work of an artistic architect, and they will prove very valuable and suggestive."—*Building News*.

THE ARCHITECT'S GUIDE.

Being a Text-book of Useful Information for Architects, Engineers, Surveyors, Contractors, Clerks of Works, &c., &c. By FREDERICK ROGERS, Architect. Third Edition. Crown 8vo, cloth . . . **3/6**

ARCHITECTURAL PERSPECTIVE.

The whole Course and Operations of the Draughtsman in Drawing a Large House in Linear Perspective. Illustrated by 43 Folding Plates. By F. O. FERGUSON. Second Edition, Enlarged. 8vo, boards . . . **3/6**

"It is the most intelligible of the treatises on this ill-treated subject that I have met with. — E. INGRESS BELL, ESQ., in the *R.I.B.A. Journal*.

PRACTICAL RULES ON DRAWING.

For the Operative Builder and Young Student in Architecture. By GEORGE PYNE. 14 Plates, 4to, boards . . . **7/6**

MEASURING AND VALUING ARTIFICER'S WORK

(The Student's Guide to the Practice of). Containing Directions for taking Dimensions, Abstracting the same, and bringing the Quantities into Bill, with Tables of Constants for Valuation of Labour, and for the Calculation of Areas and Solidities. Originally edited by E. DOBSON, Architect. With Additions by E. W. TARN, M.A. Seventh Edition, Revised. With 8 Plates and 63 Woodcuts. Crown 8vo, cloth. [Just Published. **7/6**

"This edition will be found the most complete treatise on the principles of measuring and valuing artificer's work that has yet been published."—*Building News*.

TECHNICAL GUIDE, MEASURER, AND ESTIMATOR.

For Builders and Surveyors. Containing Technical Directions for Measuring Work in all the Building Trades, Complete Specifications for Houses, Roads, and Drains, and an Easy Method of Estimating the parts of a Building collectively. By A. C. BEATON. Ninth Edition. Waistcoat-pocket size, gilt edges . . . **1/6**

"No builder, architect, surveyor, or valuer should be without his 'Beaton.'"—*Building News*.

SPECIFICATIONS FOR PRACTICAL ARCHITECTURE.

A Guide to the Architect, Engineer, Surveyor, and Builder. With an Essay on the Structure and Science of Modern Buildings. Upon the Basis of the Work by ALFRED BARTHOLOMEW, thoroughly Revised, Corrected, and greatly added to by FREDERICK ROGERS, Architect. Third Edition, Revised. 8vo, cloth . . . **15/0**

"The work is too well known to need any recommendation from us. It is one of the books with which every young architect must be equipped."—*Architect*.

THE HOUSE-OWNER'S ESTIMATOR.

Or, What will it Cost to Build, Alter, or Repair? A Price Book for Un-professional People as well as the Architectural Surveyor and Builder. By J. D. SIMON. Edited by F. T. W. MILLER, A.R.I.B.A. Fifth Edition Carefully Revised. Crown 8vo, cloth. [Just Published. **Net 3/6**

"In two years it will repay its cost a hundred times over."—*Field*.

SANITATION AND WATER SUPPLY.**THE BACTERIAL PURIFICATION OF SEWAGE:**

Being a Practical Account of the Various Modern Biological Methods of Purifying Sewage. By SIDNEY BARWISE, M.D. (Lond.), D.P.H. (Camb.), etc. With 10 Page Plates and 2 Folding Diagrams. Royal 8vo, cloth.

[Just Published. Net 6/0

THE PURIFICATION OF SEWAGE.

Being a Brief Account of the Scientific Principles of Sewage Purification, and their Practical Application. By SIDNEY BARWISE, M.D. (Lond.), M.R.C.S., D.P.H. (Camb.), Fellow of the Sanitary Institute, Medical Officer of Health to the Derbyshire County Council. Crown 8vo, cloth. [Just Published. 5/0

WATER AND ITS PURIFICATION.

A Handbook for the Use of Local Authorities, Sanitary Officers, and others interested in Water Supply. By S. RIDEAL, D.Sc. Lond., F.I.C. Second Edition, Revised, with Additions, including numerous Illustrations and Tables. Large Crown 8vo, cloth.

[Just Published. Net 9/0

RURAL WATER SUPPLY.

A Practical Handbook on the Supply of Water and Construction of Water-works for Small Country Districts. By ALLAN GREENWELL, A.M.I.C.E., and W. T. CURRY, A.M.I.C.E. Revised Edition. Crown 8vo, cloth 5/0

THE WATER SUPPLY OF CITIES AND TOWNS.

By WILLIAM HUMBER, A.M. Inst. C.E., and M.Inst. M.E. Imp. 4to, half-bound morocco. (See page 11.) Net £6 6s.

THE WATER SUPPLY OF TOWNS AND THE CONSTRUCTION OF WATER-WORKS.

By PROFESSOR W. K. BURTON, A.M. Inst. C.E. Second Edition, Revised and Extended. Royal 8vo, cloth. (See page 10.) 25/0

WATER ENGINEERING.

A Practical Treatise on the Measurement, Storage, Conveyance, and Utilisation of Water for the Supply of Towns. By C. SLAGG, A.M. Inst. C.E. 7/6

SANITARY WORK IN SMALL TOWNS AND VILLAGES.

By CHARLES SLAGG, A. M. Inst. C.E. Crown 8vo, cloth 3/0

SANITARY ARRANGEMENT OF DWELLING-HOUSES.

By A. J. WALLIS-TAYLER, A.M.Inst.C.E. Crown 8vo, cloth 2/6

MODERN PLUMBING, HOT WATER HEATING, &c.

A New Practical Work for the Plumber, the Heating Engineer, the Architect, and the Builder. By J. J. LAWLER, Author of "American Sanitary Plumbing," &c. With 284 Illustrations and Folding Plates. 4to, cloth.

[Just Published (see page 25). Net 21/-

PLUMBING.

A Text-book to the Practice of the Art or Craft of the Plumber. By W. P. BUCHAN, R.P. Ninth Edition, Enlarged. Crown 8vo, cloth 3/6

VENTILATION.

A Text-book to the Practice of the Art of Ventilating Buildings. By W. P. BUCHAN, R.P. Crown 8vo, cloth 3/6

THE HEALTH OFFICER'S POCKET-BOOK.

A Guide to Sanitary Practice and Law. For Medical Officers of Health, Sanitary Inspectors, Members of Sanitary Authorities, &c. By EDWARD F. WILLOUGHBY, M.D. (Lond.), &c. Second Edition, Revised and Enlarged Fcap. 8vo, leather.

[Just Published. Net 10/6

CARPENTRY, TIMBER, &c.

THE ELEMENTARY PRINCIPLES OF CARPENTRY.

A Treatise on the Pressure and Equilibrium of Timber Framing, the Resistance of Timber, and the Construction of Floors, Arches, Bridges, Roofs, Uniting Iron and Stone with Timber, &c. To which is added an Essay on the Nature and Properties of Timber, &c., with Descriptions of the kinds of Wood used in Building; also numerous Tables of the Scantlings of Timber for different purposes, the Specific Gravities of Materials, &c. By THOMAS TREGOLD, C.E. With an Appendix of Specimens of Various Roofs of Iron and Stone, Illustrated. Seventh Edition, thoroughly Revised and considerably Enlarged by E. WYNDHAM TARN, M.A., Author of "The Science of Building," &c. With 61 Plates, Portrait of the Author, and several Woodcuts. In One large Vol., 4to, cloth **25/0**

"Ought to be in every architect's and every builder's library."—*Builder*.

"A work whose monumental excellence must commend it wherever skillful carpentry is concerned. The author's principles are rather confirmed than impaired by time. The additional plates are of great intrinsic value."—*Building News*.

WOODWORKING MACHINERY.

Its Rise, Progress, and Construction. With Hints on the Management of Saw Mills and the Economical Conversion of Timber. Illustrated with Examples of Recent Designs by leading English, French, and American Engineers. By M. POWIS BALE, A.M.Inst.C.E., M.I.M.E. Second Edition, Revised, with large Additions, large crown 8vo, 440 pp., cloth **9/0**

"Mr. Bale is evidently an expert on the subject, and he has collected so much information that his book is all-sufficient for builders and others engaged in the conversion of timber."—*Architect*.

"The most comprehensive compendium of wood-working machinery we have seen. The author is a thorough master of his subject."—*Building News*.

SAW MILLS.

Their Arrangement and Management, and the Economical Conversion of Timber. By M. POWIS BALE, A.M.Inst.C.E. Second Edition, Revised. Crown 8vo, cloth. [Just Published. **10/6**

"The administration of a large sawing establishment is discussed, and the subject examined from a financial standpoint. Hence the size, shape, order, and disposition of saw mills and the like are gone into in detail, and the course of the timber is traced from its reception to its delivery in its converted state. We could not desire a more complete or practical treatise."—*Builder*.

THE CARPENTER'S GUIDE.

Or, Book of Lines for Carpenters; comprising all the Elementary Principles essential for acquiring a knowledge of Carpentry. Founded on the late PETER NICHOLSON'S standard work. A New Edition, Revised by ARTHUR ASHPITEL, F.S.A. Together with Practical Rules on Drawing, by GEORGE PYNE. With 74 Plates, 4to, cloth **£1 1s.**

A PRACTICAL TREATISE ON HANDRAILING.

Showing New and Simple Methods for Finding the Pitch of the Plank, Drawing the Moulds, Beveling, Jointing-up, and Squaring the Wreath. By GEORGE COLLINGS. Second Edition, Revised and Enlarged, to which is added A TREATISE ON STAIR-BUILDING. With Plates and Diagrams **2/6**

"Will be found of practical utility in the execution of this difficult branch of joinery."—*Builder*.
 "Almost every difficult phase of this somewhat intricate branch of joinery is elucidated by the aid of plates and explanatory letterpress."—*Furniture Gazette*.

CIRCULAR WORK IN CARPENTRY AND JOINERY.

A Practical Treatise on Circular Work of Single and Double Curvature. By GEORGE COLLINGS. With Diagrams. Third Edition, 12mo, cloth **2/6**

"An excellent example of what a book of this kind should be. Cheap in price, clear in definition, and practical in the examples selected."—*Builder*.

THE CABINET-MAKER'S GUIDE TO THE ENTIRE CONSTRUCTION OF CABINET WORK.

By RICHARD BITMEAD. Illustrated with Plans, Sections and Working Drawings. Crown 8vo, cloth. [Just Published. **2/6**

HANDRAILING COMPLETE IN EIGHT LESSONS.

On the Square-Cut System. By J. S. GOLDTHORP, Head of Building Department, Halifax Technical School. With Eight Plates and over 150 Practical Exercises. 4to, cloth **3/6**

"Likely to be of considerable value to joiners and others who take a pride in good work. The arrangement of the book is excellent. We heartily commend it to teachers and students."—*Timber Trades Journal*.

TIMBER MERCHANT'S and BUILDER'S COMPANION.

Containing New and Copious Tables of the Reduced Weight and Measurement of Deals and Battens, of all sizes, from One to a Thousand Pieces, and the relative Price that each size bears per Lineal Foot to any given Price per Petersburg Standard Hundred; the Price per Cube Foot of Square Timber to any given Price per Load of 50 Feet, &c., &c. By WILLIAM DOWSING. Fourth Edition, Revised and Corrected. Crown 8vo, cloth **3/0**

"We are glad to see a fourth edition of these admirable tables, which for correctness and simplicity of arrangement leave nothing to be desired."—*Timber Trades Journal*.

THE PRACTICAL TIMBER MERCHANT.

A Guide for the Use of Building Contractors, Surveyors, Builders, &c., comprising useful Tables for all purposes connected with the Timber Trade, Marks of Wood, Essay on the Strength of Timber, Remarks on the Growth of Timber, &c. By W. RICHARDSON. Second Edition. Fcap. 8vo, cloth . . . **3/6**

"Contains much valuable information for timber merchants, builders, foresters, and all others connected with the growth, sale, and manufacture of timber."—*Journal of Forestry*.

PACKING-CASE TABLES.

Showing the number of Superficial Feet in Boxes or Packing-Cases, from six inches square and upwards. By W. RICHARDSON, Timber Broker. Third Edition. Oblong 4to, cloth **3/6**

"Invaluable labour-saving tables."—*Ironmonger*.

GUIDE TO SUPERFICIAL MEASUREMENT.

Tables calculated from 1 to 200 inches in length by 1 to 108 inches in breadth. For the use of Architects, Surveyors, Engineers, Timber Merchants, Builders, &c. By JAMES HAWKINGS. Fifth Edition. Fcap., cloth. **3/6**

"A useful collection of tables to facilitate rapid calculation of surfaces. The exact area of any surface of which the limits have been ascertained can be instantly determined. The book will be found of the greatest utility to all engaged in building operations."—*Scotsman*.

PRACTICAL FORESTRY.

And its Bearing on the Improvement of Estates. By CHARLES E. CURTIS, F.S.I., Professor of Forestry, Field Engineering, and General Estate Management, at the College of Agriculture, Downton. Second Edition, Revised. Crown 8vo, cloth. [Just Published. **3/6**

SUMMARY OF CONTENTS:—PREFATORY REMARKS.—OBJECTS OF PLANTING.—CHOICE OF A FORESTER.—CHOICE OF SOIL AND SITE.—LAYING OUT OF LAND FOR PLANTATIONS.—PREPARATION OF THE GROUND FOR PLANTING.—DRAINAGE.—PLANTING.—DISTANCES AND DISTRIBUTION OF TREES IN PLANTATIONS.—TREES AND GROUND GAME.—ATTENTION AFTER PLANTING.—THINNING OF PLANTATIONS.—PRUNING OF FOREST TREES.—REALIZATION.—METHODS OF SALE.—MEASUREMENT OF TIMBER.—MEASUREMENT AND VALUATION OF LARCH PLANTATION.—FIRE LINES.—COST OF PLANTING.

"Mr. Curtis has in the course of a series of short pithy chapters afforded much information of a useful and practical character on the planting and subsequent treatment of trees."—*Illustrated Carpenter and Builder*.

THE ELEMENTS OF FORESTRY.

Designed to afford Information concerning the Planting and Care of Forest Trees for Ornament or Profit, with suggestions upon the Creation and Care of Woodlands. By F. B. HOUGH. Large crown 8vo, cloth **10/0**

THE TIMBER IMPORTER'S, TIMBER MERCHANT'S, AND BUILDER'S STANDARD GUIDE.

By RICHARD E. GRANDY. Comprising:—An Analysis of Deal Standards, Home and Foreign, with Comparative Values and Tabular Arrangements for fixing Net Landed Cost on Baltic and North American Deals, including all intermediate Expenses, Freight, Insurance, &c.; together with copious Information for the Retailer and Builder. Third Edition. 12mo, cloth **2/0**

DECORATIVE ARTS, &c.

SCHOOL OF PAINTING FOR THE IMITATION OF WOODS AND MARBLES.

As Taught and Practised by A. R. VAN DER BURG and P. VAN DER BURG, Directors of the Rotterdam Painting Institution. Royal folio, 18 $\frac{1}{2}$ by 12 $\frac{1}{2}$ in., Illustrated with 24 full-size Coloured Plates; also 12 plain Plates, comprising 154 Figures. Third Edition, cloth. [Just Published. £1 11s. 6d.]

LIST OF PLATES:—1. VARIOUS TOOLS REQUIRED FOR WOOD PAINTING.—2, 3. WALNUT; PRELIMINARY STAGES OF GRAINING AND FINISHED SPECIMEN.—4. TOOLS USED FOR MARBLE PAINTING AND METHOD OF MANIPULATION.—5, 6. ST. REMI MARBLE; EARLIER OPERATIONS AND FINISHED SPECIMEN.—7. METHODS OF SKETCHING DIFFERENT GRAINS, KNOTS, &c.—8, 9. ASH; PRELIMINARY STAGES AND FINISHED SPECIMEN.—10. METHODS OF SKETCHING MARBLE GRAINS.—11, 12. BRECHE MARBLE; PRELIMINARY STAGES OF WORKING AND FINISHED SPECIMEN.—13. MAPLE; METHODS OF PRODUCING THE DIFFERENT GRAINS.—14, 15. BIRD'S-EYE MAPLE; PRELIMINARY STAGES AND FINISHED SPECIMEN.—16. METHODS OF SKETCHING THE DIFFERENT SPECIES OF WHITE MARBLE.—17, 18. WHITE MARBLE; PRELIMINARY STAGES OF PROCESS AND FINISHED SPECIMEN.—19. MAHOGANY; SPECIMENS OF VARIOUS GRAINS AND METHODS OF MANIPULATION.—20, 21. MAHOGANY; EARLIER STAGES AND FINISHED SPECIMEN.—22, 23, 24. SIENNA MARBLE; VARIETIES OF GRAIN, PRELIMINARY STAGES AND FINISHED SPECIMEN.—25, 26, 27. JUNIPER WOOD; METHODS OF PRODUCING GRAIN, &c.; PRELIMINARY STAGES AND FINISHED SPECIMEN.—28, 29, 30. VERT DE MER MARBLE; VARIETIES OF GRAIN AND METHODS OF WORKING, UNFINISHED AND FINISHED SPECIMENS.—31, 32, 33. OAK; VARIETIES OF GRAIN, TOOLS EMPLOYED AND METHODS OF MANIPULATION, PRELIMINARY STAGES AND FINISHED SPECIMEN.—34, 35, 36. WAULSORT MARBLE; VARIETIES OF GRAIN, UNFINISHED AND FINISHED SPECIMENS.

"Those who desire to attain skill in the art of painting woods and marbles will find advantage in consulting this book. . . . Some of the Working Men's Clubs should give their young men the opportunity to study it."—*Builder*.

"A comprehensive guide to the art. The explanations of the processes, the manipulation and management of the colours, and the beautifully executed plates will not be the least valuable to the student who aims at making his work a faithful transcript of nature."—*Building News*.

"Students and novices are fortunate who are able to become the possessors of so noble a work."—*The Architect*.

ELEMENTARY DECORATION.

A Guide to the Simpler Forms of Everyday Art. Together with PRACTICAL HOUSE DECORATION. By JAMES W. FACEY. With numerous Illustrations. In One Vol., strongly half-bound 5/0

HOUSE PAINTING, GRAINING, MARBLING, AND SIGN WRITING.

A Practical Manual of. By ELLIS A. DAVIDSON. Eighth Edition. With Coloured Plates and Wood Engravings. 12mo, cloth boards 6/0

"A mass of information of use to the amateur and of value to the practical man."—*English Mechanic*.

THE DECORATOR'S ASSISTANT.

A Modern Guide for Decorative Artists and Amateurs, Painters, Writers, Gilders, &c. Containing upwards of 600 Receipts, Rules, and Instructions; with a variety of Information for General Work connected with every Class of Interior and Exterior Decorations, &c. Seventh Edition. 152 pp., cr. 8vo. 1/0

"Full of receipts of value to decorators, painters, gilders, &c. The book contains the gist of larger treatises on colour and technical processes. It would be difficult to meet with a work so full of varied information on the painter's art."—*Building News*.

MARBLE DECORATION

And the Terminology of British and Foreign Marbles. A Handbook for Students. By GEORGE H. BLAGROVE, Author of "Shoring and its Application," &c. With 28 Illustrations. Crown 8vo, cloth 3/6

"This most useful and much wanted handbook should be in the hands of every architect and builder."—*Building World*.

"A carefully and usefully written treatise; the work is essentially practical."—*Scotsman*.

DELAMOTTE'S WORKS ON ALPHABETS AND ILLUMINATION.

ORNAMENTAL ALPHABETS, ANCIENT & MEDIÆVAL.

From the Eighth Century, with Numerals; including Gothic, Church-Text, large and small, German, Italian, Arabesque, Initials for Illumination, Monograms, Crosses, &c., &c., for the use of Architectural and Engineering Draughtsmen, Missal Painters, Masons, Decorative Painters, Lithographers, Engravers, Carvers, &c., &c. Collected and Engraved by F. DELAMOTTE, and printed in Colours. New and Cheaper Edition. Royal 8vo, oblong, ornamental boards 2/6

"For those who insert enamelled sentences round gilded chalices, who blazon shop legends over shop-doors, who letter church walls with pithy sentences from the Decalogue, this book will be useful."—*Athenæum*.

MODERN ALPHABETS, PLAIN AND ORNAMENTAL.

Including German, Old English, Saxon, Italic, Perspective, Greek, Hebrew, Court Hand, Engrossing, Tuscan, Riband, Gothic, Rustic, and Arabesque; with several Original Designs, and an Analysis of the Roman and Old English Alphabets, large and small, and Numerals, for the use of Draughtsmen, Surveyors, Masons, Decorative Painters, Lithographers, Engravers, Carvers, &c. Collected and Engraved by F. DELAMOTTE, and printed in Colours. New and Cheaper Edition. Royal 8vo, oblong, ornamental boards 2/6

"There is comprised in it every possible shape into which the letters of the alphabet and numerals can be formed, and the talent which has been expended in the conception of the various plain and ornamental letters is wonderful."—*Standard*.

MEDIÆVAL ALPHABETS AND INITIALS FOR ILLUMINATORS.

By F. G. DELAMOTTE. Containing 21 Plates and Illuminated Title, printed in Gold and Colours. With an Introduction by J. WILLIS BROOKS. Fourth and Cheaper Edition. Small 4to, ornamental boards 4/0

"A volume in which the letters of the alphabet come forth glorified in gilding and all the colours of the prism interwoven and intertwined and intermingled."—*Sun*.

A PRIMER OF THE ART OF ILLUMINATION.

For the Use of Beginners; with a Rudimentary Treatise on the Art, Practical Directions for its Exercise, and Examples taken from Illuminated MSS., printed in Gold and Colours. By F. DELAMOTTE. New and Cheaper Edition. Small 4to, ornamental boards 6/0

"The examples of ancient MSS. recommended to the student, which, with much good sense, the author chooses from collections accessible to all, are selected with judgment and knowledge as well as taste."—*Athenæum*.

THE EMBROIDERER'S BOOK OF DESIGN.

Containing Initials, Emblems, Cyphers, Monograms, Ornamental Borders, Ecclesiastical Devices, Mediæval and Modern Alphabets, and National Emblems. Collected by F. DELAMOTTE, and printed in Colours. Oblong royal 8vo, ornamental wrapper 1/6

"The book will be of great assistance to ladies and young children who are endowed with the art of plying the needle in this most ornamental and useful pretty work."—*East Anglian Times*.

INSTRUCTIONS IN WOOD-CARVING FOR AMATEURS.

With Hints on Design. By A LADY. With 10 Plates. New and Cheaper Edition. Crown 8vo, in emblematic wrapper 2/0

"The handicraft of the wood-carver, so well as a book can impart it, may be learnt from 'A Lady's' publication."—*Athenæum*.

PAINTING POPULARLY EXPLAINED.

By THOMAS JOHN GULLICK, Painter, and JOHN TIMBS, F.S.A. Including Fresco, Oil, Mosaic, Water-Colour, Water-Glass, Tempera, Encaustic, Miniature, Painting on Ivory, Vellum, Pottery, Enamel, Glass, &c. Fifth Edition. Crown 8vo, cloth 5/0

. Adopted as a Prize Book at South Kensington.

"Much may be learned, even by those who fancy they do not require to be taught, from the careful perusal of this unpretending but comprehensive treatise."—*Art Journal*.

NATURAL SCIENCE, &c.

THE VISIBLE UNIVERSE.

Chapters on the Origin and Construction of the Heavens. By J. E. GORE, F.R.A.S., Author of "Star Groups," &c. Illustrated by 6 Stellar Photographs and 12 Plates. Demy 8vo, cloth 16/0

"A valuable and lucid summary of recent astronomical theory, rendered more valuable and attractive by a series of stellar photographs and other illustrations."—*The Times*.

"In presenting a clear and concise account of the present state of our knowledge Mr. Gore has made a valuable addition to the literature of the subject."—*Nature*.

"Mr. Gore's 'Visible Universe' is one of the finest works on astronomical science that have recently appeared in our language. In spirit and in method it is scientific from cover to cover, but the style is so clear and attractive that it will be as acceptable and as readable to those who make no scientific pretensions as to those who devote themselves specially to matters astronomical."—*Leeds Mercury*.

STAR GROUPS.

A Student's Guide to the Constellations. By J. ELLARD GORE, F.R.A.S., M.R.I.A., &c., Author of "The Visible Universe," "The Scenery of the Heavens," &c. With 30 Maps. Small 4to, cloth 5/0

"The volume contains thirty maps showing stars of the sixth magnitude—the usual naked-eye limit—and each is accompanied by a brief commentary adapted to facilitate recognition and bring to notice objects of special interest. For the purpose of a preliminary survey of the 'midnight pomp' of the heavens nothing could be better than a set of delineations averaging scarcely twenty square inches in area and including nothing that cannot at once be identified."—*Saturday Review*.

AN ASTRONOMICAL GLOSSARY.

Or, Dictionary of Terms used in Astronomy. With Tables of Data and Lists of Remarkable and Interesting Celestial Objects. By J. ELLARD GORE, F.R.A.S., Author of "The Visible Universe," &c. Small crown 8vo, cloth.

2/6

"A very useful little work for beginners in astronomy, and not to be despised by more advanced students."—*The Times*.

"A very handy book . . . the utility of which is much increased by its valuable tables of astronomical data."—*Athenaeum*.

THE MICROSCOPE.

Its Construction and Management. Including Technique, Photo-micrography, and the Past and Future of the Microscope. By Dr. HENRI VAN HEURCK. Re-Edited and Augmented from the Fourth French Edition, and Translated by WYNNE E. BAXTER, F.G.S. 400 pp., with upwards of 250 Woodcuts, imp. 8vo, cloth 18/0

"A translation of a well-known work, at once popular and comprehensive."—*Times*.

"The translation is as felicitous as it is accurate."—*Nature*.

ASTRONOMY.

By the late Rev. ROBERT MAIN, M.A., F.R.S. Third Edition, Revised by WILLIAM THYNNE LYNN, B.A., F.R.A.S., formerly of the Royal Observatory, Greenwich. 12mo, cloth 2/0

"A sound and simple treatise, very carefully edited, and a capital book for beginners."—*Knowledge*.

"Accurately brought down to the requirements of the present time by Mr. Lynn."—*Educational Times*.

A MANUAL OF THE MOLLUSCA.

A Treatise on Recent and Fossil Shells. By S. P. WOODWARD, A.L.S., F.G.S. With an Appendix on RECENT AND FOSSIL CONCHOLOGICAL DISCOVERIES, by RALPH TATE, A.L.S., F.G.S. With 23 Plates and upwards of 300 Woodcuts. Reprint of Fourth Edition (1880). Crown 8vo, cloth 7/6

"A most valuable storehouse of conchological and geological information."—*Science Gossip*.

THE TWIN RECORDS OF CREATION.

Or, Geology and Genesis, their Perfect Harmony and Wonderful Concord. By G. W. V. LE VAUX. 8vo, cloth 5/0

"A valuable contribution to the evidences of Revelation, and disposes very conclusively of the arguments of those who would set God's Works against God's Word. No real difficulty is shirked, and no sophistry is left unexposed."—*The Rock*.

HANDBOOK OF MECHANICS.

By Dr. LARDNER. Enlarged and re-written by BENJAMIN LOEWY, F.R.A.S.
378 Illustrations. Post 8vo, cloth **6/0**

"The perspicuity of the original has been retained, and chapters which had become obsolete have been replaced by others of more modern character. The explanations throughout are studiously popular, and care has been taken to show the application of the various branches of physics to the industrial arts, and to the practical business of life."—*Mining Journal*.

HANDBOOK OF HYDROSTATICS AND PNEUMATICS.

By Dr. LARDNER. New Edition, Revised and Enlarged by BENJAMIN LOEWY, F.R.A.S. With 236 Illustrations. Post 8vo, cloth **5/0**

"For those 'who desire to attain an accurate knowledge of physical science without the profound methods of mathematical investigation,' this work is well adapted."—*Chemical News*.

HANDBOOK OF HEAT.

By Dr. LARDNER. Edited and re-written by BENJAMIN LOEWY, F.R.A.S., &c.
117 Illustrations. Post 8vo, cloth **6/0**

"The style is always clear and precise, and conveys instruction without leaving any cloudiness or lurking doubts behind."—*Engineering*.

HANDBOOK OF OPTICS.

By Dr. LARDNER. New Edition. Edited by T. OLVER HARDING, B.A. Lond.
With 298 Illustrations. Small 8vo, 448 pp., cloth **5/0**

"Written by one of the ablest English scientific writers, beautifully and elaborately illustrated."—*Mechanics Magazine*.

ELECTRICITY, MAGNETISM, AND ACOUSTICS.

By Dr. LARDNER. Edited by GEO. CAREY FOSTER, B.A., F.C.S. With
400 Illustrations. Small 8vo, cloth **5/0**

"The book could not have been entrusted to any one better calculated to preserve the terse and lucid style of Lardner, while correcting his errors and bringing up his work to the present state of scientific knowledge."—*Popular Science Review*.

HANDBOOK OF ASTRONOMY.

By Dr. LARDNER. Fourth Edition. Revised and Edited by EDWIN DUNKIN, F.R.A.S., Royal Observatory, Greenwich. With 38 Plates and upwards of
100 Woodcuts. 8vo, cloth **9/6**

"Probably no other book contains the same amount of information in so compendious and well arranged a form—certainly none at the price at which this is offered to the public."—*Athenæum*.

"We can do no other than pronounce this work a most valuable manual of astronomy, and we strongly recommend it to all who wish to acquire a general—but at the same time correct—acquaintance with this sublime science."—*Quarterly Journal of Science*.

MUSEUM OF SCIENCE AND ART.

Edited by Dr. LARDNER. With upwards of 1,200 Engravings on Wood. In
Six Double Volumes, **£1 1s.** in a new and elegant cloth binding; or hand-
somerly bound in half-morocco **£1 11s. 6d.**

"A cheap and interesting publication, alike informing and attractive. The papers combine subjects of importance and great scientific knowledge, considerable inductive powers, and a popular style of treatment."—*Spectator*.

Separate books formed from the above.

- | | |
|--|---|
| Common Things Explained. 5s. | Steam and its Uses. 2s. cloth. |
| The Microscope. 2s. cloth. | Popular Astronomy. 4s. 6d. cloth. |
| Popular Geology. 2s. 6d. cloth. | The Bee and White Ants. 2s. cloth. |
| Popular Physics. 2s. 6d. cloth. | The Electric Telegraph. 1s. 6d. |

NATURAL PHILOSOPHY FOR SCHOOLS.

By Dr. LARDNER. Fcap. 8vo **3/6**

"A very convenient class book for junior students in private schools."—*British Quarterly Review*.

ANIMAL PHYSIOLOGY FOR SCHOOLS.

By Dr. LARDNER. Fcap. 8vo **3/6**

"Clearly written, well arranged, and excellently illustrated."—*Gardener's Chronicle*.

THE ELECTRIC TELEGRAPH.

By Dr. LARDNER. Revised by E. B. BRIGHT, F.R.A.S. Fcap. 8vo. . **2/6**

"One of the most readable books extant on the Electric Telegraph."—*English Mechanic*.

CHEMICAL MANUFACTURES, CHEMISTRY, &c.

THE GAS ENGINEER'S POCKET-BOOK.

Comprising Tables, Notes and Memoranda relating to the Manufacture, Distribution and Use of Coal Gas and the Construction of Gas Works. By H. O'CONNOR, A.M.Inst.C.E. Second Edition, Revised. 470 pp., crown 8vo, fully Illustrated, leather. [Just Published. 10/6

"The book contains a vast amount of information. The author goes consecutively through the engineering details and practical methods involved in each of the different processes or parts of a gas-works. He has certainly succeeded in making a compilation of hard matters of fact absolutely interesting to read."—*Gas World*.

"A useful work of reference for the gas engineer and all interested in lighting or heating by gas, while the analyses of the various descriptions of gas will be of value to the technical chemist. All matter in any way connected with the manufacture and use of gas is dealt with. The book has evidently been carefully compiled, and certainly constitutes a useful addition to gas literature."—*Builder*.

"The volume contains a great quantity of specialised information, compiled, we believe, from trustworthy sources, which should make it of considerable value to those for whom it is specifically produced."—*Engineer*.

LIGHTING BY ACETYLENE

Generators, Burners, and Electric Furnaces. By WILLIAM E. GIBBS, M.E. With 66 Illustrations. Crown 8vo, cloth. [Just Published. 7/6

ENGINEERING CHEMISTRY.

A Practical Treatise for the Use of Analytical Chemists, Engineers, Iron Masters, Iron Founders, Students and others. Comprising Methods of Analysis and Valuation of the Principal Materials used in Engineering Work, with Analyses, Examples and Suggestions. By H. J. PHILLIPS, F.I.C., F.C.S. Third Edition, Revised and Enlarged. Crown 8vo, 420 pp., with Plates and other Illustrations, cloth. [Just Published. Net 10/6

"In this work the author has rendered no small service to a numerous body of practical men. . . . The analytical methods may be pronounced most satisfactory, being as accurate as the despatch required of engineering chemists permits."—*Chemical News*.

"Full of good things. As a handbook of technical analysis, it is very welcome."—*Builder*.

"The analytical methods given are, as a whole, such as are likely to give rapid and trustworthy results in experienced hands. . . . There is much excellent descriptive matter in the work, the chapter on 'Oils and Lubrication' being specially noticeable in this respect."—*Engineer*.

NITRO-EXPLOSIVES.

A Practical Treatise concerning the Properties, Manufacture, and Analysis of Nitrated Substances, including the Fulminates, Smokeless Powders, and Celluloid. By P. G. SANFORD, F.I.C., Consulting Chemist to the Cotton Powder Company, &c. With Illustrations. Crown 8vo, cloth. [Just Published. 9/0

"Any one having the requisite apparatus and materials could make nitro-glycerine or gun-cotton, to say nothing of other explosives, by the aid of the instructions in this volume. This is one of the very few text-books in which can be found just what is wanted. Mr. Sanford goes through the whole list of explosives commonly used, names any given explosive, and tells us of what it is composed and how it is manufactured. The book is excellent throughout."—*Engineer*.

A HANDBOOK ON MODERN EXPLOSIVES.

A Practical Treatise on the Manufacture and Use of Dynamite, Gun-Cotton, Nitro-Glycerine and other Explosive Compounds, including Collodion-Cotton. With Chapters on Explosives in Practical Application. By M. EISSLER, Mining Engineer and Metallurgical Chemist. Second Edition, Enlarged. With 150 Illustrations. Crown 8vo, cloth. [Just Published. 12/6

"Useful not only to the miner, but also to officers of both services to whom blasting and the use of explosives generally may at any time become a necessary auxiliary."—*Nature*.

DANGEROUS GOODS.

Their Sources and Properties, Modes of Storage and Transport. With Notes and Comments on Accidents arising therefrom, together with the Government and Railway Classifications, Acts of Parliament, &c. A Guide for the Use of Government and Railway Officials, Steamship Owners, Insurance Companies and Manufacturers, and Users of Explosives and Dangerous Goods. By H. JOSHUA PHILLIPS, F.I.C., F.C.S. Crown 8vo, 374 pp., cloth. . . . 9/0

"Merits a wide circulation, and an intelligent, appreciative study."—*Chemical News*.

A MANUAL OF THE ALKALI TRADE.

Including the Manufacture of Sulphuric Acid, Sulphate of Soda, and Bleaching Powder. By JOHN LOMAS, Alkali Manufacturer, Newcastle-upon-Tyne and London. 300 pp. of Text. With 232 Illustrations and Working Drawings, Second Edition, with Additions. Super-royal 8vo, cloth . . . £1 10s.

"This book is written by a manufacturer for manufacturers. The working details of the most approved forms of apparatus are given, and these are accompanied by no less than 232 wood engravings, all of which may be used for the purposes of construction. Every step in the manufacture is very fully described in this manual, and each improvement explained."—*Athenæum*.

"We find not merely a sound and luminous explanation of the chemical principles of the trade, but a notice of numerous matters which have a most important bearing on the successful conduct of alkali works, but which are generally overlooked by even experienced technological authors."—*Chemical Review*.

THE BLOWPIPE IN CHEMISTRY, MINERALOGY, AND GEOLOGY.

Containing all known Methods of Anhydrous Analysis, many Working Examples, and Instructions for Making Apparatus. By Lieut.-Colonel W. A. ROSS, R.A., F.G.S. With 120 Illustrations. Second Edition, Enlarged. Crown 8vo, cloth 5/0

"The student who goes conscientiously through the course of experimentation here laid down will gain a better insight into inorganic chemistry and mineralogy than if he had 'got up' any of the best text-books of the day, and passed any number of examinations in their contents."—*Chemical News*.

THE MANUAL OF COLOURS AND DYE-WARES.

Their Properties, Applications, Valuations, Impurities and Sophistications. For the Use of Dyers, Printers, Drysalts, Brokers, &c. By J. W. SLATER. Second Edition, Revised and greatly Enlarged. Crown 8vo, cloth . . . 7/6

"A complete encyclopædia of the *materia tinctoria*. The information given respecting each article is full and precise, and the methods of determining the value of articles such as these, so liable to sophistication, are given with clearness, and are practical as well as valuable."—*Chemist and Druggist*.

"There is no other work which covers precisely the same ground. To students preparing for examinations in dyeing and printing it will prove exceedingly useful."—*Chemical News*.

A HANDY BOOK FOR BREWERS.

Being a Practical Guide to the Art of Brewing and Malting. Embracing the Conclusions of Modern Research which bear upon the Practice of Brewing. By HERBERT EDWARDS WRIGHT, M.A. Second Edition, Enlarged. Crown 8vo, 530 pp., cloth. [Just Published. 12/6

"May be consulted with advantage by the student who is preparing himself for examinational tests, while the scientific brewer will find in it a *résumé* of all the most important discoveries of modern times. The work is written throughout in a clear and concise manner, and the author takes great care to discriminate between vague theories and well-established facts."—*Brewers' Journal*.

"We have great pleasure in recommending this handy book, and have no hesitation in saying that it is one of the best—if not the best—which has yet been written on the subject of beer-brewing in this country; it should have a place on the shelves of every brewer's library."—*Brewers' Guardian*.

"Although the requirements of the student are primarily considered, an acquaintance of half-an-hour's duration cannot fail to impress the practical brewer with the sense of having found a trustworthy guide and practical counsellor in brewery matters."—*Chemical Trade Journal*.

FUELS: SOLID, LIQUID, AND GASEOUS.

Their Analysis and Valuation. For the Use of Chemists and Engineers. By H. J. PHILLIPS, F.C.S., formerly Analytical and Consulting Chemist to the G.E. Rlwy. Third Edition, Revised and Enlarged. Crown 8vo, cloth 2/0

"Ought to have its place in the laboratory of every metallurgical establishment and wherever fuel is used on a large scale."—*Chemical News*.

THE ARTISTS' MANUAL OF PIGMENTS.

Showing their Composition, Conditions of Permanency, Non-Permanency, and Adulterations; Effects in Combination with Each Other and with Vehicles; and the most Reliable Tests of Purity. By H. C. STANDAGE, Crown 8vo. 2/6

"This work is indeed *multum-in-parvo*, and we can, with good conscience, recommend it to all who come in contact with pigments, whether as makers, dealers, or users."—*Chemical Review*.

A POCKET-BOOK OF MENSURATION AND GAUGING.

Containing Tables, Rules, and Memoranda for Revenue Officers, Brewers, Spirit Merchants, &c. By J. B. MANT, Inland Revenue. Second Edition, Revised. 18mo, leather 4/0

"This handy and useful book is adapted to the requirements of the Inland Revenue Department, and will be a favourite book of reference."—*Civilian*.

"Should be in the hands of every practical brewer."—*Brewers' Journal*.

INDUSTRIAL ARTS, TRADES, AND MANUFACTURES.

TEA MACHINERY AND TEA FACTORIES.

A Descriptive Treatise on the Mechanical Appliances required in the Cultivation of the Tea Plant and the Preparation of Tea for the Market. By A. J. WALLIS-TAYLER, A. M. Inst. C. E. Medium 8vo, 468 pp. With 218 Illustrations. [Just Published. Net 25/0

SUMMARY OF CONTENTS:—MECHANICAL CULTIVATION OR TILLAGE OF THE SOIL.—PLUCKING OR GATHERING THE LEAF.—TEA FACTORIES.—THE DRESSING, MANUFACTURE, OR PREPARATION OF TEA BY MECHANICAL MEANS.—ARTIFICIAL WITHERING OF THE LEAF.—MACHINES FOR ROLLING OR CURLING THE LEAF.—FERMENTING PROCESS.—MACHINES FOR THE AUTOMATIC DRYING OR FIRING OF THE LEAF.—MACHINES FOR NON-AUTOMATIC DRYING OR FIRING OF THE LEAF.—DRYING OR FIRING MACHINES.—BREAKING OR CUTTING, AND SORTING MACHINES.—PACKING THE TEA.—MEANS OF TRANSPORT ON TEA PLANTATIONS.—MISCELLANEOUS MACHINERY AND APPARATUS.—FINAL TREATMENT OF THE TEA.—TABLES AND MEMORANDA.

"The subject of tea machinery is now one of the first interest to a large class of people, to whom we strongly commend the volume."—*Chamber of Commerce Journal*.

"When tea planting was first introduced into the British possessions little, if any, machinery was employed, but now its use is almost universal. This volume contains a very full account of the machinery necessary for the proper outfit of a factory, and also a description of the processes best carried out by this machinery."—*Journal Society of Arts*.

FLOUR MANUFACTURE.

A Treatise on Milling Science and Practice. By FRIEDRICH KICK, Imperial Regierungsrath, Professor of Mechanical Technology in the Imperial German Polytechnic Institute, Prague. Translated from the Second Enlarged and Revised Edition with Supplement. By H. H. P. POWLES, Assoc. Memb. Institution of Civil Engineers. Nearly 400 pp. Illustrated with 28 Folding Plates, and 167 Woodcuts. Royal 8vo, cloth £1 5s.

"This valuable work is, and will remain, the standard authority on the science of milling. . . . The miller who has read and digested this work will have laid the foundation, so to speak, of a successful career; he will have acquired a number of general principles which he can proceed to apply. In this handsome volume we at last have the accepted text-book of modern milling in good, sound English, which has little, if any, trace of the German idiom."—*The Miller*.

COTTON MANUFACTURE.

A Manual of Practical Instruction of the Processes of Opening, Carding, Combing, Drawing, Doubling and Spinning of Cotton, the Methods of Dyeing, &c. For the Use of Operatives Overlookers, and Manufacturers. By JOHN LISTER, Technical Instructor, Pendleton. 8vo, cloth . . . 7/6

"A distinct advance in the literature of cotton manufacture."—*Machinery*.

"It is thoroughly reliable, fulfilling nearly all the requirements desired."—*Glasgow Herald*.

MODERN CYCLES.

A Practical Handbook on their Construction and Repair. By A. J. WALLIS-TAYLER, A. M. Inst. C. E., Author of "Refrigerating Machinery," &c. With upwards of 300 Illustrations. Crown 8vo, cloth. [Just Published. 10/6

"The large trade that is done in the component parts of bicycles has placed in the way of men mechanically inclined extraordinary facilities for building bicycles for their own use. . . . The book will prove a valuable guide for all those who aspire to the manufacture or repair of their own machines."—*The Field*.

"A most comprehensive and up-to-date treatise."—*The Cycle*.

"A very useful book, which is quite entitled to rank as a standard work for students of cycle construction."—*Wheeler*.

CEMENTS, PASTES, GLUES, AND GUMS.

A Practical Guide to the Manufacture and Application of the various Agglutinants required in the Building, Metal-Working, Wood-Working, and Leather-Working Trades, and for Workshop, Laboratory or Office Use. With upwards of 900 Recipes and Formulæ. By H. C. STANDAGE, Chemist. Third Edition. Crown 8vo, cloth. [Just Published. 2/0

"We have pleasure in speaking favourably of this volume. So far as we have had experience, which is not inconsiderable, this manual is trustworthy."—*Athenæum*.

"As a revelation of what are considered trade secrets, this book will arouse an amount of curiosity among the large number of industries it touches."—*Daily Chronicle*.

THE ART OF SOAP-MAKING.

A Practical Handbook of the Manufacture of Hard and Soft Soaps, Toilet Soaps, &c. Including many New Processes, and a Chapter on the Recovery of Glycerine from Waste Leys. By ALX. WATT. Sixth Edition, including an Appendix on Modern Candlemaking. Crown 8vo, cloth.

[Just Published. 7/6

"The work will prove very useful, not merely to the technological student, but to the practical soap boiler who wishes to understand the theory of his art."—*Chemical News*.

"A thoroughly practical treatise on an art which has almost no literature in our language. We congratulate the author on the success of his endeavour to fill a void in English technical literature."—*Nature*.

PRACTICAL PAPER-MAKING.

A Manual for Paper-Makers and Owners and Managers of Paper-Mills. With Tables, Calculations, &c. By G. CLAPPERTON, Paper-Maker. With Illustrations of Fibres from Micro-Photographs. Crown 8vo, cloth . . . 5/0

"The author caters for the requirements of responsible mill hands, apprentices, &c., whilst his manual will be found of great service to students of technology, as well as to veteran paper-makers and mill owners. The illustrations form an excellent feature."—*The World's Paper Trade Review*.

"We recommend everybody interested in the trade to get a copy of this thoroughly practical book."—*Paper Making*.

THE ART OF PAPER-MAKING.

A Practical Handbook of the Manufacture of Paper from Rags, Esparto, Straw, and other Fibrous Materials. Including the Manufacture of Pulp from Wood Fibre, with a Description of the Machinery and Appliances used. To which are added Details of Processes for Recovering Soda from Waste Liquors. By ALEXANDER WATT, Author of "The Art of Soap-Making." With Illustrations. Crown 8vo, cloth 7/6

"It may be regarded as the standard work on the subject. The book is full of valuable information. The 'Art of Paper-Making' is in every respect a model of a text-book, either for a technical class, or for the private student."—*Paper and Printing Trades Journal*.

A TREATISE ON PAPER.

For Printers and Stationers. With an Outline of Paper Manufacture; Complete Tables of Sizes, and Specimens of Different Kinds of Paper. By RICHARD PARKINSON, late of the Manchester Technical School. Demy 8vo, cloth.

[Just Published. 3/6

THE ART OF LEATHER MANUFACTURE.

Being a Practical Handbook, in which the Operations of Tanning, Currying, and Leather Dressing are fully Described, and the Principles of Tanning Explained, and many Recent Processes Introduced; as also Methods for the Estimation of Tannin, and a Description of the Arts of Glue Boiling, Gut Dressing, &c. By ALEXANDER WATT, Author of "Soap-Making," &c. Fourth Edition. Crown 8vo, cloth 9/0

"A sound, comprehensive treatise on tanning and its accessories. The book is an eminently valuable production, which redounds to the credit of both author and publishers."—*Chemical Review*.

THE ART OF BOOT AND SHOE MAKING.

A Practical Handbook, including Measurement, Last-Fitting, Cutting-Out, Closing and Making, with a Description of the most approved Machinery Employed. By JOHN B. LENO, late Editor of *St. Crispin*, and *The Boot and Shoe-Maker*. 12mo, cloth 2/0

WOOD ENGRAVING.

A Practical and Easy Introduction to the Study of the Art. By W. N. BROWN. 12mo, cloth **1/6**

"The book is clear and complete, and will be useful to any one wanting to understand the first elements of the beautiful art of wood engraving."—*Graphic*.

MODERN HOROLOGY, IN THEORY AND PRACTICE.

Translated from the French of CLAUDIUS SAUNIER, ex-Director of the School of Horology at Macon, by JULIEN TRIPPLIN, F.R.A.S., Besancon Watch Manufacturer, and EDWARD RIGG, M.A., Assayer in the Royal Mint. With Seventy-eight Woodcuts and Twenty-two Coloured Copper Plates. Second Edition. Super-royal 8vo, cloth, **£2 2s.**; half-calf **£2 10s.**

"There is no horological work in the English language at all to be compared to this production of M. Saunier's for clearness and completeness. It is alike good as a guide for the student and as a reference for the experienced horologist and skilled workman."—*Horological Journal*.

"The latest, the most complete, and the most reliable of those literary productions to which continental watchmakers are indebted for the mechanical superiority over their English brethren—in fact, the Book of Books, is M. Saunier's 'Treatise.'"—*Watchmaker, Jeweller, and Silversmith*.

THE WATCH ADJUSTER'S MANUAL.

A Practical Guide for the Watch and Chronometer Adjuster in Making, Springing, Timing and Adjusting for Isochronism, Positions and Temperatures. By C. E. FRITTS. 370 pp., with Illustrations, 8vo, cloth **16/0**

THE WATCHMAKER'S HANDBOOK.

Intended as a Workshop Companion for those engaged in Watchmaking and the Allied Mechanical Arts. Translated from the French of CLAUDIUS SAUNIER, and enlarged by JULIEN TRIPPLIN, F.R.A.S., and EDWARD RIGG, M.A., Assayer in the Royal Mint. Third Edition. 8vo, cloth. **9/0**

"Each part is truly a treatise in itself. The arrangement is good and the language is clear and concise. It is an admirable guide for the young watchmaker."—*Engineering*.

"It is impossible to speak too highly of its excellence. It fulfils every requirement in a handbook intended for the use of a workman. Should be found in every workshop."—*Watch and Clockmaker*.

A HISTORY OF WATCHES & OTHER TIMEKEEPERS.

By JAMES F. KENDAL, M.B.H. Inst. Boards, **1/6**; or cloth, gilt **2/6**

"The best which has yet appeared on this subject in the English language."—*Industries*.

"Open the book where you may, there is interesting matter in it concerning the ingenious devices of the ancient or modern horologer."—*Saturday Review*.

ELECTRO-PLATING & ELECTRO-REFINING OF METALS.

Being a new edition of ALEXANDER WATT'S "ELECTRO-DEPOSITION." Revised and Largely Rewritten by ARNOLD PHILIP, B.Sc., A.I.E.E., Principal Assistant to the Admiralty Chemist. Large Crown 8vo, cloth.

[Just Published. Net. **12/6**

"Eminently a book for the practical worker in electro-deposition. It contains practical descriptions of methods, processes and materials, as actually pursued and used in the workshop."—*Engineer*.

ELECTRO-METALLURGY.

Practically Treated. By ALEXANDER WATT. Tenth Edition, including the most recent Processes. 12mo, cloth **3/6**

"From this book both amateur and artisan may learn everything necessary for the successful prosecution of electroplating."—*Iron*.

JEWELLER'S ASSISTANT IN WORKING IN GOLD.

A Practical Treatise for Masters and Workmen, Compiled from the Experience of Thirty Years' Workshop Practice. By GEORGE E. GEE, Author of "The Goldsmith's Handbook," &c. Crown 8vo, cloth **7/6**

"This manual of technical education is apparently destined to be a valuable auxiliary to a handicraft which is certainly capable of great improvement."—*The Times*.

ELECTROPLATING.

A Practical Handbook on the Deposition of Copper, Silver, Nickel, Gold, Aluminium, Brass, Platinum, &c., &c. By J. W. URQUHART, C.E. Fourth Edition, Revised. Crown 8vo, cloth. [Just Published. 5/0

"An excellent practical manual."—*Engineering.*

"An excellent work, giving the newest information."—*Horological Journal.*

ELECTROTYPING.

The Reproduction and Multiplication of Printing Surfaces and Works of Art by the Electro-Deposition of Metals. By J. W. URQUHART, C.E. Crown 8vo, cloth 5/0

"The book is thoroughly practical; the reader is, therefore, conducted through the leading laws of electricity, then through the metals used by electrotypers, the apparatus, and the depositing processes, up to the final preparation of the work."—*Art Journal.*

GOLDSMITH'S HANDBOOK.

By GEORGE E. GEE, Jeweller, &c. Fifth Edition. 12mo, cloth 3/0

"A good, sound educator, and will be generally accepted as an authority."—*Horological Journal.*

SILVERSMITH'S HANDBOOK.

By GEORGE E. GEE, Jeweller, &c. Third Edition, with numerous Illustrations. 12mo, cloth 3/0

"The chief merit of the work is its practical character. . . . The workers in the trade will speedily discover its merits when they sit down to study it."—*English Mechanic.*

. The above two works together, strongly half-bound, price 7s.

SHEET METAL WORKER'S INSTRUCTOR.

Comprising a Selection of Geometrical Problems and Practical Rules for Describing the Various Patterns Required by Zinc, Sheet-Iron, Copper, and Tin-Plate Workers. By REUBEN HENRY WARN. New Edition, Revised and greatly Enlarged by JOSEPH G. HORNER, A.M.I.M.E. Crown 8vo, 254 pp., with 430 Illustrations, cloth. [Just Published. 7/6

BREAD & BISCUIT BAKER'S & SUGAR-BOILER'S ASSISTANT.

Including a large variety of Modern Recipes. With Remarks on the Art of Bread-making. By ROBERT WELLS. Third Edition. Crown 8vo, cloth . 2/0

"A large number of wrinkles for the ordinary cook, as well as the baker."—*Saturday Review.*

PASTRYCOOK & CONFECTIONER'S GUIDE.

For Hotels, Restaurants, and the Trade in general, adapted also for Family Use. By R. WELLS, Author of "The Bread and Biscuit Baker." Crown 8vo, cloth 2/0

"We cannot speak too highly of this really excellent work. In these days of keen competition our readers cannot do better than purchase this book."—*Bakers' Times.*

ORNAMENTAL CONFECTIONERY.

A Guide for Bakers, Confectioners and Pastrycooks; including a variety of Modern Recipes, and Remarks on Decorative and Coloured Work. With 129 Original Designs. By ROBERT WELLS. Second Edition. Crown 8vo . 5/0

"A valuable work, practical, and should be in the hands of every baker and confectioner. The illustrative designs are alone worth treble the amount charged for the whole work."—*Bakers' Times.*

THE MODERN FLOUR CONFECTIONER, WHOLESALE AND RETAIL.

Containing a large Collection of Recipes for Cheap Cakes, Biscuits, &c. With remarks on the Ingredients Used in their Manufacture. By ROBERT WELLS, Author of "The Bread and Biscuit Baker," &c. Crown 8vo, cloth . 2/0

"The work is of a decidedly practical character, and in every recipe regard is had to economical working."—*North British Daily Mail.*

RUBBER HAND STAMPS

And the Manipulation of Rubber. A Practical Treatise on the Manufacture of Indiarubber Hand Stamps, Small Articles of Indiarubber, The Hektograph, Special Inks, Cements, and Allied Subjects. By T. O'CONNOR SLOANE, A.M., Ph.D. With numerous Illustrations. Square 8vo, cloth. 5/0

HANDYBOOKS FOR HANDICRAFTS.

BY PAUL N. HASLACK.

Editor of "Work" (New Series), Author of "Lathe Work," "Milling Machines," &c. Crown 8vo, 144 pp., price 1s. each.

These HANDYBOOKS have been written to supply information for WORKMEN, STUDENTS, and AMATEURS in the several Handicrafts, on the actual PRACTICE of the WORKSHOP, and are intended to convey in plain language TECHNICAL KNOWLEDGE of the several CRAFTS. In describing the processes employed, and the manipulation of material, workshop terms are used; workshop practice is fully explained; and the text is freely illustrated with drawings of modern tools, appliances, and processes.

THE METAL TURNER'S HANDYBOOK.

A Practical Manual for Workers at the Foot-Lathe. With over 100 Illustrations. 1/0

"The book will be of service alike to the amateur and the artisan turner. It displays thorough knowledge of the subject."—*Scotsman*.

THE WOOD TURNER'S HANDYBOOK.

A Practical Manual for Workers at the Lathe. With over 100 Illustrations. 1/0

"We recommend the book to young turners and amateurs. A multitude of workmen have hitherto sought in vain for a manual of this special industry."—*Mechanical World*.

THE WATCH JOBBER'S HANDYBOOK.

A Practical Manual on Cleaning, Repairing, and Adjusting. With upwards of 100 Illustrations 1/0

"We strongly advise all young persons connected with the watch trade to acquire and study this important work."—*Clerkenwell Chronicle*.

THE PATTERN MAKER'S HANDYBOOK.

A Practical Manual on the Construction of Patterns for Founders. With upwards of 100 Illustrations 1/0

"A most valuable, if not indispensable manual for the pattern maker."—*Knowledge*.

THE MECHANIC'S WORKSHOP HANDYBOOK.

A Practical Manual on Mechanical Manipulation, embracing Information on various Handicraft Processes. With Useful Notes and Miscellaneous Memoranda. Comprising about 200 Subjects 1/0

"A very clever and useful book, which should be found in every workshop; and it should certainly find a place in all technical schools."—*Saturday Review*.

THE MODEL ENGINEER'S HANDYBOOK.

A Practical Manual on the Construction of Model Steam Engines. With upwards of 100 Illustrations. 1/0

"Mr. Hasluck has produced a very good little book."—*Builder*.

THE CLOCK JOBBER'S HANDYBOOK.

A Practical Manual on Cleaning, Repairing, and Adjusting. With upwards of 100 Illustrations 1/0

"It is of inestimable service to those commencing the trade."—*Coventry Standard*.

THE CABINET MAKER'S HANDYBOOK.

A Practical Manual on the Tools, Materials, Appliances, and Processes employed in Cabinet Work. With upwards of 100 Illustrations 1/0

"Mr. Hasluck's thorough-going little Handybook is amongst the most practical guides we have seen for beginners in cabinet-work."—*Saturday Review*.

THE WOODWORKER'S HANDYBOOK OF MANUAL INSTRUCTION.

Embracing Information on the Tools, Materials, Appliances and Processes Employed in Woodworking. With 104 Illustrations. 1/0

OPINIONS OF THE PRESS.

"Written by a man who knows, not only how work ought to be done, but how to do it, and how to convey his knowledge to others."—*Engineering*.

"Mr. Hasluck writes admirably, and gives complete instructions."—*Engineer*.

"Mr. Hasluck combines the experience of a practical teacher with the manipulative skill and scientific knowledge of processes of the trained mechanic, and the manuals are marvels of what can be produced at a popular price."—*Schoolmaster*.

"Helpful to workmen of all ages and degrees of experience."—*Daily Chronicle*.

"Practical, sensible, and remarkably cheap."—*Journal of Education*.

"Concise, clear, and practical."—*Saturday Review*.

COMMERCE, COUNTING-HOUSE WORK, TABLES, &c.

LESSONS IN COMMERCE.

By Professor R. GAMBARO, of the Royal High Commercial School at Genoa.
Edited and Revised by JAMES GAULT, Professor of Commerce and Commercial
Law in King's College, London. Fourth Edition. Crown 8vo, cloth . 3/6

"The publishers of this work have rendered considerable service to the cause of commercial education by the opportune production of this volume. . . . The work is peculiarly acceptable to English readers and an admirable addition to existing class books. In a phrase, we think the work attains its object in furnishing a brief account of those laws and customs of British trade with which the commercial man interested therein should be familiar."—*Chamber of Commerce Journal*.

"An invaluable guide in the hands of those who are preparing for a commercial career, and, in fact, the information it contains on matters of business should be impressed on every one."—*Counting House*.

THE FOREIGN COMMERCIAL CORRESPONDENT.

Being Aids to Commercial Correspondence in Five Languages—English, French, German, Italian, and Spanish. By CONRAD E. BAKER. Third Edition, Carefully Revised Throughout. Crown 8vo, cloth.

[Just Published. 4/6

"Whoever wishes to correspond in all the languages mentioned by Mr. Baker cannot do better than study this work, the materials of which are excellent and conveniently arranged. They consist not of entire specimen letters, but—what are far more useful—short passages, sentences, or phrases expressing the same general idea in various forms."—*Athenaeum*.

"A careful examination has convinced us that it is unusually complete, well arranged and reliable. The book is a thoroughly good one."—*Schoolmaster*.

FACTORY ACCOUNTS: their PRINCIPLES & PRACTICE.

A Handbook for Accountants and Manufacturers, with Appendices on the Nomenclature of Machine Details; the Income Tax Acts; the Rating of Factories; Fire and Boiler Insurance; the Factory and Workshop Acts, &c., including also a Glossary of Terms and a large number of Specimen Rulings. By EMILE GARCKE and J. M. FELS. Fifth Edition, Revised and Enlarged. Demy 8vo, cloth.

[Just Published. 7/6

"A very interesting description of the requirements of Factory Accounts. . . . The principle of assimilating the Factory Accounts to the general commercial books is one which we thoroughly agree with."—*Accountants' Journal*.

"Characterised by extreme thoroughness. There are few owners of factories who would not derive great benefit from the perusal of this most admirable work."—*Local Government Chronicle*.

MODERN METROLOGY.

A Manual of the Metrical Units and Systems of the present Century. With an Appendix containing a proposed English System. By LEWIS D. A. JACKSON, A. M. Inst. C. E., Author of "Aid to Survey Practice," &c. Large crown 8vo, cloth 12/6

"We recommend the work to all interested in the practical reform of our weights and measures."—*Nature*.

A SERIES OF METRIC TABLES.

In which the British Standard Measures and Weights are compared with those of the Metric System at present in Use on the Continent. By C. H. DOWLING, C. E. 8vo, strongly bound 10/6

"Mr. Dowling's Tables are well put together as a ready reckoner for the conversion of one system into the other."—*Athenaeum*.

THE IRON AND METAL TRADES' COMPANION.

For Expediently Ascertaining the Value of any Goods bought or sold by Weight, from 1s. per cwt. to 112s. per cwt., and from one farthing per pound to one shilling per pound. By THOMAS DOWNIE. 396 pp., leather 9/0

"A most useful set of tables, nothing like them before existed."—*Building News*.

"Although specially adapted to the iron and metal trades, the tables will be found useful in every other business in which merchandise is bought and sold by weight."—*Railway News*.

NUMBER, WEIGHT, AND FRACTIONAL CALCULATOR.

Containing upwards of 250,000 Separate Calculations, showing at a Glance the Value at 422 Different Rates, ranging from $\frac{1}{12}$ th of a Penny to 20s. each, or per cwt., and £20 per ton, of any number of articles consecutively, from 1 to 470. Any number of cwts., qrs., and lbs., from 1 cwt. to 470 cwts. Any number of tons, cwts., qrs., and lbs., from 1 to 1,000 tons. By WILLIAM CHADWICK, Public Accountant. Third Edition, Revised. 8vo, strongly bound . **18/0**

"It is as easy of reference for any answer or any number of answers as a dictionary. For making up accounts or estimates the book must prove invaluable to all who have any considerable quantity of calculations involving price and measure in any combination to do."—*Engineer*.

"The most perfect work of the kind yet prepared."—*Glasgow Herald*.

THE WEIGHT CALCULATOR.

Being a Series of Tables upon a New and Comprehensive Plan, exhibiting at one Reference the exact Value of any Weight from 1 lb. to 15 tons, at 300 Progressive Rates, from 1d. to 168s. per cwt., and containing 186,000 Direct Answers, which, with their Combinations, consisting of a single addition (mostly to be performed at sight), will afford an aggregate of 10,266,000 Answers; the whole being calculated and designed to ensure correctness and promote despatch. By HENRY HARBEN, Accountant. Fifth Edition, carefully Corrected. Royal 8vo, strongly half-bound **£1 5s.**

"A practical and useful work of reference for men of business generally."—*Ironmonger*.

"Of priceless value to business men. It is a necessary book in all mercantile offices."—*Sheffield Independent*.

THE DISCOUNT GUIDE.

Comprising several Series of Tables for the Use of Merchants, Manufacturers, Ironmongers, and Others, by which may be ascertained the Exact Profit arising from any mode of using Discounts, either in the Purchase or Sale of Goods, and the method of either Altering a Rate of Discount, or Advancing a Price, so as to produce, by one operation, a sum that will realise any required Profit after allowing one or more Discounts; to which are added Tables of Profit or Advance from $1\frac{1}{4}$ to 90 per cent., Tables of Discount from $1\frac{1}{4}$ to $98\frac{3}{4}$ per cent., and Tables of Commission, &c., from $\frac{1}{8}$ to 10 per cent. By HENRY HARBEN, Accountant. New Edition, Corrected. Demy 8vo, half-bound . **£1 5s.**

"A book such as this can only be appreciated by business men, to whom the saving of time means saving of money. The work must prove of great value to merchants, manufacturers, and general traders."—*British Trade Journal*.

TABLES OF WAGES.

At 54, 52, 50 and 48 Hours per Week. Showing the Amounts of Wages from One quarter of an hour to Sixty-four hours, in each case at Rates of Wages advancing by One Shilling from 4s. to 55s. per week. By THOS. GARBUTT, Accountant. Square crown 8vo, half-bound **6/0**

IRON-PLATE WEIGHT TABLES.

For Iron Shipbuilders, Engineers, and Iron Merchants. Containing the Calculated Weights of upwards of 150,000 different sizes of Iron Plates from 1 foot by 6 in. by $\frac{1}{4}$ in. to 10 feet by 5 feet by 1 in. Worked out on the Basis of 40 lbs. to the square foot of Iron of 1 inch in thickness. By H. BURLINSON and W. H. SIMPSON. 4to, half-bound **£1 5s.**

MATHEMATICAL TABLES (ACTUARIAL).

Comprising Commutation and Conversion Tables, Logarithms, Cologarithms, Antilogarithms and Reciprocals. By J. W. GORDON. Royal 8vo, mounted on canvas, in cloth case. [Just Published. **5/0**

AGRICULTURE, FARMING, GARDENING, &c.

THE COMPLETE GRAZIER AND FARMER'S AND CATTLE BREEDER'S ASSISTANT.

A Compendium of Husbandry. Originally Written by WILLIAM YOUATT. Fourteenth Edition, entirely Re-written, considerably Enlarged, and brought up to Present Requirements, by WILLIAM FREAM, LL.D., Assistant Commissioner, Royal Commission on Agriculture, 1893, Author of "The Elements of Agriculture," &c. Royal 8vo, 1,100 pp., with over 450 Illustrations, handsomely bound. [Just Published. £1 11s. 6d.

SUMMARY OF CONTENTS.

BOOK I. ON THE VARIETIES, BREEDING, REARING, FATTENING AND MANAGEMENT OF CATTLE.
BOOK II. ON THE ECONOMY AND MANAGEMENT OF THE DAIRY.
BOOK III. ON THE BREEDING, REARING, AND MANAGEMENT OF HORSES.
BOOK IV. ON THE BREEDING, REARING, AND FATTENING OF SHEEP.
BOOK V. ON THE BREEDING, REARING, AND FATTENING OF SWINE.
BOOK VI. ON THE DISEASES OF LIVE STOCK.

BOOK VII. ON THE BREEDING, REARING, AND MANAGEMENT OF POULTRY.
BOOK VIII. ON FARM OFFICES AND IMPLEMENTS OF HUSBANDRY.
BOOK IX. ON THE CULTURE AND MANAGEMENT OF GRASS LANDS.
BOOK X. ON THE CULTIVATION AND APPLICATION OF GRASSES, PULSE AND ROOTS.
BOOK XI. ON MANURES AND THEIR APPLICATION TO GRASS LAND AND CROPS.
BOOK XII. MONTHLY CALENDARS OF FARMWORK.

** OPINIONS OF THE PRESS ON THE NEW EDITION.

"Dr. Fream is to be congratulated on the successful attempt he has made to give us a work which will at once become the standard classic of the farm practice of the country. We believe that it will be found that it has no compeer among the many works at present in existence. . . . The illustrations are admirable, while the frontispiece, which represents the well-known bull, New Year's Gift, owned by the Queen, is a work of art."—*The Times*.

"The book must be recognised as occupying the proud position of the most exhaustive work of reference in the English language on the subject with which it deals."—*Athenaeum*.
"The most comprehensive guide to modern farm practice that exists in the English language to-day. . . . The book is one that ought to be on every farm and in the library of every land owner."—*Mark Lane Express*.

"In point of exhaustiveness and accuracy the work will certainly hold a pre-eminent and unique position among books dealing with scientific agricultural practice. It is, in fact, an agricultural library of itself."—*North British Agriculturist*.

FARM LIVE STOCK OF GREAT BRITAIN.

By ROBERT WALLACE, F.L.S., F.R.S.E., &c., Professor of Agriculture and Rural Economy in the University of Edinburgh. Third Edition, thoroughly Revised and considerably Enlarged. With over 120 Phototypes of Prize Stock. Demy 8vo, 384 pp., with 79 Plates and Maps, cloth. . . . 12/6

"A really complete work on the history, breeds, and management of the farm stock of Great Britain, and one which is likely to find its way to the shelves of every country gentleman's library."—*The Times*.

"The latest edition of 'Farm Live Stock of Great Britain' is a production to be proud of, and its issue not the least of the services which its author has rendered to agricultural science."—*Scottish Farmer*.

NOTE-BOOK OF AGRICULTURAL FACTS & FIGURES FOR FARMERS AND FARM STUDENTS.

By PRIMROSE MCCONNELL, B.Sc., Fellow of the Highland and Agricultural Society, Author of "Elements of Farming." Sixth Edition, Re-written, Revised, and greatly Enlarged. Fcap. 8vo, 480 pp., leather. [Just Published. 6/0

SUMMARY OF CONTENTS: SURVEYING AND LEVELLING.—WEIGHTS AND MEASURES.—MACHINERY AND BUILDINGS.—LABOUR.—OPERATIONS.—DRAINING.—EMBANKING.—GEOLOGICAL MEMORANDA.—SOILS.—MANURES.—CROPPING.—CROPS.—ROTATIONS.—WEEDS.—FEEDING.—DAIRYING.—LIVE STOCK.—HORSES.—CATTLE.—SHEEP.—PIGS.—POULTRY.—FORESTRY.—HORTICULTURE.—MISCELLANEOUS.

"No farmer, and certainly no agricultural student, ought to be without this *multum-in-parvo* manual of all subjects connected with the farm."—*North British Agriculturist*.

"The amount of information it contains is most surprising; the arrangement of the matter is so methodical—although so compressed—as to be intelligible to everyone who takes a glance through its pages. They teem with information."—*Farm and Home*.

THE ELEMENTS OF AGRICULTURAL GEOLOGY.

A Scientific Aid to Practical Farming. By PRIMROSE MCCONNELL, Author of "Note-Book of Agricultural Facts and Figures." Royal 8vo, cloth. [Just Published. Net 21/0

"On every page the work bears the impress of a masterly knowledge of the subject dealt with, and we have nothing but unstinted praise to offer."—*The Field*.

BRITISH DAIRYING.

A Handy Volume on the Work of the Dairy-Farm. For the Use of Technical Instruction Classes, Students in Agricultural Colleges and the Working Dairy-Farmer. By Prof. J. P. SHELDON. With Illustrations. Second Edition, Revised. Crown 8vo, cloth. [Just Published. 2/6

"Confidently recommended as a useful text-book on dairy farming."—*Agricultural Gazette*.
 "Probably the best half-crown manual on dairy work that has yet been produced."—*North British Agriculturist*.

"It is the soundest little work we have yet seen on the subject."—*The Times*.

MILK, CHEESE, AND BUTTER.

A Practical Handbook on their Properties and the Processes of their Production. Including a Chapter on Cream and the Methods of its Separation from Milk. By JOHN OLIVER, late Principal of the Western Dairy Institute, Berkeley. With Coloured Plates and 200 Illustrations. Crown 8vo, cloth. 7/6

"An exhaustive and masterly production. It may be cordially recommended to all students and practitioners of dairy science."—*North British Agriculturist*.

"We recommend this very comprehensive and carefully-written book to dairy-farmers and students of dairying. It is a distinct acquisition to the library of the agriculturist."—*Agricultural Gazette*.

SYSTEMATIC SMALL FARMING.

Or, The Lessons of My Farm. Being an Introduction to Modern Farm Practice for Small Farmers. By R. SCOTT BURN, Author of "Outlines of Modern Farming," &c. Crown 8vo, cloth. 6/0

"This is the completest book of its class we have seen, and one which every amateur farmer will read with pleasure, and accept as a guide."—*Field*.

OUTLINES OF MODERN FARMING.

By R. SCOTT BURN. Soils, Manures, and Crops—Farming and Farming Economy—Cattle, Sheep, and Horses—Management of Dairy, Pigs, and Poultry—Utilisation of Town-Sewage, Irrigation, &c. Sixth Edition. In One Vol., 1,250 pp., half-bound, profusely Illustrated 12/0

FARM ENGINEERING, The COMPLETE TEXT-BOOK of.

Comprising Draining and Embanking; Irrigation and Water Supply; Farm Roads, Fences and Gates; Farm Buildings; Barn Implements and Machines; Field Implements and Machines; Agricultural Surveying, &c. By Professor JOHN SCOTT. In One Vol., 1,150 pp., half-bound, with over 600 Illustrations. 12/0

"Written with great care, as well as with knowledge and ability. The author has done his work well; we have found him a very trustworthy guide wherever we have tested his statements. The volume will be of great value to agricultural students."—*Mark Lane Express*.

THE FIELDS OF GREAT BRITAIN.

A Text-Book of Agriculture. Adapted to the Syllabus of the Science and Art Department. For Elementary and Advanced Students. By HUGH CLEMENTS (Board of Trade). Second Edition, Revised, with Additions. 18mo, cloth 2/6

"It is a long time since we have seen a book which has pleased us more, or which contains such a vast and useful fund of knowledge."—*Educational Times*.

TABLES and MEMORANDA for FARMERS, GRAZIERS, AGRICULTURAL STUDENTS, SURVEYORS, LAND AGENTS, AUCTIONEERS, &c.

With a New System of Farm Book-keeping. By SIDNEY FRANCIS. Fifth Edition. 272 pp., waistcoat-pocket size, limp leather 1/6

"Weighing less than 1 oz., and occupying no more space than a match-box, it contains a mass of facts and calculations which has never before, in such handy form, been obtainable. Every operation on the farm is dealt with. The work may be taken as thoroughly accurate, the whole of the tables having been revised by Dr. Fream. We cordially recommend it."—*Bell's Weekly Messenger*.

THE ROTHAMSTED EXPERIMENTS AND THEIR PRACTICAL LESSONS FOR FARMERS.

Part I. STOCK. Part II. CROPS. By C. J. R. TIPPER. Crown 8vo, cloth. [Just Published. 3/6

"We have no doubt that the book will be welcomed by a large class of farmers and others interested in agriculture."—*Standard*.

FERTILISERS AND FEEDING STUFFS.

A Handbook for the Practical Farmer. By BERNARD DYER, D.Sc. (Lond.). With the Text of the Fertilisers and Feeding Stuffs Act of 1893, &c. Third Edition, Revised. Crown 8vo, cloth. [Just Published. 1/0

"This little book is precisely what it professes to be—'A Handbook for the Practical Farmer.' Dr. Dyer has done farmers good service in placing at their disposal so much useful information in so intelligible a form."—*The Times*.

BEEES FOR PLEASURE AND PROFIT.

A Guide to the Manipulation of Bees, the Production of Honey, and the General Management of the Apiary. By G. GORDON SAMSON. With numerous Illustrations. Crown 8vo, wrapper 1/0

BOOK-KEEPING for FARMERS and ESTATE OWNERS.

A Practical Treatise, presenting, in Three Plans, a System adapted for all Classes of Farms. By JOHNSON M. WOODMAN, Chartered Accountant. Fourth Edition. Crown 8vo, cloth 2/6

"The volume is a capital study of a most important subject."—*Agricultural Gazette*.

WOODMAN'S YEARLY FARM ACCOUNT BOOK.

Giving Weekly Labour Account and Diary, and showing the Income and Expenditure under each Department of Crops, Live Stock, Dairy, &c., &c. With Valuation, Profit and Loss Account, and Balance Sheet at the End of the Year. By JOHNSON M. WOODMAN, Chartered Accountant. Second Edition. Folio, half-bound Net 7/6

"Contains every requisite form for keeping farm accounts readily and accurately."—*Agriculture*.

THE FORCING GARDEN.

Or, How to Grow Early Fruits, Flowers and Vegetables. With Plans and Estimates for Building Glasshouses, Pits and Frames. With Illustrations. By SAMUEL WOOD. Crown 8vo, cloth 3/6

"A good book, containing a great deal of valuable teaching."—*Gardeners' Magazine*.

A PLAIN GUIDE TO GOOD GARDENING.

Or, How to Grow Vegetables, Fruits, and Flowers. By S. WOOD. Fourth Edition, with considerable Additions, and numerous Illustrations. Crown 8vo, cloth 3/6

"A very good book, and one to be highly recommended as a practical guide. The practical directions are excellent."—*Athenaeum*.

MULTUM-IN-PARVO GARDENING.

Or, How to Make One Acre of Land produce £620 a year, by the Cultivation of Fruits and Vegetables; also, How to Grow Flowers in Three Glass Houses, so as to realise £176 per annum clear Profit. By SAMUEL WOOD, Author of "Good Gardening," &c. Sixth Edition, Crown 8vo, sewed 1/0

"We are bound to recommend it as not only suited to the case of the amateur and gentleman's gardener, but to the market grower."—*Gardeners' Magazine*.

THE LADIES' MULTUM-IN-PARVO FLOWER GARDEN.

And Amateur's Complete Guide. By S. WOOD. Crown 8vo, cloth 3/6

"Full of shrewd hints and useful instructions, based on a lifetime of experience."—*Scotsman*.

POTATOES: HOW TO GROW AND SHOW THEM.

A Practical Guide to the Cultivation and General Treatment of the Potato. By J. PINK. Crown 8vo 2/0

MARKET AND KITCHEN GARDENING.

By C. W. SHAW, late Editor of *Gardening Illustrated*. Cloth 3/6

"The most valuable compendium of kitchen and market-garden work published."—*Farmer*.

AUCTIONEERING, VALUING, LAND SURVEYING, ESTATE AGENCY, &c.

INWOOD'S TABLES FOR PURCHASING ESTATES AND FOR THE VALUATION OF PROPERTIES,

Including Advowsons, Assurance Policies, Copyholds, Deferred Annuities, Freeholds, Ground Rents, Immediate Annuities, Leaseholds, Life Interests, Mortgages, Perpetuities, Renewals of Leases, Reversions, Sinking Funds, &c., &c. 26th Edition, Revised and Extended by WILLIAM SCHOOLING, F.R.A.S., with Logarithms of Natural Numbers and THOMAN'S Logarithmic Interest and Annuity Tables. 360 pp., Demy 8vo, cloth.

[Just Published. Net 8/0

"Those interested in the purchase and sale of estates, and in the adjustment of compensation cases, as well as in transactions in annuities, life insurances, &c., will find the present edition of eminent service."—*Engineering*.

"This valuable book has been considerably enlarged and improved by the labours of Mr. Schooling, and is now very complete indeed."—*Economist*.

"Altogether this edition will prove of extreme value to many classes of professional men in saving them many long and tedious calculations."—*Investors' Review*.

THE APPRAISER, AUCTIONEER, BROKER, HOUSE AND ESTATE AGENT AND VALUER'S POCKET ASSISTANT.

For the Valuation for Purchase, Sale, or Renewal of Leases, Annuities, and Reversions, and of Property generally; with Prices for Inventories, &c. By JOHN WHEELER, Valuer, &c. Sixth Edition, Re-written and greatly Extended by C. NORRIS, Surveyor, Valuer, &c. Royal 32mo, cloth 5/0

"A neat and concise book of reference, containing an admirable and clearly-arranged list of prices for inventories, and a very practical guide to determine the value of furniture, &c."—*Standard*.

"Contains a large quantity of varied and useful information as to the valuation for purchase, sale, or renewal of leases, annuities and reversions, and of property generally, with prices for inventories, and a guide to determine the value of interior fittings and other effects."—*Builder*.

AUCTIONEERS: THEIR DUTIES AND LIABILITIES.

A Manual of Instruction and Counsel for the Young Auctioneer. By ROBERT SQUIBBS, Auctioneer. Second Edition, Revised and partly Re-written. Demy 8vo, cloth 12/6

"The standard text-book on the topics of which it treats."—*Athenæum*.

"The work is one of general excellent character, and gives much information in a compact and satisfactory form."—*Builder*.

"May be recommended as giving a great deal of information on the law relating to auctioneers, in a very readable form."—*Law Journal*.

"Auctioneers may be congratulated on having so pleasing a writer to minister to their special needs."—*Solicitors' Journal*.

THE AGRICULTURAL VALUER'S ASSISTANT.

A Practical Handbook on the Valuation of Landed Estates; including Example of a Detailed Report on Management and Realisation; Forms of Valuations of Tenant Right; Lists of Local Agricultural Customs; Scales of Compensation under the Agricultural Holdings Act, and a Brief Treatise on Compensation under the Lands Clauses Acts, &c. By TOM BRIGHT, Agricultural Valuer. Author of "The Agricultural Surveyor and Estate Agent's Handbook." Fourth Edition, with Appendix containing a Digest of the Agricultural Holdings Acts, 1883 and 1900. Crown 8vo, cloth.

[Just Published. Net 6/0

"Full of tables and examples in connection with the valuation of tenant-right, estates, labour, contents and weights of timber, and farm produce of all kinds."—*Agricultural Gazette*.

"An eminently practical handbook, full of practical tables and data of undoubted interest and value to surveyors and auctioneers in preparing valuations of all kinds."—*Farmer*.

POLE PLANTATIONS AND UNDERWOODS.

A Practical Handbook on Estimating the Cost of Forming, Renovating, Improving, and Grubbing Plantations and Underwoods, their Valuation for Purposes of Transfer, Rental, Sale or Assessment. By TOM BRIGHT. Crown 8vo, cloth 3/6

"To valuers, foresters and agents it will be a welcome aid."—*North British Agriculturist*.

"Well calculated to assist the valuer in the discharge of his duties, and of undoubted interest and use both to surveyors and auctioneers in preparing valuations of all kinds."—*Kent Herald*.

AGRICULTURAL SURVEYOR AND ESTATE AGENT'S HANDBOOK.

Of Practical Rules, Formulæ, Tables, and Data. A Comprehensive Manual for the Use of Surveyors, Agents, Landowners, and others interested in the Equipment, the Management, or the Valuation of Landed Estates. By TOM BRIGHT, Agricultural Surveyor and Valuer, Author of "The Agricultural Valuer's Assistant," &c. With Illustrations. Fcap. 8vo, Leather.

Just Published. Net 7/6

"An exceedingly useful book, the contents of which are admirably chosen. The classes for whom the work is intended will find it convenient to have this comprehensive handbook accessible for reference."—*Live Stock Journal*.

"It is a singularly compact and well informed compendium of the facts and figures likely to be required in estate work, and is certain to prove of much service to those to whom it is addressed."—*Scotsman*.

THE LAND VALUER'S BEST ASSISTANT.

Being Tables on a very much Improved Plan, for Calculating the Value of Estates. With Tables for reducing Scotch, Irish, and Provincial Customary Acres to Statute Measure, &c. By R. HUDSON, C.E. New Edition. Royal 32mo, leather, elastic band 4/0

"Of incalculable value to the country gentleman and professional man."—*Farmers' Journal*.

THE LAND IMPROVER'S POCKET-BOOK.

Comprising Formulæ, Tables, and Memoranda required in any Computation relating to the Permanent Improvement of Landed Property. By JOHN EWART, Surveyor. Second Edition, Revised. Royal 32mo, oblong, leather . . . 4/0

"A compendious and handy little volume."—*Spectator*.

THE LAND VALUER'S COMPLETE POCKET-BOOK.

Being the above Two Works bound together. Leather 7/6

HANDBOOK OF HOUSE PROPERTY.

A Popular and Practical Guide to the Purchase, Mortgage, Tenancy, and Compulsory Sale of Houses and Land, including Dilapidations and Fixtures: with Examples of all kinds of Valuations, Information on Building and on the right use of Decorative Art. By E. L. TARBUCK, Architect and Surveyor. Sixth Edition. 12mo, cloth 5/0

"The advice is thoroughly practical."—*Law Journal*.

"For all who have dealings with house property, this is an indispensable guide."—*Decoration*.

"Carefully brought up to date, and much improved by the addition of a division on Fine Art. A well-written and thoughtful work."—*Land Agent's Record*.

LAW AND MISCELLANEOUS.

MODERN JOURNALISM.

A Handbook of Instruction and Counsel for the Young Journalist. By JOHN B. MACKIE, Fellow of the Institute of Journalists. Crown 8vo, cloth . . . 2/0

"This invaluable guide to journalism is a work which all aspirants to a journalistic career will read with advantage."—*Journalist*.

HANDBOOK FOR SOLICITORS AND ENGINEERS

Engaged in Promoting Private Acts of Parliament and Provisional Orders for the Authorisation of Railways, Tramways, Gas and Water Works, &c. By L. LIVINGSTONE MACASSEY, of the Middle Temple, Barrister-at-Law, M. Inst. C.E. 8vo, cloth £1 5s.

PATENTS for INVENTIONS, HOW to PROCURE THEM.

Compiled for the Use of Inventors, Patentees and others. By G. G. M. HARDINGHAM, Assoc. Mem. Inst. C.E., &c. Demy 8vo, cloth 1/6

CONCILIATION & ARBITRATION in LABOUR DISPUTES.

A Historical Sketch and Brief Statement of the Present Position of the Question at Home and Abroad. By J. S. JEANS, Author of "England's Supremacy &c." Crown 8vo, 200 pp., cloth 2/6

EVERY MAN'S OWN LAWYER.

A Handy-Book of the Principles of Law and Equity. With a Concise Dictionary of Legal Terms. By A BARRISTER. Thirty-ninth Edition, carefully Revised, and including New Acts of Parliament of 1901. Comprising the *Youthful Offenders Act, 1901*; the *Larceny Act, 1901*; the *Intoxicating Liquors Act, 1901*; the *Factory and Workshop Act, 1901*, and other enactments of the year. *Judicial Decisions during the year have also been duly noted.* Crown 8vo, 800 pp., strongly bound in cloth.

[Just Published. 6/8

** *This Standard Work of Reference forms a COMPLETE EPITOME OF THE LAWS OF ENGLAND, comprising (amongst other matter):*

THE RIGHTS AND WRONGS OF INDIVIDUALS—LANDLORD AND TENANT—VENDORS AND PURCHASERS—LEASES AND MORTGAGES—PRINCIPAL AND AGENT—PARTNERSHIP AND COMPANIES—MASTERS, SERVANTS AND WORKMEN—CONTRACTS AND AGREEMENTS—BORROWERS, LENDERS AND SURETIES—SALE AND PURCHASE OF GOODS—CHEQUES, BILLS AND NOTES—BILLS OF SALE—BANKRUPTCY—RAILWAY AND SHIPPING LAW—LIFE, FIRE, AND MARINE INSURANCE—ACCIDENT AND FIDELITY INSURANCE—CRIMINAL LAW—PARLIAMENTARY ELECTIONS—COUNTY COUNCILS—DISTRICT COUNCILS—PARISH COUNCILS—MUNICIPAL CORPORATIONS—LIBEL AND SLANDER—PUBLIC HEALTH AND NUISANCES—COPYRIGHT, PATENTS, TRADE MARKS—HUSBAND AND WIFE—DIVORCE—INFANCY—CUSTODY OF CHILDREN—TRUSTEES AND EXECUTORS—CLERGY, CHURCHWARDENS, &c.—GAME LAWS AND SPORTING—INNKEEPERS—HORSES AND DOGS—TAXES AND DEATH DUTIES—FORMS OF AGREEMENTS, WILLS, CODICILS, NOTICES, &c.

The object of this work is to enable those who consult it to help themselves to the law; and thereby to dispense, as far as possible, with professional assistance and advice. There are many wrongs and grievances which persons submit to from time to time through not knowing how or where to apply for redress; and many persons have as great a dread of a lawyer's office as of a lion's den. With this book at hand it is believed that many a SIX-AND-EIGHTPENCE may be saved; many a wrong redressed; many a right reclaimed; many a law suit avoided; and many an evil abated. The work has established itself as the standard legal adviser of all classes, and has also made a reputation for itself as a useful book of reference for lawyers residing at a distance from law libraries, who are glad to have at hand a work embodying recent decisions and enactments.

OPINIONS OF THE PRESS.

- "It is a complete code of English Law written in plain language, which all can understand. . . . Should be in the hands of every business man, and all who wish to abolish lawyers bills."—*Weekly Times.*
- "A useful and concise epitome of the law, compiled with considerable care."—*Law Magazine.*
- "A complete digest of the most useful facts which constitute English law."—*Globe.*
- "This excellent handbook. . . . Admirably done, admirably arranged, and admirably cheap."—*Leeds Mercury.*
- "A concise, cheap, and complete epitome of the English law. So plainly written that he who runs may read, and he who reads may understand."—*Figaro.*
- "A dictionary of legal facts well put together. The book is a very useful one."—*Spectator.*

THE PAWNBROKER'S, FACTOR'S, AND MERCHANT'S GUIDE TO THE LAW OF LOANS AND PLEDGES.

With the Statutes and a Digest of Cases. By H. C. FOLKARD, Barrister-at-Law. Cloth 3/6

LABOUR CONTRACTS.

A Popular Handbook on the Law of Contracts for Works and Services. By DAVID GIBBONS. Fourth Edition, with Appendix of Statutes by T. F. UTTLEY, Solicitor. Fcap. 8vo, cloth 3/6

SUMMARY OF THE FACTORY AND WORKSHOP ACTS

(1878-1891). For the Use of Manufacturers and Managers. By EMILE GARCKE and J. M. FELS. (Reprinted from "FACTORY ACCOUNTS.") Crown 8vo, sewed 6s.

WEALE'S SERIES

OF

SCIENTIFIC AND TECHNICAL WORKS.

“It is not too much to say that no books have ever proved more popular with or more useful to young engineers and others than the excellent treatises comprised in WEALE'S SERIES.”—**Engineer.**

A New Classified List.

| PAGE | PAGE |
|---|--|
| CIVIL ENGINEERING AND SURVEYING 2 | ARCHITECTURE AND BUILDING 6 |
| MINING AND METALLURGY 3 | INDUSTRIAL AND USEFUL ARTS. 9 |
| MECHANICAL ENGINEERING 4 | AGRICULTURE, GARDENING, ETC. 10 |
| NAVIGATION, SHIPBUILDING, ETC. 5 | MATHEMATICS, ARITHMETIC, ETC. 12 |
| BOOKS OF REFERENCE AND MISCELLANEOUS VOLUMES 14 | |



CROSBY LOCKWOOD AND SON,
7, STATIONERS' HALL COURT, LONDON, E.C.

1902.

CIVIL ENGINEERING & SURVEYING.

Civil Engineering.

By HENRY LAW, M.Inst.C.E. Including a Treatise on HYDRAULIC ENGINEERING by G. R. BURNELL, M.I.C.E. Seventh Edition, revised, with LARGE ADDITIONS by D. K. CLARK, M.I.C.E. 6/6

Pioneer Engineering:

A Treatise on the Engineering Operations connected with the Settlement of Waste Lands in New Countries. By EDWARD DOBSON, M.Inst.C.E. With numerous Plates. Second Edition 4/6

Iron Bridges of Moderate Span:

Their Construction and Erection. By HAMILTON W. PENDRED. With 40 Illustrations 2/0

Iron and Steel Bridges and Viaducts.

A Practical Treatise upon their Construction for the use of Engineers, Draught-men, and Students. By FRANCIS CAMPIN, C.E. With numerous Illustrations 3/6

Constructional Iron and Steel Work,

As applied to Public, Private, and Domestic Buildings. By FRANCIS CAMPIN, C.E. 3/6

Tubular and other Iron Girder Bridges.

Describing the Britannia and Conway Tubular Bridges. By G. DRYSDALE DEMPSEY, C.E. Fourth Edition 2/0

Materials and Construction:

A Theoretical and Practical Treatise on the Strains, Designing, and Erection of Works of Construction. By FRANCIS CAMPIN, C.E. 3/0

Sanitary Work in the Smaller Towns and in Villages.

By CHARLES SLAGG, Assoc. M.Inst.C.E. Third Edition 3/0

Roads and Streets (The Construction of).

In Two Parts: I. THE ART OF CONSTRUCTING COMMON ROADS, by H. LAW, C.E., Revised by D. K. CLARK, C.E.; II. RECENT PRACTICE: Including Pavements of Wood, Asphalte, &c. By D. K. CLARK, C.E. 4/6

Gas Works (The Construction of),

And the Manufacture and Distribution of Coal Gas. By S. HUGHES, C.E. Re-written by WILLIAM RICHARDS, C.E. Eighth Edition 5/6

Water Works

For the Supply of Cities and Towns. With a Description of the Principal Geological Formations of England as influencing Supplies of Water. By SAMUEL HUGHES, F.G.S., C.E. Enlarged Edition 4/0

The Power of Water,

As applied to drive Flour Mills, and to give motion to Turbines and other Hydrostatic Engines. By JOSEPH GLYNN, F.R.S. New Edition 2/0

Wells and Well-Sinking.

By JOHN GEO. SWINDELL, A.R.I.B.A., and G. R. BURNELL, C.E. Revised Edition. With a New Appendix on the Qualities of Water. Illustrated 2/0

The Drainage of Lands, Towns, and Buildings.

By G. D. DEMPSEY, C.E. Revised, with large Additions on Recent Practice, by D. K. CLARK, M.I.C.E. Third Edition 4/6

The Blasting and Quarrying of Stone,

For Building and other Purposes. With Remarks on the Blowing up of Bridges. By Gen. Sir J. BURGUYNE, K.C.B. 1/6

Foundations and Concrete Works.

With Practical Remarks on Footings, Planking, Sand, Concrete, Béton, Pile-driving, Caissons, and Cofferdams. By E. DOBSON, M.R.I.B.A. Eighth Edition 1/6

Pneumatics,

Including Acoustics and the Phenomena of Wind Currents, for the Use of Beginners. By CHARLES TOMLINSON, F.R.S. Fourth Edition . 1/6

Land and Engineering Surveying.

For Students and Practical Use. By T. BAKER, C.E. Eighteenth Edition, Revised and Extended by F. E. DIXON, A.M. Inst. C.E., Professional Associate of the Institution of Surveyors. With numerous Illustrations and two Lithographic Plates *Just published* 2/0

Mensuration and Measuring.

For Students and Practical Use. With the Mensuration and Levelling of Land for the purposes of Modern Engineering. By T. BAKER, C.E. New Edition by E. NUGENT, C.E. 1/6

MINING AND METALLURGY.

Mining Calculations,

For the use of Students Preparing for the Examinations for Colliery Managers' Certificates, comprising numerous Rules and Examples in Arithmetic, Algebra, and Mensuration. By T. A. O'DONAHUE, M.E., First-Class Certificated Colliery Manager. *Just published.* 3/6

Mineralogy,

Rudiments of. By A. RAMSAY, F.G.S. Fourth Edition, revised and enlarged. Woodcuts and Plates 3/6

Coal and Coal Mining,

A Rudimentary Treatise on. By the late Sir WARINGTON W. SMYTH, F.R.S. Eighth Edition, revised by T. FORSTER BROWN 3/6

Metallurgy of Iron.

Containing Methods of Assay, Analyses of Iron Ores, Processes of Manufacture of Iron and Steel, &c. By H. BAUERMAN, F.G.S. With numerous Illustrations. Sixth Edition, revised and enlarged 5/0

The Mineral Surveyor and Valuer's Complete Guide.

By W. LINTERN. Fourth Edition, with an Appendix on Magnetic and Angular Surveying 3/6

Slate and Slate Quarrying:

Scientific, Practical, and Commercial. By D. C. DAVIES, F.G.S. With numerous Illustrations and Folding Plates. Fourth Edition . . . 3/0

A First Book of Mining and Quarrying,

With the Sciences connected therewith, for Primary Schools and Self Instruction. By J. H. COLLINS, F.G.S. Second Edition 1/6

Subterraneous Surveying,

With and without the Magnetic Needle. By T. FENWICK and T. BAKER, C.E. Illustrated 2/6

Mining Tools.

Manual of. By WILLIAM MORGANS, Lecturer on Practical Mining at the Bristol School of Mines 2/6

Mining Tools, Atlas

Of Engravings to Illustrate the above, containing 235 Illustrations of Mining Tools, drawn to Scale. 4to 4/6

Physical Geology,

Partly based on Major-General PORTLOCK's "Rudiments of Geology." By RALPH TATE, A.L.S., &c. Woodcuts 2/0

Historical Geology,

Partly based on Major-General PORTLOCK's "Rudiments." By RALPH TATE, A.L.S., &c. Woodcuts 2/6

Geology, Physical and Historical.

Consisting of "Physical Geology," which sets forth the Leading Principles of the Science; and "Historical Geology," which treats of the Mineral and Organic Conditions of the Earth at each successive epoch. By RALPH TATE, F.G.S. 4/6

MECHANICAL ENGINEERING.

- The Workman's Manual of Engineering Drawing.**
By JOHN MAXTON, Instructor in Engineering Drawing, Royal Naval College, Greenwich. Seventh Edition. 300 Plates and Diagrams . 3/6
- Fuels: Solid, Liquid, and Gaseous.**
Their Analysis and Valuation. For the Use of Chemists and Engineers. By H. J. PHILLIPS, F.C.S., formerly Analytical and Consulting Chemist to the Great Eastern Railway. Third Edition 2/0
- Fuel, Its Combustion and Economy.**
Consisting of an Abridgment of "A Treatise on the Combustion of Coal and the Prevention of Smoke." By C. W. WILLIAMS, A.I.C.E. With Extensive Additions by D. K. CLARK, M.Inst.C.E. Fourth Edition . 3/6
- The Boilermaker's Assistant**
In Drawing, Templating, and Calculating Boiler Work, &c. By J. COURTNEY, Practical Boilermaker. Edited by D. K. CLARK, C.E. . 2/0
- The Boiler-Maker's Ready Reckoner,**
With Examples of Practical Geometry and Templating for the Use of Platers, Smiths, and Riveters. By JOHN COURTNEY. Edited by D. K. CLARK, M.I.C.E. Fourth Edition 4/0
- ** *The last two Works in One Volume, half-bound, entitled "THE BOILER-MAKER'S READY-RECKONER AND ASSISTANT."* By J. COURTNEY and D. K. CLARK. Price 7/0.
- Steam Boilers:**
Their Construction and Management. By R. ARMSTRONG, C.E. Illustrated 1/6
- Steam and Machinery Management.**
A Guide to the Arrangement and Economical Management of Machinery. By M. POWIS BALE, M.Inst.M.E. 2/6
- Steam and the Steam Engine,**
Stationary and Portable. Being an Extension of the Treatise on the Steam Engine of Mr. J. SEWELL. By D. K. CLARK, C.E. Fourth Edition 3/6
- The Steam Engine,**
A Treatise on the Mathematical Theory of, with Rules and Examples for Practical Men. By T. BAKER, C.E. 1/6
- The Steam Engine.**
By Dr. LARDNER. Illustrated 1/6
- Locomotive Engines,**
By G. D. DEMPSEY, C.E. With large Additions treating of the Modern Locomotive, by D. K. CLARK, M.Inst.C.E. 3/0
- Locomotive Engine-Driving.**
A Practical Manual for Engineers in charge of Locomotive Engines. By MICHAEL REYNOLDS. Tenth Edition. 3s. 6d. limp; cloth boards . 4/6
- Stationary Engine-Driving.**
A Practical Manual for Engineers in charge of Stationary Engines. By MICHAEL REYNOLDS. Sixth Edition. 3s. 6d. limp; cloth boards . 4/6
- The Smithy and Forge.**
Including the Farrier's Art and Coach Smithing. By W. J. E. CRANE. Fourth Edition 2/6
- Modern Workshop Practice,**
As applied to Marine, Land, and Locomotive Engines, Floating Docks, Dredging Machines, Bridges, Ship-building, &c. By J. G. WINTON. Fourth Edition, Illustrated 3/6
- Mechanical Engineering.**
Comprising Metallurgy, Moulding, Casting, Forging, Tools, Workshop Machinery, Mechanical Manipulation, Manufacture of the Steam Engine, &c. By FRANCIS CAMPIN, C.E. Third Edition 2/6
- Details of Machinery.**
Comprising Instructions for the Execution of various Works in Iron in the Fitting-Shop, Foundry, and Boiler-Yard. By FRANCIS CAMPIN, C.E. 3/0

Elementary Engineering:

A Manual for Young Marine Engineers and Apprentices. In the Form of Questions and Answers on Metals, Alloys, Strength of Materials, &c. By J. S. BREWER. Fourth Edition 1/6

Power in Motion:

Horse-power Motion, Toothed-Wheel Gearing, Long and Short Driving Bands, Angular Forces, &c. By JAMES ARMOUR, C.E. Third Edition 2/0

Iron and Heat,

Exhibiting the Principles concerned in the Construction of Iron Beams, Pillars, and Girders. By J. ARMOUR, C.E. 2/6

Practical Mechanism,

And Machine Tools. By T. BAKER, C.E. With Remarks on Tools and Machinery, by J. NASMYTH, C.E. 2/6

Mechanics:

Being a concise Exposition of the General Principles of Mechanical Science, and their Applications. By CHARLES TOMLINSON, F.R.S. 1/6

Cranes (The Construction of),

And other Machinery for Raising Heavy Bodies for the Erection of Buildings, &c. By JOSEPH GLYNN, F.R.S. 1/6

NAVIGATION, SHIPBUILDING, ETC.**The Sailor's Sea Book:**

A Rudimentary Treatise on Navigation. By JAMES GREENWOOD, B.A. With numerous Woodcuts and Coloured Plates. New and enlarged Edition. By W. H. ROSSER 2/6

Practical Navigation.

Consisting of THE SAILOR'S SEA-BOOK, by JAMES GREENWOOD and W. H. ROSSER; together with Mathematical and Nautical Tables for the Working of the Problems, by HENRY LAW, C.E., and Prof. J. R. YOUNG. 7/0

Navigation and Nautical Astronomy,

In Theory and Practice. By Prof. J. R. YOUNG. New Edition. 2/6

Mathematical Tables,

For Trigonometrical, Astronomical, and Nautical Calculations; to which is prefixed a Treatise on Logarithms. By H. LAW, C.E. Together with a Series of Tables for Navigation and Nautical Astronomy. By Professor J. R. YOUNG. New Edition 4/0

Masting, Mast-Making, and Rigging of Ships.

Also Tables of Spars, Rigging, Blocks; Chain, Wire, and Hemp Ropes, &c., relative to every class of vessels. By ROBERT KIPPING, N.A. . 2/0

Sails and Sail-Making.

With Draughting, and the Centre of Effort of the Sails. By ROBERT KIPPING, N.A. 2/6

Marine Engines and Steam Vessels.

By R. MURRAY, C.E. Eighth Edition, thoroughly revised, with Additions by the Author and by GEORGE CARLISLE, C.E. 4/6

Naval Architecture:

An Exposition of Elementary Principles. By JAMES PEAKE 3/6

Ships for Ocean and River Service,

Principles of the Construction of. By HAKON A. SOMMERFELDT . 1/6

Atlas of Engravings

To Illustrate the above. Twelve large folding Plates. Royal 4to, cloth 7/6

The Forms of Ships and Boats.

By W. BLAND. Ninth Edition, with numerous Illustrations and Models 1/6

**ARCHITECTURE AND THE
BUILDING ARTS.**

Constructional Iron and Steel Work,

As applied to Public, Private, and Domestic Buildings. By FRANCIS CAMPIN, C.E. 3/6

Building Estates :

A Treatise on the Development, Sale, Purchase, and Management of Building Land. By F. MAITLAND. Third Edition 2/0

The Science of Building :

An Elementary Treatise on the Principles of Construction. By E. WYNHAM TARN, M.A. Lond. Fourth Edition 3/6

The Art of Building :

General Principles of Construction, Strength, and Use of Materials, Working Drawings, Specifications, &c. By EDWARD DOBSON, M.R.I.B.A. 2/0

A Book on Building,

Civil and Ecclesiastical. By Sir EDMUND BECKETT, Q.C. (Lord GRIMTHORPE). Second Edition 4/6

Dwelling-Houses (The Erection of),

Illustrated by a Perspective View, Plans, and Sections of a Pair of Villas, with Specification, Quantities, and Estimates. By S. H. BROOKS, Architect 2/6

Cottage Building.

By C. BRUCE ALLEN. Eleventh Edition, with Chapter on Economic Cottages for Allotments, by E. E. ALLEN, C.E. 2/0

Acoustics in Relation to Architecture and Building :

The Laws of Sound as applied to the Arrangement of Buildings. By Professor T. ROGER SMITH, F.R.I.B.A. New Edition, Revised 1/6

The Rudiments of Practical Bricklaying.

General Principles of Bricklaying ; Arch Drawing, Cutting, and Setting ; Pointing ; Paving, Tiling, &c. By ADAM HAMMOND. With 68 Woodcuts 1/6

The Art of Practical Brick Cutting and Setting.

By ADAM HAMMOND. With 90 Engravings 1/6

Brickwork :

A Practical Treatise, embodying the General and Higher Principles of Bricklaying, Cutting and Setting ; with the Application of Geometry to Roof Tiling, &c. By F. WALKER 1/6

Bricks and Tiles,

Rudimentary Treatise on the Manufacture of ; containing an Outline of the Principles of Brickmaking. By E. DOBSON, M.R.I.B.A. Additions by C. TOMLINSON, F.R.S. Illustrated 3/0

The Practical Brick and Tile Book.

Comprising : BRICK AND TILE MAKING, by E. DOBSON, M.INST.C.E. ; PRACTICAL BRICKLAYING, by A. HAMMOND ; BRICK-CUTTING AND SETTING, by A. HAMMOND. 550 pp. with 270 Illustrations, half-bound 6/0

Carpentry and Joinery—

THE ELEMENTARY PRINCIPLES OF CARPENTRY. Chiefly composed from the Standard Work of THOMAS TREGOLD, C.E. With Additions, and TREATISE ON JOINERY, by E. W. TARN, M.A. Seventh Edition 3/6

Carpentry and Joinery—Atlas

Of 35 Plates to accompany and Illustrate the foregoing book. With Descriptive Letterpress. 4to 6/0

- A Practical Treatise on Handrailing;**
Showing New and Simple Methods. By GEO. COLLINGS. Second Edition, Revised, including a TREATISE ON STAIRBUILDING. With Plates . . . 2/6
- Circular Work in Carpentry and Joinery.**
A Practical Treatise on Circular Work of Single and Double Curvature. By GEORGE COLLINGS. Third Edition 2/6
- Roof Carpentry:**
Practical Lessons in the Framing of Wood Roofs. For the Use of Working Carpenters. By GEO. COLLINGS 2/0
- The Construction of Roofs of Wood and Iron;**
Deduced chiefly from the Works of Robison, Tredgold, and Humber. By E. WYNDHAM TARN, M.A., Architect. Third Edition 1/6
- The Joints Made and Used by Builders.**
By WYVILL J. CHRISTY, Architect. With 160 Woodcuts 3/0
- Shoring**
And its Application: A Handbook for the Use of Students. By GEORGE H. BLAGROVE. With 31 Illustrations 1/6
- The Timber Importer's, Timber Merchant's, and Builder's Standard Guide.**
By R. E. GRANDY 2/0
- Plumbing:**
A Text-Book to the Practice of the Art or Craft of the Plumber. With Chapters upon House Drainage and Ventilation. By WM. PATON BUCHAN. Eighth Edition, Re-written and Enlarged, with 500 Illustrations . . . 3/6
- Ventilation:**
A Text Book to the Practice of the Art of Ventilating Buildings. By W. P. BUCHAN, R.P., Author of "Plumbing," &c. With 170 Illustrations 3/6
- The Practical Plasterer:**
A Compendium of Plain and Ornamental Plaster Work. By W. KEMP 2/0
- House Painting, Graining, Marbling, & Sign Writing.**
With a Course of Elementary Drawing, and a Collection of Useful Receipts. By ELLIS A. DAVIDSON. Eighth Edition. Coloured Plates 5/0
** The above, in cloth boards, strongly bound, 6/0
- A Grammar of Colouring,**
Applied to Decorative Painting and the Arts. By GEORGE FIELD. New Edition, enlarged, by ELLIS A. DAVIDSON. With Coloured Plates . . . 3/0
- Elementary Decoration**
As applied to Dwelling Houses, &c. By JAMES W. FACEY. Illustrated 2/0
- Practical House Decoration.**
A Guide to the Art of Ornamental Painting, the Arrangement of Colours in Apartments, and the Principles of Decorative Design. By JAMES W. FACEY 2/6
** The last two Works in One handsome Vol., half-bound, entitled "HOUSE DECORATION, ELEMENTARY AND PRACTICAL," price 5/0.
- Portland Cement for Users.**
By HENRY FAIJA, A.M.Inst.C.E. Third Edition, Corrected 2/0
- Limes, Cements, Mortars, Concretes, Mastics, Plastering, &c.**
By G. R. BURNELL C.E. Fifteenth Edition 1/6

Masonry and Stone-Cutting.

The Principles of Masonic Projection and their application to Construction
By EDWARD DOBSON, M.R.I.B.A. 2/6

Arches, Piers, Buttresses, &c.:

Experimental Essays on the Principles of Construction. By W. BLAND. 1/6

Quantities and Measurements,

In Bricklayers', Masons', Plasterers', Plumbers', Painters', Paperhangers',
Gilders', Smiths', Carpenters' and Joiners' Work. By A. C. BEATON 1/6

The Complete Measurer:

Setting forth the Measurement of Boards, Glass, Timber and Stone. By R.
HORTON. Sixth Edition 4/0

*** The above, strongly bound in leather, price 5/0.*

Light:

An Introduction to the Science of Optics. Designed for the Use of Students
of Architecture, Engineering, and other Applied Sciences. By E. WYND-
HAM TARN, M.A., Author of "The Science of Building," &c. 1/6

Hints to Young Architects.

By GEORGE WIGHTWICK, Architect. Sixth Edition, revised and enlarged
by G. HUSKISSON GUILLAUME, Architect 3/6

Architecture—Orders:

The Orders and their Aesthetic Principles. By W. H. LEEDS. Illustrated. 1/6

Architecture—Styles:

The History and Description of the Styles of Architecture of Various
Countries, from the Earliest to the Present Period. By T. TALBOT BURY,
F.R.I.B.A. Illustrated 2/0

*** ORDERS AND STYLES OF ARCHITECTURE, in One Vol., 3/6.*

Architecture—Design:

The Principles of Design in Architecture, as deducible from Nature and
exemplified in the Works of the Greek and Gothic Architects. By EDW.
LACY GARBETT, Architect. Illustrated 2/6

*** The three preceding Works in One handsome Vol., half bound, entitled
"MODERN ARCHITECTURE," price 6/0.*

Perspective for Beginners.

Adapted to Young Students and Amateurs in Architecture, Painting, &c.
By GEORGE PYNE 2/0

Architectural Modelling in Paper.

By T. A. RICHARDSON. With Illustrations, engraved by O. JEWITT 1/6

Glass Staining, and the Art of Painting on Glass.

From the German of Dr. GESSERT and EMANUEL OTTO FROMBERG. With
an Appendix on THE ART OF ENAMELLING 2/6

Vitruvius—The Architecture of.

In Ten Books. Translated from the Latin by JOSEPH GWILT, F.S.A.,
F.R.A.S. With 23 Plates 5/0

N.B.—This is the only Edition of VITRUVIUS procurable at a moderate price.

Grecian Architecture,

An Inquiry into the Principles of Beauty in. With an Historical View of the
Rise and Progress of the Art in Greece. By the EARL OF ABERDEEN 1/0

*** The two preceding Works in One handsome Vol., half bound, entitled
"ANCIENT ARCHITECTURE," price 6/0.*

INDUSTRIAL AND USEFUL ARTS.

Cements, Pastes, Glues, and Gums.

A Guide to the Manufacture and Application of Agglutinants. With 900 Recipes and Formulæ. By H. C. STANDAGE 2/0

Clocks and Watches, and Bells,

A Rudimentary Treatise on. By Sir EDMUND BECKETT, Q.C. (Lord GRIMTHORPE). Seventh Edition. 4/6

Electro-Metallurgy,

Practically Treated. By ALEXANDER WATT. Tenth Edition, enlarged and revised including the most Recent Processes 3/6

The Goldsmith's Handbook.

Containing full Instructions in the Art of Alloying, Melting, Reducing, Colouring, Collecting and Refining, Recovery of Waste, Solders, Enamels, &c., &c. By GEORGE E. GEE. Fifth Edition 3/0

The Silversmith's Handbook,

On the same plan as the GOLDSMITH'S HANDBOOK. By G. E. GEE. 3/0
* * * *The last two Works, in One handsome Vol., half-bound, 7/0.*

The Hall-Marking of Jewellery.

Comprising an account of all the different Assay Towns of the United Kingdom; with the Stamps and Laws relating to the Standards and Hall Marks at the various Assay Offices. By GEORGE E. GEE 3/0

French Polishing and Enamelling.

A Practical Work of Instruction, including numerous Recipes for making Polishes, Varnishes, Glaze-Lacquers, &c. By R. BITMEAD 1/6

Practical Organ Building.

By W. E. DICKSON, M.A. Second Edition, Revised, with Additions 2/6

Coach-Building:

A Practical Treatise. By JAMES W. BURGESS. With 57 Illustrations 2/6

The Cabinet-Maker's Guide

To the Entire Construction of Cabinet-Work. By R. BITMEAD 2/6

The Brass Founder's Manual:

Instructions for Modelling, Pattern Making, &c. By W. GRAHAM 2/0

The Sheet-Metal Worker's Guide.

A Practical Handbook for Tinsmiths, Coppersmiths, Zincworkers, &c., with 46 Diagrams. By W. J. E. CRANE. Third Edition, revised 1/6

Sewing Machinery:

Its Construction, History, &c. With full Technical Directions for Adjusting, &c. By J. W. URQUHART, C.E. 2/0

Gas Fitting:

A Practical Handbook. By JOHN BLACK. New Edition 2/6

Construction of Door Locks.

From the Papers of A. C. HOBBS. Edited by C. TOMLINSON, F.R.S. 2/6

The Model Locomotive Engineer, Fireman, and Engine-Boy.

By MICHAEL REYNOLDS 3/6

The Art of Letter Painting made Easy.

By J. G. BADENOCH. With 12 full-page Engravings of Examples 1/6

The Art of Boot and Shoemaking.

Including Measurement, Last-fitting, Cutting-out, Closing and Making. By JOHN BRADFORD LENO. With numerous Illustrations. Fourth Edition 2/0

Mechanical Dentistry:

A Practical Treatise on the Construction of the Various Kinds of Artificial Dentures. By CHARLES HUNTER. Fourth Edition 3/0

Wood Engraving:

A Practical and Easy Introduction to the Art. By W. N. BROWN 1/9

Laundry Management.

A Handbook for Use in Private and Public Laundries 2/0

AGRICULTURE, GARDENING, ETC.

- Draining and Embanking:**
A Practical Treatise. By Prof. JOHN SCOTT. With 68 Illustrations 1/6
- Irrigation and Water Supply:**
A Practical Treatise on Water Meadows, Sewage Irrigation, Warping, &c.; on the Construction of Wells, Ponds, Reservoirs, &c. By Prof. JOHN SCOTT. With 34 Illustrations 1/6
- Farm Roads, Fences, and Gates:**
A Practical Treatise on the Roads, Tramways, and Waterways of the Farm; the Principles of Enclosures; and the different kinds of Fences, Gates, and Stiles. By Prof. JOHN SCOTT. With 75 Illustrations . 1/6
- Farm Buildings:**
A Practical Treatise on the Buildings necessary for various kinds of Farms, their Arrangement and Construction, with Plans and Estimates. By Prof. JOHN SCOTT. With 105 Illustrations 2/0
- Barn Implements and Machines:**
Treating of the Application of Power and Machines used in the Threshing-barn, Stockyard, Dairy, &c. By Prof. J. SCOTT. With 123 Illustrations. 2/0
- Field Implements and Machines:**
With Principles and Details of Construction and Points of Excellence, their Management, &c. By Prof. JOHN SCOTT. With 138 Illustrations 2/0
- Agricultural Surveying:**
A Treatise on Land Surveying, Levelling, and Setting-out; with Directions for Valuing Estates. By Prof. J. SCOTT. With 62 Illustrations . 1/6
- Farm Engineering.**
By Professor JOHN SCOTT. Comprising the above Seven Volumes in One, 1,150 pages, and over 600 Illustrations. Half-bound 12/0
- Outlines of Farm Management.**
Treating of the General Work of the Farm; Stock; Contract Work; Labour, &c. By R. SCOTT BURN 2/6
- Outlines of Landed Estates Management.**
Treating of the Varieties of Lands, Methods of Farming, Setting-out of Farms, Roads, Fences, Gates, Drainage, &c. By R. SCOTT BURN. 2/6
** The above Two Vols. in One, handsomely half-bound, price 6/0
- Soils, Manures, and Crops.**
(Vol. I. OUTLINES OF MODERN FARMING.) By R. SCOTT BURN . 2/0
- Farming and Farming Economy.**
(Vol. II. OUTLINES OF MODERN FARMING.) By R. SCOTT BURN 3/0
- Stock: Cattle, Sheep, and Horses.**
(Vol. III. OUTLINES OF MODERN FARMING.) By R. SCOTT BURN 2/6
- Dairy, Pigs, and Poultry.**
(Vol. IV. OUTLINES OF MODERN FARMING.) By R. SCOTT BURN 2/0
- Utilization of Sewage, Irrigation, and Reclamation of Waste Land.**
(Vol. V. OUTLINES OF MODERN FARMING.) By R. SCOTT BURN . 2/6
- Outlines of Modern Farming.**
By R. SCOTT BURN. Consisting of the above Five Volumes in One, 1,250 pp., profusely Illustrated, half-bound 12/0

- Book-keeping for Farmers and Estate Owners.**
 A Practical Treatise, presenting, in Three Plans, a System adapted for all classes of Farms. By J. M. WOODMAN. Third Edition, revised . 2/6
- Ready Reckoner for the Admeasurement of Land.**
 By A. ARMAN. Fourth Edition, revised and extended by C. NORRIS 2/0
- Miller's, Corn Merchant's, and Farmer's Ready Reckoner.**
 Second Edition, revised, with a Price List of Modern Flour Mill Machinery, by W. S. HUTTON, C.E. 2/0
- The Hay and Straw Measurer.**
 New Tables for the Use of Auctioneers, Valuers, Farmers, Hay and Straw Dealers, &c. By JOHN STEELE 2/0
- Meat Production.**
 A Manual for Producers, Distributors, and Consumers of Butchers' Meat. By JOHN EWART 2/6
- Sheep:**
 The History, Structure, Economy, and Diseases of. By W. C. SPOONER, M.R.V.S. Fifth Edition, with fine Engravings. 3/6
- Market and Kitchen Gardening.**
 By C. W. SHAW, late Editor of "Gardening Illustrated" 3/0
- Kitchen Gardening Made Easy.**
 Showing the best means of Cultivating every known Vegetable and Herb, &c., with directions for management all the year round. By GEORGE M. F. GLENNY. Illustrated 1/6
- Cottage Gardening:**
 Or Flowers, Fruits, and Vegetables for Small Gardens. By E. HOBDAV. 1/6
- Garden Receipts.**
 Edited by CHARLES W. QUIN 1/6
- Fruit Trees,**
 The Scientific and Profitable Culture of. From the French of M. DU BREUIL. Fifth Edition, carefully Revised by GEORGE GLENNY. With 187 Woodcuts 3/6
- The Tree Planter and Plant Propagator:**
 With numerous Illustrations of Grafting, Layering, Budding, Implements, Houses, Pits, &c. By SAMUEL WOOD 2/0
- The Tree Pruner:**
 A Practical Manual on the Pruning of Fruit Trees, Shrubs, Climbers, and Flowering Plants. With numerous Illustrations. By SAMUEL WOOD 1/6
 ** The above Two Vols. in One, handsomely half-bound, price 3/6.
- The Art of Grafting and Budding.**
 By CHARLES BALTET. With Illustrations 2/6

MATHEMATICS, ARITHMETIC, ETC.

Descriptive Geometry,

An Elementary Treatise on; with a Theory of Shadows and of Perspective, extracted from the French of G. MONGE. To which is added a Description of the Principles and Practice of Isometrical Projection. By J. F. HEATHER, M.A. With 14 Plates 2/0

Practical Plane Geometry :

Giving the Simplest Modes of Constructing Figures contained in one Plane and Geometrical Construction of the Ground. By J. F. HEATHER, M.A. With 215 Woodcuts 2/0

Analytical Geometry and Conic Sections,

A Rudimentary Treatise on. By JAMES HANN. A New Edition, re-written and enlarged by Professor J. R. YOUNG 2/0

Euclid (The Elements of).

With many Additional Propositions and Explanatory Notes; to which is prefixed an Introductory Essay on Logic. By HENRY LAW, C.E. 2/6

*** Sold also separately, viz :—*

Euclid. The First Three Books. By HENRY LAW, C.E. 1/6

Euclid. Books 4, 5, 6, 11, 12. By HENRY LAW, C.E. 1/6

Plane Trigonometry,

The Elements of. By JAMES HANN. 1/6

Spherical Trigonometry,

The Elements of. By JAMES HANN. Revised by CHARLES H. DOWLING, C.E. 1/0

*** Or with "The Elements of Plane Trigonometry," in One Volume, 2/6*

Differential Calculus,

Elements of the. By W. S. B. WOOLHOUSE, F.R.A.S., &c. 1/6

Integral Calculus.

By HOMERSHAM COX, B.A. 1/6

Algebra,

The Elements of. By JAMES HADDON, M.A. With Appendix, containing Miscellaneous Investigations, and a Collection of Problems 2/0

A Key and Companion to the Above.

An extensive Repository of Solved Examples and Problems in Algebra. By J. R. YOUNG 1/6

Commercial Book-keeping.

With Commercial Phrases and Forms in English, French, Italian, and German. By JAMES HADDON, M.A. 1/6

Arithmetic,

A Rudimentary Treatise on. With full Explanations of its Theoretical Principles, and numerous Examples for Practice. For the Use of Schools and for Self-Instruction. By J. R. YOUNG, late Professor of Mathematics in Belfast College. Thirteenth Edition 1/6

A Key to the Above.

By J. R. YOUNG 1/6

Equational Arithmetic,

Applied to Questions of Interest, Annuities, Life Assurance, and General Commerce; with various Tables by which all Calculations may be greatly facilitated. By W. HIPSLEY 1/6

Arithmetic,

Rudimentary, for the Use of Schools and Self-Instruction. By JAMES HADDON, M.A. Revised by ABRAHAM ARMAN 1/6

A Key to the Above.

By A. ARMAN 1/6

Mathematical Instruments :

Their Construction, Adjustment, Testing, and Use concisely Explained. By J. F. HEATHER, M.A., of the Royal Military Academy, Woolwich. Fourteenth Edition, Revised, with Additions, by A. T. WALMSLEY, M.I.C.E. Original Edition, in 1 vol., Illustrated 2/0

* * * *In ordering the above, be careful to say "Original Edition," or give the number in the Series (32), to distinguish it from the Enlarged Edition in 3 vols. (as follows)—*

Drawing and Measuring Instruments.

Including—I. Instruments employed in Geometrical and Mechanical Drawing, and in the Construction, Copying, and Measurement of Maps and Plans. II. Instruments used for the purposes of Accurate Measurement, and for Arithmetical Computations. By J. F. HEATHER, M.A. 1/6

Optical Instruments.

Including (more especially) Telescopes, Microscopes, and Apparatus for producing copies of Maps and Plans by Photography. By J. F. HEATHER, M.A. Illustrated 1/6

Surveying and Astronomical Instruments.

Including—I. Instruments used for Determining the Geometrical Features of a portion of Ground. II. Instruments employed in Astronomical Observations. By J. F. HEATHER, M.A. Illustrated. 1/6

* * * *The above three volumes form an enlargement of the Author's original work, "Mathematical Instruments," price 2/0. (Described at top of page.)*

Mathematical Instruments :

Their Construction, Adjustment, Testing and Use. Comprising Drawing, Measuring, Optical, Surveying, and Astronomical Instruments. By J. F. HEATHER, M.A. Enlarged Edition, for the most part entirely re-written. The Three Parts as above, in One thick Volume. 4/6

The Slide Rule, and How to Use It.

Containing full, easy, and simple Instructions to perform all Business Calculations with unexampled rapidity and accuracy. By CHARLES HOARE, C.E. With a Slide Rule, in tuck of cover. Seventh Edition 2/6

Logarithms.

With Mathematical Tables for Trigonometrical, Astronomical, and Nautical Calculations. By HENRY LAW, C.E. Revised Edition 3/0

Compound Interest and Annuities (Theory of).

With Tables of Logarithms for the more Difficult Computations of Interest, Discount, Annuities, &c., in all their Applications and Uses for Mercantile and State Purposes. By FEDOR THOMAN, Paris. Fourth Edition 4/0

Mathematical Tables,

For Trigonometrical, Astronomical, and Nautical Calculations; to which is prefixed a Treatise on Logarithms. By H. LAW, C.E. Together with a Series of Tables for Navigation and Nautical Astronomy. By Professor J. R. YOUNG. New Edition 4/0

Mathematics,

As applied to the Constructive Arts. By FRANCIS CAMPIN, C.E., &c. Third Edition 3/0

Astronomy.

By the late Rev. ROBERT MAIN, F.R.S. Third Edition, revised and corrected to the Present Time. By W. T. LYNN, F.R.A.S. 2/0

Statics and Dynamics,

The Principles and Practice of. Embracing also a clear development of Hydrostatics, Hydrodynamics, and Central Forces. By T. BAKER, C.E. Fourth Edition 1/6

**BOOKS OF REFERENCE AND
MISCELLANEOUS VOLUMES.**

A Dictionary of Painters, and Handbook for Picture Amateurs.

Being a Guide for Visitors to Public and Private Picture Galleries, and for Art-Students, including Glossary of Terms, Sketch of Principal Schools of Painting, &c. By PHILIPPE DARYL, B.A. 2/6

Painting Popularly Explained.

By T. J. GULLICK, Painter, and JOHN TIMBS, F.S.A. Including Fresco, Oil, Mosaic, Water Colour, Water-Glass, Tempera Encaustic, Miniature, Painting on Ivory, Vellum, Pottery, Enamel, Glass, &c. Sixth Edition 5/0

A Dictionary of Terms used in Architecture, Building, Engineering, Mining, Metallurgy, Archæology, the Fine Arts, &c.

By JOHN WEALE. Sixth Edition. Edited by R. HUNT, F.R.S. . . . 5/0

Music:

A Rudimentary and Practical Treatise. With numerous Examples. By CHARLES CHILD SPENCER 2/6

Pianoforte,

The Art of Playing the. With numerous Exercises and Lessons. By CHARLES CHILD SPENCER 1/6

The House Manager.

A Guide to Housekeeping, Cookery, Pickling and Preserving, Household Work, Dairy Management, Cellarage of Wines, Home-brewing and Wine-making, Gardening, &c. By AN OLD HOUSEKEEPER 3/6

Manual of Domestic Medicine.

By R. GOODING, M.D. Intended as a Family Guide in all cases of Accident and Emergency. Third Edition, carefully revised . . . 2/0

Management of Health.

A Manual of Home and Personal Hygiene. By Rev. JAMES BAIRD 1/0

Natural Philosophy,

For the Use of Beginners. By CHARLES TOMLINSON, F.R.S. . . . 1/6

The Elementary Principles of Electric Lighting.

By ALAN A. CAMPBELL SWINTON, M.INST.C.E., M.I.E.E. Fourth Edition, Revised [Just Published 1/6

The Electric Telegraph,

Its History and Progress. By R. SABINE, C.E., F.S.A., &c. . . . 3/0

Handbook of Field Fortification.

By Major W. W. KNOLLYS, F.R.G.S. With 163 Woodcuts . . . 3/0

Logic,

Pure and Applied. By S. H. EMMENS. Third Edition 1/6

Locke on the Human Understanding,

Selections from. With Notes by S. H. EMMENS 1/6

The Compendious Calculator

(*Intuitive Calculations*). Or Easy and Concise Methods of Performing the various Arithmetical Operations required in Commercial and Business Transactions; together with Useful Tables, &c. By DANIEL O'GORMAN. Twenty-seventh Edition, carefully revised by C. NORRIS 2/6

Measures, Weights, and Moneys of all Nations.

With an Analysis of the Christian, Hebrew, and Mahometan Calendars.
By W. S. B. WOOLHOUSE, F.R.A.S., F.S.S. Seventh Edition . . . 2/6

Grammar of the English Tongue,

Spoken and Written. With an Introduction to the Study of Comparative Philology. By HYDE CLARKE, D.C.L. Fifth Edition. 1/6

Dictionary of the English Language.

As Spoken and Written. Containing above 100,000 Words. By HYDE CLARKE, D.C.L. 3/6

Complete with the GRAMMAR, 5/6.

Composition and Punctuation,

Familiarly Explained for those who have neglected the Study of Grammar. By JUSTIN BRENNAN. 18th Edition. 1/6

French Grammar.

With Complete and Concise Rules on the Genders of French Nouns. By G. L. STRAUSS, Ph.D. 1/6

English-French Dictionary.

Comprising a large number of Terms used in Engineering, Mining, &c. By ALFRED ELWES 2/0

French Dictionary.

In two Parts—I. French-English. II. English-French, complete in One Vol. 3/0

*** Or with the GRAMMAR, 4/6.*

French and English Phrase Book.

Containing Introductory Lessons, with Translations, Vocabularys of Words, Collection of Phrases, and Easy Familiar Dialogues 1/6

German Grammar.

Adapted for English Students, from Heyse's Theoretical and Practical Grammar, by Dr. G. L. STRAUSS 1/6

German Triglot Dictionary.

By N. E. S. A. HAMILTON. Part I. German-French-English. Part II. English-German-French. Part III. French-German-English . . . 3/0

German Triglot Dictionary.

(As above). Together with German Grammar, in One Volume . . . 5/0

Italian Grammar.

Arranged in Twenty Lessons, with Exercises. By ALFRED ELWES. 1/6

Italian Triglot Dictionary,

Wherein the Genders of all the Italian and French Nouns are carefully noted down. By ALFRED ELWES. Vol. I. Italian-English-French. 2/6

Italian Triglot Dictionary.

By ALFRED ELWES. Vol. II. English-French-Italian 2/6

Italian Triglot Dictionary.

By ALFRED ELWES. Vol. III. French-Italian-English 2/6

Italian Triglot Dictionary.

(As above). In One Vol. 7/6

Spanish Grammar.

In a Simple and Practical Form. With Exercises. By ALFRED ELWES 1/6

Spanish-English and English-Spanish Dictionary.

Including a large number of Technical Terms used in Mining, Engineering, &c., with the proper Accents and the Gender of every Noun. By ALFRED ELWES 4/0

*** Or with the GRAMMAR, 6/0.*

Portuguese Grammar,

In a Simple and Practical Form. With Exercises. By ALFRED ELWES 1/6

Portuguese-English and English-Portuguese Dictionary.

Including a large number of Technical Terms used in Mining, Engineering, &c., with the proper Accents and the Gender of every Noun. By ALFRED ELWES. Third Edition, revised 5/0

** Or with the GRAMMAR, 7/0.

Animal Physics,

Handbook of. By DIONYSIUS LARDNER, D.C.L. With 520 Illustrations. In One Vol. (732 pages), cloth boards 7/6

** Sold also in Two Parts, as follows:—

ANIMAL PHYSICS. By Dr. LARDNER. Part I., Chapters I.—VII. 4/0

ANIMAL PHYSICS. By Dr. LARDNER. Part II., Chapters VIII.—XVIII. 3/0



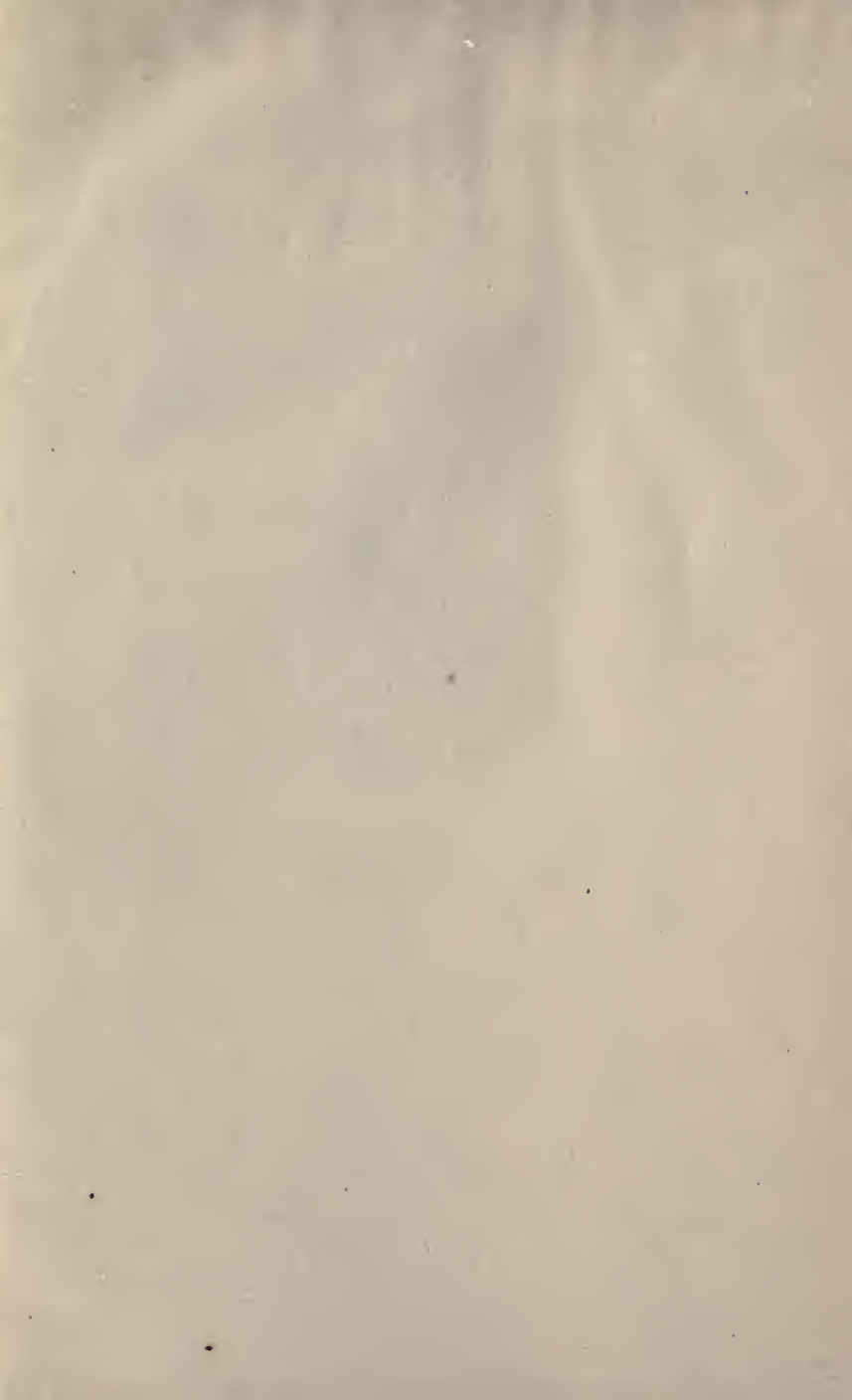

UNIVERSITY OF CALIFORNIA LIBRARY
BERKELEY

Return to desk from which borrowed.

This book is DUE on the last date stamped below.

DEC 9 1947

30 Nov '48 DL

26 Mar '49 FA

30 Mar '56 KK

MAR 16 1956 LU

6 Aug '56 HJ

JUL 23 1956 LU

YC 19580

Serrell

116780

TK145
S5

