



















# SCIENCE

---

A WEEKLY JOURNAL DEVOTED TO THE ADVANCEMENT OF SCIENCE, PUBLISHING THE OFFICIAL NOTICES AND PROCEEDINGS OF THE AMERICAN ASSOCIATION FOR THE ADVANCEMENT OF SCIENCE.

---

EDITORIAL COMMITTEE: S. NEWCOMB, Mathematics; R. S. WOODWARD, Mechanics; E. C. PICKERING, Astronomy; T. C. MENDENHALL, Physics; R. H. THURSTON, Engineering; IRA REMSEN, Chemistry; JOSEPH LE CONTE, Geology; W. M. DAVIS, Physiography; HENRY F. OSBORN, Paleontology; W. K. BROOKS, C. HART MERRIAM, Zoology; S. H. SCUDDER, Entomology; C. E. BESSEY, N. L. BRITTON, Botany; C. S. MINOT, Embryology, Histology; H. P. BOWDITCH, Physiology; J. S. BILLINGS, Hygiene; WILLIAM H. WELCH, Pathology; J. McKEEN CATTELL, Psychology; J. W. POWELL, Anthropology.

NEW SERIES. VOLUME XIII.

JANUARY-JUNE, 1901.

---

NEW YORK  
THE MACMILLAN COMPANY  
1901

---

THE NEW ERA PRINTING COMPANY,  
41 NORTH QUEEN STREET,  
LANCASTER, PA.

---



## CONTENTS AND INDEX.

N. S. VOL. XIII.—JANUARY TO JUNE, 1901.

*The Names of Contributors are Printed in Small Capitals.*

- A., J. A., Mammals of S. Africa, W. L. SCLATER, 105  
 ADAMS, F. A., George M. Dawson, 561  
 Agricultural Experiment Stations, 331  
 Agriculture, Dept. of, 257, 315; E. W. ALLEN, 572  
 ALLEN, E. W., U. S. Department of Agriculture, 572  
 American Association for the Advancement of Science, 37, 425, 705, 811, 875, 902, 961, 995  
 AMES, J. H., Henry Augustus Rowland, 681  
 AMI, H. M., Stratigraphical Note, 394; Geological Survey of Canada, D. B. DOWLING, 424; Ottawa Naturalists' Club, 469; R. Society of Canada, 1015  
 Anatomists, Association of American, D. S. LAMB, 289  
 André, Ch., *Traité d'astronomie stellaire*, E. B. FROST, 618; G. C. COMSTOCK, 746  
 ANDREWS, W. C., Amer. Inst. Electr. Engineers, 655  
 ANGELL, J. R., Monaural Localization of Sound, 775  
 Antarctic Expedition, 836; E. B. POULTON, 890  
 Anthropological Society of Washington, W. HOUGH, 305, 391, 547, 665, 786  
 Anthropology, at Baltimore, F. RUSSELL, 139; and Psychology at the N. Y. Acad. of Sci., C. H. JUDD, 309, 468; R. S. WOODWORTH, 662, 864  
 Antiquities of Michigan, Survey of, 672  
*Arbacia punctulata*, H. L. OSBORN, 938  
 Astronomy, Physics and Chemistry, N. Y. Acad. of Sci., W. S. DAY, 148, 346, 469, 866  
 ATKINSON, G. F., The Embryo-sac, 530  
 Auriferous Deposit, O. H. HERSHEY, 869  
 B., C. F., Bird Book; Woodpeckers, F. H. ECKSTORM, 658  
 B., F. A., Christian Frederik Lütken, 540  
 Baconian Club, Univ. of Iowa, C. E. SEASHORE, 826  
 Bacteriologists, Amer. Soc. of, H. W. CONN, 321  
 Bacteriology, W. T. SEDGWICK, 121  
 BAILEY, E. H. S., Kans. Acad. of Sci., 217  
 BAILEY, L. H., Botany, C. E. BESSEY, 859  
 BALDWIN, J. M., Sidgwick Memorial, 274  
 Ball, Sir R., Astronomy, F. W. VERY, 581  
 BANKS, N., Notes on Entomology, 668; Gli Insetti Nocivi, A. Lunardon, 706  
 BARBOUR, E. H., Nehr. Ornithologists' Union, 216  
 Barraclough, S. H., Steam-engine Problem, R. H. THURSTON, 619  
 BARTON, G. E., Arsenic Tests, 470  
 BARUS, C., Stroboscopic Phenomena, 128; Projection of Ripples by a Grating, 297; Particles in Saturated Emanation of Phosphorus, 501; Remarks on the Top, 852; Rotation of a Rigid Body, 914  
 BASKERVILLE, C., Elisha Mitchell Soc., 548, 666, 827  
 BATHER, F. A., Bibliographic Catch Title, 220  
 BAUER, L. A., Magnetic Observations, 746  
 BENSLEY, I. A., Australian Marsupialia, 431  
 Bergen, J. Y., Botany, C. E. BESSEY, 859  
 BESSEY, C. E., Botanical Notes, 193, 397, 472, 714, 832; Botanical Literature, 298, 859  
 Bibliographic Catch Title, E. L. MARK, 31; F. A. BATHER, 230  
 Bibliographicum Concilium, 633  
 Bibliography of Geodesy, J. H. GORE, 868  
 BIGELOW, F. H., U. S. Naval Observatory, 150; Cyclones, 589  
 Bigelow, F. H., Cloud Observations, R. DEC. WARD, 24  
 Biological, Society of Washington, F. A. LUCAS, 26, 189, 307, 392, 428, 506, 585, 711, 909; W. H. OSGOOD, 787; Laboratory, Marine, of Woods Holl, 433; C. O. WHITMAN, 538; Problems, Statistical, 673; Station, Univ. of Montana, 873; New Mexico, T. D. A. COCKERELL, 954; Lectures, Columbia Univ., J. H. MCG., 1035  
 Biology, W. H. HOWELL, 49; Section, N. Y. Acad. of Sci., F. E. LLOYD, 71, 467; H. E. CRAMPTON, 272  
 BIRGE, E. A., H. F. NACHTRIEB, and F. SMITH, State Natural History Surveys, 563; Limnological Commission, C. H. EIGENMANN, C. A. KOFOID, G. C. WHIPPLE, and H. B. WARD, 897  
 BOAS, F., The Mind of Primitive Man, 281  
 BOGUE, E. E., A Simple Osmometer, 791  
 Bolas, T., Photography in Colors, R. W. W., 109  
 BOLTON, H. C., Physics and Faith, 241  
 Bolton, H. C., The Thermometer, J. L. H., 146; Bibliography of Chemistry, J. L. HOWE, 784  
 Botanical, Club, Torrey, E. S. BURGESS, 27, 347, 586, 788, 912; Notes, C. E. BESSEY, 193, 397, 472, 714, 832; Literature, C. E. BESSEY, 298  
 Botany, Option in, Standard College Entrance, W. F. GANONG, 611; in Japan, KRICHI MIYAKE, 734  
 Boveri, T., Die Centrosomen, E. B. WILSON, 264  
 Bowers, G. M., Report of U. S. Fish Commissioner, H. C. BUMPUS, 23; M. C. MARSH, 106  
 Boyer, J., Mathematics, G. B. HALSTED, 462  
 BRITTON, N. L., Precedence in Nomenclature, 588  
 BROOKS, A. H., Cassiterite in Alaska, 593  
 Brooks, Thomas Benton, B. WILLIS, 460  
 BROOMALL, C. M., Lunar Halo, 549  
 BROWN, B. H., Constant Cross-Section, 831  
 Brühl, J. W., Pflanzen-Alkaloide, H. KRAEMER, 821  
 BUCHNER, E. F., A. KIRSCHMAN, J. R. ANGELL, A. M. BEELIE, E. D. STARBUCK, Disclaimer No. 2, 667  
 Buffalo, Wood, O. J. KLOTZ, 233  
 Bufo Agua in the Bermudas, F. C. WAITE, 342  
 BUMPUS, H. C., Report of U. S. Fish Commissioner, G. M. BOWERS, 23  
 BURGESS, E. S., Torrey Botanical Club, 27, 347, 586, 788, 912  
 C., T. D. A., Las Vegas Science Club, 191, 469, 711

- CALL, R. E., The Date of Rafinesque's Death, 548  
 Campanus, C. S. PIERCE, 809  
 CAMPBELL, W. W., Observations of Eros, 176  
 Carnegie's, Mr., Gift to Scottish Universities, 1032  
 Catalogue, International, of Scientific Literature, 76  
 CHAMBERLAIN, A. F., Seri Indians, W J McGe, 779  
 CHAPLIN, W. S., Washington University, 258  
 Chemical Society, American, 576; A. C. HALE, 104; N. Y. Section, D. WOODMAN, 191, 393, 711, 948; Washington, W. H. KRUG, 149, 308; L. S. MUNSON, 507, 664, 824, 910; N. C. Section, C. B. WILLIAMS, 899; Laboratory, E. H. KEISER, 261; Industries, W. M. McMURTRIE, 441  
 Chemistry, Inorganic, Notes on, J. L. H., 33, 313, 349, 434, 627, 831, 993; Dignity of, H. W. WILEY, 721; in the Nineteenth Century, E. H. KEISER, 803  
 CHILD, C. D., Velocity of Ions, 830  
 CHILD, C. M., Zoological Club, University of Chicago, 73, 112, 1026  
 Chougb, Alpine, P. S. SCLATER, 626; W. J. FOX, 713  
 CHURCH, J. P., Reservoirs, J. D. Schnyler, 738  
 CLARK, W. B., The State and Investigation, 81  
 CLARKE, F. W., Free Speech in Universities, 309  
 Classen, A., Chemie, H. P. TALBOT, 660  
 CLAYTON, H. H., Cyclones, 747  
 Clayton's Eclipse Cyclone, F. H. BIGELOW, 589  
 Clements, F. E., and R. Pound, Phytogeography of Nebraska, A. HOLLICK, 981  
 COCKERELL, T. D. A., Predetermined Evolution, 311; Insect Fauna of Human Excrement, L. O. Howard, 389; Penycuk Experiments, Telegony, Zebra Hybrids, J. C. Ewart, 423; Naiades, C. T. Simpson, 983; New Mexico Biological Station, 954; The Mongosee in Jamaica, 990  
 Cohnheim, O., Chemie der Eiweisskörper, L. B. MENDEL, 185  
 COLE, F. N., Amer. Mathematical Society, 102, 429  
 COMSTOCK, G. C., André's Astronomie Stellaire, 746  
 Congdon, E. A., Chemistry, H. F., 708  
 CONN, H. W., Amer. Soc. of Bacteriologists, 321  
 Convocation Week, 641, 996  
 COOK, O. F., Priority and Method of Types, 712; Kinetic Theory of Evolution, 969  
 Corona, Solar, R. W. WOOD, 179  
 CRAMPTON, H. E., Biology, N. Y. Acad. of Sci., 272, 467, 623, 865  
 Crawley, E. S., Geometry, G. B. HALSTED, 462  
 CROCKER, F. B., Gray's Talks on Science, 505  
 Crocker, F. B., Electric Lighting, E. THOMSON, 943  
 CROSS, C. R., Silas W. Holman, 857  
 DALL, W. H., Anatomie der Wirbellosen Thiere, A. Lang, 945  
 DALY, R. A., Expedition to Iceland, 192; Notes on Oceanography, 951  
 DANDENO, J. B., Freezing in Plants, 916  
 DAVENPORT, C. B., Naturalists at Chicago, 370; Resolution of Committee of Central Naturalists, 753  
 DAVIS, H. S., Astronomischer Jahresbericht, 32  
 DAVIS, W. M., Notes on Physiography, 152, 275, 351, 395, 471, 551, 628, 751, 791, 871, 950, 1032  
 DAWSON, G. M., Rocky Mountain Region in Canada, 401  
 Dawson, George M., F. A. ADAMS, 561  
 DAY, W. S., Astronomy, Physics and Chemistry, N. Y. Acad. of Sci., 148, 346, 469, 866  
 DERBY, O. A., Tertiary Sea of Southern Brazil, 348  
 Discoveries, Remarkable, 987; G. F. Wright, 1029  
 Discussion and Correspondence, 28, 75, 113, 150, 191, 230, 274, 348, 394, 431, 548, 588, 626, 666, 712, 746, 789, 827, 868, 913, 948, 987, 1029  
 DIXLOWE, C. D., Vermont Botanical Club, 230  
 DIXON, R. B., The Musical Bow in California, 274  
 DODGE, C. W., N. Y. State Science Teachers' Association, 415  
 DODGE, R. E., N. Y. Acad. of Sci., 379  
 Dodge, R. E., Physical Geography, J. P. GOODE, 907  
 DORSEY, G. A., Hopsi Expeditions, 219  
 Dowling, D. B., Geol. Survey of Canada, Index, H. M. AMI, 424  
 DURÁN-LORIGA, J. J., Charles Hermite, 883  
 DWIGHT, T., Skelet des Menschen, F. Frenkel, 145  
 Eekstorn, F. H., Bird Book; Woodpeckers, C. F. B., 658  
 Eclipse, Total Solar, 854; Artificial Representation of, R. W. WOOD, 65; Suggestions for Work at, R. W. WOOD, 179; Photography, F. E. NIPHER, 208; Cyclone, Clayton's, F. H. BIGELOW, 589; Magnetic Observations, L. A. BAUER, 746  
 EIGENMANN, C. H., and C. KENNEDY, Unilateral Coloration with Bilateral Effect, 828  
 EIMBECK, W., Miles Rock, 978  
 Electro, Chemical Laboratory, E. F. SMITH, 697; Chemist, Training of, H. C. JONES, 569  
 Embryo-sac, G. A. ATKINSON, 530  
 Engineering, Steam, U. S. Bureau of, R. H. THURSTON, 224; Education, R. H. THURSTON, 301; Association of the South, H. M. JONES, 230; In Nineteenth Century, J. L. VAN ORNUM, 771  
 Engineers, Elec., Amer. Inst. W. C. ANDREWS, 655  
 Entomology, Notes on, N. BANKS, 668  
 Enzymes, J. H. KASTLE, 765; and their application, A. F. WOODS, 822  
 Erdmann, H., Anorganische Chemie, E. RENOUF, 268  
 Eros, Observations of, W. W. CAMPBELL, 176; Variation of Light in, E. C. PICKERING, 790  
 Evolution, Predetermined, T. D. A. COCKERELL, 311; Kinetic Theory of, O. F. COOK, 969  
 Ewart, J. C., The Penycuk Experiments; Telegony; Zebra Hybrids, T. D. A. COCKERELL, 423  
 F., H., Chemical Analysis, J. F. Sellers, 707; Chemistry, E. A. Congdon, 708  
 F., W. S., Notes on Physics, 312  
 FAIRCHILD, H. LE R., Geological Soc. of Amer., 954  
 FARRAND, L., Amer. Psychological Assoc., 211  
 FERGUSON, M. C., Pollen Tube and Fertilization, 668  
 Ferments, Inorganic, H. C. JONES, 940  
 FERNOW, B. E., Forestry Legislation, 354  
 FESSENDEN, R. A., Electrical Theory of Gravitation, 28  
 FOLEY, A. L., Diamond-Glass Fluorescence, 732  
 Forest Management, V. M. SPALDING, 542  
 FOX, W. J., Alpine Chough, 713; and Egyptian Crocodile, 232  
 FRANKLIN, C. L., The Syllogism, 574  
 FRAPS, G. S., Commercial Organic Analysis, A. H. Allen and H. Leffmann, 465  
 Free Speech in Universities, F. W. CLARKE, 309  
 Frenkel, F., Skelet des Mensch. T. DWIGHT, 145  
 FROST, E. B., Representative Stellar Spectra, Sir W. Huggins, 222; Astronomie stellaire, Ch. André, 618

- G., J. E., Chemistry, J. Waddell, 304; Chemists' Pocket Manual, R. K. Meade, 708
- GALLOWAY, B. T., The State and Investigation, 81
- GANONG, W. F., Society for Plant Morphology and Physiology, 246; Standard College Entrance Option in Botany, 611
- Genera, Composite, of Animals and Plants, D. S. JORDAN, 498
- Geodesy, Progress in, J. F. HAYFORD, 381; Bibliography of, J. H. GORE, 868
- Geodetic Association, International, J. WINSTON, 129
- Geographic Names, U. S. Board on, 153
- Geographical, American, Society, 753
- Geological, Society of America, J. F. KEMP, 95, 133; of Washington, F. L. RANSOME and D. WHITE, 187, 270, 426, 508, 555, 663; H. L. FAIRCHILD, 954; U. S. Survey, 554
- GILBERT, G. K., Stereoscopic Study of the Moon, 407
- GILL, A. H., Analyse des Gaz, M. E. Pozzi Escot, 345; Gas Lighting, C. Hunt, 944
- GILL, T., Genus *Hollandia* of Karsch, 949
- GILMAN, D. C., Professor Rowland, 801
- GOFF, E. S., Seediness and Quality in Melons, 310; Hypocotyl in Indian Corn, 395
- GOODE, J. P., Physical Geography, R. E. Dodge, 907
- GORE, J. H., Topographic Surveying, H. M. Wilson, 820; Bibliography of Geodesy, 868
- Gratings, Diffraction, R. W. WOOD, 33; E. THOMSON, 114
- Gravitation, Electrical Theory, R. A. FESSENDEN, 28
- Gravity Measures, J. F. HAYFORD, 654
- Gray's Familiar Talks on Science, F. B. CROCKER, 505
- GRAY, T., Modulus of Constant Cross Section, 949
- Gregory, J. W., Fossil Bryozoa, J. M. N., 620
- Groos, K., Play of Man, O. T. M., 862
- H., J. L., Notes on Inorganic Chemistry, 33, 313, 349, 434, 627, 831, 993; The Thermometer, H. C. Bolton, 146
- HALE, A. C., American Chemical Society, 104
- HALE, G. E., New Star in Perseus, 514
- HALL, A., Motion of a Top, 948
- HALLOCK, W., American Physical Society, 101
- HALSTED, G. B., Non-Euclidean Geometry, 462
- HARPER, H. W., Immunity and Inoculation, 684
- HARRIS, G. D., Oil in Texas, 666
- Hastie, W., Kant's Cosmogony, R. M. WENLEY, 302
- Hawaiian Islands, Aquatic Resources of, 835
- HAYFORD, J. F., Geodesy, 381; Gravity Measures, 654; Philosophical Soc. of Washington, 665
- Heider, K., and E. Korschelt, Embryology of Invertebrates, F. R. L., 861
- Hellmann, G., Meteorologische Beobachtungen, A. L. ROTCH, 821
- Herman, R. A., Geometrical Optics, R. W., 505
- Hermite, Charles, J. J. DURÁN-LORIGA, 883
- HERSHEY, O. H., An Auriferous Deposit, 869
- Hickson, S. J., Aleyonium, J. P. McM., 465
- HILL, G. A., The New Comet, 827
- HILL, R. T., Geology of Texas, 226
- HITCHCOCK, R., Reversal of Photographic Image, 591
- HOBBS, W. H., Science Club, Univ. of Wisconsin, 228
- HOLGATE, T. F., Chicago Section, American Mathematical Society, 181
- Hollandia, Genus of Karsch, T. GILL, 949
- HOLLICK, A., Phytogeography of Nebraska, R. Pound and F. E. Clements, 981
- Holman, Silas W., C. R. CROSS, 857
- Hopi Expeditions, G. A. DORSEY, 219
- HOUGH, T., Physiology in the Schools, 914
- HOUGH, W., Anthropological Society of Washington, 308, 391, 547, 665, 786
- HOWARD, L. O., State and Scientific Investigation, 81; Otto Luggler, 980
- Howard, L. O., Insect Fauna of Human Excrement, T. D. A. COCKERELL, 339
- HOWE, J. L., Bibliography of Chemistry, H. C. Bolton, 784
- HOWE, M. A., Torrey Botanical Club, 986, 1028
- HOWELL, W. H., Biology in College Training, 49
- Huber, C. C., Boehm and Von Davidoff's Histology, H. McE. KNOWER, 70
- Huggins, Sir W., Representative Stellar Spectra, E. B. FROST, 222
- Hunt, C., Gas Lighting, A. H. GILL, 944
- HUNTINGTON, G. S., Morphological Museum, 601
- Hypocotyl in Indian Corn, E. S. GOFF, 395
- INGHAM, W. A., Geological Map of Europe, 349
- Inoculation, Immunity and, H. W. HARPER, 684
- Iowa, Academy of Sciences, L. H. PAMMEL, 214; Upper, University Science Club, 547
- J. J., Human Nature Club, E. Thorndike, 621
- Jacoby, H. S., Amer. Education, R. H. THURSTON, 68
- JASTROW, J., Experimental Psychology, E. B. Titchener, 741
- JENNINGS, H. S., Zoological Journal Club, Univ. of Michigan, 74, 745; Michigan Acad. of Sci., 616
- JONES, H. C., The Exact Natural Sciences, 338; The Electrochemist, 569; François Marie Raoult, 881; Inorganic Ferments, 940
- JONES, H. M., Engineering Assoc. of the South, 230
- JORDAN, D. S., Type in Composite Genera, 498
- JUDD, C. H., Anthropology and Psychology, N. Y. Acad. of Sci., 309, 468
- KAHLENBERG, L., Science Club of the Univ. of Wisconsin, 548
- KANSAS Academy of Science, E. H. S. BAILEY, 217
- KASNER, E., American Mathematical Society, 741
- KASTLE, J. H., Vital Activity of Enzymes, 765
- Keeler Memorial, F. L. O. WADSWORTH, 789
- KEISER, E. H., The Busch Chemical Laboratory, 261; Chemistry in the Nineteenth Century, 803
- KELLOGG, V. L., San Jose Scale in Japan, 383
- KEMP, J. F., Geological Society of America, 95, 133; Clays of New York, H. Ries, 946
- Kent, W., Steam boiler, R. H. THURSTON, 906
- KEYES, C. R., Crinoid Horizon, 915
- KEYSER, C. J., Trigonometry, D. A. Murray, 25
- KINGSBURY, E. F., Anatomie der Wirbelthiere, A. Oppel, 1024
- KLOTZ, O. J., The Wood Buffalo, 233
- KNIGHT, W. C., Potassium Nitrate in Wyoming, 151
- KNOWER, H. McE., Boehm and Von Davidoff's Histology, C. C. Huber, 70
- KOFOID, C. A., Deutsche Zoologische Gesellschaft, 783
- Kölliker, A., Erinnerungen, C. S. MINOT, 657
- KRAEMER, H., Pflanzen-Alkaloide, J. W. Brühl, 821
- KRUG, W. H., Chemical Soc. of Washington, 149, 308
- L., F. A., Museum Notes, 595, 834
- L., F. R., Embryology of Invertebrates, E. Korschelt and K. Heider, 861
- Laboratory Construction, Unit, C. S. MINOT, 409
- LAMB, D. S., Assoc. of American Anatomists, 289

- Lang A., Anatomie der Wirbellosen Thiere, W. H. DALL, 945
- Larynx as an Instrument of Music, J. LE CONTE, 790; A. G. WEBSTER, 827; E. W. SCRIPTURE, 913; J. WRIGHT, 1030
- Lassar-Cohn, Chemistry, W. B. SCHÖBER, 707
- Las Vegas Science Club, T. D. A. C., 191, 469, 711
- LEAVITT, R. G., Root-Hair Cells in Azolla, 1030
- LE CONTE, J., Larynx as an Instrument of Music, 790; What is Life? 991
- Leland Stanford Junior University, 142, 751
- Linnological Commission, A. E. BIRGE, C. H. EISENMANN, C. A. KOFOID, G. C. WHIPPLE, H. B. WARD, 897
- LLOYD, P. E., Biology, N. Y. Acad. Sci., 71; Extra-Nuptial Nectaries in Common Brake, 885
- LOEB, J., Unauthorized Newspaper Reports, 75
- LUCAS, F. A., Biological Society of Washington, 26, 189, 307, 392, 428, 506, 585, 711, 909
- Lugger, Otto, L. O. HOWARD, 980
- Lummer, O., Photographic Optics, R. W., 505
- Lütken, Christian Frederik, F. A. B., 540
- LYON, H. L., Embryogeny of Nelumbo, 470
- M., Naval Observatory, 113
- M., O. T., Play of Man, K. GROSS, 862
- McG., J. H., Biological Lectures, 1035
- McM., J. P., Aleyonium, S. J. HICKSON, 465
- MACCURDY, G. G., Le préhistorique, Gabriel et Adrien Mortillet, 343
- MACDOUGAL, D. T., Torrey Botanical Club, 867
- McGee, W. J., The Serri-Indians, A. F. CHAMBERLAIN, 779; Man's Place in Nature, 453
- MCMEURIE, W. M., The Chemical Industries, 441
- Manning, H. P., Non-Euclidean Geometry, G. B. HALSTED, 462
- Man's Place in Nature, W. J. MCGEE, 453
- MARK, E. L., Bibliographic Catch Title, 31
- MARSH, M. C., Report of U. S. Fish Commissioner, G. M. BOWERS, 106
- MASON, W. P., Air, Water and Food, E. H. RICHARDS and A. G. WOODMAN, 907
- Mathematical Soc., Amer., 917; F. N. COLE, 102, 429; E. KASNER, 744; Chicago Section, T. F. HOLGATE, 181
- MAURER, E. R., Science Club of Univ. of Wisconsin, 274
- MEADE, R. K., Chemists' Manual, J. E. G., 708
- Medical Association, Amer., C. A. L. REED, 924
- Melons, Seediness and Quality in, E. S. GOFF, 310
- MEDEL, L. B., Chemie der Eiweisskörper, O. COHNHEIM, 185
- Mendenhall, President, Resignation of, 34
- MERRIAM, C. H., Food of Sea Lious, 777
- MERRITT, E., American Physical Society, 823
- Meteorology, Current Notes, R. DEC. WARD, 75, 192, 233, 352, 512, 629, 793, 993, 1034
- Michigan Academy of Science, H. S. JENNINGS, 616
- Minnesota Acad. of Nat. Sci., F. G. WARVELLE, 509, 1029
- MINOT, C. S., The Unit System of Laboratory Construction, 409; Embryological Basis of Pathology, 481; Erinnerungen, A. Kölliker, 651
- MIYAKE, KRICHI, Botany in Japan, 734
- MONTGOMERY, T. H., JR., Amer. Morphological Society, 296
- Moon, Stereoscopic Study of, G. K. GILBERT, 407
- Morphological, Soc., Amer., T. H. MONTGOMERY, JR., 296; Museum, G. S. HUNTINGTON, 601
- Mortillet, Gabriel et Adrien, Le préhistorique, G. G. MACCURDY, 343
- Moses, A. J., and C. L. PARSONS, Mineralogy, C. H. W., 267
- MUNSON, L. S., Chem. Soc. of Washington, 507, 664, 824, 910
- Murray, D. A., Trigonometry, C. J. KEYSER, 25
- Museum Notes, F. A. L., 595, 834
- N., J. M., Fossil Bryozoa, J. W. GREGORY, 620
- N., W. A., Trivalent Carbon, 116
- NACHTRIEB, H. F., E. A. BIRGE, F. SMITH, State Natural History Surveys, 565
- National, Observatory, 195, 276; Acad. of Sciences, 597, 643; Government, Relation to Higher Education and Research, C. D. WALCOTT, 1001
- Natural, History, Aims and Methods of Study in, E. B. WILSON, 14; Hall of, Trinity College, 57; Sciences, Exact, Development in Nineteenth Century, H. C. JONES, 338; Work at Marie Biological Laboratory, Wood's Holl, C. O. WHITMAN, 538; State Surveys, E. A. BIRGE, 563; H. F. NACHTRIEB, 565; F. SMITH, 566
- Naturalists, American Society of, 36, 81; Western Branch, 117; C. B. DAVENPORT, 370, 753
- Naval Observatory, 1, 41, 113, 195, 234, 276, 314, 437, 550; F. H. BIGELOW, 150
- Nectaries, Extra-Nuptial in Common Brake, F. E. LLOYD, 885
- Newspaper Reports, Unauthorized, J. LOEB, 75
- New York Academy of Sciences, R. E. DODGE, 379; Biology, F. E. LLOYD, 71; H. E. CRAMPTON, 272, 467, 623, 865; Astronomy, Physics and Chemistry, W. S. DAY, 148, 346, 469; F. L. TUFTS, 624, 866; Anthropology and Psychology, C. H. JUDD, 309, 468; R. S. WOODWORTH, 662, 864; J. A., Engineering Chemistry, T. B. STILLMAN, 659
- NICHOLS, E. L., Research for Physics Teachers, 202
- NIPHER, F. E., Eclipse Photography, 208
- Nomenclature, N. L. BRITTON, 588
- Northwestern University Club, H. M. SNYDER, 587
- NORTON, W. H., Social Service of Science, 644
- Notable Official Report, 41
- Notter, J. L., Treatise on Hygiene, W. H. PARK, 156
- NOYES, W. A., Engineering Chemistry, T. B. STILLMAN, 659
- NUTTING, C. C., The Sea Bottom, 841
- Observation and Experiment, R. S. WOODWARD, 521
- Observatory, Naval, 1, 41, 113, 195, 234, 276, 314, 437, 550; F. H. BIGELOW, 150
- Oceanography, Notes on, R. A. DALY, 951
- Oil in Texas, G. D. HARRIS, 666
- Onondaga Acad. of Sci., P. F. SCHNEIDER, 625, 825, 912
- Oppel, A., Anatomie der Wirbelthiere, B. F. KINGSBURY, 1024
- Ormond, A. T., Foundations of Knowledge, R. M. WENLEY, 182
- ORNDORFF, W. R., Organic Analysis, F. G. BENEDICT, 785
- Ornithologists' Union, Nebraska, E. H. BARBOUR, 216
- OSBORN, H. F., Progress of Paleontology, 45, 872; The State and Scientific Investigation, 81
- OSBORN, H. L., Archaica Punctulata, 938
- OSGOOD, W. H., Biological Soc. of Washington, 787
- Osmometer, Simple, E. E. BOGUE, 791
- OSMOND, I. T., Vegeto-Electricity, 191

- Paleobotany, North American, D. P. PENHALLOW, 161  
PAMMEL, L. H., Iowa Academy of Sciences, 214  
PARK, W. H., Hygiene, J. L. Notter, 186  
PARKER, G. H., Zoological Results, A. Willey, 544  
Patent, Commissioner, Report, R. H. THURSTON, 503; Acts, Working of, R. H. THURSTON, 669  
Pathology, Embryological Basis of, C. S. MINOT, 481  
PECKHAM, S. F., Pavements, G. W. Tillson, 67  
Pedagogy, School of, N. Y. University, Resignations, 764; S. WEIR, E. F., BUCHNER, C. H. JUDD, 626  
PEGRAM, G. B., Radio-Active Minerals, 274  
PEIRCE, C. S., Campanus, 809  
PENHALLOW, D. P., Decade of N. Amer. Paleobotany, 161; Fossil Botany, D. H. Scott, 386; Mesozoic Flora of the U. S., L. F. Ward, 904  
Philosophical Society of Washington, C. K. WEAD, 149, 190, 306, 429, 508, 586, 665, 787, 985; J. F. HAYFORD, 665; Association, Western, 393  
Phosphorus Emanation, C. BARUS, 501  
Physical Society, American, W. HALLOCK, 101; E. MERRITT, 823; History of Rocky Mountain Region, G. M. DAWSON, 401; Laboratory, British National, 1036  
Physics, Teachers, Research for, E. L. NICHOLS, 202; and Faith, H. C. BOLTON, 241; Notes, W. S. F., 312  
Physiography, Current Notes on, W. M. DAVIS, 152, 275, 351, 395, 471, 551, 628, 751, 791, 871, 950, 1032  
Physiology in Schools, S. W. WILLISTON, 827, 991; T. HOUGH, 914  
PICKERING, E. C., Endowment of Research, 201; Variation of Light in Eros, 790  
Pierce, N. B., Peach Leaf Curl, 744  
Plague in San Francisco, 761  
Plant Morphology and Physiology, The Society for, W. F. GANONG, 246  
Politics and State Universities, 550  
Positions, Scientific under the Government, 754, 994  
Potassium Nitrate in Wyoming, W. C. KNIGHT, 151  
POULTON, E. B., British Antarctic Expedition, 890  
Pound, R. and F. E. Clements, Phytogeography of Nebraska, A. HOLLICK, 981  
Pozzi Escot, M. E., Analyse des Gaz, A. H. GILL, 345  
Primates, North American, J. L. WORTMAN, 209  
Primitive Man, Mind of, F. BOAS, 281  
Projection of Ripples by Grating, C. BARUS, 297  
Psychological Assoc., American, L. FARRAND, 211  
Public Service, R. H. THURSTON, 594  
PUTNAM, F. W., Appeal for Assistance, 75  
Quesnay, Francois, T. WILSON, 794  
Quotations, 550, 1031  
RANSOME, F. L., and D. WHITE, Geological Society of Washington, 187, 270, 426, 508, 585, 663  
Rault, Francois Marie, H. C. JONES, 881  
REED, C. A. L., Amer. Med. Assn., Address of President, 924  
Renault, B., Microorganismes des combustibles fossiles, L. F. WARD, 577  
RENOUF, E., Inorganic Chemistry, H. Erdmann, 268; V. Von Richter, 862  
Research, Endowment of, E. C. PICKERING, 201  
Richards, E. H., and A. G. Woodman, Air, Water and Food, W. P. MASON, 907  
Richter, V. von, Chemistry, E. RENOUF, 862  
Ries, H., Clays of New York, J. F. KEMP, 946  
RIGGS, E. S., Largest known Dinosaur, 549  
Rock, Miles, W. EIMBECK, 978  
Ross, Professor, The Case of, 361  
Rotation of a Rigid Body, Equations, C. BARUS, 914  
ROTCH, A. L., Meteorologische Beobachtungen, G. Hellmann, 821  
Rowland, H. A., J. H. AMES, 681; D. C. GILMAN, 801  
Royal Society of Canada, H. M. AMI, 1015  
RUSSELL, F., Anthropology at Baltimore, 139  
S., G. N. I., Physiology, E. A. Schäfer, 144  
St. Louis Academy of Science, W. TRELEASE, 27, 72, 273, 430, 584, 626, 666, 826, 986  
San Jose Scale, and Orange Scale Problem, F. M. WEBSTER, 511; in Japan, V. L. KELLOGG, 383  
SARDESON, F. W., Notes on Western Tertiary, 868  
Schäfer, E. A., Physiology, G. N. I. S., 144  
SCHNEIDER, P. F., Onondaga Academy of Science, 625, 825, 912  
SCHOEER, W. B., Chemistry, Lassar-Cohn, 707  
Schuyler, J. D., Reservoirs, J. P. CHURCH, 738  
Science, Teachers' Association, N. Y. State, C. W. DODGE, 415; Social Service of, W. H. NORTON, 644; and Industrial Competition, R. H. THURSTON, 631; and the London University, 1021  
Scientific Books, 23, 67, 105, 144, 182, 222, 264, 301, 343, 386, 422, 462, 503, 542, 577, 618, 657, 706, 738, 779, 820, 859, 904, 943, 981, 1034; Journals and Articles, 25, 70, 110, 147, 186, 227, 305, 346, 390, 425, 466, 545, 582, 622, 661, 709, 785, 863, 908, 947, 984; Notes and News, 37, 77, 117, 154, 196, 236, 278, 315, 355, 398, 438, 475, 515, 555, 598, 634, 675, 715, 755, 795, 836, 876, 917, 955, 996, 1037; Literature, International Catalogue of, 76; Investigation, The State and, H. F. OSBORN, W. B. CLARK, L. O. HOWARD, B. T. GALLOWAY, W. T. SEDGWICK, 81; Alliance of New York, 596; Work, Legislative Recognition of, 704  
SCLATER, P. S., The Alpine Chough, 626  
Selater, W. L., Mammals of S. Africa, J. A. A., 105  
Scott, D. H., Fossil Botany, D. P. PENHALLOW, 386  
SCRIPTURE, E. W., The Larynx, 913  
Sea, Lions, 765; C. H. MERRIAM, 777; Bottom, Physical Conditions and Fauna, C. C. NUTTING, 841  
SEASHORE, C. E., Baconian Club, Univ. of Iowa, 826  
SEDGWICK, W. T., The State and Scientific Investigation, 81; Bacteriology, 121  
Sellers, J. F., Chemical Analysis, H. F., 707  
SHARP, F. C., Wisc. Acad. of Sci., 181  
SIMONDS, F. W., The Geology of Texas, R. T. HILL, 226; Texas Acad. of Sci., 229; The Austin Dam, T. U. Taylor, 545; Mineral Survey in Texas, 671  
Simpson, C. T., Naiades, T. D. A. COCKERELL, 983  
SMITH, E. F., Electro-Chemical Laboratory, 697  
SMITH, F., E. A. BIRGE, H. F. NACHTRIEB, State Natural History Surveys, 566  
SMITH, H. I., Wisconsin Archeology, 794; Archeological Map, 873; Earthwork in Michigan, 991  
SMITH, H. M., Chasmodon in the Indian Ocean, 510  
SNYDER, H. M., Sci. Club of Northwestern Univ., 587  
Societies and Academies, 26, 71, 112, 148, 187, 238, 270, 306, 346, 391, 426, 467, 506, 547, 584, 623, 662, 710, 744, 786, 823, 864, 909, 948, 985, 1026  
Sound, Monaural Localization of, J. R. ANGELL, 775  
SPALDING, V. M., Forest Management, 542  
Standards, National Bureau of, 474  
Stanley-McCormick Expeditions, G. A. DORSEY, 219

- STEJNEGER, L., Crocodilian Nomenclature, 394  
 STILES, C. W., Notes on Parasites, 593  
 Stillman, T. B., Engineering Chemistry, W. A. NOYES, 659  
 Stroboscopic Phenomena, C. BARUS, 128
- T., The Magnetic Survey of the United States, 353  
 T., Cyclopedia of American Horticulture, 823  
 T., R. H., Frictional Effect of Railway Trains on the Air, 115
- TALBOT, H. P., Chemie, A. Classen, 660  
 TALMAGE, J. E., Fault-Slip, 550; 'Sand-Bow,' 992  
 Taylor, T. U., The Austin Dam, F. W. SIMONDS, 545  
 Tertiary, Sea, Southern Brazil, O. A. DERBY, 348; Western, Notes on, F. W. SARDESON, 868  
 Texas Academy of Science, F. W. SIMONDS, 229  
 THOMSON, E., Diffraction Gratings, 114; Electric Lighting, F. B. Crocker, 943  
 Thorndike, E., Human Nature Club, J. J., 621  
 THURSTON, R. H., American Education, H. S. Jacoby, 68; U. S. Bureau of Steam Engineering, 224; Society for the Promotion of Engineering Education, 301; U. S. Commissioner of Patents, 503; Thermodynamic Efficiencies, 552; Amateurism and Mental Inertia in Public Service, 594; The Steam-engine Problem, S. H. Barracough, 619; Science and Industrial Competition, 631; Patent Acts, 669; Steam-boiler Economy, W. Kent, 906; Reports of War Department, 740  
 Tillman, S. E., Minerals and Rocks, C. H. W., 267  
 Tillson, G. W., Street Pavements, S. F. PECKHAM, 67  
 Titchener, E. B., Exper. Psychology, J. JASTROW, 741  
 Top, Motion of, A. HALL, 948  
 TRELEASE, W., St. Louis Academy of Science, 27, 72, 273, 430, 584, 626, 666, 826, 986  
 Trinity College, Hall of Natural History, 57  
 TUFTS, F. L., N. Y. Acad. of Sci., Astronomy, Physics and Chemistry, 624, 866
- Universities, Association of American, 436  
 University and Educational News, 40, 80, 120, 159, 199, 240, 279, 320, 359, 400, 440, 480, 519, 560, 600, 640, 680, 719, 760, 799, 839, 880, 920, 959, 999, 1039
- VAN ORNUM, J. L., Engineering, 771  
 Vermont Botanical Club, C. D. DIXLOWE, 230  
 VERY, F. W., Astronomy, Sir R. Ball, 581
- W., C. H., Mineralogy, A. J. Moses and C. L. Parsons, 267; Minerals and Rocks, S. E. Tillman, 267  
 W., R., Photography in Colors, 109; Photographic Optics, O. Lummer; Geometrical Optics, R. A. Herman, 505  
 Waddell, Chemistry, J. E. G., 304  
 WADSWORTH, F. L. O., The Keeler Memorial, 789  
 WAITE, F. C., Bufo Agua in Bermudas, 342  
 WALCOTT, C. D., Relation of National Government to Higher Education and Research, 1001  
 War Department, Reports, R. H. THURSTON, 740  
 WARD, H. B., E. A. BERGE, C. H. EIGENMANN, C. A. KOFOID, G. C. WHIPPLE, Limnological Commission, 897  
 WARD, L. F., Microorganismes des combustibles fossiles, B. Renault, 577
- Ward, L. F., Mesozoic Flora of the U. S., D. P. PENHALLOW, 904  
 WARD, R. DE C., Cloud Observations, F. H. Bigelow, 24; Current Notes on Meteorology, 75, 192, 233, 352, 512, 629, 793, 993, 1034  
 WARVELLE, F. G., Minnesota Academy of Natural Sciences, 509, 1029  
 Washington University, W. S. CHAPLIN and E. H. KEISER, 258  
 Washington Memorial Institution, 921  
 WEAD, C. K., Philosophical Society of Washington, 149, 190, 306, 429, 508, 586, 665, 787, 985  
 WEBSTER, A. G., The Larynx, 827  
 WEBSTER, F. M., San Jose and Orange Scale Problem, 511  
 WEIR, S., E. F. BUCHNER, C. H. JUDD, Resignations from School of Pedagogy, N. Y. University, 626  
 WENLEY, R. M., Foundations of Knowledge, A. T. Ormond, 182; Kant's Cosmogony, W. Hastie, 302; Knowledge, Belief and Certitude, F. S. Turner, 422  
 Wesleyan University, Science at a, 1031  
 WHITE, D., and F. L. RANSOME, Geological Society of Washington, 187, 270, 426, 508, 585, 663  
 WHITE, T. G., Geology and Mineralogy at the N. Y. Acad. of Sci., 509, 710  
 WHITMAN, C. O., Natural History Work at the Marine Biological Laboratory, Wood's Holl, 538  
 WILEY, H. W., Dignity of Chemistry, 721  
 Willey, A., Zoological Results, G. H. PARKER, 544  
 WILLIAMS, C. B., N. C. Section of Amer. Chemical Society, 899  
 WILLIAMS, H. S., Photography of Fossils, 790  
 Williams, Thomas A., 36  
 WILLIS, B., Thomas Denton Brooks, 460  
 WILLISTON, S. W., Physiology in Schools, 827, 991  
 WILSON, E. B., Aims and Methods of Study in Natural History, 14; Centrosomen, T. Boveri, 264  
 Wilson, H. M., Topographic Surveying, J. H. GORE, 820  
 WILSON, T., Francois Quesnay, 794  
 WINSTON, I., International Geodetic Association, 129  
 Wireless Telegraphy, 874, 875  
 Wisconsin, Academy of Sci., Arts and Letters, F. C. SHARP, 181; University Sci. Club, W. H. HOBBS, 228; E. R. MAURER, 274; L. KAHLLENBERG, 548  
 WOOD, R. W., Diffraction Gratings, 33; Artificial Representation of Eclipse, 65; Solar Corona, 179  
 WOODMAN, D., N. Y. Section of the American Chemical Society, 191, 393, 711, 948  
 WOODS, A. F., Enzymes and their Application, 822  
 WOODWARD, R. S., Observation and Experiment, 521  
 WOODWORTH, R. S., Anthropology and Psychology, N. Y. Acad. of Sci., 662, 864  
 WORTMAN, J. L., North American Primates, 209  
 WRIGHT, J., Larynx as an Instrument of Music, 1030  
 WRIGHT, G. F., Geology of China, 1029
- Yellow Fever, 513
- Zoological, Club, Univ. of Chicago, C. M. CHILD, 73, 112, 1026; Journal Club, Univ. of Michigan, H. S. JENNINGS, 74, 745; Notes, 276, 435.  
 Zoologischen Gesellschaft, C. A. KOFOID, 783



# SCIENCE

EDITORIAL COMMITTEE: S. NEWCOMB, Mathematics; R. S. WOODWARD, Mechanics; E. C. PICKERING, Astronomy; T. C. MENDENHALL, Physics; R. H. THURSTON, Engineering; IRA REMSEN, Chemistry; JOSEPH LE CONTE, Geology; W. M. DAVIS, Physiography; HENRY F. OSBORN, Paleontology; W. K. BROOKS, C. HART MERRIAM, Zoology; S. H. SCUDDER, Entomology; C. E. BESSEY, N. L. BRITTON, Botany; C. S. MINOT, Embryology, Histology; H. P. BOWDITCH, Physiology; J. S. BILLINGS, Hygiene; WILLIAM H. WELCH, Pathology; J. McKEEN CATTELL, Psychology; J. W. POWELL, Anthropology.

FRIDAY, JANUARY 4, 1901.

THE NAVAL OBSERVATORY REPORT.

## CONTENTS:

<i>The Naval Observatory Report:—</i>	
Editorial Comment.....	1
Extracts from the Report of the Superintendent....	5
<i>Aims and Methods of Study in Natural History:</i>	
PROFESSOR EDMUND B. WILSON.....	14
<i>Scientific Books:—</i>	
<i>Report of the U. S. Commission of Fish and Fisheries:</i> PROFESSOR H. C. BUMPUS. <i>Report on the International Cloud Observations:</i> PROFESSOR R. DEC. WARD. <i>Murray on Plane Trigonometry:</i> DR. C. J. KEYSER. <i>Books Received.</i>	23
<i>Scientific Journals and Articles.....</i>	25
<i>Societies and Academies:—</i>	
<i>Biological Society of Washington:</i> F. A. LUCAS.	
<i>Torrey Botanical Club:</i> PROFESSOR EDWARD S. BURGESS. <i>The Academy of Science of St. Louis:</i> PROFESSOR WILLIAM TREALEASE.....	26
<i>Discussion and Correspondence:—</i>	
<i>The Electrical Theory of Gravitation:</i> PROFESSOR R. A. FESSENDEN. <i>A Bibliographic Catch Title for the Years 1900 to 1999.</i> PROFESSOR E. L. MARK. <i>Astronomischer Jahresbericht:</i> DR. HERMAN S. DAVIS. <i>Diffraction Gratings for Gratuitous Distribution:</i> PROFESSOR R. W. WOOD.	28
<i>Notes on Inorganic Chemistry:—</i>	
<i>Argon and its Companions:</i> J. L. H.....	33
<i>The Resignation of President Mendenhall.....</i>	34
<i>Thomas A. Williams.....</i>	36
<i>The American Society of Naturalists.....</i>	36
<i>The American Association for the Advancement of Science.....</i>	37
<i>Scientific Notes and News.....</i>	37
<i>University and Educational News.....</i>	40

THE first impression of our readers on glancing at the annual report of the Naval Observatory, of which the essential portions are reprinted in our columns, will be one of pleasure that the head of the Observatory has deemed it appropriate to review the conclusions of the board of visitors appointed by the Secretary of the Navy in 1899. But pleasure will be changed to disappointment at what the review omits. It maintains with an energy of expression quite unusual in an official paper that a majority of the board was hostile to the Observatory; that it failed to report on the main points submitted, and that the measures which it proposed are 'preposterous' and 'only ridiculous.' But not a word is said in reply to the destructive criticism of the management of the institution 'during almost the entire period of its existence,' which is one of the most important features of the report. Had these strictures been now heard of for the first time some reason might have been found for ignoring them. But they are little more than an echo of strictures emanating from or endorsed by Secretaries of the Navy, the National Academy of Sciences, at least one distinguished naval offi-

MSS. intended for publication and books, etc., intended for review should be sent to the responsible editor, Professor J. McKeen Cattell, Garrison-on-Hudson, N. Y.

cer, and every eminent astronomer in the country who has ever expressed an opinion on the subject. Utterances by such authorities are surely worthy of being honored by a refutation. We wish to facilitate in every way the task of making the most effective refutation possible, and this we can best do by stating the substance of the criticisms as clearly and forcibly as we can, without implying any endorsement of them until we hear the other side.

The only rational object that the nation can have in supporting a great public observatory is the continuous making of those astronomical observations which require to be prosecuted on a uniform plan for long intervals of time, with a force larger than private observatories can ordinarily command, and with a persistence more long-continued than they can be expected to exhibit. The first requirement of all is a comprehensive plan of work, devised by the best authorities at the command of the nation, and based on the latest aspects of astronomical science. This plan should be pursued without change except as improvements are suggested by the advance of research. It should be dependent on the life or temporary opinions of no individual, and should have a form of public support which will secure adherence to it.

The criticism directed against the Observatory is that its published observations and reports show little or nothing of this kind, and that neither permanence of purpose nor unity of object can be discerned in them. Much that we find in the published volumes looks like a collection of individual works of every degree of ability from the highest

to the lowest, which have the appearance of being initiated by the worker himself, abandoned when he deemed it best to do so, and only now and then controlled by the guidance of any higher authority. Even in the case of those observations in which continuity from year to year can be best traced, gaps and unexplained changes and omissions occur through the whole history of the Observatory, for most of which no explanation is found, and none can be readily imagined except the varying moods of the observers.

In these points the critics see no evidence of any permanent improvement in the work of the new establishment. The reports for the last eight or ten years show earnest efforts made by this and that astronomer to do this, that and the other, set forth the difficulties encountered in making these efforts, report the success reached in overcoming them, and describe the alterations necessary in instruments and arrangements. Sometimes an effort made one year seems to be continued into the next, and sometimes we hear nothing more of it. It would be tedious to enumerate all the enterprises which figure for a year or two in the annual reports, without any reason being assigned, and then disappear without any explanation. There seems to be as striking an absence of continuity from year to year as there ever was, the work with the prime vertical transit excepted.

It is not denied by the critics that able and industrious astronomers have, from time to time, been attached to the institution, that the qualifications of the working force are still excellent, and that much good

work has been done by it; but it is also claimed that, for the most part, this work could have been equally well or better done at universities and private institutions, and that it is mixed up with so much indifferent work that the separation of the two is difficult. It is also admitted that much of the work compares favorably with that done by professors and students at the various colleges and universities of the country. But the critics do not see why the government should establish a great institution and give men commissions in the navy to enable them to do work which professors and students are doing at universities and which is of no special naval use.

In framing a reply to this criticism we trust that several other points which invite adverse criticism will be cleared up to the pleasure of all. One is especially worthy of mention because we think, if anything can be said to correct the unfavorable impression which it makes, it ought to be said authoritatively and as speedily as possible. Among the important subjects of scientific observation and investigation to-day is terrestrial magnetism. The good policy of the observatory in entering upon a field already occupied by another bureau of the government may be open to question, but this is aside from the main point. One of the best-equipped magnetic observatories was established and, we believe, observations made for a year or two. We learn from recent reports that the observations were suspended and the department discontinued, because the action of the electric current from a trolley line in the neighborhood so disturbed the instruments

as to deprive the results of all scientific value. Now, we hope the head of the establishment will explain how it happened that one of the finest magnetic observatories in existence was established 400 yards from a trolley line, when a simple computation of the effect of the electric current by a magnetic expert would have shown that its inductive effect would be destructive to the results, and, unless we are mistaken as to dates, after experience elsewhere had shown that the presence of such a line within a mile or even a mile and a half of a magnetic station was fatal to the usefulness of its work. All good wishers of the Observatory would be glad of a proof that this happened through no fault of its administration.

We also suggest that something be said to remove the unfavorable impression made by the unfortunate experience of the institution with its instruments from the beginning of its history. How many costly instruments, supposed to be of the finest quality, have been procured, tested, reconstructed, found wanting and suffered to disappear from view, we cannot say without an examination of the records. But the recent easily accessible reports and documents throw some light on the later history of the subject.

The great 26-inch telescope, constructed about 1874, was found to be so defective that, on moving into the new Observatory, what was substantially a new instrument was constructed. We believe that nothing but the object-glass and, perhaps, some accessories of the old instrument were retained. Whose fault was this?

Perhaps the most necessary and important instrument the Observatory ever had was the 9-inch transit circle, constructed, we believe, some time in the sixties. It was found so defective in stability as to greatly impair the value of its results. Attempts to correct the defect proved unavailing, so radical changes were made in the instrument at a cost, if we mistake not, which could not have been greatly short of the original price. No sooner was it remounted at the new location than defects were found in its performance which, according to the annual reports, it took another year to remedy. In 1896 it is reported as again taken down for a period of five months in order that further extensive repairs might be made. The report of 1899 gives an elaborate account of renewed efforts during the first six months of the year to improve its performance, concluding with the statement: "In my opinion it should be restored as nearly as possible to its original construction." But this does not end the history. We learn from the present report that the instrument was again undergoing repairs and alterations for the first six months of the last fiscal year, and yet it winds up with the statement that "one of the defects still introduces liabilities to error which, though small, ought not to be tolerated in a modern instrument."

The defects in this instrument naturally led to the desire to have a better one. Accordingly, among the appropriations made for the new establishment was one of \$10,000 for a meridian circle. This instrument was completed and mounted in 1897. We learn from the report before us that it

exhibits a peculiarity of a kind so singular that it should interest physicists as well as astronomers. Its horizontal pointing changes so rapidly with the temperature that, by the aid of the delicate meridian mark, a variation produced by a change of a single degree in the temperature must be an easily measurable quantity. Consequently the instrument could be used as a fairly delicate thermometer. It is hardly necessary to add that observations with such an instrument cannot have much scientific value until the defect is corrected, and that the policy of the observers in not attempting serious work with it cannot be questioned.

The new 12-in. equatorial has proved unsatisfactory. There are also intimations that something is wrong with the prime vertical transit, and, altogether, the impression made on the reader is that, after seven years of effort to equip the Observatory with the best instruments, it is doubtful whether a single one of real importance, except the great telescope, is in order for first-class work. We hope something can be said to explain this history, which is without example. The Greenwich transit circle has been in continuous use for half a century except during a brief period of its early history, when some alteration was made in it. The small repairs which it has since required have caused no interruption in the continuity of its work. The instruments of the Pulkova Observatory have, for the most part, been in use since 1840, and it is believed that their results are to-day among the best attainable in astronomy.

Were only a single instrument involved in the case of our own Observatory, it might

well be set down to unavoidable misfortune. But so long-continued a history leads one to infer a cause, and we should be glad to see something said to efface the impression that the administration is at fault.

In the way of assistance we suggest a few other questions as worthy of careful consideration. It is understood that, when the Astrophysical Society of America chose its committee to confer with the Secretary of the Navy on the question of the Observatory, especial pains were taken to select men who had never been known to express any opinion on the subject. We are quite sure that the Society would like the Superintendent of the Observatory to state how he knows that in making the selection, it was the victim of misplaced confidence, and that the members were 'known to be inspired by a hostility to its organization.'

A cognate point is this: The membership of the Society includes a respectable and influential number of members who have been connected with the Observatory at one time or another in various capacities and who would be its natural defenders. Would not some of them have objected to the appointment of a hostile committee?

The greater number of our astronomers are the mildest of men, and glad to see their science promoted in every way. How does it happen that they, as a class, are moved by 'animosity' toward a national institution for promoting their science?

We wish also to discover every possible justification for the claim that "no person, no matter how eminent he may be in science, can pretend to be a friend of the Observatory or of science while attacking its

organization." This is preceded by the statement that "the number of observations made at the old and new Observatories kept pace with those made at Greenwich." If the report had said that the Observatory during the past ten years, with less than half the personnel of Greenwich, had, on the average, done nearly one-half as much work, the critics might have inquired in reply whether this was not a slight exaggeration. They might also have inquired whether it was not desirable to take account of the quality as well as the quantity of the work, and whether in that respect the observations described in the annual reports of the last ten years could compare even with one-third of the work done at Greenwich. But when we find the head of the Observatory seriously believing that some comparison can be instituted between the output of the two observatories we see that he has, from his own point of view, just cause of resentment against the critics of the institution, and feel encouraged to believe that, when he has ascertained the facts, he will, as an act of justice, fair play and public policy, admit that the 'prejudices and animosities' of the astronomers have better grounds than he had supposed.

---

REPORT OF THE SUPERINTENDENT OF THE  
NAVAL OBSERVATORY.

[We regret that we have room only for such portions of this interesting report as relate to astronomical work and the report of the board of visitors.]

DEPARTMENT OF ASTRONOMICAL OBSERVATIONS.

The work of the year in this department may be summarized as follows:

Professor William Harkness, who retired from active service on December 15, 1899, was succeeded in the astronomical directorship by Professor Stimson J. Brown, the senior professor of mathematics on duty at the Observatory. Professor Brown's first duty was as member of a board of examiners, to fill the vacancy caused by the retirement of Professor Harkness, by the selection of a suitable candidate for appointment as professor of mathematics in the navy. The labors of this board, of which Professor William Hendrickson, U. S. N., was senior member, resulted in the selection and appointment of Professor W. S. Eichelberger. In this connection it is pertinent to observe that the present condition of the astronomical staff of the Observatory is highly satisfactory, and gives promise for the future. The vacancies, caused by the rapid successive retirement of the older professors, have all been filled by young men of marked ability, and the Observatory has followed its traditional policy in this respect, and has every reason to anticipate a renewed activity and a period of harmony, industry and usefulness.

All the astronomical instruments of the Observatory have been steadily and continuously in use during the year on every clear night and day.

The XXVI.-inch equatorial telescope has been employed on the observation of difficult double stars, the satellites of the planets and the measurement of their disks, and on other objects suitable to an instrument of its power. This instrument was in charge of Professor Brown, assisted by Professor T. J. J. See, until December 15th, and has since been in charge of Professor See.

In the month of October, during the hazy weather common at that season, the images of celestial bodies were marked by great steadiness in the field of view, unusual at other times. Owing to this favorable con-

dition, Professor See noticed on several occasions faint markings on the disk of Neptune, similar to the equatorial belts of the planets Jupiter and Saturn. The fine definition at this time was ascribed to the selective absorption of the haze caused by the smoke of forest fires, and an attempt has been made by Professor See and Mr. George H. Peters, the photographer, to reproduce artificially the same conditions by the use of a color screen. The idea of this application to the telescope was not wholly new, although it was believed to be so at the time. It is too early to speak definitely on the result of these experiments, except to say that the general effect of the use of a screen composed of two thin sheets of plate-glass, the space between them being filled with a solution of chloride of copper and picric acid, or a solution of bichromate or chromate of potash, seems to have the effect of absorbing the blue rays and removing the halo which surrounds bright objects in the field of a large achromatic telescope, and the image appears somewhat steadied. The color screen is now in use in observations of the diameters of the planets and measurable satellites.

During the year the double floor, which was appropriated for last year, designed to obviate the difficulty experienced from currents of warm air rising from the basement, has been finished, and answers every expectation, giving highly satisfactory results.

The IX.-inch transit circle was undergoing its periodical repairs and general overhauling from the beginning of the fiscal year until January 20, 1900, during which time the routine work of the sun, moon and planets was carried on with the new VI.-inch steel transit circle. Since the resumption of the regular work on the IX.-inch circle, Professor Skinner has had charge of the zone observations and Professor Eichelberger of the routine sun, moon and planet work, while the VI.-inch circle, in charge of

Professor Updegraff, has been under strict investigation, with a view to determining the causes of several faults made apparent by the routine work and probably unavoidable in a new instrument.

In the meridian work a total of 1,114 observations of zone stars and a total of 3,105 observations in the sun, moon and planet work have been made during the year.

The XII.-inch equatorial has been used for observations of comets, asteroids and other miscellaneous objects, and will soon undergo some extensive repairs and alterations.

Assistant astronomer George A. Hill has devoted the prime vertical transit to observations of  $\alpha$  Lyræ and a small list of suitable stars in the investigation of the variation of latitude and the constants of nutation and aberration, and the same observer has used the new V.-inch steel altazimuth instrument principally as a zenith telescope for observations for latitude by Talcott's method, and for the declinations of stars of the American Ephemeris.

The 40-foot photoheliograph has been used in making daily photographs of the sun whenever the weather permitted, except after April 2d, during preparations for the observations of the total eclipse of the sun on May 28th.

By an appropriation of \$5,000 the Observatory was able to undertake observations of the total eclipse of the sun on the date above mentioned. Two parties were sent into the field, and attention is respectfully invited to the detailed report of the astronomical director on this subject, and also to the recommendation for an appropriation to cover the expenses of a similar expedition this year, in the eclipse of May 17, 1901, which is approved and indorsed.

Preparations are now in progress for installing at the Observatory a new standard clock which shall be entirely freed from the influences of changes of temperature, and

the recommendations of the astronomical director on this subject are approved.

The work of bringing up the publications of observations to date, which has been in arrears for several years, is being vigorously pushed, and the issue of the first volume of the new series of Washington observations, commencing with the first year of the Observatory's work on the present site, will soon occur, to be followed by the succeeding volumes in rapid succession. The delay in the publication of its work has been made a reproach to the Observatory, although the causes of this delay have been reasonable and unavoidable, but the most earnest and determined effort is being made to relieve the Observatory of a condition which has been used to its disadvantage in outside criticism.

The report of the astronomical director is herewith transmitted in full.

The department of magnetism has been discontinued, as noted in the last report of the superintendent. The buildings and instruments are, however, maintained in perfect order under the charge of assistant astronomer Theo. I. King. The Georgetown and Tennallytown Electric Railway has already installed a return wire which, it is reasonable to suppose, it intends sooner or later to use. When this road ceases to ground its powerful working currents, an attempt will be made to resume magnetic observations at the Observatory. The result is dubious. Moreover, the Observatory is to a lesser extent within the influence of the Chevy Chase road, which would continue to affect observations.

#### BOARD OF VISITORS.

As noted in my last report, and for the first time in its history, a board of visitors was appointed which visited the Observatory in June and again in September, remaining a few days at each visit. As the report of the board, which was not made

available to the Observatory until long after its substance had appeared in the public prints, was in the nature of an attack on the Observatory, I trust that it will not be out of place, in the report of the Superintendent, to touch upon its salient features.

The board was unfortunate in having the support of several zealous newspaper writers, by whom it has been made to appear, and I think that it is generally believed in the scientific world and by that part of the public which takes an interest in scientific affairs, that the presence of the board was in the nature of a visitation distasteful to the Observatory and inflicted against its will. As the Observatory has thus been made to appear in an odious light, I take the liberty of reminding the Bureau that not only the original conception of the board of visitors was a suggestion of the Superintendent, but the selection of the three astronomical members was concurred in by him because they were already the members of a self-constituted committee to conduct a gratuitous investigation of the Observatory, and known to be inspired by a hostility to its organization. It was hoped that by placing them in a position of official responsibility an impartial judgment could be obtained.

A criticism of the report may be very briefly summarized. The board made no examination or inspection of the Observatory except in the most casual way. To quote its own language, "Owing to the lack of printed material representing the recent work of the Naval Observatory, the board of visitors finds it practically impossible to form a satisfactory opinion of that work without devoting to the task an inadmissible amount of time and labor." Nevertheless, and without such an opinion, the board did not hesitate to recommend the most sweeping changes in the present organization, and it is noticeable that the report of the board deals exclusively with the ques-

tion of reorganization, while that question had not been officially presented to it at all. As a guide to the board the following letter of instructions was addressed to it by the Department:

NAVY DEPARTMENT,  
WASHINGTON, JUNE 23, 1899.

SIR: I have the honor to enclose you herewith a memorandum making certain suggestions which the Department wishes the board, of which you are the chairman, to have in mind in making an examination of the Naval Observatory. This memorandum is not intended to finally limit the investigations of the board, but to convey certain suggestions in regard to which the Department desires to be informed, and which, it is believed, may assist the board in its work.

JOHN D. LONG, *Secretary.*

Hon. WM. E. CHANDLER,  
*Chairman Board of Visitors, Naval Observatory, Washington, D. C.*

[The points covered by the enclosure, which is too long for reproduction here, are meridian observations of the sun, moon and planets, spectroscopy and photography, chronometers, the Magnetic Observatory and the publications of the Observatory.]

Not one of the subjects proposed in the above memorandum received the attention of the board or was even mentioned by it. The whole report is taken up with the proposed reorganization, a subject which it had not been asked to consider at all, and for which it could only find a general authorization in the concluding paragraph of the Department's letter.

Notwithstanding that the board had no time to form an opinion as to the condition of work at the Observatory, the conclusion upon which it bases a recommendation for a revolutionary change of organization is found in the charge that the output, in published results, is not commensurate with an extravagant annual outlay. In other words, the board lays particular stress upon the delay in the publication of the annual volume, and bases its whole finding upon that fact.



The board makes a comparison between the Naval Observatory and the observatories at Greenwich and Harvard, selecting the former because it is supposed to cover nearly the same field, and the latter because it also undertakes large pieces of routine work which are beyond the reach of smaller observatories, because the resources of Harvard approach more nearly than do any other those of the Naval Observatory, and because all the details of the Harvard Observatory were readily available, its director being a member of the board.

I ask the attention of the Bureau to the following table, which gives an exact comparison of the three observatories chosen by the board, and which, almost without elucidation, confutes the sole and only charge made by the board against the efficiency of the Observatory upon which charge the only recommendation of the board rests.

Comparison of number and cost of scientific personnel of Greenwich, Harvard, and Naval observatories, previous to July 1, 1900 :

GREENWICH OBSERVATORY.

Scientific personnel.	No.	Average.	Total.
Director .....	1	\$5,000	\$5,000
Chief assistants .....	2	2,550	5,100
First-class assistants .....	4	2,000	8,000
Second-class assistants .....	4	1,200	4,800
Magnetic superintendent .....	1	1,700	1,700
Assistant magnetic superintendent .....	1	1,000	1,000
Computers .....	23	325	7,475
Total .....	36	.....	\$33,075

HARVARD COLLEGE OBSERVATORY.

Director .....	1	\$5,000	\$5,000
Astronomers .....	6	2,000	12,000
Assistant astronomers .....	13	900	11,700
Computers .....	18	600	10,800
Total .....	38	.....	\$39,500

UNITED STATES NAVAL ACADEMY.

Astronomical director .....	1	\$3,500	\$3,500
Other professors of mathematics .....	4	2,700	10,800
Assistant astronomers .....	3	1,500	4,500
Computers .....	6	1,200	7,200
Photographer .....	1	1,200	1,200
Total .....	15	.....	\$28,300

A comparison of the figures in this table shows that the number of astronomers em-

ployed at the Naval Observatory is 5, at Greenwich 3, at Harvard 7. The Naval Observatory has the advantage of Greenwich and decidedly the disadvantage of Harvard. In the matter of assistants, however, the case is different. The total of assistants at Greenwich is 8, at Harvard 13, and at the Observatory 3; while the computers stand, Greenwich 23, Harvard 18, Naval Observatory 6.

In the years 1891 to 1893 the Observatory was removed from the site which it had occupied for nearly fifty years, to its present situation. The delays in building, the labor of dismantling and remounting the instruments, the repairs and alterations of the same and their subsequent installation, the removal of the records and Observatory property, and generally the labor involved in settling in the new place, absorbed the entire time of the whole very limited working force of the Observatory for several years. The publication of results, from this cause and from this cause alone, fell into arrears. The force of the astronomical staff, sufficient for current work in settled times, was totally inadequate to bring up back work when the work had fallen behind. It was simply a physical impossibility to keep up the publications, and to make the current observations and do the necessary work of removal at the same time. This and this alone is the cause of the delay in printing, and when the number of assistants and computers at the Observatory is contrasted with the numbers at Greenwich, and especially at Harvard, the delay is reasonable on its face. These facts were represented to the board, but are nowhere given in its report. The board, on the contrary, evaded and concealed them. It might have reasonably been shown that during the whole of this transition period current work was practically uninterrupted, and that the number of observations made at the old and new Observatories kept pace

with those made at Greenwich. But "owing to the lack of printed material the board found it impossible to form a satisfactory opinion upon that work, without devoting to the task an inadmissible amount of time and labor." The facts were laid before the board and ignored by it. They would have shown to the credit of the Observatory.

It is needless to say that the figures in the above table are not given by the board in its comparison of the three observatories named as they are given here. The board had to make a case against the Observatory, and the charge of extravagance of outlay in proportion to the output of results had to be substantiated. Accordingly, the whole staff of the Observatory, scientific and lay, is contrasted with that at Harvard, and the numbers are brought to an equality by adding in the artisans and laborers employed about the buildings and grounds, Harvard having practically none. By this process the astronomical personnel of the Observatory is shown to be one in excess of that at Harvard, and the salaries are compared on this basis, greatly to the disadvantage of the Observatory. This enumeration also charges the Observatory with two 'directors' for the same obvious reason. Although the board had no time to form an opinion, it should have learned, if it could have assimilated the information which it received, that the Observatory, like other naval establishments, has but one 'head,' and that the astronomical director of the Observatory is the head of the astronomical department, just as a naval officer is the head of the department of nautical instruments. To charge two 'heads' to the Observatory in order to increase the apparent extravagance of maintenance is clearly a perversion of fact. If the Observatory has two heads, then it has eight heads, one for each department, and including the superintendent.

The attention of the Bureau is asked to a comparison of salaries, shown in the above table, which forms the basis of the board's charge of extravagance. At both Greenwich and Harvard the salary of the director is \$5,000. At the Observatory, using the board's own method of comparison, the corresponding salary is \$3,500. But, by the ingenious device of a 'dual head,' the board increases it to \$4,000 and then doubles it. Naval officers receive their pay, whether they happen to be on duty at the Observatory or elsewhere; but the board chooses to assume that the salary of every professor of mathematics in the navy, active or retired, except two at the Naval Academy, is chargeable to the expenses of the Observatory. It therefore charges in its exhibit the salaries of officers on the retired list, and the salary of one officer, still on the active list, whose connection with the Observatory has long since definitely ceased for cause. By such flimsy expedients as these the expense column is easily swelled. It might be swelled to any amount desired by simply charging against it the salary of any or every living officer of the navy, active or retired, who had ever been on duty at the Observatory. It is in the lower grades particularly, however, that I ask a fair comparison of salaries at the three institutions selected by the board. At Greenwich, for example, computers receive an average of \$325 per year, less than one-half the pay of our laborers, and less than the remuneration of any human being doing skilled work in the United States. At Harvard computers receive an average of \$600, less than the pay of any person in the United States service. These computers are largely women, who can be got to work for next to nothing. Now the Observatory pays its employees at exactly the same (or in some cases less) rate as in other branches of the government service in corresponding grades. To charge extravagance against

the Observatory because its employees are paid according to a rate fixed by law for the public service at large is clearly disingenuous and tending to mislead.

The whole report of the board is colored by the evident intention of making as strong a case against the Observatory, and in favor of its own plan of reorganization, as possible.

On page 6 the board objects to transferring responsibility of direction from the astronomical director to a committee, and then, on pages 7 and 8, recommends that the board of visitors 'shall prepare and submit to the Secretary of the Navy regulations prescribing the scope of the astronomical and other researches of the Naval Observatory and the duties of its staff with reference thereto.' In other words, the duties which should belong to the astronomical director, if he is to be held responsible for the astronomical work of the Observatory, are to be transferred to the board of visitors. Furthermore, on page 14, it is proposed that the board of visitors shall have power to make 'necessary changes,' apparently not only in the work, but also in the personnel.

On page 8 objection is made to retiring astronomers at 62 years of age, as is now done, and on page 6 it is specifically recommended that under the proposed new arrangement the astronomical staff of the Naval Observatory are to 'hold their offices until their successors are appointed,' or, in other words, they are to have no tenure of office at all, and to be liable to dismissal at any moment.

The pay table on page 9 proposes to give the astronomical director \$6,000 a year, and the director of the Nautical Almanac, \$5,000, making a total of \$11,000 a year, for the same duties which were then performed by Professor Harkness for \$3,500 a year. In view of the distinct charge of extravagance against the present administration, this proposal is only ludicrous. It is diffi-

cult to believe that it was intended to be taken seriously.

On page 12 it is asserted that the 9-inch transit circle was not then in use, although the board knew that it was simply undergoing periodical temporary repairs, and would be brought into use again as soon as they were completed.

On page 13 it is asserted that none of the directors of the Greenwich or Harvard College observatories 'have ever resigned to accept positions elsewhere,' but the author of the report forgets to mention that one of the Greenwich astronomers royal did resign.

On page 15 it is indirectly stated that when an observer is not actually observing he is only doing clerical work, which is untrue. The reduction of astronomical observations is not clerical work within the ordinary meaning of that phrase.

The statement on page 30 respecting the personnel of the Observatory board established by Rear-Admiral John Rogers is wholly erroneous. That board comprehended the entire astronomical staff of the Observatory.

In the list of professors of mathematics, given on page 41, Professor H. M. Paul is stated to be attached to the Naval Observatory, when in fact he is attached to the Bureau of Yards and Docks.

An historical sketch of the Naval Observatory, written by an individual member of the board, with the avowed purpose of showing that the system under which the Observatory has been administered since its foundation is entirely defective, is appended to the report. It is a sufficient criticism of this sketch to say that a system which, from a most modest beginning, has built up one of the few great astronomical institutions of the world, and which has produced the two most eminent living astronomers in America, can not be wholly bad.

It is particularly worthy of note that the board actually proposes to remove the affairs of the Observatory from Government control. The irresponsible governing authority of a public institution is to be 'a board of visitors independent of Government control, but having power to make necessary changes.' With the exception of this preposterous proposal, I will dismiss the plan of reorganization proposed by the board with the simple statement that subsequent events have made it impracticable, or at least highly unlikely, to be seriously considered now. To apply it at the present time would be, not to build up, but to tear down.

A determined effort was made by the board to prevent, if possible, the appointment of new men to fill the vacancies created by the retirement of the older professors of mathematics at the Observatory. New offices were created in the board's plan of reorganization, at enormous salaries. Notwithstanding the efforts of the board to prevent it, these vacancies have all been filled in line with the traditional policy of the Observatory, which has always been to take for its staff young men of promise whose career was before them, in contrast with the plan, recommended by the board, of appointing at once to high office men whose scientific reputation was already established, and whose prejudices and animosities were mature and confirmed.

I have ventured to touch in brief upon the report of the board of visitors in a manner which I trust does not transcend the legal limitations of this report, because, while the Observatory has been made the object of adverse criticism in the report, the friends and supporters of the board have not hesitated to assail it in attacks in the public prints, some of which have been extremely abusive and obviously dictated by pure malice, and with the knowledge that a reply in kind was impossible. This report

furnishes the only means of replying to these attacks, which are and have been perennial, culminating in force whenever, as in the present instance, circumstances seemed to justify a reasonable anticipation of success.

The Observatory staff is now complete. The excuse afforded by the retirement of the older professors of mathematics no longer exists. For the present, at least, no person, no matter how eminent he may be in science, can pretend to be a friend of the Observatory or of science while attacking its organization. I do not mean to say that the Observatory should be exempt from criticism; but such criticism, in order to be of any benefit, must be made in a spirit of fairness, and not in a spirit of animosity. The Observatory invited such criticism from the recent board of visitors, and its invitation was slighted.

The Observatory is making an earnest and honest effort to correct faults which have, in most cases, arisen from circumstances not wholly within its own control, as the board very well knew, but omitted to point out. It is only reasonable to ask that it be allowed a fair field for its efforts.

The experience with the recent board of visitors was not such as to encourage the hope that much good can be gained by a repetition of the experiment. Nevertheless, I recommend that a board of visitors be appointed from time to time, as may be convenient to the Department, not to act in an arbitrary and irresponsible capacity of authority, 'free of government control,' as recommended by the late board of visitors, but to give the Observatory the benefit of its counsel and to give the scientific world an insight into the actual workings of the institution.

[The following extracts from the report of the Astronomical Director refer to the instruments whose work is not summed up in the preceding report of the Superintendent.]

THE 6-INCH STEEL TRANSIT CIRCLE.

[Professor Milton Udegraff, U. S. N., in charge.]

\* \* \* \* \*

This instrument is made entirely of steel and mounted very solidly, so that the constants might reasonably be expected to be unusually steady. In the case of the level and collimation this expectation has been realized, but not in the case of the azimuth. Both the collimation and the level are remarkably uniform, excepting that on one or two occasions the latter has shown slight though anomalous changes. A series of experiments made in November, 1899, showed that the variation of the azimuth keeps pace regularly with the variation of the temperature of the steel in the microscope bearers on which the pivots rest. This variation is not, however, a linear function of the temperature, but is less per degree at low than at high temperatures. The change of azimuth per degree of temperature (Fahrenheit) during the earlier part of its use seems to have been 0".032. Since the instrument is provided with a meridian mark to the north, this variation of the azimuth has been productive principally of inconvenience rather than inaccurate work; but the change is too great to make the instrument a suitable one for fundamental work. The instrument will in the near future be entirely dismantled and a careful investigation made in the hope of finding the source of this variation.

THE PRIME VERTICAL TRANSIT INSTRUMENT.

[Assistant Astronomer George A. Hill, in charge.]

The work on this instrument has been devoted to observations of  $\alpha$  Lyræ and a small list of suitable stars for the purpose of investigating the variation of latitude and the constants of nutation and aberration. The number of observations is as follows:

$\alpha$ Lyræ.....	89
Other stars.....	75

A careful investigation of the level-constant, with a special reference to the coincidence and parallelism of the axis of the pivots, is in progress, but the material is not yet sufficient to determine whether any defect exists in regard to this which is of sufficient magnitude to affect the observations.

THE 5-INCH STEEL ALT-AZIMUTH INSTRUMENT.

[Assistant Astronomer George A. Hill, in charge.]

This instrument is used principally as a zenith telescope for observations of latitude by Talcott's method and the declinations of the stars of the American Ephemeris. Of the former there have been made 86 observations of  $\alpha$  Lyræ and three of miscellaneous stars, which are reduced up to date, and the results in January, 1900, together with the material from the prime vertical instrument, sent to Professor Albrecht. Of the declinations of Ephemeris stars 330 observations have been made, and the reductions are completed up to the end of the calendar year.

The results have not yet been subjected to sufficient study to determine the quality of the instrument for obtaining absolute declinations, for which purpose the general form of the mounting is admirably adapted. When its usefulness in this field is established I propose to separate the work of the two instruments and employ more observers in this important line of observation. I have not thought it expedient to attempt this until the arrears of publication are brought up—a task on which all the available force of the Observatory is now concentrated.

THE 40-FOOT PHOTOHELIOGRAPH.

[Photographer George H. Peters, in charge.]

The series of daily photographs of the sun has been continued, weather permitting, except after April 2d, when they were interrupted by the preparations for the observations of the total eclipse in May. Nega-

tives were obtained on 81 days, showing sun spots on 18, distributed as follows: Two in September, two in December, five in January, five in February, three in March and one in April. Visual observations of the sun in May indicate the same low state of solar activity.

#### STANDARD CLOCK.

Preparations are now in progress for installing a standard clock in a hermetically sealed case to be kept in a double-wall chamber at a constant temperature. The device for keeping the temperature constant is entirely similar to that now employed so successfully in the temperature room for testing chronometers. I consider this subject as one of the most important for the future of the fundamental work of the Observatory, and no pains or expense ought to be spared in securing the best possible performance of a standard clock under the conditions above described. I regret that the preparations for the eclipse so completely occupied the resources of the Observatory that this important matter has had to be laid aside until the present time.

---

#### AIMS AND METHODS OF STUDY IN NATURAL HISTORY.\*

I INVITE your attention to an old but still fruitful topic, namely, the aims and methods of study in natural history. It is a well-worn theme, but one that will retain its interest to the naturalist so long as natural history remains a progressive subject; and I venture to think that it was never more timely than at the present period of intense activity in natural science, of rapid development of new aims and methods, and of continually shifting point of view. How great the changes have been in the last

\* Presidential Address delivered at the annual dinner of the American Society of Naturalists, Baltimore, December 28, 1900.

twenty or even ten years is, I dare say, hardly realized by many of the younger generation of naturalists to-day. To appreciate their full extent one must be old enough to have passed his student days in the sixties and seventies, at a time when it was still possible to discuss the truth or error of the evolution theory; when the germ theory of disease was itself no more than a germ; when a gastrula or a karyokinetic figure was a thing to be spoken of with bated breath, but not to be looked upon when there were no oil-immersion-lenses or Abbe illuminators, no automatic microtomes, no ribbon-sections, no chromosomes or centrosomes, no shaking of eggs, no 'taxes' or 'tropisms'; when to adopt the career of a naturalist was to face the imminent prospect of extinction in the struggle with the environment, and to incur the half-admiring, half-contemptuous compassion of one's relatives and friends.

Speaking as I am in the presence of some of those who guided my own first tottering footsteps along the pathway of science, I feel some hesitancy in claiming a place among those veterans of the old guard; but I am nevertheless able to recall days when we had to do without all the things I have mentioned, as well as a good many others, both material and spiritual, that are now considered the very bread of life in the day's work. I will confess, too, that I am old enough to be at times lost in wonder at the child-like serenity with which the modern student will accept many of these matters, which cost such travail of the spirit, and at the distant epoch to which I have referred would have produced a sensation throughout the scientific world. When, for instance, Kleinenberg made the famous declaration 'Es gibt gar kein mittleres Keimblatt' it seemed to us that the sky must fall on such a blasphemy. We have changed all that. Cite those memorable words to-day, at the climax of your cautious discussion of the

germ-layer theory, and your *fin de siècle* student merely remarks stolidly, as he reels off a yard or two of ribbon-sections from his Minot microtome, "Of course not; but what is the use of talking about such an antediluvian myth?" It is enough to make Balfour turn in his grave!

I do not propose to review the advance of discovery in recent years, but only to offer a few reflections on the progress of our aims, methods and standpoints, taking as my point of departure Louis Agassiz's delightful little book, entitled 'Methods of Study in Natural History,' published in 1863. In this work we find a clear and simple exposition of the aims and methods of natural history as they appeared to a great naturalist and teacher before the theory of evolution had wrought its wonderful transformation in natural science. We all know that, as far as that theory was concerned, Agassiz ranged himself on the side of a losing cause, believing, to quote his own words, that naturalists were chasing a phantom in their search after some material gradation among created beings such as that theory demanded, though he was constrained to the admission that 'this notion' had a certain fascination for the human mind. I am here concerned with Agassiz's position on this question only in its bearing on his aim and method. It was Agassiz's aim, first, to observe phenomena with all possible accuracy; and, second, to arrange and classify them in order to discover the 'natural affinities' of living things. His method, on the all-importance of which he was never weary of dwelling, was that of his master, Cuvier, *comparison*. "The true method of obtaining independent knowledge" he says "is this very method of Cuvier's—comparison." "The education of a naturalist now consists chiefly in learning how to compare." It was not Agassiz's aim to analyze and explain phenomena, as Darwin was attempting to do. His whole theory of organic creation

precluded such an aim; for existing phenomena of life were viewed as the result, not of progressively operating causes, but of special creation, and 'natural affinities' among living things were but the expression of creative thought. It was enough for him to observe, compare and classify. In his work one is everywhere struck with the eager and enthusiastic delight that he took in the facts of natural history for their own sake. The key note of Agassiz's work was, in short, *the love of nature*, and his remarkable success as a teacher was mainly due to his power of inspiring a like enthusiasm in others. Such, in few words, were what seem to me the characteristic features in Agassiz's aim and methods. They may have for us later naturalists a useful lesson, both in their agreement with, and their contrast to, some of the latest *dicta* of modern writers on scientific method.

Leaving aside for the moment the subject of experimental physiology, we may say broadly that the progress of natural history since Agassiz's time has been along three general lines of study, though no very definite line of demarkation between them can be drawn. First came the development of comparative morphology, dominated by Agassiz's method of observation and comparison, but largely inspired by a theory of organic forms that was the very antipode of his own. Here belong the elaborate and exact modern investigations on general and systematic zoology and botany, on geographical and geological distribution and on comparative anatomy and embryology. In all these, a leading motive was to search for natural affinities and to interpret them in accordance with the theory of evolution. It has been a laborious and persistent quest, carried forward on a vast scale; and there is now hardly a corner of the plant or animal kingdom into which it has not been pressed. Its point of departure was primarily given by the comparative anatomy

of existing forms of life, supplemented by that of extinct forms. Almost from the start, however, it was evident that the data derived from those sources were sufficient without the additional evidence afforded by the facts of embryological development. Despite the high degree of validity possessed by the paleontological evidence, the record is, and is likely always to remain, too meager to guide us to the broader results we seek. Without the aid of embryology, comparative anatomy, with all its wealth of data, gives us hardly a hint of some of the most fundamental relations of living things. The high value of the embryological evidence was therefore early recognized; and with the progress of research it played a more and more important rôle in the examination of genealogical problems.

It seems a singular irony of fate that Agassiz, an anti-evolutionist, should have singled out as the most important result of his life-work a discovery in embryology, which, in connection with the generalizations of von Baer and Darwin, was destined to form one of the watchwords of a coming generation of evolutionists. "I have devoted my life to the study of Nature, and yet a single sentence may express all that I have done. I have shown that there is a correspondence between the succession of forms in geological times and the different stages of their growth in the egg—this is all." In another place he urges young students to turn to the study of embryology; for here, he says, lies 'an inexhaustible mine of valuable information—where we shall find the true facts by which to determine the various kinds and different degrees of affinity which animals bear not only to one another, but also to those that have preceded them in past geological times.' How little he foresaw the use which embryologists were soon to make of this principle or the lengths to which they

would go in its application. It was in that very year that Fritz Müller published the famous little book entitled 'Facts for Darwin,' which contained the first clear outline of the recapitulation theory and marked the beginning of the embryological search for genealogies, continued with so much ardor by Haeckel, Semper, Claus, Dohrn, Balfour and a hundred others. Many of us have eagerly followed the phases of that long quest or have sought to make our own modest contributions to it. We know how many puzzling problems of comparative morphology it has brought to a solution, how great an impulse was given to the investigation of natural affinities by the formulation of the recapitulation theory by Müller, Haeckel and their followers. I would be the last to question the immense interest and value of the results that have thus been achieved in the field of genealogical inquiry. And yet I believe that when these results, together with those derived from all other sources, are broadly viewed, we are constrained to the admission that comparative morphology as a whole has thus far solved only minor problems of descent, and that naturalists as a body are beginning to turn their attention in other directions. Let any one who doubts this compare the present attitude of naturalists towards some of the more general problems of descent with that of fifteen or twenty years ago. At that time the burning questions of zoological morphology centered in far-reaching genealogical hypotheses such as the *Gastrea* theory, the *Trochophore* theory, the *Nauplius* theory, the origin of vertebrates, the origin of metamerism, or the derivation of bilateral animals from medusoid or polypoid forms. They still remain questions of very high interest, but they are no longer the leading questions of the day; and we may as well admit the truth that interest in them is beginning to wane, temporarily perhaps, but unmistakably.



It will be worth our while to inquire into the reasons for this.

First, we cannot repress a certain feeling of dissatisfaction at the vagueness of our conclusions regarding many of these major problems. Our knowledge of the anatomy and development of the leading types of life is still very far from complete—indeed, the field before us remains so vast that we may never hope to exhaust its possibilities of research. We have, nevertheless, gained a fairly clear view of the general outlines of the system. But have we reached substantial agreement regarding the natural affinities of the great types? In a few cases, yes; but I think the candid naturalist must also reply, in most cases, no. How is it with that time-honored problem, the origin of vertebrates, in one way the most interesting of all, involving as it does our own remote ancestry? How is it with the origin of annelids or mollusks, of echinoderms, of platodes, of round worms or molluscoids? What are the historical relationships of the higher types to the Cœlenterata, of bilateral to radial forms, or of Metazoa to Protozoa? I dare say most of the morphologists present hold more or less definite views on these questions—if I, for one, am charged with holding such views on the zoological side I shall not defend myself or deny that all these are questions of high interest to me. But have we reached definite conclusions on which we are substantially agreed? I fear that a general discussion of the zoological members of this society would elicit but too emphatic a negative reply, and that a similar symposium of our botanical brethren would not set us a better example of unanimity. I do not doubt that the progress of research will in time bring us much nearer to a definite solution of these great problems; though it lies in the nature of the case, that we can never attain complete certainty. In the mean time, we may as well admit that in the application

of the embryological evidence to the broader problems of descent the recapitulation theory has encountered so many difficulties, undergone so many modifications and limitations, that investigators have in a measure wearied of their wanderings through the scholastic mazes of ancestral and secondary characters, of palingenesis and cenogenesis, of primary and adaptive forms and the like, and have sought for new interests and fresh motives of study. This is clearly apparent in the changed character of the more recent papers in embryology, which devote far less attention than those of ten or fifteen years ago to 'genealogische Betrachtungen' that once formed their inevitable climax. The relative decline of interest in genealogical questions is partly due, I think, to a healthy reaction against the inflated speculation into which morphologists have too often allowed themselves to fall; but it is also in large measure a result of the growing feeling that the solution of the broader problems of genealogy still lies so far beyond our reach that we would better turn for a time to the study of questions that lie nearer at hand and are, to say the least, of equal interest and importance.

We here arrive at a consideration of the two other great lines of progress to which I have referred. The first of these includes the modern developments of the cell theory, which have perhaps contributed equally with the evolution theory to the unification of biological knowledge. I need not dwell on the fundamental importance or the fascinating interest of the general results that have been attained in this field. The point on which I would lay emphasis is that investigation in this direction has only in very minor degree been inspired by the evolution theory or influenced by the historical point of view. The study of the cell, whether morphological or physiological, has been inspired by the desire to penetrate more deeply into the mechanism of

the existing living body. It has established a fundamental unity in the organization and modes of activity of living things, but it has thus far taught us little or nothing regarding their origin and progressive transformations. The interest of the results of cell-research, therefore, is of a different kind from that attaching to the genealogical problems of comparative morphology, and the one has grown, in some measure, at the expense of the other.

A no less potent influence has been the rapid infusion of experimental methods into morphological research, which forms the third line of progress in question, and is fast becoming the characteristic feature of latter-day biology; and with this we may briefly regard the far older subject of experimental physiology. When we regard the novelty and importance of the results already attained through these methods, it seems strange that morphologists were so long content to leave them to the almost undisputed monopoly of the physiologists; and I think that zoologists must admit further that, until recently, they have lagged behind the botanists in this regard. It would, however, be wide of the mark to maintain that experimental methods in morphology are a new product of the day. Did not Bacon, in the 'Novum Organum,' urge that living things are especially adapted for experiment, and in the 'Nova Atlantis' even project a scientific institution for experimental researches with reference to the problem of variation? More than a century before our time Trembley, Bonnet and Spallanzani showed how rich a field lay in the experimental study of regeneration; and Darwin later taught us what a wealth of suggestive results could be drawn from the long-continued experiments of breeders of domestic plants and animals. Nevertheless, it is only very recently that a definite program of experimental morphology has

\* Osborn, 'Greeks to Darwin,' pp. 92, 93.

been laid out, and that naturalists have begun to address themselves seriously to the task.

The revival of experimental methods in morphology is only in part due to a reaction against genealogical speculation. It is in at least equal measure due—and here we touch on a point that is vital to my present purpose—to the closer relations that have sprung up between morphology and physiology, and to the *development of comparative methods on the part of physiologists*. Animal physiology, long confined almost exclusively to the study of vertebrates, at last broke away from its earlier traditions and entered upon a new career, in the course of which it amalgamated with morphology. The traditional line between morphology and physiology thus faded away in zoology, as it had earlier done in botany, as naturalists advanced from either side into a neutral zone of inquiry devoted to the physiology of the lower animals and of the cell, to the activities of one-celled organisms, and to experimental studies on regeneration and development, and on cell-morphology; while in the study of habit, instinct, variation and inheritance the psychologist and even the sociologist have made common cause with us. We may well congratulate ourselves on such a solidification of aim and on the accompanying increase in the exactness and order of our method, and this not merely because of the value of the results attained, but in no less degree through the revival of interest in natural history, in the older sense of the word, that has accompanied it. We see the signs of this revival in many directions—in precise and far-reaching inquiries into the habits and instincts of insects and birds, and the life of animal communities; in renewed and more accurate ecological studies on plants and animals of almost every group, in the increasing interest in systematic zoology and botany, in the extended examination of the plankton of inland waters and the sea, in the rapid

development of exact statistical methods in the study of variation, and in many other ways, among which we should not forget the mention of the development of courses of instruction in the so-called 'Nature-study,' and the recent appearance of admirable text-books in which anatomical detail is largely—perhaps too largely—subordinated to the older natural history. I think, too, that we have a right in this connection to point to the influence that such associations as this Society have exerted in widening the range of common interests and fostering the spirit of scientific fellowship and cooperation.

With these changes has come a better understanding between the field naturalist and the laboratory morphologist and physiologist, who in earlier days did not always live on the best of terms. I shall never forget the impression made on me many years ago, shortly after returning from a year of study in European laboratories, by a remark made to me in the friendliest spirit by a much older naturalist, who was one of the foremost systematic and field naturalists of his day, and enjoyed a worldwide reputation. "I fear," he said, "that you have been spoiled as a naturalist by this biological craze that seems to be running riot among the younger men. I do not approve of it all." I was hardly in a position to deny the allegation; but candor compels me to own to having had a suspicion that while there may have been a mote in the biological eye, a microscope of sufficient power might possibly have revealed something very like a beam in that of the systematists of the time. However that may have been, it is undeniable that at that period, or a little later, a lack of mutual understanding existed between the field naturalist and the laboratory workers which found expression in a somewhat picturesque exchange of compliments, the former receiving the flattering appellation of the 'Bug-

hunters' the latter the ignominious title of the 'Section-cutters,' which on some irreverent lips was even degraded to that of the 'Worm-slicers'! (For the sake of completeness it may be well to add that at a later period the experimental morphologists fared no better, being compelled to go through the world under the stigma of the epithet 'Egg-shakers.') I dare say there was on both sides some justification for these delicate innuendoes. Let us for the sake of argument admit that the section-cutter was not always sure whether he was cutting an *Ornithorhynchus* or a pearly *Nautilus*, and that at times perhaps he did lose sight of out-of-doors natural history and the living organism as he wandered among what Michael Foster called the 'pitfalls of carmine and Canada balsam'; but let us in justice mildly suggest that the bug-hunter, too, like Huxley's celebrated old lady, was sometimes a trifle hazy as to whether the cerebellum was inside or outside the skull, and did not sufficiently examine that hoary problem as to whether the hen came from the egg or the egg from the hen, and by what kind of process. The lapse of time has in truth shown that each had something to learn from the other. The field naturalist came to realize that he could not attain right conclusions in the investigation of the larger problems before him without more thorough studies in anatomy and development. The laboratory morphologist learned better to appreciate the fact that his refined methods of technique are after all but a means toward the better understanding of the living organism and its relation to its environment. On both sides, accordingly, the range of common interests and sympathies was extended; and some of the splendid monographs of recent years bear witness to the value of the results that have flowed from the combination of anatomical, embryological, systematic and ecological research.

But now, in the last place, we encounter in the recent writings of some of the experimental morphologists a singular attitude of mind toward other methods of study and, in particular, toward the comparative method and the historical point of view in biology generally, for it is seriously maintained that the scientific study of organic nature is possible through experiment and through *experiment alone*. That I am not overstating the case will be evident from the following citations from recent utterances by an eminent leader in this field. "The comparative method in morphology," he says, "is in itself not science, but only a preparation for scientific work." Speaking for the self-styled 'rational morphologists' he says, "We have not a method of scientific morphology, but *the scientific morphological method*. There is but one productive method, and that is our method." The historical point of view in comparative morphology is of wholly minor value. Even could we accurately determine the ancestral origin of plants and animals—which in point of fact we cannot do—we should still not have solved the real problem—namely, the laws in accordance with which evolution has taken place. The most complete acquaintance with phylogeny would give us only an ancestral portrait-gallery, nothing more than a 'photograph of the problem.' Only through systematic experiment can we unveil the nature and limits of the power of transformation that lies at the root of the evolutionary process.

We may as well admit forthwith that there is a large element of truth in this bold claim, and it is well to recall how prominent a place the experimental evidence of evolution held in Darwin's mind. The history of science shows incontestably that only through experiment, through deliberately calculated and precise alterations in the conditions under which phenomena

occur, can we attain the limits of scientific analysis. So long, therefore, as the naturalist limits himself to the study of vital phenomena under natural conditions, he falls short of the highest ideal of scientific investigation. For my part, I am wholly ready to admit that the introduction of experimental methods into morphology is the most momentous step in biological method that has been taken since the introduction of such methods into physiology by Harvey and Haller. As regards the comparative method, I do not overlook the force of the argument that when comprehensive conclusions are attained by the mere elimination of facts that are not common to all the individual cases compared, those conclusions must have a more limited content than the collective data on which they are based, though I suspect that it would not require a very long search to discover a fallacy lurking here. But seriously to maintain that the non-experimental comparative study of nature is not science is an efflorescence of enthusiasm at which one could hardly repress a smile did it not involve so serious a blunder.

Now I certainly shall not undertake such a work of supererogation as a defense of the comparative method in natural history. Moreover, the statements cited were, I believe, intended mainly as a protest against too free genealogical speculation, and perhaps conveyed more than their author really intended. Yet the undoubted truth that they embody is masked by a form of expression so misleading, that even before this audience of naturalists I shall venture to place beside them the words of one or two of those best qualified to pass judgment on scientific method in the domain of physical science, which may rightly claim to be the experimental science *par excellence*. Helmholtz, in a discourse on the relation of natural science to general science, delivered at Heidelberg forty

years ago, said: "It is not enough to be acquainted with the facts; scientific knowledge begins only when their laws and causes are unveiled. Our materials must be worked up by a logical process; and the first step is to connect like with like and to elaborate a general conception embracing them all. Such a conception, as the name implies, takes a number of single facts together, and stands as their representative in our mind. We call it a general conception, or the conception of a genus, when it embraces a number of existing objects; we call it a law when it embraces a series of incidents or occurrences." What is the first example by which Helmholtz illustrated his meaning? It is one drawn not from experimental science, but from comparative anatomy, namely, the correlations of structure shown by the Mammalia. What was Helmholtz's estimate of the historical point of view in biology? Here are his own words, spoken ten years after the appearance of the 'Origin of Species': "The facts of paleontological and embryological evolution were enigmatical wonders as long as each species was regarded as the result of an independent act of creation, and cast a scarcely favorable light on the strange tentative method which was ascribed to the Creator. Darwin has raised all these isolated questions from the condition of a heap of enigmatical wonders to a great consistent system of development, and established definite ideas in the place of such a fanciful hypothesis as, among the first, had occurred to Goethe, respecting the facts of the comparative anatomy and the morphology of plants."

But, the 'rational morphologist' may reply, these words were spoken thirty years ago, and conditions have profoundly changed since Helmholtz passed this too favorable judgment. Let us see. In his address on the 'Principle of Comparison in Physics,' delivered before the German As-

sociation of Naturalists and Physicians at Vienna in 1894, that brilliant and versatile mathematical physicist, Ernst Mach, said: "Comparison, as the fundamental condition of communication, is the most powerful inner vital element of science." What is his first illustration of this truth? Again, as in the case of Helmholtz, it is drawn from non-experimental comparative morphology—from comparative anatomy and comparative embryology. "If it is not customary," he continues, "to speak of comparative physics in the same sense that we speak of comparative anatomy, the reason is that in a science of such great experimental activity the attention is turned away too much from *contemplative* element. But, like all other sciences, physics lives and grows by comparison."

It is needless to multiply such statements. Every really rational naturalist must admit that there is but one sane position to adopt, namely, to welcome any and every method by which our knowledge of organic nature may be advanced and unified. No one, I trust, will understand me to advocate the indiscriminate accumulation of facts—for this is not method, but the absence of method. The essence of science is not the accumulation of knowledge, but its organization. Observation and experiment give us our materials, but it is the comparison and correlation of those materials that first build them into the fabric of science. As I regard the matter, it is therefore a reversal of the true standpoint to regard biological classification, in the broadest sense of the term, as no more than a preparation for experiment. Let us, however, admit that our science is entering on a phase in which experimental methods seem destined, and rightly so, to take the leading rank, and that to them we may probably look for the greatest advances that are to be made in years to come. Let us, too, admit that our existing systems of classification, our views

of genealogical relationship, are incomplete, are in many respects still hypothetical and often misleading; that our methods of study have not been sufficiently exact; that a little judicious clipping of the wings of our scientific imagination will render its flight safer, even though it may not soar so high. But let us not depreciate the importance of the comparative study of normal phenomena to which biology already owes so many brilliant triumphs, and which, as we may confidently hope, has still so many future achievements in store. The true aim of the naturalist is to understand the conditions of living forms as they now exist and have existed in the past; but what are these conditions if not the result of an illimitable series of experiments, carried on by nature since life began? Under what other interpretation has the theory of natural selection any meaning? Comparative morphology and physiology but record and coordinate the results of these experiments. The experiments performed in our laboratories but supplement those that have taken place and are always taking place in nature, and their results must be wrought into the same fabric.

One final thought, and I have done. I have said that the key-note of Agassiz's life and work was his love of nature; and in this respect I believe he was typical of the great naturalists of every age. It has of late become the fashion in some quarters to look with a certain condescension on what is styled the 'sentimental side' of natural history, on that keen primary interest in biological phenomena for their own sake, apart from their scientific analysis, that was characteristic of so many of the earlier naturalists. I can but believe that such an attitude shows a lack of insight into the real motives and sources of inspiration of all great observers and discoverers. Every critical analysis of the progress of science leads to a recognition of the vital

importance of the imaginative faculty in all research of a high order; and in this regard great masters of creative science, such as Faraday or Darwin, have rightly been placed beside the great masters of creative art. But this faculty is nearly akin to the esthetic sense. Karl Pearson, in his admirable 'Grammar of Science' remarks, "Both works of art and laws of science are the product of the creative imagination, both afford material for the esthetic judgment." Pearson is here referring, it is true, to the sense of beauty and harmony aroused by the discovery and contemplation of natural law. Beyond this, however, we must recognize that there is no more potent spring of scientific research than a lively interest in the facts—in other words, the esthetic satisfaction that lies in the mere observation of natural phenomena. Read the intimate records of the lives of great discoverers in every field of science, and you cannot fail to be struck with this. From this source flows the impulse to analyze by experiment, to correlate by comparison and thus to discover law. The primary impulse of the naturalist is thus given by the love of nature; and I believe that the scientific naturalist should welcome every movement toward the cultivation of general interest in natural history. We may therefore regard it as a happy omen for the future of our science that in every direction we see the signs of increasing interest in field work, in nature-study and in the teaching of natural history in our schools. It would be an evil day for the more advanced and precise study of biology when it came to be regarded as actuated by motives having nothing in common with the love of nature that inspired such men as Darwin, Agassiz, Audubon and Gray; but we need not fear that such a day will come. For my part, I believe that the newer experimental study is better calculated to foster an interest in nature than much of the

minute anatomical and embryological work that has played so great a rôle in the laboratory methods of comparative morphology. These methods were a healthy reaction against the superficial character of much of the earlier work; they form the indispensable basis of all exact and thorough training in biology; but too often in our courses of instruction they have been carried to such a point that the student has lost himself amid anatomical detail of a kind as dry and formal as that of the old-fashioned systematic museum-study. Experimental research is already, I believe, exerting the happiest influence on our methods of teaching by showing how indispensable to a course in comparative morphology is the consideration of physiological phenomena and a study of the living organism.

I cannot better close than with the words that an eminent zoologist—we of this company have not far to seek him—has imagined to be the comment of Aristotle, could he have surveyed some of the aspects of our modern work in biology. "My teaching that the essence of a living being is not what it is made of, or what it does, but why it does it, has been rendered by one of your contemporaries into the statement that life is the continuous adjustment between internal relations and external relations. If this is true, is not the biology which restricts itself to the physical basis and forgets the external world, like your play of 'Hamlet' without the Hamlet? Is not the biological laboratory which leaves out the ocean and the mountains and meadows a monstrous absurdity? Was not the greatest scientific generalization of your times reached independently by two men who were eminent in their familiarity with living things in their homes?" I for one agree with the author of these words that such a comment would be good common sense and therefore good science.

EDMUND B. WILSON.

#### SCIENTIFIC BOOKS.

*Report of the United States Commission of Fish and Fisheries.* Part XXV., 1899. By GEORGE M. BOWERS, Commissioner. Washington, Government Printing Office. Pp. clxiii + 397. Plates XXIX + 21.

The contents of this the twenty-fifth report is divided into two portions, of which the first relates to the official and more practical work of the fiscal year, and the second to the special or more scientific work, the preparation of which may have extended over a considerable period.

In speaking of the general condition of the fishery industry, Commissioner Bowers states that the approximate value of the commercial fisheries of the United States in 1899 was \$40,000,000, to which the oyster industry contributed about \$14,000,000. In comparing the productiveness of the oyster beds of Chesapeake Bay and of Long Island Sound, Commissioner Bowers states that the natural supply of oysters is being exhausted, but that the areas of the sea bottom that are being artificially cultivated are becoming more and more productive. There is sufficient evidence that the increased abundance of cod, in the inshore waters of the New England States, is due to the work of artificial propagation carried on at Gloucester and at Woods Holl. Efforts are being made to rehabilitate the lobster fishery and to devise methods for increasing the number of sturgeon.

Under the direction of Dr. Hugh M. Smith, the Department of Scientific Inquiry has inaugurated or continued several important lines of investigation. The systematic survey of the physical and biological conditions of Lake Erie, begun in 1898 by Professor Reighard, has been continued. Dr. B. W. Evermann has made a biological survey of the waters of the Northwest; Dr. W. C. Kendall has continued his work on the fauna of the lake systems of Maine; and Dr. H. F. Moore has made a study of the physical conditions of Great Salt Lake, and has showed its absolute unfitness for maintaining any form of marine life.

The laboratories at Woods Holl and at Put-in-Bay have been occupied by an enthusiastic corps of investigators, and a building was rented at Beaufort, N. C., to serve as a temporary lab-

oratory. But with these matters readers of SCIENCE are well acquainted. The list of publications for the year numbers forty-six.

The work of the division under Mr. W. deC. Ravenel was the most extensive in the history of the Commission. More than one billiou fry were distributed. Mr. Ravenel's report is illustrated with many photographic reproductions and plans of the twenty-nine stations. Mr. C. H. Townsend's statistical tables will prove of inestimable value to those who in the future may wish to follow the rise and decline of the different fisheries. The capture of one hundred and forty bowhead whales by the Pacific fleet in the Arctic Ocean produced an eventful, even if only temporary, elevation in the curve of decline of the whale fishery. It is with a feeling of sorrow that one reads of the slaughter of four thousand sea elephants on Kerguelen Island.

The articles published in the appendix are of both general and scientific interest. Several have a tropical flavor. The papers of Mr. W. A. Wilcox, Mr. C. H. Townsend and Mr. J. N. Cobb are mainly economic. Messrs. Evermann and Kendall have prepared an acceptable check list of the fishes of Florida. New genera and species of fishes from Porto Rico are described by Messrs. Evermann and Marsh. Dr. Moore gives an interesting account of his 'Inquiry into the Feasibility of Introducing Useful Marine Animals into the Waters of Great Salt Lake,' and Dr. Rathbun contributes 'A Review of the Fisheries in the Contiguous Waters of the State of Washington and British Columbia.' The scope of this paper is limited to the fishery questions of the region that are of international concern. While such papers have an immediate interest, their value really increases as time goes on, for they give a record of the more primitive biological conditions, without which it would be quite impossible in the future to determine the changes that have been wrought in the natural productiveness of a region by the occupancy of man.

H. C. BUMPUS.

*Report on the International Cloud Observations.*

Prepared under direction of WILLIS L. MOORE, Chief of Weather Bureau, by FRANK H. BIGELOW, Professor of Meteorology. U.

S. Department of Agriculture, Weather Bureau. Report of the Chief of the Weather Bureau for 1898-99. Vol. II. 4to. Washington, D. C. 1900. Pp. 787. Charts 79.

The Report on the International Cloud Observations, just published by the Weather Bureau, is one of the most detailed and elaborate studies of clouds that has yet been issued. Professor Bigelow, who has been in charge of the reduction of the observations, has not limited his investigations to the tabulation and simple discussion of the heights, velocities, and directions of movement of the different clouds, but has gone far into the thermodynamic and hydrodynamic problems which grew out of his study of the cloud observations. As he himself says in his preface: "In order to submit these results to a careful discussion, it has been necessary to prosecute a critical comparative study of several important theories heretofore proposed by meteorologists, so that comparison between observations and theoretical computations can be suitably carried out. Accordingly, a standard mathematical system has been constructed, including in a definite notation the constants, the thermodynamic and the hydrodynamic formulæ pertaining to the atmospheric physical processes and motions, by means of which the work of the several authorities can be reduced to one set of typical equations. The theories of the American and German schools of meteorology have been contrasted, and the results derived from them have been compared with the facts obtained from these cloud observations." This quotation may serve to give some idea as to the thoroughness with which Professor Bigelow has done his work. Indeed, the report is the most comprehensive and important of the Government meteorological publications of recent years.

There are in all fourteen chapters, the first two of which relate to the methods of taking the observations, and of computing the heights, directions and velocities. Chapters 3 to 7 contain summaries of all the observations made with nephoscopes and theodolites, and the discussions of these observations. The subjects treated in the last seven chapters are as follows: 'The Typical Local Circulations over the United States,' 'Diurnal Oscillations of the Barometric



Pressure in Relation to the Diurnal Winds,' 'A System of Fundamental Constants and Formulae and Reduction Tables,' 'The Theory of Cyclones and Anticyclones,' 'Discussion of the Cumulus and Cumulo-Nimbus Clouds,' 'Reduction of the Pressure and Temperature Maps at Sea-level, 3,500-foot Level, and 10,000-foot Level,' 'The Amount of Heat that would Convert an Adiabatic Atmosphere into the State Actually Existing.'

The reading of this report cannot be lightly undertaken. Indeed, the very completeness of it and the elaborate mathematical discussions which find a place in it, will undoubtedly prevent many persons from attempting to find out what the volume really contains. We do not wish to be understood as saying that work of the sort that Professor Bigelow has here given us is unimportant, or out of place in a thorough study of the observations with which he has had to deal. Far from it. But we cannot help feeling, and feeling strongly, that the observers of the Weather Bureau, both regular and voluntary, and the public generally, should have the chief results of the international cloud observations in this country put before them in a simple, compact form. We hope that the chief of the Weather Bureau may look at this matter in the same light, and may perhaps sanction the publication of a Weather Bureau *Bulletin*, of say 100 pages, in which the results of Professor Bigelow's painstaking research, which are of most general interest, may be set forth.

Professor Bigelow is to be congratulated on the completion of this report, which stands on a far higher plane than most of the meteorological work published in this country.

R. DEC. WARD.

*Plane Trigonometry.* By DANIEL A. MURRAY, Ph.D., Instructor in Mathematics in Cornell University. New York, London and Bombay, Longmans, Green & Co. 1899. Pp. xiii + 301.

The author has aimed to 'avoid the extremes of expansion and brevity.' Only such topics are fully treated as make up the usual course in plane trigonometry. The thickness of the volume is largely due to the presence of an

appendix of historical and other notes, a long list of exercises for practice and review, a table of answers, a four-place and a five-place table of logarithms of numbers, a five-place table of logarithms of the sine, cosine, tangent and cotangent, a four-place table of logarithms (augmented) of trigonometric functions, and a four-place table of values of trigonometric functions. These components constitute little less than half of the book. The other and larger half contains an unusually full exposition of principles. The composition is throughout careful and scholarly. While acquiring a knowledge of the elements as here presented, the student can hardly fail to become aware of the larger aspects of the science.

As regards arrangement and disposition of matter, there is, of course, always room for difference of opinion. Doubtless many teachers would for example prefer to have the notion of the radian introduced at an earlier stage; and there are not wanting reasons of some weight for preferring to present the general ratio definitions of the functions in connection with the conventional system of coordinate axes boldly in the *beginning*, instead of reserving this most commanding point of view, as is here done, for so advanced a stage as Chapter V. However, in things pedagogical, *quot homines, tot sententiæ*.

It remains to say that while paper and typography are good, the book deserves to be more substantially bound.

C. J. KEYSER.

COLUMBIA UNIVERSITY.

#### BOOKS RECEIVED.

*A de Bary's Vorlesungen über Bakterien.* Edited by W. MIGULA. Leipzig, W. Engelmann. 1900. Pp. vi + 186. M. 4. 60 Pf.

*Outlines of Human Physiology.* F. SCHENK and A. GRÜBER, translated by Wm. D. ZOETHOUT with a preface by JACQUES LOEB. New York, Henry Holt & Co. 1900. Pp. viii + 339.

*Leçons de physiologie expérimentale.* RAPHAEL DU-BOIS. Paris, G. Carré and C. Naud. 1900. Pp. vi + 380.

#### SCIENTIFIC JOURNALS AND ARTICLES.

The *Journal of the American Chemical Society* for December contains the following articles: 'The Production of Alloys of Tungsten and of

Molybdenum in the Electric Furnace,' Charles L. Sargent; 'A Method for the Rapid Determination of Carbon in Steel,' Robert Job and Charles T. Davies; 'Determination of Iron in Magnetite Ore by the Specific Gravity Test,' Joseph W. Richards; 'Irregular Distribution of Sulphur in Pig Iron,' Randolph Bolling; 'The Composition and Analysis of London Purple,' J. K. Haywood; 'Detection of Foreign Coloring-matter in Spirits,' C. A. Crampton and F. D. Simons; 'A Rapid Method for the Detection of Aniline Orange in Milk,' Hermann C. Lythgoe.

THE December number (Volume 7, Number 3) of the *Bulletin of the American Mathematical Society* contains: 'Report of the October meeting of the Society,' by the secretary, 'On Linear Dependence of Functions of One Variable,' by M. Bôcher; 'Report on Groups of an Infinite Order,' by G. A. Miller; 'A Review of Ewing's Strength of Materials,' by Dr. Chas. Chree; 'A Review of Scheffer's Differential Geometry,' by J. M. Page; 'Notes'; 'New Publications.'

*Popular Astronomy* for January opens with an illustrated article by Miss Caroline E. Furness on the new 'Photographic Catalogue of North Polar Stars,' which has just been published from Vassar College Observatory. Professor Kurt Laves continues his discussion of the 'Adjustment of the Equatorial Telescope,' and Charles P. Howard his account of the 'Total Solar Eclipse.' Professor Francis E. Nipher's 'Positive Photography with special reference to Eclipse Work' is timely. Professor Herbert A. Howe, director of Chamberlin Observatory, of University Park, Colorado, begins his series of articles on astronomical books for the use of students. Professor Asaph Hall contributes a note on multiplication showing some peculiarly symmetrical results. The department of Astronomical Phenomena announces the eclipses of the coming year, and gives much space to news of comets, asteroids, etc. The number includes the usual general, spectroscopic and variable star notes, and W. W. Payne's second article on 'The Figure and the Attraction of the Earth.'

*Nature* announces that the Anthropological Institute will issue an anthropological journal

to be entitled *Man*, which will appear monthly. Special attention will be given to the data concerning the origin of those forms of civilization which have become dominant.

#### SOCIETIES AND ACADEMIES.

##### BIOLOGICAL SOCIETY OF WASHINGTON.

THE 330th meeting was held on Saturday evening, December 15th.

F. A. Lucas exhibited the under portion of the skull of a large specimen of the gar pike, *Lepisosteus tristoechus*, showing fracture and repair of the sphenoid. He stated that this was a good example of the fact that many animals could successfully recover from very severe injuries, since in the present case the breaking of the sphenoid must have entailed severe injury to and deflection of the entire cranium, and yet recovery had taken place. C. W. Stiles spoke of 'Some Tropical Parasites that may be introduced by our Returning Troops,' saying that the present conditions in China where troops were gathered from many parts of the world were particularly favorable for the interchange of parasites that were ordinarily confined to certain areas. The conditions in Manila were also favorable for attacks of parasites and their subsequent introduction into this country. The speaker described the various species of parasites that might be met with, their structure, mode of reproduction, the manner in which they entered the system and their effect upon it, illustrating his remarks by diagrams. But one or two of these species it was pointed out, were really to be apprehended, and as most of them were taken through the medium of drinking water, the danger could be almost entirely obviated by boiling the water.

E. W. Nelson presented a paper on 'The Caribbean Seal,' saying that while this was the first seal met with by the early explorers of the New World, and was an animal of considerable size and former extensive distribution, it was one of the least known of North American mammals and not accurately described until 1884. The various accounts of this seal, from the time of its discovery by the sailors of Columbus up to the present time were briefly no-

ted, the speaker then describing the habits of the animal as observed by him during a recent visit to the Triangles, in the Gulf of Campeche, to which the seal now appears to be restricted. They were sluggish and stupid, making practically no defense when attacked, and very easy to approach. While on shore they commonly laid on their backs, basking in the sun for hours, although the heat was so intense that iron exposed to the sun became too hot to handle with comfort, and dead seals soon had the epidermis so heated that the hair slipped off. Owing to the killing of these seals for oil, sold for lubricating purposes, their numbers had been greatly reduced, it being estimated that under one hundred were now living so that the extinction of the species would probably soon take place.

F. A. LUCAS.

#### TORREY BOTANICAL CLUB.

THE scientific program on November 28th consisted of a paper, soon to be printed, by Mr. Frederick H. Blodgett, on 'The Seed and Seedling of *Lilium tenuifolium* Fisch,' in which the seed characters were presented in detail, and with comparisons with those of *Erythronium*. Interesting differences were found in the size of the *Lilium* seeds about 93 per cent. of which germinated the small seeds as quickly as the larger, though with less vigorous subsequent growth.

On Tuesday afternoon, December 11th, the Club met at the Botanical Garden at Bronx Park. The program included a brief address by Professor Charles E. Bessey, a visit to the Garden conservatories with explanations by Dr. Britton, and the exhibition by Miss Anna M. Vail of valuable books recently added to the Garden library. Mr. R. M. Harper exhibited a very interesting series of specimens and photographs of plants from Georgia, and gave notes on their habitat and distribution. Dr. J. K. Small described a series of tree and shrub specimens from the south, with critical notes. Dr. D. T. MacDougal presented notes on the bulbils of *Lysimachia terrestris*. These bulbils are formed during the latter part of the season, in the axils of many leaves, and are morphologically branches. On completing their growth they

pass into rhizomes. They are killed by freezing and desiccation.

Another paper was by Dr. M. A. Howe, 'Remarks on rare North American Hepaticæ.' The first hepatic discussed was *Riccia Beyrichiana*, a species which was discovered about seventy years ago 'between Jefferson and Gainesville, North America,' by the German traveller Beyrich, but which has of late been a subject of considerable doubt, inasmuch as it has not been seen since. Now, however, it has apparently been rediscovered by Mr. R. M. Harper, who found it during the last summer at Athens, Georgia, scarcely more than twenty miles from the locality where it was evidently first collected.

Dr. Howe also furnished a brief account of a collection of Hepaticæ made in the Yukon region by Mr. R. S. Williams—a collection of much interest, inasmuch as it contained one species which appears to be entirely new, one which has not heretofore been reported from this continent, five others new to the Alaskan region, and, besides these, two or three which have been rarely collected in America. The report on Mr. Williams's Hepaticæ is soon to be published.

EDWARD S. BURGESS,  
Secretary.

#### THE ACADEMY OF SCIENCE OF ST. LOUIS.

AT the meeting of the Academy of Science of St. Louis of December 3, 1900, fifteen persons being present, Mr. William H. Roever, of Washington University, read a paper on 'Brilliant Points and Loci of Brilliant Points.' The paper gave the analytical conditions which define the brilliant point of a surface, the brilliant point of a space curve, the brilliant point of a plane curve and the brilliant point in space of two dimensions, when the source of light is such that the incident rays are normal to a given surface and the recipient is such that the reflected rays are normal to another given surface. Formulæ were given for the important special case in which the source and recipient are points. The paper also contained a general method for finding the equation of the locus of the brilliant points of a moving or variable surface or curve, together with a number of applications. Such loci may often be perceived when an illuminated

polished surface is rapidly moved, as when a wheel with a polished spoke is rapidly rotated. Another interesting example in loci of brilliant points is that of a circular saw which has been polished with emery in a lathe and thus received a great number of concentric circular scratches. The locus of the brilliant points of this family of scratches was shown in this paper to be a curve of the fourth degree. In the special case when the point source of light and the eye of the observer (the point recipient) are in a plane through the axis of the saw, the curve degenerates into a circle and two coincident straight lines. A photograph of the saw curve has been taken in which the optical center of the camera lens is the point recipient. Other interesting facts and a number of geometrical constructions were also given in this paper.

Three persons were elected to active membership in the Academy.

WILLIAM TRELEASE,  
*Recording Secretary.*

#### DISCUSSION AND CORRESPONDENCE.

##### THE ELECTRICAL THEORY OF GRAVITATION.

It is, perhaps, by the severe but impartial criticism of his work that the greatest of all possible obligations is laid upon the scientific investigator, for thereby his theories are purged of what may be incorrect or trivial, and that part of them which may be true is compacted and separated from what might otherwise hide its value, and cause it to be neglected.

Unfortunately I have been unable to profit as much as I felt I had a right to expect from Dr. Franklin's letter, *SCIENCE*, December 7th, as he has apparently been unable to find time for that careful examination and study which the subject, aside from the paper, demands. It is a matter of regret, also, in view of Dr. Franklin's admirable qualifications for dealing with the question, that he should have directed his criticism, in every single case, against theories which are the exact opposite of those which I hold, and which I have explicitly set forth in the paper referred to.

But though Dr. Franklin has with some slight lack of courtesy invited his readers to 'ignore'

my remarks on the methods by which my theory was deduced, I shall not return the compliment by 'ignoring' his criticism, because it contains a number of very serious misstatements which should be promptly pointed out, as otherwise they may become sources of error.

To consider, first, his criticism of my paper, he says (par. 1):

"Professor Fessenden in a recent number of *SCIENCE* discusses the nature and velocity of gravitation. There is, no doubt, something of value in Professor Fessenden's suggestions and much that is new. However, the explanation of gravitation which Professor Fessenden offers is by no means so adequate as would appear from Professor Fessenden's discussion."

On careful perusal we find his reasons for making this statement to be three in number. In regard to the first he says:

"If we admit that the diminution of volume of the ether at each point is proportional to the resultant intensity of the electric field, then the part of the energy which depends upon diminution of volume cannot be separated in its effects from the part of the energy which depends upon the shearing distortion, inasmuch as both are proportional to the square of the resultant field intensity. Therefore a diminution of volume of the ether could not explain gravitation, but would only be involved in the explanation of ordinary electrical attraction and repulsion."

But, *so far from my theory implying a diminution of the density of the ether at each point proportional to the resultant field intensity, F, I have expressly stated that the change of density is proportional to F<sup>2</sup>, as witness the following extracts from my paper:*

"Whilst the one which is a density must decrease with the *second* power of the corresponding intensity."

"And hence, as my experiments prove, the change in density is proportional to the *square* of the electric intensity."

As a matter of fact, even a cursory examination of my paper will show that the whole point of my argument rests on the fact that it is the *second* and not the *first* power which is involved. For the qualitative equation is

$$M/L^3 = T^2/L^2 \times M/LT^2,$$

*i. e.*, density varies with the inverse square of volitivity and directly as compressibility.

Since, then, my theory calls for a change in density proportional to  $F^2$  and since compressional energy varies as the second power of the compression, my theory makes the compressional energy vary as the fourth power of the electric intensity.

Dr. Franklin later says (last par.) :

"If, however, the compressional energy were proportional to the fourth power of the resultant field intensity, then \* \* \* gravitation would be provisionally explained."

Out of Dr. Franklin's own mouth, therefore, we have it that my theory provisionally explains gravitation.

As regards the second point, he says :

"Professor Fessenden, in his article referred to, speaks quite in general of the compression of the ether near a charged body, or ion, without localizing the distortion."

But this is not true. I have given the precise and exact distribution, par. 40, where I state,

"This change in density varies as the fourth power of the distance from the corpuscle."

I do not wish to complain, but no one cares to be continually misrepresented, and it is much to be regretted that Dr. Franklin was not able to note that I had covered the points he has criticised.

Thirdly, Dr. Franklin says (p. 889, 1st col. bottom):

"One might therefore expect that an hypothesis as to the constitution of matter which clears up the nature of inertia, even provisionally, would throw some light upon the nature of gravitation, but it does not seem to be so, and Professor Fessenden must needs say more from his point of view before we will be convinced."

But this is just what my theory *does* do. As I have pointed out elsewhere this is one of the very strongest points in favor of my theory, and in the paper criticised I have explicitly stated this, as, to quote (par. 41):

"The inertia of the atom is due to the electromagnetic inductance of the corpuscular charge, and gravity is due to the change of density of the ether surrounding the corpuscles, produced by the electrostatic stress of the

corpuscular charge. *Mass and gravity thus bear a constant ratio.*"

Having thus answered all of Dr. Franklin's objections to my theory, I must now call attention to some very serious misstatements.

To take the first one. He says (p. 887, par. 2):

"Professor Fessenden claims to have derived *numerical functional relations* [the italics are Professor Franklin's] with the aid of his Qualitative Mathematics."

Now it is very wrong to say this. If I were to write an article in a scientific paper, stating that Dr. Franklin believed that the earth was flat, and after stating that this was believed by scientists to be impossible, 'on definite rational grounds,' and inviting my readers 'to ignore' his arguments, Dr. Franklin would justly consider that he had reason for complaint. But he would not have so much of reason as I have, for whilst Dr. Franklin has never, to my knowledge, published his opinions on this matter, I have, in no less than four papers, *explicitly stated views which are the exact reverse of those Dr. Franklin attributes to me.* In the very paper he is criticising I say (par. 5):

"Qualitative Mathematics, as its name signifies, is used, *not for the exact determination of numerical values*, but for the prediction and classification of phenomena."

I really could not put it any plainer. I do not see why Dr. Franklin makes his statement. He cannot point to *any* statement or *any* work which I have ever done in which I have tried to deduce numerical relations by means of qualitative mathematics.

So far from this being the case, I have frequently stated exactly the opposite. As instance the above quotation. Also in my paper on the 'Nature of Electricity and Magnetism,' *Phys. Rev.*, Jan., 1900. Also, in my paper in the *Electrical World*, of some years ago, I point out very specifically that this same numeral coefficient, which Dr. Franklin says I have overlooked, cannot be determined by Qualitative Mathematics, and I then go on to point out, that since, this coefficient being of zero quality, we can always make it equal to unity by choosing suitable units, it is a matter of no consequence in discussing the *nature* of phenomena, however important it is as regards

the quantity of the action. Thus, so far from overlooking it, I called attention to it, no less than four years before Lord Rayleigh did, in the article of his which Dr. Franklin quotes.

So much for my theory. As regards my practice, one has only to read any of the papers in which I have used this method to see that I have never used other than experimental means to determine this unknown coefficient of zero dimensions. For example, in my paper on the nature of electricity, I first show that specific inductive capacity  $k$  is a density, and I then find, by experiment, what numeric  $k$  must be multiplied by to get the actual value of that density. Similarly, in the same paper, having shown that the magnetic coefficient  $a$  has the quality of hysteresis, I then proceeded, by experimental means, to find what the numerical relation between the two is.

A second misstatement is the following (p. 888, par. 4):

"Maxwell showed that the mechanical stresses in the dielectric tend to produce a diminution of volume."

There are no less than three mistakes in these lines. In the first place Maxwell never showed anything of the kind, and Dr. Franklin cannot refer to any passage in his writings where any change of volume, due to the electrically produced dielectric stresses is even hinted at. Second, the Maxwell stresses are incapable, as has been pointed out by several eminent physicists, of giving any diminution in volume, except on making assumptions not contained in Maxwell's theory or in his writings. Thirdly, the change in volume is not a diminution, but in the most general case an expansion, and only under certain conditions does it become a diminution.

Quinke had previously worked along that line, and found that some dielectrics expanded and others contracted, but did not give the law of the change. It was not until I had shown that contracting dielectrics behaved as negative uniaxial crystals in Kerr's phenomena, and did not obey the Maxwellian law,  $1/\sqrt{k\mu} = \text{velocity of light}$ , whilst expanding dielectrics behaved as positive crystals and did obey that law; also that the compression depended upon the square of the electric intensity and the compressibility,

and that mixtures and ionized compounds contracted whilst pure dielectrics expanded, that the phenomenon was exactly formulated, by me, as follows:

"All simple non-ionized dielectrics expand under electric stress, the change in volume being proportional to the square of the electric intensity, and inversely as the compressibility; they act as positive uniaxial crystals in Kerr's phenomenon, and obey Maxwell's law for the refractive index."

On p. 888, par. 2, he says:

"Physicists have known for many years" that attraction is to be attributed to ether energy, which decreases as the bodies approach each other."

Has this statement any basis of fact? Can Dr. Franklin adduce a particle of evidence to show that Hick's bubble theory, as developed by McAulay, or Newton's, or that theory of Bjerknæs's which Larmor seems to regard with some favor, is more probable than the old corpuscular one (of le Sage? I write away from my books). As a matter of fact, can Dr. Franklin refer to the slightest evidence that ether is necessary to transmit gravitational force? And if Kelvin's value for the ether constants were correct, would this not be very improbable? And had it ever been shown that the ether has the properties requisite to do it, before I showed it, a couple of years ago?

Still one more point, and I mention this because I think Dr. Franklin has been a little unfair. In writing of the electrical theories of matter, he does it in such a way, no doubt unintentionally, as to convey the impression that the theories I have advanced are not original with me, but form a part of the common scientific stock of knowledge. For instance, in speaking of the 'electrical hypothesis of the constitution of matter.'

But it was the writer who first introduced the idea of the universal association of the electrical charge with matter. I believe that it is a fact that Dr. Franklin cannot refer to a single sentence in all scientific literature in which this theory was put forward, still less any proof given, prior to my papers of 1891 and 1892 in the *Electrical World* and *SCIENCE*, with their contained proofs. Prior to that date the ionic

charge had never been considered in connection with the atom save in relation to chemical and molecular effects.

The last statement I shall criticise is the following: He says (p. 888, 3d par.):

"It is now pretty well established that the other energy having to do with electrical attraction and repulsion is dependent upon a sort of *shearing distortion* of the ether unaccompanied by any sensible diminution of volume, that this ether distortion is what is known as *electric field*, that the propagation of this energy constitutes *electrical waves*, and that the movement of the ether which comes into play during the establishment of this shearing distortion, or which comes into play while distortion at one place is relieved and distortion at a contiguous place is built up, is what is known as *magnetic field*."

Surely not!! So far from being established, Dr. Franklin cannot adduce the slightest particle of evidence for it. Though Maxwell and Lodge have used this theory, yet both Lord Kelvin and Professor J. J. Thomson have suggested exactly the opposite theory, and Heaviside has pointed out (Electromagnetic Theory, Vol. 1), that the theory which Dr. Franklin states is 'pretty well established' is at present as hard to reconcile with the facts as the other theory, so that the weight of authority would appear to be fairly evenly divided. And one of our greatest living physicists, J. J. Thomson, uses the opposite theory, of late exclusively. Moreover I have elsewhere pointed out that the variation of  $\mu$  with the first power and of  $k$  with the second power is conclusive proof that the opposite theory is true.\* If we chose to be uncon-

\* Those who are acquainted with my work on the nature of electricity and magnetism may remember that the proof that magnetism was a shear was based upon the following:

(a) The determination of the fact that either  $k$  or  $\mu$  must be a density, thus confirming Williams's result.

(b) The demonstration of the fact that whichever one of the two  $k$  or  $\mu$  is a density, must depend upon the first power of the corresponding force, whilst the other must depend upon the second power of the corresponding force.

(c) The experimental determination of the fact that  $\mu$  varies with  $H$  whilst  $k$  varies with  $F^2$ .

A second proof was then indicated, depending upon

vinced by this, then there is not the slightest evidence one way or another, and Dr. Franklin can add considerably to his already brilliant reputation by producing some evidence in favor of his statement.

REGINALD A. FESSENDEN.

#### A BIBLIOGRAPHIC CATCH TITLE FOR THE YEARS 1900 to 1999.

IN a note published in SCIENCE, May 11th, I called attention to a bibliographic matter which I wish to return to again.

Some twenty years ago I adopted the plan of placing all bibliographic titles at the end of an article in a single list with authors' names arranged alphabetically and each author's papers arranged chronologically. As an essential part of the plan, the citation in the text consisted simply in giving the author's name and the last two figures of the year of publication preceded by an apostrophe. To avoid ambiguity, in case two or more cited papers were published by an author in one year, the abbreviated dates were followed by a lower-case letter used as an exponent. This plan has been kept up since then in the 'Contributions from the Zoological Laboratory at Harvard College.' Owing to its simplicity and the evident advantage which it gives the reader by acquainting him at once with the date of the paper cited, this plan has come into rather common use.

The apostrophe used to mark the omission of the first two figures of the year-date could not be used without ambiguity for dates subsequent to 1899, and I have consequently urged in the note

the nature of the Lagrangian terms involved in the change of  $k$  and  $\mu$  in elastic phenomena.

I have now to add a third. Briefly stated it is as follows: Since either  $k$  or  $\mu$  is a density, then either  $H$  must be a shearing stress and  $F$  a velocity or *vice versa*. It is next shown that in the electric current we have a non-conservative system, and from quite general principles it is shown that it is the non-conservative system which must involve the velocities. And it is shown that under no circumstances could the equation expressing the amount of the  $I^2R$  loss be of the form it is if  $F$  were a shear, since in that case an operator which experiment shows is attached to an electric term would be connected with a magnetic term instead.

referred to that the apostrophe should be used to indicate an omitted 18, never an omitted 19. It then occurred to me that a comma might be similarly used to denote the omission of 19; but there seemed to be such important objections to this, that I dismissed the matter without further thought until, a few weeks ago, I received a letter from Mr. R. Pearl of the University of Michigan, in which he urged the desirability of adopting some method of abbreviation, and suggested the use of a period. There are, however, quite as serious objections to a period as to a comma. After some correspondence on the matter it has seemed to both of us that the *colon* so used would afford the best solution to the problem; but in order to avail ourselves of other possible suggestions, we desire to call attention to the matter in SCIENCE.

The signs hitherto considered and some of the more obvious objections to them are the following: The *comma* would be objectionable because in almost every citation two commas—one for punctuation, the other to mark the elision—would be brought together, and no proof-reader could be expected to accustom himself to the anomaly; thus in a recent publication, if the dates had been 1993, etc., instead of 1893, etc., the use of the comma would have given this undesirable result: "In Anurida, as in Orthoptera (Wheeler, ,93; Heymons, ,95<sup>b</sup>) and Lepisma (Heymons, ,97<sup>a</sup>), etc." The *period* is so commonly used as a decimal point, that .93 or .97<sup>a</sup>, for example, would be misleading. It would clearly be of some advantage to have a character that should stand, like the apostrophe, on a line with the tops of the figures; but the various signs which usually have that position, as the asterisk, obelisk, etc., have such a fixed usage, as a means of referring to footnotes, that it seems unwise to employ any of them for this purpose. An *inverted period* would be open to the objection that a defective apostrophe could not be distinguished from it. The *dash* takes up too much room; the *hyphen*, though shorter, is not better in this respect than the colon, and has the disadvantage that, in the case of papers occupying more than a single year in publication, it now has to serve for omitted digits which might, or might

not, be the figures 19, for which we should wish it invariably to stand.

So far as I recall, there is only one usage, except that of ordinary punctuation, to which the colon has been put that would be liable to interfere with its use for the purpose contemplated here. It has been used to separate the number designating a volume from that designating the first page of an article in that volume—a substitute for the letter *p*. Since in the proposed usage the colon would stand between the name of the author cited (not a number) and the last two figures of the year in which his paper was published, I think no ambiguity could arise. If, however, serious objections to the use the colon, or a better plan, occurs to any one interested in the matter, both Mr. Pearl and the writer would be glad to profit by suggestions communicated through SCIENCE or directly.

E. L. MARK.

HARVARD UNIVERSITY,

December 13, 1900.

#### ASTRONOMISCHER JAHRESBERICHT.

EACH year there is being issued under the editorship of Professor Dr. W. Wislicenus, from the press of Georg Reimer, an *Astronomischer Jahresbericht*, or annual review of all kinds of *astronomical publications*, including writings on geodesy and navigation if not too remotely connected with astronomy. This work is carried on under the supervision of the *Astronomische Gesellschaft*. The first volume contains the publications of 1899, and consists of xxiv + 537 pages, 8vo. This was issued in the spring of 1900.

In the interests of publishers, of readers and of the nation which he represents, the associate-editor for the United States desires to make the compilation and review of American publications on the above named subjects as complete as possible. To this end he invites authors and publishers to favor him with the title and place of publication of each book or article issued during 1901 and each subsequent year or a copy of the same if convenient that it may be reviewed for this purpose. The reviews are merely explanatory—not critical.

HERMAN S. DAVIS.

INTERNATIONAL LATITUDE OBSERVATORY  
GAITHERSBURG, MARYLAND.



DIFFRACTION GRATINGS FOR GRATUITOUS  
DISTRIBUTION.

TO THE EDITOR OF SCIENCE: Two or three years ago while engaged in some experimental work on the reproduction of diffraction gratings by photography, I devised a method of copying a Rowland 14,000 line to the inch grating, and silvering the copy, transforming it into a reflecting grating. The original was an excellent glass grating kindly loaned to us by the Johns Hopkins University. I was unable to get satisfactory copies with the bichromated gelatine but succeeded very well with albumin. I found this difficulty, however. To reproduce so fine a spacing it was necessary to use an exceedingly thin film, so thin, in fact, that the retardation of the light waves in traversing the 'bars' was insufficient to give spectra of any brilliancy. By thickening the film I was able to get a brilliant grating occasionally, but usually the lines ran together. It then occurred to me to silver the gratings, for the retardation by reflection is four times the retardation by transmission. The thin film failures, which I had thrown into a drawer as scrap plate-glass, were accordingly immersed in a chemical silvering solution, and when washed and dried were found to give brilliant spectra. One of these was exhibited by Professor Boys at a conversation of the Royal Society about two years ago. Having about thirty of these gratings, which, while not as perfect as an original Rowland grating, being made on ordinary plate glass, are nevertheless suited for the ordinary purposes of the laboratory, I am desirous of placing them where they will do the most good. There must be among our many universities some physical laboratories which are not fortunate enough to have a good diffraction grating. I shall be very glad to distribute these copies to laboratories desiring them, as long as the supply holds out. I shall be glad if applicants will state whether the laboratory possesses a good spectrometer, and also the number of students engaged in the pursuit of physics. Some of the gratings are very good indeed, others quite poor as to general appearance, but all will give tolerably good spectra, and can be used for wave-length determinations. They will show the nickel line between the sodium lines in the solar

spectrum very distinctly. Applications from high-schools will not be considered. Failure to receive any reply must be taken as evidence that the supply has been exhausted.

R. W. WOOD.

UNIVERSITY OF WISCONSIN.

NOTES ON INORGANIC CHEMISTRY.

ARGON AND ITS COMPANIONS.

ON November 15 a paper was read before the Royal Society by Professor William Ramsay and Dr. Morris W. Travers on 'Argon and its Companions,' which was a continuation of the previous papers of the same author on the inert gases of the atmosphere. In the early summer of 1898 the discovery of neon and krypton was announced, and later a heavier atmospheric gas was found, to which the name xenon was given. At that time krypton and xenon were not obtained in a condition pure enough for the investigation of their physical constants.

The present paper deals chiefly with these three gases, which have been isolated and studied. By the evaporation of a large amount of liquid air a mixture of argon, krypton and xenon was obtained, the former largely predominating. This mixture was liquefied by liquid air and the three separated by fractional distillation, many times repeated. At the temperature of boiling air krypton has considerable vapor-tension, while that of xenon is scarcely appreciable. Neon was isolated from the first portion of gas escaping from boiling air. This consisted chiefly of nitrogen, which was then liquefied and a part of the liquid evaporated by passing through it a current of air. This gas, after the removal of the oxygen by hot copper, contained most of the helium and neon present in the air. After purification from nitrogen in the usual manner, the helium and neon were separated from the argon present by fractional distillation. To separate these gases was very difficult, but was finally accomplished by condensing the neon by means of boiling hydrogen. In this way pure neon was obtained.

A determination of the ratio of the specific heats of these gases showed that they are all monatomic. A number of the physical prop-

erties of these gases were determined, which are given in the following table :

	Helium.	Neon.	Argon.	Krypton.	Xenon.
Refractivities (Air 1).....	0.1238	0.2345	0.968	1.449	2.364
Densities of gases (O=16).....	1.93	9.97	19.96	40.88	64
Boiling points at 760 mm.....	?	?	86.9° abs.	121.35° abs.	163.9° abs.
Critical temperatures.....	?	Below 68° abs.	155.6° abs.	210.5° abs.	287.7° abs.
Critical pressures.....	?	?	40.2 m.	41.24 m.	43.5 meters.
Vapor-pressure ratio.....	?	?	0.0350	0.0467	0.0675
Weight of 1 cc. of liquid.....	?	?	1.212 gms.	2.155 gms.	3.52 gms.
Molecular volume.....	?	?	32.92	37.84	36.40

In the vacuum tube neon is extremely brilliant and of an orange-pink hue, and is characterized by multitude of intense orange and yellow lines; krypton is pale violet, and xenon is sky-blue.

The five elements clearly form a series in the periodic table, between the seventh and the first groups, that is, as a transition from the most negative to the most positive group. This is of the greatest interest, since in two recently published papers Ladenburg has given the atomic weight of krypton as about 59, placing the element between nickel and copper. It could thus find no place in the periodic table, as it is now understood. On the other hand, as determined by Ramsay and Travers, the elements find a natural place in the eighth group, as a transition from the negative series of the seventh group to the positive series of the first group.

J. L. H.

#### THE RESIGNATION OF PRESIDENT MENDENHALL.

MEN of science everywhere will learn with deep regret that Dr. Thomas C. Mendenhall has been compelled by ill health to resign the presidency of the Worcester Polytechnic Institute. Fortunately President Mendenhall's health has only been injured by the great amount and responsible character of the work he has undertaken, and there is every reason to believe that after rest in Europe he will return prepared to continue work as important as that which he has already accomplished at the Ohio

State University, the Imperial University of Japan, the U. S. Signal Service, the Rose Polytechnic Institute, the U. S. Coast and Geodetic Survey and the Worcester Polytechnic Institute. It is known to all men of science that, while occupying executive positions of great responsibility, President Mendenhall has carried out scientific researches of the utmost importance, and has taken an active part in all movements for the advancement and diffusion of science in the United States. He is one of the most efficient members of the National Academy of Sciences and of the American Association for the Advancement of Science, of which he has been president. He is now president of the American Metrological Society, chairman of the Massachusetts Highway Commission and a leader in many important scientific movements. As one of the editors of this journal since its reorganization six years ago his services have been invaluable. The grounds of President Mendenhall's resignation, the reluctance with which it was accepted and the great value of his work at the Worcester Polytechnic Institute is shown by the following letters. The letter of resignation, dated October 15, 1900, is as follows :

Hon. Stephen Salisbury,  
President, Board of Trustees.

Worcester Polytechnic Institute :

Dear Sir :

I hereby tender my resignation as president of the Worcester Polytechnic Institute, to take effect on the first of July next.

I send this communication so long in advance in order to afford ample time for the selection of a suitable person to fill my place, and I hope I may be allowed to add a few words in acknowledgment of the continued and unvarying kindness which the board of trustees have shown me during my connection with the institute.

As far as I can now remember every suggestion I have made relating to the management of the institute has been approved by the board and every plan for its betterment that I have submitted has received its cordial, unanimous and hearty support. My personal relations with the members of the board have been, without exception, agreeable; everything that they could do to make my administration successful and my life in Worcester pleasant has been done, and I cannot give measure, however much I might multiply words, to the feelings of appreciation and grati-

tude with which I must always regard their considerate treatment of me during my term of service.

Naturally it is with great regret that I look forward to the early breaking off of a relation which has been to me so satisfactory. During the past year the condition of my health has been such as to cause much anxiety and this has been increasingly so during the past few months. The conclusion has been forced upon me that I must indulge myself in a long vacation or period of rest as free as may be from care and responsibility, too long to be for a moment considered compatible with a continuance of my connection with the institute. While thus compelled to sever this connection, there is no small consolation in the fact that I leave the institution at a period which may fairly be called the most prosperous in its history. Its numerical strength has not before been equalled; its next graduating class will be larger than any that has preceded it; its material equipment in the way of apparatus, machinery and other appliances for instruction has been greatly increased during the last few years and is now as nearly adequate as that of the best institutions of its class; during the same time new departments have been developed and specialization has increased; its internal affairs are directed by a relatively large, able and harmonious corps of instructors, and it is everywhere admitted to be in the front rank of the engineering schools of the country. Whatever progress towards this end has taken place during my administration, I wish to attribute to the generous support of the board of trustees, the cordial and enthusiastic cooperation of the faculty, the earnest and conscientious devotion to work which is and, I think, always has been characteristic of the student body, and, finally, the growing interest of the alumni, now nearly a thousand in number, scattered over the civilized world. The latter has been specially manifest on the organization of a number of new and active Alumni Associations, one of which is now to be found in almost every city of the first importance.

Under the continued fostering care of those who have so generously and unselfishly supported it in the past and with any one whom the board of trustees may select at its head, I shall confidently expect it to maintain its rank among the leading exponents of technical education.

I need hardly say that it will ever be a pleasure to me to further its interests in any way in my power.

I am yours faithfully,

T. C. MENDENHALL.

On December 20th in reply, the following communication was sent to Dr. Mendenhall by

the committee on the part of the board of trustees:—

President T. C. Mendenhall, Ph.D., LL.D., Worcester Polytechnic Institute:—

Dear Dr. Mendenhall:

Your letter of October 15, 1900, resigning your office as president of the Worcester Polytechnic Institute, has been received by the trustees with expressions of profound surprise and regret. They deeply deplore the cause which alone necessitates this action on your part. They have been very slow and unwilling to admit the fact. In conference with you and at repeated meetings of the board, they have earnestly sought to find some way by which such a serious loss as your permanent separation from the institute might be averted. They are, however, compelled to recognize that your reasons leave them no option, either as respects your interests or those of the institute, and they therefore reluctantly accept your resignation as president of the institute to take effect, as you request, July 1, 1901.

In thus regretfully acceding to your request, the trustees wish to thank you for your thoughtful consideration of the welfare of the institute in giving them timely notice of your decision, and for the most courteous terms in which you have made it known to them. They also desire to communicate to you and to place on record their high and grateful appreciation of your laborious, devoted and successful service for the institute. During your administration, which in July will cover seven years, the institute has steadily grown in its productive endowment; in the size and value of its plant; in the excellence of all its facilities; and in the number of its faculty, instructors and students. New buildings have been erected and equipped. Large additions have been made to machinery and apparatus. The courses of study have been extended, revised and brought to the highest standards. The success, high rank and deserved fame of the institute have been greatly and solidly increased. All this has, in large measure, been due to your wisdom, faithfulness, tact and unwearied courtesy as president.

Nor would the trustees fail most cordially and thankfully to recognize the distinction which your ability as a scientific man, your skill and charm as a lecturer, and your ready, valuable and public spirited service of the city and the commonwealth, have given to the institute. In all these and similar directions your departure from among us will leave a vacancy not easy to fill. This adds to the pain with which, not only the institute, but also the city and the state, will lament your forced retirement on account of impaired health.

The trustees assure you that they fully reciprocate your expressions of personal esteem and of gratitude for the most amicable relations which have always existed between them and you. They earnestly hope that the rest and relief from responsibility to which you look forward will speedily result in your complete restoration to health and in fitness for increased usefulness and happiness, and to this end their good wishes will always follow you.

We remain, dear Mr. Mendenhall, on behalf of the trustees and with high regard, faithfully yours,

STEPHEN SALISBURY,  
DANIEL MERRIMAN,  
C. G. WASHEURN,  
*Committee of Trustees.*

---

THOMAS A. WILLIAMS.

WE learn with much regret of the death of Professor Thomas A. Williams, assistant-chief of the Division of Agrotopology, U. S. Department of Agriculture, and a well known authority on botany and agriculture. He died at his home, near Washington, on December 23d, at the early age of thirty-five years. The high esteem in which Professor Williams was held by his colleagues is expressed in the following resolutions:

It is with feelings of profound sorrow and regret that we, the employees of the Department of Agriculture, learn that death has removed from among us our beloved companion and co-worker, Thomas A. Williams, a classmate and intimate associate of many of our number. His broad knowledge of scientific matters, his keen appreciation of nature, his kind and forbearing disposition has endeared him to all. He was known to his associates as an indefatigable worker and investigator.

*Resolved*, That in the death of Professor Thomas A. Williams, science and agriculture have suffered a great loss, and we, his associates, a dear friend, whose self-forgetfulness in his kindly consideration for the feelings of others, and uniform cheerfulness, often under conditions of severe physical suffering, revealed a lovable character of the highest Christian type. The loss to the Division of Agrotopology is irreparable. In the performance of his official duties he had proved himself an excellent executive and an organizer of unusual merit and his relations with his associates in office were always such as to command the highest esteem and respect. He never shirked a duty, and however difficult the undertaking, the work performed by him was done most creditably. His loss will be felt most keenly by his associates in the di-

vision, and his memory will remain with them as one whose exemplary life and steadfastness of purpose they should strive to emulate.

*Resolved further*, That we tender to his bereaved family our heartfelt sympathy in their great loss and invoke for them the blessing of the Heavenly Father, who alone can heal the broken heart and give lasting comfort.

*Resolved*, That copies of these resolutions be sent to the family of the deceased and to the various daily and scientific journals.

COMMITTEE ON RESOLUTIONS FOR THE  
DEPARTMENT OF AGRICULTURE.

WASHINGTON BIOLOGISTS' FIELD CLUB.

WASHINGTON, D. C., December 27, 1900.

*Whereas*, We have learned with sorrow and a sense of deep personal loss of the sudden death of our fellow-member, Thomas A. Williams.

*Resolved*, That the Standing Committee of the Washington Biologists' Field Club voices the feeling of every member in paying tribute to the memory of Mr. Williams, whose gentle and kindly disposition, charming good-fellowship and sterling qualities endeared him to every one of us. We recall with pleasant remembrances his interest in the work of the Club and its social relationships, as well as the many delightful hours spent with him in the field. We extend our heartfelt sympathy to Mrs. Williams in this the hour of her great bereavement, which we hope may be lightened by the thought that he passed away in the same peaceful and tranquil spirit in which he had lived.

*Resolved*, That a copy of this tribute be sent to the family of the deceased, and that it be published in *The Plant World*, of which he was an editor, and in SCIENCE.

By direction Standing Committee,  
Washington Biologists' Field Club,  
CHARLES LOUIS POLLARD,  
*Chairman.*

---

THE AMERICAN SOCIETY OF NATURALISTS.

THE Society met at Johns Hopkins University, Baltimore, on the 27th and 28th of December. In addition to serving as a center for the important affiliated societies devoted to the natural sciences, the Society as usual had what may be regarded as two scientific sessions. The address of the president, Professor E. B. Wilson, printed above, was given at the annual banquet on Friday evening, and on Thursday afternoon a discussion, which will also be printed in this Journal, took place, its

subject being 'The Attitude of the State towards Scientific Research,' and the speakers being Professor H. F. Osborn, Dr. L. O. Howard, Professor W. B. Clark, Dr. B. T. Galloway and Professor William T. Sedgwick.

The business transacted by the Society included an appropriation of \$50 toward the support of the university table at the Naples Zoological Station, and \$50 to support a table at the Marine Biological Laboratory at Woods Holl. It was also voted that a committee of five be appointed by the incoming executive committee to select appointments to the university table at Naples, and to raise, if possible, additional funds for its support. A resolution was passed protesting against the duty on wax and other models intended for scientific research in educational institutions.

The most important business transacted by the Society was the consideration of its relations to the Naturalists meeting simultaneously at Chicago. The action taken was as follows: (1) Section 1, of Article IV, which limited the territory for holding meetings, was stricken out of the Constitution and was transferred to the By-Laws. (2) This By-Law was temporarily set aside for the purpose of providing for the meeting of the Society in Chicago in 1901. (3) The Executive Committee was empowered to confer with those interested in the formation of a Western Branch of the Society.

Officers for the ensuing year were elected as follows:

*President*, Wm. T. Sedgwick; *Vice-Presidents*, L. O. Howard, L. M. Underwood, J. Walter Fewkes; *Secretary*, A. D. Mead; *Treasurer*, M. M. Metcalf; *Executive Committee from Society at Large*, G. H. Parker, J. McK. Cattell.

#### THE AMERICAN ASSOCIATION FOR THE ADVANCEMENT OF SCIENCE.

A MEETING of the Council of the American Association for the Advancement of Science was held at Johns Hopkins University, Baltimore, at one o'clock on December 28th, with the president of the Association, Professor R. S. Woodward, in the chair. Professor C. S. Minot, the president-elect, was also in attendance.

The permanent secretary, Dr. L. O. Howard,

made a report on the affairs of the Association, including the preparations for the meeting next August at Denver. Professor L. G. Carpenter has been in charge of the local arrangements, and has visited the officers of the Association and the leading scientific centers of the Eastern States in the interest of the meeting.

Local committees were appointed in a large number of places throughout the country to forward the interests of the Association in different regions.

A committee was appointed to inquire whether universities and other scientific institutions would set aside a week during the winter for the meetings of scientific and learned societies.

Miss Watson presented her resignation as assistant secretary of the Association, and was elected a life member in recognition of her long and efficient services.

247 new members were elected, which makes the total membership of the Association over 2,000.

The contract made by the Association with The Macmillan Company was presented. It carries out the arrangements made at the New York meeting, in accordance with which SCIENCE is sent free of charge to all members of the Association.

#### SCIENTIFIC NOTES AND NEWS.

WE expect to publish in early issues accounts of the scientific proceedings of the societies that met during Christmas week. In the meanwhile it may be stated that Professor W. T. Sedgwick, of the Massachusetts Institute of Technology, has been elected president of the American Society of Naturalists; Professor J. S. Kingsley, of Tufts College, president of the American Morphological Society; Professor W. H. Welch, of the Johns Hopkins University, president of the American Society of Bacteriologists; Dr. Erwin F. Smith, U. S. Department of Agriculture, president of the Society of Plant Morphology and Physiology; Dr. Frank Russell, of Harvard University, president of the Folklore Society; Professor Josiah Royce, of Harvard University, president of the American Psychological Association; Professor E. H. Moore, of the University of Chicago, president of the

American Mathematical Society, and Professor W. F. Clarke, of the U. S. Geological Survey, D. C., president of the American Chemical Society.

The Presidents of sections for the meeting of the British Association for the Advancement of Science, which will be held in 1901, at Glasgow, commencing on September 11th, will be as follows :

Section A.—Mathematical and Physical Science, Professor Percy A. MacMahon, F.R.S.

Section B.—Chemistry, Professor Percy Frankland, F.R.S.

Section C.—Geology, Mr. John Horne, F.R.S.

Section D.—Zoology, Professor Cossar Ewart, F.R.S.

Section E.—Geography, Dr. H. R. Mill, F.R.G.S.

Section F.—Statistics and Economic Science, Sir Robert Giffen, F.R.S.

Section G.—Engineering, Mr. R. E. Crompton.

Section H.—Anthropology, Professor D. J. Cunningham, F.R.S.

Section I.—Physiology, Professor J. G. McKendrick, F.R.S.

Section J.—Botany, Professor I. Bayley Balfour, F.R.S.

At the annual election of the New York Academy of Medicine on December 20th, the following officers were chosen: *President*, Dr. Robert F. Weir; *Vice-President*, Dr. Charles M. Dana; *Recording Secretary*, Dr. John H. Huddleston; *Corresponding Secretary*, Dr. Louis F. Bishop.

At the meeting of the Royal Statistical Society, on December 18th, a Guy medal was awarded to Mr. J. A. Baines, for his services to statistical science and a Howard medal and a prize of one hundred dollars to Dr. J. F. J. Sykes for his essay on 'The Results of State, Municipal and organized Private Action on the Housing of the Working Class in London and other Large Cities in the United Kingdom.'

PROFESSOR W J MCGEE, of the Bureau of American Ethnology, has returned to Washington from a field trip through parts of Arizona, Sonora and Lower California. Outfitting at Phoenix about the middle of October, he traversed the sparsely settled plains southward to the International boundary at Santo Domingo, and thence to the village of Carborca. From this point the party worked down the sandwash of

Rio San Ignacio (or Rio Altar) to the coast of the Gulf of California, where the Tepoka Indians lived until recently. Finding this tribe extinct, the expedition returned by a new route to Santo Domingo, and took the historical Yuma trail—now completely abandoned—to Rio Colorado. Here the territory of the Cocopa Indians was visited, and fairly extensive collections were for the first time made among them. Mr. DeLancey Gill, artist of the expedition, secured numerous photographs and sketches of the tribes and their territory.

DR. L. A. BAUER, in charge of the magnetic work of the United States Coast and Geodetic Survey, returned to Washington on December 15th, after having determined the sites of the base stations for the magnetic surveys in Alaska and in the Hawaiian Islands.

COLONEL FIVE, who was in 1896 sent by the Belgian Government on a scientific expedition to the far East, has returned home.

A MEMORIAL is being formed to commemorate the service to learning and letters of the late Professor Max Müller. The necessary steps are being taken to raise a fund, which, after providing for some personal memorial, such as a bust, relief or portrait, should be handed over to the University of Oxford, and held in trust for the promotion of learning and research in all matters relating to the history and archeology, the languages, literature, and religions of ancient India.

DR. P. H. KIRSCH died recently at Las Cruces, New Mexico. Dr. Kirsch received his doctor's degree from Indiana University about 1888. He was a teacher and naturalist of high rank, and was superintendent of schools in Franklin and other towns in Indiana and also in New Mexico. He is the author of several papers on fishes, one on the fishes of the Gila River, and another on the sturgeons.

For the purposes of the National Physical Laboratory, Queen Victoria has granted to the Royal Society, Bushey-house, Bushey-park.

THE annual report of the Superintendent of Disbursements shows an increased demand on the part of the public for Government publications and recommends that the issue of the monthly catalogue be enlarged, that permission

be granted to reprint documents of public interest and that a library be established, where not only national, but also State, municipal and foreign official documents may be preserved.

A TELEGRAM has been received at the Harvard College Observatory from Professor Kreutz at Kiel Observatory, stating that a comet was discovered by Giacobini at Nice, Dec. 20<sup>d</sup>, 313 Greenwich mean time in R. A. 22<sup>h</sup> 32<sup>m</sup> 0<sup>s</sup> and Dec. —22° 0' 0". Its daily motion in R. A. is + 6<sup>m</sup> and in Dec. —8'. The discovery has been confirmed at the Lick Observatory, the comet having been observed by Professor Aitken on December 24th, 26th and 28th.

THE American Medical Association has appropriated \$500 for researches. Applications for grants may be made during the present month to Dr. H. C. Wood, chairman of the Committee on Scientific Research, 1925 Chestnut street, Philadelphia.

THE Council of the American Chemical Society has authorized the establishment of a local section with headquarters in Kansas City.

AT a meeting of the Society of Arts, on December 12th, Professor Frank Clowes, chemical adviser to the London County Council, read a paper on 'The Treatment of London Sewage.' According to the London *Times* Professor Clowes said the present system of treatment consisted in straining or 'screening' off the larger solid matters and then mixing the sewage with solutions of lime and sulphate of iron; the chemical precipitate thus produced was then allowed to settle, together with the finer particles in the sewage, by sending the sewage slowly through parallel channels on its way to the river. The screenings or 'filth' were disposed of by being dug into the ground; the settled matter, or 'sludge' was sent in tank-steamers to be discharged out at sea; and the fairly clear 'effluent' passed constantly into the river at Beckton, Barking or Crossness. Although the condition of the river had been improved it had to be remembered that the effluent of the sewage after it had been freed from visible foul matter, still contained in invisible solution a large amount of putrescible substance, which might

under suitable conditions lead to serious foulness in the stream. In 1893 the Main Drainage Committee of the London County Council started a large scale experiment on the bacterial purification of sewage. This experimental treatment had been considerably extended in its scope and the results pointed to a general conclusion that the settled sewage might be purified to a far greater degree by encouraging the spontaneous purifying action of the bacteria which were present in the sewage itself. The effluent thus produced, without the intervention of chemicals, remained free from foul putrefaction, and was able to support the life of fish. Professor Clowes proceeded to describe the bacterial treatment by means of coke beds filled three or four times per 24 hours. The maintenance of the purifying action was due to the presence of bacteria upon the coke surface and to the adequate aëration of these surfaces by frequently exposing them to the oxygen of the air. The chairman expressed the opinion that the lecturer had rightly emphasized the extreme importance of the subject as a question of sanitation. The late Professor Faraday once called attention to the foul condition of the river as evidenced by the fact that a piece of card which he threw into the water disappeared when it became immersed to the extent of only one inch. Professor Poore told them that they were altogether on the wrong track, that they ought to restore the fertilizing materials, now permitted to go to waste, to the land, without the intervention of water, but for the present, at all events, he was crying in a wilderness. The only practicable method for the present generation seemed to be to minimize the inevitable nuisance as far as possible. He wished that Professor Clowes had given them some information with regard to the cost of the processes he recommended as compared with the cheapness of letting it alone. He desired to know how much land and what sized tanks would be required for the bacteriological treatment of the whole of the London sewage. He should have been glad if the lecturer had told them whether there were not other methods of applying the activity of bacteria to the purpose in hand. It was desirable to know whether the admixture of the

salt tidal water had an injurious effect on the bacteria contained in the effluent.

#### UNIVERSITY AND EDUCATIONAL NEWS.

By the will of Henry Villard, Harvard University and Columbia University each receive \$50,000. Among other public bequests is one of \$5,000 to the American Museum of Natural History.

RIPON COLLEGE dedicated its new science building, Ingram Hall, on December 18th. The keys of the building were presented to the trustees by the principal donor, Mr. O. H. Ingram, of Eau Claire, and received, with a fitting response by President Flagg. The principal address of the occasion was by Professor John M. Coulter, of the University of Chicago, on 'Some College Fallacies.' The building, which has been completed this fall, cost about \$33,000, of which sum Mr. Ingram gave nearly \$18,000 and Dr. Pearsons \$5,000. The pleasant feature of the dedication exercises was a special gift by Mr. Ingram which wiped out a small debt remaining upon the building and allowed about \$1,300 to be applied to the equipment. The building is three stories high and modern in all details of its construction.

THE new building of the Medical College of Cornell University was formally opened on December 29th. Addresses were made in the afternoon by President Schurman, Dr. Stimpson, professor of surgery in the College, and Governor Roosevelt. In the evening, the new building was open to invited visitors.

DR. D. K. PEARSONS has given Colorado College the \$50,000 promised some time since, and it is reported that he has given Northwestern University \$30,000 for the erection of a woman's dormitory and \$200,000 to an educational institution, the name of which is not to be made public during his life time. A press dispatch from Chicago accounts for about two and a half million dollars given by Dr. Pearson mostly to educational institutions, and it is estimated that the sum of about five hundred thousand dollars has been given anonymously. The details of the gifts are as follows:

Beloit College.....	\$295,000
Chicago Theological Seminary .....	280,000

Colorado College, Colorado Springs.....	150,000
Mount Holyoke College, Massachusetts.....	150,000
Berea College, Kentucky.....	150,000
Lake Forest University .....	125,000
Whitman College, Oregon.....	120,000
Knox College.....	100,000
Drury College, Springfield, Mo.....	100,000
Yankton College, South Dakota.....	100,000
Presbyterian Hospital, Chicago .....	70,000
Pacific University, Oregon.....	60,000
Carleton College, Northfield, Minn. ....	50,000
Fargo College, North Dakota .....	50,000
Pomona College, California.....	50,000
Fairmount College, Kansas.....	50,000
McCormick Theological Sem., Chicago.....	50,000
Chicago Young Men's Christian Assoc.....	40,000
Olivet College, Michigan.....	25,000
Marietta College, Ohio.....	25,000
Sheridan College, Wyoming.....	25,000
McKendree College.....	25,000
Presbyterian Board of Missions .....	20,000
Grand Prairie Seminary, Onarga, Ill.....	20,000
Anatolia College, Turkey .....	20,000
Woman's Board of Foreign Missions.....	20,000
Chicago Art Institute.....	15,000
Unknown College.....	200,000
Northwestern University.....	30,000
Colorado College .....	50,000

Grand total.....\$2,465,000

It is generally believed that Dr. Pearsons' anonymous gifts will bring the total close to \$3,000,000.

MR. W. J. THOMPSON, of Pittsburg, has given Washington and Jefferson College \$50,000 for a library building and \$10,000 for equipment.

THE Hon. Roger Wolcott, formerly governor of Massachusetts, who during his life time gave liberally to Harvard University, has by his will bequeathed \$20,000 to the institution.

THE daily papers report that Mr. Alfred Vanderbilt has given \$30,000 to the bi-centennial fund of Yale University.

AT the meeting of the trustees of Ripon College, December 19th, President Flagg tendered his resignation. The administrative work of the college will continue in the hands of the dean of the faculty, Professor Marsh, as it has during the fall term.

PROFESSOR ARTHUR THOMPSON, of Oxford, has been elected Professor of Anatomy in the Royal Academy, London.



# SCIENCE

EDITORIAL COMMITTEE: S. NEWCOMB, Mathematics; R. S. WOODWARD, Mechanics; E. C. PICKERING Astronomy; T. C. MENDENHALL, Physics; R. H. THURSTON, Engineering; IRA REMSEN, Chemistry; JOSEPH LE CONTE, Geology; W. M. DAVIS, Physiography; HENRY F. OSBORN, Paleontology; W. K. BROOKS, C. HART MERRIAM, Zoology; S. H. SCUDDER, Entomology; C. E. BESSEY, N. L. BRITTON, Botany; C. S. MINOT, Embryology, Histology; H. P. BOWDITCH, Physiology; J. S. BILLINGS, Hygiene; WILLIAM H. WELCH, Pathology; J. MCKEEN CATTELL, Psychology; J. W. POWELL, Anthropology.

FRIDAY, JANUARY 11, 1901.

A NOTABLE OFFICIAL REPORT.

## CONTENTS:

<i>A Notable Official Report</i> .....	41
<i>The Hall of Natural History, Trinity College</i> :—	
<i>The Recent Progress of Paleontology in America</i> : PROFESSOR HENRY FAIRFIELD OSBORN.....	45
<i>Biology as an Element in College Training</i> : PROFESSOR W. H. HOWELL.....	49
<i>Opening of the Hall of Natural History, Trinity College</i> .....	57
<i>An Artificial Representation of a Total Solar Eclipse</i> : PROFESSOR R. W. WOOD.....	65
<i>Scientific Books</i> :—	
<i>Tillson on Street Pavements</i> : F. S. PECKHAM.	
<i>American Education</i> : PROFESSOR R. H. THURSTON.	
<i>Boehm and von Davidoff's Histology</i> : H. MCE. KNOWER. <i>Books Received</i> .....	67
<i>Scientific Journals and Articles</i> .....	70
<i>Societies and Academies</i> :—	
<i>New York Academy of Sciences, Section of Biology</i> : PROFESSOR FRANCIS E. LLOYD. <i>Academy of Science of St. Louis</i> : PROFESSOR WILLIAM TRELEASE. <i>Zoological Club of Chicago</i> : DR. C. M. CHILD. <i>Zoological Journal Club of the University of Michigan</i> : DR. H. S. JENNINGS.....	71
<i>Discussion and Correspondence</i> :—	
<i>Unauthorized Newspaper Reports</i> : PROFESSOR JACQUES LOEB; <i>An Appeal for Assistance</i> , PROFESSOR F. W. PUTMAN.....	75
<i>Current Notes on Meteorology</i> :—	
<i>Rainfall of New South Wales</i> ; <i>Rainfall and Altitude of England</i> ; <i>A New Meteorology</i> ; <i>Atlas of the Indian Ocean</i> : PROFESSOR R. DEC. WARD.....	75
<i>The International Catalogue of Scientific Literature</i> .....	76
<i>Scientific Notes and News</i> .....	77
<i>University and Educational News</i> .....	80

IN our last issue we pointed out the urgency of an authoritative reply from the Naval Observatory to the criticisms on its management which have been uttered by parties entitled to the highest respect. We return to the subject to mention another point on which it is equally urgent that certain unfavorable impressions likely to be given by the annual report of the Observatory should be corrected. Precision and accuracy of statement are always expected in an official document, and there is no department of the government in whose reports this quality is more confidently looked for than in that of the Navy. If a report is circulated by this department containing statements likely to be misconstrued, an earnest desire that public confidence in the Navy shall not be impaired will lead us to call attention to the statements and ask that they be supported, or so changed as not to give rise to misconception. Especially is this the case with a paper from which astronomers the world over will draw conclusions as to the degree of precision aimed at in describing the operations of one of our scientific departments. We shall quote the passages we have in

MSS. intended for publication and books, etc., intended for review should be sent to the responsible editor, Professor J. McKeen Cattell, Garrison-on-Hudson, N. Y.

mind and show wherein they seem to need strengthening.

"All the astronomical instruments of the Observatory have been steadily and continuously in use during the year on every clear night and day."

So comprehensive a statement as this can be made by no other observatory; and the importance assigned it is shown by the prominence of its position, and its being repeated by the Bureau in its report direct to the Secretary of the Navy. But in other passages of the report we find that the 9-in. transit circle was out of use undergoing repairs more than half the year, that little use was made of the 6-in. circle except to take the place of the 9 in., and that observations with the latter and with the photoheliograph were suspended because the observers were engaged in making preparations for the total eclipse of the sun. We find also that the total number of separate observations with the prime vertical transit was 164, less than one-half the number of nights in the year, while those with the altazimuth, used as a zenith telescope, numbered a little more than the days in the year. At the international geodetic stations the observers are expected to make about 16 double observations on every clear night. We confess to some difficulty in interpreting and reconciling these statements.

"The board chooses to assume that the salary of every professor of mathematics in the Navy, active or retired, except two at the Naval Academy, is chargeable to the expenses of the Observatory. It therefore charges in its exhibit the salaries of officers on the retired list, and the salary of one officer still on the active list whose connection with the Observatory has long since definitely ceased for cause. By such flimsy expedients as this the expense column is easily swelled."

The law provides for twelve professors on the active list. The exact number on the retired list we do not know, but certainly six, still living, have been retired from the Observatory and the Nautical Almanac Office, making a total of not less than eighteen. All but two of these would number sixteen. We find by reference to the passage alluded to in the report of the board, that five active professors with estimated salaries of \$15,000 are charged to the Observatory, while the salaries of the professors retired from active duty there are estimated in the total at \$10,000. The salaries of the senior ones are \$3,500. We do not know whether the \$8,000 estimated is or is not more than that of the three others; but it does not seem that it could be much in excess. We are therefore unable to see what ground there can be for the statement we have quoted which implies that the salaries of sixteen professors were charged to the Observatory.

In explanation of delay in publishing observations the report says:

"The delays in building, the labor of dismounting and remounting the instruments, the repairs and alterations of the same and their subsequent installation, the removal of the records and Observatory property, and generally the labor involved in settling in the new place, absorbed the entire time of the whole very limited working force of the Observatory for several years. \* \* \* The force of the astronomical staff, sufficient for current work in settled times, was totally inadequate to bring up back work when the work had fallen behind. It was simply a physical impossibility to keep up the publications, to make the current observations and do the necessary work of removal at the same time. \* \* \* It might have reasonably been shown that during the whole of this transition period current work was practically uninterrupted and that

the number of observations made at the old and new Observatories kept pace with those made at Greenwich. \* \* \* The facts were laid before the board and ignored by it. They would have shown to the credit of the Observatory."

In the Observatory report for 1892 scarcely any astronomical observations are reported, except with the old equatorial, and in the report for 1893 it is still reported that few were made, 'as all the principal instruments were undergoing repairs.'

The absorption of the entire time of the working force, for several years in the manner stated; the impossibility of keeping up observations and their uninterrupted continuance, during this whole transition period on such a scale as to keep pace with Greenwich, are facts which seem to need elucidation to make them consistent. That the board of visitors ignored them is true, —the implication that it did so because they would have shown to the credit of the Observatory we leave the men concerned to answer.

"A determined effort was made by the board to prevent, if possible, the appointment of new men to fill the vacancies created by the retirement of the older professors of mathematics at the Observatory. \* \* \* Notwithstanding the efforts of the board to prevent it, these vacancies have all been filled in line with the traditional policy of the Observatory, which has always been to take for its staff young men of promise whose career was before them, in contrast with the plan, recommended by the board, of appointing at once to high office men whose scientific reputation was already established, and whose prejudices and animosities were mature and confirmed."

We find nothing in the report of the visitors implying that 'prejudices and animosities' were to be considered as necessary qualifications for the offices to be created.

It would therefore seem that, in the opinion of the head of our Observatory, astronomers whose scientific reputation is established are, as a class, 'men whose prejudices and animosities are mature and confirmed.' We can only regret that his experience should have been such as to lead to this conclusion.

A word about Leverrier and the Paris Observatory may serve to introduce a statement found in the papers appended to the 'Report of the Board of Visitors.' During the first half of the century the Paris Observatory had fallen to so low an ebb that a radical reorganization was decided upon, and Leverrier was chosen as the man to effect the desired reform.

He adopted the principle that his assistants must either quit the observatory or go to work. During his career he caused all the observations for fifty years back, which had lain unreduced, to be reduced by modern methods, arranged and published. He also kept up the regular reduction and publication of current work. Besides carrying on all this regular work, he published a vast collection of researches by himself and others, which forms one of the greatest astronomical enterprises ever undertaken by one man, and laid much of the foundation of exact astronomy up to the end of the 19th century.

In a letter to the Secretary of the Navy, found in Exhibit B, page 33, of the 'Report of the Board of Visitors,' this work is disposed of in the following terms:

"The most eminent astronomer that France has produced was an utter failure in the administration of the National Observatory at Paris, and was suc-

ceeded by an admiral of the navy under whose direction it was excellently administered."

The fact that the officer who succeeded Leverrier was retired from active service and had devoted his energy to astronomical work with such success that, before his appointment, he had become one of the professional astronomers of the French Academy of Sciences, was not stated in the letter.

There are several other points in which the construction placed upon the Visitors' report differs essentially from that which would be placed upon it by the ordinary reader; but we shall not stop to discuss them. One is "that the Board actually proposes to remove the affairs of the Observatory from Government control." The reader of the Visitors' report will see for himself that nothing of this sort was intended.

A charge of unfairness should, however, be noticed. A comparison of personnel, salaries and total expenses at Washington shows it to cost about 50 per cent. more than Greenwich or Harvard. In the report now under review a comparison is given limited to the scientific personnel of the three observatories, and, showing that of Washington to be less in total cost, and less than half in strength, as compared with either of the others. But this only emphasizes the extraordinary number of non-scientific employees and the magnitude of the general expenses at our Observatory.

A general remark on the Visitors' report may not be out of place. The careful reader of this paper will find it marked by a moderation of tone showing a keen appreciation of the amenities of official expression, and by an avoidance of the blunt

statement of unpleasant facts suggestive of the gentle influences exerted by a hospitable reception at a great government institution. A curious feature of the situation is that the plan of reform which now comes in for such scathing criticism is the outcome of an effort on the part of the Board to devise some way of making the continued administration of the Observatory as a naval station compatible with its success as a scientific institution. The Board is now, we suppose, considered as *functus officio*, but it would be interesting to know whether its individual members would, in the light of subsequent events, change their minds as to the practicability of their plan after reading such forceful criticisms from the very authority it was intended to propitiate.

Having said so much implying dissatisfaction with the report, it is a pleasure to find a serious misapprehension corrected by it. This is the common notion, shared by the Board of Visitors, that the Astronomical Director is a dual head of the Observatory. It is now made quite clear that he is only one of seven subordinate and co-equal heads of departments. We must frankly admit that this makes the proposal to have him appointed by the President, by and with the advice and consent of the Senate at a salary of \$6,000, look—if not 'preposterous'—at least a little open to question.

We conclude with two questions, an answer to which we are sure would be received by all the astronomers of the country with great respect, not to say eager interest. Granting that 'no person can now pretend to be a friend of the Observatory or of science while attacking its organization,'

then if our astronomers see a great institution for promoting their science supported by Congress on a scale of unprecedented liberality, while, owing to defects of organization, the results do not come out on a corresponding scale, what is their duty as patriots and citizens in the premises?

The other and concluding question is this: What possible object can men enjoying the high and well-earned reputation which so justly accrues to the professional abilities of the officers of our Navy have in going outside the line of their profession to enter a field in which their best efforts can have no result but to lessen public confidence in their ability and good judgment? We can assure these officers that none of our citizens admire their professional skill and achievements more heartily than do the astronomers. We do not believe there is a director of an observatory in the land who would not welcome the advent of a naval officer to relieve him of the onerous duties of administration, were such a thing compatible with efficiency. But the director knows well that no such result would be possible unless the officer would consent to be subordinate to him, just as he would be the subordinate of the officer, if he performed scientific duty on a naval vessel.

— — — — —

*THE RECENT PROGRESS OF VERTEBRATE  
PALEONTOLOGY IN AMERICA.\**

THE three sciences especially favored by nature in this country are astronomy, paleontology and geology. American progress in astronomy is largely due to our rela-

\* Introduction and conclusion of a popular lecture illustrated by field and museum photographs, delivered at Trinity College, Hartford, Conn., on the occasion of the opening of the Hall of Natural History.

tively clear and dry atmosphere, as compared with that of northern Europe, to our inventive genius in the matter of instruments and to the private and public liberality which has founded great observatories and telescopes. Paleontology is also notably an American science, not because of the superior ability of its American votaries, but because of the vast extent of the arid region of the West exposing thousands of miles of fossil-bearing strata which in a moist climate would be covered by vegetation. This branch has especially enjoyed the liberality of the national government, and two men of large wealth, Professors Marsh and Cope, have devoted their entire fortunes to it. Except by institutions west of the Mississippi it cannot be pursued with limited means because of the great distances involved, the expense of fitting out explorations, and the equally great expense of preparing the fossils when they arrive in the East.

The development of paleontology in this country has followed the forest clearing of the East and the winning of the West by stage coaches and railroads. Mastodons, great sloths, horses and cetaceans were the principal animals found in the East. Among other early observers of this Eastern fauna was President Jefferson. David Owen, as U. S. Geologist between 1847 and 1852, explored the Mississippi Valley as far west as Wisconsin, Ohio and Minnesota. Joseph Leidy, the distinguished comparative anatomist of the old school, astonished the world in the fifties by describing the ancient fauna of Dakota and Nebraska. In 1870 the line extended west into Wyoming; Leidy, Marsh and Cope were all exploring and describing the types of this Eocene region with feverish haste, so that upon the average each animal was baptized with at least three names. It is our hard lot at present to find order out of this chaos of species. 'Après moi le déluge,' apparently was the motto

of each of these authors. As widely apart in their personal characteristics and methods of work, as it was possible to be, they were nevertheless the founders of American paleontology: Leidy, a pre-evolutionist and an exact descriptive writer, with little power of generalization; Marsh, a genius for the appreciation of the most important problems in evolution, with clearness as a writer, unrivaled talent as a collector and great powers of exact description, without marked originality in the invention of hypotheses; Cope on the other hand a philosopher, fertile in hypotheses, a road-breaker in classification, hasty in description and with indomitable capacity for work. The comparatively recent death of these three great men has totally changed the conditions of paleontology in this country, it now attracts a large number of students and has spread through our institutions. Whereas twenty-three years ago paleontology was exclusively in the hands of Marsh and Cope, we now find workers in the National Museum, the Yale Museum, at Princeton, the American Museum of Natural History, the Carnegie Museum of Pittsburg, and the Field Columbian Museum of Chicago, also in the Universities of Chicago, Kansas, Nebraska, Minnesota and Colorado. Explorations are now conducted on a most extensive scale, the peculiar American methods of work having been carried by two parties as far as Patagonia with remarkable results.

Before describing the work of the American Museum which is quite characteristic of the field at large, I want to speak of the philosophical development of this science.

The wise and oft-quoted remark of Huxley's, that the only difference between a fossil and a recent animal is that one has been dead longer than the other, is the epitome of the present attitude of our science. Huxley himself slowly reached this conclusion. After devoting the earlier years of his life to marine zoology, he shrank from

accepting a post in the School of Mines, because it necessitated his centering his research upon extinct animals. Yet he became the Nestor of modern vertebrate paleontology, the first to thoroughly apply the principles of evolution as a means of interpretation of extinct forms. A fossil is still a synonym for dryness, and Huxley's preconceived prejudice, which was transformed into a passionate devotion for fossils, represents a popular error, which I trust I shall succeed in fully dissipating this afternoon; in fact, the chief burden of my song is that paleontology is a part of zoology or the study of animal life; that zoology is a part of biology; and that biology is the common-sense, the rationale, the philosophy of living nature as a whole.

The true modern spirit in which to study a fossil vertebrate is to imagine it as living, moving, walking, swimming or flying, begetting its kind. The size of the brain, which is really ascertained by studying its cavity in the skull, has been the subject of special researches by Leuret, Marsh, Cope and Bruce; the size and position of the organs of sight and smell are among the data of fossil psychology. Therefore we can study a fossil as thinking, that is, fearing its enemies, devising means of escape either by adhering to its friends in herds or by swift solitary flight. But such knowledge is not obtained from a few fragments, we need a very large part of the skeleton of an animal and information concerning its contemporaries before we can begin to draw such inferences, and one of the greatest advances of recent work consists in the fact that we have secured complete skeletons in the place of fragmentary parts.

If the remains of an animal are found with many others of its kind as in the case of five skeletons of *Merycochoerus* recently found by one of the American Museum expeditions, you infer that it was gregarious; if always found isolated you infer that it

led a solitary life. The construction of both teeth and feet teaches you whether it lived in the water, along the shores and swamps, in the meadows or on the dry grasses of the uplands and mountains. If an animal is found with short crowned teeth and spreading feet and its remains are always imbedded in coarse sandstones and gravels, you have an absolute demonstration that it lived and died near the river bank, if on the other hand the teeth are long crowned, adapted to the grasses, and the limbs are stilted like those of the antelope, you infer that it avoided water courses and that its remains were deposited in the fine dust like that now seen upon our western plains. This law has been recently used for a geological generalization by Dr. W. D. Matthew, which, if confirmed, will entirely overturn the lake-bottom theory long held for certain great formations of the Oligocene and Miocene east of the Rocky Mountains, as shown in this map.\* It will bring in its train a whole series of consequences, because a new idea disturbs the relations of old ones just as the introduction of a new animal into a country may alter the whole balance of life. It will change our views, not only as to these eastern deposits, but as to the climate of this period; this which we have always supposed to have been extremely moist, will now prove to have been dry, not so dry as upon the western plains of the present day, but certainly as dry as in great districts in Africa. These fine dry subaërial or eolian deposits of drifting soil, containing animals of one type, are traversed by sandstone deposits due to intersecting rivers and containing animals of quite another type. This result has not been reached haphazard, but it is largely due to the exact study of extremely exact field records which are now made as to the level at which every specimen is found. The kind of rock in which

a skeleton is found and even its position often forms a clue to its mode of deposition. Thus paleontology works hand in hand with geology and throws a clear light upon the climatic conditions of the past.

In line with zoology is the adaptation of extinct types. The very first advice I give to my students is to ponder over the function, purpose, fitness or adaptation of parts. Comparative anatomy and paleontology are alike dry where they ignore physiology, they become fascinating in the measure that they reveal design. Consider for a moment the story told by these vertebræ, part of the backbone of a great dinosaur of 50 to 70 feet in length; they are marvels of construction, with all the beauties of the flying buttress of a cathedral and rigidity of the T truss of a modern bridge; evidently the mechanical problem which this animal solved was to combine the maximum of size and strength with the minimum of weight.

This spirit of looking for 'purpose' and ignoring the conventional distinctions between a petrified animal and a living one has been more or less characteristic of the work of the master minds of paleontology from the time of its great founder Cuvier, of Cuvier's successor, Owen, and of our own Cope. Did not Cuvier propose the law of correlation, whereby he maintained that a single claw would enable us to give the habits and restore an entire animal? A generalization, not altogether supported by more recent evidence, which in his day excited great admiration and called forth the famous remark of Balzac that 'Cuvier like Cadmus builds cities from a single tooth.' The masters of every science are always in advance of the lesser men, many of whom are seeking a bubble reputation, not at the cannon's mouth, but by the laborious description of new species. Systematic description is at once the staff of our progress and the bane of our existence. Rightly

\* Oligocene Lake.

done, it is a record of all the steps which nature has taken in the passage from lower to higher types but, alas, egotism, personal rivalry, in short every form of human frailty is here exhibited; there are the 'species makers,' who devise species which nature knows not of; the 'species lumpers' who ignore actual distinctions, putting together that which nature has put asunder, forgetting that it is a great convenience to have a name or symbol for every distinct stage of evolution; finally, there are the 'resurrectionists' who, seldom or never examining original specimens, pore over old literature and revive obsolete and best-to-be-forgotten names.

Paleontology has yet to gain universal recognition as a zoological science not only on the part of other workers, but of its own disciples. Its disciplinary value as a training in *exact thinking in evolution* is undoubtedly superior to that afforded either by embryology or comparative anatomy.

Modern morphology or the science of form stands on a tripod of evidence. He who tries to balance a theory of vertebrate structure upon embryology or comparative anatomy alone is like a man trying to keep a permanent and comfortable sitting on a two-legged stool. It may be inconvenient to go from the laboratory so far afield as the rocks for one's evidence, but the stability of every theory which affects the hard parts of the vertebrates depends upon the tripod, namely, upon the comparison with other living types, upon the order of development from the embryo, and upon the direct history or order of evolution in past time. We are even now sympathetically witnessing the wreck of certain favorite doctrines of the greatest comparative anatomist of our day, Carl Gegenbaur, because his work rests upon comparative anatomy and embryology alone. In this regard Huxley was an unrivaled model; he not only, so far as was in his power, rested his theories upon three kinds

of evidence, but let those who are hurrying through a superficial education for brief glory as investigators ponder upon the following passage, written at the age of 31: "1856-7-8 must still be 'Lehrjahre' to complete training in principles of Histology, Morphology, Physiology, Zoology, and Geology by *Monographic Work* in each Department. 1860 will then see me well grounded and ready for any special pursuits in either of these branches." This passage, in fact all of the 'Life and Letters,' constitutes at once a brilliant argument against premature specialization (Huxley little dreamt of the modern fad of extending the elective system to the kindergarten) and a solemn injunction that he who would build high must be patient to lay his foundations broad and deep.

Is there then no distinction in the methods of thinking of the paleontologist, embryologist or comparative anatomist? I would answer a distinction not of kind but of degree. Of course none of the soft parts are preserved in a fossil, the skeleton and teeth alone remain; by direct study and comparison with living types these have to be clothed with muscles, nerves and blood vessels. We are forced to study the bones and teeth with intensified keenness and exactitude in our search for evidence as to how an extinct animal moved and fed, and I consider that *precision in methods of exact description and terminology* constitutes one of the chief advances in the work of the present day.

In the geological and biological spirit this becomes a fascinating field for the constructive imagination. To do the best work you must live in the period of your research, however, remote it may be; marshal the extinct animals before you, as the brilliant young dramatist, Rostand, marshals Wagram before the eyes of L'Aiglon; revive the physical geography, the temperature, moisture, vegetation, insect life and see before



your minds eye the keen struggle for existence. \* \* \*

\* \* \* Here you have before you the methods and present aims of paleontology; it is the history of the world in the period which is mistakenly called prehistoric; it is your history and mine when our ancestors were struggling upwards in the long ascent of man. Every broad, serious, honest contribution to paleontology will constitute a word, a line, a chapter in the final history which our descendants will complete.

HENRY FAIRFIELD OSBORN.

COLUMBIA UNIVERSITY.

*BIOLOGY AS AN ELEMENT IN COLLEGE TRAINING.\**

COURSES in natural science under the head of biology are a comparatively recent feature in our college programs. They may be described in general terms as consisting of a comparative study of certain types of animal and vegetable life with reference to their functions as well as their structures. Strictly speaking biology is in no essential respect a new subject. Nevertheless the term is a useful one, and courses in general biology differ in several important, if not essential respects, from those usually given under the title of zoology or botany or natural history. In the first place, these courses, as given in our colleges, endeavor to present the salient facts with regard to the properties of living things from a common or general standpoint. They attempt to bring into the foreground the resemblances as well as the differences in structure and function among varied forms of life belonging to both the plant and the animal kingdom. The intention is to give a bird's-eye view in which the general plan shall be made evident, and fundamental relationships shall be emphasized. A student

who has acquired this point of view is prepared to appreciate discussions of the great general laws of biology, or, if need be, to enter more carefully upon a closer study of details.

But, in addition to this feature, courses in general biology are characterized by the emphasis laid upon the functional manifestations of living matter, by a presentation and discussion of the great questions of nutrition, heredity and reaction to environment.

In other words, the physiological point of view is brought out more prominently, if I mistake not, than is the case in the customary courses in botany or zoology. For these reasons a course in elementary biology has a special value, which has been recognized and has led to its very general introduction into our colleges. In a proper sequence of biological studies its place falls naturally in the college period. It should be preceded, preferably in the secondary schools, by an out-door study of the forms and life-histories of familiar plants and animals, and, on the other hand, should itself precede courses in botany or zoology or special professional training.

It is in this last respect that the importance of collegiate training in biology has been most widely recognized, that is, as a preparation for a future professional career, particularly the profession of medicine. Medicine on its scientific side falls into the group of biological studies, but as taught in the professional schools it concerns itself almost exclusively with a single, and that the most highly developed, form of life. The intelligent members of the medical profession have recognized freely that a general survey of the whole series of living types forms an excellent basis for the more special work of medical schools and medical practice, in that it gives a wholesome breadth of view and an educational training that may save its possessor from many

\* Address delivered at Trinity College, Hartford, Connecticut, on the occasion of the opening of the Hall of Natural History.

a crude theory or foolish notion. It contributes, in other words, to that sound scientific foundation which is a characteristic of the well-educated physician. We find, therefore, in many or indeed in most of our colleges that courses in biology are arranged with special reference to the needs of those who expect to go into medicine. The value of this preparation is emphasized by the fact that in Great Britain all medical students are required to show evidence that they have had courses in elementary biology before entering upon their medical studies, and in this country one at least of our better schools makes a similar requirement. This intimate and recognized relationship to one of the most important professions is in itself a strong practical reason for the encouragement of undergraduate courses in biology in our colleges, for it is evident, I think, that the rapid increase in preliminary requirements now taking place in our medical schools will result in a corresponding increase in the number of those who, intending to enter medicine, will first prepare themselves by a college training. There will be in the future a greater demand from this source for biological instruction.

This relationship of biology to medicine is not, perhaps, wholly beneficial to biology, in that it tends in the minds of some to give to the subject a technical aspect which is inconsistent with pedagogical ideas of what should constitute the proper material for undergraduate study. On the contrary, it has always seemed to me that biological courses, of the kind I have in mind, are singularly well adapted to the purposes of a liberal training, that they possess both a culture and a training value entirely apart from their especial importance as a preparation for professional life. The educational value of biological work has been pointed out by many eminent writers. Huxley has summarized the arguments upon this point by showing that the work involved leads

necessarily to training in observation, in comparison and classification of facts, in deduction and verification, that is in those processes of thought which enter into the intellectual life of every man. The special feature of biological training, perhaps, is the exercise it gives to the power of observation; in this respect at least it possesses a distinct advantage over other means employed to develop the mind, and I fancy that few will dispute its supremacy in this regard.

But another important influence, from the standpoint of liberal training, which may be expected from a college course in biology is frequently overlooked. I refer to the culture value of biological studies in bringing one into an intelligent relation with life on its physical as well as its psychical side. To my mind this feature is emphasized by the frequent instances one meets of crass ignorance regarding the simpler processes of bodily life. By way of example, a friend of mine, a gentleman and a scholar, a linguist of international reputation, once remarked to me that he was suffering from a headache, and he thought it probable that the fumes from his liver had gotten into his head. Evidently my friend, like some other classical scholars, had imbibed his physiological information quite incidentally from very ancient sources. With respect to modern biological knowledge his position was not more advanced than that of Brother Jasper regarding the planetary system. So, too, I am informed upon good authority that an eminent divine in this country based a certain mystical theory of his own regarding spiritual phenomena upon the fact that after amputation an individual may experience sensations in his lost fingers or toes, a fact perfectly understood by any one possessing an elementary knowledge of physiology without recourse to far-reaching mystical views.

Curiously enough, deplorable ignorance of

this kind is frequently displayed by educated men without the least sign of compunction. In fact it is usually treated in a jocund way much as when one confesses his ignorance of the latest mode in garments or of other trivial affairs of life. One may infer from this attitude that a knowledge of biology is not widespread or highly esteemed among the educated people of our time, otherwise it would not be deemed expedient to treat this knowledge with the contempt of levity. The condition that actually exists recalls the state of affairs that prevailed some two or three hundred years ago, when "Many a pretty fellow, who was a wit, too, ready of repartee, and possessed of a thousand graces would be puzzled if he had to write more than his own name." The ability to write with moderate ease is widespread now, and not even the possession of a thousand graces, would save one from a sense of humiliation if he were deficient in the elements of an English education. It would really seem desirable that our colleges should provide against the possibility of their graduates entering life a thousand years or more in arrears in all that concerns vital phenomena. So far as I am aware it is possible for a man to go through college and be instructed in the wisdom of the ancients and the history of mankind, and yet be left in a condition of child-like ignorance concerning what is known of the most striking and important phenomenon of the universe, namely, living matter and its properties.

Next to living itself there is nothing, it would seem, that should so interest mortal man as that physical basis of life through which his living is effected and in such large part influenced and controlled. Biology seeks to discover what it may concerning this substance, its structure, the laws controlling its activity, its origin, its growth, its death. These are matters concerning which every intelligent man has a natural curiosity, and concerning which every educated

man ought to have some reliable information, so much at least as would enable him to appreciate the modern point of view and follow the trend of contemporaneous thought. A brief course in elementary biology meets this requirement where a course in natural history, so-called, would probably prove insufficient. The latter gives the large but external view of living nature, the former brings us into close contact with the inner structure of living matter, the medium of all the manifestations of life. On the other hand, those who have not had the advantage of some elementary instruction in biology will find that a large and important chapter in the revelations of modern science and the progress of modern civilization is written in a language which it will be difficult for them to comprehend.

When one considers the interest and importance of biology and its peculiarly intimate relations with the act of living, it becomes a fair question whether or not this side of knowledge should be represented in the course of study of every college student. It would seem to me that inasmuch as we are creatures of the senses, and must seek the foundations of our knowledge in the deliverances of the senses concerning the world without, the education of every individual should include some instruction concerning the animate as well as the inanimate world in which we find ourselves placed. He should possess some information about the means and method by which knowledge is acquired, and the external phenomena that are the occasion of this knowledge.

Moreover, the culture inculcated by natural science, both physical and biological, is a world culture that takes us back beyond the history of mankind and looks hopefully forward into the future expectant of greater and greater development. It is a culture too that we can share in common with all the sons of men, whether their classical tra-

ditions, the sources of their laws and customs and languages, are the same as ours or not. We must assume that it will become more and more important to educated men as the varied nations of the earth are brought into closer intercourse and a greater community of life.

Among the specific advantages that may be hoped from a spread of biological knowledge among the educated classes is an abatement of the surprising credulity that they often exhibit regarding natural phenomena. This credulity finds its most common manifestation in relation to diseases, their causes and their cure, and springs without doubt from ignorance of the elementary facts of biology. Men of ability and discrimination, of wide acquaintance with the affairs of life, or versed in the classical learning of the schools, are oftentimes as prone as a child or an untutored savage to be misled by the utterly irresponsible views of ignorant persons concerning the human body and its functions. From time to time in the history of medicine sects arise which propose to treat disease upon *a priori* theories that are as devoid of a rational basis as are the incantations of the Indian medicine-man. The dupes of these theories are not alone the ignorant and untrained, but frequently the well-educated. They are deceived by the shallow sophistries of quacks and charlatans, because, I fancy, the living body is to them what it was to the ancients, the seat of mysterious forces. About these mysteries they know nothing and, therefore, they are ready to believe almost anything, especially from the mouths of charlatans or self-deceived fanatics, because in the nature of things it is the latter classes that speak most positively and in the loudest tones of conviction, and such mannerisms carry much weight with most of us when we are upon unfamiliar grounds.

I am entirely willing to admit, of course,

that there are more things in heaven and earth than are dreamed of in our philosophy, but this is a very vague and unsatisfactory premise upon which to erect a working hypothesis of life. I am sure that in the practical and serious affairs of life it is much better to be guided by the knowledge that we have, incomplete though it may be, rather than by wild speculations about the knowledge that we have not. The wrecks of many fantastic beliefs scattered through the history of mankind bear witness to the wisdom of this rule of conduct. It would seem that the primitive mysticism that enveloped the healer's art still clings more or less to the profession of medicine. Those who practice the art to-day, whether legitimately or illegitimately, are supposed by many who should know better, to have acquired in some way the power to lift the veil that enshrouds the mysteries of life. It would be well for the profession as well as the public if this remnant of ancient superstition could be forever effaced, and practitioners of the art of medicine could be measured by the standards of knowledge and skill that apply to less occult callings of life. For naturally this factor is used chiefly by those who are least deserving of confidence, and to the undoing of a credulous public.

We may infer that the establishment of a rational theory and practice of medicine depends nearly as much upon an education of the public as upon the training of the physician. Education in the traditional humanities does not seem to be sufficient for it is well known that those who are provided with this culture may fall easy victims to the vagaries of quacks. One might suppose that instruction in the elements of human physiology such as prevails in many colleges and secondary schools would meet the need that I am describing. But seemingly this is not the case, and the reasons for the inefficiency of this kind of

instruction are very apparent to my mind. It has none of the virtues of first-hand knowledge. Human physiology as taught in our schools is good enough in its way, but it gives no real information of the nature and properties of living matter. Outside the fact that the instruction is usually authoritative and based upon book-work, it fails to develop an acquaintance with fundamental conceptions of the nature of the living processes, and these must be comprehended in some measure if one wishes to look at the living side of nature from the proper standpoint. It may very well happen that an individual has a fair idea of his internal topography, and yet believes firmly in mad-stones as a cure for hydrophobia, or the occult influence of horse-chestnuts in the coat pocket upon rheumatic conditions, or in some similar superstition that has come down from the age of witchcraft and sorcery. These last illustrations are perhaps extreme and not generally applicable to the college graduate, but if it were desirable it would be easy to give quite specific instances of fads and theories just as unscientific and irrational which do find lodgment among the educated classes.

As an antidote to this unworthy credulity I can imagine no more certain remedy than a course in biology, including some laboratory exercises. Not a great deal is required if the instruction is real and first hand. Any one who has examined into the minute structure of living forms and gained some conception of the nature of vital processes is effectively armed against the grosser fallacies that at present find some acceptance among even the educated classes. I do not mean to say that training of this kind is indispensable for an appreciation of the nature of biological conceptions, but only that by its means the whole subject is illumined and given a reality that otherwise could scarcely be hoped for. One sees the difference fully illustrated by

the attitude of the general public toward modern ideas of germ diseases and bacteria in general. How many absurdities and false notions are entertained by educated people regarding these latter forms of life!

The point that I wish to make is that in this day and generation the man or woman who goes out from college entirely uninformed on the biological side is ignorant of a very important phase of the world's history, is out of adjustment with his times, and is deprived of a most helpful means of controlling rationally his own health and that of others committed to his care. If this kind of knowledge is desirable at all as part of the armamentarium of an educated man, it is hopeless to seek for it elsewhere than in the college period. Much of the education necessary to put us into intelligent adjustment with modern life can be obtained in the secondary schools, but laboratory courses in biology can scarcely find a place so early in the scheme of instruction; they require some degree of maturity and previous training on the part of students, to say nothing of the paraphernalia requisite for actual instruction. Our college courses are crowded as it is, and perhaps it is not possible to include biology as a compulsory subject in the polymathic curriculum that is forced upon the student at present, but the opportunity at least should be freely offered. And indeed it is offered in a way in all good colleges. I only wonder that its general value is not more widely appreciated. Instead of being restricted practically to those expecting to enter the medical profession or looking forward to careers as specialists, it should be utilized by all who hope to keep abreast of the intellectual life of their times.

From a pedagogical standpoint biology is one of the most attractive subjects offered in the college programs. Outside any question of training value there are few if any subjects that lend themselves more

readily to good teaching. This peculiarity arises from the inherent human interest of the material it deals with, and by virtue of which it is easily possible to arouse the student to voluntary effort. The more I see of practical teaching the more I am convinced of the great influence that can be exerted by a teacher in this matter of stimulating the interest of students in his subject. Interest in one's work is like a brilliant light; it brings out numerous details that would be overlooked in the obscurer illumination that comes from an effort under compulsion or from a mere sense of duty, and by the same token the mental impressions produced under its influence are of a more enduring character. Real interest in one's work leads to voluntary exertion and to a concentration of attention, both of which factors produce excellent results, as regards the subject under study as well as in the matter of exercising and developing the potential capacities of the brain. I should be willing to defend this thesis purely on physiological grounds, although it is scarcely necessary, perhaps, since it seems to be fully appreciated in modern methods of teaching, particularly in the instruction of the young.

I am sure that those of us who are watching the education of our children must be struck with this fact. In former times the teacher, from the beginning, was often a task master, driving us to unwelcome labor, and when interest on the part of the pupil flagged he stirred up the circulation in the organs of thought by external applications of the rod. Learning and the rod, to use an often-quoted simile, were nail and hammer. The method was effective; temporarily, at least, it served as a means of concentrating the mind on the work in hand, but from the physiological standpoint the rod is a crude instrument, ill-adapted to mental culture. In these happier days the teacher is more frequently a friend endeavoring

by gentler means to arouse in his pupils a vivid personal interest in the subjects studied, and successful in his work in proportion to his ability to effect this result. In fact, I am inclined to believe that the power to interest his students in their work is the test of a good teacher. It makes no difference how well a teacher may know his subject, nor how skilled he may be in the technical side of his calling, if he has not sufficient enthusiasm and ingenuity to put life and attractiveness into his instruction he is not doing justice to his opportunities. No student is getting the full measure of information or mental discipline out of his course unless by the interest he takes in the subject, or by some other means, he has been led to exert himself voluntarily. I feel that this consideration is quite as important in university instruction as in kindergarten teaching. I am convinced that every teacher should exert himself to devise legitimate means of arousing the interest of his student, upon the theory that they will thereby be led to think and meditate for themselves. It is for this reason, mainly, that in the natural sciences we make such extensive use of ocular demonstrations. It is not often that these demonstrations are really necessary to the comprehension of facts; their value, so it seems to me at least, lies mainly in this, that they stir the sluggish mind, they bring the brain into a condition of receptivity and activity in which it is at its best as a physiological mechanism.

That this last statement is a matter of fact and not a mere figure of speech is indicated pretty clearly by laboratory experiments. It is well known to physiologists that mental exertion is accompanied by a greater flow of blood through the brain, and that, roughly speaking, the effectiveness and intensity of the brain work is proportional to the increase in the flow of blood. We have instruments in the laboratories by

means of which we can measure these changes in blood flow, and thus approximately determine the intensity of mental activity under different conditions. I need not here describe the instrument any further than to say that it consists of an apparatus for measuring the volume of the hand or arm. When the brain is working actively the arm shrinks in size, the shrinkage being due to a shunting, so to speak, of some of its blood to the brain. I have had occasion to use this apparatus repeatedly in my laboratory, and the results seem to indicate quite clearly that an important factor in bringing about increased circulation through the brain, and therefore probably an accompanying intensity of brain activity, is that of a high degree of interest in the subject of thought or discussion.

I may be permitted to describe one or two incidents which, though trivial in themselves, illustrate the point I am making. It happened on one occasion that a graduate student in my laboratory, a Catholic priest, was using this apparatus in the course of some investigations upon the physiological effects of pleasant and unpleasant sensations. In connection with his problem he made a number of tests of the effect of strong mental activity upon the circulation. In one of these experiments he had a young theological student in the apparatus and was putting him through an examination, with the result that the record showed some indication of increased mental activity. He had arranged, however, that while the experiment was in progress one of the young man's regular teachers should appear suddenly upon the scene and pretend to give him his final examination which was due at about that time. The ruse succeeded admirably; the student took the examination seriously and the effect upon his arm was so great that the apparatus was unable to record the full extent of its shrinkage. It was a capi-

tal illustration of the effect on the circulatory system of intense mental activity when accompanied by some degree of emotional excitement; or as a Methodist Bishop, to whom I was showing the record, expressed himself, it showed the serious effect that dogmatic theology may have on the extremities.

On another occasion, a colleague of the priest, who was himself an instructor in a theological seminary, was placed in the apparatus and subjected to an examination. The result upon his extremities was very slight. The truth was that he was on familiar grounds, he was as well acquainted with the subject as his interlocutor, and perhaps was a little weary of it. The experimenter, however, recalled that his friend was from Kentucky and began to ask some questions concerning the blue-grass region, the breeds of race-horses and horses in general. He was delighted to find that he not only got an enthusiastic and minute description of the region and its famous racers, but, that his apparatus gave most satisfactory indications that the sluggish brain had been fully aroused, and was working in its best form as regards the subject under discussion.

Many similar results obtained by other observers bear witness to the general truth that the element of interest is an important factor in stimulating brain activity, and so acting upon the vaso-motor centers as to put this organ under its most favorable physiological conditions for work. The brain that is but half aroused and interested is in fact partly unconscious. Much that it sees or hears fails utterly to awaken that chain of associations, that synthesis and comparison of memory records which forms the physical basis of mental growth and training.

It is possible, I believe, that this factor is not entirely appreciated in our college teaching. Some weight, indeed consider-

able weight should be given to it, not only in the individual work of the teacher, but in the construction of courses. I do not mean, of course, that in making the curriculum this consideration should have a predominating influence, but it should certainly be borne in mind. Other things being equal the subject that has the most intrinsic interest is likely to have the highest degree of training and developing value, and I feel safe in asserting that this virtue is possessed to an uncommon degree by the subject of biology. Its importance in illustrating the methods of scientific thought, and the practical utility in life of its subject matter are combined with an attractiveness that appeals to every intelligent person.

To have under the eye the primitive forms of life in all their strange and suggestive variations, to follow the development of an apparently simple and structureless ovum into a complicated and exquisitely constructed organism and to see these various stages in the individual history paralleled in nature by the slow phylogenetic growth of animal forms, to realize for one's self the community of structure and function that binds together all living beings, these things are of a nature to awaken interest in the minds of the most careless. Such at least was my personal experience as a student, and such has been my observation upon many classes composed of men with varied training and widely different purposes in life. Just as an elementary study of astronomy lifts one out of his self-sufficient narrowness and brings him face to face with great thoughts and problems, so an acquaintance with the teeming existence of the microscopic world leads us to a thoughtful, intelligent and humble consideration of the great mysteries of the universe.

The desirability of having some form of biological work represented in our college courses commends itself to my mind for

still another reason which has, I believe, some practical basis. I refer to the fact that during a man's college life it is necessary as a rule that some decision shall be reached concerning the character of his future career. There are some, doubtless, among our college students upon whose conscience the necessity of making this decision rests but lightly, by reason of the exuberant hopefulness and confidence of youth, yet upon the whole I fancy that few students in their senior year fail to give this serious subject much careful and anxious consideration. Motives of expediency or the advice of parents or friends frequently furnish the controlling factor in the decision to which he finally comes, but individually he must desire and seek for some light, from his own experience, regarding his personal fitness and adaptability for the various possible careers that lie before him. It is a sad business when the search is fruitless, and he stands at the parting of the ways, undecided, not knowing which path offers to him the greatest chances of happiness, usefulness and success. It seems to me that a student's college course should be of direct assistance to him in this matter of his life's work, not only in giving him a general training that shall send him forth equipped for competition with his fellows, and prepared to enjoy the usufruct of the world's intellectual inheritance, but specifically in throwing light upon the nature of his own talents. In some way this period of preparation and training should be adapted to enable the individual to find himself, to discover wherein lie his greatest interests and greatest possibility of success and happiness. For this reason it would seem to be a mistake if a department of knowledge so important and peculiar as biology is not brought in some way to the student's attention. It forms the gateway to at least one great profession which though overcrowded at present is in



reality suffering from the lack of men with college training.

If our colleges could turn into the profession of medicine those of their students who find within themselves a peculiar adaptability to its work, to take the place of the thousands of uneducated men who at present are attracted to it by commercial motives alone, they would accomplish a most useful work for humanity at large.

W. H. HOWELL.

JOHNS HOPKINS UNIVERSITY.

THE OPENING OF THE HALL OF NATURAL HISTORY, TRINITY COLLEGE.

On December 7th the new Hall of Natural History of Trinity College was formally opened.

The Rev. George Williamson Smith, D.D., President of the College, delivered the address of welcome, as follows:

"It gives me great pleasure to welcome

of chemistry and mineralogy, of agriculture and political economy, and of botany. A professor of natural philosophy was to be appointed at an early day. It was a radical departure from the college curriculum accepted at that time to give such a large place to scientific study, and the difference was increased by a provision that students could be admitted to 'pursue such *particular studies* as might be suited to their circumstances,' 'or as the inclination of their parents or guardians might require.' The additional announcement that 'if, in the end' of their association with the college, 'the amount of the attainments' of special students 'should be judged by the faculty to be equal to the knowledge acquired in the regular course, they might be candidates for the Degrees in Arts, which would be conferred on the students in that course,' is still regarded as revolutionary in most of our colleges.

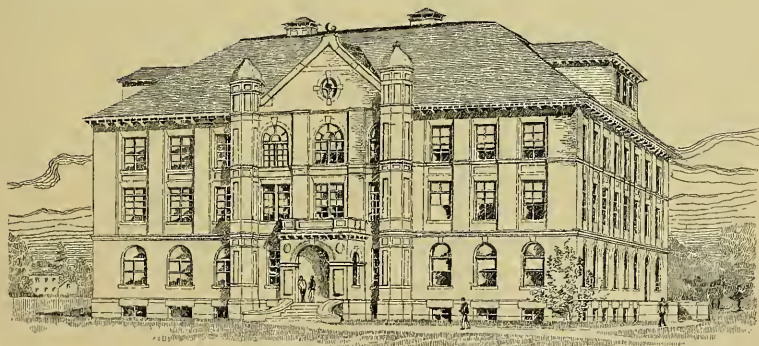

FIG. 1. The Hall of Natural History.

you to Trinity College on this occasion. It is the realization of what was undertaken by the trustees of Washington College when they issued their prospectus in 1824. In that prospectus we find that professors had been appointed for departments

"The position and importance given to scientific studies attracted a large number of students who wished to prepare for the study of medicine or for scientific pursuits, and among the early students a large proportion became distinguished physicians.

Among the special students in 1829 was James H. Ward, a midshipman of the United States Navy, who was preparing for the examination for past-midshipman, and who found in Washington College the opportunities for such studies as he desired to pursue and which were cultivated in only a few places. It was largely through his instrumentality that the United States Naval Academy was founded by Bancroft in 1844.

"But the men who founded Washington College, with its startling departure from the accepted course of study, were half a century in advance of their day; and it is as fatal to a man's usefulness to be fifty years ahead of his time as to be fifty years behind it. The college was compelled to recede from its advanced position and do the work called for in its generation. But the scientific studies, though reduced, were never abandoned. A few years ago, by the generosity of alumni and friends of the college, among whom the late Junius S. Morgan, of London, and Mr. Walter Keney, of Hartford, were conspicuous, but particularly by the large gift of the late George A. Jarvis, of Brooklyn, N. Y., the laboratories for physics and chemistry were constructed and equipped. In 1888 tentative efforts were made to procure the funds for the erection of a building for the museum and department of natural history. The time was not deemed favorable and the project slept until 1893, when another effort was made. But the flurry of a threatened war with England over the Venezuelan boundary caused another postponement. In 1898 the effort was renewed; several large subscriptions were obtained, W. C. Brocklesby, an alumnus of the college, whose father had been for many years a professor in charge of the work of natural history, was engaged as architect, and to-day we have the satisfaction of seeing the completion of this part of the project of our vener-

ated founder and his associates. In their name, as well as our own, I bid you welcome."

In addition to the addresses by Professor H. F. Osborn and Professor W. H. Howell given above, short addresses were made by Professor Hadley, of Yale; President Carter, of Williams; Professor Conn, of Wesleyan and ex-President Pynchen, of Trinity.

The following extracts from congratulatory letters to Professor Edwards were read:

"The generous support which is afforded by your countrymen to scientific institutions is in the highest degree creditable to the nation and sadly contrasts with the treatment accorded to naturalists in the old country.

"I need hardly say that I am fully aware of the splendid contributions to the various branches of natural history which have been made by members of the staff of the various universities and colleges of the United States, and I trust that the magnificent scientific reputation of such men as Louis and Alexander Agassiz, Asa Gray, T. D. Dana, and O. C. Marsh may serve as an incitement to their successors in similar lines of research, and that the mantle which they dropped may abide with future generations in Trinity College, Hartford. Believe me, dear sir,

"Very faithfully yours,

"ROBERT D. CUNNINGHAM, M.D."

PROFESSOR OF NATURAL HISTORY,  
QUEEN'S COLLEGE, BELFAST, IRELAND.

"It is my wish that your new hall may receive and instruct many generations of students, and that it may inspire in many the taste for zoology.

"Very cordially yours,

"L. CUÉNOT."

PROFESSOR OF ZOOLOGY AND PHYSIOLOGY,  
UNIVERSITY OF NANCY, FRANCE.

"With all good wishes for the success of your labor, I am

"Yours very faithfully,

"FRANCIS DARWIN."

CAMBRIDGE, ENGLAND,  
August 15, 1900.

"I regret that distance, and the occupations that fill the life of all those who have devoted themselves to science, do not permit me to be present in person at the inauguration of the Laboratory of Natural History of your college. But I am with you in heart, and I send you in this letter my most earnest wishes for the success of your laboratory.

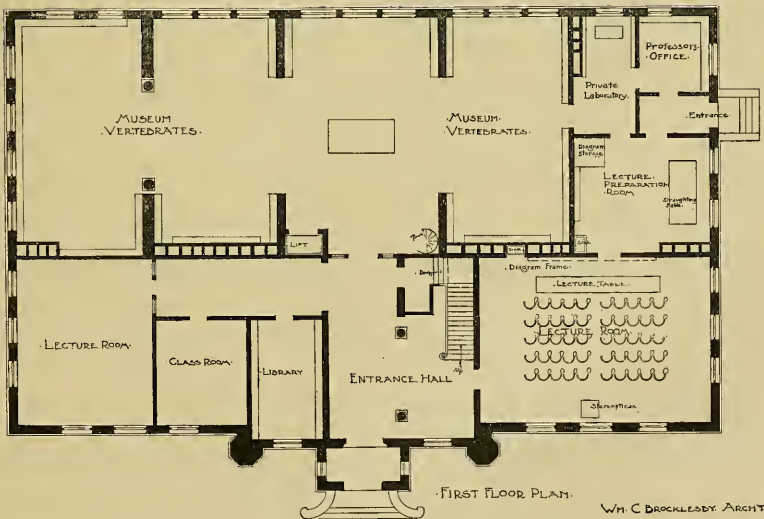
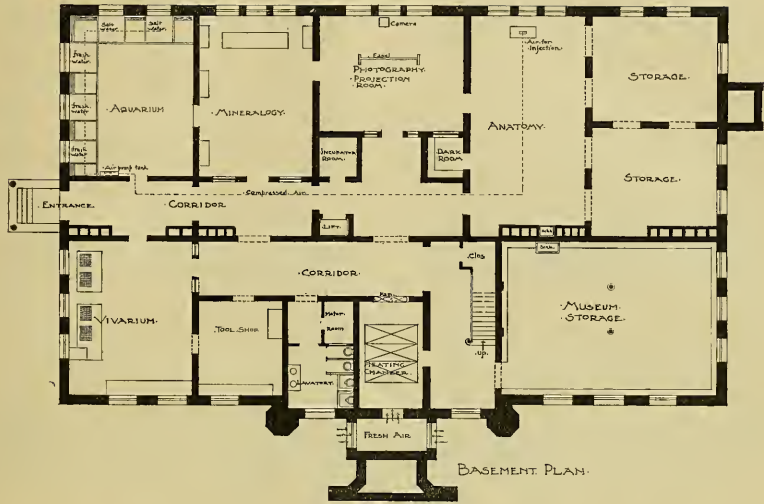

WM. C. BROCKLESBY ARCHT.

FIG. 2. Hall of Natural History.

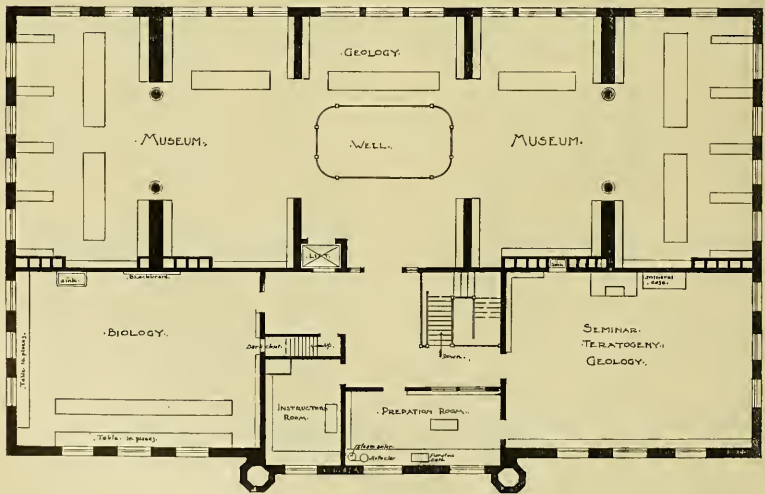
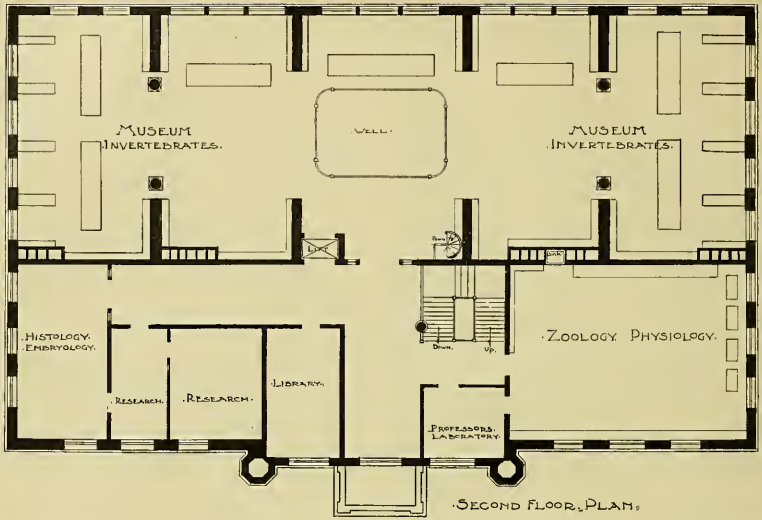

FIG. 3. Hall of Natural History.

"Moreover, there can be no doubt of this success, for you will display there, you, your associates in labor and your pupils, the remarkable qualities of your race, and you will be with us in the vanguard in the great battle that we are fighting without truce for the discovery of the truth, a noble conflict in which all the combatants participate in the advantages of victory, and which causes to flow neither blood nor tears.

"YVES DELAGE."

PROFESSOR OF ZOOLOGY AND COMPARATIVE  
ANATOMY, UNIVERSITY OF PARIS, FRANCE.

"I wish your new Hall of Natural History the very best success. I am

"Yours very respectfully,

"PROFESSOR DR. ANTON DOHRN."

ZOOLOGICAL STATION,  
NAPLES, ITALY.

"I send you my best wishes for the opening of your new Natural History Institute in Trinity College, and hope it will bring to maturity many advances in the investigation of the grand treasures of Nature of your beautiful country, which I had the pleasure of becoming acquainted with last year. With greatest esteem,

"Yours truly,

PROFESSOR D. A. FOREL."

ZURICH, SWITZERLAND.

"Thank you very much for the sending of your program of instruction, which I have read with the greatest interest. I congratulate you upon the problem which you have set for yourself; that zoology and anatomy can only gain when they are permeated by physiological and general biological principles, is, alas, not yet recognized to any extent. Only in botany is recognized the natural union of form and function in teaching, and there but to a slight degree; this has found expression in the splendid book of Haberlandt, 'Physiological Anatomy.' Mineralogy and geology in Zurich have undergone a similar process.

"To the anatomist and zoologist on the contrary, the comparative method is allowed, and the so-called 'purely mechanical' points of view are repudiated.

"Yours truly,

"MAX VON FREY."

UNIVERSITY OF WÜRZBURG,  
GERMANY.

"May the Hall of Natural History be a complete success—fulfilling all the aspirations of its founders and well-wishers! Had it been possible it would have afforded me much pleasure and satisfaction to have been present at your opening function. All I

can do now is to wish the institution and yourself Godspeed!

"Yours very truly,

"JAMES GEIKIE."

UNIVERSITY OF EDINBURGH,  
SCOTLAND.

"I should have been happy to express personally to you my great admiration for the powerful scientific movement taking place in the United States of America, the proof of which is given by the erection of so many splendid universities. I send you my heartiest wishes that the Biological Laboratory of Hartford may soon produce numerous and excellent works in all branches of modern biology. Believe me, dear sir,

"Yours very sincerely,

"A. GIARD."

MEMBRE DE L'INSTITUT DE  
FRANCE.

"In reply to your invitation I wish to send, in my absence, a few words of hearty greeting on the occasion of the opening of your Hall of Natural History. I hold it an imperative duty of the minister of every denomination of religion to seek to understand the modes of thought of his flock. And considering the way biological progress has influenced man's way of looking at things generally, it seems to me that its study is one specially necessary for the ministry. The work of the churches or great social bond of union and progress in humanity is one we all recognize. That men anxious and willing to work for this end should have had their services unutilized in the past—the very recent past—through the lack of understanding of the theologians is a fact to be deeply regretted. And the new foundation in your college should make for charity in human fellowship, through and with the advancement of human knowledge. I am, gentlemen,

"Faithfully yours,

"MARCUS HARTZOG, D.Sc., M.D., F.L.S."

PROFESSOR OF NATURAL HISTORY,  
QUEEN'S COLLEGE, CORK, IRELAND.

"The natural sciences, and not in the least biology, have in a few decades developed remarkably in the United States. Proof of this are the newly founded, splendidly equipped universities, natural history museums, marine biological stations, and recently published journals, by means of which science has already experienced so many additions due to American research.

"That the newly erected 'Hall of Natural History of Trinity College,' placed under your guidance, may

develop to a worthy home of the natural sciences, I wish from all my heart.

"Yours truly,

"DR. OSCAR HERTWIG."

UNIVERSITY OF BERLIN,  
GERMANY.

"I express my interest in the erection of your institute. Its creation will be a new proof of the successful zeal with which the younger school of your country is occupied to further scientific progress in unconfined research, as well as in the dissemination of knowledge. With the most respectful greetings,

"Yours truly,

"WILLIAM HIS."

UNIVERSITY OF LEIPZIG,  
GERMANY.

"You may perhaps be surprised to hear that I passed two very happy years of my boyhood in Hartford, attending the high school, and that I still count among my best friends a number of Hartford people. You may, therefore, imagine with what satisfaction I learned that in the city with which my personal relations, so to speak, are very intimate, a hall has been established in which the subjects in my own special lines are to be studied. I congratulate the city, the College and you on the completion of the Hall of Natural History, and hope that it will become a center of scientific activities and will do its full share in the advancement of knowledge, as it no doubt will. With best wishes, I remain

"Yours sincerely,

"K. MITSUKURI."

IMPERIAL UNIVERSITY,  
TOKIO, JAPAN,

"I have much pleasure in sending you my best wishes for the new Hall of Natural History at Trinity College, Hartford. May it have a long, useful and prosperous career. May it train many men to do good and honest work in natural history, that most delightful of the sciences, and may financial blight—that curse of so many scientific undertakings, never fall upon it! I much regret that I cannot myself be present on the occasion to offer my congratulations in person.

"It is now exactly a quarter of a century since I began the study of Natural History under that brilliant zoologist, that truly great and distinguished man, Francis Maitland Balfour. The lessons I learnt from him I would fain teach to others, and it has always been my endeavor to do so. The most important of them were—thoroughness and honesty in work, the realization of the fact that no scientific work is worth doing unless it be done primarily for

the sake of the work, and not primarily for the sake of the worker. The realization of this fact is the most important result which a sound education can produce.

"I cannot wish you anything better than this—that the work done in your institution may be honest work, sound work, work which men of all countries and all languages who are seeking after truth may turn to with confidence, that there at least they will find the real thing—an honest record of painstaking observation.

"In other words, may your institution be the means of training men to work like Johannes Müller, Charles Darwin, Thomas Henry Huxley, Albert Kölliker, Elias Metschnikoff and Francis Maitland Balfour. I am, dear sir,

"Yours sincerely,

"ADAM SEDGWICK."

READER IN MORPHOLOGY AND EMBRYOLOGY OF  
ANIMALS, TRINITY COLLEGE, UNIVERSITY OF  
CAMBRIDGE, ENGLAND.

"I pledge you my sincerest wishes for the new Hall of Natural History of Trinity College. May it take its place in contributing to the greatest researches which the United States have produced in the last decennium for our sciences, and which have stirred up the admiration, yes, I may say, the envy of the entire Old World. With this wish, I remain, in greatest esteem,

"Yours truly,

"DR. J. W. SPENGLER."

UNIVERSITY OF GIESSEN,  
GERMANY.

"I express my admiration and forcible acknowledgment of how zealous your countrymen in the great country of the United States are to further science in every direction; I wish Trinity College and especially its scientific institutes the greatest success and development.

"Most respectfully yours,

"WALDEYER."

UNIVERSITY OF BERLIN,  
GERMANY.

"Kindly accept my wishes for the success of this solemnity and for the ever progressive development of the knowledge of truth, as well as of the spirit of research in your university.

"I beg you, sir and your colleagues, to accept the expression of my cordial appreciation.

"EMILE YUNG."

PROFESSOR OF ZOOLOGY AND OF COMPARATIVE  
ANATOMY IN THE UNIVERSITY OF GENEVA,  
SWITZERLAND.

In addition letters were received from:

Professor Henry Blanc, University of Lausanne, France.

Professor Wilhelm Blasius, University of Braunschweig, Germany.

Professor O. Bütschli, University of Heidelberg, Germany.

Professor Carl Chun, University of Leipzig, Germany.

Professor E. Ehlers, University of Göttingen, Germany.

Sir Michael Foster, University of Cambridge, England.

Professor A. A. W. Hubrecht, of Utrecht, Holland.

Professor Alexander Kovalevskij, St. Petersburg, Russia.

Professor W. N. Parker, University College, Cardiff Wales.

Professor E. B. Poulton, University of Oxford, England.

Professor Dr. Louis Ronle, University of Toulouse, France.

Professor G. O. Sars, Christiania, Norway.

Professor Dr. Franz Eilhard Schulze, University of Berlin, Germany.

Professor Aleksandr Andrejevid Tiebomirov, University of Moscow, Russia.

Professor Sydney Howard Vines, University of Oxford, England.

Professor S. Watasé, University of Tokio, Japan.

Professor R. Wiedersheim, University of Freiburg, Germany.

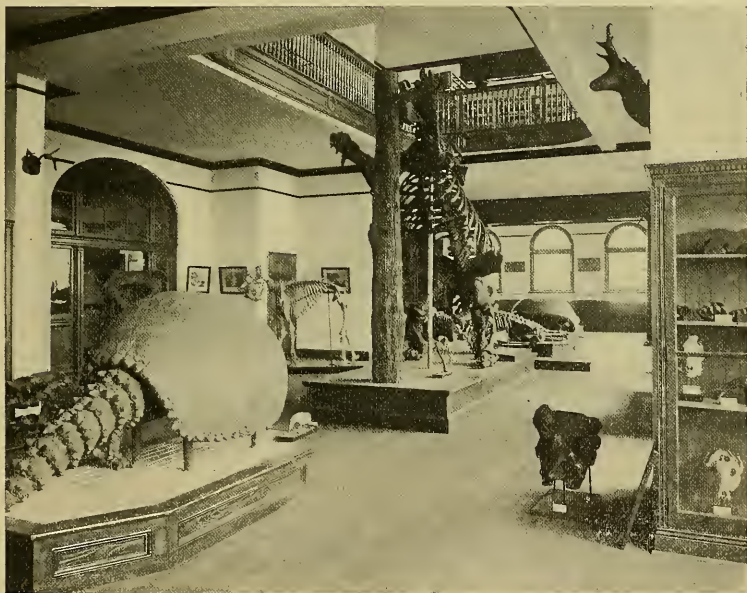

FIG. 4. Museum.

Professor Hubert Ludwig, University of Bonn, Germany.

Professor H. N. Mackintosh, Trinity College, Dublin, Ireland.

Professor K. Möbius, University of Berlin, Germany.

#### THE HALL OF NATURAL HISTORY.

The building having a frontage to the north of 122 feet, and a width of 72 feet, is three stories high above an ample basement. The materials used are common

brick, molded brick and sandstone for finish.

In plan the building is a parallelogram, with a central projection 40 feet wide, flanked by octagonal turrets extending through the several stories and finished above the main roof line. The principal

The arrangement of rooms is shown in the accompanying diagrams.

A feature of the equipment is the aquarium and vivarium rooms in the basement. In the aquarium there are five tanks, each containing 290 gallons, paneled off from the main room as in the Berlin, Washington,

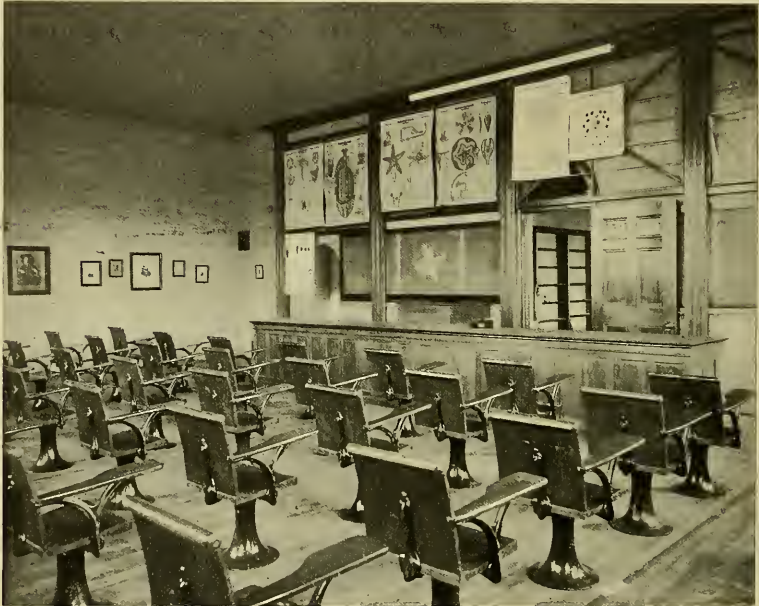

FIG. 5. Lecture Room.

entrance gives access to a wide staircase hall. Directly opposite this entrance is the doorway to the Museum.

The Museum occupies three floors, the two upper ones having each an area of over 4,650 square feet, the first floor being connected with the second by an iron staircase and a large floor-well, which forms a feature in the construction of the second floor. The whole Museum has a southern exposure and is adequately lighted.

Battery Park and other aquaria. Thus the public can see the animals under the most favorable conditions, while in the aquarium section the students may work at problems in comparative physiology and comparative psychology without being disturbed. Three of the tanks are for marine and two for fresh-water animals and plants. The great advantage, as an adjunct to teaching, of having alive such animals as medusæ, star-fish, sea-cucumbers and anemones is apparent to



anyone who has attempted to gain a natural conception of such forms from only alcoholic material. In the attic is a large pigeon house for breeding purposes. Glass beehives and ant nests are used for the study of community life. In fact, it is planned to have every order of animals represented by typical species in the aquaria and vivaria, so that the study of function may go hand in hand with the study of form.

In the museum each order is represented by specimens in alcohol, skins, skeletons, a dissection accompanied by a water-color sketch, with all the parts plainly labeled and embryological models with explanatory charts, in order that the visitor or student may learn as much as possible of the forms exhibited rather than become overwhelmed with the wealth of species.

#### AN ARTIFICIAL REPRESENTATION OF A TOTAL SOLAR ECLIPSE.

In preparing for polarization experiments on the solar corona it is extremely desirable to have an artificial corona as nearly as possible resembling the reality, for preliminary work. The only device of the kind that has been used to my knowledge is the arrangement described by Wright in his eclipse report, consisting of a cardboard funnel, lined with black cloth, with a light at the back. This gives a ring-shaped illuminated area radially polarized. It is believed that the contrivance about to be described will be found far better adapted to work of this sort, for the artificial corona in this case resembles the real so closely as to startle one who has actually witnessed a total solar eclipse; the polarization is radial, and is produced in the same way as in the sun's surroundings, and the misty gradations of brilliancy are present as well. So perfect was the representation that I added several features of purely æsthetic nature, to heighten the effect, and finally succeeded in getting a reproduction of a solar eclipse

which could hardly be distinguished from the reality, except that the polar streamers are straight as drawn by Trouvelot, instead of being curved, as all the recent photographs show them. The curious greenish-blue color of the sky and the peculiar pearly luster and misty appearance are faithfully reproduced. For lecture purposes an artificial eclipse of this sort would be admirably adapted, and I know of no way in which an audience could be given so vivid an idea of the beauty of the phenomenon. Drawings and photographs are wholly inadequate in giving any notion of the actual appearance of the sun's surroundings, and I feel sure that any one will feel amply repaid for the small amount of trouble necessary in fitting up the arrangement which I shall describe.

A rectangular glass tank about a foot square on the front and five or six inches wide, and a six-candle-power incandescent lamp are all that are necessary. The dimensions of the tank are not of much importance, a small aquarium being admirably adapted for the purpose. The tank should be nearly filled with clean water, and a spoonful or two (the right amount determined by experiment) of a weak alcoholic solution of mastic should be added. The mastic is at once thrown down as an exceedingly fine precipitate, giving the water a milky appearance. The wires leading to the lamp should be passed through a short glass tube, and the lamp fastened to the end of the tube with sealing wax, taking care to make a tight joint, to prevent the water from entering the tube. (Fig. 1.) Five or six strips of tin foil are now fastened with shellac along the sides of the lamp,



FIG. 1.

leaving a space of from  $\frac{1}{2}$  to 1 mm. between them. The strips should be of about the same width as the clear spaces. They are to be mounted in two groups on opposite sides of the lamp,

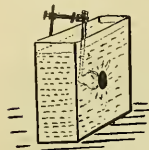

FIG. 2.

them produce the polar streamers. The proper number, width and distribution of the strips necessary to produce the most realistic effect can be easily determined by experiment.\* A circular disk of metal, a trifle larger than the lamp, should be fastened to the tip of the lamp with sealing-wax, or any soft, water-resisting cement; this cuts off the direct light of the lamp and rep-

resents the dark disk of the moon. The whole is to be immersed in the tank, with the lamp in a horizontal position, and the metal disk close against the front glass plate. (Fig. 2.) It is a good plan to have a rheostat in circuit with the lamp to regulate the intensity of the illumination. On turning on the current and seating ourselves in front of the tank we shall see a most beautiful corona, caused by the scattering of the light of the lamp by the small particles of mastic suspended in the water. If we look at it through a Nicol prism we shall find that it is radially polarized, a dark area appearing on each side of the lamp, which turns as we turn the Nicol. The illumination is not uniform around the lamp, owing to unsymmetrical distribution of the candle power, and this heightens the effect. If the polar streamers are found to be too sharply defined or too wide, the defect can be easily remedied by altering the tin-foil strips. The eclipse is not yet per-



FIG. 3.

fect, however, the illumination of the sky background being too white and too brilliant in comparison. By adding a solution of some bluish-green aniline dye (I used malachite green) the sky can be given its weird color, and the corona brought out much more distinctly. If the proper amount

\*Probably black paint could be used instead of the tin-foil strips.

of the lamp to regulate the intensity of the illumination. On turning on the current and seating ourselves in front of the tank we shall see a most beautiful corona, caused by the scattering of the light of the lamp by the small particles of mastic suspended in the water. If we look at it through a Nicol prism we shall find that it is radially polarized, a dark area appearing on each side of the lamp, which turns as we turn the Nicol. The illumination is not uniform around the lamp, owing to unsymmetrical distribution of the candle power, and this heightens the effect. If the polar streamers are found to be too sharply defined or too wide, the defect can be easily remedied by altering the tin-foil strips. The eclipse is not yet per-

of the dye be added, the sky can be strongly colored without apparently changing the color of the corona in the slightest degree, a rather surprising circumstance, since both are produced by the same means. We should have now a most beautiful and perfect reproduction of the wonderful atmosphere around the sun, a corona of pure golden white light, with pearly luster and exquisite texture, the misty streamers stretching out until lost on the bluish-green background of the sky. The rifts or darker areas due to the unequal illumination are present as well as the polar streamers. The effect is heightened if the eyes are partially closed.

A photograph of one of these artificial eclipses is reproduced in Fig. 3. Much of the fine detail present in the negative is lost in the print, and still more will doubtless go in the process of reproduction. The coronal streamers extend out much farther than is indicated by the photograph. No especial pains were taken to get the polar rays just right.

R. W. WOOD.

UNIVERSITY OF WISCONSIN.

#### SCIENTIFIC BOOKS.

*Street Pavements and Paving Materials.* A Manual of City Pavements: the Methods and Materials of their Construction. For the use of Students, Engineers and City Officials. By GEORGE W. TILLSON, C.E., President Brooklyn Engineers' Club, etc. New York, John Wiley & Sons. 1900.

As might be inferred from the title, this is a very pretentious book. The design of the author appears to have been to exhaust the subject. A very careful examination of the book has convinced the reviewer that for the purpose of the reviewer the accomplishment of this design may be divided into two parts: (1) That portion of the book that comes strictly within the perview of the engineer, and (2) that portion which does not.

Before proceeding to the consideration of these parts we wish to remark certain condi-

tions that relate to the work as a whole. The author does not appear to have been impressed with the gravity and seriousness of the great work he has undertaken, but a certain atmosphere of flippancy pervades some of the most important discussions; as witness his definition of the word Bitumen on page 43.

Again, either the manuscript was very carelessly prepared, or the proofs were very carelessly read, for the grave errors that are too numerous to mention can hardly be laid to the account of the printer. For illustration turn to page 53. The sentence, "He contends that by the use of petroleum ether a large amount of asphaltene is dissolved and is consequently called asphaltene," is nonsense, as it stands; the last word should be 'petrolene.' Further on he says, "I had to admit, and do admit, that the analysis as carried out by the later methods suffices to make identity or nonentity of two samples probable or highly probable." Nonentity should be nonidentity, and highly should be highly. To point out all the errors of this description would require too much space.

That portion of the work that relates strictly to engineering problems appears to be carefully prepared, and the various problems discussed appear to be treated with intelligence and discrimination. Had Mr. Tillson, as an engineer, discussed seriously and carefully read the proofs of a work devoted to the engineering problems involved in street paving, we do not doubt that a very valuable book would have been the result. For Mr. Tillson has reaped a field of immense extent, and he has brought together an immense amount of detail from widely separated sources and has brought them into convenient form. For this his fellow members of the engineering profession, and a wider clientele of miscellaneous readers outside his profession would have doubtless given him appreciative thanks. But, as before stated, Mr. Tillson has attempted, in a very pretentious way, to exhaust his subject, and has wandered far beyond the borders of his profession of engineering, thereby committing the blunder of attempting to treat subjects learnedly of which he has no knowledge. For engineers as a class are not trained in general science. They are

trained as engineers and have a fairly generous knowledge of physics, with only a smattering of chemistry, mineralogy and geology; yet following the example of the French engineers, which I have elsewhere mentioned, they seem to have a propensity for the discussion of the origin and properties of bitumens, a discussion which involves some of the most intricate problems in the sciences above mentioned now engaging the attention of scientific men. Hence, it is not strange, that outside the engineering problems which it treats intelligently, this book should be a chaotic jumble, brought together without chronological arrangement, without order as to the natural divisions of subjects, and discussed without discrimination and without satisfactory result. These defects of judgment and purpose would have been greatly mitigated if Mr. Tillson had not committed two unpardonable offences as an author. First, he cites from authors all over the world without giving in a single instance reference to the original memoirs, by which a reader can verify or extend the passage cited. Second, he has attributed to authors cited, language that they have never used, by substituting for the author's language his own abstract or paraphrase. In illustration, see page 43, where he patches up a definition of 'bitumen' by 'transposing Professor Sadtler's words and adding some of Mr. Richardson's.' He puts this patchwork that neither Sadtler nor Richardson would recognize, in quotation marks. From whom is it quoted? Again, on page 53, he quotes from my 'Tenth Census Report.' I read the passage with amazement. I knew I had never used such language. When I turned to the report I found that Mr. Tillson had substituted his own paraphrase for the language used by myself and had enclosed it in quotation marks. Comment on such atrocious work is unnecessary.

It would require too much time and space to show in detail all the blunders that are found in the nearly 40 pages devoted to 'Asphalt.' One other must suffice. This book is infested with the ill-disguised fallacy that material from the Trinidad Pitch Lake is superior to all other for street pavements. The old threadbare story of Eighth Avenue is rehearsed, etc.

I regret the necessity of such unqualified con-

demnation of much of this book; but the character of the criticism results from the nature of the case. I think I am safe in assuming that no railroad corporation would employ a chemist to construct a skew-arched bridge.

S. F. PECKHAM.

*American Education and What Shall It Be?*

Preliminary Report of the Committee of the Society for the Promotion of Engineering Education; made at the New York Meeting, July 2, 3, 1900. Reprinted, with discussion, from the Annual Volume of Proceedings; H. S. JACOBY, Secretary, Ithaca, N. Y. 8vo. Pp. 74. Price, 25 cents.

One of the speakers in the discussion began with the remark that this report marks an era in its department, that it was the first document of the sort which, so far as he had observed, recognized the fact that there may be 'many educations.' While it may not be the fact that the publication of this report was the first recognition of the necessity of various educations for various sorts and conditions of men,\* it is probably the first in which the fact of a variety of educations as a need of the time being recognized by authority is itself noted. The document is a reprint, from the transactions of the Society, of the report of a committee consisting of six representative educators in applied science and technical subjects, selected from representative institutions at Madison, St. Louis, Ithaca, Minneapolis, Boston and Philadelphia, who were requested to endeavor to give formal expression to the views held by them collectively on the question above quoted in the title of the paper thus prepared.

Space does not here permit of the presentation of any full abstract of the report, which is one which should be carefully read by every educator—and by our legislators even more carefully, if possible. The discussion is no less suggestive and invaluable than the report; a considerable number of well-known teachers and engineers taking part.

\* 'The Mechanic Arts and Modern Educations,' an address delivered at Richmond, Va., before the Mechanics' Institute of Virginia, by R. H. Thurston, May 18, 1894, Richmond, Va. William Ellis Jones. 1894 12mo. Pp. 23.

The committee agrees that there is a place for many kinds of school, and that they, as a rule, have their separate purposes and are, in fact, not competitors either among themselves or with the common school system of the country. Manual training schools, in which, as Dr. Woodward has said, 'the whole boy is sent to school,' are commended as adjuncts to the existing system, and, as a matter of fact, such schools are rapidly becoming incorporated into the common school systems of our larger cities and industrial towns. Manual training and art education are considered desirable as a part of all public school education, and provision should be made in them for both boys and girls, each in a suitable manner. The committee considers such a combination to be 'the ideal public school' for our country. The State agricultural and mechanical colleges constitute, in many of our States, another and important class, and are doing work which is adjudged to be far more than a compensation for their cost to the people. They are usually true secondary industrial schools, but they apparently divert many young men from agriculture into mechanical vocations. Minnesota, however, for example, and some other States, have very successful schools of agriculture.\*

The higher engineering schools are considered to be strictly professional schools of a high grade, which 'rank with the best' in any country. Our monotechnic or trade schools are still to be founded. They are considered to constitute the greatest need of the educational system. While the committee asserts that 'all schooling should lead primarily to the elevation

\* In the State of New York, it may be observed, while the State college, Cornell University, has a proportionally large body of mechanical engineering students and a relatively small body of agriculturalists, the latter, through its 'university extension work,' is performing an enormous task. It sent out in the year 1899-1900, over 7,000,000 pages of bulletins to farmers, embodying results of research in agricultural science and arts; it taught classes of 20,000 in 'Farmers' classes,' 25,000 in its 'Teachers' courses,' 35,000 in its 'Junior Naturalists' Clubs' and 2,500 in 'Home Nature Study,' a total of 83,000 students outside of the university.—President Schurman's Report, 1899-1900.

and development of the individual, and only secondarily to a greater material prosperity,' and italicizes the statement, it is considered, nevertheless, imperative that such institutions be established, if we are to hold our own, in the future, in the great competition among the nations. It is asserted that such schools need not be so conducted as to abrogate the principle just stated. The State of Massachusetts is already systematically encouraging the organization of textile schools, for example. It is such schools as these that have made Germany what she is, industrially.

Supplementary schools for workers are commended, such as evening schools, correspondence schools, etc. Proprietary and public and Y. M. C. A. evening schools, for example, are doing an immensely valuable work, and these schools cannot be too generally encouraged and sustained. Professor Higgins proposed 'half-time' school is thought well worthy of trial and is considered to have great promise. The higher schools of commerce and of business, which have been organized in some of our colleges already, are thought to be a step in the right direction.

The report is assumed to be preliminary and is to be later supplemented by special discussions of details and of special forms of industrial education. On the whole it would appear that the committee feel as did one of the gentlemen taking part in the discussion, Mr. Rothwell, said: "greater results can certainly be secured by educating the masses than in educating the small number in the higher departments of engineering"; although, as the same speaker remarked: "Nothing can be said against that." As Mr. Fay, of Rhode Island, put it, in his report to the State Legislature, 1877, the great problem is 'that of the adaptation of industrial education to our existing systems of mental training in the public schools,' and in this the committee is also agreed. The committee and the disputants seem to have substantially agreed with Col. E. D. Meier, who asserted that 'the point that the better part of the man should be educated is met by an education based upon the natural sciences'—after the manner advised by Huxley, we may presume.

R. H. THURSTON.

*A Text-Book of Histology, including Microscopic Technic.* Authorized Translation of the Second German Revised Edition of DR. BOEHM and VON DAVIDOFF'S Histology. Edited with Extensive Additions to Text and Illustrations by C. CARL HUBER, M.D., of the University of Michigan. Published in Philadelphia by W. B. Saunders & Co. 1900. Price, \$3.50, net.

In selecting Drs. Boehm and von Davidoff's 'Text-Book of Histology' for an English edition, the American editor has made a happy choice. The excellent features of the original German editions are too well known to need any extensive comment here.

In general plan, clearness and brevity of treatment, combined as a rule with sufficient detail, the text is admirable. The illustrations are for the most part quite good. Especially praiseworthy are the suggestions as to technical methods following each topic, and the references to literature in the back of the book. The student finds here an exceptionally valuable addition to the statements of the text, in the effects of reagents and other treatment of the structures described, and is led to understand how and by whom the science has been developed. This feature gives a very broad conception of the subject, explains the basis of the facts and conclusions presented, and at the same time makes it easy to confirm and extend them in the laboratory and through the literature.

We find unevenness of emphasis, certain subjects being described in much greater detail than are others, as is usually the case in text-books; but the constant reference to original sources should counteract this, and the book as a whole has certainly been a decided success.

Dr. Huber must be congratulated on his English version of so good a text-book. Taking Dr. Cushing's excellent translation as a basis, the editor has rearranged the text to advantage here and there, and has rewritten and extended a number of topics, greatly improving them. Many new and valuable figures have been introduced. This is especially true of the sections on the structure of ganglia and nerve end-organs, the figures having been taken from Dr. Huber's own papers on the peripheral nerves.

The nerve supply of all organs is much more fully treated than in the original. The discussion of the development of bone is much improved, and the sections on the structure of the spleen and ductless glands receive considerable additions.

The changes or additions of the editor seem well considered, wherever made, and it is only to be regretted that he has not attempted to bring all sections symmetrically up to date.

Finally the publishers must be complimented on a handsome book with excellent press-work, and with illustrations as good as those of the German edition, which is high praise.

It is a pleasure to cordially recommend this book as one of the very best text-books available on the subject.

H. MC. E. KNOWER.

ANATOMICAL LABORATORY,  
JOHNS HOPKINS UNIVERSITY.

BOOKS RECEIVED.

*The Elements of Astronomy.* ROBERT BALL. New York and London, The Macmillan Company. 1900. Pp. viii + 183. 80 cts.

*Die Pflanzen-Alkaloide.* JUL. WILH. BRÜHL, EDVARD HJELT and OSSIAN ASCHAN. Braunschweig, Friedrich Vieweg und Sohn. 1900. Pp. xxii + 586. M. 14.

*Beitrag zur Systematik und Genealogie der Reptilien.* MAX FÜRBRINGER. Jena, Gustav Fischer. 1900. Pp. 91.

*Ergebnisse der neueren Sporozoenforschung.* M. LÜHE. Jena, Gustav Fischer. 1900. Pp. iv + 100.

SCIENTIFIC JOURNALS AND ARTICLES.

IN the November-December number of the *Physical Review*, Mr. Frank Allen describes an interesting series of experiments to determine the effect upon the persistence of vision of exposing the eye to light of various wave-lengths. It is found that prolonged exposure to red light increases the persistence of vision for light from the red end of the spectrum, while the sensitiveness of the eye for other colors is unaffected. It has previously been shown by Ferry that a 'red-blind' eye shows abnormally great persistence of vision at the red end of the spectrum. In respect to the duration of impressions, therefore, as well as in other respects, an eye that has been fatigued by red light re-

sembles temporarily the eye of a red-blind individual. In like manner temporary green blindness and violet blindness may be produced by fatiguing the eye with light of the corresponding color. Very remarkable results are obtained when the eye is fatigued, not by exposure to one of the fundamental colors of the Young-Helmholtz theory, but by an intermediate color, such as yellow or blue. In case yellow light is used it is found that the persistence of vision is increased for both red and green; but that the persistence of vision for yellow light remains unchanged. The article contains much that is of great significance in connection with theories of color vision. In the same number of the *Review*, Dr. W. P. Boynton, of California, discusses the Gibb's 'Thermodynamic Model in the case of a substance obeying Van der Waal's Equation'; while Dr. J. C. Shedd, of Colorado College, gives an analytical discussion of the various forms of curves that are presented by the fringes seen in the Michelson interferometer.

#### SOCIETIES AND ACADEMIES.

##### NEW YORK ACADEMY OF SCIENCES.

###### SECTION OF BIOLOGY.

THE regular monthly meeting for December was held on the evening of the 10th, Professor C. L. Bristol presiding.

Professor Lloyd offered his resignation as Secretary of the Section, on account of his intended absence in Europe. On the motion of Professor Wilson, seconded by Dr. Calkins, a vote of thanks was tendered to the Secretary for his interest in furthering the work of the Section.

The following program then was offered:

G. N. Calkins: 'Some interesting Protozoa from Van Cortlandt Park.'

H. E. Crampton: 'Elimination in Lepidoptera.'

E. B. Wilson: 'The Chemical Fertilization of the Sea Urchin Egg.'

Dr. Calkins stated that there were four genera of Protozoa which are usually regarded as intermediate forms between the classes of Protozoa were considered. These were: *Nuclearia*, intermediate between the Rhizopoda and the Heliozoa; *Mastigamoeba*, intermediate

between Mastigophora and the Rhizopoda; *Multicilia*, intermediate between the Mastigophora and Ciliata, and *Actinobolus*, intermediate between the Ciliata and the Suctoria. The method of feeding in the latter form was also described for the first time. All these forms, together with 54 other genera and a great many species (100 to 150) were found in the waters of Van Cortlandt Park during the past fall.

The paper by Dr. Crampton was designed to be the first of a series dealing with the problems of variation and selection in Lepidoptera, and especially in the Saturnid moths. The particular questions here considered are as to the relative variability of eliminated and surviving pupæ and moths of *Philosamia cynthia*, and as to the relative variability of males and females. From a lot of 1,090 cocoons from a restricted locality, 310 living and 632 dead pupæ were obtained, the remainder being shriveled or abnormal larvæ and pupæ. The living pupæ were compared with an equal number of dead pupæ in reference to certain body-characters (length, length of bust, width, depth, frontal stature and sagittal stature of bust), and to certain characters of a typical organ, the left antenna (length, breadth and stature). It appears that the surviving males are slightly less variable than the eliminated males, and that the surviving females are far less variable. From the living pupæ 180 perfect moths were obtained. The males were from pupæ which were far less variable than pupæ producing abnormal moths; but the females were from relatively more variable pupæ, though the latter were much less variable than eliminated female pupæ of the preceding group. The paper will be published in full.

Professor Wilson presented the results of a study of the phenomena of development in the unfertilized eggs of *Toxopneustes* when treated with solutions of magnesium chloride by Loeb's method. The results confirm Loeb's conclusion that the embryos arising from these eggs are produced without fertilization by spermatozoa, conclusive proof being given in the fact that during cleavage the number of chromosomes is half the usual number, namely 18 instead of 36. The mitotic phenomena differ in many de-

tails from those occurring in fertilized eggs, but show a striking general parallel to them. The asters may be only two in number (cleavage asters), but as a rule there are many other asters (cytasters) that have no connection with the nucleus. Like the nuclear asters, however, the cytasters contain centrosomes and may progressively multiply by division. Cytasters and centrosomes are formed also in enucleated fragments obtained by shaking unfertilized eggs to pieces before treatment by the magnesium solution, and these asters may likewise multiply by division.

These facts seem to leave no doubt of the formation of functional centrosomes *de novo* and independently of the nucleus. Evidence was adduced to show that the asters may operate as centers of cytoplasmic division, independently of the nucleus. It was also shown that the magnesium eggs show numerous gradations in the mitotic process between complete division and partial mitosis.

FRANCIS E. LLOYD,  
*Secretary.*

ACADEMY OF SCIENCE OF ST. LOUIS.

At the meeting of the Academy of Science of St. Louis of December 17, 1900, forty-six persons present, the following subjects were presented:

Dr. O. Widmann read an account of the great St. Louis crow-roost, in which were embodied many facts concerning the life-history and habits of the common crow.

Professor F. E. Nipher gave an account of some of his recent results in positive photography. He has now found that hydrochinone baths of normal strength may be used. The formula given in each box of Cramer plates yields good results, if the mixed bath is diluted with water to one-third strength. The potassium bromide may be left out, and one drop of concentrated hypo solution must be added for each ounce of diluted bath. The hypo has a most wonderful effect. With the same bath, plates may be developed as positives, in the dark room or in direct sunlight. He had even started the developing of a plate in a dark room, where it progressed very slowly, but satisfactorily; continued the operation in diffused daylight in

an adjoining room, and finished the operation in direct sunlight. The process was accelerated by the light, but did not appear to be otherwise changed by the change in illumination. The resulting picture could not be distinguished from those produced by ordinary methods. This picture was shown by means of the lantern.

A box of Cramer's 'Crown,' 'Banner' or 'Isochromatic' plates may have the plates individually wrapped in black paper, in the dark room or at night, and all the remaining work may be done in the light. A plate is taken from its wrapping into the lighted room and placed in the slide holder. After exposure it is taken out into the light and placed in the developing bath, and the picture is then developed in the light, and may be fixed in the light. Of course, during the changes the plate should be shielded from the light as much as is feasible, and the fixing bath may always be covered. But all the operations may be carried on without any dark-room conveniences that may not be secured even in the open fields.

When weak hydrochinone baths are used, the picture, when developed in strong lamp-light, or in sunlight, has at first a golden-yellow color. When left in the lighted bath for an hour and a half, it slowly darkens to a nearly normal shade, as the details come out more sharply. If the exposure has been correctly made, there will be no trace of fog. With stronger baths, the picture comes out in the normal time, and has the normal shade.

If the pictures are too dense, the remedy is to reduce the strength of the sodium carbonate solution, or to increase the amount of hypo in the bath. Very fine results are obtained with the sodium carbonate solution at half the strength given in Cramer's formula.

When the plate has been sufficiently exposed, a negative of the object can usually be seen upon the plate before development. With long exposure this image is very distinct. It fades out in the bath, and the plate becomes clear. The shadows appear strongly but indistinctly at first, and of a pink color, and the high-lights still appear white. The solution remains clear. Too much hypo will cause turbidity and a loss of detail.

When the plate is exposed in a printing frame



under either a negative or a positive, an exposure of half a minute to diffuse daylight is ample, with an ordinary negative. The plate may be over-exposed by placing it for a long time in direct sunlight, and it will then appear on development somewhat like an over exposed negative. This has not yet been tried with hypo in the bath.

Professor Nipher showed a preliminary diagram in which exposure and illumination of the developing bath were taken as coordinates. The zero condition was represented by a line, and the conditions for producing direct and inverted pictures were represented by areas.

He also exposed and developed, in a common bath, in the lighted audience room, negatives printed from negatives and positives printed from positives.

The possible value of radio-active substances acting upon the developing plate in place of or in addition to light was referred to as a most promising field for study.

Professor Nipher stated that he had done no work with the plates of other makers, since he found on trial that one such plate did not give good results with the treatment that had succeeded with the Cramer plates.

One person was elected to active membership.

WILLIAM TRELEASE,

*Recording Secretary.*

ZOOLOGICAL CLUB, UNIVERSITY OF CHICAGO.

THE first meeting of the Quarter, October 17th, was devoted to a paper by Miss Mary Hefferan, giving the results of her researches on the variation of the teeth in the jaws of *Nereis*. This paper will appear elsewhere in full.

At the second session of the club, October 31st, Mr. R. S. Lillie gave an account of some experimental work upon the reactions of *Arenicola*-larvæ which was carried on by him during the last summer at Woods Holl. The following is a brief abstract of Mr. Lillie's paper:

In the swarming stage (in which three setigerous trunk segments are present) the larvæ are positively heliotropic and negatively geotropic, and in consequence collect at the surface of the water on the light side of the dish. After the fourth segment has appeared

the cilia are lost, the larvæ settle to the bottom, and the heliotropism becomes negative. The heliotropic response is due to the rays at the blue end of the spectrum, the red rays being apparently inactive.

The normal reactions of the swarming larvæ are altered under the following artificially induced conditions: (a) rise of temperature of the sea-water, (b) dilution or concentration of the sea-water within certain limits, (c) alteration of the chemical constitution of the medium. Rise of temperature above 35° is followed by loss of heliotropism and a gradual settling of the larvæ to the bottom; on cooling, however, heliotropism and negative geotropism largely appear. In dilute or concentrated sea-water the heliotropism in a large proportion of larvæ is altered from positive to negative; the same happens in slightly acidulated sea-water (though the effect here soon passes off and positive heliotropism reappears) and also in artificial solutions containing NaCl, CaCl<sub>2</sub>, and MgCl<sub>2</sub> in certain proportions.

Solutions of different salts affect ciliary and muscular movements in definite and characteristic ways. A fact of particular significance is that in the same solution one form of motility may be affected very differently from the other. Pure 5/8n NaCl solutions immediately arrest ciliary movement and cause a liquefaction and dissolution of the cilia; towards muscular movement its action is decidedly less injurious. The poisonous effect of the pure solution is, however, diminished by dilution, and also by the addition of small quantities of other salts, especially CaCl<sub>2</sub> and MgCl<sub>2</sub>. Solutions containing two salts in favorable proportions preserve ciliary and muscular activities for considerable periods, each form of activity having its own characteristic optimum solution which differs from that of the other. Pure CaCl<sub>2</sub> solutions and pure MgCl<sub>2</sub> solutions, and their mixtures, quickly arrest muscular activity and cause the larvæ to become perfectly rigid within a few minutes; while ciliary movement may continue in these solutions in some cases for hours after muscular movement has ceased. The larvæ, although capable of swimming about actively in these solutions, quickly lose all power of heliotropic orientation as their power

of muscular movement disappears; and in a short time they become collected in small groups or clumps, as a result of their inability to effect the muscular movements necessary to disengage them from the contact and adhesion of other larvæ. The fact that ciliary activity can continue (in some cases for many hours) in solutions in which all muscular movement is impossible, proves that these two forms of contractility are essentially very different.

Solutions containing three salts in suitable proportions are much more favorable than those containing only two. In solutions of the composition 40 cc. 5/8n NaCl + 55 cc. 10/8n MgCl<sub>2</sub> + 5 cc. 10/8n CaCl<sub>2</sub>, larvæ may remain living and capable of growth for so long a period as two weeks. Mixtures of the above three salts are the most favorable; the presence of KCl is injurious since potassium acts as a specific poison on muscular tissue. The three most essential metallic ions for the life-activities of these organisms are apparently Na, Ca, and Mg; K in very small proportions is probably also necessary.

On analysis of the normal swimming movements of the larvæ it appears that ciliary and muscular movements play separate and independent parts. Propulsion is effected exclusively by the action of the cilia, while heliotropic orientation is a purely muscular phenomenon with which the cilia have nothing directly to do. That this is so is proved (1) by direct observation, which shows that the cilia never exhibit a greater degree of activity on one side of the body than on the other, while the muscles of the more strongly illuminated side always show stronger contractions than those of the other; (2) by the fact of heliotropic orientation of the larvæ in later stages after the cilia have disappeared; and (3) by the fact that all power of heliotropic response is lost in solutions that remove muscular contractility without at first interfering with ciliary movement.

C. M. CHILD,

Secretary.

ZOOLOGICAL JOURNAL CLUB OF THE UNIVERSITY OF MICHIGAN.

THE meetings of November 6th and November 13th were occupied by Dr. H. S. Jennings

with an account, accompanied by demonstrations, of his researches on the activities of unicellular organisms. By means of the arc light, stereopticon and projecting microscope, with an intervening alum cell to cut out the heat, the living organisms were projected on the screen, and their reactions to various stimuli could be observed by those present. *Paramecium* thus appeared three inches long, and its minute structure, even to the cilia, was visible.

The collecting ('positive chemotaxis') of *Paramecia* about a bubble of CO<sub>2</sub> and in solutions of mineral acids was shown; also the spontaneous collections formed by the organisms, owing to the presence of CO<sub>2</sub> excreted by themselves. 'Negative chemotaxis' toward salt solutions was shown in the same way. Attention was then directed to the mechanism of the reactions, and it was pointed out that there was no orientation of the organisms either in collecting in the acids or in the negative reaction to salts. By throwing on the screen a slide of *Paramecia* with a small ring marked on the outside of the cover-glass, it was shown that in their swift roving movements at least ten *Paramecia* per second crossed this ring; hence that if any method could be found of keeping in the ring those that crossed it by chance, the area would soon swarm with the *Paramecia*. A drop of weak acid was now introduced beneath the marked ring; it could then be observed that the animals swam into the area just as before, but that on coming to the outer boundary of the area, they were turned back. Hence every *Paramecium* entering by chance remained in the area—swimming rapidly from one side to the other—and in a short time a dense collection was here formed ('positive chemotaxis').

To show the exact mechanism of the reactions, an organism having a more differentiated structure, so that its movements could be more easily followed, was thrown on the screen. For this purpose *Oxytricha* was used. The differentiation of right and left sides in this infusorian was pointed out; then as the individual approached a source of stimulus, the lecturer predicted, by pointing, in which direction the animal would turn on arriving at the stim-

ulus. The predictions were always fulfilled, since the animals always turn to their right when stimulated.

In the same way *Paramecia* always turn toward the *aboral* side when stimulated. These animals have thus a definite 'motor reaction' to almost any stimulus—consisting of a dart backward and a turning toward a *structurally defined* side. The collection of the *Paramecia* in the drop of acid is due to the fact that the passage from the acid to the water acts as a stimulus to produce this 'motor reaction.' This prevents them from leaving the acid, and a dense collection is soon formed.

The collecting of *Chilomónads* in acetic acid was shown. The essential identity in character of 'positive chemotaxis' or 'positive chemotropism' with 'negative chemotaxis' or 'chemokinesis' was demonstrated by showing that whether we get the one or the other depends on the relative arrangement of the two fluids. If the *Paramecia* or *Chilomónads* were in water, and a drop of acid was introduced, a dense group was quickly formed in the acid ('positive chemotaxis'); if on the other hand the organisms are in acid and a drop of water is introduced, the latter remains quite empty. If now the organisms were in water and a drop of salt solution was introduced, the drop remained empty ('negative chemotaxis,' or 'chemokinesis'); if the organisms were in salt solution and a drop of water was introduced, they swarmed into the drop of water, as previously into the acid. Passage from the water to acid does not cause the 'motor reaction,' while passage from the acid to the water does, hence they collect in the acid; passage from the salt solution to the water does not cause the reaction, while passage from the water to the salt does, hence they collect in the drop of water.

Many other demonstrations were given, and the significance of the results in simplifying the 'psychology' of these organisms, and in their relation to current theories of tropisms or taxis was discussed. Similar results to those set forth were stated to have been obtained with certain Metazoa also.

H. S. JENNINGS,  
*Secretary.*

#### DISCUSSION AND CORRESPONDENCE.

##### UNAUTHORIZED NEWSPAPER REPORTS.

IN view of the fact that a number of daily papers have printed reports concerning alleged or real experiments of mine I wish to state:

1. That none of the statements printed in the newspapers have been authorized by me.
2. That whatever I may have to say about my work will be published in scientific journals.

JACQUES LOEB.

UNIVERSITY OF CHICAGO.

##### AN APPEAL FOR ASSISTANCE.

TO THE EDITOR OF SCIENCE: A letter received from Mr. R. W. Garner, dated from Sao Thomé, West Africa, November 26, 1900, gives rather painful news of that intrepid explorer in the jungles of West Africa. Relying upon his remarkable powers of endurance and his simple habits of life, Mr. Garner started on this expedition with very limited means and an inadequate outfit. It seems that on this occasion he was overcome by the jungle fever, and the unexpected expense incurred by a month's sickness has exhausted his resources. He does not ask for help, but states that since he is already in a country where few men would care to venture, it seems as if some institution might like to send him a moderate sum of money, in return for which he would collect ethnological and zoological material, and at the same time could continue his own investigations. This is certainly a good opportunity, and any institution that can take advantage of it would at the same time be rendering assistance to a worthy explorer who is deserving of help in his undertaking. It will be necessary to secure Mr. Garner's services at once, since it is evident that if he does not receive some substantial cooperation, he cannot continue his researches. Any communication should be sent direct to Mr. R. W. Garner at Sao Thomé, West Africa.

F. W. PUTNAM.

PEABODY MUSEUM OF ARCHEOLOGY AND  
ETHNOLOGY, HARVARD UNIVERSITY,  
CAMBRIDGE, MASS.

##### CURRENT NOTES ON METEOROLOGY.

###### RAINFALL OF NEW SOUTH WALES.

THE 'Results of Rain, River, and Evaporation Observations made in New South Wales

during 1898,' compiled by H. C. Russell, Government Astronomer of New South Wales, show that the year 1898 is to be classed as a drought year, and was the fourth of that character to follow in succession. The average rainfall of the Colony for the year was 20.54 in., as against an average rainfall, derived from 28 years' record, of 24.85 in. The heaviest average rainfall, 64 in., is found on the Tweed river, just at the foot of a range of mountains from 4,000 to 6,000 feet high, against which the trade winds blow. A hopeful view is taken by Mr. Russell regarding the possibility of long range weather forecasts in New South Wales. "I am fully convinced," he says, "that a complete record of the rainfall will enable us to forecast the seasons with some show of success, provided, of course, that the extended knowledge of our rainfall is concurrent with a careful study of Australian and tropical weather, which is now in progress. \* \* \* Further study will, there is reason to expect, explain the reason for dry years and when to expect them."

#### RAINFALL AND ALTITUDE IN ENGLAND.

THE *Quarterly Journal* of the Royal Meteorological Society, for October, contains a paper by Marriott on 'Rainfall in the West and East of England in Relation to Altitude above Sea-Level,' in which the mean annual and monthly rainfalls at the English and Welsh stations are discussed for the ten-year period 1881-1890. The stations are classed as 'eastern' and 'western,' the former being those that drain to the east and the latter those that drain to the west. A further classification was made according to altitude, the stations being grouped together for each 50 ft. up to 500 ft., and above that altitude for each 100 ft. The increase of rainfall with altitude may be compactly summarized as follows:

100 feet + 9 per cent.	600 feet + 5 per cent.
200 " + 3 "	700 " + 38 "
300 " + 3 "	800 " + 3 "
400 " + 14 "	900 " + 4 "
500 " + 1 "	1000 " - 21 "

#### A NEW METEOROLOGY.

A NEW 'popular' presentation of the essential portions of meteorology, within the compass

of a small octavo volume of 123 pages, at a cost of 80 Pfenning (20 cents) comes in a recent mail from Germany. This little book is by Paul Kaegbein; is entitled 'Meteorologie'; appears in the *Wissenschaftliche Volksbibliothek*; is published by Schnurpfel, of Leipzig, and can really be recommended as giving a good general view of the subject with which it deals. The price is certainly low for the amount of information contained in the book. One of the chief objections to the book is the fact that the author has drawn largely on some of the standard works on meteorology, such as Hann's *Handbuch der Klimatologie*; Abercromby's *Weather*, etc., without acknowledging his indebtedness to the writers from whom he obtained his material.

#### ATLAS OF THE INDIAN OCEAN.

THE Royal Meteorological Institute of the Netherlands has recently issued a meteorological atlas of the Indian Ocean for the month of June, July and August. The two preceding volumes for the months of December, January and February, and March, April and May, respectively, preceded the present volume by seven years. The charts contained in the third part of this important publication are stated in the preface to have been ready in September, 1899. There are in all twenty-two charts, showing surface temperatures of the ocean water; ocean currents (velocity and direction); pressure; air temperature; winds (by means of wind roses); rainfall (in percentages); the distribution of thunder, fog, hail, cloudiness; the average limits of whales, flying fish, etc.; the sailing routes; percentages of storm frequency, and the trajectories of cyclones.

R. DEC. WARD.

#### THE INTERNATIONAL CATALOGUE OF SCIENTIFIC LITERATURE.\*

At the International Conference which met in London last June to discuss this subject, it was thought that the time had arrived when the great work of publishing a complete catalogue of all the scientific literature of the world might be undertaken with every prospect of success.

A Provisional International Committee was, therefore, appointed at the Conference to carry

\* From *Nature*.

out the preliminary work, and this Committee reported the results of its labors to an International Council which met last week in the rooms of the Royal Society.

At this meeting, which took place on December 12th and 13th, there were present: Professor B. Schwalbe, representing Dr. Milkau (Germany), Professor G. Darboux, representing Professor H. Poincaré, and Dr. J. Deniker (France), Professor A. W. Rücker, Sir M. Foster, Professor H. E. Armstrong and Dr. L. Mond (Great Britain), Professor J. H. Graf (Switzerland), Dr. E. W. Dahlgren (Sweden), Professor Korteweg (Holland), Dr. M. Knudsen (Denmark), Mr. Roland Trimen (Cape Colony), Dr. W. T. Blanford (India), Señor del Paso y Troncoso (Mexico), and M. Metaxas (Greece). Dr. Ludwig Mond represented Italy in the absence of Professor Nasini. Sir Michael Foster was elected chairman of the meeting.

It is proposed that the annual cost of a set of seventeen volumes shall be 17*l.*, and on this basis it was announced that the number of sets subscribed for by the various countries was as follows:

United States of America .....	68
Great Britain .....	45
Germany .....	45
France .....	35
Italy .....	27
Japan .....	15
Switzerland .....	7
Sweden .....	6½
Denmark .....	6
Holland .....	6
Norway .....	5
Mexico .....	5
Cape Colony .....	5
Canada .....	4½
Hungary .....	4
Portugal .....	2
South Australia .....	2
Western Australia .....	1
Victoria .....	1

One great difficulty in starting an enterprise of this magnitude is that a large amount of capital is needed to cover the preliminary expenses and to pay for the printing of the first set of volumes, and for other work which must be done before the grants from the various countries are received, and before any sales of the volumes to the public can be effected. This initial difficulty was met by the Royal Society, which generously offered to advance

the necessary capital. This offer was accepted by the International Council, which expects to be in a position to repay the sum advanced during the next few years.

The Royal Society offered to act as the publishers of the catalogue, and to sign the necessary contracts with the printers and publishing agents. This offer was unanimously accepted by the International Council, which, after carefully examining the clauses of the proposed contracts, declared its approval of them.

The three principal countries which have not yet joined in the scheme are Russia, Belgium and Spain; and the Royal Society was asked by the International Council to address the Imperial Academy of Sciences of St. Petersburg on the subject, and also to take steps to induce the other countries to join in the catalogue.

A code of instructions for the use of all who are taking part in the preparation of the catalogue was considered, and, after some amendment, adopted.

In this connection the chief point discussed was whether it is desirable to publish complete lists of new botanical and zoological species. It was decided that lists of new species should be published, and that they should, as far as possible, contain all the additions to our knowledge in this direction made within the year.

It was also decided to include translations in the catalogue, but to indicate that they are translations. Schedules of classification for the subject indexes of the several sciences were adopted.

An executive committee was appointed, consisting of the four delegates of the Royal Society and the representatives of the four largest subscribers to the catalogue—France, Germany, Italy and the United States. Dr. H. Forster Morley was appointed director of the catalogue.

Finally, it was resolved to begin the work on January 1, 1901, and to include in the catalogue all literature published after that date.

SCIENTIFIC NOTES AND NEWS.

DR. H. C. BUMPUS, professor of comparative anatomy at Brown University and director of the Biological Laboratory of the U. S. Fish Commission at Woods Holl, has been appointed curator of invertebrate zoology and assistant to

the president in the American Museum of Natural History, New York City. The office of assistant to the president, Mr. Morris K. Jesup, is an important executive position, as the Museum has no scientific director. It was created last year and was filled by Professor H. F. Osborn, who has resigned in order to devote himself more exclusively to research in vertebrate paleontology.

A FURTHER reorganization of the staff of the American Museum of Natural History has been made. A department of mineralogy has been formed, with Dr. L. P. Gratacap as curator, while R. P. Whitfield remains curator of geology, with Dr. E. O. Hovey as associate curator. Professor Franz Boas and Dr. Marshall H. Saville have been made curators, the former of ethnology and the latter of Mexican and Central American archeology, though Professor F. W. Putnam retains the head curatorship in the department of anthropology. In the department of mammalogy and ornithology, Mr. Frank M. Chapman has been made associate curator.

At a meeting of the Paris Academy of Sciences on December 17th, announcement was made of the great number of prizes annually awarded. The Janssen gold medal was conferred on Professor E. E. Barnard for his discovery of the fifth satellite of Jupiter, and the Cuvier prize was awarded to Professor Anton von Fritsch, of the University of Prague.

M. PAINLEVÉ has been elected a member of the section of geometry of the Paris Academy of Sciences.

THE Elisha Kent Kane medal of the Geographical Society of Philadelphia, has been presented to Dr. A. Donaldson Smith, the African explorer.

DR. ANITA NEWCOMB MCGEE has resigned her position as acting assistant-surgeon, U. S. A., after having organized 'The Army Nurse Corps.' In accepting the resignation Surgeon-General Sternberg writes:

"I desire to express to you my high appreciation of the valuable services you have rendered during the past two and one-half years in selecting trained female nurses for duty at our field and general hospitals wherever their assistance has been necessary, and

in organizing the 'Army Nurse Corps' upon a satisfactory basis. You have shown excellent judgment and executive ability and have labored zealously both in the interest of the nurses and of the Government."

It is proposed to erect a monument in memory of the late Professor Camara Pestana, who fell a victim to his devotion to scientific research in the recent epidemic of plague at Oporto.

MONEY is being collected for a heroic bust of the late Professor Thomas Egleston, 'Founder of the School of Mines' of Columbia University, in 1864. The work of modeling has been intrusted to the sculptor, William Couper.

THROUGH the courtesy of Mrs. Joseph Leidy, Jr., of Philadelphia, a life-size oil painting of the late Dr. Joseph Leidy, fellow of the College of Physicians, president of the Academy of Natural Sciences and professor of comparative anatomy and biology at the University of Pennsylvania, has been presented to the College of Physicians.

THE death is announced, on December 25th, at Vineland, N. J., of Professor N. B. Webster, founder and for many years head of the Military Institute at Norfolk, Va. He was also a lecturer on scientific and educational topics. Professor Webster was a fellow of the American Association for the Advancement of Science, having been elected a member in 1853 and a fellow in 1874.

LORD WILLIAM GEORGE ARMSTRONG, inventor of the gun that bears his name and of hydraulic machinery, and the author of numerous scientific articles, died on December 27th. He was born in 1810, was elected a fellow of the Royal Society in 1843 and was president of the British Association in 1863. Lord Armstrong was knighted in 1858 and raised to the peerage in 1887.

THE death is announced of Dr. William King, for thirteen years connected with the Geological Survey of India, and for seven years its director.

MICHEL-EDMOND BARON DE SELYS-LONGCHAMPS, an eminent entomologist and a high authority on Odonata, died at Liège on December 11th, in his eighty-seventh year.

SIR JOHN CONROY, F.R.S., formerly lecturer in physics and chemistry in Keble College, Oxford, died at Rome on December 15th.

THE Honorable David Carnegie, assistant resident commissioner for the British Government in West Africa, known for his explorations in Central Australia, has died from a wound made by a poisoned arrow.

THE death is announced of the Portuguese explorer, Major Serpa Pinto, at Lisbon, at the age of fifty-four years. Beginning in 1877, he crossed Africa from Benguela to Durban and published a book on his expedition.

WE regret also to record the following deaths among men of science abroad: Dr. S. J. Korschinski, the botanist, of St. Petersburg; Dr. Richard Altmann, assistant professor of histology in the University of Leipzig; Dr. E. Ketteler, professor of physics in the Münster Academy; Dr. Walter von Funke, formerly professor of agriculture in the University at Breslau, and Dr. Hermann Stechmanns, director of the zoological gardens in Breslau.

THE meeting of naturalists at Chicago during the Christmas holidays was very successful. Besides the discussion on 'State Natural History Surveys: Methods, Results, Cooperation,' in which Professors Birge, Nachtrieb, Smith, Eigenmann, Conway MacMillan, Cowles and others took part, about forty papers were read. A zoological and a botanical section were formed to receive the papers of more special interest. Over one hundred persons were in attendance. There were forty-one at the dinner. No permanent organization was effected. The following were appointed a committee on a meeting for next year: Professor S. A. Forbes, University of Illinois, *President*; Professors D. M. Mottier, University of Indiana; W. A. Lacy, Northwestern University; Conway MacMillan, University of Minnesota, and C. B. Davenport, *Secretary*.

THE Association of American College Physical Directors held its annual meeting at Columbia University, New York, on December 29th and 30th. A number of papers relating to physical training and anthropometry were presented and discussed. Dr. R. Tait Mc-

Kenzie, of McGill University, was elected president for the ensuing year.

THE Duke of the Abruzzi proposes to start from Buenos Ayres in 1902 on a voyage to explore the South Polar Seas. A ship is to be built in Italy for the purpose.

DR. F. A. COOK, who, it will be remembered, was a member of the Belgian South Polar expedition, has sailed for Europe to cooperate in the preparation of the account of the expedition which will be published in ten volumes.

MR. E. B. BALDWIN has purchased for his proposed Arctic expedition the *Esquimaux*, said to be the largest and staunchest of the British whaling fleet.

THE collection of minerals and meteorites, made by Mr. Clarence S. Bement of Philadelphia, has been acquired by the American Museum of Natural History, New York. This is a collection of much importance and will be described in a subsequent issue of this JOURNAL.

DR. EDWARD EVERETT HALE has recently given the Semitic Museum at Harvard University a collection of Egyptian antiquities, consisting of bronze, stone and terra cotta statuettes, vases and lamps, collected by Dr. Hale's brother, Charles Hale, while a United States Consul in Egypt.

MR. THEODORE MARBURG, of Baltimore, a well-known art collector, has presented to Johns Hopkins University a collection of antiquities from the Island of Cyprus.

WE learn from *Nature* that the Botanical Department of the British Museum has recently acquired M. Bescherelle's herbarium of exotic Musci and Hepaticæ, consisting of 14,800 specimens of the former and 3,500 of the latter family. It contains a very large number of type-specimens.

THE sum of 10,000 crowns has been given by the King of Sweden and Norway to assist the archeological researches of Dr. L. Kjellberg in Asia Minor and the island of Lesbos.

SENATOR HANSBROUGH introduced on January 4th a bill creating a department of education, the head of which is to have a place in the cabinet.

THE daily papers report that Governor-Gen-

eral Wood has, in view of the probability that mosquitoes are concerned in the spread of yellow fever, issued orders for the use of mosquito netting in barracks and hospitals and on the field where possible, for the use of petroleum on temporary pools and for filling up permanent pools.

THE *British Medical Journal* reports that Professor Celli, who is a member of the Italian Parliament, will introduce drastic measures for the suppression of malaria in Italy. He would make punishable by law the neglect of landowners and all employers of labor to provide in malarial districts every means of fighting the fever. Bosselli and Sonnino have proposed that the Minister of Finance purchase pure quinine and sell it to the public at a slight advance over cost. The profit could be applied to the extermination of malaria.

#### UNIVERSITY AND EDUCATIONAL NEWS.

AN influential meeting was held at San Francisco, on December 22d, to advocate the passage of an inheritance tax law in aid of the State University.

THE late Chief Justice Faircloth, of North Carolina, bequeathed \$20,000 to the Baptist Female University of Raleigh.

WE regret to learn that the will of the late George V. Clayton, giving about two and a-half million dollars to the city of Denver for the establishment of a college for poor boys, is being contested by a brother.

THE great Hydraulic Laboratory of Cornell University is nearing completion and will be ready for work early in the spring. In its incomplete condition it has been used for experiments in connection with U. S. Deep Water Ways Commission, also in experiments for the New York State Canals. Investigations have also been made in reference to the water supplies of the City of New York and for the Lake Superior Power Company. Corporations and individuals wishing to make investigations for the benefit of Hydraulic Science or Public Improvements are invited to communicate with the Director of the College of Civil Engineering of Cornell University, Ithaca, N. Y.

GROUND has been broken for the new Hall of Mechanical Engineering, for Syracuse University, and work is being pushed forward in order that it may be in readiness for occupancy by the spring of the next college year. The building will be of stone, four stories above the basement, 133 feet in length, by 60 feet in depth. Its equipment will be thoroughly modern in every detail.

THE report telegraphed from California to the daily papers that President Benjamin Ide Wheeler would this year succeed President Eliot, of Harvard University, is entirely without foundation.

CHANCELLOR WILLIAM H. PAYNE, PH.D., LL.D., of the University of Nashville, Tenn., has been elected to the professorship of the science and the art of teaching in the University of Michigan, vacant by the death of Dr. B. A. Hinsdale. Dr. Payne was Dr. Hinsdale's predecessor in this chair.

H. WADE HIBBARD, A.B., A.M., M.E., formerly connected with the Rhode Island Locomotive Works, Pennsylvania and Lehigh Valley Railroads, has been elected Professor of Mechanical Engineering of Railways, having for the past two years been assistant professor and Principal of the Railway School of Sibley College, Cornell University. This railway course is the latest addition to the several specialized finishing schools which are available for the 670 students in mechanical engineering now registered at Cornell.

DR. ARTHUR ROBINSON, lecturer on anatomy in the Middlesex Hospital Medical School, has been appointed professor of anatomy in King's College, London, in the vacancy caused by the death of Professor Hughes.

DR. FREDERICK GOLTZ, who has occupied the chair of physiology of the University of Strasbourg for twenty-nine years, has retired.

AT Trinity College, Cambridge, the Coutts-Trotter studentship for the promotion of original research in natural science, especially for physiology and experimental Physics, has been divided between Charles Francis Mott, B.A., and Owen Williams Richardson, B.A., both scholars of the college. The tenure is until September 29, 1902.



# SCIENCE

A WEEKLY JOURNAL DEVOTED TO THE ADVANCEMENT OF SCIENCE, PUBLISHING THE OFFICIAL NOTICES AND PROCEEDINGS OF THE AMERICAN ASSOCIATION FOR THE ADVANCEMENT OF SCIENCE.

EDITORIAL COMMITTEE: S. NEWCOMB, Mathematics; R. S. WOODWARD, Mechanics; E. C. PICKERING Astronomy; T. C. MENDENHALL, Physics; R. H. THURSTON, Engineering; IRA REMSEN, Chemistry; JOSEPH LE CONTE, Geology; W. M. DAVIS, Physiography; HENRY F. OSBORN, Paleontology; W. K. BROOKS, C. HART MERRIAM, Zoology; S. H. SCUDDER, Entomology; C. E. BESSEY, N. L. BRITTON, Botany; C. S. MINOT, Embryology, Histology; H. P. BOWDITCH, Physiology; J. S. BILLINGS, Hygiene; WILLIAM H. WELCH, Pathology; J. MCKEEN CATTELL, Psychology; J. W. POWELL, Anthropology.

FRIDAY, JANUARY 18, 1901.

ANNUAL DISCUSSION BEFORE THE AMERICAN SOCIETY OF NATURALISTS.\*

THE ATTITUDE OF THE STATE TOWARD SCIENTIFIC INVESTIGATION.

## CONTENTS:

<i>Annual Discussion before the American Society of Naturalists:—</i>	
<i>The Attitude of the State toward Scientific Investigation: PROFESSOR HENRY FAIRFIELD OSBORN, PROFESSOR WM. BULLOCK CLARK, DR. L. O. HOWARD, DR. B. T. GALLOWAY, PROFESSOR WILLIAM T. SEDGWICK.....</i>	81
<i>The Albany Meeting of the Geological Society of America (I.): PROFESSOR J. F. KEMP.....</i>	95
<i>The American Physical Society: PROFESSOR WILLIAM HALLOCK.....</i>	101
<i>The American Mathematical Society: PROFESSOR F. N. COLE.....</i>	102
<i>The American Chemical Society: DR. ALBERT C. HALE.....</i>	104
<i>Scientific Books:—</i>	
<i>Sclater on the Mammals of South Africa: J. A. A. Report of the U. S. Commissioner of Fish and Fisheries: M. C. MARSH. Photography in Colors: R. W. W. Books Received.....</i>	105
<i>Scientific Journals and Articles.....</i>	110
<i>Societies and Academies:—</i>	
<i>Zoological Club of the University of Chicago: DR. C. M. CHILD.....</i>	112
<i>Discussion and Correspondence:—</i>	
<i>The U. S. Naval Observatory: M. Reproduction of Diffraction Gratings: DR. ELIHU THOMSON.....</i>	113
<i>The Frictional Effect of Railway Trains on the Air: R. H. T.....</i>	115
<i>Trivalent Carbons: W. A. N.....</i>	116
<i>Columbia University.....</i>	116
<i>Report on a Western Branch of the American Society of Naturalists.....</i>	117
<i>Scientific Notes and News.....</i>	117
<i>University and Educational News.....</i>	120

A FAIR criterion of intelligence in the government of a country is afforded by an examination of its annual budget. There is first the provision for a certain number of expenditures which are purely conservative, because the State must maintain itself, it must defend itself, it must support a large class of office holders who are more or less useful. Without knowing the figures it is safe to say that the budget of Russia is chiefly of this order. These expenditures may be wisely and honestly made, but they largely go to waste; they are either immediately productive or altogether non-productive. On the other hand, there are expenditures in the nature of investments, looking to the future and characterizing the most far-sighted statesmanship. Conspicuous among these are the funds invested in education and science.

Said Helmholtz in 1862\*: "In fact men of science form, as it were, an organized army, laboring on behalf of the whole nation, and generally under its direction and

\* Given at the Baltimore Meeting, 1900.

† 'On the Relation of Natural Science to General Science' (Heidelberg, 1862), 'Popular Lectures on Scientific Subjects' by H. Helmholtz. New York, D. Appleton & Co. 1873. Pp. 28-30.

MSS. intended for publication and books, etc., intended for review should be sent to the responsible editor, Professor J. McKeen Cattell, Garrison-on-Hudson, N. Y.

at its expense, to augment the stock of such knowledge as may serve to promote industrial enterprise, to increase wealth, to adorn life, to improve political and social relations and to further the moral development of individual citizens. After the immediate practical results of their work we forbear to inquire; that we leave to the uninstructed. We are convinced that whatever contributes to the knowledge of the forces of nature or the powers of the human mind is worth cherishing, and may, in its own due time, bear practical fruit, very often where we should least have expected it." Helmholtz in this most influential essay enforces his point by citing Galvani and Galileo and continues: "Whoever, in the pursuit of science, seeks after immediate practical utility may generally rest assured that he will seek in vain. All that science can achieve is a perfect knowledge and a perfect understanding of the action of natural and moral forces. \* \* \* At the same time we must acknowledge that the value of scientific discoveries is now far more fully recognized than formerly by public opinion, and that instances of the authors of great advances in science starving in obscurity have become rarer and rarer. On the contrary, the government and peoples of Europe have, as a rule, admitted it to be their duty to recompense distinguished achievements in science by appropriate appointments or special rewards."

Upon the general contention of Helmholtz as to the ultimate practical importance of pure scientific work, Dr. Galloway will speak from the standpoint of botany and Dr. Howard from the standpoint of applied entomology.

Of European countries Germany places in its budget the largest productive investments of this kind; France is not far behind, England is perhaps fourth and affords a conspicuous example of blindness and fatuity in the matter of unproductive invest-

ment; she has, it is true, established textile schools, but has not sufficiently supported technical schools; the cost of a single battleship would establish four splendidly equipped technical schools; England secures the ship and postpones the construction of the schools. All this is through no fault of her prophets of science, who have been as persistent as Jeremiah in foretelling the consequences which are sure to follow.

Yet England gave Darwin his schooling upon the *Beagle*; Huxley secured his upon the *Rattlesnake*. As a sea-faring nation marine zoology appeals to her imagination, and the single notable departure from her short-sighted policy in the encouragement of pure science is the magnificent service she has rendered in the *Challenger* expedition. Our own Dana was trained upon the Wilkes expedition; the French Government equipped the *Talisman*; the German government is supporting the highly successful cruise of the *Valdivia* and its publications under Chun; the U. S. Government has a permanent exploring vessel in the *Albatross*.

In this rivalry of foresightedness the German and French governments have been our keenest competitors both on sea and land, and have probably surpassed us in the recognition of the ultimate economy of pure research. In Germany, quite apart from the extension of the technical school system which to-day is placing her in the lead of all the manufacturing states of Europe, one recalls the annual grant to the Naples Zoological Station. Her most admirable recent action is the subvention of Professor Abbe for his investigations upon optics. Abbe's work was not in the nature of invention, but of research and discovery in the highest sense resulting in the production of an illuminating stage, apochromatic and achromatic immersion lenses, which have fairly revolutionized biology. What we owe to these lenses in a theoretical sense could not be stated in a single

volume and the economic value is equally immeasurable.

The distinctive feature of pure science is that it is not remunerative; the practical rewards and returns are not the immediate objects in view. On the other hand, the work of Tyndall and Pasteur on fermentation, pursued in the first instance for its own sake, has come to have an economic importance which is simply incalculable.

American legislators have lent a willing ear to the advice of wise men. What we now enjoy we owe mainly to the counsels of Joseph Henry, Spencer F. Baird and G. Brown Goode. And I may call attention here to a thought which will be expanded presently, namely, that the secret of the success of these men is to be found in their enthusiasm, unselfishness and lofty scientific and personal character. When we consider the liberal appropriations made year after year for the United States Geological Survey, the nobly equipped station at Wood's Holl, the purely scientific work which is now being supported by many States and municipalities, there is abundant cause for congratulation; but lest we think of ourselves more highly than we ought to think, let us recall the contrast between our lavish liberality in certain appropriations and our lack of enlightenment in certain details of legislation. The student steps in line with the farmer to support the manufacturer; he is encouraged to work, he is denied the tools. In regard to the importation of models, microscopes and other scientific instruments the tariff is a tax which bears most heavily upon research. By the tariff on lithographic plates Congress places a Chinese wall around publications of the first class in all branches of natural history. America is a most unfavorable center of scientific publication so far as illustrations are concerned. Professor Sedgwick will perhaps have something to say upon these subjects.

In these matters the American Society of Naturalists has expressed and will continue to express its urgent desire for reforms which will come about through public enlightenment.

The main object of this discussion, however, is not merely a reiteration of opinions which we all share, but a symposium in regard to some of the new directions in which we must apply our energies in order to secure ultimately the best results.

In the last analysis we are *advocating public taxation* for the purposes of research. Having considered the parental relation of the State to the investigator—what are the filial relations of the investigator to the State. Granting that we have carried the outer works by demonstrating the wisdom of taxation, felicitating ourselves upon the fact that we have an enlightened public opinion behind us, there now remains the honorable obligation on our part of administering these funds to the very best service of the State, and it is to this obligation I wish to especially direct your attention. There are two directions in which it is possible that we have not as yet fulfilled our duty.

I believe with Huxley that good science rests upon good morals and that good morals rest upon those principles which are best enunciated for plain people in the ten commandments. In the special field of work under discussion, it seems to me that in return for the confidence of the State, specialists are under the binding obligation to administer public funds in the most scrupulous manner. I have in mind instances where the confidence of the State has been betrayed and where results damaging to the general cause of science have inevitably followed. Extravagance in the use of words and parsimony in the use of ideas; the lavish illustration of papers of little scientific and of less literary value; the reckless expenditure of public funds for instruments, apparatus,

and general equipment that anticipate imaginary rather than real needs; the diversion of these funds to purposes for which they were never intended; the surreptitious introduction of material not mentioned in the original purpose of an appropriation; in short, the obtaining of money under false pretenses; these are immoralities which retard the development and jeopardize the existence of the grand system which our state and national governments have so wisely instituted.

A second consideration is the importance of cooperation between nation, state, and university in education and organization for research. A conspicuous example of the splendid results which may flow from such cooperation is found in the present administration of the United States Geological Survey. We see the Government cooperating with the states and with the universities and public museums to produce a uniform investigation of the geology and paleontology of the entire area of the United States. Of this Professor Clark is far better qualified to speak than I am.

In the foundation of the United States Fish Commission Station at Wood's Holl, Spencer F. Baird, one of the most large-minded men this country has produced, formed a similar conception of the advantages of cooperation in biology, which alone justifies the erection of an enduring monument to his memory. While the execution of his purpose may be described as having ebbed and flowed like the tides, strong under some administrations, such as Goode's, and not even as yet fully attained, we have in the last few years seen an approach to the fulfilment of Baird's ideal, and it remains for the United States Fish Commissioner and his staff, and the Director and Trustees of the Marine Biological Laboratory at Wood's Holl, to consider a plan of cooperation which will effectively combine the intellectual and material forces of these two

institutions in the future. No private institution can compete with the material resources of the government; no government institution can flourish without availing itself of the intellectual resources of the university. The cooperative advantages which the Marine Biological Laboratory should enjoy as the premier institution of its kind in this country should be extended to other laboratories along the coast. The difficulties in the way of bringing about such cooperation are more apparent than real, in fact, I am one of those who have firm faith that the ideal is also the practical and that we shall see Baird's plans fulfilled in the case of biology, even as Hayden's plans have been fulfilled in the case of geology.

If the larger scientific interests of the country are one, and if the Utopian state is one in which there is a sympathetic nervous system connecting state and university work, it is obvious that our colleges and universities should consider more carefully than they have done the preparation of men especially for state work. Educators have perhaps had too exclusively in mind the medical school, the teaching profession, and too little the direct service of the state. This is a feature of the general subject which will be especially spoken of by Dr. Howard who is well qualified by his knowledge to discuss present conditions in state and college and the present needs of government science.

College and university men of science, and state and government men of science, naturally acquire certain individual characteristics; they have their strong points and their weak points, and it is of advantage to American science at large that these two classes of men in all departments of science, in physics, chemistry, geology, botany, zoology, should abrade their angles by coming into frequent contact; because contact not only removes prejudices, but it increases mutual respect and admiration,

until an entire unity of purpose and action is consummated which completes the scientific structure of the nation.

HENRY FAIRFIELD OSBORN.

COLUMBIA UNIVERSITY.

The attitude of the state toward scientific investigation is less a question of inherent right than of expediency. Political economy assigns no sharp limitations to the functions of government and whether or not any particular interest should receive the fostering care of the state depends upon circumstances. That scientific research is a subject of government concern is becoming recognized more fully every year. A well-known English educator in discussing the endowment of research by the state says: 'that liberal and scientific culture, intelligence, and the whole domain of mind, is a national interest, as much as agriculture, commerce, banking or water-supply.'

Granting all this, and I am sure no one here maintains any other view, we are confronted with the fact that the state cannot support, or even subsidize, every national interest. Which should receive government support must finally be determined by expediency—by whether in the long run the state is to be benefited by the aid extended.

Agriculture, commerce and banking, for example, can be maintained by private enterprise and can be made largely or wholly self-supporting. Their prosecution can be left therefore largely to the individual, with such incidental protection as may be required in the particular case. Scientific investigation is not and cannot hope to be self-supporting in most instances. This I believe to be the determining factor. Admitting the material value of scientific investigation to the state, it becomes necessary for the state to see that its interests are secured.

It may perhaps be desirable to examine for a moment the reason why scientific in-

vestigation is not and can not be self-supporting. This may be found in the fact that the great majority of scientific researches have no immediate commercial value and as commodities can not find a speedy or, in most instances probably, even a prospective market. We all know of many investigations, begun without thought of pecuniary advantage, that have ultimately produced practical results of the greatest importance. Instances might be cited of investigations, the value of which were not apparent until a generation or more had passed, as, for example, paleontological researches which have laid the foundation for the correlation of deposits of great economic value. The support of such investigations must, as Professor Osborn has shown, be looked upon as investments for the state which no far-sighted statesman will ignore.

I have found, although my own experience has been limited to be sure, that the average legislator, who is considering honestly the interests of the state, is not without appreciation of the far-reaching value of scientific work, if convinced that the investigations proposed will be honestly conducted. The legislator, surrounded, as he too frequently is, by evidences of political jobbery of every sort, is very keen in detecting what is false and untrue. He may be over-suspicious in some instances and may even suggest that you have some ax to grind in the measure which you bring forward, but if he is honest in purpose his support in the end is not difficult to obtain. I have always gone on the principle that the legislator whose support I was seeking was a public-spirited and intelligent citizen who was capable of judging of the true merits of the subject under consideration. I have never claimed for the investigation proposed that it would in every instance bring an immediate financial return, but rather that the work laid the foundation for subsequent re-

searches, the material value of which could not be estimated. In stating the objects of the Maryland Geological Survey in the opening chapter of the first volume of its reports I said: "The fact must be borne in mind that much preliminary and fundamental work has to be done, the utility of which is not at once apparent to the uninitiated. The publication of such material, rendered necessary as a basis for future investigation, is often liable to misinterpretation, but yet may be of far more lasting value to the State than some superficial statement that is intended to meet a supposed practical need." I believe it is not difficult for the scientific man, with a subject of real merit, to secure the confidence and support of any body of legislators, if he approaches them with honesty of purpose, and with his plan sufficiently matured for them to see its real significance.

We find that ever since the establishment of universities and seminaries widely over Europe in the fourteenth and fifteenth centuries, the civilized countries of the world have recognized in one form or another the relation of the state to scientific investigation. Not only the great nations of the world but oftentimes the small and relatively poor countries like Belgium and Switzerland, as well as the smallest of our own commonwealths, have frequently provided liberally for the support of scientific research. This has been accomplished through the publicly endowed educational institutions, through the public museums and through the special bureaus of the government. The dependence of these various public organizations, as well as the privately endowed institutions upon one another in scientific investigation, has been already pointed out by Professor Osborn, and I shall presently refer to a concrete instance of this in my own work.

Too frequently scientific investigation has held a subordinate place in both the pub-

licly and privately endowed institutions, their chief functions being either educational or commercial. The purpose of the schools and universities is primarily in most instances the instructing of youth in the already acquired results of scientific research rather than the fostering of investigation for itself, although the latter as a secondary consideration often holds a prominent place in the larger institutions of learning. The museums and scientific bureaus are like our great universities centers of research, without the exactions of teaching, where continuous investigation can be pursued under most favorable conditions, although here again either educational or commercial considerations for the most part ostensibly control. That this is not always the case either in our own country or abroad is cause for congratulation, and the support of research directly for itself without other, and oftentimes false, claims is becoming yearly a more fully recognized fact.

It is interesting for us who are Americans to know that the claims of science received recognition at the very inception of our government, for we find that George Washington in his first message to Congress stated: "Nor am I less persuaded that you will agree with me in opinion that there is nothing more deserving your patronage than the promotion of science and literature. Knowledge in every country is the surest basis of public happiness. In one in which the measures of government receive their impressions so immediately from the sense of the community as ours it is proportionally essential." How well that early advice has been carried out by the statesmen of later days under the wise counsels of Henry, Baird, Goode and their successors, Professor Osborn has already shown.

That much can be accomplished through cooperation between our national bureaus and the State and university institutions, I

have had occasion to know in the conduct of the State Geological Survey of Maryland, the resources of several of the national bureaus, as well as the State and university institutions being at my disposal in the advancement of the work. Any single one of these agencies, if alone employed, could not readily have accomplished the same results. This is shown by the scope of the work which the local scientific bureau in most of our smaller States must necessarily embrace. Its investigations cannot be as fully differentiated as is possible in the case of the national bureaus, except by largely increased expenditure, seldom provided even by our richest States, and whether the organization is known as a geological survey or by some other name, it must naturally deal with the whole realm of the physical features of the commonwealth. It need not, however, encroach upon the functions of other departments of the government and more particularly of its nearest associates, the more strictly agricultural institutions, but should, by the classification and mapping of the soils which depend primarily on geological criteria, afford the foundation for agricultural work. But in this as well as in the topographic, hydrographic, magnetic, climatic and forestry work, the relations of all of which to geology are more or less intimate, the aid of the national bureaus is essential, while the State bureau can be the medium by which the results may be presented to the local communities in a manner that would be difficult if not impossible for any institution of the central government. Each has a well-defined field of action and instead of conflicting can be of material advantage to the other.

The same is true of the university and in even larger degree, for here are trained the specialists, who either in State or in national work can add much to the effectiveness of both, while the opportunities afforded by the latter for wider experience react on the

university in many ways. The advantages offered the university instructor and student by cooperation in government explorations and surveys are only part of the increased opportunities which can result from this relationship. The various bureaus and divisions of the U. S. Department of Agriculture, the U. S. Geological Survey and the U. S. Coast and Geodetic Survey are all manifesting a broad spirit of helpfulness that is being met by the state and university institutions. The possibilities of an extension of this cooperation between nation, state and university promise well for the widening of the bounds of scientific investigation in this country. It is indeed a hopeful sign when we see the scientific men of the nation, whatever their affiliations, working together with mutual interest and respect. May it pre-empt the dawn of a still brighter day in American science.

WM. BULLOCK CLARK,  
JOHNS HOPKINS UNIVERSITY.

THE State and scientific research cover an enormous field—as broad as scientific research and as broad as government possibilities. The men who have spoken and are still to speak are specialists. They can speak theoretically of other matters, but more authoritatively of their own field. I am a specialist and shall therefore limit myself to ‘the State and zoology.’ By ‘the State’ I shall refer only to the general government.

In opening this discussion, Professor Osborn indicated two points upon which he expected me to speak. The one was the ultimate practical importance of pure scientific work from the standpoint of applied entomology, and the other was the preparation of men by our colleges and universities especially for State work. In regard to the first topic, the case is so self-evident as to require little elaboration. It is upon work in pure science that the entire superstruc-

ture of economic entomology has been built, and workers in applied science are constantly making use of the results of the labors of workers in pure science. The practical outcome, however, of the labors of the workers in pure science is indirect, while the practical outcome of those who work in the economic applications of science is direct. In any emergency the direct method is the one which is immediately productive of practical results. The study of economic entomology is a study of facts which will enable us to meet one great and widely extended emergency. It must be conducted by the direct method, and the reason why this country stands in advance of the rest of the world in this application of science is because we are a practical people and have adopted the direct method. There can be no doubt, however, that it is necessary for the most successful economic worker to have had a sound training in pure science.

This leads us naturally to the second point—the preparation of men by universities especially for State work. The first training should be, as just stated, a broad one in pure science, but the practical applications should follow with as rigid a course of instruction as can be given. University teachers should make a study of the markets for the brains and training of their students. They should study the conditions of those markets, and their needs. This is self-evident. But where is there a college professor who has made a careful study of the practical scientific needs of the Government? Some years ago the President of Vassar College visited in Washington during the Easter vacation. He spent his days visiting the scientific branches of the Government service. He spent his evenings at the Cosmos Club talking with the heads of those bureaus. He went home and arranged a course of lectures on the scientific work of the Government to be delivered

for the most part by the men actually at the head of these branches of work. His aim was simply one of broad education, and I doubt whether he had any practical point in mind for the future of his students beyond the acquisition of general knowledge, but you will readily see that this idea might be used in a most practical way.

Men in charge of university departments of scientific work should keep closely in touch with the Government work along similar lines. They should be encouraged to do this by the Government. Government should employ their services wherever they can be of use, and such cases are numerous. They themselves should be able, with the intimate knowledge acquired by official association or by close investigation of Government work, to lay out lines of study which will fit their students to take a hand in Government work. In many cases, of course, this cannot be thoroughly done in university laboratories at the present time. Very few college graduates can pass the special examinations for certain scientific positions under the Government without training which they have secured outside of the colleges. A study of such conditions will show just how this is to be done, and universities will find it to their advantage to increase their facilities for instruction in such directions, and certainly it will be to the advantage of the Government scientific work. This is by no means a new idea. Several practical college men have been asking this question of men in charge of Government bureaus and only recently the newly elected President of the Massachusetts Institute of Technology, who went there direct from a Government bureau, sent out a circular letter asking Government officials how he can best train men in Boston for other branches of Government scientific work than that of which he was in charge.

What does government do for zoology,



and what ought it to do? If it does not do as it ought, why does it not do so?

Aside from the meager sums which the State experiment stations supported by the Government allot to animal industry and to economic entomology, the zoological activities of this Government center at Washington. There are three institutions which do zoological work for the government. The Smithsonian Institution, with its National Museum and National Zoological Park branches, is the only one of the three which cares for pure zoological science. The U. S. Department of Agriculture, with its Bureau of Animal Industry, its Biological Survey, and its entomological service, is wholly economic in the aims of its zoological scientific work. The third of these institutions, the U. S. Commission of Fish and Fisheries, was also established by the Government for a purely economic purpose.

It is not my intention to dwell at any length upon the relative merits of economic and pure scientific work. I have a strong conviction that humanity gains far more from scientific work undertaken with an economic aim than from the labors of the other class of scientific men, and I believe it to be a most unfortunate condition of affairs that hundreds of the men, best fitted by brains and training to attack the many economic problems which are fairly crying for solution, are delving away in their search for truths and principles which when found have only a remote bearing, if any at all, upon the sum total of human happiness. I was once filled with the resounding majesty of the phrase 'science for science's sake,' but now, while I admit the grandeur of the idea, I have come to parallel it and its opposite in my mind with the contrast between abstract and practical Christianity—both beautiful, but one for gods and the other for men.

Now what is Government doing for these

three scientific institutions at Washington?

The Smithsonian Institution receives each year \$246,540, for the National Museum, and \$75,000, for the National Zoological Park. The National Museum employs 33 scientific men, and the National Zoological Park, 2. All are pitifully underpaid. The amounts spent on purchase of collections have been extremely small. Neither the Museum nor the Park has a responsible head in the proper sense of the term. The Secretary of the Smithsonian Institution supervises the work of both branches and alone asks Congress for their appropriations. The personnel of the scientific force of the Museum is admirable in quality but absurdly insufficient in quantity. Not a scientific man on the force has the proper facilities for work. The collections are large but they are one-sided and there is little money to supply the deficiency. Underpaid, with few facilities, grievously dissatisfied with conditions, nothing but the rare enthusiasm which scientific work inspires keeps these able men at their labors. The National Museum needs a new building planned for all time to come. It needs now an annual appropriation of double the present size. As soon as the beginning of a new building is made it will need an appropriation of ten times its present size. Think of what the words *United States National Museum* should mean and then think how the present institution fits the name! Government has not given a proper amount of money and Government shows faint signs of ever giving it. Why? Because Congress has not been made to see the importance of the subject; because Congress has not been asked for the money with sufficient force and with sufficient argument. The Board of Regents of the Smithsonian Institution might make this request and back it with all the weight of the illustrious names of the men who compose that body. The Secretary of the Smithsonian Institution

might make this request and urge it strenuously and incessantly and with an ability which few other men possess. The scientific men of the country might urge it. Organizations of many different characters might petition Congress for it. But the men who best know the truth about the present conditions, the scientific employees of the National Museum, may say no word.

The National Zoological Park is naturally by no means as important an institution as the National Museum, since it is concerned with but one branch of science, but it falls as far short of what it should be as does the National Museum, and for the same reasons. Double the means and a force of zoologists are its important needs. This institution should naturally be a branch of the National Museum, but the National Museum as it should be and as it will be is too great a branch of Government to be controlled by the Smithsonian Institution. It should have its independent organization; it should have its responsible director who will spend his winter days laboring with Congress for appropriations and his nights planning broad lines of development. The Smithsonian Institution has done a great and good work, but it should not be given control of great national institutions like the ideal national museum. Infinitely better would it be were the Smithsonian Institution attached to the National Museum as one of its component parts. The Smithsonian has played its rôle with the Museum. It officiated at its birth and nursed it through its childhood; but the youth is now cramped. It must grow. It must burst the Smithsonian cage and stretch out its own appealing hands directly to Congress.

The U. S. Department of Agriculture is the first of the Government bureaus which does economic zoological work. Here as in the National Museum the men are underpaid, but the facilities for work are vastly

better. Government appreciates more readily work which promises immediate economic results and hence money for such work is more easily gained. Scientific men in the Department of Agriculture refuse positions offered elsewhere at higher salaries, on account of these better facilities. Good research work and initiative in investigation are encouraged. Nothing could be more ideally perfect than the relation between the present head of the Department of Agriculture and his scientific corps. Four years ago he announced his policy in this regard in conversation with one of his scientific chiefs in the following words: "I am here to facilitate your work, not to dictate to you. Make your plans, conduct your investigations, and I will help you with all my strength, but I shall hold you responsible for results." Scientific men should honor James Wilson for the introduction of this novel principle in the administration of a Government scientific bureau. The good, sound, progressive scientific work now being done by his corps is everywhere commended, and I am proud to be connected with such an organization. New laboratory buildings are needed here, but there is no fear that they will not come in the immediate future.

The U. S. Commission of Fish and Fisheries deals with a single aspect of zoology and with a single industry. Just why scientific men are chosen as the administrative heads of the U. S. Geological Survey and the U. S. Coast and Geodetic Survey and not, since the days of Baird, for the Fish Commission is one of the mysteries of Government. Nearly four years ago this Society did the creditable thing in passing resolutions and sending them to Washington in the hands of Professor Osborn, protesting against the appointment of any other than a scientific man as the director of this important branch of applied scientific work. The present incumbent of the

office is a good official and no personal objections are to be raised against him. The principle, however, is not a good one, and the next appointee to this office should be a man who combines scientific attainments with administrative ability. The old popular idea of a scientific man—that he lacks what is called 'common sense,' that he is impractical—is an unfortunate estimate gained from unappreciative observation of workers in pure science, but it no longer holds. Henry, Agassiz, Baird—all men of affairs, now gone, did much to change this popular estimate, and the host of brilliant men who have succeeded them—men of high scientific rank, who control the destinies and shape the policies of great institutions, and who turn out work of great and important practical value, have demonstrated beyond the slightest doubt that scientific men are the broadest men of affairs, that they are practical men, and that they are fit to be leaders not only in thought but in action.

It is doubtful whether any government in existence does as much for the encouragement and development of science as does our own. This has repaid her a thousand fold, and the sound judgment of the American people and their patriotic pride in national attainment will effect a steady increase in governmental support of scientific work in spite of temporary checks. With scientific men, however, must come the initiative. They must point out the needs and the ways and means by which these needs must be supplied. This fact is the justification of this discussion.

L. O. HOWARD.

U. S. DEPARTMENT OF AGRICULTURE.

Is it not true that the attitude of the State toward science and scientific research is at all times greatly influenced by the shaping of public sentiment through the work of scientific men themselves? This

is a practical age, and in America especially the tendency is more and more to give a practical trend to almost every line of research. We find, therefore, as a matter of fact, that there is a general lack of interest in, and support of, matters having to do with pure science alone, while on the other hand all questions having practical application, and even those in which the practical end is remote are received with commendable liberality. Taking the field of botany, for example, it would be difficult, if not impracticable, to secure support for the preparation and publication of purely floristic monographs, unless it could be pretty clearly shown that such a project had some practical end in view.

In so far, therefore, as the attitude of the State toward all work of this nature is concerned, there is a great deal of conservatism to be overcome, and this conservatism is especially pronounced where pure science is brought strongly to the front. The reason for this is not far to seek, for its roots lie imbedded in the selfishness of human nature, which, acting through organization in the shape of government, sees, or thinks it sees, in the aggressiveness of science a menace to existing institutions in some form or other. While science in its nature is aggressive, the men who do most to advance it often lack aggressiveness, and for this reason the far-reaching effect of science as an educational factor at the present time is not fully understood or appreciated.

This brings me more particularly to the main question I wish to raise in this discussion, namely, what should be the attitude of the scientific man toward the cause he represents. I am strongly of the opinion that he owes it to himself and to his work to put forth every legitimate effort to advance the interests of the cause. He should of course keep constantly before him the fact that to bring honor and credit to the

work he must recognize the duties of life which Professor Osborn has already pointed out. This will not allow him, however, to sit calmly down and wait for the material things of the world to come to him. The men who have it in their power to aid him are too busy to go out of their way to render help unless that help is sought. There exists a mistaken idea that because one is engaged in or may be directing scientific work he is the one to be sought. We see this idea shaping the policy followed in some of our important institutions, as already pointed out by Dr. Howard, and as a result they are being outstripped in every way by others which have a better appreciation of what is necessary to influence public sentiment. After all, the public and those who represent the public look at this matter in its true light, for they have been educated to expect those who are responsible for important lines of work to make their needs plainly understood.

With the distinctly utilitarian sentiment toward science, as pointed out, the question arises as to what stand should be taken by those charged with the guidance of the work with respect to shaping a general policy which will meet the demand for practical ends, and at the same time advance the cause of science to the fullest extent. Extremes must be avoided, for if the tendency is too strong toward pure science, opportunities will be lost through lack of support, and if toward ultra-utilitarianism, science itself will be endangered through the development of false views, erroneous statements and lack of judgment—rocks and reefs that must by all means be avoided. There is always a medium ground, however, where science and practice can each be made to help the other and each be the stronger for the support thus gained. This is the stand, I may say, that is now taken by those charged with most of the work conducted under the auspices of the Government, and

which, during the past fifteen years at least, has resulted in a rapid development of all work along broad and safe lines. Most of the departments of the Government, wherein scientific work is carried on, owe their existence to a demand for greater knowledge on problems concerning the interests and welfare of the people. In the early days of this work too much attention was given to a mere diffusion of knowledge without regard to its source, and as a result of this original research did not receive the attention it deserved. In later years, however, the importance of research is becoming more and more appreciated, and as a result the work has increased in strength and now commands the respect it deserves. It is unnecessary to dwell upon any specific work now being done by the Government, as the object of this discussion, as I understand it, is more to deal with general matters, and certain of the details have already been given by Dr. Howard. I will conclude what I have to say with just one statement, namely, that the future attitude of the State toward scientific research will in large measure depend on our own efforts individually and collectively. Let us therefore go forth with a determination to advance the cause of science in every way and to stand firmly for the great principles of truth it represents.

B. T. GALLOWAY.

U. S. DEPARTMENT OF AGRICULTURE.

IN considering the attitude of the State toward scientific investigation it may be well to remember that with us the State is the people, ours being a government of the people, by the people, for the people. What then is and what should be the attitude of the people toward scientific investigation? Probably very much the same as their attitude toward education, and concerning this there can be no question. From the very beginning our people made careful provision for education by the establishment of public

schools. They have asked, and answered emphatically in the affirmative, the question: Does education pay; and I believe that they are asking and answering the other question, Does scientific investigation pay, very much in the same fashion. The golden stream of benefactions which has now for many years been flowing in upon educational establishments proves that the people firmly believe that education pays. They believe in education.

I have been very much interested to hear the quotation from the 'Message of Washington' urging upon our people the importance of promoting scientific investigation and research. I believe that the American people are, in increasing numbers, large-minded enough to look through and beyond the nearer every-day phenomena and to realize that the promotion of discovery, no less than the promotion of learning, pays in every sense of the word. They perceive that it pays in the highest sense, in the enrichment of intellect and the cultivation of faculty. They perceive also that it pays in the utilitarian sense, in that it gives leadership among the nations of the earth in the applications of science which always follow hard upon the heels of discovery. Professor Osborn has done well to point out that those nations which support research most liberally are those which are taking the lead in the industrial world to-day.

I remember a saying of General Walker's, that he firmly believed that we should outgrow the necessity of protection, and we are beginning to-day to witness the fulfilment of his prediction. The enormous development of our export trade, based upon our scientific and economic system of manufactures, arts and industries, marks that over-growth of the merely home market and local protection which General Walker was far-sighted enough to foresee. I believe that, if once the people realize what a burden and a hindrance is inflicted upon

scientific research, and thereby upon educational and industrial progress, by the tariff upon microscopes, dissecting instruments, models, diagrams and other apparatus of research and instruction, that tariff will melt away like dew before the sun.

And so it is also, I believe, with the relations between pure and applied science. The barrier between them is fading away, because they are constantly drawing nearer together and over-growing one another. Pure science has given to applied science the fundamental elements of truth, perfection, knowledge and skill. Applied science, on the other hand, has developed so prodigiously as to react favorably upon pure science, furnishing for it rich sustenance and fertile soil in which it may flourish. An hour might well be spent in pointing out not only the aid which pure science has given to applied science, but reciprocally the enormous development of pure science and scientific investigation wrought by applied science. It is one of the marvels of the day that many highly organized and differentiated industries, and even many of the coarser arts, find their narrow but sufficient basis of profit in the employment of the results of latest and most advanced researches in pure science.

Our age has been called by one of the speakers who has preceded me, a practical age, and so it is; but it is an age which has discovered in science the Promethean fire. The highest and truest utilitarianism of to-day is a generous cultivation of scientific investigation, not indeed for its own sake, but for the sake of the results which are sure to follow from it. As to the pursuit of science for its own sake, Professor Osborn has, it seems to me, used a happy illustration in referring to the scientific investigations of the Government as an investment rather than an immediate outlay for current expenses. As to pure science pursued strictly for its own sake, I think we may

rather describe it as an investment from which we still expect ultimately some return. Science for its own sake is, after all, much like investment for its own sake; which has never been made, I fancy, even by the least practical of philanthropists.

For illustration of public appreciation of scientific research as a necessity for practical results, I may give an example. When in 1886 the newly organized State Board of Health of Massachusetts attacked scientifically the problem of protection of the purity of inland waters, they reported to the people of that State that in order to do the work required by the Legislature it would be necessary to inaugurate and prosecute special and novel investigations, and for this and other purposes they asked for an appropriation of \$30,000. This sum was immediately and cheerfully granted by the people for this purpose and has ever since been continued, annually, with the result that the Massachusetts experiments are referred to with commendation and advantage by bacteriologists and engineers all over the world. Again, when it became clear that antitoxin for diphtheria had become a public necessity and its proper preparation a public duty, the same State Board of Health secured the services of one of the most distinguished bacteriologists in the country, Professor Theobald Smith, and requested him not only to prepare antitoxin for the citizens of the State, but also to investigate the best methods of its preparation and preservation, besides other cognate and novel but pressing problems in the field of pure science. Here also the most thorough-going utilitarianism has proved to be scientific investigation pushed to its utmost limits.

Just here also the State, by and for the people, might well do much more than is yet done. As a nation we have hitherto played but an insignificant part in those scientific inquiries which underlie the medical and sanitary arts. As a nation we

cannot claim any of the credit for originating the germ theory, or antiseptic surgery, or for laying the foundations of modern bacteriology, or for the discovery of antitoxins or for elucidating the ætiology of malaria, or for inventing the agglutination test for typhoid fever. We may be excused for our inertness previous to 1870, because until then the civil war or its sequelæ claimed all our energies; but from comparative inactivity in these matters since that time—excepting in one honorable division of the government service, the agricultural,—we have no good excuse to offer. If we are to hold our proper place among the nations in the prosecution of medical and sanitary inquiry the State or the States must lend their powerful aid, or else private enterprise or the universities must do far more than they have yet done in this direction.

In this connection, and especially on this platform, it will not be out of place for me to refer to the intense satisfaction which all lovers of good government and of the intelligent and scientific administration of public affairs feel, that Dr. Gilman, the founder of purely university education in America, and the president of this University, which has done so much for the cause of scientific investigation, has consented to accept the presidency of the National Civil Service Reform Association; for I believe that the introduction of more science and more scientific investigation into the civil service means the development and extension of a rational system of government based upon merit, rather than partisanship or spoils. Here Harvey, the father of physiology, raised the true standard for us when he exclaimed: 'I avow myself the partisan of truth alone.'

I cannot close without expressing my cordial assent to another point made by Professor Osborn and my belief in its extreme importance, viz., the reciprocal duty which the scientific worker owes to the State.

Who can forget the famous and stinging characterization of that tutor in Magdalen College whom Gibbon's caustic pen has embalmed in eternal disgrace, one Dr. ———, of whom Gibbon said, 'he well remembered that he had a salary to receive, and he only forgot that he had a duty to perform.' I have always been sorry that Dr. ——— was a teacher and glad that he was not a scientific man. President Hadley, I think, struck the right note when he cautioned young men not to ask themselves 'How much can we get out of college?' but rather, 'How much of ourselves can we put into it?' Science, like religion, demands of her votaries lofty sacrifices and personal devotion, and if they are public servants their debt to her is always not less but more.

WM. T. SEDGWICK.

MASSACHUSETTS INSTITUTE OF TECHNOLOGY.

THE ALBANY MEETING OF THE GEOLOGICAL SOCIETY OF AMERICA.

I.

THE thirteenth annual meeting of the Geological Society of America was held in Albany on December 27, 28 and 29, 1900. The fellows were called to order by the retiring President, Dr. George M. Dawson, Director of the Geological Survey of Canada, at 10 A.M. on Thursday, in the chapel of the Albany Academy. A very gratifying number of members was present and during the sessions from 50 to 60 were in attendance. All felt the significance of meeting in the city where stratigraphical geology received its greatest single impetus in America and where the classification of most of the Paleozoic was chiefly worked out. Memories of James Hall were in all minds and frequent reference was made to the late venerable State Geologist, first President of the Society.

At the opening meeting brief addresses of welcome were made by Dr. F. J. H. Merrill, State Geologist, and by Dr. J. M.

Clarke, State Paleontologist. The Council then presented its written report, which showed the Society to be in a very flourishing condition. During the year one fellow, Mr. Franklin Platt, has died. The present enrolment is 248, and the financial condition is gratifying. The following officers were declared elected:

*President*, Charles D. Walcott, Washington, D. C.; *First Vice-President*, N. H. Winchell, Minneapolis, Minn.; *Second Vice-President*, S. F. Emmons, Washington, D. C.; *Secretary*, H. L. Fairchild, Rochester, N. Y.; *Treasurer*, I. C. White, Morgantown, W. Va.; *Editor*, J. Stanley Brown, Washington, D. C.; *Librarian*, H. P. Cushing, Cleveland, O.; *Councillors*: Samuel Calvin, Iowa City, Ia.; A. P. Coleman, Toronto, Can.

A memorial of Franklin Platt, prepared by Persifer Frazer was then read by W. M. Davis, and at its conclusion the reading of scientific papers was immediately taken up.

*Experimental Work on the Flow of Rocks recently carried out at the MacGill University, Montreal*: FRANK D. ADAMS.

This paper gave the results of an investigation in which the effects of very heavy pressure on rocks were studied with a view to ascertaining how the gigantic movements which geologists observe in the strata of the earth's crust have taken place.

Marble was the rock on which most of the work was carried out, but harder rocks such as granite are now being studied as well. Small columns of marble an inch in diameter and an inch and one-half high were carefully turned, polished and then very accurately fitted into heavy wrought iron tubes constructed on the plan of heavy ordnance, by wrapping strips of wrought iron around a core of soft iron and welding the whole together. The core of iron was then bored out and the marble substituted for it. Heavy steel pistons were fitted into each end of the tube, and the rock was thus submitted to very high pressures, often for several months continuously, in espe-

cially constructed machines capable of developing pressures reaching nearly 100 tons to the square inch.

Under high pressures the marble was found to flow, bulging out the iron tube that enclosed it on all sides. When the iron tube was cut away a solid block of marble was obtained, which had completely altered its shape. It was found, however, that the marble in these cases was only about half as strong as the original rock.

Other columns of marble were then heated to temperatures of 300 C. and 400 C. and while thus heated the pressure was applied as before. Under these conditions the rock was found to flow readily and to retain its strength much better, being nearly as strong as the original rock.

In the third series of experiments the marble was not only heated to the temperatures before mentioned, but at the same time water under a pressure of 460 pounds to the square inch was forced through it while it was being compressed. Under these conditions, the marble after being molded was found to be as strong as it was originally.

A microscopical study of the structure of the deformed marble shows that in these two latter cases the crystalline grains composing the marble had glided on one another.

This structure is exactly the same as that which is produced in a billet of iron when it is heated and then hammered or rolled, or in a button of gold when flattened in a vise, so that the marble *flows* just as any metal does when submitted to pressure, except that under the ordinary conditions at the surface of the earth the brittleness of the marble causes it to break before the flow point is reached. In the depths of the earth, however, being hemmed in by other rocks, it flows as in the experiments.

The paper was elaborately illustrated by specimens and by many lantern slides, show-

ing the machines employed, as well as the marble before and after compression. They also illustrated its structure as compared with that of various rocks found in the earth's crust and with hammered iron.

In discussion B. K. Emerson asked (1) whether the cylinders of marble contained any water before they were put into the machine; (2) if any schistosity resulted, and, if so, in what way it was related to the optical properties of the calcite grains; (3) if the marble rebounded on the release of pressure.

J. E. Wolff inquired whether the water that was forced in passed around or through the cylinder of stone, and if solution played any part.

G. K. Gilbert asked if the speaker could draw a parallel between the pressures employed and the depths within the earth corresponding to them.

In reply Professor Adams stated (1) that the cylinders of marble were kept in a perfectly dry laboratory, and that while no determinations of their content of water had been made, they were practically dry when put in the machine; (2) he had noted no rebound. The marble was first compressed and then accommodated itself to the pressure by flowage; (3) he had been unable to note any effects of solution as a result of the entrance of the water. The results were the same with or without the water, except that with the water the resulting disk was stronger. The water entered at the top under 460 pounds' pressure to the square inch and emerged at the bottom. The water had dissolved a little copper from the tube of entry, which was precipitated on the bottom of the marble. He could not state positively whether it went through or around, but the marble was in a bath of vapor.

J. E. Wolff suggested that waters with some dissolved dye or easily reducible salt be employed so that the last point could be



determined, and that ordinary limestone be compressed to see if it would yield marble, and that impure varieties be also used so as if possible to produce the silicates familiar as a result of metamorphism. G. K. Gilbert estimated approximately the depth which corresponded to the pressures employed. Roughly one vertical foot of rock corresponds to an increase of one pound per square inch, or one-half ton per 1,000 feet. Forty tons would therefore correspond to 80,000 feet or about 16 miles. This should be reduced somewhat, as rock is slightly heavier than the assumption, but the difference is slight.

C. D. Walcott remarked the deformation which he had observed in the rocks of the ranges in California and western Nevada, and emphasized the different behavior of brittle rocks and tough rocks, illustrating his remarks by photographs. The brittle rocks break while the tough rocks flow—the former being often driven into the latter. He suggested that Dr. Adams experiment with cylinders of varied tenacity.

G. K. Gilbert raised the point that rocks may compress slightly while they are within the elastic limit, *i. e.*, before they yield, flow or otherwise deform. He suggested the importance of determining the amount of this.

B. K. Emerson remarked the importance of allowing for the phenomena of recrystallization in interpreting the results.

Dr. Adams then thanked his colleagues for the suggestions, and stated his intention of carrying them into effect as far as possible.

The paper was felt by all to be one of the most important ever presented to the Society, and the investigations are of such significance that further results will be eagerly looked for.

*Geomorphogeny of the Klamath Mountains:* J. S. DILLER, Washington, D. C.

During the Neocene the Klamath moun-

tain region of northwestern California and southwestern Oregon, by long-continued erosion, was reduced to a peneplain and the resulting marine sediments, rich in fossils and deposited along the ocean border, recorded its age. The Neocene strata were compressed and tilted, and with the Klamath peneplain and monadnocks were uplifted somewhat differentially several hundred feet above its former level. The invigorated streams in the rather long succeeding epoch of stability cut wide valleys across the peneplain to the coast, where extensive wave-cut terraces were developed. A much greater differential uplift followed, and elevated the region to an altitude of 1,200 feet to 2,000 feet, for the Klamath peneplain near the coast of 7,000 feet, and near the crest of the range causing the streams to cut deep canyons before the close of the glacial period. Near the northern border of the Klamath Mountains on the coast there has been a recent subsidence converting the lower courses of the rivers to tidal inlets.

M. R. Campbell inquired if the peneplain topography could be traced all around the mountains. The speaker replied that, while it was not everywhere present, it could often be recognized. Mr. Campbell then remarked the interesting parallelism with the Appalachians, the similar shading of plains into each other and the similar interpretation of escarpments.

As Mr. Diller had referred to great numbers of small lakes upon the elevated plain and with local 'fluvialite' rather than 'lacustrine' sedimentation, W. M. Davis suggested for the phenomena Penck's term of 'continental' sedimentation. He compared the region to the central plateau of France, and urged that under compression surface plains would warp in a general way like single strata, so that in a principal ascent of a large order there would be alternate ascents and descents of a smaller order of magnitude.

President Dawson referred to the Eocene peneplain of British Columbia that was protected from the sea during its formation by an intervening range of mountains, and was therefore subaërial in its character. He asked why the Klamath peneplain might not be explained by marine denudation. Mr. Miller replied that in the Klamath case Eocene strata were themselves trenched, and, therefore, the leveling was later; and that the entire absence of marine sediments compelled him to infer sub-aërial agencies. G. O. Smith spoke of the peneplain of Washington that lies between the Klamath mountains and British Columbia. It is post-Miocene, as it cuts Miocene strata, which have themselves been deformed, probably in the case of basalt by slipping along multitudes of joints, as suggested by Bailey Willis. G. K. Gilbert described the great Alaska peneplain, which slopes upward and eastward from the Alexander Archipelago to heights of 5,000 feet and more in the mountains. It has been vividly brought out by the photographs of the Survey of the International Boundary. He also remarked the parallelism that existed between the Pacific and Atlantic physiography. President Dawson cited mountains of the Pacific coast 7,000 feet high that have been sculptured out of uplifted plains. He sounded a note of caution, however, lest the observer be misled into believing in peneplains which had no real existence. Above a certain level degradation is abnormally active and rapid, and from this alone mountains may reach a common and deceptive level and yet not be stumps of peneplains. Mr. Gilbert, however, replied that his Alaska mountains were shouldered and therefore not open to doubt.

*Origin and Structure of the Basin Ranges:* J. E. SPURR, Washington, D. C.

The structure of most of the ranges which have been hitherto studied in the Great

Basin region was first examined in detail, and in each case deductions were made as to the relative importance of erosion and of direct deformation, by either fault or folds, in determining the present topographic relief. Finally a general statement as to the origin of this relief is arrived at. The history of erosion in the region, and that of deformation, so far as these are known, were discussed separately; and the history and foundation of the fault hypothesis as applied to these ranges were examined. The conclusion arrived at is that the ranges in general owe their existence to the long-continued erosion of rocks folded and faulted by many successive movements, and that it is only exceptional that the folds or faults are expressed in direct deformation of the present surface.

This paper was read in abstract by C. D. Walcott and was illustrated by cross-sections. It involved a great amount of detail, however, which it is not possible to summarize, but which will be extremely valuable as a matter of record. At its conclusion the morning session adjourned. On reassembling the first paper read was the following:

*The Tuff Cone at Diamond Head:* C. H. ИГГНСОК, Hanover, N. H.

This cone is one of the famous ones of the Hawaiian Islands, and is interesting and exceptional in that coral, limestone and marine shells are copiously mingled with the tuffs, giving rise to a difference of opinion as to whether the cone is submarine and therefore marks a notable subsequent elevation of the land, or whether the organic remains have been ejected to their present positions along with the tuffs. No discussion followed, as the Fellows seemed too unfamiliar with the locality to hazard an opinion.

*An Hypothesis to account for the Extra-Glacial, Abandoned Valleys of the Ohio Basin:* MARIUS R. CAMPBELL, Washington, D. C.

The lower courses of the Allegheny, Monongahela, Kanawha, Guyandot, Big Sandy and Kentucky rivers are characterized by abandoned channels which generally range from 100 to 200 feet above the present streams. Generally these channels are deeply covered with silt, but sometimes the rock floor is only partially obscured by a thin layer of sand and gravel. The streams which have forsaken these valleys have sought new routes, along which they have carved deep channels through the upland topography. Teays Valley in West Virginia is perhaps the most noted example, but the old channels at Carmichael and Masontown on the Monongahela River and at Parker on the Allegheny River are also well known.

No reason has been assigned for the abandonment of these channels; they can not be considered as 'ox-bows,' and they are all beyond the limit of glacial ice. The present hypothesis seeks to explain them through the breaking up of river ice and the formation of local ice dams, which were of sufficient height to force the water over the lowest divide in the rim of the basin and which persisted long enough for the stream to intrench itself in its new position.

The paper was illustrated by many lantern slides of topographical maps. It brought on an extended discussion, because the Fellows were generally familiar with the subject, since for many years Teays Valley has not been omitted at a meeting, but has come up in one connection or another, and has grown to be a sort of geological Banquo's ghost, that will not down. I. C. White opposed the ice jams and argued in favor of one large dam produced by the continental glacier when it crossed the Ohio river. He emphasized the softness of the rocks at the headwaters of the southern tributaries and the harder ones further down. W. M. Davis suggested lakes as a possible obstruction which had developed cut-offs by gradually falling waters. G. K. Gilbert opposed the

explanation by means of a glacial dam, and suggested a possible change in climate, with increasing cold and a filling of the valleys with ice, which brought about a rearrangement of the drainage. M. R. Campbell opposed the explanation by lakes and by a glacial dam, because of the lack of uniformity in the sedimentation which should appear with such an extended cause. A. P. Brigham called attention to the fact that the new courses assumed by some of the rivers were longer than the old and raised the point that ice jams ought to cut off and shorten meanders. M. R. Campbell admitted the slightly longer courses in a few cases, but still supported the ice jam as against all the other causes suggested.

*The Alleged Parker Channel:* EDWARD H. WILLIAMS, Jr., Bethlehem, Pa.

The paper was a brief one, which described one of the cases cited by Mr. Campbell, located at Parker, Pa. Instead of an old channel, the apparently abandoned detour of the Allegheny river was explained by the disappearance or effacement of the divide between the headwaters of two tributary streams.

This general subject having been so well gone over, the above paper was not specially discussed.

*Apparent Unconformities during Periods of Continuous Sedimentation:* GEORGE B. SHATTUCK, Baltimore, Md.

The paper was based on certain phenomena which the author had observed along the shores of Chesapeake Bay. Lenticular beds of black clay were found resting with apparent unconformity on older sediments and provided with cypress knees and other fossilized vegetation. The explanation advanced was that minor stream valleys had been ponded during subsidence of the shore by bars formed across their mouths. Thus, while the sea crept inland and formed extended sediments, these ponded embay-

ments would be the place for the gathering of clays and vegetation which would lie unconformably with the synchronous shore deposits. The paper was very clearly presented and was suitably illustrated by the lantern.

*Origin and Age of an Adirondack Augite*

*Syenite*: H. P. CUSHING, Cleveland, Ohio.

Recent work in the field, together with chemical analyses, demonstrates that the Adirondack anorthosite shows a certain amount of differentiation and passes locally into an augite syenite, all intermediate phases being found, as was contended by the writer in a paper read before the Society two years ago. There is, however, much evidence now at hand to show that much of the great body of augite syenite gneiss in the Adirondacks is older and to be referred in age to the main body of gneiss of the region, whatever that may be. Criteria for distinguishing between the two syenites have not been developed. The paper was presented by permission of the State Geologist, and was illustrated by an extensive series of analyses. J. F. Kemp remarked the abundance of related rocks in the regions to the south, and then the session adjourned for the day.

In the evening the annual dinner was held, with Professor Emerson in the chair and fifty-five present. An address of welcome to the Society was made on behalf of the Regents of the University by Dr. T. Guilford Smith. The proposition for the erection of a State museum in which to house the collections of the various scientific departments was discussed, and resulted in a subsequent resolution which will be given below.

On Friday morning the Society met at 9:30 and listened to a report of the Committee on Photographs by its chairman, N. H. Darton. The collection now numbers over 2,000, and is stored in the building of the

U. S. Geological Survey in Washington. It is a valuable one, and will be revised and condensed, and a published list will be prepared at an early date. This collection has made accessible to the Fellows many photographs made by surveys, both State and national, and by private individuals.

*The Laurentian Limestones of Baffinland*: ROBERT BELL, Ottawa, Canada.

The discovery of great quantities of crystalline limestones in Baffinland was announced in the writer's 'Summary Report for 1897.' The geographical position and physical aspect of the region were described. The general character of the Laurentian System in Hudson Straits was outlined. The rocks of the north side are newer or Upper Laurentian, as far as known, and differ from those of the south shore. Regularity of strike and dip is pronounced. Enormous developments of crystalline limestones have been met in southern Baffinland. Their general characters were described. Great thickness is presented by the beds, some of them being over a mile across and running regularly for long distances. They are evidently stratified aqueous deposits. Questions were raised as to the origin of such limestones. The associated rocks are gneisses and schists, and the accompanying minerals are chiefly feldspar. Owing to the absence of trees, the limestones are conspicuous in the landscape and are not more eroded than the gneisses. Comparisons were drawn with Laurentian limestones elsewhere, the former physical conditions and the older and newer glaciations of Baffinland were discussed as affecting the limestones. The existing glaciers there were described. The paper was illustrated by the lantern. There was no discussion.

JAMES F. KEMP.

(To be concluded.)

## THE AMERICAN PHYSICAL SOCIETY.

THE American Physical Society held its annual meeting at Columbia University on Thursday, December 27, 1900. The following officers were elected for the year 1901: President, H. A. Rowland; Vice-President, A. A. Michelson; Secretary, Ernest Merritt; Treasurer, W. Hallock; Councillors, Henry Crew and E. B. Rosa.

Professor M. I. Pupin, in a paper on anomalous propagation of electrical waves, called attention to certain peculiar results which he had obtained when trying to improve the telephone transmission of a line, by counteracting its capacity by the introduction of self-induction coils between the outgoing line and the return. By this means he was able to considerably improve the transmission of certain frequencies, but he had not succeeded in reinforcing a sufficient range of frequencies to avoid a serious distortion of the quality of articulate speech.

The discussion by Professors Rowland and Webster and others raised the question as to whether Professor Pupin's abnormal velocity of transmission, considerably above that of light, derived from the relation that velocity is equal to the wave-length divided by the period, is justifiable, since it is doubtful what is to be called the 'wave-length' in a coil.

President Rowland reported that his search for an electromotive force due to dragging a wire through the ether had so far failed, and that it would appear that so far as the limits which he had used were concerned, it was safe to conclude that no positive results are attainable.

In a theoretical consideration of certain magneto-optical phenomena President Rowland pointed out that by considering each of two particles as having quantitatively different charges of electricity, he had been able to deduce formulæ which account for many of the electro-optical effects, as the Zeeman, Faraday and other effects, as well

as refraction, double refraction, dispersion, dispersion in double refraction and absorption. If the charge of one of the particles is practically infinite as compared with the other, then his formulæ reduce to the ordinary ones. If the two charges are equal, no Zeeman effect could take place.

Professor E. F. Nichols presented the results of his investigations upon the energy radiated from certain stars and planets as measured with his radiometer, which proves to be about thirty times as sensitive as the radiomicrometer of Professor Boys. The unit used to express the quantity of energy was the hundred-millionth part of the energy received from a candle at a distance of one meter, *i. e.*,  $10^{-8}$  meter-candle. The results obtained were as follows:—Vega, 0.51, —Arcturus, 1.14, —Jupiter, 2.38, —and Saturn, 0.37.

Two papers by Professor R. W. Wood were read by the Secretary. In the first he outlined the method of making very efficient cyanine prisms and of showing their anomalous dispersion. In the second he called attention to certain peculiarities in the propagation of waves reflected in a spherical mirror.

A brief *résumé* of the work of the Paris Congress of Physics was given by Professor A. W. Webster. The reports of the congress have appeared in three volumes, and a 'Procès Verbaux.' It is of general interest that this congress by its commission on units expressed the belief that it is desirable:

1. That a unit of pressure be used, called the *bary*, which is the C.G.S. unit (that is a dyne per square centimeter). The *megabary*, equal to  $10^6$  C.G.S. units, may, for practical purposes, be considered equal to the pressure of a column of mercury 75 cm. high at  $0^{\circ}$ C. under normal conditions of gravity.

2. That the *final* results of calorimetric experiments be expressed in the C.G.S. mechanical units (erg and joule).

3. That in the logarithmic subdivision of the spectrum the sections be called 'regions.' The visible region to include the part between  $0.4 \mu$  and  $0.8 \mu$  and bear the index 0, the infra-red regions having positive, and the ultra-violet, negative indices (thus,  $R_2$  from  $3.2 \mu$  to  $1.6 \mu$ ,  $R_1$  from  $1.6 \mu$  to  $0.8 \mu$ ,  $R_0$  from  $0.8 \mu$  to  $0.4 \mu$ ,  $R_{-1}^2$  from  $0.4 \mu$  to  $0.2 \mu$ , etc.).

4. It is desirable to reserve the word *density* to designate the quotient of mass by volume.

The titles of the papers read were as follows :

'On anomalous propagation of electric waves,' by M. I. Pupin.

'A search after a new source of electromotive force,' by H. A. Rowland.

'The theory of certain magneto-optical phenomena,' by H. A. Rowland.

'On the heat of Arcturus, Vega, Jupiter and Saturn,' by E. F. Nichols.

'On cyanine prisms and a new method of exhibiting anomalous dispersion,' by R. W. Wood.

'On the propagation of cusped waves and their relation to the primary and secondary focal lines,' by R. W. Wood.

WILLIAM HALLOCK.

#### AMERICAN MATHEMATICAL SOCIETY.

THE American Mathematical Society held its seventh annual meeting at Columbia University, New York City, on Friday, December 28, 1900. About forty persons, including thirty-three members of the Society, were in attendance during the two sessions. Vice-President Thomas S. Fiske occupied the chair. A special feature of the meeting was the election of officers and other members of the Council. Under recent amendment of the Constitution, taking effect at this meeting, the president of the Society is elected for a term of two years and is ineligible for immediate reelection. The number of members of the Council elected annually is increased from three to four. This provision with the recent inclusion of ex-presidents as permanent mem-

bers brings the present membership of the Council up to twenty-four. The newly elected officers are: President, Eliakim Hastings Moore; Vice-Presidents, Thomas S. Fiske and Henry S. White; Secretary, F. N. Cole; Treasurer, W. S. Dennett; Librarian, Pomeroy Ladue; Committee of Publication, F. N. Cole, Alexander Ziwet, Frank Morley; Members of the Council to serve for three years, E. W. Brown, H. B. Fine, T. F. Holgate, W. F. Osgood; Member of the Council to serve for two years, E. W. Hyde.

During the six years since its reorganization as a national body, the history of the Society has been one of constant and rapid development. The membership has grown from 244 in 1894 to 357 at present. In 1894 the number of papers read at the meetings was 24; in 1900 it was 115. Since 1894 summer meetings have been regularly held, supplemented on two occasions by colloquia or special courses of lectures. These have done much to bring the members together and to create a more general interest. The rapid expansion of the Society led in 1898 to the formation of the Chicago Section, which fosters the interest of the Society in the West. By the founding of the *Transactions*, which has just completed a very successful first year, improved facilities have been provided for the publication of important papers read before the Society. A gratifying recognition of the Society's usefulness and efficiency is found in the liberal financial cooperation of ten leading universities in the publication of the *Transactions*. The *Bulletin*, which was founded in 1891 as a historical and critical review, has been greatly enlarged, although confining itself more strictly than before to its special field.

The administration of the business of the Society has been wisely left from the beginning in the hands of the Council, the time of the meetings being thus economized for the purely scientific proceedings. The

finances of the Society are in a satisfactory condition, a moderate reserve fund having been slowly accumulated. The Society also possesses a considerable library, as yet of unbound journals and works. It is hoped that arrangement can soon be made for binding the books and making them accessible to the members.

At the annual meeting the following twenty-five persons were admitted as members of the Society.

Dr. G. N. Bauer, University of Minnesota; Dr. J. R. Benton, Princeton University; Dr. H. F. Blichfeldt, Leland Stanford University; Dr. G. A. Bliss, University of Minnesota; Professor Joseph Bowden, Adelphi College, Brooklyn, N. Y.; Professor D. F. Campbell, Armour Institute, Chicago, Ill.; Dr. J. E. Clarke, Gilbert School, Winsted, Conn.; Dr. Euplio Conoscente, New York, N. Y.; Mr. Arthur Crathorne, University of Wisconsin; Mr. H. W. Curjel, Birkdale, Eng.; Professor L. M. Defoe, University of Missouri; Mr. B. S. Easton, University of Pennsylvania; Dr. L. P. Eisenhart, Princeton University; Mr. U. S. Hanna, University of Indiana; Mr. L. I. Hewes, Yale University; Mr. A. M. Kenyon, Purdue University; Professor C. N. Little, Leland Stanford University; Mr. E. L. Milne, University of Illinois; Mr. H. B. Mitchell, Columbia University; Dr. Asutosh Mukhopādyaý, Calcutta, India; Mr. W. S. Nichols, New York, N. Y.; Professor J. M. Page, University of Virginia; Dr. T. H. Tallaferro, Pennsylvania State College; Miss R. H. Vivian, University of Pennsylvania; Dr. N. R. Wilson, Royal Military Academy, Kingston, Canada. Six applications for membership were received. The Annual Register of the Society, containing a complete list of members, the constitution and by-laws, reports of the secretary, treasurer and librarian, etc., is now in press.

The following papers were read at the annual meeting:

(1) Dr. VIRGIL SNYDER: 'On some plane curves having factorable parallels.'

(2) Professor E. D. ROE: 'On a formula of interpolation.'

(3) Mr. W. B. FORD: 'Dini's method of showing

the convergence of Fourier's series and of other allied developments.'

(4) Dr. EMORY MCCLINTOCK: 'A simplified solution of the cubic.'

(5) Professor W. F. OSGOOD: 'On the minimum property of an external that meets its envelope.'

(6) Mr. C. J. KEYSER: 'Theorems concerning positive definition of finite assemblage and infinite assemblage.'

(7) Professor M. I. PUPIN: 'Wave propagation over bridged wave conductors.'

(8) Professor MORLEY: 'On a point in Sylvester's theory of canonical forms.'

(9) Professor HARRIS HANCOCK: 'On primary prime functions in several variables and a generalization of an important theorem of Dedekind's.'

(10) Dr. J. I. HUTCHINSON: 'On some birational transformations of a Kummer surface into itself.'

(11) Miss R. G. WOOD: 'The collineations of space which transform a non-degenerate quadric surface into itself.'

(12) Professor H. E. SLAUGHT: 'The complete form systems of invariants of the group of 120 quadratic Cremona transformations of the plane.'

(13) Dr. JAMES MACLAY: 'Some geometrical theorems connective with a class of differential equations derived from Poisson's equation

$$\frac{\partial^2 z}{\partial t^2} = a^2 \left( \frac{\partial^2 z}{\partial x^2} - \frac{mz}{x^2} \right).$$

(14) Mr. J. K. WHITTEMORE: 'A note on cones of the second degree osculating developable surfaces.'

(15) Professor E. O. LOVETT: 'The types of line-sphere transformation.'

(16) Professor E. O. LOVETT: 'Note on differential geometry of  $n$ -dimensional space.'

(17) Dr. L. P. EISENHART: 'A demonstration of impossibility of a triply asymptotic system of surfaces.'

(18) Professor MAXIME BÔCHER: 'Some cases in which the identical vanishing of the Wronskian is a sufficient condition for linear dependence.'

After the meeting many of the members dined and spent the evening together.

The Chicago Section of the Society held its usual winter meeting at the University of Chicago on December 27th-28th. A report of the sectional meeting will appear later in this JOURNAL.

The next meeting of the Society will be held in New York on Saturday, February 23d. The Chicago Section will meet on

Saturday, April 6th. The summer meeting of the Society will be held at Cornell University, beginning on Monday, August 19th. Arrangements are being made for a colloquium in connection with the summer meeting. The committee in charge is now able to announce that Professor E. W. Brown will give a course of six lectures on 'The modern methods of dealing with the problems of dynamics and especially those of celestial mechanics,' consisting mainly of the work of Poincaré in this direction. A second course of lectures will also be arranged.

F. N. COLE,  
*Secretary.*

#### THE AMERICAN CHEMICAL SOCIETY.

THE first session of the twenty-second general meeting of the American Chemical Society was held in Lewis Institute, Chicago, Ill., on Thursday, December 27, 1900. The session was called to order by President McMurtrie, in the chemical lecture-room of the Institute at 10.15 A.M. Dr. W. R. Smith, chairman of the Chicago section of the Society, was introduced and welcomed the chemists on behalf of the local section. He was followed by Howard S. Taylor, Esq., prosecuting attorney for the city of Chicago, who addressed a few words of welcome on behalf of the city and its citizens. President McMurtrie responded briefly on behalf of the Society, thanking the speakers for the cordial words of welcome.

After a few announcements a paper on 'Correction in the Determination of Urea by the Liebig Method,' was read by J. H. Long. This was followed by another paper by the same author, on 'Preliminary Note on the Optical Rotation of Certain Tartrates in Glycerol.' The latter paper was discussed by Messrs. W. A. Noyes and Long. A paper on 'The Decomposition of Sodium Nitrate by Sulphuric Acid, Part

Two,' by C. W. Volney, was read by the author. Edward Gudeman presented a brief paper on arsenical poisoning, which was discussed by Messrs. Springer, Volney and Gudeman, and Miss Fossler. Two papers by C. L. Parsons, entitled 'A Simple Test for distinguishing Oleomargarine from Butter,' and 'The Use of Metallic Sodium in Blow-pipe Analysis,' were read by the Secretary in the absence of the author.

A photograph of the assembled chemists was taken, and, after a few announcements, the morning session was adjourned. At the close of the session luncheon was served in the building, through the courtesy of the authorities of the Lewis Institute.

The Council of the Society met at the Lewis Institute at 1.30 P.M. Other members of the Society participated in visits to the works of Messrs. Frazer & Chalmers, the Consumers Ice Company, and the Eisendrath tannery of the American Hide and Leather Company.

The evening session of the Society was held in the banquet hall of the Auditorium Hotel. Dr. W. R. Smith, vice-president of the Society and chairman of the Chicago section, presided. The retiring president, Dr. William McMurtrie, delivered an address on 'The Condition, Prospects and Future Educational Requirements of the Chemical Industries.' After a few announcements the session adjourned, and the visiting chemists enjoyed a 'smoker' given by the members of the local section at the Technical Club, 230 South Clark street.

The session of the meeting on Friday was held in the chemical lecture room of the Northwestern University Medical and Pharmacy School, 2421 Dearborn Street. The meeting was called to order by President McMurtrie at 9.30 A.M.

The annual reports of the Secretary, the Treasurer and the Librarian were presented in order and read by the Secretary. These reports were accepted by the Society and



ordered placed on file. President McMurtrie made a few remarks regarding the thorough work which had been accomplished by the Librarian during the past year, and on motion of Dr. Hart the thanks of the Society were voted to the Librarian for his successful and faithful services.

The editor presented a brief oral report of his work.

Reports received by the Secretary from F. W. Clarke, chairman of the Committee on Atomic Weights and also chairman of the International Committee on Atomic Weights, were presented by the Secretary in the absence of Mr. Clarke, and were read by title and referred to the Committee on Papers and Publications.

The Secretary reported from the Council that that body had considered the question referred to it by the Society at the New York meeting with reference to the passage of H. R. Bill 104, looking to the adoption and use of the metric system, and had decided to recommend that the Society lay the question on the table. By a vote of the Society the recommendation of the Council was adopted and the question\* was laid on the table.

The Committee on Standards for Instruments of Measure reported progress through Messrs. Munroe and Linebarger, who urged immediate action on the part of the membership with reference to the bill now pending in Congress to establish a National Standards Bureau.

The Secretary presented a motion urging the appointment of a committee to consider the adoption of a permanent badge or pin by the Society. The motion being seconded, it was moved and carried that the whole matter be laid upon the table.

After some announcements W. A. Noyes presented a paper on 'Synthesis of Derivatives of Dimethyl-cyclopentanone] and of Beta Beta Adipic Acid and of Alpha Beta Beta Tri Methyl Adipic Acid.' Dr. Noyes

also presented a paper by himself and W. M. Blanchard on 'A New Hydroxy Dihydro-campholytic Acid.'

After some other announcements Professor A. B. Prescott presented a paper by B. F. Trowbridge, entitled 'Notes on Sugar Beet Analysis.' This was followed by a paper 'On Hematite Crystals,' by Charles E. Munroe.

The remaining papers on the program were read by titles.

On motion of Dr. Alfred Springer, the thanks of the Society were extended un-animously to the Chicago Local Section; the Local Committee of Arrangements for the meeting, the authorities of the various institutions which had extended courtesies to the Society during its meeting, and the proprietors of the various works which had been thrown open to inspection by the visiting chemists.

The Local Committee made some announcements with reference to a proposed excursion to South Chicago on Saturday morning, and the meeting of the Society was then adjourned. In the afternoon the chemists enjoyed an excursion and visit to the Stock Yards Industries, and at 7 P.M. a subscription dinner was given in the banquet hall of the Auditorium Hotel.

ALBERT C. HALE,  
*Secretary.*

#### SCIENTIFIC BOOKS.

*The Mammals of South Africa.* By W. L. SCLATER, M.A., F.Z.S., Director of the South African Museum, Cape Town. Vol. I. Primates, Carnivora and Ungulata. With a map and illustrations. London, R. H. Porter. 1900. Medium 8vo, pp. i-xxx+1-324, with map and 80 text cuts.

Smuts's 'Mammalium Capensium,' published in 1832, a small quarto in Latin, is the first and only attempt to present an account of the mammals of South Africa prior to the work here under notice, of which the first volume has just appeared. Hence the desirability of a good

manual of South African mammals is apparent. This, we are happy to say, is now being provided by Mr. Sclater in the form of a large octavo work in two volumes, beautifully printed and well illustrated with, for the most part, excellent text cuts, many of them prepared especially for the work. The region here included is that portion of Africa south of the Cunene and Zambesi rivers.

South Africa has a comparatively rich mammalian fauna, the three orders here treated—the Primates, Carnivora and Ungulata—numbering 95 species and 8 additional subspecies, while the remaining orders—the Chiroptera, Insectivora, Rodentia, Edentata and Cetacea—to be treated in Volume II., will doubtless raise the number to considerably more than 200. In the present work the author informs us he has endeavored 'to collect together all the information at present available on the subject of South African mammals,' but he has been hampered in its preparation by lack of specimens and by paucity of information regarding the life-history of the species. He has, however, laid a good foundation for further additions and given a most excellent and useful summary of the subject. A bibliography of the more important separate works relating to South African mammals occupies pp. xi-xix, and following the synonymy under each species is a paragraph, under the heading 'Literature,' giving further references.

The work is well designed to serve as a convenient manual, the higher groups being defined, and keys are provided to the genera and species, and the descriptions are fairly full. The text is further paragraphed under 'History,' 'Distribution,' 'Habits,' etc., where whatever is known of the species is briefly summarized.

In respect to nomenclature, it is well to note that the twelfth edition of Linnæus, instead of the tenth is taken as the starting point, and that specific names when employed for genera are discarded in their specific sense, so that we have, for example, *Suricata tetractyla* instead of *Suricata suricatta*, although the latter is the older name; and *Oreotragus saltatrix* instead of *Oreotragus oreotragus*, etc. As usual with English authors, only two genera are recognized in the

family Otariidæ, all the species but one being referred (p. 118) to the genus *Arctocephalus*, the type of which is wrongly given as *A. ursinus*; while the wholly undeterminable name *A. pusillus* (Schreber) is used for the single South African species, instead of the correct name *A. antarcticus* (Thunberg).

This volume is the second in point of issue—Volume I. of the late Dr. Stark's 'Birds of South Africa' being the first—of a 'series in which it is proposed to give an account of the Fauna of Africa south of the Zambesi and Cunéné Rivers,' under the general title 'The Fauna of South Africa,' under the editorship of Mr. W. L. Sclater, the author of the mammal volumes of the series. The second volume of the birds is in course of preparation by Mr. Sclater, from MSS. left by Dr. Stark, who was killed early in the present South African war.

J. A. A.

*Report of the U. S. Commissioner of Fish and Fisheries for the Year ending June 30, 1900.* By GEORGE M. BOWERS. Washington, Government Printing Office. 1900. Pp. 191.

The report of the Commissioner of Fish and Fisheries, for the year ending June 30, 1900, again shows an increase of fish distributed of a round hundred million, consisting chiefly of shad, cod, flatfish, whitefish and lake trout. Whitefish, shad and cod stand at the head of the list, the totals being about 337, 265, and 241 millions, respectively. The year, on the whole, has been a good one and the results commensurate with the steady expansion of operations, while local accidents of climate have, in a few cases, reduced the normal output. In California the drought of last year considerably affected the spawning migrations of the quinnat salmon. On the Rogue river, in Oregon, an innovation in the food of quinnat fry, in the way of using canned salmon scraps, was attempted with promising results. In Michigan, the close season was amended to allow the National Commission to take whitefish and lake trout for fish-cultural purposes, with the result of very large collections at a minimum expenditure. The Commission moreover operated the Michigan whitefish hatcheries at Detroit and Sault Ste., Marie, for which the State did not provide

this year. Most of the whitefish output was obtained from 'penned' fish, a method of holding the fish until ripe, which has now an assured place in fish-cultural operations. Seasonal difficulties affected unfavorably the pike-perch in Lake Erie and Vermont, though a total of 90 million eggs and fry was distributed.

The New England stations propagating the great marine food species were unusually successful. Cod were hatched in excess by 50 million of any previous record. The interesting experiment of tagging adult codfish for the purpose of acquiring data on their migrations and growth was continued, 1,311 being returned to the ocean in November from the Wood's Holl Station, of which 11 were captured, some as far south as New Jersey, before the close of the year. A new method was followed in flatfish culture, consisting in allowing natural spawning in tanks in place of fertilizing artificially, the results indicating the superiority of this means of obtaining fertilized eggs of this species.

Three new stations were put in commission—at Bullochville, Ga., Edenton, N. C., and Nashua, N. H., devoted chiefly to the salmonids, shad and bass, making a total of 35 operated during the year.

The weather considerably shortened the shad season on the Potomac, but an unusual run occurred on the Delaware, the price falling to nearly nothing. The success here and on the Susquehanna made possible a large total output, a gain of several millions over the preceding year. The basses and crappie were in unusual demand, but the development of the collecting work on the Mississippi and Illinois rivers—by which fingerling bass that would otherwise be sacrificed are taken from the 'back' waters of the river, throwing the fish-cultural work upon nature—met all demands at a nominal expense.

Encouraging reports come from Montana and Colorado of the establishment of brook and steelhead trout in waters very recently without these valuable species. Captures of a few specimens in other cases indicate the process of establishing rainbow trout in Maine and Tennessee, Swiss trout in the Adirondacks, and quinnat salmon in Lake Ontario. The Chesapeake and Ohio canal was seined prior to drawing off the water for the winter, for a distance

of 92 miles, and some 90,000 fish of many species transferred to the Potomac.

Notable among the biological investigations of the Division of Scientific Inquiry are the oyster experiments at Lynnhaven Bay, Va. These are directed toward a practical method of fattening oysters by the use of a commercial fertilizer through the medium of their diatomaceous food, the diatoms appropriating the fertilizer. The experiments are made in an enclosed and tideless cove and have achieved a definite measure of success in demonstrating the possibility of fattening oysters to marketable condition by this means. The process is slower, however, than demanded for commercial purposes, and modifications of the conditions have been made which provide for artificial currents in the cove, thus approaching more nearly the conditions of nature.

The failure of the North Carolina oyster-beds has been taken up by the Commission, and the steamer *Fish-Hawk* spent the fall and winter on important portions of the grounds. A report upon the subject is in preparation. Eastern oysters have become well acclimatized in San Francisco Bay and support an industry yielding a half-million of dollars annually in mature oysters with the quantity and value on the increase. The conditions at Willapa Bay, Washington, were examined with reference to the fate of a plant of eastern oysters made there in 1894. It appears that the water is colder than is favorable for the setting of the spat. Nothing came of the plant, and while reports show that a large proportion of them were alive a year after planting, the original oysters have now almost entirely disappeared and there is a presumption of depredations upon these grounds. A method of obtaining spat from shallow ponds constructed for the purpose was recommended, the spat to be then planted in the bay. In connection with the failure of eastern oysters to multiply in the colder waters of our northwestern coast, oysters of northern Japan are to be transplanted to Washington waters.

The Wood's Holl laboratory has undergone expansion in equipment, the amount of work done, particularly in devoting, at the suggestion of the Commissioner, the museum room

to the purposes of the library. This change gave great satisfaction to the investigators, who were in greater number than usual. The work carried on included some chemical determinations of the connective tissue of the ocean sunfish, with a view to its value in making glue, and of lobster chitin in the hope of discovering for it a commercial use; diseases of fishes, anatomy of the star-fish, and of the alimentary tract of the flounder; photography and sketching of living marine forms. A series of publications has been planned which is to embrace all the invertebrate groups of the region. The Beaufort, N. C., laboratory completed the first year of its existence and concerned itself, among other things, with the breeding conditions of some fishes, sponges and parasitic crustaceans, the latter including a barnacle (*Dichalaspis*) on the gills of the common blue crab; spawning habits of certain food-fishes; life history of brittle stars; effects of abnormal conditions on the development of oyster eggs and those of other molluscs; the development of a common annelid (*Axiotea*) which forms part of the food of bottom-feeding fishes, and the food of the hog-fish and croaker. An observation is made on the inferior flavor of the hog-fish taken at Beaufort, which reduces its value as a food-fish as compared with the same species taken, for instance, at Norfolk. One cause of the undesirable flavor is traced to the interesting form *Balanoglossus*. The Beaufort laboratory is happily located for the purposes of marine biology, and now that a permanent establishment has been authorized by Congress continuous systematic studies on broad lines may be anticipated.

In accordance with the direction of the last Congress, a special lobster and clam investigation, for the purpose of remedying the marked decline in these fisheries, has been instituted. With the lobster, efforts are directed toward methods of rearing the larvæ through the early defenseless stages before liberating. With the clam it is apparently feasible to apply the methods of planting which are so extensively used with the oyster. The work has begun during the past summer and is proceeding satisfactorily.

Some work on variation in the common

mackerel, begun in 1898, with a view to the question of its separation into geographical races—a fact demonstrated by an English investigator, Mr. Walter Garstang, for British mackerel—was continued during the summer of 1899, and confirms Mr. Garstang's observation of a marked difference between American and British mackerel. As for recognizable American races the material examined, as far as it goes, tends to show that such do not exist. The data, however, from the extremes of the range of the species are not yet complete.

Collections of aquatic fauna and general biological observations have been carried on in Cobbosseecontee and Sebago Lakes in Maine, in Seneca Lake, New York, in Lake Mattamuskeet, N. C., in West Virginia, in the Wabash Basin, Indiana, and in California, Oregon and Arizona. The biological survey of Lake Erie was carried on as usual throughout the summer, with headquarters at Put-in Bay, plankton studies forming an important part of the work. The collections made by the *Fish-Hawk* expedition to Porto Rico in 1899 have been distributed to specialists in the various groups. The report on the fishes was issued during the last days of the year, the others are approaching completion and it is probable that all will be published during the next fiscal year.

Dr. H. F. Moore submits an outline of the recent extensive cruise of the steamer *Albatross* in the South Seas. This expedition left San Francisco in August, 1899, Mr. Alexander Agassiz in charge of the scientific work, assisted by a party of seven, four of whom represented the Commission. The *Albatross* cruised for over six months among the South Sea Islands, visiting the Marquesas, Paumotu, Society, Tonga, Fiji, Ellice, Gilbert, Marshall and Caroline Islands and Guam. Accounts of the voyage have appeared in these columns. In the Tonga group the trawl was used in 4,173 fathoms, the deepest trawl haul ever made. The work of the party concerned the zoology, geology, ethnology and botany of the island groups, the director devoting himself to the coral formations. The officers of the vessel made surveys and nautical observations. The *Albatross* reached Yokohama in March of the present

year and spent three months trawling and dredging on the coast of Japan. In June she sailed for Alaska on commercial investigations of the Alaska salmon fisheries.

The statistical canvasses have this year covered New England, New York and Lake Erie, and in May the canvass of the Pacific coast was begun. The figures for New England show a moderate falling off in value of fishery products since the last tabulation in 1889, and also in the amount of invested capital, the latter caused by the transfer of the menhaden industry to New York. The lobster fishery has the remarkable record of a diminution, since 1889, of over 50 per cent. in quantity and a coincident increase of over 50 per cent. in value. The total value of New England fisheries reaches over nine and one-half millions. Lake Erie and Lake Ontario come forward with a large increase in quantity and value, the whitefish, a species very extensively propagated by the Commission, sharing largely in this expansion. Over three and one-half million pounds of the much-abused carp were taken from the American waters of the lake in 1899, with a value of over \$50,000. Indeed, a glance at the figures for this species shows that the carp is certainly the most valuable fresh-water fish after the whitefish and its allies, the pike perch and the lake trout, and should afford food for thought to those who condemn the carp as an unmitigated evil. The Illinois Fisherman's Association reports the catch in the Illinois river as greater in quantity than that of all other species combined, with a value of nearly \$200,000. Carp have increased many fold in the Middle Atlantic States and the Middle West during the last decade, the quantity taken in Lake Erie, the Illinois river, and the Ohio river and its tributaries, during 1899, being nine times that of six years ago.

The annual visit to the fur-seal rookeries on the Pribilofs shows the continued decline of the seal herd as a consequence of the continuance of pelagic sealing. The number of seals taken from the islands under government supervision was 16,812, and the pelagic catch from the American herd some 34,000.

M. C. MARSH.

*A Handbook of Photography in Colors.* By THOMAS BOLAS, ALEXANDER H. K. TALLENT and EDGAR SENIOR. Published by Marion and Co., London. American edition by E. & H. T. Anthony, New York and Chicago.

The authors of this book have brought together in compact form the very scattered literature pertaining to color photography. Part I., by Mr. Bolas, contains a brief history of helichromy, from the early work of Seebeck, Herschel and others until the present day, covering about the same ground as the new edition of Zenker's 'Lehrbuch der Photochromie.' His account of Wiener's work and suggestions regarding the possibility of getting a truly chromo-sensitive surface will be found of use by any who are engaged in the hitherto fruitless search of a substance which when exposed to colored light will assume permanently the color of the illuminating light. That such a surface is theoretically possible is clearly shown, and methods of realizing it in a crude way are given.

The general principles of the various processes are given, including those of Joly, Ives, Lippmann and others. Lippmann's account of his interference process as delivered in English before the Royal Photographic Society is given verbatim. His picture of the formation of the thin laminae which produce the colors by the stationary light waves is interesting. It will be remembered that these stationary waves are produced by backing the sensitive film with mercury. "If you put no mercury," says Lippmann, "each train of waves rushes through the plate and wipes off every record of its own form by reason of its velocity; you cannot expect a thing which moves with a velocity of 300,000 kilometers a second to give a photograph of itself. If you put a mercury mirror behind the plate, then the following phenomena occur: the light is reflected back on itself; the light rushes in with the velocity of light, and rushes out with the same velocity; the entering and issuing waves interfere, and the effect of interference is that vibration takes place, but the effects of propagation are stopped, and instead of having propagated waves, we get stationary waves; that is, the waves

now rise and fall each in its own place; they pose, therefore, in the film and impress their form upon it, the largest movement giving the largest impression, and where the movement is naught the impression is naught."

Part II., by Mr. Tallent, is devoted to three-color photography. It opens with an elementary treatment of spectrum work as applied to the study of color and color mixtures. Following this comes a very complete account of color curves, and the reproduction of various colors by the synthesis of three primary spectrum colors. Ives's beautiful method is again described, together with fuller details regarding the preparation of color records, the preparation and use of color filters and other details. The various other modifications of the three-color scheme are treated, closing with a chapter on Wood's diffraction process. It seems a pity that fuller working details of some of the methods of producing colored transparencies by the superposition of dyed films, are not given. However, there are hints enough to enable one to experiment along these lines if so inclined.

Part III., by Mr. Senior, is a dozen or so pages on the Lippmann process, with formulæ for the preparation of the emulsion. There is a good deal of repetition in the book, as is usually the case in symposia of this sort. It will, however, be found very useful as a reference book by those desirous of experimenting with any of the processes.

R. W. W.

#### BOOKS RECEIVED.

*Lectures on the Lunar Theory.* JOHN COUCH ADAMS. Edited by R. A. SAMPSON. New York, The Macmillan Company; London, Cambridge, University Press. 1900. Pp. 88. \$1.25.

*Knowledge, Belief and Certitude.* FREDERICK STORES TURNER. New York, The Macmillan Company; London, Swan, Sonnenschein & Company. 1900. Pp. viii+484. \$2.25.

*Engineering Chemistry.* THOMAS B. STILLMAN. Easton, Pa., The Chemical Publishing Company. 1900. Vol. II., pp. xxii+503. \$4.50.

*Elementary Organic Analysis.* FRANCIS GANO BENEDICT. Easton, Pa., The Chemical Publishing Company. 1900. Pp. vi+86. \$1.00.

*A Text-book of Urine Analysis.* JOHN H. LONG. Easton, Pa., The Chemical Publishing Company. 1900. Pp. iv+249. \$1.50.

*Evolution of the Thermometer.* HENRY CARRINGTON BOLTON. Easton, Pa., The Chemical Publishing Company. 1900. Pp. 98. \$1.00.

*The Chemists' Pocket Manual.* RICHARD K. MEADE. Easton, Pa., The Chemical Publishing Company. 1900. Pp. vii+204. \$2.00.

*Handbook of Practical Hygiene.* D. H. BERGEY. Easton, Pa., The Chemical Publishing Company. 1899. Pp. 164. \$1.50.

*Concretions from the Champlain Clays of the Connecticut Valley.* J. M. ARMS SHELDON. Boston. 1900. Pp. 45. Plate xiv.

*Annual Report of the State Geologist of New Jersey for the Year 1899: Forests.* Trenton, N. J., MacCrellich & Quigley. 1900. Pp. xvi+327.

*Nature's Miracles: Electricity and Magnetism.* ELISHA GRAY. New York, Fords, Howard & Hulbert. 1900. Pp. vi+248. \$.60.

#### SCIENTIFIC JOURNALS AND ARTICLES.

THE January *American Journal of Physiology*, the concluding number of Vol. IV., records in the initial paper further interesting results obtained by Loeb in his study of artificial parthenogenesis. Loeb has caused the eggs of *Chaetopterus*, an annelid, to develop into free swimming larvæ by simply placing the eggs in various solutions which cause them to lose water. Potassium ions, however, have peculiar power over these eggs which grow to the trochophore stage in a KCl solution with an osmotic pressure considerably lower than that of sea water. A slight addition of HCl to the sea water also causes the eggs to develop. Loeb carefully observed the morphological changes in the eggs during their development, and found that although the artificially produced trochophores may be indistinguishable from those arising from fertilized eggs, yet the processes of segmentation varied so greatly that these processes must be regarded as distinctly a function of the constitution of the sea water. These observations, together with those on the formation of giant embryos by the fusion of two or more eggs, have an important bearing on developmental mechanics and cell lineage. Loeb concludes with a consideration of the relation

between natural and artificial fertilization, and of the relation of his results to the theory of fertilization and of life phenomena in general. 'The Theory of Phototactic Response' is a clarifying paper by Holt and Lee. They aim to show that organisms do not react to direction of light as well as to intensity of rays. The conditions of the organism itself must be more closely regarded. Every ray impinging on an organism stimulates it at one point and in proportion to the intensity. If the light comes to one side of the organism, that side is naturally stimulated more than the other and the response is thus determined. The two factors, intensity of light and the side of the organism the light reaches, account for all the phenomena included under phototaxis and photopathy. Reaction to the 'direction of the ray' must, therefore, be regarded as an incorrect conception, and the term phototaxis relieved of that meaning. A. P. Mathews presents a paper on the spontaneous secretion of saliva, which brings evidence against the theory of secretory nerves. On re-admitting blood to the dog's submaxillary after having cut off the supply for 12 to 25 minutes, the gland secretes rapidly. This secretion is not due to nerve cells in the gland, since nerve cells are made ineffective by absence of blood supply during so long a period. The important fact is that atropine stops the secretion; it must act directly on the gland cells. The value of this drug therefore as a witness for secretory nerves is seriously impaired.

*The Journal of the Boston Society of Medical Sciences* for November 20, 1900, opens with an article on 'Ergographic Studies in Muscular Fatigue and Soreness,' by Theodore Hough. T. M. Rotch notes the 'Treatment of the Proteids of Cow's Milk' and J. J. Thomas describes, with illustrations, 'Five Cases of Injury of the Cord resulting from Fracture of the Spine,' showing among other things the difficulty of exactly locating the seat of injury and the necessity of taking into consideration the manner in which the accident took place. It is noted that early operations should be limited to cases where the neural arches are thought to be crushed and cases of knife and bullet wounds. John Dane notices 'Some Variations in the Skeleton of the Foot,' stating that some form

of variation from the type of foot described in our anatomies may be expected in thirty-three per cent. of human feet.

*The Popular Science Monthly* for December has for its first article a paper by S. F. Peckham on 'Asphaltum for a Modern Street' telling what the material is, where it is found and how the deposits are worked. Allan Macfadyen discusses 'The Effect of Physical Agents on Bacterial Life' showing the varying effects of light, air and temperature on these simple organisms, and stating the remarkable fact that typical series of bacteria were subjected to the temperature of liquid hydrogen—250° C.—and that upon being thawed their vitality was unimpaired. L. O. Howard treats of 'Flies and Typhoid Fever' and shows the danger of infection from several excreta-frequenting species and Edwin S. Crawley has an interesting article on 'Geometry: Ancient and Modern,' Huxley's 'Address given before the Anthropological Department of the British Association, 1878' is reprinted. It is not republished in his 'Collected Essays.' William Henry Hudson gives a brief abstract of the little known 'Story of Autonus' and 'The Economic Life of France' is considered by Edward D. Jones who notes the physical conditions of various portions of that country and their related industries. Pearson's 'Grammar of Science' is unfavorably criticized by C. S. Peirce in a series of annotations on the first three chapters, and in the instalment of 'Chapters on the Stars' Simon Newcomb discusses the structure of the heavens and the distribution of the stars. Under discussion and correspondence an editor utters a well-founded protest against needless obscurity in scientific publications.

THE opening article of *The American Naturalist* for December is on 'The Study of Mammalian Embryology,' by C. S. Minot, and is a preliminary publication of portion of a text-book on which the author has been at work for a considerable time. The general plan of the work is outlined and samples are given of the fine wood cuts with which it is to be illustrated. Henry F. Osborn presents a third paper on 'The Origin of the Mammalia: Occipital Condyles of Reptilian Tripartite Type,' the con-

clusion being that the reptilian tripartite origin of the mammalian condyle is more probable than the amphibian dicondylid origin. T. W. Galloway presents some 'Studies on the Cause of the Accelerating Effect of Heat upon Growth' giving the results of experiments upon the larvæ of various amphibians and showing that all the early developmental processes were accelerated. C. B. Davenport discusses 'The Variation of the Statoblasts of *Pectinatella magnifica*' and J. B. Johnston describes 'A Sealing Stone Jar for Zoological Laboratories' which seems very useful and is sealed with a heavy paraffin oil. The title page and index of the completed thirty-fourth volume are included in this number.

On January 1st appeared the first part of 'Geologisches Centralblatt, Revue Géologique, Geological Review,' edited by Dr. K. Keilhack, Bingerstrasse, 59, Wilmersdorf, Berlin, and published by Gebrüder Borntraeger, Leipzig, at an annual subscription of 30 Marks. The American agent is G. E. Stechert. The review is to appear on the 1st and 15th of each month, and is intended to give short, uncritical notifications of the latest publications in geology and allied sciences. The abstracts are written in German, French or English, according to the language in which the original papers have appeared. Since the contributors are to be compatriots of the respective authors, this renders their task easy; but the converse method would be of more advantage to scientific workers, and unless the German printers are more careful than they have been in the first number, even the English will be unintelligible to readers in this country. There can be no doubt as to the 'uncritical' nature of the notices; but this may be carried too far. It is to be hoped that authors, by contributing their own abstracts, will forestall some of the maugling to which they are otherwise liable.

It is interesting to note that in the numerous surveys of the nineteenth century, now being published, science usually occupies about half the space. This is in curious contrast to the slight attention paid by the newspapers to contemporary science and the carelessness with which scientific news is usually compiled.

Several of the daily papers have published very good historical surveys of the progress of science during the century; thus the New York *Evening Post* of January 12th, contains articles on astronomy by Professor Newcomb, on physics by Professor Lodge, on electricity by Professor Trowbridge, on medicine by Dr. Billings and other interesting articles. The New York *Sun* is also publishing a history of the nineteenth century in thirteen articles of which nine are on the science as follows: 'Evolution' (Dec. 23), by Alfred Russel Wallace; 'Chemistry' (Dec. 30), by Professor W. Ramsay; 'Archeology' (Jan. 6), by Professor Flinders-Petrie; 'Astronomy' (Jan. 13), by Sir Norman Lockyer; 'Philosophy' (Jan. 20), by Dr. Edward Caird; 'Medicine' (Jan. 27), by Professor William Osler; 'Surgery' (Feb. 3), by Professor W. W. Keen; 'Electricity' (Feb. 10), by Professor Elihu Thomson; 'Physics' (Feb. 17), by President F. C. Mendenhall.

#### SOCIETIES AND ACADEMIES.

##### ZOOLOGICAL CLUB OF THE UNIVERSITY OF CHICAGO.

At the meeting of November 14th, Mr. G. A. Allen reviewed a recent paper by Dunecker on variation in *Palemonetes*, and Miss Minnie Enteman recounted her observations on the behavior of *Polistes*. Some of the more important points of the latter paper may be mentioned here:

*Polistes*, our common paper wasp, constructs for a nest a single flat plate of hexagonal cells without an external covering. This renders observation of its habits and instincts very easy. Among the facts gathered concerning the activities characteristic of the larval, pupal and imaginal life, the most interesting relate to those of the newly excluded worker:

1. Fear is very generally exhibited, the young worker retreating precipitately when a strange object is presented to it. This gradually diminishes with the repeated appearance of the awe-inspiring object. If the bit presented is edible the worker will, after five or six trials, come up, touch it with the antennæ and exhibit

2. The feeding instinct. This consists in crushing the food in the mandibles, and ex-



tracting its juices, which are then swallowed by the worker. When the mass has reached a pulp like consistency it is distributed to the feeding larvae which occupy the cells of the nest. This habit has been thought to arise by imitation of the queen or an older worker, but that it is independent of such example is proved by the fact that it is acquired in all its perfection by wasps which have had no association with others of their kind.

3. The locality study. This is a mere desultory alternation of short flights and strolls, by means of which the wasp comes in contact with objects surrounding its nest. It appears to use these objects to some extent as landmarks, but experiments indicate that the olfactory sense is also an important factor in guiding it.

4. In a way the wasp remembers. This is indicated by its behavior when a change is made in its nest, and also by its accustoming itself to the appearance of strange objects.

5. Wasps learn nothing from one another. Instinct and individual experience account entirely for their complex activities, and their apparent cooperation is due to the accident of being born in the same nest.

At the session of November 28 Mr. C. M. Child gave a brief account of some zoological observations made during a recent trip to Florida, and showed a number of specimens.

Following this, Mr. E. R. Downing discussed 'Recent Experiments on Sea-Urchin Eggs,' referring chiefly to the work of Driesch.

The last session of the club for the autumn quarter was held December 12. This was devoted to a paper by Mr. C. C. Adams, entitled 'Geographical Distribution of Variations in *Io*.' The paper was illustrated by a number of lantern-slides, showing series of the shells from different localities.

The following abstract gives an outline of Mr. Adams's work on this form:

The gasteropod genus *Io* is found only in the headwaters of the Tennessee River and its tributaries. By the aid of a grant from the American Association for the Advancement of Science the Clinch and Powell Rivers were explored and the following facts concerning its geographical distribution and variations were discovered:

These shells are remarkably variable, all intermediates being found between a smooth shell (*Io fluviatilis* Say) and a very spinose shell (*Io spinosa* Lea). The extremes of variation do not occur promiscuously in all localities, but are quite definite in their occurrence. In the headwaters of both streams the smooth shells form the dominant population, but farther down stream, in the case of the Clinch River within 60 miles, the entire shell population changes from a smooth to a very spinose shell. In the intermediate region the shells are mixed, smooth, spiny and intermediate.

The headwater shells in the Powell are more globular and relatively stable, have low or no spines, distance between spines small and slightly variable. Down stream the shells are less globular and relatively variable, spines high and fairly stable, distance between spines wide and variable.

In the Clinch the headwater shells are more globular (similar to those in the head of the Powell) and relatively variable, low or no spines, distance between spines small and slightly variable. Down stream the shells are less globular and relatively stable, spines are high and variable, distance between spines wide and stable.

Thus these parallel streams have parallel differences in their *Io* shells.

C. M. CHILD,  
Secretary.

#### DISCUSSION AND CORRESPONDENCE.

THE U. S. NAVAL OBSERVATORY.

TO THE EDITOR OF SCIENCE: Every reader of SCIENCE must have been greatly interested in two recent editorials discussing the Naval Observatory at Washington and its work, but many of them will regret that where so much is said and so well said, the real meat of the controversy is left untouched, although in the last paragraph it seems to be 'scented.' Is it not true that the question in the minds of most thoughtful people is—what, in the name of reason is the use of having the Observatory for astronomical research under the Navy Department, any way?—why not just as well a geological survey? If this question be pertinent it cannot be impertinent and why do scientific

men continue to beat about the bush when they know exactly where the real quarry is?

A few years ago the pressure for a reformation in the management grew to considerable proportions and it was shrewdly met by the Navy Department in the scheme for an astronomical director. Many hopeful people without much experience rejoiced at this which they thought was a great step in the right direction. When a year or two ago the continued dissatisfaction had grown to the extent of demanding the appointment of committees by the American Association for the Advancement of Science and the Astrophysical Society, it was again as shrewdly encountered by the appointment, by the Secretary of the Navy, of the Board of Visitors whose report is unhappily meeting with criticism fore and aft. A distinguished statesman whose loyalty to the interests of the Navy Department has long been known was made chairman of this Board and it is an open secret that he peremptorily cut off all suggestions looking to the real emancipation of this great institution.

The scientific members of the Board, all most excellent astronomers, but possibly not well informed as to the methods sometimes resorted to by great statesmen, were restricted in the recommendations to proposals for repair rather than reconstruction. In spite of their limitations they succeeded in getting in a most interesting and valuable report—one in which symptoms are admirably set forth, although there is 'much silence' as to the real nature of the complaints. Is it not perfectly true that the Naval Observatory, as such, has been of little value to astronomical science, although *astronomers* attached to the establishment have contributed greatly to the glory of American science? But this is in spite of, not on account of the character of the administration of the Observatory. This administration is and must always be, and properly so, while it is under the Navy Department, military in its character. The utter incompatibility of this sort of control and direction with the best interests of scientific research needs no demonstration. The very existence of a comfortable retiring pension for astronomers who survive their sixty-second year has been unfortunate in its results, in that it has led to the ap-

pointment, through the use of influence, other than that of merit, of men whose principal ambition was old age under these conditions. Why should a regularly appointed astronomer be detailed as inspector of apparatus for fire protection at the Navy yards? What would be thought of a civil establishment which detailed one of its best paid professors of astronomy to the duties of superintendent of grounds and buildings? M.

#### REPRODUCTION OF DIFFRACTION GRATINGS.

TO THE EDITOR OF SCIENCE: The communication of Professor R. W. Wood in your issue of January 4th (p. 33), concerning diffraction gratings, is of interest to me. I have, during the past year, made some experiments on the reproduction of gratings. Obtaining through the kindness of Professor Rowland and Mr. Schneider, a fine flat glass grating, it was silvered on its face in a silvering solution, then electroplated with silver and afterward with a heavy coat of copper. With care it could be readily removed from the glass especially if warmed. I had used the process to make concave mirrors from lens surfaces about six or seven years ago and the results were excellent, even the most minute scratches or imperfections of the glass appearing in the silvered surface with the utmost fidelity, while the polish and brilliancy was such that one could scarcely believe that the surface was not one of glass instead of polished metal. With the glass grating the experiments gave excellent reproductions of the ruling and great brilliancy, but the surface of the metal grating was not optically flat but slightly warped. This condition varied in different trials and the result would probably have been more perfect if the temperatures during the electro-depositing had been maintained rigorously the same.

It is possible that had the glass been convex the resultant concave grating would have been without distortion. Lack of time has so far prevented my trying another expedient which ought to give good results. It is to first silver the glass grating as before, then, having coated a flat glass surface with a thin layer of adhesive cement, like hard pitch or shellac warmed, or with a cement like glycerine and litharge which

sets firmly, apply this to the silver surface and allow it to harden. It should then be easy to remove the silver grating from the glass grating and the reproduction should have all the gloss and accuracy of the surface serving as the matrix. My interest in the matter was the possibility of easily and rapidly obtaining fairly good gratings without great expense, so that students in laboratories might use them without restraint. From one good glass grating numerous reproductions could be had at any time.

ELIHU THOMSON.

SWAMPSCOTT, MASS.,

Jan. 5, 1901.

*THE FRICTIONAL EFFECT OF RAILWAY TRAINS ON THE AIR.*

AN interesting and in some respects exceptionally important paper, read by Professor F. E. Nipher before the St. Louis Academy of Science has just been published by that Society in its transactions.\* In this paper, the results of an experimental investigation of the effect of railway trains in the production of air-currents, and in causing the motion of adjacent bodies, are given with tabulated and diagrammed data. The effect of a rapidly moving express-train in producing strong air-currents is familiar to all who have seen anything of that kind of train-service, and the results of action of these fast-moving currents in overturning and in transporting objects near the track are hardly less familiar; but this is the first investigation conducted in a scientific and satisfactory manner to determine the quantitative measures of such effects. The stimulus to this particular research seems to have been the denial, by the Supreme Court of Missouri, that such effects are or can be produced.†

The station agents of all the great trunk-lines

\* *The Frictional Effect of Railway Trains upon the Air*; Francis E. Nipher. *Trans. Acad. of Science of St. Louis*; Vol. X., No. 10. Issued Nov. 12, 1900.

† "When the case was tried a second time, and again resulted in a verdict against the company, the Supreme Court attacked the experts it had approved in the first reversal and threw out their uncontested evidence. \* \* \* The Supreme Court of Missouri decides that the physical laws of the universe do not exist, so far as that august assemblage is concerned."

—*St. Louis Mirror*, November 29, 1900.

of railway over which fast trains are operated are invariably cautioned regarding this danger and are careful to warn people against standing near the track when an express train passes. Small articles, and especially bulky and light merchandise, may often be seen to move under the 'suction' so produced, and, in the case referred to, a boy standing near the track, awaiting the passing of the coming fast train, and about to cross, was overthrown and rolled under the wheels and killed. The evidence showed that he was not struck by the train and the upper part of his body was not bruised. 'He fell after part of the train had passed.' The Court, however, repudiated the evidence of two scientific men of recognized attainments and distinction, testifying to the existence of known facts and to the probability of the claim of the plaintiffs in the case. The outcome of this doubt of the evidence was the employment by Mr. Nipher of a large part of the succeeding summer in the investigations here recorded, which were carried on, on the various roads leading out of St. Louis to Burlington, Chicago and Cairo. The Illinois Central Railroad finally fitted up a special car for the work; this was employed in securing the larger part of the information published.

The difference of pressure was taken between the interior of the car and some one point, selected by the observer, in making a series of observations from contact with the side of the car to a stratum several feet from the side, and the successive differences of pressure constitute measures of the varying tendency to carry along loose bodies near the track and of the tendency, also, to rotate them. A cup-shaped collector was used and the Newtonian equation was adopted. The coefficient, for pounds per square foot and miles per hour, was found to be 0.0025, very nearly, without wind. Still air is only reached at distances of sometimes many feet from the side of the train. The curve of varying pressures relatively to the car was found to be, as plotted, approximately hyperbolic, the vertical asymptote finding its position a short distance inside the car. The pressures measured range from 3.4 to 6 pounds on the square foot, at distances of 0 to 30 inches from the side of the car; the mean speed being 38 to 46, usually about 40, miles an hour; at which speed the

head-pressure relatively to the earth would be about four pounds per square foot. Light winds, sometimes following, sometimes resisting, the train, caused some variations which were allowed for in computations.

It is to be noted that a plane surface would have given a higher resistance, by at least 50 per cent., than was recorded by the cup-shaped vane.

R. H. T.

#### TRIVALENT CARBON.

IN the *Journal of the American Chemical Society* for November appeared an article of very unusual interest. By the action of silver, mercury or zinc on triphenylchloromethane Dr. M. Gomberg has obtained a new hydrocarbon, *triphenyl-methyl*,  $(C_6H_5)_3C$ . For some reason, perhaps because of space relations involved, two molecules of this hydrocarbon do not unite to form hexaphenylethane,  $(C_6H_5)_2C - C(C_6H_5)_3$ , as would be expected. The new body is the only one among the seventy thousand or more compounds of carbon, which contains an odd number of atoms of odd valence. The compound furnishes the first opportunity of studying the properties of a substance containing a carbon atom that is almost certainly trivalent. From this standpoint, as well as others, the discovery possesses a great theoretical interest. Especially the properties of triphenyl methyl in its rapid absorption of oxygen furnish a practically complete refutation of the view that benzene, ethylene and similar compounds contain trivalent carbon.

W. A. N.

#### COLUMBIA UNIVERSITY.

THE trustees of Columbia University have authorized the publication of the following statement drawn up by President Low:

The problem of Columbia University can now be defined, for the first time since, in 1892, it was determined to move to Morningside Heights.

Cost of land and development at Morningside Heights, .....	\$6,516,300 17
Improvements at College of Physicians and Surgeons, .....	879,688 43
	<hr/>
	\$7,395,988 60
Interest to June 30, 1900, .....	586,519 92
	<hr/>
	\$7,982,508 52

Of this large sum the University has succeeded in paying, mostly out of gifts and legacies, \$4,250,000. Of its outstanding debt the sum of \$750,000 is provided for. It still owes \$3,000,000 that is not provided for; upon which the annual interest payable is \$98,500.

Careful computations justify the undersigned in saying that eight years from now the University will be able, by the increase of income from its fees and endowments to care for its floating debt without embarrassment to its educational work. The falling in of contingent interests already definitely established may hasten this result importantly. Experience also demonstrates that the endowments of the University are likely to be constantly increased by gift and legacy year by year.

The problem of the University, therefore, is to conduct its educational work for a period of eight years without curtailment by reason of the interest to be paid in the meanwhile on its outstanding debt, say \$100,000 a year.

For the academic year ending June 30, 1897, the last year at the 49th street site, the University had a deficiency on its current educational account, disregarding interest, of \$48,260. For the coming academic year, 1901-1902, the estimates for the Budget already made show that the ordinary income of the University next year will pay all of its current expenses except the interest on its outstanding debt.

If our interest payable can be taken care of for eight years, the problem of the University growing out of its removal to the new site will be solved.

From the purely business point of view, the operations of the University have been already justified. Its plant has been increased in value, after deducting the proceeds of its old buildings, by more than \$6,250,000, taking its new site at cost. If the new site be taken at its present market value, the increase in the value of the University's plant would be not less than \$8,000,000. The debt incurred in producing these results, still remaining unprovided for, is only \$3,000,000. In addition, University Hall is now being enlarged by gift; and Earl Hall is about to be erected, also by gift. In the same interval, the trust funds of the University have been increased by \$1,250,000.

000; the library has grown from 120,000 volumes to over 300,000 volumes; the teaching force from 226 to 361; and the number of students from 1,564 to 2,560. These figures do not include either Barnard College or Teachers College.

Since removal, also, an educational deficiency of more than \$48,000 has been overcome, and the University, after this academic year, will be running within its income, after assuming the full care of its enlarged plant.

For a few years and for a few years only, the University needs help to prevent its debt from being further swelled by borrowed interest. It is not possible to take any such sum as the University needs, annually, in the immediate future, out of its educational work, without destroying its efficiency. This ought not to be permitted: First, because the work is highly useful and is being economically and well done; second, because any curtailing of the University's educational offer would be reflected immediately in loss of earning power; and, third, because, for the credit of the city, the University must be kept where it now is, in the very front rank.

To meet this situation, appeal is made to all the friends of the higher education in New York. Friends of the University, including the President and Trustees, have already pledged \$38,000 for this purpose. For the rest, the University confidently turns to the citizens of New York who value the things for which Columbia University stands in this metropolitan city.

#### REPORT ON A WESTERN BRANCH OF THE AMERICAN SOCIETY OF NATURALISTS.

As we have already announced, the American Society of Naturalists decided to meet next year at Chicago, and the Council was requested to report on the relations of the Society to the Western Branch, which has held two successful meetings in that city. Prior to this decision a committee consisting of Professors Henry Kraemer, G. D. Macloskie, E. B. Wilson, C. B. Davenport and T. H. Morgan made a report which we publish, in order that men of science may have an opportunity to consider and discuss a problem of considerable importance. The report of the committee is as follows:

The Committee appointed to consider the proposition offered by some of the members of the American Society of Naturalists to form a Western Branch of this Society (See Records of A. S. N., p. 29) submit the following recommendations for the action of the Society:

1. The American Society of Naturalists appreciates the desire of some of the Western members to form a Society of the Central States and, furthermore, appreciates the motives of the members to make this new Society a branch of the American Society of Naturalists. It is doubtful, however, if it will be possible to form such a branch, and if such a society is formed, we believe it should be as a distinct organization having its own officers, control of its own finances and the publishing of its own records.

2. The original intention of the Society of Naturalists was a good one, but we believe that it was unfortunate in changing its name from 'Society of Naturalists of the Eastern United States' to 'American Society of Naturalists' and in limiting the meetings to the Eastern United States. We recommend, therefore, that the original name be readopted in place of the present name. We believe this action would tend to facilitate the formation of similar societies, if desired, in different parts of the United States, and be in accord with the inception principles of this Society.

3. It is further recommended, in order to strengthen the work of naturalists in the United States, and so add to the influence of the whole body of naturalists in this country, that, if a Society of Naturalists of the Central United States be formed, or any similar society, if possible, each society appoint delegates to represent it at the Annual Meeting of the Sister Society; that the Executive Committee of the one cooperate with the Executive Committee of the other for united effort in contributing to the support of different objects such as the Naples and Wood's Holl Biological Stations; and that the societies extend to each other mutual privileges and courtesies such as: (a) Change in membership from one society to the other by approval of the Executive Board of both societies; (b) Admission of members of both societies to the meetings of either society, with enjoyment of certain privileges such as the reading of papers, taking part in the discussions and participation in such other matters as may be deemed advisable.

#### SCIENTIFIC NOTES AND NEWS.

MR. JOSEPH WHITE SPRAGUE, of Louisville, Ky., who died recently in Switzerland, left a will that should ultimately greatly benefit the

Smithsonian Institution. It gives 85 per cent. of the interest on the estate to relatives for life. On their death the entire property, increased by 15 per cent. of the income to be laid by each year, is held in trust for twenty years, and then reverts to the Smithsonian Institution. One-half of the annual income is then to be added to the principal each year, and the other half is to be used for the advancement of the physical sciences by prizes, lectures or original research. It is estimated that the fund now is worth \$200,000, and that it will be available in about fifty years.

A BILL has been introduced in the House of Representatives directing the general government, through the Secretary of the Interior, to secure title to the cliff dwellers' region of New Mexico for park and scientific purposes, and one in the Senate appropriating \$5,000,000 for the purchase of land in the Appalachian Mountains for a national forest reserve.

THE Washington Academy of Sciences is endeavoring to secure a permanent home for the Academy and the nine local societies which are affiliated with it. A lot has been purchased on 15th Street, between L and M Streets, northwest. It is hoped that funds enough can be secured to warrant the erection of a building containing a large hall for various public meetings and small rooms for the different purposes of the various societies.

DR. H. R. MILL will, as we learn from *Nature*, join Mr. Sowerby-Wallace in carrying on the British Rainfall Organization, in continuation of the work of the late Mr. G. J. Symons.

WE regret to learn that the *Philadelphia Medical Journal* will no longer be edited by Dr. George M. Gould. The Journal has been edited by Dr. Gould since its establishment and has been made by him one of the half-dozen valuable medical journals of the United States.

IN commenting on the election of Professor W. W. Campbell to the directorship of the Lick Observatory, the *Astrophysical Journal* says: "The wisdom of this choice will be apparent to every one familiar with the circumstances of the case. The task which falls to the successor of Professor Keeler is no easy one, a fact which the Observatory Committee fully appreciated.

They accordingly deferred action until the opinions of many eminent astronomers in this country and abroad could be secured. The replies, almost without exception, named Professor Campbell as first choice. It is evident that his remarkable success as an investigator, his tireless energy and his ability to direct the works of others are widely known and appreciated. It is a pleasure to extend congratulations to the President and Regents of the University of California for the wise manner in which the appointment was made; to the Lick Observatory for its bright prospects under such leadership, and to Professor Campbell himself for the wider opportunity in the prosecution of his researches which he will now enjoy."

DR. W. WALDEYER, professor of anatomy at Berlin, has been elected a member of the Moscow Natural History Society.

It is understood that Lord Kelvin will give an address on the textile industries at the annual dinner of the governors of Yorkshire College, on February 1st.

A MARBLE bust of Friedrich Gustav Gauss is to be made and placed in the lecture room for geodesy and mathematics at the University of Berlin.

THE death is announced on December 30th of Mr. William Pole, F.R.S., formerly professor of civil engineering in University College, London, an eminent writer on engineering subjects and an active member of a number of Government commissions of inquiry. He was a man of wide interests, being a gifted musician and student of music and the author of the well-known 'Evolution of Whist.'

WE also regret to learn of the death of Mr. Philip Crawley, fellow of the Zoological and Linnean Societies of London, and the possessor of collections of birds' eggs and butterflies, said to be among the finest in the world; of Mr. F. R. Bedford, a young English zoologist, known for his studies on the echinoderms, and of Senhor Cordeiro, Secretary of the Portuguese Geographical Society.

THE Chicago Medical Society has adopted a resolution protesting against the duty of 20 per cent. on pathological specimens.

IN accordance with the recommendation of Governor Odell, a bill has been introduced in the New York Assembly abolishing the present Forest Preserve Board and transferring its duties to a Forest, Fish and Game Commission. This Commission would have a president with a salary of \$5,000 and two other members appointed from the commissioners of the Land Office without extra salary.

As a part of the work of the Geological Survey in Alaska this year, an arctic party will proceed from Bergman on the Koyukuk River by the Allen Kakat River to the divide, then down some stream to the arctic coast and along the coast southward and westward. Another party will go westward from Bergman down the Kowak River to Kotzebue Sound. Another party will continue investigation of the Copper River region.

We learn from the *Irish Naturalist* that Professor A. C. Haddon, and Messrs. H. J. Seymour, R. L. Praeger and Halbert, have been investigating the Cave of Dunmore in County Kilkenny, Ireland, both as regards its geology and its past and present fauna, and have taken a number of the small animals which render the Mitchelstown cave so interesting.

A COLLECTION of marine, fresh-water and land shells, made by the late Sir James Emerson Tennent, Governor of Ceylon, has been presented to the Municipal Museum of Belfast, Ireland, by the executors of the late George Horner, who had purchased it from a previous owner.

THE HON. E. S. Converse has given \$125,000 for an endowment fund for the Malden Public Library, established by him.

THE daily papers report that the Finlay theory of the propagation of yellow fever by mosquitoes has been further confirmed by the commission now studying the subject in Cuba. Cable dispatches state that a monkey which had been bitten by an infected mosquito developed on the fourth day well-marked symptoms; that of six non-immunes bitten by mosquitoes which had previously bitten yellow fever patients, five developed yellow fever, while subjects who slept in infected clothing

and bedding, but were guarded from mosquitoes, were untouched.

THE plague has broken out at Vladivostock with nineteen cases of which fifteen have been fatal.

ON the afternoon of December 7, 1900, there passed over northern Colorado and southern Wyoming a magnificent fireball, which was so brilliant that some observers described it as rivaling the sun. It exploded when passing over North Park, Colorado, its detonations inspiring animals with terror and startling people. Some reports state that the earth was shaken and windows in houses broken. The Chamberlin Observatory has sent circulars broadcast over the State and has utilized the newspapers thoroughly in an endeavor to gather information. The data obtained have been placed in the hands of Miss Lela L. Stingley, of the University of Denver, for discussion and publication.

MR. A. G. S. JOSEPHSON, of the John Crerar Library, submitted, at a recent meeting of the Bibliographical Society, of Chicago, a plan for a complete bibliography of American literature on cards, thus making it possible to issue to subscribers, during the course of its preparation, cards for either the whole work or for any part thereof. The plan provides for the organization of a Bibliographical Institute, either specially endowed or supported by contributions from scientific societies and institutions. The Society voted that a committee of three be appointed to consider ways and means for carrying out the plan, and the President, Professor Camillo von Kleuze, appointed as members of the committee Messrs. Clement W. Andrews, Frederick H. Hild and Carl B. Roden.

IN the spring of last year the London *Times* published a series of articles on American engineering competition that attracted much attention. The articles are now being continued, and it is sought to explain the growing place taken by American manufactures throughout the world, including Great Britain. Apart from the natural resources, the chief factors are said to be the placing of young men in charge of important enterprises and the educational methods. The technical schools, though highly

praised, are said to be no better than those in Great Britain, but in regard to secondary education the article proceeds: "So far as I can see, the American system is more truly educational, less pedagogic; the child is made to learn, I will not say things that are useful, but things that more develop his intelligence and reasoning faculties. I think any average Englishman of middle age, whether of a public or private school, who looks back on his school days must be struck by the vast amount of time and tears he spent in acquiring knowledge which he has entirely forgotten. "But the acquiring of this knowledge," it is said, "has developed his reasoning powers and strengthened his memory." The latter, no doubt, is true, and no one would undervalue memory. But the memory so acquired is of a description that is the least useful in the business affairs of life. Let us take a single example. Perhaps the most marvelous exhibition of memory is that displayed by players of blindfold chess; but who would select a man, because he was an expert in this science, to conduct a business? In regard to the claim of development of reasoning powers, it may be that the absolute reverse is the truth, and to learn by rote things that have no meaning to the learner is possibly the surest way to stunt the intellect. The most valuable intellectual gift a man can possess—I speak with all deference, not as an educationist, but as an engineer—is the power of concentrating his mind on the problem immediately before him; and the learning of meaningless or objectless things—they need only be meaningless or objectless to the learner—is the surest way to cultivate a discursive mental habit. Let any one who doubts this watch an average school boy getting by rote a Greek verb or any other lesson equally empirical. The most trifling incident will distract his attention, and that not from wilfulness, for the penalty of not knowing his lesson has many real terrors. Educational methods, I know, have improved and are still improving in this country, but when all is said I attribute the greater mental alertness of Americans, especially American middle-class youths, to the lead that American schools have taken in this respect.

#### UNIVERSITY AND EDUCATIONAL NEWS.

ACCORDING to press despatches, Professor E. A. Ross, lately professor of sociology at Leland Stanford Junior University, has been appointed professor in the University of Nebraska and Professors G. E. Howard (history), William H. Hudson (English literature) and G. N. Little (mathematics) have resigned their chairs at Stanford University.

THE latest benefaction of Dr. B. K. Pearsons's is reported to be \$200,000 for Beloit College, conditional on the raising of \$150,000 more by June 15th.

WARREN A. WILBUR, of South Bethlehem, has given \$5,000 to Lehigh University for the equipment of a mechanical laboratory.

AN anonymous gift of £50,000 has been made to the Woman's Agricultural College at Reading, England.

IN order to limit the crowding of the medical profession in Germany, the Government has introduced a bill regulating entrance to the medical profession, prolonging the period of study to five years and enlarging the subjects upon which the examinations are based.

THE Agricultural School at Berlin has been injured by fire due to an explosion of gas. The loss is estimated at \$15,000, in addition to the destruction of valuable collections.

DR. WINTHROP ELLSWORTH STONE has been elected president of Purdue University. He has been professor of chemistry in the institution since 1889, and vice-president since 1892.

It is said that Dr. George Edgar Vincent, professor of sociology at the University of Chicago, has been offered the presidency of Northwestern University.

MISS LAURA D. GILL, A.B., A.M. (Smith College), has been appointed dean of Barnard College, Columbia University.

DR. JOHN E. WEEKS has been appointed to the professorship of ophthalmology in the New York University and Bellevue Hospital Medical College made vacant by the death of Dr. Henry D. Noyes.

AUSTIN M. PATTERSON, A.B., (Princeton), Ph.D. (John Hopkins), has been appointed instructor in chemistry in Centre College, Ky.



# SCIENCE

A WEEKLY JOURNAL DEVOTED TO THE ADVANCEMENT OF SCIENCE, PUBLISHING THE OFFICIAL NOTICES AND PROCEEDINGS OF THE AMERICAN ASSOCIATION FOR THE ADVANCEMENT OF SCIENCE.

EDITORIAL COMMITTEE: S. NEWCOMB, Mathematics; R. S. WOODWARD, Mechanics; E. C. PICKERING, Astronomy; T. C. MENDENHALL, Physics; R. H. THURSTON, Engineering; IRA RENSEN, Chemistry; JOSEPH LE CONTE, Geology; W. M. DAVIS, Physiography; HENRY F. OSBORN, Paleontology; W. K. BROOKS, C. HART MERRIAM, Zoology; S. H. SCUDDER, Entomology; C. E. BESSEY, N. L. BRITTON, Botany; C. S. MINOT, Embryology, Histology; H. P. BOWDITCH, Physiology; J. S. BILLINGS, Hygiene; WILLIAM H. WELCH, Pathology; J. MCKEEN CATTELL, Psychology; J. W. POWELL, Anthropology.

FRIDAY, JANUARY 25, 1901.

THE ORIGIN, SCOPE AND SIGNIFICANCE OF BACTERIOLOGY.\*

## CONTENTS:

<i>The Origin, Scope and Significance of Bacteriology:</i> PROFESSOR WM. T. SEDGWICK.....	121
<i>Certain Stroboscopic Phenomena in the End-on Projection of a Single Wave:</i> PROFESSOR CARL BARUS.....	128
<i>The International Geodetic Association:</i> ISAAC WINSTON.....	129
<i>The Albany Meeting of the Geological Society of America (II.):</i> PROFESSOR J. F. KEMP.....	133
<i>Anthropology at Baltimore:</i> PROFESSOR FRANK RUSSELL.....	139
<i>Leland Stanford Junior University.....</i>	142
<i>Scientific Books:—</i>	
<i>Schäfer's Text-Book of Physiology:</i> G. N. I. S. FRENKEL'S <i>Die Lehre vom Skelet des Menschen:</i> PROFESSOR THOMAS DWIGHT. <i>Bolton on the Evolution of the Thermometer:</i> J. L. H. Books Received.....	144
<i>Scientific Journals and Articles.....</i>	147
<i>Societies and Academies:—</i>	
<i>Section of Astronomy, Physics and Chemistry of the New York Academy of Sciences:</i> DR. WM. S. DAY. <i>The Chemical Society of Washington:</i> DR. W. H. KRUG. <i>The Philosophical Society of Washington:</i> C. K. WEAD.....	148
<i>Discussion and Correspondence:—</i>	
<i>Whose Fault at the U. S. Naval Observatory:</i> DR. FRANK H. BIGELOW. <i>Potassium Nitrate in Wyoming:</i> PROFESSOR WILBUR C. KNIGHT...	150
<i>Current Notes on Physiography:—</i>	
<i>Southern Wisconsin; The Islands of Southern California; Deecke's Italien; Norway:</i> PROFESSOR W. M. DAVIS.....	152
<i>United States Board on Geographic Names.....</i>	153
<i>Scientific Notes and News.....</i>	154
<i>University and Educational News.....</i>	159

BACTERIOLOGY is a child of the 19th century. It is the offspring of chemistry and biology, enriched by physics with the gift of the achromatic microscope.

By the end of the first quarter of the century, natural philosophy, natural history and chemistry had almost wholly displaced the magic and alchemy of the Middle Ages and the Renaissance. Natural law was the explanation indicated by natural knowledge for natural phenomena, and in most cases a natural explanation of these phenomena was either discoverable or conceivable. The Copernican theory, as developed by Galileo, Kepler, Newton and their successors, accounted satisfactorily for the obvious structure and operation of the solar system. The researches of Vesalius and Harvey, and their successors, had made comprehensible the anatomy and physiology of the animal body. The earth, in response to the inquiries of Hutton and Lyell, was yielding up the record of its slow but sublime history, its very rocks bearing eloquent testimony to their natural origin. "The lightning of heaven, the thunderbolt of Zeus, interrogated by our own Franklin, had confessed its affinity

\* Address delivered by the president before the Society of American Bacteriologists, Baltimore, December 27, 1900.

MSS. intended for publication and books, etc., intended for review should be sent to the responsible editor, Professor J. McKee Cattell, Garrison-on-Hudson, N. Y.

to the humbler electricity of glass and amber. Everywhere the growth of natural knowledge revealed always more and more of natural law. Magic and mystery in the greater part of the macrocosm and microcosm were no more. Alchemy, the philosophers' stoue and the transmutation of metals were gone forever. Yet even as late as 1835 there still remained one large group of familiar natural phenomena which was neither understood nor explained.

*Fermentation*, and especially alcoholic fermentation, had long excited the wonder of the ignorant, the curiosity of the wise. Fermentation was obviously the seat of active, spontaneous, self-regulated change. Its bubbling had given to it the name, which comes from the Latin *fervere*, to boil. Yeast was the constant accompaniment of the alcoholic fermentation, but exactly what yeast was no one knew. At best it seemed to be a consequence rather than a cause of fermentation, since it was more abundant at the end than at the beginning, more abundant in the later and less active stages than in the earlier and more active. Leuwenhoeck indeed had examined yeast microscopically and found in it what seemed to be living cells, but his discovery appears to have occasioned no great surprise and to have been virtually forgotten after the lapse of a hundred and fifty years. The bubbling or boiling of the alcoholic fermentation suggested the action of acid on limestone, but as there was no limestone present and very little acid the suggestion explained nothing and was not very helpful. Chemistry had dealt with the alcoholic fermentation, and had come to the conclusion, based upon analyses and experiments, that it was a purely chemical process, in which sugar was decomposed wholly into alcohol and carbonic acid, the cause of the decomposition being the aggressive action of the oxygen of the air.

These were the days in which oxygen

was much in fashion, for it had been only recently discovered by Priestley in 1774, and it was perhaps natural that Gay Lussac, reflecting upon the successful experiments by Appert in preserving foods by canning, should have concluded that it was the exclusion of the atmospheric oxygen from the tins which prevented fermentation of the fruit juices which they contained. He was confirmed in this opinion by his own experiment upon grape juice in the Torricellian vacuum, and his theory was, naturally enough, accepted and extended by his pupil Liebig. There were not wanting, however, objectors to this theory, nor experiments which seemed to disprove it, and it was never very satisfactory because it failed to account adequately, not only for the constant presence and growth of yeast—for which no provision was made in Gay Lussac's formula,—but also because of the total absence of oxygen in the most active stages of alcoholic fermentation as conducted in breweries, etc. For most persons, therefore, fermentation was still an unsolved problem when, in 1836, Schulze completely disproved the oxygen theory by showing that ordinary air, such as had been excluded in the experiments of Appert and Gay Lussac, was unable, even if admitted, to produce fermentation if it had first been caused to bubble slowly through concentrated sulphuric acid which, whatever else it might do, certainly could not deprive it of oxygen.

*Putrefaction* was another unsolved problem in nature, not only at the beginning of this century, but as late as 1835. It obviously resembled fermentation in some respects, and had often been classified with it, but yet it was also obviously different. Bubbling was not always an accompaniment of it, and the microscopes of the day, comparatively poor as they were, had revealed the almost constant presence in putrefactions of swarms of microscopic

forms of life roughly classified as 'animalcules.' These were either not present at all in the alcoholic fermentation or, if present, were few in number. Moreover, in this case also, the microscopic life seemed to be a consequence rather than a cause of putrefaction, inasmuch as it was most abundant, not at the beginning, but toward the end of the process. Meat kept in warm air or warm water soon 'spoiled,' though exactly how or why no one knew. Chemical changes were obvious and abundant, but of a totally different kind from those characterizing the fermentation of alcohol or vinegar.

*Organic decomposition and decay*, two of the most widespread and universal processes in nature, while occurring on every hand, were in the early part of our century either not understood or else incorrectly interpreted. The slow decay of timber and of teeth, the rapid decay of fruits and flowers, sometimes, it is true, suggested putrefactions, but quite as often went on almost insidiously and unobserved. Even after the first quarter of our century had gone by, slow decay was given a very large name, *eremacausis*, but yet was only imperfectly understood. The current explanation, such as it was, was in harmony with the few facts established by chemistry, viz., a theory of oxidation probably produced by the aggressive energy of free oxygen. Iron rusted readily enough; why should not wood and teeth and fruits 'rust' also in a somewhat different, but still essentially similar, way. This hypothesis seemed to be confirmed by the fact that canned fruits and foods were preserved so long as air was excluded from them, but spoiled soon after being exposed to the atmosphere. It was not observed, or if observed it was forgotten or believed to be immaterial, that meat and fish and fruits could be equally well preserved for an indefinite length of time by simple drying, although remaining constantly exposed in the dry condition to

the aggressive action of the free oxygen of the air.

*Nitrification*, or the conversion of nitrogenous organic matter into mineral nitrates, was well known in the early part of our century as one of the most fundamental processes in nature and of prime importance in agriculture; manures, for example, being nitrified before they could become fit food for green plants. Precisely how this nitrification was effected, however, was not known, although it was suggested that free oxygen somehow oxidized organic nitrogen by a process similar to that in which it attacks iron. Obviously, this process went on best, if not exclusively, in the soil, for organic nitrogen elsewhere showed little or no tendency to unite with oxygen to form nitrates. The soil seemed to have some peculiar property of favoring this oxidation, but exactly what this property could be, unless it were a kind of platinum-sponge effect, was by no means clear even to the most eminent chemists and naturalists.

*Natural 'heating' and 'sweating'* were processes familiar enough to all observers of natural phenomena, but exactly what they meant no one in the early part of our century knew. Hay, imperfectly cured, heated and even rotted in the barn. Manure, collected in heaps, underwent a spontaneous and peculiar change by which it was altered or ripened, sometimes becoming intensely hot and giving off vapors which indicated profound and important chemical changes. Flax, in the course of the preparation of linen fiber, was made to undergo a peculiar maceration or change which must have suggested fermentation or decay and was known as rotting or 'retting.' Hides, in the peculiar and primitive processes preliminary to tanning, often underwent a similar change known as 'drenching.' Tobacco 'sweated,' and milk 'soured,' spontaneously. Cider 'turned' into vinegar, grape-juice into wine, and in various other domestic or indus-

trial processes advantage was taken of 'spontaneous' changes of highly peculiar and unexplained characteristics.

*Contemporary spontaneous generation*, in the first half of our century, was commonly accepted as a fact even by many scientific men, who held that it was the simplest explanation of the origin of the swarms of microscopic organisms observed in putrefying liquids or infusion. The belief in easy and constant spontaneous generation of living from lifeless matter is probably as old as the human race, and if we bear in mind the ignorance which was universal concerning the nature and complexity of even the simplest forms of life, and the complete lack of trustworthy evidence such as we have to-day against the theory of present-day abiogenesis, we can not wonder that this theory should have been so recently and so widely held. It is true that some of the most acute observers, such as Leeuwenhoek, had utterly refused to accept the theory, arguing that the total absence of abiogenesis in the higher forms of life made its occurrence in the lowest forms highly improbable, but we must admit that in these cases their conclusions were based rather upon instinct than scientific evidence. Granting, as we must, the theoretical possibility, and perhaps probability, of this process in the primordial origin of life upon our globe, we may well be slow to condemn those who leaned toward the theory of modern spontaneous generation as the most reasonable explanation of the myriad life of to-day in the under microscopic world. At the same time it can hardly be doubted that the belief in present-day spontaneous generation represented the last survival of such traces of belief in magic, alchemy, and the transmutation of metals, as the nineteenth century inherited from its predecessors.

In the early part of our century there was a group of natural phenomena of a

different order, which, though painfully familiar, was equally puzzling and mysterious. Seemingly spontaneous in origin, always inexplicable, erratic and mysterious in transmission, often swift in operation and fatally destructive to human life, the mysterious phenomena known as *epidemics, plagues and pestilences* were among the most dreaded of all natural occurrences. Many indeed still spoke of them as 'visitations of the Almighty,' and treated them as if they were of superhuman origin, but Dr. William Farr, in preparing a classification of diseases for the purposes of the registration of vital statistics—made for the first time in history on a large scale in England in 1839—recorded epidemics, plagues and pestilences as strictly natural phenomena, though obscure, and while specifically denying any intention of considering them as fermentations, almost unconsciously acknowledged their affinity to fermentations by the name which he applied to them, and under which they have ever since been known, viz., the 'zymotic' or fermentative diseases. Dr. Farr gives no theory of their origin or causation and expressly declines to regard them as fermentations, partly, no doubt, because of the vehemence of Liebig, who was opposed to the idea, but also, we may believe, because the prevailing theory of the cause of fermentation was that it was due to the aggressive energy of free oxygen; and it would have been obviously too absurd to assert that free oxygen, the very breath of human life, is at the same time the cause of its worst diseases. In Germany, Henle arrived, largely from observation and *a priori* reasoning, at a conclusion essentially similar to Dr. Farr's, and, in America, Professor J. K. Mitchell, father of our distinguished physiologist and litterateur, Dr. Weir Mitchell, was urging, upon similar grounds, his able thesis 'On the Cryptogamous Origin of Malarious and Epidemic Fevers.'

To recapitulate.—While, in the first half of our century, the anatomy and physiology of the macrocosm and the microcosm, the heavens, the earth and man, were fairly well understood, there yet remained certain important natural phenomena either generally not understood at all or else, as we know, almost completely misinterpreted, namely, as follows :

1. Fermentation of every kind.
2. Putrefactions.
3. Organic decomposition and decay.
4. Nitrification.
5. The origin of microscopic life.
6. Zymotic diseases.

The end of the third decade of our century saw the beginning of a profound change in the accepted theories concerning all or nearly all of these phenomena. In 1836, Schulze proved that the oxygen theory of fermentation could not be correct. The next year Theodor Schwann confirmed his results by a different experiment, and by the improved achromatic microscope not only discovered, or rediscovered, the yeast plant, but also boldly asserted that the life and growth of this plant was the cause, and not the consequence, of the alcoholic fermentation. Thus, based on solid grounds, began the biological or germ theory of fermentation of which Schwann is entitled to be regarded as the founder, precisely as Pasteur some twenty years later became the founder of its direct descendant, the germ theory of disease. Confirmed or even slightly anticipated by Latour in his discovery of the living and vegetable character of yeast; supported by Helmholtz and Mitscherlich in his assertion that no alcoholic fermentation of sugar ordinarily occurs except as caused by yeast; and by Schroeder and Von Dusch in his claim that the cause of fermentation and putrefaction in boiled liquids is not air, but floating matters in the air; Schwann is entitled to be regarded as the immediate precursor of the

bacteriologists and as having effectually paved the way for the first and greatest of all bacteriologists, Louis Pasteur.

Of Pasteur, the founder of our science, I shall only recall very briefly the principal facts of history :

Pasteur brought to the study of all the problems that I have enumerated—and I hardly need remind you that among them are some of the most elusive, some of the most profound, and some of the most intensely practical, problems in all the field of natural knowledge—a thorough working familiarity with physics and chemistry. Though not exactly a chemist, he was able to meet chemists upon their own ground. Though not exactly a microscopist, he was highly trained in physics and mineralogy, and thus quickly became a master of the microscope. Piqued by the fact that living ferments could do with his salts what he himself could not do, he began a careful study of ferments and fermentation, with the result that in a few short years he had completely confirmed and established the biological or germ theory of fermentation propounded by Schwann; had extended it so as to make it include putrefactions; had shown that organic decomposition and decay in nature are simply slow fermentations or putrefactions; had nearly, if not quite, overthrown the world-old theory of spontaneous generation; had studied the floating matter of the air, and actually found in it organized corpuscles, or germs, of molds and of infusorial or fermentation animalcules; had invented and introduced for the first time methods for the cultivation, and even for the pure cultivation, of living ferments which so much facilitated the investigation of microscopic life that we now rightly regard them as constituting the very basis and essence of bacteriology,—which thus becomes a kind of microscopic gardening or horticulture of the microscopic world; had also, by the use of these

novel methods, established not merely the fact that living ferments in general are the cause of fermentation in general, but, what was of equal or even greater importance, the existence of specific or characteristic ferments for particular fermentations, one, for example, producing the alcoholic fermentation, another the lactic, a third the butyric, a fourth the acetic, and so on. If to-day we have to modify this primitive simplicity of arrangement and refer rather to one group of ferments than to one species merely, nevertheless the idea of specific energies for specific ferments remains secure and underlies most of the practical work of bacteriology.

Finally, through his work on industrial micro-biology, on the yeasts and the ferments of milk, vinegar, etc., Pasteur was led not only to consider the applications of bacteriology to the useful arts, but also to study the ailments of fermented drinks and the causes of their deterioration or 'disease,' with the result that in discovering and proclaiming the sources of the diseases of wine and beer as residing in specific noxious ferments or germs carelessly or unwittingly introduced, he became, almost unconsciously, not merely the apostle and defender of the biological or germ theory of fermentation, but also the principal contemporary exponent of the biological or germ theory of disease; a theory which had long been a dream of pathologists and now suddenly rose into scientific as well as popular favor.

Such was the origin of bacteriology, and such were some of the early achievements of its great founder. Stimulated by the work of Pasteur, a host of eager and enthusiastic workers threw themselves with intense zeal into the study of the micro-organisms which constitute the field of microbiology. Time has proved beyond all peradventure that the foundations laid by Pasteur were laid solidly and securely. The *fermen-*

*tations* are in fact what he and his precursor Schwann believed them to be, viz., chemical changes produced by living ferments, which, taken together, we may call microbes. *Putrefactions* are, as Pasteur believed them to be, essentially anaërobic fermentations. *Present day spontaneous generation* is, as Pasteur claimed, a myth—the last survivor of the notions of the alchemists. *Organic decomposition and decay* in nature have been found to be simply slow fermentations and putrefactions. *Nitrification*, or the natural mineralization of organic matter, is essentially an oxidizing fermentation, as is also, for example, the making of vinegar, from alcoholic cider. The *infectious or zymotic diseases* are either harmful fermentations, or the results of such fermentations, occurring not merely in wine, beer and vinegar, but, as Pasteur himself showed in the case of the silk-worm, in or upon the animal—and, we may now add, the plant—body.

A careful review of the subject from our present relatively advanced position shows that the really distinguishing characteristic of bacteriology is not merely its subject matter but its methods, not so much the peculiar organisms with which it deals—interesting and important though these are—as the peculiar means it has devised and employed for studying these organisms. In this respect bacteriology differs widely from any other science bearing the name of a particular class of plants or animals. Sciences such as mammalogy, ornithology, entomology, dendrology, pteridology, bryology, algology, mycology, lichenology and the like are chiefly, though not exclusively, characterized by the peculiarities of the special forms of life with which they deal, the methods by which they are pursued being largely common to all or at least in no great degree either peculiar or extraordinary. In bacteriology, on the contrary, owing, no doubt, to the small size and ap-

parent similarity of the organisms concerned, the ordinary methods of study and of classification are quite insufficient, so that new and highly peculiar methods have been devised and employed. Bacteriology does not depend, as ornithology and entomology chiefly do, on the external and internal anatomical features of individuals, but only to a small extent on these, and chiefly on the behavior of flocks, swarms, groups or masses of individuals, and upon these not in a state of nature but artificially massed or cultivated. Bacteriology finds its closest analogy not in such sciences as ornithology or bryology—the science of birds or the science of mosses—but in such sciences as breeding, gardening or agriculture. Possibly bee-keeping (apiculture) offers an analogy as useful as any. In apiculture bees are dealt with not so much as individuals, as communities or ‘colonies,’ and the swarms are bred, cared for or cultivated largely as masses and by methods highly peculiar. Bacteriology is a kind of microscopic horticulture or apiculture, and its methods, introduced in the first instance by Pasteur for yeasts and twenty years later vastly improved by Koch, are applicable to many bacteria and yeasts—though certainly not equally to all—and also to some molds and other fungi, and, to some extent, to certain algae and protozoa. If we define as micro-organisms or microbes all organisms invisible or barely visible to the naked eye, we may conveniently describe their study as micro-biology. *Bacteriology* then is a sub-division of micro-biology and is conveniently defined as *the science of the culturable micro-organisms*.

Enough has perhaps been said already, in dealing with the origin of bacteriology, to indicate sufficiently the scope and significance of the culturable micro-organisms in nature. But when we reflect upon the simple fact that without their activity the habitable world and the sea would become

one vast charnel-house, because there would be no adequate agency for mineralizing dead matter, we begin to realize the enormous importance of the part which they play in the economy of nature. We have only to think of their helpful and wholesome unseen activity in removing from our view the dead animal bodies which would otherwise cover the earth, the dead leafage of the autumn, the worn-out trunks of trees, and the waste matters of human and animal life, in order to appreciate in some measure their fundamental importance in nature. When to this we add their tendency to cause the destruction of valuable organic matters, such as food and timber; their function in producing those fermentations, putrefactions and poisonings of the human body which we know as epidemics, plagues, pestilences, infectious diseases, suppurating wounds, gangrene and the like; when, furthermore, we consider their causative participation in such universal, familiar and important processes as bread-making, brewing, vinegar-making, the fermentations of milk and its products, butter-making, cheese-making, lactic acid manufacture, tanning and nitrification, we are in a position to understand something of the scope and significance of the culturable micro-organisms, and therefore of bacteriology, from a practical point of view. And while we cannot forget that our science had its most fruitful beginnings in pure science at the hands of a physiologist, Schwann, and a natural philosopher, Pasteur, we must allow that its highest cultivation and its richest fruits have come from the labors of medical men. The names of Lister, Burdon-Sanderson, Koch, Behring, Roux and many others are the most famous, and their wonderful researches, with the brilliant practical results of their labors for human welfare and progress, by far the most splendid achievements of bacteriology in the last

quarter of our century,—the post-Pasteur period.

But in the last analysis it is the higher significance of bacteriology which must always be regarded as its most important characteristic. By virtue of the discoveries upon which it was founded, to which it has led and upon which to-day it rests illustrious and secure, mankind has been enabled for the first time to arrive at an adequate comprehension and understanding of the microscopic world and of many important and familiar natural phenomena hitherto either not understood or misinterpreted. The origin of bacteriology is interesting and instructive; its scope is broad and comprehensive; but these matters are of only moderate consequence as compared with its philosophical significance. At the beginning of our century, in absolute ignorance of bacteriology and its wonderful teachings, man gazed with wonder or indifference on some of the most familiar, yet most mysterious, of natural phenomena. Organic matters almost everywhere slowly 'decayed' and disappeared; sweet and sugary fruit juices 'turned' rapidly and 'spontaneously' into pungent or acid liquors; slow and innocuous 'decomposition' often gave place to foul 'putrefaction' and rapid 'decay' or destructive 'rots'; manure applied to land, even to land lying fallow, soon vanished altogether; 'epidemics,' 'plagues' and 'pestilences' swept over the earth, and man could neither understand, nor explain, nor intelligently fight them; the microscopic world quivered with forms of life which seemed to be born in a day and to disappear like dew. The heavens had long since revealed the glory of God, and the firmament,—thanks to the interpretations of Copernicus, Galileo and Newton,—had abundantly shown his handiwork. But the microscopic world still sat in the shadow of darkness, awaiting the disclosure of its meaning. At last, in the fulness of time and largely

through the achromatic objective, a great light shone upon and from the under world. The mysteries of fermentation, putrefaction, organic decomposition, decay and the mineralization of organic matters were reduced to their lowest terms and brought into line with other problems of biology. Epidemics, plagues and pestilences were proved to be merely the ravages of micro-parasites; the life of the under world was scrutinized, classified and studied, and has been found to follow in general the same natural laws as that of the upper world. Bacteriology has given to us a comprehension of the under world similar to that which astronomy and astro-physics have given us of the heavens; the widely-accepted theory of present-day spontaneous generation has been proved to be a myth, and with the fading out of this ancient view of nature the last traces of medieval ideas of magic, alchemy and easy transmutation of the elements have disappeared from science.

WILLIAM T. SEDGWICK.

MASSACHUSETTS INSTITUTE  
OF TECHNOLOGY.

*CERTAIN STROBOSCOPIC PHENOMENA IN THE  
END-ON PROJECTION OF A SINGLE WAVE.*

IN projecting a plane polarized wave machine wave, *www*, with a lens on a distant screen, *S*, one observes when the wave is in vigorous motion that the balls appear on the screen as stationary objects, symmetrically disposed with reference to the axis of advance of the wave, or the direction of incident light, *LL*, and at distances apart corresponding to equal phase-differences. Clearly the same effect must be produced in rotating the circle of reference, *C*, if provided with balls, *a*, *b*, *c*—at equal angular distances apart on the circumference. As certain parts of this phenomenon are peculiar, I constructed a disk like *C* by soldering bright rods at right angles to its surface at *a*, *b*, *c*—with an axle at *C*.



When the disk revolves, however rapidly, in the beam of sunlight parallel to its surface as stated, the eye regarding the inner surfaces of the rods  $a, b, c, d, e$ , sees the usual sheen of light intersected with intensely black shadow bands due to  $f, g, h, i, j$ , projected in the positions  $a, b, c, d, e$ . The experiment is specially striking in a dark room. This phenomenon is easily explained, for the points  $a, b, c$ —are nodal points, as it were, or loci of perpetual eclipse.

The second phenomenon is even more striking: if the light after passing the revolving disk parallel to its face (which therefore is seen as a mere line) is caught on a screen, either close at hand without a lens, or at long range by lens projection, the loci  $a, \beta, \gamma, \delta, \epsilon$ , are again stationary, appearing however bright on a dark ground. Judged merely by the eye, the effect is just

volving rods. Hence more light must get through along the lines  $fe, gd, hc$ , than in the same direction between these lines.

C. BARUS.

BROWN UNIVERSITY.

THE INTERNATIONAL GEODETIC ASSOCIATION.

THE sessions of the Thirteenth General Conference of the International Geodetic Association were held at Paris, France, between the 25th of September and the 6th of October, 1900.

The following countries were represented at the Conference: Germany (8), Austria (2), Denmark (1), Spain (1), United States (1), Great Britain (1), Hungary (1), Italy (3), Japan (1), Mexico (2), Norway (1), Holland (3), Roumania (2), Russia (1), Sweden (1), Switzerland (1), France (8),

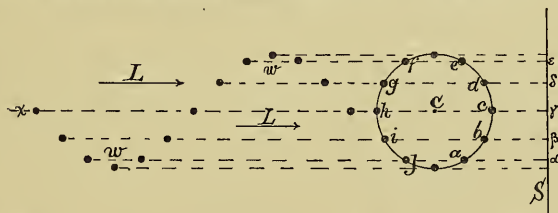

as if the rods where they cross in double thickness were perfectly transparent. It would take considerable acumen to predict this kinematic result.

Without entering into details, I may point out in explanation that every part of the area of projection,  $S$ , is swept by the shadow of each rod twice per rotation. The result must be perceptible and at first sight uniform darkening of the field. But whereas throughout the whole semicircle,  $f, g, h$ ,—and also between the points  $a, b, c$ ,—light has been removed backwards (*i. e.*, from the screen) by reflection, none has been removed at the points  $a, b, c$ ; for these appear as black lines in the sheen of re-

the number following the name of each country indicating the number of delegates sent from the country. Belgium, Greece and Portugal were not represented.

At the opening session of the Conference the French Minister of Public Instruction presided, and welcomed the delegates in the name of the French Government. The sessions were held in the new Sorbonne, and a great many interesting reports were read. From these reports the following details have been extracted:

M. Schumann has undertaken a new computation of all the great arcs already measured, in order to deduce the elements of the terrestrial ellipsoid.

By relative gravity measures, M. Schumann has connected Königsberg, Guldenstein, Copenhagen and Christiania with Potsdam.

M. Borrass has connected Bucharest with Potsdam; M. Nagaoka will soon connect Tokio with Potsdam; and M. Putnam has recently connected Washington with London, Greenwich, Kew, Potsdam and Paris.

The funds of the association will be used to effect other connections of the principal gravity stations of Europe.

M. Helmert continues to keep up complete statistics of relative gravity stations. The actual number of these stations is now 1,450, of which 83 are connection stations. The results are very numerous, and the exact connection of the principal stations is an accomplished fact. M. Helmert hopes to be able, in 1901, to give a comprehensive discussion of all the results so far obtained.

A report was made upon the observations already made at international latitude stations, and the provisional calculations of the observations so far made have given satisfactory results.

General Bassot suggested the desirability of making similar observations on a parallel in the Southern Hemisphere.

The labors of Albrecht and Chandler have made great progress in developing the theoretical question of the variation of latitude. The first, from observations at 13 stations in Europe and America, from 1890 to 1897, has shown that the pole of rotation of the earth has described in that space of time an irregular spiral about a mean position, with a maximum elongation of  $0''.30$ . The second, after a profound discussion of observations made between 1825 and 1893, represents this displacement by an expression of two terms, periodic functions of time. The period of the first oscillation covers 429 mean days, that of the second 365. These terms vary,

respectively, from  $0''.085$  to  $0''.185$  and from  $0''.115$  to  $0''.135$ . The mechanical causes of the displacement of the terrestrial axis of rotation are still far from being known.

A resolution was passed requesting Professor Gore to prepare a new edition of his *Bibliography of Geodesy*, issued by the Coast and Geodetic Survey in 1889.

A special report on triangulation was made by General Ferrero, and on base lines by General Bassot.

The French Geographic Service has undertaken a revision of all the French triangulation, with the aid of the instruments and methods of high precision used in the New Meridian of France; and work is actually in progress on the parallel of Paris.

In Italy the geodetic junction of Malta and Sicily has been made.

Roumania submitted her first report of geodetic work. The arc of the parallel already measured between the Atlantic Ocean and the Danube has been extended across Roumania to the Black Sea, and the meridional arc measure by Struve between the Arctic Ocean and the Danube has been extended entirely across the country.

In Russia the recomputation of all trigonometric points upon the same spheroid has been undertaken. A determination of the terrestrial elements from Russian arcs alone shows that the elements of Bessel conform more nearly to the curvature within the boundaries of Russia than those of Clarke.

Two proposed operations were submitted to the Conference:

The Observatory at Nice will undertake experiments to determine the velocity of sound and light, using the distance between Mt. Mounier, near Nice, and Mt. Rotondo, in Corsica. This distance will be redetermined with modern precision by the French and Italian geodesists.

The difference of longitude, Paris-Greenwich, will again be determined according

to an elaborate program. One determination will be made in October, 1901, and another in March, 1902, so that the first results can be discussed before undertaking the second set of observations. Two pairs of observers, using four instruments, as nearly similar as possible, will be employed. At each station the French and English observers will frequently exchange their instruments. The pairs of instruments and observers will be exchanged twice during each determination. The method employed will be submitted to the examination and approval of the Central Bureau of the Association.

In this connection M. Albrecht called attention to the advantage of using the registering micrometer of the Repsold system, which eliminates the personal equation of observers.

Mr. Foerster spoke of errors resulting from the instability of the optical axes of instruments, caused by the movement of the objectives in their mounting.

General Bassot emphasized the necessity of watching attentively the nature and constancy of the electric communication, whose variability may explain the marked differences.

M. Cornu exhibited and explained an apparatus to determine the zenith distance of a star culminating near the zenith. On motion of M. Hirsch the Association resolved that a similar apparatus should be constructed and studied in one of the great observatories, and that M. Cornu, continuing his useful studies, should realize a portable zenitho-nadiral apparatus for use in temporary observatories, permitting numerous and easy determinations of latitude at all the points of a geodetic net.

Upon the invitation of the Association, M. Guillaume, of the International Bureau of Weights and Measures, presented a very interesting communication concerning nickel-steel. He remarked in 1896 that nickel-steel,

with 30 per cent. nickel, had an expansion sensibly less than platinum, and since then has conducted most interesting studies concerning these alloys. He dwelt upon their singular magnetic, thermometric and mechanical properties, and stated that a certain alloy with 35 per cent. to 36 per cent. nickel possesses an expansion ten times less than that of platinum and twenty times less than that of brass. He then passed to the uses of the alloy for geodetic purposes. He considers it impracticable to use the alloy in the construction of standards of the first order, where perfect stability and invariable dimensions within the limits of precision measures are demanded for long periods of time, on account of certain changes which have been observed as a function of time. In geodesy the question presents a different aspect, and it suffices in practise that the length varies very little, say a millionth part in a year, and that the change should be very regular. The small coefficient of expansion, the malleability, the feeble oxidation, and the homogeneous character of these alloys all increase their usefulness in the construction or use of geodetic instruments.

The applications of nickel-steel have passed the experimental stage and entered the practical field in the two methods of measuring bases actually in use, viz., those of rigid bars and wires.

The problem of constructing a base bar has been solved in a very satisfactory manner in the one actually being constructed for the Geographic Service of the French Army, from the plans of MM. Benoit and Guillaume. The bar, which is four meters long, has a section in the form of an H inscribed in a square of 40 millimeters. It is enclosed in a case, made of an alloy of aluminum, with openings for necessary observations. It rests in its case on two normal points of minimum flexure. It weighs 50 kilos, case included.

Nickel-steel wires have been made and furnished to the Geographic Service of the French army, to the Swedish-Russian Expedition to Spitzbergen and to the Geodetic Service of Cape Colony, for experimental use.

Work in Spitzbergen is in progress under the extremely difficult climatic conditions usually found in this region. The missions sent out by the two Governments were engaged in field work from the last of June to the beginning of September. They are now in winter quarters, isolated from the rest of the world during nine months, engaged in making astronomical and meteorological observations and in studying gravity, refraction, etc.

Sir David Gill addressed the Association on the motion of Professor Darwin, the delegate from Great Britain. He announced that since the publication of the first volume of the Geodetic Survey of South Africa, two extensions of the Geodetic Survey have been undertaken there. The first was required for the purpose of delimiting the boundary of British Bechuanaland and German Southwest Africa; with the cordial cooperation of both governments concerned, it was arranged to carry out this work as far as latitude  $22^{\circ}$  S. with the accuracy of a geodetic operation.

Connection was made with previous work, and the combination of these observations secures the measurement of a latitude arc along the 20th meridian from Cape Agulhas, (the southernmost point of Africa), to latitude  $22^{\circ}$  S.—an arc of nearly  $13^{\circ}$ .

The second operation is the more important of the two, and provides for the extension of an arc along the 30th meridian of E. longitude, from the southern border of Rhodesia ( $22^{\circ}$  S.), to the southern end of Lake Tanganyika. The work owes its inception to the enlightened policy of the Chartered Company, which has accepted the results of all experience and has determined to

base its surveys of the country on a framework of the most accurate possible triangulation. The work has been in progress for some years and a chain of triangulation has been carried along the 30th meridian from Gwelo (lat.  $19\frac{1}{2}^{\circ}$  S.) to the Zambesi.

Sir David Gill plans an extension of this work to Alexandria, Egypt, with the cooperation of Germany and Belgium through their African possessions, and of the Egyptian Government, and sees no special difficulties in the way of accomplishing the measurement of this great meridional arc, covering  $66^{\circ}$  of latitude.

Splendid as is the scientific prospect which the realization of these projects would present, its importance is further enhanced by the consideration that by the execution of a triangulation around the Levant to join Struve's great arc of the meridian (which extends from the North Cape, in Norway, along the 30th meridian to the southern limit of Russian territory), an arc having an amplitude of  $104^{\circ}$  would be completed.

A resolution was adopted expressing appreciation and approval of the project proposed by Sir David Gill.

The new measure of the Equatorial Arc of the meridian, known as the Peruvian Arc, undertaken by the Geographic Service of the French Army, was discussed by the Association with great interest. Captains Maurain and Lacombe, of this service, spent five months in South America during 1899, and finished the reconnoissance, during this time, of an arc of  $6^{\circ}$ , extending the old arc  $1^{\circ}$  on the north and  $2^{\circ}$  on the south. The scheme includes base lines, azimuth stations, astronomical observations, leveling, gravity and magnetic observations, topographical work and geological investigations.

The French Minister of Public Instruction referred the report of MM. Maurain and Lacombe to the French Academy of Sciences

for a statement whether the interests of science required this long extension of the arc, and the Academy has replied, through M. Poincaré, that the arc should be extended to  $6^\circ$ , and that the Academy should exercise a scientific control of the work through a permanent commission, but that the actual work on the ground should be confided to the Geographic Service of the French Army.

The sentiment of the Association was in favor of the prompt execution of this work. It was stated that two officers would shortly leave for South America to finish all preliminary preparations, and that three other officers and their staff would probably start about the last of April, 1901, to take up the field work. A French astronomer is already in charge of the observatory at Quito, under appointment from the Government of Ecuador.

During the discussion of the project for a great meridional arc in Africa, proposed by Sir David Gill, the Astronomer Royal at the Cape of Good Hope, I had occasion to make the following remarks, in response to the request of Professor Darwin for some statement from the delegate of the United States in reference to the suggestion offered by General Bassot, one of the French delegates, that in America there was an opportunity of measuring an arc of the meridian from Cape Horn on the south to the Arctic Ocean on the north :

"In response to the request of M. Darwin, I have the honor of expressing my appreciation and admiration of the grand scheme of triangulation proposed by Professor Gill, Director of the Observatory of the Cape, and take pleasure in stating that the motion for its endorsement by the International Geodetic Association will receive my earnest support. I will present the plan to my government and feel confident that it will receive all possible support from the geodesists of my country.

"In reference to the suggestion of General Bassot that a great meridional arc might be measured in America, I have to state that the United States is now engaged in measuring an arc along the 98th meridian west of

Greenwich, which will extend entirely across the country and cover  $23^\circ$  of latitude.

"The details of the condition of this work at this time will be found in my report to the Association.

"This arc can be extended south  $9^\circ$  of latitude by Mexico, and north by Canada to the limit of ice and snow in the Arctic regions, an unknown distance. I do not think that my Government is prepared to undertake any extension of the above scheme at present."

After discussing Sir David Gill's scheme, the Association indicated its approval by a unanimous vote.

When the report on the new measurement of the Equatorial Arc (known as the Arc of Peru), was before the Association, I took occasion to make the following statement :

"The delegate on the part of the United States desires to express, in the most positive manner, admiration and appreciation of the work already accomplished by the French geodesists, as shown in their report on the reconnaissance of the Arc of the Meridian of Quito, and to extend to them the most cordial congratulations.

"Feeling the deepest interest in the prosecution of the work and in its successful completion, he trusts that no serious obstacle will cause delay.

"Its ultimate completion is assured, now that it has been undertaken by those who will make any necessary sacrifice to add this additional glory to the illustrious position already attained by French geodesists.

"If assistance of any kind is needed to complete the work, he hopes that his country will be given preference in doing all in its power to supply whatever is demanded by the exigencies of the case."

ISAAC WINSTON.

U. S. COAST AND GEODETIC SURVEY.

#### THE ALBANY MEETING OF THE GEOLOGICAL SOCIETY OF AMERICA.

##### II.

#### *Stereographic Projection in Map-Construction :*

SAMUEL L. PENFIELD, New Haven, Conn.

By means of lantern slides and diagrams, Professor Penfield illustrated the methods of projecting maps of the various parts or countries of the globe upon the plane of its equator or of any other great circle. The methods are those employed by crystallographers for the projection of the polar points

of crystals and possess many advantages over the Mercator's projection or the ordinary maps which are practically pictures without definite mathematical proportions. Professor Penfield has constructed a series of scales which correspond to the projections of arcs by the stereographic method, and which enable one to measure distances between points of the earth whose latitudes and longitudes are known. Great accuracy can be obtained even when the projections are made on a circle whose diameter is less than six inches. The paper appears in the January number of the *American Journal of Science* and should be read by all teachers of geography.

*The Paleozoic Limestones of the Kittatinny Valley, N. J.*: HENRY B. KÜMMEL, Trenton, N. J., and STUART WELLER, Chicago, Ill.

The Paleozoic limestones of the Kittatinny Valley are divisible into the Kittatinny formation below and the Trenton above. The former is a magnesian limestone, probably 3,000 feet thick, and ranges from lower Cambrian into the Calciferous, with no structural or marked lithological differences. The Trenton limestone, about 135 feet thick, carries in its lower beds the Black River fauna, making it the equivalent of the lower Trenton of New York. A conspicuous and widespread basal conglomerate at the bottom of the Trenton rests upon the eroded surface of the Kittatinny formation. The lithological and faunal characteristics of the formations were described and their structural relations shown. The extent and importance of the basal conglomerate were outlined.

In discussion, M. R. Campbell inquired if the Trenton conglomerate changed in thickness from northwest to southeast. Mr. Kimmel replied that it did not, generally, although there was some variation in that the conglomerate appears to have been

formed at the foot of cliffs. Mr. Campbell stated that he had noted somewhat similar relations in Virginia, but that the conglomerate appeared on the northwest sides of the valleys and not on the southeast. He explained it as due to an interval of erosion and to the direction of the currents. N. S. Shaler cited parallel conditions in Kentucky and remarked the tendency of the limestones to thicken toward the northwest, not only in the Trenton but in the Lower Carboniferous and in the Coal Measures as well. He explained this by an Appalachian island to the eastward. J. M. Clarke mentioned a basal conglomerate in the Trenton near Albany, with fossiliferous pebbles containing a different fauna from the cement. J. F. Kemp cited a conglomerate of boulders of gneiss enclosed in a limestone cement in the thin Trenton outlier, within the southern Adirondack crystallines, at Wellstown, N. Y. The boulders are several inches in diameter, are similar to the neighboring gneisses and have apparently been dropped by floating ice. T. C. Hopkins remarked the Trenton conglomerate of the Nittany Valley, Penn., and its likeness to that of New Jersey.

*The Niagara Group along the Western Side of the Cincinnati Anticline*: AUG. F. FÖRSTE, Dayton, Ohio.

The paper described the lithology, paleontology and physiography of the Niagara Group, with special reference to Middle Tennessee. It was the continuation of an investigation which had been partially described to the Society at a previous meeting, and which had for its object the determination of the time of upheaval and the structural relations of the Cincinnati uplift. Mr. Foerste traced the several component strata from north to south on both sides of the great fold, from Ohio into Central Tennessee, and especially emphasized the excellent section presented at Newsome, Tenn. He

had observed that the Clinton fossils of New York occur at higher and higher horizons as one goes westward, and by this observation he was led to correct some previous errors of correlation. He placed the crest of the fold farther west than is ordinarily done, and made the upheaval later than the close of the Ordovician and earlier than the Hamilton, whose shale goes unconformably over the strata on the flanks.

At the conclusion of the paper the Society adjourned for lunch. On reassembling the program was continued as follows:

*The Knoydart Formation in Nova Scotia—a bit of the 'Old Red Sandstone' of Europe:* H. M. AMI, Ottawa.

The presence of such genera as *Pteraspis*, *Pterygotus Onchus*, etc., in the red marls, shales and calcareous breccias (?) of McArras Brook in Antigonish and Pictou counties, Nova Scotia, indicates the base of the 'Old Red Sandstone' of Great Britain. The paper discussed the relations, paleontological and stratigraphical, of this important formation in the sequence of Devonian strata in eastern Canada. The result of observations made by Mr. Hugh Plebden, of the Canadian Geological Survey, as published on this subject, together with important notes by Mr. A. Smith Woodward and Dr. Henry Woodward, of the British Museum, was embodied in the paper.

The names applied by Mr. Ami to the several formations of this section are the following:

The Silurian of the Arisaig Coast of Nova Scotia is divisible into at least four distinct geological formations, and includes:

1. *The Stoneham formation*, consisting for the most part of dark red and fine grained shales and mudstones, holding a conspicuous, lamellibranchiate fauna, of which *Grammysia Acadica*, Billings is a well-known species, together with a number of interstratified, more or less thin, calcareous

bands, holding brachiopods, gastropods, trilobites and ostracods in abundance.

2. *The Moydart formation* consisting of more or less heavy bedded, light greenish-gray and rusty weathering, calcareous strata, in which the author's 'Red Stratum' occurs—holding brachiopods, cephalopods, crinoids and gasteropods.

3. *The McAdam formation* consisting for the most part of impure, black, carbonaceous, at times splintery shale, holding a lamellibranchiate fauna, graptolites, etc.

4. *The Arisaig formation* including buff-weathering, fine grained and compact mudstones and shales, holding corals, chiefly *Streptoplasma* and brachiopods, gastropods and trilobites.

5. *Knoydart formation* red shales and sandstones and calcareous bands, holding pteraspidian and ostracoderm fishes and crustaceans, referable to the Cornstone or lower Old Red Sandstone of Great Britain. It immediately overlies the Silurian strata at Arisaig, but no actual contact has been observed.

H. S. Williams inquired about the igneous rocks at the top and in further detail regarding the Knoydart formation. Mr. Ami replied that igneous rocks were present. The strata had been mapped as upper Devonian, but that they really were lower Devonian and possessed a pronounced Silurian facies. The whole series is much more closely related to the British fauna than to that of Anticosti.

*A Depositional Measure of Unconformity:* CHARLES R. KEYES, Des Moines, Iowa.

The paper was read by W. B. SCOTT.

The great unconformity at the base of the Coal Measures in the upper Mississippi Valley was briefly characterized in its various aspects. The enormous thickness of Coal Measures in Arkansas and Indian Territory finds adequate explanation in the ancient geographic development. The recent

results of correlation of the north and south regions were summed up. Twenty thousand feet of the Arkansas Coal Measures are found to have been deposited during the period represented by the great stratigraphic break in the north. No discussion.

*Marine and Fresh-water Beaches in Ontario.*

A. P. COLEMAN, Toronto, Canada.

Marine deposits, often rich in shells and other fossils, are widely distributed east of Brockville and Smith's Falls, in the valleys of the Ottawa and St. Lawrence. They occur at higher levels toward the northeast and east than towards Brockville; they include trees and other forms indicating a climate like that of to-day, and are all evidently postglacial. The shells occur in clay, sand and also coarse gravel.

High beaches, such as the Iroquois, Warren, etc., contain only fresh-water shells, if any. Still higher beaches, such as those reaching 1,400 to 1,600 feet above sea level in the highlands between Georgian Bay and Lake Huron, and the beaches found above 1,400 feet between Lake Superior and Missanabie, and at the same level on the Hudson Bay watershed northwest of Sudbury, have not yet been found to contain shells, although if marine there must have been complete and widely opened connection with the sea. The wide gravel terraces on the watershed mentioned contain numerous and large, kettle-shaped, lake basins, sometimes without outlets, suggesting that they were formed by the burial of large blocks of ice at the border of the Labradorian ice sheet, and hence in ice dammed waters.

In discussion Robert Bell explained the presence of fresh-water shells amid marine conditions because of the forcing back of salt water by an inflowing stream of fresh. On the north side of Lake Superior he cited the occurrence of marine shells up to 500 feet, but their absence in the high gravels.

He argued against the existence of ice dams in the past. G. K. Gilbert described the phenomena along the St. Lawrence east of Lake Ontario. He cited the occurrence of marine shells as far as Ogdensburg. C. H. Hitchcock referred to the sea-shore plants that are found around Lake Superior, apparently left by the withdrawal of the salt water. He also suggested that the basin of Lake Ontario might be due to the removal of limestone in solution. F. B. Taylor discussed the shell-beds, beaches and ice-dams. H. P. Cushing instanced the high gravels and general physiography of the Adirondacks as bearing on the questions. The Adirondacks embrace the high mountains, the western penneplain plateau and the depressed lakes. Kettle-holes occur on the north side but not on the south. Ice dams are proved by the kames left by subglacial streams which flowed against the slope of the country.

*The Geology of Rigaud Mountain, Province of Quebec, Canada: OSMOND EDGAR LEROY, Montreal, Can. Introduced by F. D. ADAMS.*

The chief topographic feature of the Paleozoic plain of Central Canada is a series of hills, which occur in the district about Montreal. These are of igneous origin, and follow a line of disturbance which is almost at right angles to the trend of the Notre Dame Mountains. Rigaud is the most western of the series. It consists of an area of hornblende syenite, which is pierced on its northern flank by a quartz syenite porphyry. The field relations of all the hills with the exception of Rigaud, show them to be of post-Silurian age. In the case of the latter, the contact with the Paleozoic is wholly concealed by drift. The object of the research was to ascertain if a genetic connection could be established between Rigaud and the other hills to the east.

Investigation shows that it is probably



not so connected, but a definite conclusion cannot be reached until a more extended study is made of the rest of the range.

In discussion, F. D. Adams commented on the interest attaching to this mountain both in its petrographic and stratigraphic relations. Mention was made by others of the benches of boulders which lie on the side of Rigaud. It was brought out that they are coarse cobbles, entirely unglaciated and all of local origin. They are known as the Devil's Garden and are at least thirty feet deep, but have no fine material between them. N. S. Shaler, therefore, remarked that they could not be beach-deposits, else they would be packed with sand. The interpretation of the boulders is an interesting point in post-glacial geology, but it still remains to be solved. J. F. Kemp remarked the similarity of the syenite to that of the Adirondacks, especially as described by H. P. Cushing in an earlier paper.

At the conclusion of Mr. Leroy's paper the session adjourned.

In the evening the Society was most hospitably entertained by Dr. and Mrs. F. J. H. Merrill and had the opportunity of meeting many Albany people.

On reconvening on Saturday morning the most important executive business was the adoption of a resolution recommended by the Council, which read as follows:

*Resolved*, That recognizing the great, historical, scientific and economic value of the collections of the State Museum in Albany, representing the geology and paleontology of the State of New York, the Geological Society of America expresses the earnest hope that an ample and fireproof building may be provided for the display of the priceless collections, where they may be accessible to students interested in the progress of science and the economic development of the State.

The Society then listened to the Presi-

dential address of Dr. George M. Dawson, who took for his subject 'The Geological Record of the Rocky Mountain Region.' The paper was illustrated by maps and by comparative stratigraphic sections both east and west of the Canadian Rockies. It dealt especially with Canada and will be probably printed in full in a later number of SCIENCE.

The following paper was read in abstract by G. P. Merrill.

*Weathering of the Granitic Rocks of Georgia:*  
THOMAS L. WATSON, Atlanta, Ga.

The paper embraces the results of a detailed field and laboratory study of the principal exposures of the granitic rocks in Georgia. On structural and textural grounds, the rocks were divided into and discussed under (a) the true granites with even-grain texture; (b) porphyritic granites; and (c) granite-gneisses. Each type, as here distinguished, is represented by a number of localities in somewhat widely separated parts of the State. In mineral and chemical composition, the rocks are closely similar, and all carry biotite as the chief accessory.

The physical conditions of the fresh rock and of its accompanying, decayed product as studied in the field were carefully stated, and each was described petrographically, the description being followed by a discussion, based on chemical analyses, of the changes incident upon weathering.

In taking up the changes manifested in the weathering of the rocks, as shown in the analyses, calculated amounts of each constituent lost and saved were separately made on three assumptions, namely, that the  $\text{Fe}_2\text{O}_3$ , the  $\text{Al}_2\text{O}_3$  and the  $\text{Fe}_2\text{O}_3 + \text{Al}_2\text{O}_3$  have undergone no loss. The results were then compared. With the exception of the total loss for the entire rock, the results proved to be closely similar for the three assumptions.

*The Peneplain of Brittany:* W. M. DAVIS,  
Cambridge, Mass.

The paper consisted of an exhibition of lantern slides illustrating the peneplain of Brittany, and of its detached portions in Jersey and Belle Isle, as well as of certain valleys by which the peneplain has been dissected since its elevation; and of comments in which the speaker argued that the plain was not one of marine denudation, but was subaërial.

The paper led to a quite extended discussion of the criteria for plains of marine origin, chiefly emphasized by N. S. Shaler and H. M. Ami, and of those of subaërial character, as developed by C. D. Walcott and G. K. Gilbert.

*An Excursion to Colorado Canyon:* W. M.

DAVIS, Cambridge, Mass.

Observations made in the canyon of the Colorado and over the plateaus on the north and south, during a three weeks' trip in June, 1900, add the occurrence of certain landslides and migrating divides to the evidence already stated by Dutton in favor of two cycles of erosion in the development of the Grand Canyon district; the broad denudation of the plateaus having been accomplished in the first cycle, and the incision of the narrow canyons in the second. The faults by which the plateaus are divided are regarded as for the most part of greater antiquity than the canyon cycle; the antecedent origin of all the branch streams of the Colorado in this district is questioned; and the high level floor of the Toroweap valley is explained otherwise than by the failure of its former water supply through a change from a humid to an arid climate.

G. K. Gilbert corroborated the probability of the speaker's views from the evidence of neighboring systems of drainage, and C. D. Walcott spoke in the same vein.

*Fossiliferous Layers in the Calciferous of Dutchess County, N. Y.:* W. B. DWIGHT, Poughkeepsie, N. Y.

The paper described some recent discov-

eries of a Calciferous fauna, somewhat related to the Fort Cassin fauna of Vermont. It seems to identify the Calciferous for the first time so far south. It contains 24 species, of which 9 are trilobites.

C. D. Walcott remarked its resemblance to the fauna at Phillipsburg, Vt., and to another at Eureka, Nev.

*Glacial Phenomena in Eastern Ontario:* F.

B. TAYLOR.

The speaker described the results of his observations of the moraines and other glacial phenomena in the portion of Ontario lying between Georgian Bay and Lake Ontario. At least four moraines can be identified which he endeavored to trace out to a connection with those further south. He also described an old river channel near Guelph which had been produced by a stream flowing against the front of the ice sheet.

The paper was discussed by W. M. Davis and A. P. Coleman. The former emphasized the importance of accurate phraseology in the nomenclature of glacial forms, the latter corroborated the general conclusions of Mr. Taylor in respect to the local geology.

*Biserial Development in the Plates of the Arms of Crinoids:* A. GRABAU, Troy, N. Y.

By means of a series of diagrams the speaker showed how the arms of crinoids begin with a uniserial set of plates, and then by the development of a series of wedge-shaped plates gradually become biserial.

*The Atchison Deep Well, Kansas:* E. HAWORTH, Lawrence, Kansas.

The paper was read in abstract by J. F. Kemp in the absence of the author. It described a recent deep well at Atcheson which revealed two workable coal-seams and which threw new light on the structural relation of the Coal Measures and Lower Carboniferous strata in this section.

The following papers were read by title:

*Sand Crystals and their Relation to certain Concretionary Forms:* ERWIN H. BARBOUR, Lincoln, Nebr.

*The Broad Valleys of the Cordilleras of North America:* N. S. SHALER, Cambridge, Mass.

*Keewatin of Eastern Central Minnesota:*

*Keewenawan of Eastern Central Minnesota:* C. W. HALL, Minneapolis, Minn.

*Points Involved in the Silurian-Devonian Boundary Questions:* H. S. Williams, New Haven, Conn.

*Age of the Coals at Tipton, Blair Co., Pa.:* DAVID WHITE, Washington, D. C.

*Comparison between the Stratigraphy of the Black Hills and that of the Front Ranges of the Rocky Mountains:* N. H. DARTON, Washington, D. C.

*Tertiary History of the Black Hills:* N. H. DARTON, Washington, D. C.

*The Wisconsin Shore of Lake Superior:* G. S. COLLIE, Beloit, Wis.

*Landslides of the Echo and Vermilion Cliffs, Grand Canyon of the Colorado:* RICHARD E. DODGE, New York City.

The Society then passed the customary votes of thanks to the local Fellows and with them closed a very successful meeting.

J. F. KEMP.

COLUMBIA UNIVERSITY.

#### ANTHROPOLOGY AT BALTIMORE.

SECTION H of the American Association for the Advancement of Science held its winter meeting at Baltimore, Maryland, on December 27th and 28th, in conjunction with the meetings of the American Society of Naturalists and Affiliated Societies.

Vice-President Butler being unavoidably absent, Professor Franz Boas was elected temporary chairman at the Thursday morning session which was called to order at

10.15 o'clock in the Historical Seminary Room at Johns Hopkins University.

The first paper read was by Dr. Thomas Wilson, on 'Anthropological Congresses at the Paris Exposition of 1900.' After a brief sketch of the history of the Congrès International d'Anthropologie et d'Archéologie Préhistorique, Dr. Wilson gave a summary of the work done at the recent sessions at Paris and described the field excursion. An account was also given of the meeting of the Congrès International des Américanistes. This Society has accepted the invitation to meet in New York city in 1902. On the motion of Dr. Wilson a committee of three was appointed to take preliminary steps for the reception of the Congress at this, its first meeting in the United States. The committee appointed consists of F. W. Putman, chairman, J. W. Powell and G. A. Dorsey.

The next paper, entitled, 'The McCormick Expedition among the Hopi,' by Dr. G. A. Dorsey, described the archeological work done along the Little Colorado River by a party from the Field Columbian Museum and by another party in the vicinity of the Hopi pueblos. The ethnological work of Mr. Voth was also described and commended. This paper will be published in SCIENCE.

Professor Franz Boas next spoke of the desirability of a catalogue of the crania now in American museums. In order that the various collections may be worked up in a uniform manner, standard skulls should be sent to each museum from which the measurements to be taken might be learned and the extent of error in observation reduced to a minimum. The Section was unanimous in its approval of Professor Boas's plan and it was voted to refer the preparation of a report upon osteological cataloguing to the Anthropometrical Committee of the Association.

Dr. Frank Russell then demonstrated a

new instrument devised for the purpose of measuring the torsion of the long bones. The features of the instrument were simplicity, ease and rapidity of manipulation and accuracy.

Dr. Walter Hough gave an ethnographic sketch of the Totonac Indians of Mexico, concerning whom but little has heretofore been known.

A second paper by Dr. G. A. Dorsey, on 'An Aboriginal Quarry in Eastern Wyoming,' closed the morning session.

Upon reassembling in the Historical Seminary Room Professor Boas withdrew from the office of chairman and Dr. Frank Russell was elected to that position.

The first paper of the afternoon was by Professor O. T. Mason, on 'Technique in Amerindian Basketry.' In the absence of the author the paper was read by Dr. Hough. All American baskets are of two types: woven or plicated and coiled. The forms of woven baskets were enumerated, with examples of each. The varieties of twined and of coiled basketry were classified and described.

Professor Boas followed with an account of his summer's work among the Kwakiutl Indians of the Northwest Coast, speaking particularly of their language. He commented upon the changes that are taking place through contact with the whites, also the change from the paternal to maternal descent in the social organization of the tribe. In the discussion which followed Dr. Fewkes pointed out the similarity between the measurements in use among the Kwakiutls and those of the Hopi, and also spoke of the customs regarding property, especially the ownership of eagles. The different clans have traditions that they came from different quarters, and the eagles' nests in those directions are not disturbed by the members of other clans.

The paper upon 'The Interpretation of Field Testimony, especially concerning Vil-

lage Sites,' by Mr. W. K. Moorehead, was read by Dr. Wilson.

The Section meeting at 9 o'clock on Thursday morning in the Physical Laboratory was presided over by Professor McGee. An illustrated paper was read by Mr. Geo. G. MacCurdy, on 'Folk-Religion in Brittany.' The author described a ceremony at the church of Carnac dedicated to St. Cornély, patron of domestic animals, where live cattle are offered not only for the Saint's blessing, but also as gifts to him. At a chapel near Brussels, dedicated to St. Guidon, horses appear prominently on certain festival days. Figurines of horses and cattle used in Bohemia, Styria and Bavaria offer a striking parallelism with the Hopi figurines of domestic animals used at the winter-solstice ceremony.

Mr. Harlan I. Smith presented an illustrated paper, entitled, 'Notes upon the Archeology of the Sagwan Valley, Michigan.' These notes were selected from those taken by the author in 1890 which are now being edited for the purpose of rendering them available to the State Survey which prominent educators of Michigan are advocating. Notable among those who are endeavoring to establish an archeological survey of the State of Michigan are the University of Michigan and the Detroit Branch of the Archeological Institute of America. After discussing the paper and the desirability of extending such surveys, the Section appointed a committee consisting of Thomas Wilson, chairman, G. A. Dorsey and Frank Russell to transmit a suitable memorial to the people of Michigan expressive of its approval of the establishment of the survey.

Dr. Frank Russell exhibited a series of lantern slides made from photographs which he had taken in Arizona during the summer of 1900. This communication was avowedly presented for the purpose of eliciting information concerning the present state of our

knowledge concerning the pictographs of the southwest. In the discussion which followed Dr. Fewkes pointed out the value of these symbols to those who are studying the routes of migrations in the Southwest. He also offered interpretations of several of the characters. Dr. Hrdlička described pictographs of Northern Mexico that are suggestive of the Mayan hieroglyphs. Professor McGee reported the existence of curious pictographs which he had seen a few days before near the mouth of the Colorado River; on the top of a mesa covered with a thin layer of polished residual gravel huge figures had been traced by scraping away the gravel.

Dr. Ales Hrdlička presented the closing paper of the morning session, entitled, 'Albinos among the Hop and Zuñis.' A general outline of the nature of the phenomenon of albinism so far as it is known was given followed by a detailed account of the seventeen cases of albinism in the two pueblo tribes mentioned. Six of these cases are Zuñis. About two-thirds of the whole number are women. All are 'complete' albinos. Careful measurements show no inferiority in physical structure, and their slightly inferior strength is accounted for on the ground of lesser activity due to shyness. The eyes of these Indian albinos are invariably blue and not pink. No Hopi explanation of albinism was discovered. Dr. Fewkes stated that the Walpi Hopi had informed him that the people of the Middle Mesa, where the albinos are, make the 'White Paho,' prayer stick, and if a man whose wife is pregnant make such a Paho in an incorrect manner the child will be an albino. This Paho is not made at the First Mesa 'hence no albinos there.'

On Thursday afternoon Section H met with the American Folk-lore Society in the Donovan Room of McCoy Hall.

The session began with a paper by Dr. J. Walter Fewkes, entitled, 'An Interpreta-

tion of Pueblo Katchinas.' This paper embodied the results of a prolonged investigation into the character and significance of the many minor deities of the Hopi. This unique cult is regarded as a form of ancestor worship. Dr. Fewkes also exhibited a number of colored drawings that he had selected from a collection of 280 which the Hopi had made for him to illustrate the Katchinas. The value of these pictures is of course greatly enhanced by the fact that they are not only authentic, but the product of native talent.

Miss Alice C. Fletcher described 'The Lazy Man in Omaha Indian Lore.' The debate was graphically portrayed which the author once overheard in an Omaha camp, concerning the relative strenuousness of the life of the warrior of pre-Columbian days and that of the modern Indian. Their conclusion was that both must labor faithfully and continuously. From infancy the Omaha child is impressed with the direful consequences of laziness.

An interesting and valuable addition to the program was a paper upon 'The Treatment of an Ailing God,' by Dr. Washington Matthews. In the absence of the author, this paper was read by Dr. Hough.

'Hair in Folk-lore' was the subject of a paper by Mr. H. E. Warner, containing a summary of folk-sayings and tales regarding the human hair.

From the heirs of Dr. John Rae, a valuable manuscript has been received, entitled, 'Laieikawai, a Legend of the Hawaiian Islands.' This was written about thirty years ago. It was read in part by Mr. W. W. Newell. It is interesting because of the invention and dramatic power of the legend, as well as from the fact that it was written before the recent changes that tend to destroy the ancient myths.

Dr. E. W. Scripture reported that the American Philological Association and the Modern Language Association had each

appointed a committee of one to act upon a joint committee for collecting and preserving records of speech, song and similar material in various languages and dialects by means of speech-recording and transcribing apparatus. It was voted that Dr. Frank Russell be appointed to represent Section H upon this committee.

FRANK RUSSELL,  
*Secretary of Section H.*

*LELAND STANFORD JUNIOR UNIVERSITY.*

WE do not think that the time has yet come when a correct opinion can be expressed in regard to the unfortunate circumstances that have recently occurred at Leland Stanford Junior University. On the one hand, 'academic freedom' is absolutely essential as a condition of higher education and research; on the other hand, academic dignity and order must be maintained. At the present time we can only publish the letters exchanged between Professor Howard and President Jordan, and the subsequent letters by Professors Hudson and Little and the reply of acting-president Branner.

On January 10, 1901, President Jordan wrote as follows:

Professor George E. Howard, Stanford University—Dear Sir: After the dismissal of Professor Ross by the authorities of this university you took occasion to make certain remarks before your class criticizing the action and the motives of the management of the university. These remarks as reported in the newspapers and credited in university circles were, in the nature of the accusations, unjust, and, in the method of their presentation, discourteous to the university management. I have waited a reasonable time in the hope that reflection would enable you to see that some explanation and apology were desirable. Failing to hear from you I now deem it my duty to request you to make satisfactory apology for this breach of courtesy and to give such assurances of your attitude toward the management of the university as will guarantee a proper harmonious relation in the future. Failing in this it is my request that you at once tender your resignation, to take effect at the end of the current year, or sooner, should your feelings in

the matter prevent harmonious cooperation until that time.

Professor Howard replied on the 12th:

President David S. Jordan, Stanford University—Dear Sir: In self-defense I am forced to reply to several charges and statements contained in your letter asking my resignation. On the day following the publication of Dr. Ross' dismissal by the authorities of the university I spoke to my class in French revolution on the subject of 'Commercial absolutism and the place of the teacher in the discussion of social questions.' The address was as earnest a protest against interference with academic freedom as I was capable of making. There was absolutely no discourteous reference to the president nor to the founder, although in the discussion of the general theme there was involved a strong disapproval of their action. I do not believe that any fair-minded person who heard me will say that my remarks were discourteous in the method of presentation or unjust in their content. In the address I referred to the motives and influences which have caused the restriction of free speech in various institutions of the country. But so far as the motives and influences governing the recent action were mentioned, directly or by implication, they were those assigned in the published statement of Dr. Ross and sustained by the substance of your conversation with me on the evening of the day on which that statement appeared.

I am obliged to refer to another passage in your letter. You will scarcely fail to recall the fact that since my address before the class in French revolution you have asked me to remain in the university and repeatedly said that you did not wish me to resign. On November 20th, when our last conversation regarding the Ross incident occurred, you said positively that you should not ask my resignation unless Mrs. Stanford demanded it. How then could you have been hoping for an apology?

I have no apology to offer. My conscience is clear in this matter. What I have said I have said, as I believe, in the cause of individual justice and academic liberty. Therefore, in response to your demand, I tender you my resignation to take effect at your pleasure. An immediate answer will oblige.

On the following day President Jordan wrote:

Professor George E. Howard, Stanford University—Dear Sir: Your letter of the 12th inst., tendering your resignation as professor of history in the Leland Stanford Junior University, is duly received. I accept your resignation, to take effect at a date to be determined by you, in accordance with the concluding words of my letter of the 9th inst. These words

are: "Failing this, I request you to tender your resignation, to take effect at the end of the current year, or sooner, should your feelings in the matter prevent harmonious cooperation until that time." I shall be glad to know your further wish in the matter, and it may be communicated to Vice-President Branner, who is acting president, with full powers, in my absence.

The correspondence closed with this letter from Professor Howard, dated January 14th:

President David S. Jordan, Stanford University, Cal.—Dear Sir: Your letter accepting my resignation is received. Of course I am well aware that the rights of the large number of students now registered in my classes are involved in fixing the time of my resignation. Therefore, since I am being dismissed from a life position on the alleged ground of discourtesy to the authorities of the university, it seemed to me but fair that you should take the responsibility of saying whether I should remain to the end of the year. You decline to take that responsibility, and so leave me but one safe and dignified course.

I should have been willing to remain to the close of the year for the sake of my students, could I have felt sure that by 'harmonious cooperation' you mean a faithful and free performance of academic duty according to the spirit of the original implied contract under which I have thus far labored. I have not changed my attitude toward the university or toward my professional duties. I am only protesting against revolutionary proceedings. The vital point of the whole present incident is a question of free speech. Therefore I am not willing to pledge myself in advance to abide by the uncertain interpretation of the ambiguous phrase 'should your feelings in the matter prevent harmonious cooperation until that time.' Hence I wish my resignation to take effect at once.

On the following day Professors W. H. Hudson and C. L. Little presented their resignations. Professor Hudson's letter reads:

President Jordan—Dear Sir: For more than a year I have for personal reasons contemplated presently severing my connection with Stanford University. Recent events now precipitate my decision to do so.

As you are well aware I was from the first in strongest opposition to the new policy of the university inaugurated in the dismissal of Dr. Ross—a policy destructive of those first principles of academic

freedom upon which, as you have repeatedly said, the university was originally founded. Ever since the occurrence of that incident I have seriously doubted whether it would be possible for me, consistently with my opinions, to retain my position in this faculty. But now that in further pursuance of such policy, you have seen fit to demand the resignation of a man whom you yourself, in common with all who have known him, have long regarded as one of our ablest scholars and noblest teachers, for no other reason than that furnished by his just condemnation of the action of the university authorities—now that, in this way, you have clearly shown that it is the intention of the university to inhibit fair criticism of its methods no less than frank discussion of public affairs, no doubt is left in my mind as to my course. Whatever plans I might otherwise have made I cannot under existing circumstances continue to hold my chair. I therefore tender you my resignation, to take effect at your pleasure.

Professor Little wrote:

President Jordan—Dear Sir: Ever since the dismissal of Dr. Ross, against your protest, for expressing in the discussion of public questions opinions displeasing to Mrs. Stanford, I have considered whether I, who hold similar opinions, could be willing to remain in the faculty of Stanford University. Your recent call for the resignation of a man whose ability and independence of character I have admired for twenty years, because he uttered, in a form courteous to you and to Mrs. Stanford, condemnation of a policy destructive of the academic freedom in which you profess to believe, put an instant end to my indecision.

I hereby resign my chair as professor of mathematics in Leland Stanford Jr. University, to take effect at your convenience.

To these letters Professor J. C. Branner, acting president, replied on the same day, in identical terms, as follows:

Professor William H. Hudson, Stanford University—Dear Sir: Your resignation as Professor of English literature, in the Leland Stanford Junior University, addressed to President Jordan, has been handed to me as acting president.

Waiving the question of the validity of the reasons you put forward for your action, I hereby accept your resignation, to take immediate effect.

David E. Spencer, associate professor of history, has subsequently resigned.

## SCIENTIFIC BOOKS.

*Text-Book of Physiology.* Edited by E. A. SCHÄFER, LL.D., F.R.S., Professor of Physiology, University of Edinburgh. Edinburgh and London, Young J. Pentland; New York, The Macmillan Co. Vol. II.

In the preface to the first volume, issued nearly two years ago, it is stated that 'the want of a text-book in the English language to which students could turn for information beyond that contained in the ordinary manuals has long been felt by teachers of physiology (in England). 'The most extensive of the existing text-books do not aim at giving the full and precise information, nor the references to original authorities which are required by the advanced student.' The object of the work, the second and final volume of which is now before us, is to supply this want. The object is an excellent one. But when we enquire how far the editor and his able collaborators have succeeded in their laudable aim, we feel bound to answer that the execution does not in all points correspond with the design. Not that the book is devoid of good qualities. In certain respects its merits are conspicuous. No text-book of physiology in the language is more accurate. None is so extensive in its scope. Few are so scientific in treatment. But as regards its avowed purpose it labors under a serious, if not a fatal, defect. The 'advanced student' for whom it is intended scarcely exists at present. The twentieth century, which, as the newspapers have assured us, holds so many wonders in its womb, may in the fullness of time produce from the strangely miscellaneous contents of that mysterious receptacle some such miracle of precocious learning. In this year of grace 1901, he is, we fear, almost as much an abstraction as Macaulay's omniscient schoolboy. We can hardly help thinking, indeed, that whatever may have been the original plan of the book, the editor has not always been able to prevent his contributors from running away from him, or the contributors their subjects from running away with them. The consequence is that while some of the authors have evidently had in mind as their model the exhaustive 'Handbuch' of Hermann, and have

treated their respective themes with a wealth of illustrative detail and a copiousness of reference which leave little to be desired for the purposes of the professional physiologist, the contributions of others are such in contents and style as a student of actual flesh and blood, who had diligently improved his time in the physiological department of a medical school of actual brick and mortar, might hope to read with intelligence and profit.

We are far from supposing that a book on the lines of the 'Handbuch,' addressed to expert physiologists, is without value. On the contrary, we believe that if Professor Schäfer and his talented coadjutors, starting with the present work as a basis, expanding what is incomplete and retrenching what is too elementary, were to develop it into a really comprehensive treatise, and do for the physiology of the beginning of the twentieth century what Hermann and his fellow-workers did for the physiology of the early eighties of the nineteenth, they would confer a greater benefit on the cultivators of the science in all lands than a dozen Richet's Dictionaries will ever do. But in order that this may be accomplished, the impossible task of crowding into 2,200 pages a far greater volume of knowledge than Hermann twenty years ago was barely able to grapple with in more than 5,000 pages, would have to be frankly given up, and the idea of combining within the same boards a book for students and a book for experts once and for all abandoned.

When all due deduction is made for the discrepancy between plan and performance, it would be unjust not to say that the work remains by far the most notable recent attempt at a systematic exposition of physiology on a large scale in any language. Upon the whole, too, it cannot be denied that the authors, while avoiding hypercriticism in handling the experimental results of others, have escaped the still more serious error of making their articles mere compilations in which all the facts that have crept into the literature are spread before the reader without indication of their relative authenticity and importance. Occasionally, however, but so rarely as to excite surprise, it would seem that the Rhadamanthus of the blue pencil must have nodded over his long task.



For instance, on p. 454 the notion that 'the close agreement between the effect upon the functional changes (in nerve) of external CO<sub>2</sub>, and of previous nerve activity, is an indication that CO<sub>2</sub> is produced during the active state,' is mentioned without any warning to the innocent student that this is a mere airy speculation, such stuff, in fact, as only dreams and Croonian lectures are made of. By the way, it seems rather a pity that in a book of this size the use of such inaccurate contractions as CO<sub>2</sub> for carbon dioxide should have been countenanced for the sake of a petty saving of space.

On p. 499, in the account given of the changes of conductivity produced in a nerve by the passage of electrical currents it is stated that the block is established during closure at the anode and after opening at the cathode. No mention is made of the well-known experiments of Hermann and others which demonstrate that the block at the cathode during closure of a voltaic current is relatively greater than at the anode, while after opening, this relation is reversed.

On 48, the statement is made that in Stolnikow's determination of the output of the heart on the 'simplified circulation,' the output was probably maximal on account of the low resistance to the outflow. It ought not to be left to the student to supply the criticism that the heart can not have been normally fed through the coronary arteries with a pressure of only 30 or 40 mm. of mercury in the aorta, and therefore probably was not beating with normal strength. On the same page a comparison of Zuntz's results on the output in the horse, obtained by a method theoretically perfect, with those of Tigerstedt in the rabbit, obtained by a method of dubious propriety, is concluded by the remark that when the output per second is expressed as a fraction of the body-weight the results of the two observers roughly agree. The reader would inevitably draw from this passage the inference that the accuracy of Tigerstedt's numbers is supported by this agreement. The exact opposite is the case. For it is well established that the output of the heart is much greater in proportion to the body-weight in small animals than in large. If, then,

Zuntz's results are right for the horse, Tigerstedt's can not be right for the rabbit.

We are glad to see that Dr. Gaskell in his article on the contraction of the cardiac muscle, written in the interesting and almost autobiographical style so characteristic of this author when he handles this theme, has at last rid himself of the picturesque hypothesis that the positive electrical variation, observed by him in the quiescent auricle of the tortoise on stimulation of the vagus, indicates 'anabolic' changes in the muscular fibers, while the negative variation seen on stimulation of the augmentor nerves of the quiescent ventricle of the frog or toad indicates 'katabolic' changes, and has adopted the more prosaic view of other writers, that the electrical changes are simply associated with alterations in the tone of the heart muscle too small to be easily seen.

The contributors to this and the previous volume include most of the prominent workers in English physiology; and nearly all write upon subjects the knowledge of which they have advanced by their own labors. Thus, Dr. Leonard Hill, in one of the best articles in the book, treats of the circulation; Sir J. Burdon Sanderson, of striped muscle, including the electrical phenomena of this tissue, in the investigation of which he stands facile princeps in the English-speaking world; Professor Gotch, of nerve and electrical organ; Professors Schäfer and Sherrington, of the central nervous system; Dr. Langley, of the sympathetic and allied systems; Professor Haycraft, of animal mechanics, taste and smell; Professor {McKendrick and Dr. Gray, of the ear and voice; Professor Starling, of the muscular and nervous mechanisms of the digestive tract, etc.; and Dr. Rivers, of vision.

G. N. I. S.

*Die Lehre vom Skelet des Menschen*, unter besonderer Berücksichtigung entwicklungsgeschichtlicher und vergleichend-anatomischer Gesichtspunkte und der Erfordernisse des Anthropologischen Unterrichtes an höheren Lehranstalten, bearbeitet. Von DR. F. FRENKEL, Professor am Königl. Gymnasium zu Göttingen. Mit 81 Textfiguren. Jena, Gustav Fischer. 1900.

We have given the title at length, cumbersome as it is, because it expresses the nature of the work, and because this book has the merit of being what it pretends to be. More than that, it is the successful working out of a well-considered and philosophical plan. The purpose, in short, is to offer to students a guide to the general principles governing the morphology of the human skeleton, considered according to development and comparative anatomy. The great beauty of the book is the subordination of details to principles. It does not teach the bones as they must be taught to a student of medicine, but we wish that all medical students could have been put through this book before the beginning of their medical studies.

With the bones are very properly considered both cartilages and ligaments. It is not the disjointed skeleton that is before us, but the real framework of the body. There is first a short chapter on the histology of bone and the other connective tissues involved, and then we begin the development of the skeleton from the *chorda dorsalis*. Then we have the shapes of bones, their connections, the development of joints and the various kinds. Then we come to the description of the particular parts of the skeleton with the scientific significance dwelt upon and the details suppressed. What a relief from the compendium of anatomy which thinks well of itself because it gives the several surfaces of the orbital process of the palate bone! On the other hand, to take one example of many, how interesting to have the comparative anatomy of the malar bone!

It is not necessary to discuss the book in further detail. There are many morphological questions concerning which different opinions may be held, and an author is not necessarily wrong even if the reviewer should not agree with him on all points. That the plan of the book is good and that the aim of the author has been true is praise enough. We will add, that we wish someone would 'do it into English.'

THOMAS DWIGHT.

HARVARD MEDICAL SCHOOL.

*Evolution of the Thermometer, 1592-1743.* By HENRY CARRINGTON BOLTON. Easton, Pa., The Chemical Publishing Co. 1900. 98 pp.

This neatly printed and tastefully bound little monograph will be of interest to all physicists and chemists, and to the general public as well, for it deals with one of the most indispensable instruments in every laboratory, and one which, almost alone of those used by scientific men, has become an instrument of interest and use in every household.

In dispelling the fallacies and clearing away the obscurities which have enveloped the evolution of the thermometer, Dr. Bolton has again placed scientific men under an obligation, while at the same time he has afforded them an hour's entertaining reading.

The book opens by disposing of the oft-repeated claims that the inventor of the thermometer was Drebber. The first use of the name, thermometer, and the first accurate description, comes from Leurechon in 1624, but the real inventor of the instrument was Galileo, and the date between 1592 and 1597. This is proved, not from any statements of the inventor, but from letters written to him, and the proof is complete. This first thermometer consisted of a bulbed tube, inverted in colored water, in which the liquid rose and fell with the temperature of the bulb. With such an instrument Sanctorius discovered that there was a normal body temperature. In 1632 Jean Rey made a water thermometer, in which the expansion of a fluid replaced that of air, and not long after this Ferdinand II. of Tuscany, by sealing the top of the tube, gave approximately the modern form to the instrument. Mercury had been previously used to show expansion by heat, but in 1714 Fahrenheit constructed the first mercury thermometer with a reliable scale.

Many different scales have at various times been applied to the thermometer, and in most of them the graduation has been almost purely arbitrary. The origin of the Fahrenheit scale is involved in much obscurity. Réaumur was the first to use the melting point of ice for zero, while his boiling point of water, 80°, was obtained by the expansion of one thousand parts of 80 per cent. alcohol between the freezing and boiling points of water. As this was eighty parts, he used this number for his higher fixed temperature. The first to adopt 0° and

100° for the two points was Celsius, but in his instrument 0° represented the boiling point of water. Finally the change to the modern centigrade scale was made independently by Christin of Lyons and Strömer of Upsala, in 1743. With this date, Dr. Bolton's story of the evolution of the thermometer ends.

At the close of the book is given a table of the relative values of thirty-five different scales which have been used at various times; a chronological epitome; a list of authorities, and an index to the book.

J. L. H.

BOOKS RECEIVED.

*A Treatise on Elementary Dynamics.* H. A. ROBERTS. New York and London, The Macmillan Company. 1900. Pp. xi + 258. \$1.10.

*An Introduction to Modern Scientific Chemistry.* LAS-SAR-COHN. Translated by M. M. PATTISON MUIR. New York, D. Van Nostrand Company. 1901. Pp. viii + 348. \$2.00.

*The Foundations of Botany.* JOSEPH Y. BERGEN. Boston, Ginn & Company. 1901. Pp. x + 412; v + 257.

SCIENTIFIC JOURNALS AND ARTICLES.

IN the November-December number of the *Journal of Geology* James Perrin Smith discusses the 'Principles of Paleontologic Correlation.' He lays great stress on interregional zones and concludes that correlations upon homotaxis and synchronism should not be very different. Under 'Contributions from Walker Museum' E. C. Case describes 'The Vertebrates from the Permian Bone Bed of Vermillion County, Illinois.' A forty-page article by C. R. Van Hise on 'Some Principles controlling the Deposition of Ores' discusses the concentration of ores by underground water. He urges a new and natural classification of these ore deposits based upon their genesis, believing that such a division would also be of the greatest importance in the practical problems of engineers.

THE contents of the *Journal of the Boston Society of the Medical Sciences* for December 4, 1900, are as follows: 'Demonstration of a Photomicrograph of the Bacillus of Soft Chancre,' by F. B. Mallory; 'The Etiology of the Chancroid,' by Abner Post; 'A Simple Method of cultivating Anaerobic Bacteria,' by James H.

Wright; 'Occurrence of the Typhoid Bacillus in Suppurative Processes and in the Fœtus,' by Oscar Richardson, being the annotated record of a number of cases, and 'Observations on Milk Coagulation and Digestion,' by Franklin W. White.

*The Plant World* for December, 1900, opens with a popular article on 'Irises,' by F. H. Knowlton, in which he notes that there are about 160 species, and W. J. Beal presents, with illustrations, 'A Few Observations on Root Hairs'; Arthur Hollick gives 'An Example of Deductive Reasoning,' this being that the bottom deposits in a small swamp on Staten Island should represent the Quaternary age, a deduction that was verified by the excavation of the swamp. Edward Hale Brush gives some notes on 'Horticulture and Landscape Gardening at the [coming] Pan-American Exposition.'

*The Auk* for January contains two biographical sketches, 'In Memoriam: Elliott Coues,' by D. G. Elliot, and 'In Memoriam: George Burritt Sennett,' by J. A. Allen, both accompanied by portraits. Outram Bangs gives some observations on 'Birds of San Miguel Island, Pauama,' incidentally describing four new species. James H. Fleming presents 'A List of the Birds of the Districts of Parry Sound and Muskoka, Ontario,' comprising 196 species, and E. W. Nelson gives 'Descriptions of Five New Birds from Mexico.' 'The Sequence of Moults and Plumages of the Laridæ' (Gulls and Terns) is discussed by Jonathan Dwight, Jr., a subject that has received little attention, save at the hands of Brehm, in 1854. John H. Sage, the secretary, has an abstract of the 'Eighteenth Congress of the American Ornithologists' Union.' The 'Report of the Committee on the Protection of North American Birds for the Year 1900,' by Witmer Stone, shows that while much has been accomplished, a great deal remains to be done, and that decided help may be hoped for from the recent 'Lacey Bill.' William Dutcher gives the 'Results of Special Protection to Gulls and Terns obtained Through the Thayer Fund,' the expenditure of \$1,400 having resulted in the preservation of many birds.

*Terrestrial Magnetism* for September, which has just appeared, contains a portrait and biographical sketch of Professor Arthur Schuster. Among other articles in the number are 'The Present Status of our Knowledge of the Earth's Magnetism,' by A. Nippoldt; and 'Note sur une cause d'erreur dans la détermination de la déclinaison magnétique,' by H. Morize.

THE first number of the *Journal of Hygiene*, published by the Cambridge University Press and edited by George H. F. Nuttall, lecturer in bacteriology and preventive medicine in the University of Cambridge, late associate in hygiene in the Johns Hopkins University, Baltimore, is announced for immediate issue. The provisional table of contents is as follows:

'Introductory' by Sir John Simon, Professor William Osler and the Editor.

'Studies in Relation to Malaria.'

I. 'The Geographical Distribution of Anopheles in Relation to the Former Distribution of Ague in England,' by G. H. F. Nuttall, Louis Corbett and T. S. Pigg.

II. 'The Structure and Biology of Anopheles,' by G. H. F. Nuttall and Arthur E. Shipley.

'Pathogenic Microbes in Milk,' by E. Klein.

'Industrial Lead Poisoning,' by T. M. Legge.

'A Rapid Method of determining Carbonic Acid in Air,' by John Haldane.

'The Cause of the Red Color in Salted Meat,' by John Haldane.

'Artificial Modifications of Toxines, with Special Reference to Immunity,' by James Ritchie.

*La feuille des jeunes naturalistes*, edited by Mr. Adrien Dollfus, 35 Rue Pierre-Charron, Paris, having existed thirty years, has taken the opportunity of improving its appearance and intends to concentrate its efforts mainly on the natural history of western and central Europe with the adjacent regions around the Mediterranean. The library at the disposal of subscribers to *La Feuille* now contains about 42,000 memoirs and 300 scientific journals. The November, December and January numbers, which are those that have as yet appeared of this new series, amply fulfill the promise made. The most notable article is 'Revision des espèces de Tritons du genre *Euproctus* Gené, suivi d'un aperçu des Urodèles de la région paléarctique du sud-ouest,' by Dr. W. Wottersdorff.

## SOCIETIES AND ACADEMIES.

### NEW YORK ACADEMY OF SCIENCES.

#### SECTION OF ASTRONOMY, PHYSICS AND CHEMISTRY.

A REGULAR meeting of the Section was held at 12 West 31st St., New York, on the evening of January 7, 1901. Professor Harold Jacoby, of Columbia University, gave an account of a 'New Telescope for Photographing the Pole of the Heavens.' He announced that this plan of photographing the close polar stars had made material progress. A special instrument has been constructed and mounted at the Observatory at Helsingfors, Finland. Photographs of the actual instrument in position for use were exhibited. It is planned to make photographs with this instrument in which the close polar stars will trace out 'trails' on the plate corresponding to their diurnal motion. The effects of refraction, etc., having been eliminated by computation, it is possible to obtain from such photographs the exact position of the celestial pole among the stars and on the date of observation. The intercomparison of results taken on dates six months apart should furnish a new determination of the constant of aberration, and photographs taken annually throughout a series of years should determine the constant of nutation and ultimately perhaps even that of precession.

The actual observing with the instrument will commence in the spring, as soon as the Helsingfors astronomers have finished with the observations of Eros now in progress, and the plates will be sent to Columbia University, New York, for measurements and reductions. An outline of the method to be used, together with a preliminary trial of the same, has already been published by Professor Jacoby, under the title 'Photographic Researches near the Pole of the Heavens,' *Bulletin of the Imperial Academy of Sciences of St. Petersburg*, 5th Series, Vol. 9, p. 41, June, 1898.

Mr. George B. Pegram, of Columbia University, read a paper on the 'Reflection of Light from White Surfaces.' This was an experimental study of some white surfaces with regard to the relation between the intensity of the reflected ray and the angles of incidence

and reflection. It was carried out by means of a special photometer, allowing the use of any desired angles of incidence and of reflection. Among the surfaces tested were plaster of Paris, several kinds of unglazed paper, compressed powders of several kinds, powders not compressed, but gently smoothed with a metal plate, and finally a surface made by allowing fine plaster dust to settle from suspension in the air on a suitable plate. These surfaces in the order named, showed decreasing polarization of the reflected light, and less approach to specular reflection. The fine dust surface showed no polarization, and almost no tendency to regular reflection. The results with this surface, as shown by sets of curves, follow pretty closely the old Lambert's, or cosine, law,

$$\text{Intensity} = A \cos i \cos r.$$

with some departure when both angles were very large. With all the other surfaces the departure was very great for angles greater than 70°. Contrary to the results of Mr. Wright (*Phil. Mag.*, Feb., 1900), these experiments were quite in accord with the demand of theory that the intensity of the reflected ray should be expressed as a symmetric function of the angles of incidence and reflection.

WILLIAM S. DAY,  
*Secretary.*

#### CHEMICAL SOCIETY OF WASHINGTON.

The regular meeting was held on December 13, 1900. The first paper was read by Dr. Bigelow and was entitled, 'The Composition of the Ash of Meat Extracts,' by W. D. Bigelow and E. McK. Chace. The relation between solids and ash and between the several ash constituents were discussed in analyses of about 40 commercial meat extracts and of juices prepared from fresh beef.

The second paper, read by Dr. Cameron, was entitled, 'Formation of Sodium Carbonate or Black Alkali by Plants,' by F. K. Cameron. The view popularly held, to which Hilgard, Goss and others have called attention, is found to be correct. It seems probable that the phenomenon is very widespread, but does not assume practical importance, except under special conditions in the arid regions. A discussion of

the rôle of mineral nutrients in soil solutions accompanied the consideration of the data experimentally determined.

The last paper, read by Dr. Cameron, was entitled, 'Resistance by certain Plants to Black Alkali,' by F. K. Cameron. It has been found that a few plant specimens exist which can grow in soils containing much sodium carbonate. Three such plants were examined. It was found that these plants had an organic acid or acids formed on their surface, sufficiently strong to decompose alkaline carbonates. It is believed that this acid, or acids, aid in lowering the concentration of the alkaline carbonates in the soil immediately about the plants, and thus protect the root crowns from the caustic action of the black alkali.

WILLIAM H. KRUG,  
*Secretary.*

#### PHILOSOPHICAL SOCIETY OF WASHINGTON.

The 527th meeting was held January 5th, the new President, Mr. Walcott, Director of the Geological Survey, in the chair. The evening was devoted to geodetic papers.

Mr. Eimbeck presented informally the question of an apparent error arising in transit observations from the fact that at a locality where there is local attraction of the plumb line the geodetic meridian and the astronomical meridian differ sometimes as much as 30''.

The first regular paper was read by Mr. Isaac Winston on 'The Thirteenth General Conference of the International Geodetic Association,' held at Paris last fall, at which 17 countries were represented, and to which he was a delegate. The principal papers presented there dealt with recent work at gravity stations, the question of variation of latitude, the proposed revision of older triangulations in France and Peru, the nickel-steel alloy with small coefficient of expansion, and the recent and prospective measurements of terrestrial arcs. [This paper is printed above.]

Mr. Schott followed with an interesting historical account of such measurements, pointing out that the Clarke spheroid agreed better than Bessel's with the American observations. Mr. Hayford described more fully the simple new nadir-zenith apparatus of Coru, to which ref-

erence had been made, the purpose of which is to determine the zenith distance of stars culminating very near the zenith.

The second regular paper was by Mr. Hayford on 'The New Precise Leveling Instrument' of the Coast and Geodetic Survey, with exhibition of it. The instrument is very low and stable, the new iron nickel alloy is used, the level tube is sunk well into the telescope tube, the parts are not reversible as formerly, and an auxiliary telescope with mirror is provided for the left eye to read the ends of the bubble. Field experience shows that both rapidity and accuracy of working have been much increased by the use of the new instrument. [The full description will be published elsewhere.]

CHARLES K. WEAD,  
*Secretary.*

#### DISCUSSION AND CORRESPONDENCE.

##### WHOSE FAULT AT THE U. S. NAVAL OBSERVATORY.

TO THE EDITOR OF SCIENCE: It is natural and very proper that the Superintendent of the Naval Observatory should defend his institution, even vigorously, against charges, where he conceives there is ground for believing there has been lack of fair play. The delicate task imposed upon the Board of Visitors should evidently have been sufficient motive for safeguarding their report against the suspicion of unfairness, if any has been shown, by first giving full credit to the existing organization in preparation for their suggestions looking to an improvement. Otherwise, the entire affair will degenerate into a dispute, and that is the most hopeless basis upon which to approach Congress for remedial legislation.

Your editorial in SCIENCE of January 4, 1901, on the 'Naval Observatory Report' does not seem to be free from the objection that it charges against the administration of the Observatory certain results which do not in reality belong there. You blame it for the removal of the Magnetic Observatory to its present site, and for the imperfections of the instrumental apparatus acquired during the past thirty years. It is very easy to misplace responsibility, but in a discussion of this kind it ought not to be done; and the fact is admitted that in such

matters of administration the executive acts upon the advice of his subordinates. Now, certainly, there could not be two more conspicuous examples chosen to show that, where the astronomers have had their own way, the blame is being shifted to the chief. For it is well known that the magnetic observatory was moved by the counsel of the Astronomical Director, in cooperation with that of a prominent visiting English astronomer, and against the arguments of the professor in charge of the magnetic work, and all others in Washington interested in magnetic observations. The action of neighboring trolleys and dynamos was pointed out, but the wish to possess the equipment overruled the interests of science. The fact that the work of the magnetic observatory has not been otherwise efficient is partly due to the appointment of untrained officers of the Navy to conduct the operations, and this is of course a matter of administration. In the planning of new instruments the astronomers have for a long while had their head, and if they chose to experiment in novel constructions and to entrust the building of the instruments to American firms, they ought at least to relieve the administration, which simply expressed their decisions, of the blame for an unsatisfactory outcome of that kind.

This brings up the problem of administration. There are two types of organization, the first, where there is a strong head and a corps of subordinates who are his assistants, and over whom his decisions are final, of which the observatories at Cordoba and Harvard College are examples; then there are staffs formed of practically independent professors whose real bond of union is cooperation, of which the Naval Observatory is an example; other observatories have a mixed system in operation. The first type is calculated to put out a large mass of routine work, and to do immense pieces of observation and reduction along well-understood simple lines; the second type is suited for scientific researches into unexplored territory, where the initiative and the successful progress depends entirely upon the personality of the astronomer. No chief by executive order can aid his research, and the heads of institutions are always only too glad to support the work of men

who show real capacity, and the persistency required to bring things to a conclusion. This type of organization is the one in keeping with the highest requirements of modern science, where a work is allotted by choice or natural selection to a man, and he is given the opportunity to develop it. If in such a body of men cooperating for a common good, there should enter jealousy, dissension and rivalry, the end will be defeated, but by no fault of the system. The astronomers of the United States should consider seriously whether it is wise to debase an organization which gives the utmost possible freedom to the individual astronomer, and supplant it with a scheme where authority at the top limits the scope of operations to the will of one man.

The executive in the large Government surveys is so far burdened down with administrative duties, finances, correspondence, mediation between Congress and the public, that it is quite impracticable for him to devote energy to the advanced problems of the day. A scientist can take up these duties only by abandoning his researches, and it is little more than a dream to suppose that one can carry both along together. The proper attitude is that of co-operation between the administrator and the astronomer engaged in practical research, and I am quite persuaded that the officers of the Navy, in the Bureau and at the Observatory, have been quite as faithful to their duties as the astronomers to their tasks. Lack of co-operation, from whatever cause it may arise, is not to be remedied by legislation; this may destroy the free chance to cooperate by introducing subordination, but it would be a step backward, and it should be taken only when a body of American astronomers can not be selected, who are willing to make the most of their splendid opportunities. Furthermore, the attachment of the Observatory to the Navy Department has been the source of its prosperity, in that it has thus secured liberal and generous congressional action through half a century. Now Congress has not yet felt that its duty lies in establishing and supporting an astronomical observatory for research only, no matter how valuable this might be to the world at large. Its theory is that a practical *quid pro quo* must

be given for the people's money. The fact that the Navy needs a Nautical Almanac and a time service, and that these are practical utilities has been the ground for the annual appropriations. There is no other Department of the Government better fitted to press such claims upon Congress than the Navy, and to abandon this utilitarian ground would be to diminish the financial resources of the institution. As matters now stand there is no prospect of being able to persuade Congress to support such a research observatory; under the circumstances the nearest we can come to it is the free cooperation of the astronomers in the Naval Observatory. If these 'lay down' behind their commissions, or if their 'human nature' is too much for their good sense and the progress of science, there is no question where the responsibility should be placed. If it be true that the past generation at the Observatory, consisting of able, honorable men, failed to accomplish all they expected to do, may we not hope that the spirit of mutual cooperation between the executive and scientific staff, and the professors one with another, may still be the true remedy, rather than an angry discussion or any type of restrictive legislation which could be devised?

FRANK H. BIGELOW.

WASHINGTON, D. C., January, 10, 1901.

#### POTASSIUM NITRATE IN WYOMING.

LAST fall Mr. Victor Milward, of Dayton, Wyoming, sent me a small package of mineral which he wished tested for nitrates. The sample was a dark brown color, pulverent and contained a large amount of sand. Upon testing the substance I recognized that it was a nitrate and, in looking for the base, potassium was found in unusual quantities. Mr. McClelland an instructor in this department made a preliminary analysis and found that the sample contained upwards of fifty per cent. of potassium nitrate, and that it was nearly pure. Sodium was not detected. Mr. Milward was informed of his discovery and encouraged in making further investigations, and also asked to furnish some data as to his discovery and its extent. Later a number of samples of dark colored sandstone were received, that had been taken from

various depths and also a specimen from the surface of the prospect. The samples did not contain any of the salt except the one taken from the very surface. On this the nitrate was a coating about a quarter of an inch in thickness, and, as the previous sample sent, was approximately pure potassium nitrate. So far, the salt found is in very limited quantities and there are no explanations to offer for its existence or accumulation. It is evident that it has been brought in and deposited upon the sandstone but the source has not been detected. Owing to the winter months being close at hand when the discovery was made, it was not possible to carry on any extended examination. Potassium nitrate has been found in very minute quantities in the Leucite hills by Cross; this, however, is the most important discovery ever made in the State, and may result in the location of nitrate deposits of commercial importance.

WILBUR C. KNIGHT.

GEOLOGICAL LABORATORY,  
UNIVERSITY OF WYOMING,  
Jan. 16, 1901.

#### CURRENT NOTES ON PHYSIOGRAPHY.

##### SOUTHERN WISCONSIN.

'THE Geography of the Region about Devil's Lake and the Dalles of the Wisconsin' by R. D. Salisbury and W. W. Atwood (*Wis. Geol. and Nat. Hist. Survey*, Bull. v, Educational series, 1, Madison, 1900), is a significant publication if for no other reason than that it is concerned with geographical features and that it is a State publication 'primarily designed for use in the schools.' State surveys have been very slow in coming to recognize their responsibility in this direction; and we are glad to see Wisconsin now following Missouri, New Jersey and Maryland. The region described includes a typical resurrected mountain, Baraboo ridge, of Huronian quartzite, adjoined by a plain of erosion, too smooth over much of its extent to be called a peneplain, formed by the removal of paleozoic strata which once buried the ridge, and which still remain in isolated castle-like hills here and there over the plain, and more continuously in hilly uplands farther southwest. The Dalles of the Wisconsin river are cut in the plain where the

river has been displaced by glacial action from its former course. The 150 pages of the report are illustrated by 38 plates and 47 figures, and closed with a good index.

##### THE ISLANDS OF SOUTHERN CALIFORNIA.

'A TOPOGRAPHIC Study of the Islands of Southern California,' by W. S. Tangier Smith (*Bull. Dept. Geol., Univ. Cal.*, ii, 1900, 179-230) presents additional details concerning the features of this interesting group. The author points out that on a single shore line a wave-cut terrace of much strength may be developed where the coast has a moderate resistance and gentle slope, while hardly any shore marking is made where the coast is more resistant and of steeper slope. On San Clemente the rocks are relatively resistant and the general slope of the island is moderate; here wave-cut terraces at various levels have been remarkably developed and wonderfully preserved.

The occurrence of such terraces suggests some observations regarding the origin of those plains of erosion which now stand somewhat above sea level and are moderately dissected by streams, as in the Piedmont district of eastern Virginia and in the peninsula of Brittany. On both these plains the broad uplands are sheeted over with heavy soils of local weathering; the valleys that dissect the uplands are narrow and steep-sided. If the plains were of subaërial origin the abundant soils would be an appropriate feature; if the plains were the result of marine abrasion, the soils must have been developed by weathering on the wave-cut rock floor in the same period of time as that required for the erosion of the narrow valleys. The terraces of San Clemente may perhaps afford means of comparing the rate of soil production and valley erosion, and thus of giving further evidence regarding the origin of the districts in question.

##### DEECKE'S ITALIEN.

A WORK on the general geography of a country should not be criticised too closely with regard to its physiographic chapters, for there are many other lines toward which the chief interest of the author may have been drawn more strongly. It is nevertheless instructive to examine the method of treating land forms



that is found acceptable in an important volume of a new series of geographical handbooks. Deecke's work on Italy\* treats in its first chapter the limits and area of the country; in the second, the surrounding seas; in the third, the history of exploration; relief in the fourth, geological structure in the fifth, and climate and hydrography in the sixth and seventh. Then after 250 pages devoted to population, history, products and commerce, government and religion, the remaining 125 are given to the description of provinces ('Chorography'). In comment on this order, it may be said that it is not satisfactory from a physiographic standpoint to give a leading place to relief and a following place to geological structure; in such an order, relief must be treated empirically and to that extent imperfectly. Under hydrography many interesting details are given concerning certain rivers which have changed their courses in historical time—the Adige, the lower Po, and the Chiana between Tiber and Arno—but the development of rivers is hardly considered. The provincial descriptions include much material of value, yet they omit many facts that would shed useful light on local topography. Taken all together, the book is certainly good, but it does not contribute much to the development of the new scheme of geographical treatment that it is to be hoped may characterize similar works in the new century.

#### NORWAY.

A HANDSOME volume entitled 'Norway, official publication for the Paris exhibition, 1900' (Kristiana, 1900, 626 + xxxiv p., many plates, figures and maps) contains valuable chapters on topography, by Hansen; geology, by Reusch; and climate, by Steen, occupying 50 pages; the rest of the volume being given to history, social conditions, commerce, etc. Hansen gives a just emphasis to normal and glacial erosion in his account of surface features. The highland is described as an immense mountain plateau, whose 'even summits clearly indicate that it was originally a plain of denudation that has afterwards been forced up into an arch.' The

\* 'Bibliothek der Länderkunde' herausgegeben von Dr. A. Kirchoff und Dr. R. Fitzner. Berlin, Schall. 'Italien' von Professor Dr. W. Deecke, 1898.

summits that tower above it, being of harder rocks, may be supposed to have withstood the destructive forces which leveled the remainder. 'Actual connected mountain chains rising above lowlands at both sides do not exist.' Canyon like valleys, cut in the uplifted highland, were modified by strong glacial erosion, producing fords. The mountains that rise above the highland frequently have sharp alpine forms with corries (botner) which are described as having been developed in *névé* fields above level of the glacial sheet. The glaciated area exposes bare rock over so much of its surface as stands above the old shore line that marks post-glacial submergence; but below this line there are abundant sands and clays, affording arable land. The population is largely found below this level.

The relation of Norway to Sweden is interestingly presented. Although the two countries border each other along a boundary line that measures a thousand miles in length, by far the greatest part of this line lies on the uninhabited mountainous highland. The two countries are therefore separated rather than joined. Only three railroads and about a dozen highways cross the boundary. In 1898, only five per cent. of Norway's goods-exchange crossed the land frontier by railway and only one third of one per cent. by other means, while ninety-five per cent. went by sea.

WM. DAVIS.

#### UNITED STATES BOARD ON GEOGRAPHIC NAMES.

THIS Board, to which is referred questions of disputed geographic nomenclature arising in the Executive Departments of the Government, held its monthly meeting January 9th. Philippine Island names were considered at some length. The Coast and Geodetic Survey is about to issue an atlas of the Philippine Islands. This atlas will contain about thirty maps made by Jesuit missionaries in the islands. It is preceded by an introduction, which, among other things, has three lists, comprising in all about 6,000 geographic names. These names are now in the final proof stage. The list was prepared and the proof corrected by Rev. Father Algue, S. J., of Manila, but who has been

spending the winter in Washington. The Coast and Geodetic Survey asked the Board to adopt this list of names. The United States Hydrographic Office had previously submitted a manuscript list of about 4,000 coastwise names which list had been compiled in that office and asked for its adoption by the Board. To that request the Board had responded by recommending that it be submitted to Father Algue for comment, correction and criticism. This list with Father Algue's criticisms, together with the Coast and Geodetic Survey list was presented and discussed and, as the outcome, both lists were referred to the Hydrographic Office for comparison with a view to discovering cases of discrepancy.

The Board proceeded with its usual routine cases, deciding 21 of them. Most of these are minor features in different parts of the country, and thus of only local interest. For example, whether it is Bobs or Bobbs, Douglas or Douglass, Mullin or Mullen, Reem or Reams, etc. Such cases are for the most part easily disposed of by getting, by correspondence, local information.

Two or three cases were of wider interest. For a county in Idaho the Board adopts the form *Nez Perce* (not *Nez Percés*) conformably to the uniform practise in that county and in Idaho. For a river in southwestern Iowa the form *Nishnabotna* was adopted in place of several other forms which have been more or less used. For three glaciers in Glacier Bay, Alaska, were adopted the names *Carroll* (not *Woods*), *Grand Pacific* (not *Johns Hopkins*), and *Rendu* (not *Charpentier*). All these names, including the rejected forms, are still in use, but there has been confusion in their application. The Board follows the original usage as printed on Coast and Geodetic Survey map No. 3,095 (edition of July, 1899).

Finally, one more case in Alaska may be mentioned. The easternmost point of *Kadiak* is supposed to be the one seen by *Bering* in 1741 and by him called *St. Hermogenes*; on some charts written *Hermogenes*. *Cook* in 1778 called it *Greville*. Some of the Russian charts call it *Yelovoi* (spruce) and others *Tolstoi* (broad). Its supposed native name is *Chiniak*, which on one chart has appeared as

*Tuniak*. The present local usage is reported to be *Chiniak* and this was adopted by the Board.

#### SCIENTIFIC NOTES AND NEWS.

THE Geological Society of London has made the following awards for 1900: *Wollaston* medal, *Dr. C. Barrois*, Secretary of the International Geological Congress. *Wollaston* fund, *Dr. A. W. Rowe*, for papers on zonal geology and paleontology of the chalk of England; *Bigsby* medal, *G. W. Lamplugh*, of the British Geological Survey. *Murchison* medal to *A. J. Jukes-Browne*, of the same. *Murchison* fund, to *T. S. Hall*, of Melbourne, for work on the Tertiary Geology of Victoria. *Lyell* medal to *Dr. R. H. Traquair*, pal-ichthyologist of Edinburgh. *Lyell* fund to be divided between *Dr. J. W. Evans*, for work on Indian geology, and *A. McHenry*, of the Geological Survey of Ireland.

*WILLIAM H. CROCKER*, of San Francisco, has offered to defray the expenses of a solar eclipse expedition to be sent by the University of California from the Lick observatory to Sumatra to observe the total eclipse of the sun on May 17th. An astronomer and assistants will sail from San Francisco on February 19th to be absent until July. They will establish an observatory camp somewhere within twenty miles of Padang, on the west coast of Sumatra.

At the recent International Congress of Hygiene and Demography a committee was appointed on the hygiene of streets, of which *Dr. R. Hering* of New York is the American member.

AMONG the honors conferred by Queen Victoria for the New Year are the *K.C.B.* on *Sir William Turner*, professor of anatomy in the University of Edinburgh, and baronetcies on *Dr. William Church*, president of the Royal College of Physicians, and *Dr. Thomas Barlow*, a London physician.

*PROFESSOR E. VON DRYGALSKI*, of the University of Berlin, has been elected an honorary corresponding member of the Royal Geographical Society of London.

THE *Spencer Lens Company*, Buffalo, N. Y., of which *Dr. Roswell Park* is president, announces that it has placed its scientific

department in charge of Dr. Hermaun Kellner, who has been associated with Professor Abbe in the optical works of Carl Zeiss at Jena. Mr. Carl F. Dieckmann, who has also been employed at the Zeiss optical works, has been engaged as superintendent.

DR. BUSHROD W. JAMES, of Philadelphia, has been elected president of the Pennsylvania Fish Protective Association.

MR. G. T. HASTINGS, who was last year assistant in botany in Cornell University, is this year teacher of science in the English Institute, Santiago, Chili. Mr. Hastings's engagement is for five years, and during that time he expects to make a thorough study of the flora of the region.

DR. VICTOR C. VAUGHAN, professor of hygiene in the University of Michigan, has been appointed to a third term as member of the Michigan State Board of Health.

PROFESSOR E. F. BUCHNER, of the department of psychology of New York University, has been elected an honorary member of the new French Société Libre pour l'Étude Psychologique de l'Enfant, of which Professor F. Buisson, of the Sorbonne, is president.

THE Science Club of Northwestern University held its last meeting on the evening of January 11th. The Club was addressed by Professor A. V. E. Young on 'A Century of Discovery among the Elements.'

PROFESSOR WILLIAM HALLOCK, of Columbia University, gave on January 22d the second address before the Washington Academy of Sciences on the 'Progress and Tendency of Science during the Nineteenth Century,' his subject being physics.

DR. DAVID T. DAY, of the United States Geological Survey, is giving a series of Columbia University lectures at the American Museum of Natural History on Saturday evenings, as follows: January 5th, 'The Mining Outlook of the Opening Century'; January 12th, 'The World's Mineral Wealth as shown at the Paris Exposition'; January 19th, 'The Petroleum Industry of the United States'; January 26th, 'The Mineral Resources of Cuba, Porto Rico, Hawaii and the Philippines.'

THE Friday evening meetings of the Royal Institution of Great Britain opened on January 18, 1901, when Professor Dewar was expected to give a lecture on 'Gases at the Beginning and End of the Century.'

DR. HARTINGTON, who has been relieved from the position of head of the medical department of the University of West Virginia by the Board of Regents, has brought suit to recover \$25,000 from the president of the University.

THE death is announced of M. Charles Hermitte, the eminent French mathematician, at the age of seventy-eight years.

THE death is also announced at the age of seventy-five years of Dr. Potain, professor of medicine at various institutions in Paris since 1876, member of the Academy of Medicine since 1882, and of the Academy of Sciences since 1894.

THE position of hydrographic draughtsman in the U. S. Coast and Geodetic Survey, at a salary of \$600 per annum, will be filled by Civil Service examination on February 5th and 6th.

WE are requested to state that a young Russian gentleman, now living at St. Petersburg, who has done excellent work in physics and bacteriology, desires to find a position in the United States in the field of physiology or the applications of physics. Those interested in this matter will do well to correspond directly with His Excellency, Dr. H. Wild, 56 English Viertel-Str., Zurich, Switzerland, or with Professor Cleveland Abbe, Washington, D. C.

THE Carmichael prize of the Royal College of Surgeons in Ireland, which is of the value of £120, has been awarded to Mr. H. Nelson Hardy, F.R.C.S.Ed. for an essay dealing with the state of medicine, surgery and pharmacy in the United Kingdom.

THE Astley Cooper triennial prize of £300 will be awarded by Guy's Hospital, London, for an essay on 'The Pathology of Carcinoma and the Distribution and Frequency of the Secondary Deposits corresponding to the Various Primary Growths.' The essays should be sent to Guy's Hospital on or before January 1, 1904.

THE New York Zoological Society has presented the American Museum of Natural History with the following specimens: A young

moose (*Alces americanus*), an equine deer (*Cervus equinus*), an orang utan (*Simia satyrus*), a loris (*Nycticebus tardigradus*), an ocelot (*Felis pardalis*), three bay lynxes (*Lynx ruffus*), a jaguarondi (*Felis jaguarondi*), two black leopards (*Felis pardus*), a raccoon (*Procyon lotor*).

At the 526th meeting of the Philosophical Society of Washington, held December 22, 1900, in the assembly room of the Cosmos Club, the following officers were elected for the calendar year 1901: *President*, C. D. Walcott, Geological Survey; *Vice-Presidents*, R. Rathbun, Smithsonian Institution; J. H. Gore, Columbian University; C. Adler, Smithsonian Institution; E. D. Preston, Coast Survey; *Treasurer*, B. R. Green, Library of Congress; *Secretaries*, J. F. Hayford, Coast Survey; C. K. Wead, Patent Office; *General Committee*, W. A. DeCaindry, War Department; G. W. Littlehales, Hydrographic Office; H. M. Paul, Navy Department; F. W. True, National Museum; I. Winston, Coast Survey; J. E. Watkins, National Museum; J. G. Hagen, Georgetown Observatory; C. F. Marvin, Weather Bureau; L. A. Bauer, Coast Survey.

At the annual meeting of the Anthropological Society of Washington, on January 8th, the following officers were elected: *President*, W. H. Holmes; *General Secretary*, Hannah L. Bartlett; *Treasurer*, Perry B. Pierce; *Curator*, Mariana P. Seaman; *Councilors-at-large*, Alice C. Fletcher, J. Walter Fewkes, and J. D. McGuire. At the ensuing meeting of the Board of Managers the councilors were increased by the election of Weston Flint, F. W. Hodge, Walter Hough, George M. Kober, D. S. Lamb, John H. McCormick, Edith C. Westcott and Thomas Wilson; and the organization was completed by selecting Walter Hough as Secretary to the Board, and designating the vice-presidencies as follows: Somatology, D. S. Lamb; psychology, Frank Baker; esthetology, W. J. McGee; technology, J. Walter Fewkes; sociology, George M. Kober; philology, J. W. Powell; sophiology, Alice C. Fletcher.

At the annual meeting of the Columbia Historical Society, held on January 7, 1901, officers for the ensuing year were elected as follows: *President*, John A. Kasson; *First Vice-President*,

Ainsworth R. Spofford; *Second Vice-President*, A. B. Hagner; *Treasurer*, J. Dudley Morgan; *Recording Secretary*, Mary Stevens Beall; *Corresponding Secretary*, M. I. Weller; *Curator*, James F. Hood; *Chronicler*, William B. Bryan; *Managers* (for term expiring in 1905), Lewis J. Davis and J. Ormond Wilson.

It will be remembered that at the fourth International Zoological Congress, held at Cambridge in 1898, it was decided that the fifth Congress, in 1901, should be held in Germany. Announcement has now been made, says *Nature*, that the meeting place will be Berlin, on August 12-16, and the president, Professor K. Moebius, director of the zoological collection of the Natural History Museum, with Professor F. E. Schulze, director of the Zoological Institute, as vice-president. The secretaries of the Congress will be Herr P. Matschie, Dr. M. Meissner and Dr. R. Hartmeyer. The treasurers will be Herr H. Schalow and Herr Otto Stutzbach. Arrangements as to meetings and papers will be in charge of Professor L. H. Plate; apartments and receptions will be under the care of Dr. L. Heck, and the lighter pleasures of the meeting will be managed by Dr. O. Jaekel. The meetings will be held in the Natural History Museum and neighboring rooms of the University. Among the subjects to be brought before the Congress are the following: 'Fossil Remains of Man,' Professor Branco (Berlin); 'Vitalism and Mechanism,' Professor Bütschli (Heidelberg); 'Theories of Fertilization,' Professor Yves Delage (Paris); 'The Psychological Attributes of Ants,' Professor A. Forel (Morges); 'The Malarial Problem from a Zoological Point of View,' Professor Grassi (Rome); 'Mimicry and Natural Selection,' Professor E. B. Poulton (Oxford). After the conclusion of the Congress an excursion will be made to Hamburg for the purpose of visiting the Natural History Museum and Zoological Garden there, and also to Heligoland. Communications concerning the Congress should be made to the president, 43, Invalidenstrasse, Berlin, N. 4. Admission to the Congress will be free to all zoologists and all friends of zoology.

It is stated in *Terrestrial Magnetism* that the Magnetic Observatory at Cheltenham, Mary-

land, near Washington, D. C., which is to form the principal base station of the magnetic survey of the United States, is now ready for the installation of the instruments. The buildings were constructed under the superintendency of Mr. J. A. Fleming, of the Coast and Geodetic Survey, who also drew up the plans. Dr. W. G. Cady, a graduate of Brown University, and of the University of Berlin, and a member of the Division of Terrestrial Magnetism during the past six months, will have principal charge of the observational work. It is the intention to carry out at this observatory magnetic, meteorological, seismological, atmospheric-electric, and earth current observations.

At the meeting of the New York Zoological Society on January 15th the following officers were reelected: *President*, Levi P. Morton; *Executive Committee*, Levi P. Morton, *ex-officio*; Henry F. Osborn, chairman; John L. Cadwalader, counsel; Charles T. Barney, John S. Barnes, Philip Schuyler, Madison Grant and William White Niles. The report of the Executive Committee sets forth the necessity for an increase of annual membership to 3,000. The income is now \$7,900 annually, and what is needed is an income of \$30,000 annually. The report speaks of the increasing attendance, and says that with the additional increase from rapid transit the walks, paths and buildings will be taxed to their utmost. The total attendance for the year was 325,925. Regarding the funds appropriated by the city for maintenance of the park, the report has this to say: "For two years there has been a deficiency in maintenance, owing to no lack of good will on the part of the city authorities, but a failure to appreciate the needs of the Park. In 1899 the City contributed \$30,000 and the Society contributed \$7,038.61 towards the maintenance of the Park. In 1900 the maintenance fund of \$40,000 again resulted in a serious deficiency, which has been met by the Society by a contribution of \$6,524.04. The Society estimated \$80,000 as the fund needed for 1901, in order to meet the increased demand for food and additional keepers; the fund assigned is \$65,000. We trust that this fund will enable the committee by the greatest economy to maintain the

Park on its present limited scale without a serious deficiency.

MR. CARNEGIE has offered to build at Syracuse a library for \$200,000. The city will provide a site and \$30,000 for maintenance.

THE new building for the Boston Medical Library was formally opened on January 12th. The speakers announced on the program were: Dr. Francis W. Draper, president of the Massachusetts Medical Society; Dr. William Osler, professor of medicine in Johns Hopkins University; Dr. John S. Billings, librarian of the New York Public Library; Dr. Horatio C. Wood, of the University of Pennsylvania, and Dr. Henry P. Walcott, acting president of Harvard University. The new building, which is on the Fenway, is of stone and brick, and contains ample accommodation for the library of 32,000 volumes, together with rooms for lectures and meetings.

THE Swiss Parliament has voted a permanent subsidy to the Concillium Bibliographicum, which assures the continuation of the work inaugurated and carried forward with so much energy by Dr. H. H. Field. The vote was passed without opposition in the lower house and nearly unanimously in the upper house.

THE executive board of the Association for maintaining the American Women's Table at the Zoological Station at Naples and for promoting Scientific Research by Women announces that, in addition to maintaining a table at Naples, it is able to offer for the season 1901 the free use of a table at the Marine Biological Laboratory at Wood's Holl. The appointments are made by the executive board, with the cooperation of a regularly appointed board of advisors, on whose judgment the executive committee relies for decision in questions relating to the scholarship of candidates based on the results of work presented for examination. The members of the present board of advisors are Professor Ethan A. Andrews, of Johns Hopkins University, Professor R. H. Chittenden, of Yale University, and Dr. W. T. Porter, of the Harvard Medical School. The year of the Association begins in April, and all applications for the year 1901, both for the table at Naples and for that at Wood's Holl,

should be sent, on or before March 1, 1901, to the secretary, Miss Florence M. Cushing, 8 Walnut street, Boston, Mass.

As we have already announced the same Association has offered a prize of one thousand dollars for the best thesis presented by a woman, on a scientific subject, embodying the results of her independent laboratory research in any part of the field covered by the biological, chemical and physical sciences. The board of examiners for the prize is as follows:

*Biological Sciences:* Dr. William H. Howell, Johns Hopkins Medical School; Dr. William Trelease, Washington University; Dr. Charles O. Whitman, University of Chicago; Dr. Edmund B. Wilson, Columbia University.

*Chemical Sciences:* Dr. Russell H. Chittenden, Yale University; Dr. John U. Nef, University of Chicago; Dr. Ira Remsen, Johns Hopkins University; Dr. Theodore W. Richards, Harvard University.

*Physical Sciences:* Dr. Carl Barns, Brown University; Dr. Albert A. Michelson, University of Chicago; Dr. Edward W. Morley, Western Reserve University; Dr. Arthur G. Webster, Clark University.

THE International Mining Congress will meet at Boise, Idaho, in July of the present year.

ACCORDING to a recent bulletin of the Census Bureau, the center of population of the United States is now latitude 39.9.36; longitude, 85.48.54, having moved westward about fourteen miles and southward about three miles since the last census.

THE *British Medical Journal* states that Professor Claudio Fermi and Dr. Tonsini, of Sassari, have recently reported the results of experiments in the prophylaxis of malaria made by them in the island of Asinara, off the north-west coast of Sardinia. They succeeded in destroying the *Anopheles* larvæ by means of petroleum poured into the pools of the island. This was repeated twice a month. The process was begun in June and continued until the end of November. The mosquitoes in the air were destroyed inside houses by means of a mixture of powdered pyrethrum, chrysanthemum, valerian, etc., and the *zanzolina* of Celli and Casagrandi. In the dormitories of prisons, when there was nothing better available, chlorine, generated by treating calcium chloride

with sulphuric acid, was employed. Protective nettings were applied to windows. The result was that hardly any *Anopheles* were found in any dwelling, while *Culex pipiens* was much scarcer than in former years. Not a single case of primary malaria was observed.

THE Wisconsin Geological and Natural History Survey has in press two bulletins of its economic series. One of these is the first part of a report on the clays and clay industries of the State and is by Dr. E. R. Buckley, assistant superintendent of the Survey. The other, written by Professor U. S. Grant of Northwestern University, deals with the copper-bearing rocks of the northern part of the State. It is expected that these bulletins will be issued in January, 1901.

WE quote the following editorial note from *Nature*: "A few weeks ago the new anthropological collections in the American Museum of Natural History in New York were opened to the public, and these valuable collections now occupy five halls, and others are being provided. We learn from our contemporary, SCIENCE, that the accessions to the anthropological collections of the museum obtained during the last three years have largely been due to extended scientific research undertaken by the institution. In this respect the methods of the American Museum of Natural History differ considerably from those pursued by a number of other institutions. It has not been the policy of the museum to accumulate rapidly and indiscriminately more or less valuable specimens collected on trading expeditions or purchased from dealers; but an endeavor has been made to build up representative collections and to obtain at the same time the fullest and most detailed information in regard to specimens, so that each addition to the exhibit of the museum can be made thoroughly instructive and will represent a material contribution to science. There is no doubt this is the best way to build up a museum, and it is to be deplored that the various museums of the British Islands do not follow the example so worthily set by this and other American museums. Our English method is rather to wait like a spider in its web in the hope that something will eventually be caught;

in the meanwhile, other institutions are intelligently collecting wholesale in diverse interesting regions, while we are content with occasional specimens which usually have no history, or at most a very imperfect one, and for these we often have to pay a stiff profit to a dealer."

THE *New York Times* lays stress on its announcement that the newspaper contains 'all the news that's fit to print.' Does the editor regard the following, taken from a recent issue as 'fit to print'?

"James Conroy, of 127 Hopkins Avenue, Jersey City, claims to have devised a system of springs and weights, which, operating as a balance, will run machinery without the aid of fuel, electricity, or any other motive power. The system is so simple, he says, that the only wonder about it is that it was never discovered before. It may be operated, he says, by a boy. While it is not perpetual motion, he says it will run until one of the springs or some other part of the arrangement breaks, but that will only mean a cessation of movement until a new part is substituted for that which is broken. He will not exhibit his machinery, but says he has demonstrated its power by operating a pump in his house. All he will say is that the power is furnished according to a decimal system making ten pounds the unit of weight. This unit may be increased by multiples of ten until the desired power for any machine is attained. He says he can easily satisfy any engineer of the validity of his claims. Another thing Mr. Conroy claims is that should any part of the machinery break the machine will not be wholly disabled, but will continue to run with a power diminished only by the broken part, which will be one-tenth, the diminution continuing in that ratio for each broken part."

THE Calcutta correspondent of the *London Times* cables that since the Pasteur Institute was opened at Kasauli about 100 patients bitten by mad dogs have been treated, among whom not a single death has occurred. Appeals for funds from the municipalities, however, have been rejected. Native opinion, especially among the Hindus, joins the Buddhists in pronouncing against the Institute owing to a mistaken idea that cruel operations are practised upon living dumb animals. Memorials have been submitted to the Government protesting against State aid, though this is only given to enable British soldiers to be treated in India instead of proceeding to Paris, thus saving a

large sum annually. Bishop Welldon, preaching in the cathedral, referred to the opposition to the Institute in England and India. He said he had visited Kasauli and seen the operations, and stated that the medical process was characterized in all its aspects by the most thoughtful and scrupulous humanity. Anesthetics were employed, and the animals showed no visible sign of suffering, dying eventually, not of hydrophobia, but of paralysis. He urged people to be slow to condemn a remedial process which, at the cost of a slight infliction of pain on animals, relieved and removed suffering so intense as hydrophobia in the case of human beings.

THE report of the Meteorological Council of the Royal Society for the year ended March 31, 1900, has been issued. The work of the council is summarized under the heads of ocean meteorology, weather telegraphy and climatology. The inquiry relative to the unusually severe weather which prevailed in the Atlantic during the winter 1898-99 has been completed, and the charts illustrating the results of the investigations will be ready for publication shortly. A table is given comparing the forecasts for the United Kingdom with the subsequent weather actually experienced. The complete success, partial success, partial failure and complete failure of the forecasts are estimated according to definite rules. Partial success and partial failure are defined as meaning that the forecast was correct or incorrect for more than half the elements dealt with at the places of observation situated in the district in question. This table, when summarized, gives 55 per cent. of complete successes, 27 per cent. of partial successes, 12 per cent. of partial failures and 6 per cent. of complete failures.

#### UNIVERSITY AND EDUCATIONAL NEWS.

THE following large gifts for education have been made during the week: John D. Archbold of New York City, a vice-president of the Standard Oil Company, has given \$400,000 to the endowment fund of Syracuse University, on the condition that a like amount be raised among other friends of the institution; Mr. Andrew Carnegie has given \$225,000 to the

Upper Iowa University, at Fayette, Ia., to be used preferably for a library, and \$50,000 to Aurora College, an Illinois institution; Augustana College at Rock Island, Ill., has received about \$30,000 from Messrs. E. C. and J. A. Eriesson, of Boone, Ia.; Mr. John D. Rockefeller has offered to give \$15,000 to Carson and Newman College, a Baptist institution in Tennessee, provided \$50,000 in addition be raised; Carleton College, at Northfield, Minn., has added \$150,000 to its permanent endowment fund, \$50,000 being the gift of Dr. D. K. Pearsons, and the remaining \$100,000 being raised from various sources.

GIFTS to educational institutions in Great Britain include the following: Mr. Charles W. Mitchell, £20,000 to the University of Aberdeen to pay the debt of the University; Lord Durham, £1,000 towards the building fund of the Durham College of Science, and the Misses Mercer, £1,000 to establish a scholarship, or scholarships, in chemistry at the Blackburn Technical School in memory of the late Mr. John Mercer, the discoverer of the process of Mercerized yarn.

THE registration at Harvard University, as recorded in the issue of December 21st last of this journal, appears to need correction. Professor Storer calls our attention to the fact that the figures for the Bussey Institute and for the veterinary school were not included. These should be 33 and 18 respectively. On the other hand, the registration of the Medical School is too large. Dean Richardson, of the Medical School has explained the matter as follows: "Mr. Cram must have misunderstood your question and gave you the number enrolled, which at that time was 600, and added to it the number which were enrolled in the summer courses, 149, making a total of 749."

THE President of the Board of Education, London, has appointed a committee, consisting of Sir William de W. Abney, K.C.B., F.R.S. (Chairman), Sir Philip Magnus, Sir Swire Smith, Mr. G. R. Redgrave, Mr. W. Bousfield, Mr. W. Vibart Dixon, with Mr. A. E. Cooper, Board of Education, South Kensington, as Secretary, to consider the best means for coordinating the technological work of the Board of Education

with that at present carried on by other educational organizations.

A CABLE despatch from St. Petersburg reports that one hundred and fifty students, recently arrested at Kieff for engaging in political agitation, are to be expatriated to Port Arthur, where they will do military service. The same fate awaits scores of students arrested at the capital on a similar charge. The ferment continues among students throughout the country, and disturbances are anticipated. The troubles at Kieff do not seem to have been due to political agitation but to the unwillingness of the students to attend the lectures of an unpopular professor.

MR. H. V. CARPENTER, assistant in physics at the University of Illinois, has accepted an assistant professorship in physics and electrical engineering in the Washington Agricultural College, at Pullman, Washington. Mr. Carpenter is a graduate of the University of Illinois.

MR. U. S. HANNA, Harrison fellow in mathematics and astronomy of the University of Pennsylvania, has resigned his fellowship to resume his duties as instructor in mathematics at the University of Indiana.

MR. S. W. REAVES, graduate scholar in Cornell university, has been appointed instructor of mathematics in Orchard Lake Military Academy.

Dr. F. MONTESER has been promoted to a professorship of mathematics in the School of Pedagogy, New York University.

Mr. C. T. R. WILSON, F.R.S., fellow of Sidney Sussex College, Cambridge, has been appointed university lecturer in experimental physics in succession to Professor Wilberforce, who, it will be remembered, recently accepted a call to Liverpool.

Dr. P. DRUDE, professor of physics in the University at Giessen, has been called to Tubingen. Dr. A. Voelzmann, of Berlin, has been promoted to a professorship of zoology. Dr. A. Steur has qualified as docent in geology in the Technical Institute at Darmstadt, and Dr. George Wetzel for anatomy in the University at Berlin.



# SCIENCE

A WEEKLY JOURNAL DEVOTED TO THE ADVANCEMENT OF SCIENCE, PUBLISHING THE OFFICIAL NOTICES AND PROCEEDINGS OF THE AMERICAN ASSOCIATION FOR THE ADVANCEMENT OF SCIENCE.

EDITORIAL COMMITTEE: S. NEWCOMB, Mathematics; R. S. WOODWARD, Mechanics; E. C. PICKERING, Astronomy; T. C. MENDENHALL, Physics; R. H. THURSTON, Engineering; IRA REMSEN, Chemistry; JOSEPH LE CONTE, Geology; W. M. DAVIS, Physiography; HENRY F. OSBORN, Paleontology; W. K. BROOKS, C. HART MERRIAM, Zoology; S. H. SCUDDER, Entomology; C. E. BESSEY, N. L. BRITTON, Botany; C. S. MINOT, Embryology, Histology; H. P. BOWDITCH, Physiology; J. S. BILLINGS, Hygiene; WILLIAM H. WELCH, Pathology; J. McKEEN CATTELL, Psychology; J. W. POWELL, Anthropology.

FRIDAY, FEBRUARY 1, 1901.

A DECADE OF NORTH AMERICAN PALEOBOTANY. 1890-1900.\*

## CONTENTS:

<i>A Decade of North American Paleobotany:</i> PROFESSOR D. P. PENHALLOW .....	161
<i>Determination of the Sun's Distance from Observations of Eros:</i> PROFESSOR W. W. CAMPBELL .....	176
<i>On the Nature of the Solar Corona, with some Suggestions for Work at the Next Total Eclipse:</i> PROFESSOR R. W. WOOD .....	179
<i>Chicago Section of the American Mathematical Society:</i> PROFESSOR THOMAS F. HOGGATE .....	181
<i>Wisconsin Academy of Sciences, Arts and Letters:</i> FRANK CHAPMAN SHARP .....	181
<i>Scientific Books:—</i>	
<i>Ormond on the Foundations of Knowledge:</i> PROFESSOR R. M. WENLEY. <i>Cohnheim's Chemie der Eiweisskörper:</i> PROFESSOR LAFAYETTE B. MENDEL. <i>Notter's Treatise on Hygiene:</i> DR. W. H. PARK .....	182
<i>Scientific Journals and Articles:</i> .....	186
<i>Societies and Academies:—</i>	
<i>Geological Society of Washington:</i> DR. F. L. RANSOME AND DAVID WHITE. <i>Biological Society of Washington:</i> F. A. LUCAS. <i>Philosophical Society of Washington:</i> CHARLES K. WEAD. <i>The Las Vegas Science Club:</i> T. D. A. C. <i>New York Section of the American Chemical Society:</i> DR. DURAND WOODMAN .....	187
<i>Discussion and Correspondence:—</i>	
<i>Note on Vegeto-electricity:</i> I. THORNTON OSMOND. <i>Scientific Expedition to Iceland, Greenland and Labrador:</i> DR. R. A. DALY .....	191
<i>Current Notes on Meteorology:—</i>	
<i>Report of the Chief of the Weather Bureau; West Indian Hurricanes; The Monthly Weather Review:</i> PROFESSOR R. DE C. WARD .....	192
<i>Botanical Notes:—</i>	
<i>Botanical Opportunities in Washington; Central Massachusetts Forests; Chrysanthemum Rust:</i> PROFESSOR CHARLES E. BESSEY .....	193
<i>The National Observatory Question</i> .....	195
<i>Scientific Notes and News</i> .....	196
<i>University and Educational News</i> .....	199

THE history of paleobotany constitutes a record of the most persistent and painstaking efforts to unravel a series of great facts which have been left by the wayside of time through an untold period of the earth's history, and to interpret them with reference to their true significance in the life of this planet.

Although attention had been directed to the phenomena of plants preserved in the crust of the earth essentially with the first discovery of coal, their occurrence did not excite very marked interest until the latter part of the seventeenth century—the observations of that time being made from the standpoint of the curious in nature, rather than from an appreciation or even suggestion of their scientific value, and it was not until 1709 that the first meritorious attempt to describe them in a scientific spirit was made. From then on through the remainder of the eighteenth century, a very considerable literature accumulated, and the infant science passed through what Ward has so very aptly called the 'twilight of its development,' while very nearly a full century passed before Schlotheim published the results of those studies which must be taken

MSS. intended for publication and books, etc., intended for review should be sent to the responsible editor, Professor J. McKeen Cattell, Garrison-on-Hudson, N. Y.

\* Address of the President of the Society of Plant Morphology and Physiology, given before the Baltimore Meeting, December, 1900.

as the real commencement of paleobotanical investigation. His work gains special prominence by reason of his having been the first to definitely and authoritatively deny the deluge theory and to assert that fossil plants represent the remains of an earlier vegetation, the originals of which are no longer to be found. But it was not until the time of Sternberg and Brongniart, of Lindley and Hutton, of Witham and of Göppert from two to three decades later, that interest in this line of research gained sufficient impetus to make its continuity assured. From that time on, progress has advanced at an accelerating rate, but the one fact which we need to keep clearly before us is that such progress as has been made in this branch of botanical science has been accomplished within the last seventy years. The activity thus referred to was chiefly confined to Europe, at least during the first half of the century, but it is of value to note that the great interest in such work, which centered there, in all probability had a well-defined influence upon the same line of studies in America—indeed, we may almost say a determining influence in promoting that spirit of enthusiasm for a subject then surrounded with the greatest difficulties, which has led to such noteworthy results. It is at least a fact of more than passing interest that the two earliest among the great paleobotanists of this continent—Dawson and Lesquereux—entered upon their work here just before the completion of the first half-century, and it seems not unlikely that while the one had imbibed a strong predilection for such studies from those eminent geologists with whom he had been associated while a student at Edinburgh, the other had gained inspiration not only from his scientific associates at Neuchâtel, but also from the success of his earlier efforts as a botanist and his special studies of peat bogs for which he received the government medal, and through which

also, he gained wide celebrity. It was, therefore, but natural that in returning to his native land to follow out the ideas so well established in Europe, Dr. Dawson should at once apply himself to the solution of the many problems which the rich deposits of fossil plants in the neighborhood of his own home at once suggested; and that Lesquereux, seeking in the United States an asylum from the political troubles which drove him and his colleagues from Switzerland, should at once continue there those studies which had already brought renown, and, in the rich deposits of Pennsylvania, Ohio and other States, endeavor to read the story of the ages as inscribed in the rocks of the Carboniferous formation. These facts are of significance in considering the progress of paleobotanical work on this side of the Atlantic, since Dawson and Lesquereux, the one in Canada and the other in the United States, were its most powerful exponents. Newberry was born and educated in the States, so that his activity in this direction was the result of purely local conditions. He, nevertheless, contributed most important results, chiefly in connection with public surveys, and his name stands with those of Dawson and Lesquereux as foremost among the paleobotanists of this continent. It is impossible to consider any progress in this subject, either now or in the immediate past, without reference to their work, since it stands as the foundation of that from which some of our most important deductions may be derived.

Lesquereux died on the 25th of October, 1889; Newberry died on the 7th of December, 1892, while Dawson died on the 19th of November, 1899, and thus within the short space of a decade there passed from our midst three of the most notable of the scientific men of this continent. I have felt it to be of special importance to give prominence to these names, since they stand

as the great link which binds the old to the new. As they commenced their work under conditions which are unknown to-day, they completed it with a full recognition of the different point of view which had been introduced by the wonderful progress of botanical science in recent years, and their final publications fell within the closing decade of the century. With the disappearance of these three men whose great activity accomplished so much, we now turn to the Smithsonian Institution and the United States Geological Survey, with their superb resources in material, appliances, and a well-trained staff of scientific men, as the real center of our future progress.

The somewhat peculiar conditions surrounding the study of fossil plants in the earlier days of the subject somewhat naturally led to its exploitation by geologists into whose hands it fell, and where it has very largely remained until the present day. There has thus arisen a somewhat prevalent idea that the study of fossil plants constitutes a science altogether apart from that of botany, and for this state of affairs the botanists are themselves chiefly to blame for not promptly claiming and cultivating a field peculiarly their own, for, as Ward well observes, "Botanists have, as a rule, ignored paleontology, while the paleontologists have gone on with their classifications in total disregard of the former." And he very appropriately adds that "The mutual dependence of these two branches of botanical science upon each other is so apparent that it is certainly a matter of surprise that it has received so little recognition by scientific men."

In whatever conditions this state of affairs may have had its origin, it is certainly gratifying to observe that botanists generally are more keenly appreciative of the valuable nature of the evidence which fossil plants may afford in solving questions

of descent. It is also encouraging to discover that history does not fully sustain the extreme charge which has been brought against the botanical profession. Accepting Ward's list of twenty-two men from Scheuchzer to Carruthers, who may be considered to constitute the world's great leaders in paleobotanical research, it is to be noted that fifty per cent. were especially trained and exercised their profession as botanists—there being among the number those who have produced a strong impress upon the general history of the science, and it will well repay us to briefly glance at some of their achievements.

In 1820 Sternberg commenced the issue of his well-known *Flora der Vorwelt*, the publication of which extended over a period of eighteen years. This important work, together with the succeeding works of Brongniart, Göppert and Corda, opened the way for the final reception of the idea of evolution in plants.

To Adolph T. Brongniart, a contemporary of Sternberg's, must be ascribed the greatest measure of influence exerted upon the development of paleobotany during the first three decades of the century,—a fact so eminently true that he is commonly spoken of as the real founder of the science. His observations upon the formation of pollen grains in the mother cells of *Cobaea*, and the frequency of occurrence of the pollen tube, were the first to direct attention to this new line of inquiry. In 1843 he devised and published a system of classification which not only maintained a strong hold in France for many years, but it gained many adherents throughout Europe. In his work on fossil plants we gain, for the first time, a definite indication of that succession in the development of plant life through the various geological formations, which constitutes so important a feature of modern botanical science.

Göppert was the first to draw attention

to a rise in temperature during the process of germination, and his works on fossil plants are too extensive and well known to require special consideration at this time; but in the prosecution of his studies, he strongly emphasized the necessity of treating all such remains from a strictly botanical point of view, and he was especially prominent in giving great weight to characters derived from a study of the internal structure, thus recognizing the school already founded by Witham in England.

Corda was already well known for his valuable work on the fungi and mosses, before entering upon those paleobotanical studies through which his name more commonly appears.

The great number and value of Unger's contributions to botanical science lent special weight to his conclusions respecting fossil plants. In 1837 he described the spermatoids in various mosses and declared them to be the male elements of fertilization. In 1855 he first directed attention to the great resemblance between the protoplasm of the plant cell and the sarcode of the more simple animals,—a discovery which was later brought into great prominence and finally led to the conclusion that protoplasm is the foundation of all organic development. He was the first to successfully oppose Schleiden's theory of free cell formation as applied to the growing apex of stems, and to show that such cells arise by division—having their origin in a meristem. His work, in conjunction with that of von Mohl, Nägeli, Braun and Hofmeister, laid the foundation for a true conception of cell formation. In his 'Anatomie und Physiologie der Pflanzen' he introduced many new and valuable ideas respecting the character of the protoplasm, and gave a concise idea of the cell in its various complexes as families, tissues and fusions. With von Mohl's text-book, this work accomplished more than any other in

disseminating a knowledge of the subject up to 1860. In 1850 he issued the first complete manual of fossil plants, giving a systematic account of 2,421 species.

C. F. Schimper founded the theory of phyllotaxis. He first contributed to the study of fossil plants in 1840, and his 'Traité de paléontologie végétale' constitutes the most important of all the works on fossil botany as presenting a complete manual of the subject in accordance with the then current ideas of botanical science.

Williamson has contributed to the advance of paleobotanical knowledge in so many important ways, especially during his later years in conjunction with Carruthers, that a preliminary statement of progress would be wholly incomplete without reference to his work. His earliest experiences were gained in making the illustrations for 'Lindley and Hutton's Fossil Flora of Great Britain in 1837.' Since then his time was largely devoted to independent research in the same field, with a success which is well known, and his studies of the carboniferous flora of Great Britain have resulted in most important contributions to our knowledge of those early types of vegetation. This is especially true with respect to the Calamariaceae, Lepidodendreae, Sphenophylleae, the ferns and Lyginodendron. In the case of the first two, more particularly, he laid the foundation for all our subsequent knowledge respecting them. He furthermore showed that in Lyginodendron the fructification places this group of plants beyond question among the archegoniates, but that like recent Gymnosperms, they possess a secondary wood growth from a cambium layer. In establishing this fact he came into direct contact with the views of Brongniart, who held the formation of the wood from a cambium layer to be an absolute criterion of the phanerogams. From Heterangium and Lyginodendron he reconstructed a type of plant which he de-

scribed as having characters intermediate between those of the ferns and the Gymnosperms, and he thus opened the way for the final recognition of the Cycadofilices by Potonié, to which also such hitherto doubtful types as *Medullosa* and *Myelopteris* undoubtedly belong—a group of plants the recognition of which has gone far toward clearing up most important questions relating to the phylogeny of the Gymnosperms, and of the Cycads in particular.

It will thus be seen that to a large extent at least the study of fossil plants has proceeded on lines parallel with those in other branches of botanical science, and that the growth of the subject has substantially been directed by men eminent as botanists. Originally employed as a distinctive term for a subject supposedly outside of botanical science, paleobotany has more recently come to have equal rank with other divisions of the science such as histology, physiology, ecology, etc. Such artificial distinctions as formerly existed are fast disappearing, and we are now rapidly approaching, if we have not already entered upon, the first stages in the realization of that harmony between the botany of recent and extinct forms, the accomplishment of which Ward in 1885 recognized as so eminently desirable, but considered so difficult of attainment.

One of the earliest views attaching to the relations of paleobotany and geology was that of the supposed value of fossil plants in determining the age of deposits, and this found expression in the idea that the sequence with which plants were known to occur must be correlated with the succession of geological formations in such a way that the age of the latter could be ascertained by an examination of the flora. Although fundamentally correct, the precise application of the principle was found to lead to such erroneous conclusions that geologists soon came to look upon the evi-

dence of fossil plants as untrustworthy, and it is only within recent years that there has been any material alteration in this point of view. So long ago as 1871, however, we find Sir William Dawson,<sup>1</sup> who possessed a deeper insight into the bearings of evidence derived from fossil plants than was the case with the majority of geologists, expressing the opinion that "fossil plants have hitherto been regarded as of much less importance than fossil animals in determining the age of rocks, and in some portions of the geological series, where formations are strictly marine, their value is, no doubt, quite subordinate. But there are portions of the geological formations \* \* \* in which their value becomes much greater"; and in 1892 we find him giving a more pronounced expression of opinion when he says that "The history of geological discovery in the Canadian Northwest affords a convincing proof of the value of fossil plants when carefully collected, \* \* \* in determining the geological ages of the formations in which they occur, while there can be no question of their paramount value in indicating geographical and climatal conditions."

In 1882, Ward laid down in a definite and authoritative manner, the principles of geological correlation by means of fossil plants. He clearly showed that the old idea of contemporaneous deposits with identical fossils, as originally stated with so much prominence by Schimper and others, is entirely erroneous, and that it is relative contemporaneity or correspondence of succession which must be considered, an idea which the late Sir William Dawson often laid great stress upon in the course of his discussions with the writer. In order to give proper expression to the idea of correspondence of succession, Ward has proposed and for several years has employed the appropriate term 'homotaxis.' He lays down the general principles that

1. Great types of vegetation are characteristic of the great epochs in geology, and it is impossible for types of one epoch to occur in another.

2. Given a sufficient body of facts—*i. e.*, a suitable series of specimens—it is possible to determine as conclusively for nearly related deposits as for those more widely separated.

3. It is of the highest importance that plants should be correctly determined.

At the same time White, who deplors the 'surprising and painful inadequacy of materials relating to stratigraphic paleobotany,' shows that the present temporary obstacles to accuracy in correlation are to be found in

1. The wide vertical range of identical species.

2. The lack of standard paleobotanic sections, *i. e.*, a knowledge of plants strictly limited to various beds.

These principles form the basis of methods which have been used for the last eight years, and are employed with great success by members of the United States Geological Survey in determining the ages of deposits. This practise finds one of its latest and best expressions in a paper by Mr. David White on the 'Relative Ages of the Kanawha and Allegheny Series.' On account of similarity in the material composing it, the similar position of the series as a whole in the general lithological sequence, and the fact that the Allegheny series has been traced stratigraphically with great detail as far as central West Virginia, the Kanawha series has long been regarded as *in toto* the exact, though greatly expanded, equivalent of the Allegheny series. Following out the methods formulated by Ward, White has conclusively shown that this view is not a tenable one, but that as indicated by the testimony of the fossil plants, only the upper half of the Kanawha series can be correlated with the lower por-

tion of the Allegheny series, in each of which identical forms of plants occur; whence it appears that the two series overlap in such a manner that the Allegheny is in direct chronological succession in the lower Kanawha.

The occurrence of plant remains in the coal measures, which were in their general features comparable with existing types in the tropics, led Schlotheim to regard fossil plants as having a direct value in determining the nature of the climatic conditions under which they flourished. This idea was later taken up by Brongniart, who amplified it, and from the various types of vegetation known by their fossil remains, determined what he conceived to be the climatic conditions of the great geological periods, corresponding to the great changes in plant types. The views thus adopted have been accepted in principle by all succeeding authorities and constitute our guide post to day. Writing in 1879, the late Asa Gray felt no hesitation in laying down the general rule that "Plants are the thermometers of the ages, by which climatic extremes and climates in general through long periods are best measured," and in this connection he also pointed out that "Even very moderate changes either one way or the other, in temperature, would have excluded either the vine or the date palm which for at least five or six thousand years, have grown in proximity and furnished food to the inhabitants of the warmer shores of the Mediterranean." Three years later, in the course of extending his important studies relative to the Erian and Upper Silurian formations, Sir William Dawson laid down the general rule that "When we can obtain definite information as to the successive floras of an age, we thereby learn much as to climate and vicissitudes in regard to the extent of land and water," and that with reference to such points, "The evidence of fossil

plants, when properly studied, is, from the close relation of plants to their stations and climates, even more valuable than that of animals." But he very appropriately adds the caution that "In pursuing such inquiries, we should have some definite views as to the nature and permanence of specific forms, whether with reference to a single geological period or to successive periods."

Balfour had already pointed out the necessity for a wide acquaintance with plant distribution in order to apply fossil plants with any success as tests of climate, and Renault in 1881, expressed views similar to those held by Dawson, when he pointed out that plants were superior to animals as a test of climate because of their relative fixity, and therefore more permanent relations to their environing conditions—the ability to migrate rendering animals an uncertain guide.

While their relative fixity is an element which imparts a special value to plants in this respect, it must nevertheless be recognized that influences such as long rivers with a northerly and southerly course, are likely to introduce a disturbing element by reason of their causing a mingling of the floras of dissimilar climates, and for this and other reasons it is generally conceded that drift material must be carefully excluded from all considerations which involve questions of climate.

Variations in the soil, exposure to light, humidity of the atmosphere and many other conditions which tend to promote structural and functional modifications, and eventually also type alterations, must be carefully weighed and that these elements have been as important factors in the past, as they are at the present day, cannot be doubted when we recall the profound modifications exhibited by the various floras of Paleozoic time, and the fact, to which Lesquereux has directed attention, that "A single modification of the character of the vegetation gen-

erally follows great geological disturbances which produce permanent changes in the atmospheric condition of a country."

In 1872 Saporta pointed to the determining influence of atmospheric conditions, and showed that the relative preponderance of the monocotyledons and dicotyledons could be referred to conditions of humidity in such a way that the former increase while the latter decrease when the humidity becomes general, or with a diminution of temperature; and that, in consequence, a dry and warm climate favors a larger proportion of dicotyledons than a warm and moist, or a cold and moist climate. With these considerations in mind, we cannot avoid the conviction that the modern science of ecology as expounded by Warming and Schimper, and as exploited on this side of the Atlantic by Gannong and others, must throw much light upon questions of this kind by giving accurate data upon which to base comparative studies.

The peculiar conditions under which plants pass into the fossil state render it an altogether exceptional circumstance to find all parts present. This is more particularly true of those more delicate tissues and organs which constitute the structure of the gametophyte, but it also applies with considerable force to all the soft parts of the sporophyte. Important exceptions to this rule nevertheless appear. Renault has already shown that in *Cordaianthus*, the microspores are to be seen in position within the canal of the archegonium, as also in the pollen chamber, and they exhibit very clearly the development of the prothallus. He has also observed similar conditions of preservation in various *Calamariaeae*. More recent investigations have also given another important example of this kind in *Parka decipiens*, the remains of which show prothalli and both kinds of spores, and, coming as it does from the Devonian, it

probably stands as the most ancient representative of the heterosporous filicineæ we know. Other less conspicuous cases might also be cited, but the general fact that it is only the more resisting structures, such as those of the stem and leaves, which are recognizable, has led to attaching great importance to the anatomy of the wood. This was first pointed out by Witham, who has since been followed by many of the leading paleobotanists of Europe, and to some extent by those of America. On this side of the Atlantic, the idea was first taken up by the late Sir William Dawson in 1845, and since that time its application has been made more prominent through the work of Knowlton and others.

As a special indication of climate, the presence of growth rings—from the time of Witham who considered the absence of such structural features to be evidence of a tropical climate—has been regarded as one of the important factors in this respect. The history of the subject shows a great divergence of opinion as to the origin of these structures, but the general position may no doubt be correctly taken, that growth rings are largely dependent upon, and are therefore expressive of alternating periods of growth and rest. Such periodicity in functional activity bears a more or less close relation, among other things, to seasonal change in such a way that, other things being equal, the more definite the changes from summer to winter, the more pronounced will the growth rings become, and the more definite will be their correspondence with age. That this holds true only within certain limits is well known. Thus many Chenopodiaceous plants make several growth rings within one season independently of latitude, and the red maple, within the latitude of New York State, has been known to make twelve growth rings within a period of eight years. Fernow has recently drawn attention to

the fallacy of many of the opinions respecting the value of growth rings as an index of age, and the correctness of the views which hold them to be of importance in this respect, and he points out that under ordinary circumstances in temperate latitudes the ages of trees may be correctly ascertained within a limit of one-half to one year of error. Tropical trees generally exhibit an absence of growth rings, but exceptions to this rule are not unknown. It would therefore appear that while much caution must be exercised in applying such a test to the case of fossil plants, when used with a due recognition of its limitations, the test of growth rings as evidence of climate becomes a valuable aid.

One of the most common methods of identifying fossil plants has been through their leaves. This has of necessity resulted from the fact that these organs are much better adapted to preservation than most other parts of the plant, and that they therefore constitute the most accessible of all plant remains. The work of Lesquereux and Newberry rests very largely, indeed almost exclusively, upon evidence of this sort, and the venation has been made the basis of both generic and specific distinctions. Leaves, however, offer an unreliable basis when taken alone, and this results from the fact that the venation is not of specific rank, and often fails also in generic significance, while the form of the leaf may present so many changes within the limits of the species that no great dependence can be placed upon it. This is notably the case in such genera as *Liriodendron*, *Sassafras* and *Platanus*, and it is only necessary to refer to the comparative studies by Ward, on the 'Paleontologic History of the Genus *Platanus*,' and to the observations of Holm on *Liriodendron*, to give emphasis to facts long known to botanists, and show what erroneous and extremely misleading results may readily follow from the study of fossil



leaves, even when they are presented in a complete condition—a difficulty which is enormously increased when the fossil happens to be fragmentary, as is generally the case. The errors arising from a disregard of such facts, have led to no end of confusion, and have been among the most prolific causes of extensive revisions. It is therefore clear that for botanical purposes such fragments have a very limited value, but as Ward very correctly observes, for geological purposes it is not so much a question of correct botanical determination as the correct recognition of a plant once named and associated with a given deposit. With these limitations before us, we can form a more correct estimate of some of the recent conclusions bearing upon the climatology of former geological times.

The great analogy of climatic conditions recognized as existing between those which influenced the flora of the Dakota Group and those which now govern the vegetation of the North American continent, led Lesquereux to the conclusion that the flora of North America is not at the present epoch, and has not been in past geological times, composed of foreign elements brought to this continent by migration, but that it is indigenous. Its types are native, and the diversity of their representatives has been produced by physical influences. All the plants of the American Cenomanian, except those of *Ficus* and the *Cycads*, might find a congenial climate in the United States between latitudes 30° and 40°.

An examination of the Tertiary flora of the Yellowstone has shown that the present flora of the Park has comparatively little relation to it and cannot be regarded as a descendant of it. Knowlton concludes that the former had its origin to the south, while the latter had its origin to the north, and that the climate prevailing in Tertiary times was, therefore, quite different from that now known, and in all

probability not unlike that of Virginia of to-day.

A study of the Lower Carboniferous Measures of Missouri has led Mr. David White to draw attention to the uniformity of climate which prevailed over Europe, within the Arctic Circle, in North America, Asia and, to some extent at least, in the southern hemisphere during Carboniferous times, and the probability that the extremely close relationship between the floras of the Culm, Millstone Grit and basal portions of the Lower Coal Measures in Europe and America point to wonderful facilities for plant distribution during Culm and early Mesocarboniferous time, facilities which, with the aid of an even climate, made possible the comparatively regular distribution and sequential order of probably nineteen-twentieths of the genera, and an unknown proportion of the identical species; and he is disposed to consider that the conditions favorable to plant distribution, and consequent comparatively homogeneous dispersion of the successive floras of the Northern Hemisphere during the period extending from the later Culm to near the middle of the Mesocarboniferous, have never been equalled since. That there was plant migration cannot for a moment be doubted. Yet the evidence of distribution, of vertical range, of characteristic associations, and of the succession of the floras, indicate such geographical uniformity of climate and such facility of intermigration over a minimum distance, as to justify us in regarding the astonishingly similar associations of identical or closely related genera and species which characterize each stage, zone or group of the Culm and Mesocarboniferous, as essentially contemporaneous in all the basins of the Northern Hemisphere. From this evidence he draws the final inference that many of the species or genera of the Mesocarboniferous were, under local conditions, evolved

in different portions of the land surface, whence they spread with a rapidity difficult to conceive at the present day, over the greater portion of the northern continents.

An extended study of the Pottsville series of West Virginia offers an important illustration of the rapid differentiation of, and change in, floras during this period. White shows that "The period of change in conditions of environment attending transition from Lower Carboniferous marine to true Coal Measures formation, was marked by an extraordinarily rapid development and modification of plant species. Within a relatively short period the meager flora of the Devonian and Pocono is multiplied to the inexhaustively fecund and highly diversified flora of the Carboniferous, a development scarcely possible except in this division of organic life (plants), which is the most sensitive to climatic change or environment, excepting, perhaps, the higher vertebrates. In the lower part of the Pottsville series many species show a relation to the floras of the Vespertine or Calcareous Sandstone series; in the middle portion many of the forms are unique, while in thickly developed sections it is only near the top of the series that we see occasional Coal Measures forms creeping in."

Recent investigations, by the Committee of the British Association charged with an investigation of the Pleistocene deposits in the vicinity of Toronto, have brought out in a very convincing manner the fact that three distinct climatic periods may be recognized. During the first the vegetation and the climate were comparable with those now found in Labrador and the more northern portions of the Province of Quebec. This was followed by a period during which more southern types of vegetation were introduced, and the climate was probably comparable with that now common to the Middle United States. A third wave drove

these plants southward again, and once more northern types of vegetation were introduced, but not quite so boreal in their character as the first, and these conditions have remained unchanged in the present day.

From the considerations which have thus been passed rapidly in review, it would appear that the advantage which such studies offer to the botanist is not very large, and that while the value of paleobotany to the geologist may, upon these grounds, be conceded to be great, the solution of questions bearing upon climate and geological succession can only be regarded as of a secondary importance from a botanist's point of view. The great problems which confront the botanist of to-day relate to the filling in of those gaps in plant descent which become apparent from a study of existing species. He is, therefore, called upon to complete, as fully as possible, our knowledge of that sequence in development which is at present justified, not only on theoretical grounds, but also on the basis of observed facts. To this end all other branches of the subject are subordinate, and since paleobotany has already contributed in so many important ways to enlarge our knowledge in this direction, it is my purpose to ascertain how far the progress of the subject in America, during the last decade, has proved of real assistance, the directions in which aid may be looked for, and the limitations within which useful results may be expected.

Our conception of the four great primary divisions of the plant world and of their subordinate branches is based upon the theory of succession in development, but our knowledge in this respect is far from complete, and here and there gaps occur in places where, on theoretical grounds, there should be perfect continuity in development. This defect arises from several causes.

The recognized law that the history of the individual more or less fully repeats the

history of the species, at once points to the superior importance of embryological data as the real link through which primitive forms may be united; but as we approach these primitive forms it is to be observed that the differentiation of types becomes less and less clearly defined until they merge in the ancestral form, and this must hold true of extinct types as well as of those now existing. While on the one hand such approximations may greatly aid in the solution of given problems, on the other they serve to defeat this end by reason of the difficulty experienced in their recognition and in a demarcation of their precise limitations.

In the progress of development many of the more primitive types of life have disappeared, while those of advanced organization have survived, and thus many of the gaps revealed by the study of existing species are of a more or less permanent character, and can only be bridged hypothetically. It is in emergencies of this kind that we instinctively turn to geological records, and in paleobotany seek the only available means of solving the difficulty. But here again, the complete obliteration of perishable material in the process of petrification, the breaking-up of the original body into widely separated fragments which can be correlated, if at all, only after the most prolonged and arduous labor, and the difficulty of recovering plant remains, even though they may be present in the rocks, constitute obstacles to the progress of knowledge in this direction, of the most formidable character. Hence from a botanical point of view, our knowledge is extremely imperfect; but when we take into consideration the serious nature of the difficulties involved, the substantial progress which has been made during the last seventy years, and more particularly during the last two decades, affords ground for much satisfaction.

In this connection we may note the somewhat suggestive observations of White to the effect that "The rapid development and series of changes or modifications, presented by the plants of the Pottsville Series of both Pennsylvania and West Virginia, point to the possibility that in this series we may eventually discover facts of the deepest significance relative to descent, but the present fragmentary nature of the material recovered, which consists altogether of portions of foliage, will not warrant final conclusions in this direction."

The relative sequence of the Pteridophytes and Spermatophytes, as also of the Gymnosperms and Angiosperms, the Monocotyledons and Dicotyledons as exhibited in geological succession, is substantially the same as that derived from the study of living forms. But with reference to their points of contact and the relations of the more subordinate divisions of these groups, especially with reference to the Thallophytes and Bryophytes, the evidence of geological records often proves altogether inadequate and conveys no very exact idea of the real phylogeny. As living plants constantly approximate to the ancestral type as we descend in the scale, so likewise a similar approximation must be exhibited in earlier geological time, and this slight differentiation of primitive forms, which are very imperfectly known to us through mere fragments of the original plants, is one of the most prolific sources of error in paleobotany, and has resulted in the constant shifting of plants from one position to another.

On theoretical grounds the Thallophytes must have flourished in the very earliest periods of the earth's history, and their remains should occur in rocks of the Laurentian age, but if we leave out of consideration those very problematical forms which have sometimes been held to represent plants from the early paleozoic, nothing recognizable appears until the Silurian, in

the later portions of which we are abruptly confronted with algæ of gigantic dimensions and a high degree of organization, thereby implying the existence of a long line of ancestors in the earlier geological periods, of which all traces seem to have disappeared. Passing into the Devonian, such types gain greater prominence in point of numbers, and thence on to the present the successive formations give evidence of the continuous development of this type of plant life; and while in *Nematophycus*, *Chondrites*, *Lagynophora* and *Bacillus* we find well-developed representatives of types known at the present time, their ancestral forms are to be sought in the Laurentian and portions of the early Paleozoic, where the only evidence of their former existence is to be found in the abundance of graphite and other forms of carbon. The most perishable of all plants, the Thallophytes, readily yield to that decay which is the invariable antecedent of petrification, and the slight residue of structure which might remain is commonly obliterated in the farther metamorphosis of the rocks in which they are held. It is therefore altogether exceptional that such plants should be preserved in recognizable form, and their value for phylogenetic purposes, although very limited, acquires an unusual interest and importance. This is eminently true of the very plants through which the line of direct descent passes, since the green algæ are, of all the group, among the most perishable. For these reasons it is in no way surprising that additional representatives of the Thallophytes among fossil plants are rare, that such plants as are found add but little to our knowledge of descent, and that they fail completely to illumine the line directly ancestral to the Bryophytes—the evidence so far accumulated bearing altogether upon side lines represented by relatively durable remains.

Among the higher Thallophytes, a few

additions have been made to the Charophyceae by the recognition of the characteristic fruits in the Lower Tertiary of Wales, Ohio, where two species—*C. Stantonii* and *C. compressa* of Knowlton are found. Fruit-like bodies having the external characteristics of *Chara* have also been observed in the Devonian at the falls of the Ohio, thus giving to this group of plants the possibility of a very ancient lineage which is justified on theoretical grounds. The very fragmentary remains so far known, the preservation of which depends upon their calcareous investment, nevertheless serve to throw no additional light upon previous knowledge. Migula has suggested that these plants occupy a position superior to the Thallophytes as a whole and coordinate with the other great divisions of the plant world. This view has been adopted by Seward in his most recent contribution to paleobotany, and Campbell also regards it as deserving recognition. To the solution of this question, however, the fossil representatives contribute no information not derivable from existing species.

Among the Phaeophyceae considerable interest has attached for a number of years, to a remarkable fossil originally described by Dawson as *Prototaxites* under the impression that it represented a primitive Gymnosperm allied to the Taxaceae. This view was disputed by Carruthers, who was the first to determine the algal nature of the organism, and he assigned to it the name *Nematophycus*. Subsequent investigations of North American material amply justified this view, and Dawson was led to so far modify his original opinion as to employ the name *Nematophyton*. Several provisional species from the Silurian and Devonian of America have been recorded, and to these there have been added three species from the same formations in Europe. Carruthers has been led to suggest a possible

relationship to the modern Siphoneae, but an extended study of American forms leads to hesitation in giving this opinion unqualified acceptance. Several years since, the belief was expressed that there were grounds for supposing a relationship with Laminarieae, and the genus *Lessonia* was cited as likely to afford the best means of comparison, but the impossibility of securing suitable material caused such studies to be deferred. Recent studies by MacMillan have given us a detailed account of the morphology of this extremely interesting but not readily accessible plant, and from material which he has kindly supplied the writer, it is to be noted that very striking points of resemblance to *Nematophycus* appear. Without entering into details on the present occasion, it may suffice to indicate that similar growth layers, the presence of a distinct cortical structure, the general disposition of the elements as seen in transverse section, and the presence of radial spaces, occupied by elements of the medulla which there assume a horizontal position and develop special relations to one another, are all features which point with considerable force to possible relationship. Beyond these facts, however, our present knowledge respecting the phylogeny of this group of plants will not permit us to go.

The Bryophytes constitute another group which, from their delicate organization, are not likely to be found either in very considerable numbers or in a very perfect state of preservation as fossils. They nevertheless occupy a most important position in plant evolution, since they are considered to constitute the connecting link between the green algæ and the higher vascular plants, their derivation from the former being through the thalloid liverworts, while their algaoid ancestry also appears in the filamentous protonema of the true mosses and in the motile spermatozoids of the entire group. From the phylogenetic position

of these plants as determined by a study of existing forms, we are led to infer that they must have had their origin in very early geological times—antedating the more fully organized terrestrial forms of which they are to be considered the ancestors. There is thus good reason for supposing them to have flourished as early as Devonian or even Silurian time, but the evidence derivable from the rocks shows no recognizable remains of these plants until we reach the later Mesozoic, while it is not until Tertiary time that they become clearly defined. It is, therefore, reasonably certain that the solution of questions relating to the origin of this group must rest altogether upon evidence derived from a study of existing species—to such, fossil botany has as yet contributed nothing.

From their more durable structure, which offers a higher degree of resistance to the operation of decay, the vascular plants have always been found in the best state (sometimes remarkably perfect) of preservation, and they have therefore always presented the best of opportunities for phylogenetic studies, more especially in consequence of the great abundance of their remains and the increased probability of deriving data of permanent value from them. In considering the distribution of these plants in geological time, one is impressed not so much with their often extensive vertical range, as with the abruptness with which special types appear through representatives of a high degree of organization. This has already been noted in the case of the Thallophytes, and among the vascular plants it is no less remarkable. The ferns which first appear in the Devonian are represented not only by foliage and fruit, but also by stems of large dimensions; the *Cycads* abruptly appear in the Jurassic and Cretaceous while the Angiosperms as suddenly appear in the Mesozoic, where they gain great prominence in the Cretaceous formation.

From these and other similar examples we are justified in the inference that such highly organized types represent the culmination of lines of ancestors which must have extended far back into the earlier geological periods, a view which gains weight from recent researches.

Among the ferns the Eusporangiatae are recognized as representing the primitive forms, and they constitute the starting point for two parallel lines of descent, one of which leads to the Leptosporangiatae and finally culminates in the Heterosporaeae. Recent studies of *Parke decipiens* have shown that this hitherto problematical organism from the Devonian is unquestionably to be regarded as one of the heterosporous felicinæ, possibly allied to Marsilia. The occurrence of this plant in the same horizon as that in which the Eusporangiatae first appear, somewhat abundantly and in a high state of development, is of great significance, since it points without question to the origin of the ferns at a very much earlier date, probably not later than Silurian time.

In studying a new Taeniopterid fern from the Lower Coal Measures of the Carboniferous of Henry county, Missouri, Mr. D. White notes certain resemblances on the one hand to *Alethopteris*, and on the other to *Taeniopteris*, to which he assigns his plant under the name of *T. missouriensis*. Discussing this plant in relation to other known forms of the Marattiaceae, he endeavors to construct a hypothetical relationship which shows a *Megalopteris* stock of the Lower Devonian, to give rise in the Middle Devonian to *Neuropteris*, *Alethopteris* and *Megalopteris* proper. Thence through successive formations these three lines of descent lead to *Dictyopteris* and *Odontopteris*, which culminate in the Permo-Carboniferous, and to *Danaeopteris*, *Lomatopteris*, *Oleandridium*, *Taeniopteris*, etc., which either culminate or have their origin in the

Trias, while *Angiopteris* originates at this latter horizon and *Danaea* makes its first appearance in the Jurassic. The hypothesis is a suggestive one, but as the fructification of these plants is wholly unknown, and as we have no data derived from the internal structure, while the relations exhibited are based entirely upon leaf characters, it is impossible to attach very great weight to it except as a possible starting point for further observations.

Recent studies of modern Equisetaceae and the various species of Calamites by Jeffrey, offer some very suggestive conclusions respecting the phylogeny of this most interesting group of plants now in the later stages of decline. Embryological studies show that similar structures in the prothalli, the absence of a basal cell from the archegonia and the epibasal origin of both root and shoot, serve to establish a definite connection between the Equisetaceae and the Homosporous Lycopods, a relation which is further justified by a comparison of the stem structure. He also shows that the close agreement between the Equisetaceae and the Sphenophyllaceae makes the latter the protostelic ancestors of the former. An acceptance of these conclusions would carry our knowledge of the phylum back to Lower Devonian time, and show that while the direct line of descent passes through the Sphenophyllaceae and Equisetaceae, the Calamites arose as a side line.

The phylogeny of the Gymnosperms has for many years constituted a subject of the foremost importance and interest, and it has received the most careful consideration at the hands of both paleontologists and botanists. The deep interest which centered so largely in the Cycadaceae, has within the last few years received additional strength not only through the discovery of those remarkable collections of *Cycads* from the Mesozoic, which Ward

has already described on the basis of their external characters, and which Wieland is now engaged in studying from the standpoint of their internal structure; but also from the very noteworthy observations of Weber and Hirase respecting the occurrence of motile spermatozoids in *Zamia* and *Ginkgo*. Our knowledge of the North American *Cycads* adds nothing as yet to the phylogeny of these plants as determined by European investigators, but the progress of the studies of the Yale material will be watched with the greatest interest, in the hope that they may yield facts of importance in this connection. In the meantime, however, the deep significance of conclusions derived from the study of European material justifies a brief reference to the position of our present knowledge of this group of plants, which may be said to have commenced with a recognition of the similar characteristics possessed by a small group represented by *Noeggerathia*, *Medullosa*, etc., characters which pointed both to a filicinean and cycadean connection, but which were too poorly defined to permit the assignment of the representatives to any specific position. A recognition of the identity of *Medullosa* and *Myeloxylon* as suggested by Solms-Laubach and later confirmed by Schenck and Weber, served to prepare the way for a clearer conception of the relations existing between the individual members as also with other groups, and this gained final expression in Potonié's determination that *Noeggerathia*, *Medullosa*, *Lyginodendron*, *Heterangium*, *Cladoxylon* and *Protopitys* represent a distinct group of plants having an affinity with the ferns on the one hand, and with the cycads on the other, thereby becoming of ordinal value. He therefore established the name *Cycadofilices* as a proper recognition of the important position occupied by them. An additional contribution to our knowledge of this exceptionally interesting group of

plants has been given by D. H. Scott in a study of *Medullosa anglica*, which he shows to have a probable filicinean connection through the *Heterangium* type. He further concludes that while the *Medulloseae* are to be considered as having affinities with the *Cycadaceae* in a broad sense, they really constitute a short, divergent branch of the phylogenetic tree.

The ancestry of the *Coniferæ* has excited an interest almost as profound as that centering in the *Cycads*, and although we are enabled to trace these plants more or less fully back to Silurian time, we are as yet unable to establish their relation to an inferior group, as in the case of the *Cycads*. Our present knowledge of the descent of the *Coniferæ* rests chiefly upon a recognition of that line of ancestry which passes through *Cordaites* and culminates in the *Araucarian* type. This has been gained by a careful study of the structure of the wood, as also of the foliage, inflorescence and fruit, as obtained from numerous European localities, notably those in France. Extensive collections of North American *Cordaitæ* are represented by the wood and foliage only, and though their value for phylogenetic purposes is thereby relatively limited, they have nevertheless contributed important data derived from a study of the stem structure, and afford a striking illustration of the superior importance of those histological methods first employed in such connection by Witham, the value of which was so strongly insisted upon by Brongniart. Apart from the general evidence derived from this material, which points with great force to the development of the *Araucarian* type, the structure of the stem is frequently preserved with such perfection as to permit recognition of important phases in the evolution of structural features. As long ago as 1840, Don pointed out that in the tracheids of *Cycas revoluta*, scalariform structure may occur at one end and bordered pits at

the other. In 1869 Williamson was able to point to similar structural modifications in *Dadoxylon*, and to show that regularly transitional forms gave proof of the derivation of the bordered pits from scalariform structure. Recent studies of North American *Cordaitæ* have given conspicuous examples of the same kind, and show that a continuous series of radial sections will display regularly transitional forms—often combined in the same tracheid—passing from the spiral vessels of the protoxylem through scalariform vessels, thence into tracheids with transversely elongated bordered pits, which successively become shortened up until there is developed the typical, multiseriate, hexagonal and compactly crowded bordered pit so well defined not only in the *Cordaitæ*, but also in the modern *Araucariæ*. These facts possess the deepest significance from a phylogenetic point of view, since they afford an additional and reliable indication of derivation, and in the present connection, they serve to point with considerable force to the idea that among modern *Conifera*, the widely-separated bordered pit which in many instances wholly disappears is for that line of descent the culminating form of this type of structure; while in the *Angiosperms* the modification has been carried to a greater extreme and involves the reduction of the pit to the form of a simple slit or pore, and ultimately to its complete obliteration as a final expression of the secondary growth of the cell wall. Structural alterations of this nature involve also a more or less profound influence upon functional activity as expressed in the distribution of nutrient material.

I have thus endeavored, within the limits of the time at my disposal, to briefly indicate some of the more prominent directions in which paleobotanical activities have developed in North America within the last decade. While this review shows that some

substantial progress has been made, that much has been accomplished in the direction of laying the foundation for future studies, and that the study of fossil plants is gaining greater prominence as a necessary aid to our knowledge of plant descent, it also brings into relief the fact that progress in this latter direction must of necessity be slow, and the result of laborious methods of investigation extending over such long periods of time as will permit the accumulation of great stores of material, and the careful piecing together of fragments which separately have little or no significance. Nevertheless the rapid progress which has marked our knowledge of fossil plants during the last twenty years, and the acceleration of this progress within the last two decades, together with a greater appreciation of the fundamental importance of such studies in questions of relationship, afford much ground for regarding the future of paleobotany on this side of the Atlantic as one of promise.

D. P. PENHALLOW.

McGILL UNIVERSITY.

*DETERMINATION OF THE SUN'S DISTANCE  
FROM OBSERVATIONS OF EROS.*

THE tendency of the time toward thorough organization and cooperation in large enterprises is well illustrated in modern astronomy. Twenty-five years ago, a dozen leading observatories, by mutual agreement, divided the northern sky into zones in such a way that their meridian circle observations would combine to form the excellent *Astronomische Gesellschaft* star catalogues; and this great work is now nearing completion. The work of charting the sky by means of photography was similarly organized by the *Astrographic Conference* in Paris some ten years ago.

About fifty of the principal observatories of the world are now cooperating in a great program of observation for improving our



knowledge of the distance between the earth and sun. Fully half the resources of the Lick Observatory, the Lick Astronomical Department of the University of California, have been devoted to this work for three months past, and the observations will continue another month.

The determination of the value of this astronomical unit of distance is one of the most famous problems in the science, and a great variety of methods has been used. Perhaps the best determination is that made by Sir David Gill, of the Cape of Good Hope, from heliometer observations of the nearer asteroids. The four hundred small planets—asteroids—discovered up to 1898 all move in orbits situated entirely outside the orbit of Mars. The observations of Victoria, Iris and Sappho, which approach nearer to the earth than any of the other members of the asteroid group, led to the conclusion that the average distance from the earth to the sun is about 92,900,000 miles. The unavoidable errors to which all such observations are subject leave an uncertainty of some 150,000 miles in this value: it may be too large or too small by this amount.

The accuracy of results obtained in this manner depends upon the distance of the observed body from the earth and upon its definiteness as a point of observation. Mars possesses the advantage of being nearer the earth than the asteroids, but this advantage is greatly outweighed by the fact that an asteroid-point can be observed much more accurately than a large planet-disk. Gill's splendid work left much to be desired, but there was no prospect that his value of the unit could be improved with instruments now available.

An asteroid discovered by Dr. Witt in Berlin in 1898, to which he gave the name Eros, is very remarkable in that its orbit lies partly within and partly without the orbit of Mars. It approaches the earth more closely than any other member of

our system, except the moon. The forms and relative positions of the orbits of the earth, Eros and Mars are shown approximately by the accompanying diagram, Fig. 1. The

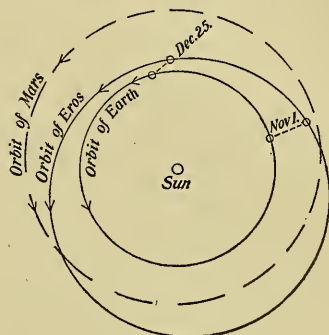

FIG. 1.

orbits of Mars and Eros appear to intersect, but this is merely apparent, from the projections of the two on the plane of the paper. The plane of the orbit of Eros makes an angle of about eleven degrees with the plane of the orbit of Mars (and the earth), and the two orbits are situated like two adjacent links of a chain, without approaching each other very closely.

As soon as the orbit of this wonderfully located asteroid was computed and published, astronomers realized its possibilities for improving our knowledge of the sun's distance. As stated above, an asteroid's value for this purpose depends upon its closeness to the earth. The distance of Eros at this opposition will have a minimum value of twenty-seven million miles. Unfortunately, the more favorable opposition of 1896, when the distance diminished to fifteen million miles, was not available, as the planet remained undiscovered; and an equally good opposition will not occur again for a quarter of a century.

In outline, this method of measuring the

sun's distance is exceedingly simple; but in detail, it is exceedingly complex and technical. The nature of the problem may be explained from Fig. 2.

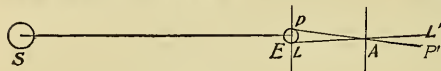

FIG. 2.

If the earth is at  $E$  and the asteroid at  $A$ , an observer on the earth's surface at  $P$  will see the asteroid projected on the sky at  $P'$ , whereas an observer at  $L$  will see it at  $L'$ . If the distance  $PL$  is known, as it is, and the angle  $PAL$  is obtained from the observations, the data for solving the triangle  $PLA$  are at hand, and the distance  $EA$  may be obtained by simple computation. As a second step in the solution, the orbit of Eros will be determined very accurately, basing the determination upon Newton's law of gravitation. It will then be a simple matter to compute the ratio of the earth's distances from the sun ( $ES$ ) and the asteroid ( $EA$ ). The distance  $EA$  having already been determined in miles, the desired distance  $ES$  will follow.

If two observatories on opposite sides of the earth secure observations simultaneously, say at  $P$  (Pukowa in Russia) and at  $L$  (Mt. Hamilton), the desired data are theoretically complete; but practically they are insufficient. There are unavoidable errors in the measurement of the very small angle  $PAL$ , and in the assumed positions of the two observatories, which will be materially reduced by having observations made at a large number of stations. The direct distance between the Pukowa and Lick Observatories is about 5,000 miles. This is a base line from which to measure a distance of 27,000,000 miles, and thence the three-and-one-half-fold greater distance to the sun. The form and the dimensions of the earth thus enter directly into the problem. An error of a quarter of a mile

in the assumed length of the base line leads to a large error in the final result.

Instead of simultaneous observations made in the morning in Russia and in the evening in America, the angle  $PAL$  can be determined by evening and morning measures secured at one station.

The July conference of astronomers at the Paris Exposition afforded an opportunity for a hurried formation of cooperative plans to secure the observations needed. It may be said that every one of the contributing observatories is devoting to this problem all its resources which in any way promise to improve the results. The measures are most advantageously made in November and December; and perhaps a hundred observers are giving their time to this work. The reductions will require one or two years' labor, and the value of the sun's distance, resulting from a combination of all the work of all the observatories, will probably not be available for two or three years.

The Lick Observatory is contributing as follows:

Astronomer R. H. Tucker, assisted by Mr. Crawford, is securing two meridian-circle observations of each of 700 stars, to determine their positions with the utmost accuracy. These positions, furnished by perhaps a dozen or more observers, will form the triangulation system, or groundwork, upon which the whole structure of the determination will be based.

Astronomer W. J. Hussey and assistant-astronomer R. G. Aitken, with the assistance of Mr. Wright and Dr. Reese, are using the great 36-inch telescope five or six nights per week, weather permitting, to measure the evening and morning positions of Eros with reference to the fixed stars in the asteroid's vicinity. The positions of these reference stars will be secured by means of photographs of the regions

taken with eight or ten telescopes, mostly in Europe.

Assistant-astronomer C. D. Perrine, assisted by Mr. Palmer, is employing the Crossley Reflector every clear night to obtain photographs of Eros and its surrounding stars, to furnish the planet's accurate position in the evening, in the morning, and on the meridian. The measurement of these plates will be a heavy task. Fortunately, Professor Rees, Director of the Columbia University Observatory, has volunteered to measure them. Columbia University is the only institution in this country which has had experience in measuring such plates, though many foreign observatories have long been doing similar work.

The planet Eros is now of about the 9.3 magnitude. It is easily visible in a three-inch telescope.

W. W. CAMPBELL,  
*Director of the Lick Observatory.*

ON THE NATURE OF THE SOLAR CORONA,  
WITH SOME SUGGESTIONS FOR WORK  
AT THE NEXT TOTAL ECLIPSE.

IN an article on the corona, published in the November number of the *Astrophysical Journal*, I suggested a method by which the existence of the Fraunhofer lines in the spectrum of the corona might be detected. The method was based on the supposition that the light emitted by the particles in virtue of their incandescence, so overpowers the reflected sunlight that the lines are invisible. That the coronal light is strongly polarized is well known, and there is scarcely any doubt but that the polarized light is reflected sunlight. If now a Nicol prism be placed before the slit of the spectroscope in such a position as to transmit the polarized radiations, these will be allowed to pass with almost undiminished intensity, while the emitted or unpolarized light will be reduced in intensity by one-half. The great change in the ratio result-

ing might easily be sufficient to bring out the dark lines distinctly. I feel firmly convinced that this experiment should be tried at the Sumatra eclipse of next May, for I have successfully accomplished it in the laboratory with an artificial corona. It was found that a gas flame in a strong beam of sunlight shone with a pure bluish-white light, due to the reflection or rather scattering of the sunlight by the minute carbon particles.\* The flame thus illuminated showed the Fraunhofer lines distinctly, but by reducing the intensity of the sunlight a point was reached at which they disappeared, and the spectrum appeared continuous. The light scattered by the flame was found to be *completely* plane-polarized in certain directions, giving us just the required conditions, namely particles emitting a continuous spectrum, and scattering a polarized solar spectrum. In front of the slit of the spectroscope a Nicol was arranged in such a manner that it could be drawn into and out of position by a cord. The Fraunhofer lines could be made to appear by sliding the Nicol in front of the slit, and disappear by drawing it away. While it does not by any means follow that the use of a Nicol on the actual corona will bring out the lines, the experiment seems to be well worth trying, as it would furnish further information regarding the relative intensity of the emitted and reflected light. Another interesting point is that the minute particles in the flame do not scatter the longer waves, the flame reflecting practically no red or orange light. Thus the Fraunhofer lines can only be traced up to about the D lines. By gradually reducing the intensity of the sunlight they disappear first in the yellow, then in the green, blue, and violet in succession.

\*A photograph of the flame with a spot illuminated by powerful convergent beams of sunlight furnishes a beautiful proof of the existence of solid particles in the flame.

This indicates that our chances of detecting the lines in the spectrum of the corona will be greatest in the photographic part of the spectrum. Moreover, it appears to explain the absence of radiant heat in the light emitted from the corona, the particles being too small to scatter these longer waves to any appreciable extent. Abbott, of the Smithsonian party at Wadesboro, found the corona cold in comparison with his bolometer, and infers from this that the corona neither reflects sunlight nor emits light in virtue of incandescence, expressing the opinion that the luminosity is analogous to that of vacuum tubes transmitting electric discharges. It seems to me that the polarization of the coronal light makes this theory untenable, and that the absence of heat rays can be explained fully by the small size of the particles. I am aware that the absence of radiant heat in the emitted light has yet to be accounted for. My own notion, based on experiments which are now in progress, is that the reflected or scattered light is vastly in excess of the emitted, and that the absence of the Fraunhofer lines is more probably due to line-of-sight motion of the particles, than to simple drowning out by emitted light.

My experiments on the ratio of emitted to reflected light of a body brought to incandescence by powerful solar radiation are not yet completed, consequently I do not yet feel prepared to make any very positive statement in regard to this matter. A full account of this work will appear shortly in the *Astrophysical Journal*.

Any observers planning to use a Nicol prism in connection with a spectroscope in the manner described will find a gas or candle flame illuminated with a beam of sunlight concentrated by means of a large mirror or lens, extremely useful in making preliminary experiments.

For work on the polarization of the corona I believe that the artificial corona

described elsewhere will be found most useful for preparatory work. Not only is it polarized, and polarized in the same way as the real corona, but it resembles it in a most striking manner, and can be easily made of the same brilliancy. It would be well to work with particles of different size, giving different percentages of polarization, and the picturesque refinements for producing the polar streamers could of course be omitted. For work of this sort it would be well to use a lamp with a ground glass bulb, as the conditions of illumination would then more nearly approach those in the real corona.

Data regarding the plane of polarization in the streamers would be useful in formulating a theory of the streamers. These, it seems to me, can be conceived as formed in two ways: they may be streams of coronal particles moving in curved paths, in which case the plane of polarization should be everywhere strictly radial, or what is extremely improbable, they may be caused by divergent beams of light coming from the polar regions of the sun and moving in curved paths, owing to the rapid decrease in the refractive index of the sun's atmosphere in an outward direction. If this were the case, the plane of polarization would turn with the streamer.

This latter hypothesis is extremely visionary, and I do not present it seriously, for it is almost impossible to conceive of any way in which the isolated beams of light could be formed, unless perhaps by vortex funnels more highly luminous than the surrounding surface of the sun. Such fanciful speculations are hardly worth indulging in, though they have interested me for the moment in connection with the matter of the possible curvature of light rays in the sun's atmosphere alluded to in a recent paper by Julius in the *Astrophysical Journal*.

R. W. WOOD.

UNIVERSITY OF WISCONSIN.

CHICAGO SECTION OF THE AMERICAN  
MATHEMATICAL SOCIETY.

THE eighth regular meeting of this Section was held at the University of Chicago on Thursday and Friday, December 27 and 28, 1900. The Section was organized in April, 1897, under a by-law of the Society which provides for conducting in any locality periodic meetings for the reading and discussion of mathematical papers, and since then has met twice a year, in April and December. During this period a total of 128 papers, by fifty-two different persons, have been read before the Section.

The election of officers, which occurs regularly at the Christmas meeting, resulted in the re-appointment of the Secretary, Professor Thomas F. Holgate, and the choice of Professor E. J. Townsend and Professor James B. Shaw for members of the Program Committee.

The following papers were read :

1. PROFESSOR E. H. MOORE : 'On the uniformity of continuity.'
2. PROFESSOR ARTHUR S. HATHAWAY : 'Quaternions and four-fold space.'
3. PROFESSOR IRVING STRINGHAM : 'On the geometry of planes in a parabolic space of four dimensions.'
4. DR. F. H. SAFFORD : 'Flow of heat in two dimensions.'
5. MR. A. C. LUNN : 'Certain mathematical aspects of experimental science.'
6. MR. E. A. HOOK : 'Some properties of circulating decimals.'
7. PROFESSOR ARNOLD EMCH : 'Note on the congruences of twisted curves.'
8. PROFESSOR H. B. NEWSON : 'A generalization of the Wessel-Gauss-Argand diagram.'
9. DR. F. R. MOULTON : 'On straight line solutions of the problem of  $n$  bodies.'
10. DR. GILBERT A. BLISS : 'Geodesic lines on an anchor ring.'
11. MR. FRANZ A. LA MOTTE : 'On the determination of the algebraic equations invariant under Tschirnhausen transformations, with the parameter representation of all such irreducible equations, with rational coefficients, of the third and fourth degrees.'
12. PROFESSOR E. J. TOWNSEND : 'Functions of two real variables which are continuous with respect to each variable.'

13. PROFESSOR L. E. DICKSON : 'The group of the equation for the twenty-seven lines on a general cubic surface.'

14. PROFESSOR OSKAR BOLZA : 'Concerning the expression of Abelian integrals in terms of a fundamental set of integral functions.'

15. DR. J. C. FIELDS : 'Proof of the Riemann-Roch theorem and of the independence of the conditions for adjointness.'

16. PROFESSOR OSCAR SCHMIEDEL : 'Two reduction formulas applicable to certain particular integrals.'

17. PROFESSOR E. B. SKINNER : 'Some forms which remain invariant with respect to certain ternary monomial substitution groups.'

18. PROFESSOR JAMES E. SHAW : 'Note indicating a new development of a determinant.'

19. PROFESSOR E. H. MOORE : 'On double limits.'

20. PROFESSOR E. H. MOORE : 'Concerning the fundamental propositions of the theory of proper definite integrals.'

21. MISS IDA M. SCHOTTENFELS : 'Proof of the existence of a particular substitution group of degree 21 and order 20160.'

In addition to the above Professor Hathaway presented a paper introducing a general discussion on the subject 'Pure Mathematics for Engineering Students.'

THOMAS F. HOLGATE,  
*Secretary of the Section.*

EVANSTON, ILLINOIS.

WISCONSIN ACADEMY OF SCIENCES, ARTS,  
AND LETTERS.

THE thirty-first annual meeting of the Academy took place at Milwaukee, December 27 and 28, 1900. The following papers were read and discussed :

'An example of a theoretical system of weight-factors, of ready application in the solution of observation equations,' by Albert S. Flint.

'Harmonic curves of three frequencies.' (Second paper.) With exhibition of stereograms drawn by E. A. Hook, by Charles S. Slichter.

'On repeating decimals,' by E. A. Hook.

'On an improved method of determining latent heat of vaporization,' by Louis Kahlenberg.

'A campaign cry of 1844,' by H. J. Desmond.

'Early political platforms in Wisconsin,' by John G. Gregory.

'Personal names, their etymology,' by James D. Butler.

'Shakespeare's knowledge of criminal psychology,' by Frank C. Sharp.

'Determinism, decrees and immutable law,' by Charles C. Caverno.

'Some recent observations on the migration of birds,' by H. A. Winkenverder.

'The plankton of Green Lake and Lake Winnebago,' by C. Dwight Marsh.

'The cause of cleavage in rocks,' by C. K. Leith.

'The supposed lessening of geyser activity in the Yellowstone National Park,' by D. P. Nicholson.

'The orientation of stream channels as related to geological structure,' by William H. Hobbs.

'The old tungsten mine at Trumbull, Ct.,' by William H. Hobbs.

'The future of the clay and cement industry in Wisconsin,' by Ernest R. Buckley, Associate Director of the State Geological Survey.

The following papers were read by title:

'On the thermal conductivity of common woods,' by L. W. Austin and C. W. Eastman.

'The expansion of wood due to the absorption of water,' by L. W. Austin, G. S. Cassels and W. H. Barber.

FRANK CHAPMAN SHARP,  
*Secretary.*

#### SCIENTIFIC BOOKS.

*Foundations of Knowledge.* By ALEXANDER THOMAS ORMOND, McCosh Professor of Philosophy in Princeton University. New York, The Macmillan Co. 1900. Svo. Pp. xxvii + 528. Price, \$3.00.

Without mincing words, it may be affirmed at once that Ormond's work is a very considerable performance. Not only this. Symptomatic books on philosophy have been none too many these last twenty-five years, and the volume before us betrays many symptoms of interest in relation to matters fundamental. Accordingly, even if it be 'meant as a first rather than a final word on the topics with which it deals' (Preface, xxv), it cannot escape the sharp analysis that all primary achievements deserve and, indeed, demand. Further, the 'General Introduction' betrays so excellent a sense of the recent historical situation, especially in British-American thought, that the things Ormond has left unsaid throw no little light on those to which he has committed himself. As the book is a first word, and largely

epistemological at that, in view of favors to come, I should like to express the hope that, in Ormond's creed, things are lawful in epistemology which must be suppressed sternly in metaphysics.

The main body of the exposition has been divided into *three* 'Parts.' In the *first*, Ormond deals with 'Ground-Concepts of Knowledge.' What he attempts here might be called a clearing of the air. That is to say, centuries of discussion and of common usage have caused many hoary associations to cluster round certain terms. Every one is aware what the words, 'Experience, Knowledge, Reality,' mean; yet, equally, no one is aware. Otherwise, these counters cover so much that few stop to deploy their implications, and the interpretation alters with the ear that hears. Personal tendencies, customary environment of intellectual habit and the like, vary from man to man, from community to community. The 'experience meeting' of the pietist, the 'experience' demanded by electors to a vacant office, 'experience' with Mr. Spencer, and 'experience' as the latter-day idealist thinks of it, are by no means the same affair. Accordingly, with true instinct, Ormond proceeds, first, to state his view of the general implications of 'Experience, Knowledge, Reality,' and a very sensible, non-partisan view it is. "We may define experience as the sum of these personal activities by means of which a conscious self reacts upon its object or not-self, and translates it into realized content, these activities being inclusive of thought, feeling and will; or, objectively—the system in which these activities are included" (50). "The notion of reality includes a synthesis of being and manifestation" (64). "The method of knowledge, as we have conceived it, is an embodiment of the inner dialectical process by which the content of experience is reduced to the content of knowledge" (104). Such are the essential statements.

The *second* Part reviews the 'gradual development of the knowing processes,' and is entitled, 'Evolution of the Categories of Knowledge.' At this point, even if one have not noted its presence previously, the modern outlook of the work becomes abundantly apparent. To be specific, the contemporary de-

mand for a dynamic, as opposed to a static, view of experience receives satisfaction. After analyzing the nature of the categories, Ormond proceeds to thresh the old straw of Space, Time, Quantity, Quality, Cause and Substance, offering, however, certain stimulating novelties, particularly in his treatment of the two last; this, even if we demur to his allegations that 'The notion of agency is a persistent element of that of cause' (174), and that 'the category of substance represents the mode by which experience realizes those points of rest or permanence in its world which are necessary in order to render the series of changes possible' (192). Thence he passes to the subject so much agitated and so vitally interesting to-day—to 'Community or Interaction, the Dynamic Consciousness, the Æsthetic Categories, the Subject Consciousness, Categories of the Subject Consciousness, the World of Individuals, the Consciousness of Community.' The point at which he elects to take up the 'Subject Consciousness' is worthy of especial remark. Every praise ought to be accorded this abundant recognition of the newer insights and problems. Similarly, one cannot fail to be struck favorably with the frank manner in which Ormond tackles this task, even although he proceeds from presuppositions that antedate the dynamic categories, do not grow out of them, nay, as the strong probability runs, are forbidden, if not exploded entirely, by them.

To readers of SCIENCE, the *third* Part presents much matter of genuine interest. Greatly daring, Ormond has christened it 'The Transcendent Factor in Knowledge.' But names need not frighten us, when we discover that he places within these dread limits that vital modern problem, the relation between science and philosophy. Moreover, in outlining this relation, he formulates what must be taken as his characteristic contribution to pending metaphysical inquiries—the concept of *transcendency within experience*. "We have seen that science deals with the transcendent and that metaphysics has something to do with experience. \* \* \* The discussion \* \* \* has put us in a position to see that one of the points of difference consists in the fact that the aim of science, in so far as it finds it necessary to recognize the

transcendent at all, is simply to employ the concept of it in determining the nature of the relative in experience. This accounts for the fact that science stops in its attempt to define the transcendent at that point where that process ceases to be necessary to the definition of the relative. Metaphysics, on the other hand, is directly concerned with the determination of the transcendent, not so much as a principle for the definition of the relative in experience, as for the complete determination and satisfaction of the relative experience as a whole through the grounding of it in that which is absolute and complete. Having for its aim then the grounding and completing of the relative experience itself in that which transcends it, the determination of this transcendent nature becomes a matter of direct interest to it, and its attitude toward the transcendent is from the outset, therefore, different from that of science" (323-4).

At this point precisely, one must take issue with the author. If what he says about the mission of metaphysics be true, then science may once more say to philosophy what she has sometimes said before: 'All right, I'll keep the inside of the house, you may do as you will with the outside.' For, by definition, the transcendent happens to be the super-experiential, that concerning which anything may be said; and we cannot too often recall that anything and nothing are identical. To attempt to fill out this word with meaning, as Ormond seems to do again and again, is, of course, to negate transcendency. The fact is that Ormond (this is part of his great interest) represents a point of view which, unconsciously, mediates between the old pre-Kantian dualism and the desiderated organic monism—a theory still in the air, but, nevertheless, the sole defensible ground of scientific dualism, and also of the conservation of those aspects of experience which Ormond has in mind when he writes 'transcendent.' Had he ploughed longer with the heifer of science, he might have earned vouchers admitting him to this philosophical paradise; as it is, he who runs may read the flaw in the credentials presented here.

Consider the following passages, for example. "The real, then, is possible content of con-

sciousness and will be found to be a transcendent term in relation to an actual consciousness. It will include the realized content of the actual consciousness; also that which is simply present *in* or *to* consciousness, together with an extra-conscious sphere which exists as yet only as implicate or postulate" (90). The *extra-conscious* as implicate of consciousness! Are we able to attach any clear idea to what is either unthinkable or else a concatenation of mere words? Again, in Ormond's definition of Category, the cloven-hoof of the Devil whose delight lies in shattering human experience, plants itself firmly. "A category may then be defined; subjectively, as the constitutional mode through and in which the subject-consciousness penetrates its world, and reduces it to ideal content, and objectively, as the form which the world or not-self is obliged to assume in order to present itself to and in consciousness and become content of its world-idea" (117). 'Obliged' were truly a symptomatic term. The problem of the unity of experience seems to be trebled here. For we have a hint of no less than three universes, to wit, a subject-universe, an object-universe and a category-universe. The conception that ideas are forms (the conception, be it remembered, which has retarded so seriously metaphysical advance, and progress in unitary understanding of the world, by rendering science and philosophy alien from each other) has once more elbowed out the hopeful contemporary insight, that ideas are forces; that 'matter,' in so far as amenable to scientific treatment, is intelligent, because intelligible; that the universe is a universe, because built in one piece, and all inclusive. Yet again, (1) "Without cause no beginning of change would be conceivable, but without substance the very notion of change would be absurd. Cause is the principle in accordance with which changes are organized into a mutually dependent system; substance is the principle which in its notion of permanence supplies the condition which our world demands in order that the system of changes may be possible." \* \* \* (2) "The points of rest are relative, therefore, and have their common presupposition in the central activity of self-consciousness"

(192-3). Here a very old friend puts in appearance, no doubt with face washed or smeared somewhat, yet with character unaltered. So far as the statement of *process* goes, (1) and (2) land at last in mutual exclusions, as they have ever done.

As Ormond is aware, no modern thinker would deny the existence or the potency of the element which he calls 'transcendent.' But the moment you term it 'transcendent,' you turn it into a kind of waste-paper basket, the convenient receptacle for every sort of inconvenient question. For instance, gravitation is an undeniable fact for the physicist's experience. But whenever you suggest its 'transcendency,' as Ormond's reasoning would, you leave the realm of experience and serve yourself some fine, mysterious feeding. The truth is that gravitation, like other 'ultimates,' is transcendental, and in the sole legitimate sense of this term; that is to say, it is constitutive. Here we come to ourselves again, and well within the sweep of experience. This solid footing reached, we cannot forbear to make the somewhat cruel point that the 'transcendent' is all too apt to provide tranquilizing refuge for those who have learned nothing and forgotten nothing. With these mummies of intellect Ormond has no commerce. But he has wandered perilously near their catacombs; nearer than he knows, possibly, when he writes thus: "There is no reason to suppose then that the distinction between the absolute and relative is other than ineradicable, but, on the contrary, the whole trend of experience tends to confirm what is also a necessity of thinking; namely, that the grounding of any distinction in the absolute is the highest guarantee we can have of its reality and permanence" (419-420). Moreover, the results of this excursion into a field so perilous crop out continually in the curious attitudes he adopts so often in the third Part. What is the man, who is looking for guidance from the very last word uttered in metaphysics, to make of this? "The notion of revelation will be completed then in the idea of the direct function of the transcendent other in introducing a new and superordinary content into our consciousness, the subjective condition of the reception and realization of which is that state of



the subjective consciousness to which the term inspiration is applicable" (491). As a piece of acrobatic audacity, excellent! Yet we may well doubt whether a thinker standing with one foot firmly planted on the Rock of Ages, the other pointing heavenward, has struck the attitude most conducive to progress. Of course, he is so interesting that we should dearly love to secure his photograph to show to our scientific friends, who would be tickled rather than impressed.

To make an end; this book constitutes one of the freshest and most stimulating contributions to philosophical inquiry that we have had for many a day. It represents an enormous advance on Ormond's earlier work. And if the author could but shake himself free from the hypnotic suggestion now exercised over him by the 'transcendent,' he might very easily, in that further discussion hinted in his Preface and looked for with lively expectation by the present writer, produce a book as superior to this as this is to 'Basal Concepts in Philosophy.' In short, Ormond stands on the very edge of the pathway to really constructive leadership.

It remains to say that the publishers have executed their part admirably. Printed at the famous Glasgow press, the book, despite its 540 pages, is light to hold and easy to read. In another edition the usefulness of the index might be much enhanced.

R. M. WENLEY.

UNIVERSITY OF MICHIGAN.

*Chemie der Eiweisskörper.* Von DR. OTTO COHNHEIM. Braunschweig, F. Vieweg und Sohn. 1900. Pp. 315.

In recent years no book dealing with the proteids and their derivatives has appeared which is so comprehensive and satisfactory as Cohnheim's 'Chemie der Eiweisskörper.' The references to the literature of the subject are unusually exhaustive and include practically every important contribution made prior to 1900. The work of American physiological chemists is cited mostly from abstracts, and some of the more recent papers have not yet found their way into the book; it is to be hoped, however, that the time is approaching

when American papers will be studied at first hand in all European laboratories. Cohnheim's 'Eiweisskörper' is something more than a mere compilation of the results of the chemical investigation of the proteids. The author's critical study of the voluminous literature on the subject is indicated by the discriminating judgment with which he has treated many controversial topics and by the succinct manner in which many of the unsolved problems are pointed out. The book is essentially a critical review, and the mode of presentation (for example, of heat coagulation and other physical modifications of the proteids) is decidedly more suggestive than that of most recent writers. In the classification of the proteids Cohnheim follows the latest edition of Hammarsten's 'Text-book,' without claiming for this grouping anything more than a temporary usefulness. The author has proposed, as an innovation, to class those proteids usually termed nuclealalbumins, of which casein is the best defined type, with the simple proteids (Eiweisskörper) under the name of phosphoglobulins; the latter would thus be differentiated more clearly from the true nucleoproteids (in the sense of German writers) to which they bear resemblance only in a few superficial characters. The vegetable globulins (Phytoglobuline) are also treated in the old group of nuclealalbumins, although in the light of our present knowledge they compare more closely with the globulins of animal origin, and many of them, at least, are free from phosphorus.

Without giving a detailed survey of Dr. Cohnheim's book, a few of the better features may be referred to. The analogy in chemical behavior between the proteids and the 'pseudobases' of Hantzsch is pointed out, and a very complete account of the decomposition products of proteids is given, especially of the carbohydrate groups lately identified by various investigators. The sulphur content of the proteids is discussed in detail; and the literature regarding the nitro- and halogen compounds—almost entirely the outcome of very recent work—is collected and reviewed for the first time. In his treatment of the albumoses and peptones the author follows the classification introduced by Hofmeister and his pupils, although the

older worker is by no means overlooked. The more thoroughly studied substances, such as egg- and serum-proteids with their crystalline forms, are taken up at length; and the muscle proteids are presented in the light of v. Fürth's work. To the physiological chemist who has occasion to refer frequently to recent investigations on the nucleoproteids and their derivatives, the careful summary of research in this field of work will be found most helpful. Thirty pages are devoted to the chemistry of hæmoglobin, and the chapter on the albuminoids is fairly exhaustive.

The volume is appropriately dedicated to the memory of W. Kühne.

LAFAYETTE B. MENDEL.

YALE UNIVERSITY.

*Treatise on Hygiene.* By J. LANE NOTTER. Second edition. P. Blackiston's Sons & Co. 1900.

This is the second edition of the well-known book of Notter and Firth, which itself was founded on the still earlier treatise of Dr. A. E. Parkes.

It is a very comprehensive work, containing nearly eleven hundred pages, and treating of a very wide range of topics, such as, for instance, water, air, food, heating, ventilation, clothing, exercise, construction of houses, vital statistics, and military and naval hygiene.

The book as a whole is excellent, the material is well selected, and the views thoroughly modern. Treating such a wide range of subjects as the authors do, they must necessarily give frequently the opinions of others rather than their own, and this causes at times, where opinions differ, a lack of authority. In a few places remains of earlier editions crop out; thus under malarious soils no mention is made of the mosquito, but in another portion which is devoted to malaria the relation of the insect to the disease is fully stated.

In some places important omissions occur: thus in the preservation of milk cold is hardly alluded to, yet it is almost as important as cleanliness. The number of bacteria considered suitable in milk, 400,000 per cc., seems very high. Taking the book as a whole, it is one that can be thoroughly commended to those

who have either a general or a special interest in the study of hygiene.

W. H. PARK.

SCIENTIFIC JOURNALS AND ARTICLES.

THE *Journal of Comparative Neurology* for December contains the following articles: 'The Giant Ganglion Cells of *Catostomus* and *Coregonus*,' by J. B. Johnston, West Virginia University. The author figures and describes successful Golgi preparations of these transient nerve cells and compares them with the sensory cells in the spinal cord of *Amphioxus* and *Petromyzon*, whose fibers reach the periphery without effecting relations with cells of the spinal ganglion. It is suggested that they are belated neural crest cells which failed to migrate into the spinal ganglia. 'Arrangement and Terminations of Nerves in the Oesophagus of *Mammalia*,' by Lydia M. DeWitt, University of Michigan. Investigations on the cat and rabbit by the *intra vitam* methylene-blue method. The following types of nerve termination are described: typical motor and secretory fibers from sympathetic ganglia of Auerbach's and Meissner's plexuses, motor fibers from the ventral horns of the spinal cord for the striated muscle fibers of the oesophagus, sensory termini in the mucosa from cells of spinal ganglia, and other sensory fibers, apparently wholly confined to the sympathetic nervous system. 'The Vibrissæ of certain Mammals,' by J. Franklin Messenger, University of New Mexico. The innervation of the hair follicles is figured and a peculiar erectile vascular pulvinus is described. 'The Ophthalmic and Eye Muscle Nerves of the Cat Fish (*Ameiurus*),' by I. S. Workman, Denison University. The cat fish is shown to resemble other teleosts in the absence of a *r. ophthalmicus profundus*. The nerve so named by some anatomists is the *r. ophthalmicus superficialis V*, to which are added facialis fibers for terminal buds on the top of the head. The eye muscle nerves show a ganoidean arrangement. 'On the Homologies of the Chorda Tympani in Selachians,' by H. A. Green, Denison University. The selachian types examined exhibit a pre-spiracular nerve, in addition to the *r. palatinus* and the true pre-trematic ramus for the pseudobranch, which runs down between the

mandible and the hyoid arch and whose morphological relations seem to be the same as those of the mammalian chorda. The editors announce the addition of Dr. Lewellys F. Barker, of the University of Chicago and Rush Medical College, to the staff of editorial collaborators.

In an article entitled 'The Recent Development of Method in Theoretical Physics,' published in the January *Monist*, Professor Ludwig Boltzmann, formerly of Vienna but now of the University of Leipsic, has presented a trenchant criticism of the philosophical tendencies now dominating physical research. Professor Boltzmann is an outspoken votary of the classical or atomistic physical philosophy which culminated in the labors of Faraday and Maxwell; and after rapidly sketching the rise and development of the mechanical philosophy he proceeds to subject to searching scrutiny the views of the energeticians (Ostwald, Helm, etc.) and the phenomenologists (Kirchhoff and Mach). While not underrating the achievements of either of these two recent schools of physical theory, he asserts that the early acquisitions of the atomistic inquirers could never have been reached by energetics or by phenomenology. To the same number of *The Monist*, MM. Vaschide and Piéron, of Paris, France, have contributed an erudite article on 'Prophetic Dreams in Greek and Roman Antiquity,' for which they have collected from the original sources all the data in the ancient writings relating to oneirology. The remaining articles are an 'Introduction to a Psychological Study of Religion,' by Professor James H. Leuba, and 'Jew and Gentile in Early Christianity,' by Dr. Paul Carus.

THE December number of the *American Geologist* contains the following articles: 'Notes on the Geology and Petrography of Monhegan Island, Maine,' by E. C. E. Lord of Washington, D. C. The works are described as granitic, containing feldspar, olivine, pyroxene and hornblende. The rocks are analyzed petrographically and chemically and compared with rocks from other districts. The mass is frequently crossed by acid and basic dykes which are described and analyses given. 'The Mineralogical and Petrographic Study of the Gabbroid Rocks

of Minnesota,' by N. H. Winchell, contains Chapters VIII. to X. inclusive and concludes the series. Chapter VIII. contains a discussion of Quartz Gabbro, in which is given the minerals and their occurrence together with their chemical composition. Chapter IX., Silico ferrolite, contains a discussion of a rock extremely rich in magnetite containing numerous grains of quartz. This name has been proposed by Mr. Winchell to distinguish the rock from the ferrolite of Wadsworth, which it resembles. Chapter X., 'Résumé and Conclusions,' contains discussions of the comparative petrography, the mineralogical and chemical composition of the various types of rock studied in the preparation of the report. Next is an interesting article on 'Meteorology of the Ordovician,' by F. W. Sardeson, which is followed by the usual editorial comments, a review of recent geological literature and personal and scientific news.

DR. A. DE WATTEVILLE has resigned the editorship of *Brain*. When accepting his resignation the Council adopted the following resolution: "The Council accepts with great regret Dr. de Watteville's resignation of the editorship of *Brain*, and desires to take this opportunity of recording the deep debt of gratitude that the Society owes him for the way in which he has conducted the Journal for the past twenty years. The Council feels that parting with Dr. de Watteville is an event of great moment to the Society, for he has not only brought *Brain* to a high standard of perfection and secured for it a great European reputation, but even the existence of the Journal at the present time is due to his energetic action at a critical juncture in 1880. Moreover, the Council is mindful that the Society itself took origin on Dr. de Watteville's initiative, at a meeting held at his house, on November 14, 1885."

#### SOCIETIES AND ACADEMIES.

##### GEOLOGICAL SOCIETY OF WASHINGTON.

AT the eighth annual meeting, held December 19, 1900, the following officers were elected for the ensuing year:

*President*, J. S. Diller; *Vice-Presidents*, C. W. Hayes and G. P. Merrill; *Treasurer*, M. R. Campbell; *Secretaries*, David White and F. L.

Ransome. *Members-at-large of the Council*, Bailey Willis, A. H. Brooks, W. Lindgren, G. O. Smith, T. W. Stanton.

The address of the retiring president, Mr. Whitman Cross, on 'The Development of Systematic Petrography in the Nineteenth Century' was delivered in connection with this meeting.

At the 108th regular meeting, held January 9, 1901, the following papers were presented:

N. H. DARTON: *Comparison of Stratigraphy of the Black Hills with that of the Front Range of the Rocky Mountains.*

After several years of detailed investigation of the stratigraphy of the Black Hills in South Dakota and Wyoming, a preliminary examination has recently been made of the region southwest to and along the front ranges of the Rocky Mountains across Wyoming and Colorado. The Black Hills are due to a local expansion of a branch of the Laramie range, but the connection underlies a country in great part covered by Tertiary deposits. In the vicinity of Hartville, about 125 miles southwest of the Black Hills, there is a local uplift on this line, affording extensive exposures of formations from the crystalline schists part way up the Mesozoic column. The stratigraphy is here very similar to that of the Black Hills, and all the principal formations from Lower Cretaceous sandstones to the Lower Carboniferous limestone can be distinctly recognized. Along the flanks of the Laramie range, and southward into Colorado, the formations present considerable change, but numerous features of close relationship were observed. In the fine sections at Morrison, west of Denver, there was found an extension of the Purple (Minnekahta) limestone of the Black Hills, having precisely similar stratigraphic relations in the Red beds, and containing some of the same Permian fossil, although these are scarce and not well preserved. The limestone was traced south for a considerable distance and found to merge into a sandy bed which was finally lost in the great mass of coarse red deposits in the vicinity of the Garden of the Gods. Its very distinct occurrence at Morrison affords the means for a precise correlation with the Black Hills region. The underlying mass of coarse sandstone lying

against the crystalline rocks represent portions or perhaps all the Carboniferous formations of the Black Hills. The Red beds overlying this Minnekahta limestone at Morrison are gypsiferous shales similar to those of the Red Valley encircling the Black Hills. The Morrison formation lying next above, is, as previous observers have pointed out, the equivalent of the Alantosaurus (Beulah) shales and the marine Jurassic which was traced as far south as the Hartville region, is lacking in the Morrison section. The lower Cretaceous sandstone in the Black Hills has not been recognized in Colorado. The Benton formation presents the same three divisions through the Black Hills region as were determined by Gilbert in southern Colorado. In the valley of the Purgatoire in southern Colorado the Red bed series are represented by red sandstones of moderate coarseness, in the upper bed of which was discovered a bone of a *Bolodont* which is thought to be of Triassic age. The overlying series of gypsum, limestone, and shale yielded no fossils, but probably comprises a representative of the Morrison formation, for its upper part it least has all the characteristic features of the Alantosaurus shale. It is overlain by so-called Dakota sandstone.

ALFRED H. BROOKS and ARTHUR J. COLLIER:  
*Glacial Phenomena of the Seward Peninsula.*

The Seward Peninsula, stretching out toward the Siberian coast from northwestern Alaska, separates the Arctic Ocean from Bering Sea.

It consists, topographically, of low, rounded hills whose gentle slopes are often broken by well-marked benches. Above this upland, rise three notable mountain masses. The Kiglowaik range, whose highest peaks reach an elevation of 4,500 feet, is a rugged mountain mass lying some 80 miles north of Nome. To the northeast of this range is another mountain mass, which, extending to the northeastward for some 80 miles, sweeps around the headwaters of Fish River, and joins the mountains east of Golofnin Bay. The York Mountains, the third mountain mass, extend inland from Cape York.

In this region there is no evidence of general glaciation. In fact, there is positive proof

against it. The three mountain masses have, however, as shown by studies of the past season, been centers of local glaciation. In the Kiglow-aik range the valleys are glaciated to an elevation of 500 feet above the valley floor, and the moraines marking the limits of this glaciation were deposited close to tide-water. The evidence of ice action consists of cirques, U-shaped valleys, morainic topography, and glacial erratics. Indeed, in some of the higher valleys still exist the shrunken remnants of the former valley glaciers. These small glaciers, in latitude 65, are, as far as known, the most northerly on the continent.

The high benches and terraces show that the western part of the peninsula has been elevated 600 or 800 feet in recent times. This elevation, however, antedates the maximum extension of the valley glaciers above described.

A. C. SPENCER: *The Physiography of the Copper River Basin, Alaska.*

The observations made by Messrs. A. C. Spencer and F. C. Schrader during the summer of 1900, establish the existence of a peneplain in the Chugatch Mountains, between the coast and the interior basin of the Copper and Chitina (Chittyna) rivers, and in the adjacent mountains at the heads of the Chitina, White and Tanana rivers.

The peneplain is now a dissected plateau with an elevation of more than 6,000 feet. Above it rise Mt. Blackburn and Mt. Natzahat to elevations of several thousand feet, the former, at least, being of extrusive origin. The age of this marked physiographic feature is not earlier than late Cretaceous nor later than Miocene. As the Eocene and Miocene are known to have been periods of baseleveling in western North America, it is probable that the peneplain is of Tertiary age. Whether it should be correlated with the Yukon plateau, considered as Miocene, or whether it is an older feature, has not been determined. It is\* of the same order of maturity as that plateau, and if it can be shown to be of the same age, its present altitude, several thousand feet above the adjacent portion of the great interior plateau of Alaska, shows that there has been faulting along the scarp which the St. Elias Range and its north-

western extension present towards the north-east.

F. L. RANSOME,  
DAVID WHITE,  
*Secretaries.*

BIOLOGICAL SOCIETY OF WASHINGTON.

The 332nd meeting was held on Saturday evening, January 12th.

W. H. Dall exhibited a skiagraph of a number of univalve mollusks, taken by a comparatively short exposure to the X rays, and yet in spite of their calcareous nature showing the structure and form of the interior whorls very distinctly.

Vernon Bailey showed a specimen of a commercial skin of a grebe, saying that the grebes, as well as other water fowl, were being killed in great numbers in the shallow lakes of Oregon and Washington, particularly in the Klamath lakes, and that it was to be hoped that something might be done to protect these birds before it was too late.

William Palmer exhibited a series of specimens of the Cuban branching fern, *Gleichenia dichotoma*, describing its various stages of growth and comparing them with those of other species.

Frank K. Cameron spoke of 'The Formation of Black Alkali by Plants,' stating that it has long been believed that certain plant varieties cultivated on the arid soils of the West can cause an accumulation of sodium carbonate or 'black alkali.' This question has received some attention in the past, notably by Hilgard in California and Goss in New Mexico. An examination of the question in the laboratory of the Division of Soils, U. S. Department of Agriculture, indicates that in some cases there is an enormous accumulation of sodium in the leaves and stems of certain plants, more than sufficient to combine with the inorganic acids present and therefore in organic combination. On decay this material yields considerable amounts of alkali carbonates, which accumulate on account of the peculiar conditions of moisture and drainage which obtain for soils in arid regions.

The study has led incidentally to a discussion of the phenomena involved in the absorption of mineral salts by plants, from the point of view of the chemist; and lines of investigation

of possible value to the physiologist are tentatively suggested.

The detailed description of the study will appear at an early date in the 'Report of the Field Operations of the Division of Soils for 1900.'

T. H. Kearney discussed 'The Effect of Alkali Salts on the Growth of Seedling Plants,' describing a series of experiments conducted with the assistance of Dr. F. K. Cameron of the Division of Soils, Department of Agriculture, in order to ascertain the relative injurious effects upon plants of the salts characteristic of the so-called 'alkali' lands of the Western States. The salts employed were  $\text{Na}_2\text{CO}_3$ ,  $\text{MgSO}_4$ ,  $\text{MgCl}_2$ ,  $\text{Na}_2\text{SO}_4$ ,  $\text{NaHC.O}_3$ ,  $\text{NaCl}$ ,  $\text{CaCl}_2$  and  $\text{CaS.O}_4$ , enumerated in the order of their toxicity so far ascertained; the first of these was the most harmful. Solutions were made in each case on the basis of a normal solution, that is, of the equivalent in grams per liter of the reacting weight of each salt. Young seedlings of *Lupinus albus* were selected for these experiments because of their sensitiveness to toxic substances, and because when proper conditions of germination are maintained their clear, straight radicles are admirably adapted to recording the rate of growth and other changes. The importance of continuing the investigations with other plants of widely different relationships was nevertheless emphasized.

One experiment was made with water heavily charged with  $\text{CO}_2$ , in order to ascertain whether the H ions set free by the dissociation of the hypothetical  $\text{H}_7\text{CO}_3$  might not prove toxic to the radicles. No harmful effect was obtained.

$\text{CaCO}_3$  and even  $\text{MgCO}_3$ , added in powdered form to solutions of  $\text{NaCl}$  and  $\text{Na}_2\text{SO}_4$ , tended to neutralize the injurious effects of those salts. Still more marked was the influence of  $\text{CaSO}_4$ , when added to very toxic solutions of  $\text{NaCl}$ , in checking the action of the latter.

Solutions of many of those salts, *e. g.*,  $\text{Na}_2\text{CO}_3$ ,  $\text{Na}_4\text{SO}_4$  and  $\text{CaCl}_2$ , when of a dilution well below the toxic limit, served as actual stimuli to growth.

O. F. Cook presented a paper on 'The Origin of the Cocoa Nut,' prefacing his remarks with the statement that the origin of

many of our domesticated plants was unknown, and in other cases obscure. It was extensively believed that the cocoa nut was a native of Asia and introduced into tropical America, but the speaker showed by quotations from early Spanish writers that it was here at the time of the discovery of America. De Candolle's reasons for and against the American origin of the cocoa palm were critically reviewed and the conclusion reached that the objections to the American origin could be successfully combated.

Attention was drawn to the fact that, contrary to universal belief, the cocoa nut could not withstand exposure to salt water, and that it was not likely that so delicate a palm had received its wide distribution by any other than human agency. Finally Mr. Cook stated his belief that the cocoa palm had its origin in some of the valleys on the western slopes of the Andes and had travelled westward in company with man.

F. A. LUCAS.

#### PHILOSOPHICAL SOCIETY OF WASHINGTON.

At the 528th meeting, held January 19th, Mr. L. A. Fischer read 'A Brief History of the Office of Standard Weights and Measures.' He said the office had grown up under the necessity of providing uniform standards of weight and measure for the custom houses. In 1836 copies of these standards were ordered to be furnished to the several States. In 1866 the office was directed to supply copies of metric standards, and still later it has been charged with verifying polariscopes and instruments for electrical measurements.

Mr. A. L. Day, now of the Geological Survey, gave an interesting account of the development, organization and work of 'The Physikalische-Technische Reichsanstalt' of Berlin, in which he was engaged for several years.

Mr. S. W. Stratton, by invitation, spoke on 'The Proposed Standardizing Bureau,' giving a résumé of the plans and of the means taken to bring the subject before Congress, and reading from printed reports some of the arguments made before committees.

CHARLES K. WEAD,  
Secretary.

## THE LAS VEGAS SCIENCE CLUB.

THE second meeting of the Las Vegas Science Club was held January 8th. Mr. Frank Springer exhibited and commented upon some crinoids from the Burlington Limestone at Lake Valley, New Mexico. He also exhibited and discussed specimens of *Uintacrinus socialis*, Grinnell, which he had found beautifully preserved in the cretaceous of Western Kansas. He showed a number of plates to illustrate a memoir on this species, which will shortly be published in the *Memoirs* of the Museum of Comparative Zoology. The abundance and excellent preservation of the material had permitted him to determine many new facts regarding *Uintacrinus*; and after tabulating the characters of over 600 individuals it became evident that *U. socialis* of America and *U. westfalicus* of Europe were identical, the supposed specific distinctions being due to age and variation.

Mr. E. L. Hewett spoke on the ancient cliff-dwellings and communal buildings of the Pajarito district, New Mexico. He had for some years been engaged in the investigation of these, and presented a map showing their distribution, a number of plans and photographs, and a collection of objects obtained from the dwellings and burial mounds. The communal buildings of the Tehrega, Tsankiwi, Navakwee and Otow; mesas were described; the first of these was estimated to have contained nearly 1,500 rooms, being much larger than the buildings still in use at Taos. Mr. Hewett referred to the importance of preserving these ruins for systematic and careful examination, and the desirability of retaining as public property such important evidences regarding the early man of America as abounded throughout the district. To this end a bill is now pending in Congress, which provided for the retention of the district as a National Park.

T. D. A. C.

## NEW YORK SECTION OF THE AMERICAN CHEMICAL SOCIETY.

A STATED meeting was held at the Chemists' Club, 108 West 55th Street, on January 11th, Dr. C. A. Doremus, presiding, and 53 members present.

Dr. Parker reported progress for the Committee appointed to confer with the Bureau of Combustibles in regard to the storage of acids.

The Chair reported that the revision of the By-Laws was in the hands of the Executive Committee in accordance with the action taken at the November meeting. A resolution offered by A. C. Hale was then read as follows:

*Resolved*, That the New York Section of the American Chemical Society herewith extends a most cordial invitation to the Society to celebrate the 25th anniversary of its foundation next April in New York City, and the Chairman of the New York Section is hereby authorized and directed to appoint such local committees as he may deem expedient in order to aid in perfecting arrangements for such celebration."

The resolution was unanimously approved and the Secretary was instructed to formally extend the invitation to the Society at large.

Dr. T. O'Connor Sloane then read his paper entitled, 'Notes on Spheroidal State Evaporation,' with experiments.

Dr. McMurtrie made a report on the Mid-winter meeting just held in Chicago, to the effect that it had been very successful, and the visiting members were well entertained. One hundred and thirty-nine members were registered. Numerous applications for membership in the Society had been entered as a result of the interest aroused.

DURAND WOODMAN,  
Secretary.

## DISCUSSION AND CORRESPONDENCE.

## NOTE ON VEGETO-ELECTRICITY.

IN SCIENCE, September 8, 1900, is an abstract of a paper, by Dr. Waller, on 'The Electrical Effects of Light upon Green Leaves,' which recalls an experience noted in 1888 in my physical laboratory work. In June of that year I asked a student to determine the magnetic elements at a certain place, just under the outer ends of the long branches of a low Norway maple. He reported that the magnetometer was in such continual tremor and slight shifting about that it was impossible to make accurate readings. This continued for hours; and was quite noticeable again some days subsequently

—so that the station was abandoned. This movement was not due to wind, nor to a magnetic storm, nor to any mechanical jarring of the earth.

Except an indefinite item in a newspaper, I have seen no mention of a similar experience.

To determine whether there is from trees such a discharge of electricity as might affect a delicate magnetic needle, I made (in 1895) a coil about 80 cm. diameter of fifty turns of wire, mounted on the end of a long pole, with a contact breaker and a telephone receiver in circuit, and had this coil held in such relation to large, dense limbs of trees as to enclose the lines of magnetic force from a discharge stream (if there be one) of electricity from the limb, selecting limbs in such direction as would make the coil when in proper relation lie in the magnetic meridian plane, determined by simple compass.

April 8th–12th, buds just swelling on deciduous trees, I tried a number of trees, including two or three evergreens. I could hear no disturbance in the telephone, in any position of the coil. Then putting the coil in the magnetic meridian, as explained above, to make the action (if any) stronger than mere variation of discharge, I had the circuit opened and closed. Still there was not the slightest effect perceptible. In the latter half of May, leaves quite fully developed on all except the various oaks, the experiments were repeated with the same negative results.

According to Dr. Waller's experiments, it would have been better to try my experiment in June (when the unexplained action was observed), rather than April and May, the leaves then being in fuller vigor and the temperature higher.

I. THORNTON OSMOND.

STATE COLLEGE, PA.,

January 21, 1901.

SCIENTIFIC EXPEDITION TO ICELAND, GREENLAND AND LABRADOR.

A GEOLOGICAL and geographical excursion in the North Atlantic is planned for the summer of 1901. Conditionally on the formation of a sufficiently large party, a steamer of about 1,000 tons, specially adapted for ice navigation, and capable of accommodating sixty men, will leave

Boston on or about June 26th and return to the same point on or about September 20th. The main object of the voyage will be to offer to the members of the excursion party opportunity of studying the volcanic cones and lava-fields, the geysers, ice-caves and glaciers of Iceland, the fiords and glaciers of the west coast of Greenland, and the mountains and fiords of Northern Labrador. Some attention will be paid to the hydrographic conditions of the waters traversed. Botanists, zoologists, ornithologists, mineralogists and those interested in other branches of natural history may pursue independent studies. A hunting party may take part in the expedition; it could be landed for a fortnight or three weeks in Greenland and for about the same period in Labrador.

Explanatory lectures on the regions visited will be given from time to time by the leader of the excursion, who will also act as guide on the Labrador coast where he spent the summer of 1900. It is expected that in Greenland and Iceland, specialists on the geology and physical geography of these countries will lead the party. Wherever possible the attempt will be made to increase the stock of existing information concerning the three regions. It is desirable, though not necessary, that applicants for membership in the party possess at least an elementary knowledge of geology. Citizens of other countries as well as of the United States are invited to participate in the expedition. A physician will accompany the party.

An inclusive fee of \$500 for each member will be charged, \$250 to be deposited with the leader of the expedition on or before March 15th, the balance to be paid on or before June 1st.

The trip will be under the direction of the writer, and applications for membership should be addressed to him.

R. A. DALY,

*Department of Geology and Geography, Harvard University.*

#### CURRENT NOTES ON METEOROLOGY.

REPORT OF THE CHIEF OF THE WEATHER BUREAU.

THE 'Report of the Chief of the Weather Bureau for 1900' devotes considerable space to forecasts. The beginning of storm forecasts for



the North Atlantic Ocean is noted, this step being made possible by the use of reports now received from the West Indies, the Bahamas, Bermuda, France, Great Britain, Germany, etc. Whenever possible, forecasts are to be made of wind force and direction for the first three days of the voyage of all outgoing steamships. A brief history of each hurricane that occurred during the year is given, with copies of statements from persons not connected with the Weather Bureau regarding the efficiency of the storm-warning service. An important improvement in connection with the display of storm-warnings for the benefit of mariners has been made by the adoption of a specially constructed steel tower, with a flagpole at its summit. From this pole the signal flags are flown by day, and on it lanterns are displayed at night. 'Eminently satisfactory' progress is reported to have been made with experiments in wireless telegraphy. The importance of the Weather Bureau's Lake Marine service may be understood from the statement that 'each of the 20,000 or more vessels that pass Detroit receives the latest information available with regard to the force and direction of the wind, and the location and probable movement of storms.'

#### WEST INDIAN HURRICANES.

UNDER the title 'West Indian Hurricanes' the Weather Bureau has issued a report, prepared by Professor E. B. Garriott, which will find many interested readers. Since the United States has come to take an active political interest in West Indian affairs, West Indian hurricanes have assumed an additional importance in the eyes of the American people. This monograph gives a general account of these storms, their laws of circulation, cloud movements, tracks, formation, prognostics and characteristic phenomena. Poëy's table of hurricanes from 1493 to 1855 is given, supplemented by a table based on Weather Bureau records, giving the hurricanes from 1878 to 1900. Then follow brief descriptions, arranged by months, of recent hurricanes, including the famous 'Galveston Storm' of last September, and lastly local descriptions of historic hurricanes. Charts showing the hurricane tracks for each month for the years 1878 to 1900 accompany the

report, which is to be recommended as being a readable, non-technical discussion of the subject with which it deals.

#### MONTHLY WEATHER REVIEW.

THE *Monthly Weather Review* for September (issued November 16th) contains the following articles: 'West Indian Hurricane of September 1-12, 1900,' by Professor E. B. Garriott; 'Special Report on the Galveston Hurricane of September 8, 1900,' by Dr. I. M. Cline, Local Forecast Official at Galveston; 'The Storm Waves of South Carolina and Texas,' by General E. P. Alexander; 'On the Color and Polarization of Blue Sky Light,' by N. E. Dorsey; 'Review of Professor Very's Memoir on Atmospheric Radiation,' by N. E. Dorsey; 'The Frequency of Hail in the United States' and 'The Crop as depending on Meteorological Conditions,' by Professor Cleveland Abbe.

R. DEC. WARD.

#### BOTANICAL NOTES.

##### BOTANICAL OPPORTUNITIES IN WASHINGTON.

It may be doubted whether the botanists of this country fully realize the magnitude of the botanical work now being done in Washington. In the Department of Agriculture there are several 'divisions' devoted wholly to botanical investigations, and several others whose work contributes more or less to the enlargement of our scientific knowledge of plants. Thus the 'divisions' of Botany, Vegetable Physiology and Pathology, and Agrostology are so many divisions of the science of botany, while the 'divisions' of Forestry, Soils, Biological Survey, Experimental Gardens and Grounds, and Pomology, and the 'section' of Seed and Plant Introduction, are more or less contributory to botanical science. All these have much in them which is of interest to the botanist; in fact, some of the most interesting contributions to the scientific aspects of botanical inquiry have come from the second list, where the applications of science are generally emphasized. To these must be added the National Herbarium under control of the Smithsonian Institution, where are stored nearly a million botanical specimens.

With the liberal policy followed by the Secretary of Agriculture and the Regents of the Smithsonian Institution, there are here many opportunities for profitable work along different lines. In spite of the crowded quarters in which all the men in these 'divisions' are compelled to work, they are willing to make room for botanists who wish to study with them. With a little encouragement it is probable that a system of 'tables' will be arranged for the benefit of investigators who wish to take advantage of the collections, libraries, laboratories, and more than all—of the men to be found here. When we remember that there are from thirty-five to forty trained botanists in the government service, we can realize somewhat better what it may mean to most teachers of botany (generally isolated from their kind) when the opportunity is open to spend a couple of months in botanical study in Washington. So also with the lonely experiment-station botanist, puzzling over the problems that come to him, a few months of personal contact with these experienced workers in Washington would be of the greatest service. Without reflecting upon the work of the marine and other aquatic laboratories, it is safe to say that for most botanical teachers and experiment-station botanists a few weeks of study in the 'divisions' in Washington would be of more value.

In this connection it is well to emphasize the fact that the scientific 'divisions' in the Department of Agriculture should have more and better rooms for the trained men who are at work in them, as well as for the preservation of the collections, libraries and laboratories. Congress should not hesitate to grant the moderate sum asked by the Secretary of Agriculture for increased laboratory facilities. Eventually there should be a fire-proof building for the department, so planned that it may furnish adequate laboratory facilities for all the 'divisions,' and complete protection to the priceless collections of specimens and books, at the same time providing for the enlarged uses referred to above.

#### CENTRAL MASSACHUSETTS FORESTS.

In an interesting paper in *Rhodora* (Vol I., No. 8), Professor G. E. Stone discusses the

forest conditions of central Massachusetts. In the course of his discussion he says: "The characteristic forest trees in this locality are the pine, chestnut, oak and birch. The pine and chestnut are especially adapted to this region, as is shown by their great abundance, both of these being more common in central Massachusetts than in any other portion of the State. The pine is especially abundant here, because of the fact that it can adapt itself to a great variety of conditions." A little later in his paper we find that "the principal forest trees at present are the pine, chestnut, oak, birch, maple, alder, poplar, willow, ironwood, hickory, hemlock, ash, cedar, spruce, beech. Their predominance follows quite closely after the order named. This order is not, however, the same as that which occurred in the primitive forests. The hemlock, beech and canoe birch have decreased, and other species have taken their places. The pine was always, and is to-day a valuable and prominent tree in this region, and undoubtedly is holding its own. The amount of young pines now in central Massachusetts is considerable. There is in fact no tree which takes so readily to the old and neglected pastures as does the pine, and they are gradually becoming filled with this species. This is a most fortunate occurrence, as these old pastures are practically worthless for other purposes, and it is by this means that the pine holds its own so readily, and compensates for that loss which occurs in consequence of rotation with hardwood where forests of this tree have been cleared." Professor Stone concludes from a study of the historical records of the forests that "on the whole, the climatic conditions have probably not changed very much, though undoubtedly local effects have been brought about by the removal of the forests, and also from industrial activities."

#### CHRYSANTHEMUM RUST.

DR. J. C. ARTHUR, of the Indiana Experiment Station, has given the results (in Bulletin 85) of his experiments on the rust which affects the chrysanthemum. This is a true rust (*Uredineae*), and to it the name of *Puccinia chrysanthemi* has been given (1900) by Roze, a French botanist. It has been known in this country and Europe

for a few years only, but apparently it has been known for a long time in Japan. In order to settle the question whether the rusts affecting other Compositae might give rise to that on the chrysanthemum, Dr. Arthur made many cultures of the rusts on this and other related plants. He found that he could not infect other Compositae with the uredospores of chrysanthemum rust, nor could he infect chrysanthemum with the uredospores of the rusts of other Compositae. No teleutospores have yet been observed in this country or Europe, and this fact is likely to make the disease more easily controllable. Hand-picking the diseased leaves, and spraying with Bordeaux Mixture or sulphide of potassium are recommended.

CHARLES E. BESSEY.

THE UNIVERSITY OF NEBRASKA.

#### THE NATIONAL OBSERVATORY QUESTION.

THE introduction by Senator Morgan last week of a bill to organize the National Observatory of the United States, of which we have not yet seen a copy, and a letter from Professor Bigelow which we published last week, suggest a condensed statement of the points at issue. The grounds taken by SCIENCE are these:

1. The United States, like every other leading government of the world, should have a national astronomical observatory.

2. The special object of this observatory should be to make those observations and calculations on the courses of the stars which are useful in the world's progress, and require to be pursued with greater system and persistence than is possible in any but a national establishment.

3. This purpose requires that the observatory should have a well understood and well defined policy and plan of work, mapped out by the best scientific authorities at command of the nation and obligatory on the scientific staff.

4. No work but the best should be done; of second-class work an abundance may be had

everywhere. This requires that the instruments should be of the best.

5. To attain these purposes it is necessary that the head of the observatory be an experienced astronomer. This because of the high technical skill and experience required in planning the work, in seeing that the innumerable details necessary to its excellence are attended to, and in so expending the funds of the observatory as to get the best results, and also to inspire the confidence of the scientific public in the high quality of the work.

Every effort on the part of our astronomers to get an observatory of this kind established has been defeated through the impression that we already have one which answers the purpose. In the opinion of every astronomer who has publicly expressed views on the subject this is not the case. So far as we are able to collect published views, while there may be much disagreement on side issues, there is absolute unanimity that the existing observatory fails to perform the required functions in a satisfactory way. Yet, we are quite ready to regard the question as an open one until everything that can be said in favor of the work and results of the existing observatory is brought out. If there is a single astronomer in the land who, after a careful examination of the published volumes of the observatory, draws the conclusion that the objects in question have been satisfactorily gained, or, after having read the annual reports of the past five years, concludes that they describe the class and character of work which should be expected from the most expensively supported astronomical observatory in the world, the columns of SCIENCE are cordially thrown open to him to make known his views, and the facts on which those views are based.

It is a well-known fact that our existing observatory is unique in the main feature of its

organization, that of being governed by a head who is not an astronomer and who has no thread of law to guide him in his administration. Another unique feature, without parallel in the history of astronomical observatories, is the misfortunes with its instruments which we pointed out in our first issue of this year. Here our information was based wholly on the official reports, no weight being given to the possibility that the actual condition of the instruments may be a little worse than made known in the public statement. Is it possible to dissociate in the mind of the scientific public these two unique features?

We commend the reading of what Mr. Bigelow has said on the subject, though he is silent on its main points, and the grounds he takes are not at all clear to us. On one point he labors under a misapprehension. If he will re-read our article he will see that we made no charge against the administration in connection with the Magnetic Observatory, but only inquired how it happened that one of the finest magnetic observatories in existence was set-up in the immediate neighborhood of a trolley line, the electric current of which would necessarily be destructive to the results. Mr. Bigelow informs us, as a 'well-known' fact, that this was done by the united counsel of the astronomical director and a prominent visiting English astronomer and against the arguments of the professor in charge of the work, and all others in Washington interested in magnetic observations. He intimates that other interests than those of science prompted the proceedings. We are thankful for this statement, which, if correct and complete, will enable the reader to draw his own conclusions, but we do not know on what ground he says that the fact is 'well known.' It may be well known to those concerned, or to people in Washington generally, but we never before heard or read of it. We

may remind Mr. Bigelow that an unnamed 'visiting astronomer' cannot bear a heavy weight of responsibility, and we hope that he will allow this unfortunate counsellor to state his side of the case.

This summary of views, reasons and arguments, seems to exhaust the case in its present aspects, though we may need to return to it when Senator Morgan's bill and the naval appropriation bill are taken up by the Senate. The question is not of concern to astronomers only, but is probably the most important subject at present before American men of science.

#### SCIENTIFIC NOTES AND NEWS.

M. FOUQUÉ, professor of mineralogy in the Collège de France, assumed the presidency of the Paris Academy of Sciences at the first meeting of the year on January 7th, succeeding M. Michel Lévy. M. Bouquet de la Grye was elected vice-president, and will consequently assume the presidency next year.

DR. GRABOWSKY, of the Natural History Museum at Brunswick, has been appointed director of the Zoological Gardens at Breslau.

MR. E. J. BUTLER, M.B., has been appointed by the Secretary of State for India, on the recommendation of the director of the Royal Gardens, Kew, to the post of official botanist to the Indian Government at a salary commencing at £600 per annum.

MR. WILLIAM WALLACE has resigned the position of superintendent of the building of the American Museum of Natural History.

*Terrestrial Magnetism* reports that Mr. James B. Baylor has now completed the magnetic survey of North Carolina, which has been carried out at the joint expense of the U. S. Coast and Geodetic Survey and the North Carolina Geological Survey. The first report upon this work, prepared by Messrs. Baylor and Hazard, is ready for distribution.

THE British Institution of Mechanical Engineers has presented the first Willan's premium to Captain H. Riall Sankey.

LORD RALEIGH has been appointed chairman of a Board of Trade committee to consider the extent to which the working of the traffic on the Central London Railway produces vibration in the adjacent buildings, and what alterations in the conditions of such working or in structure can be devised to remedy the same.

PROFESSOR MANSFIELD MERRIMAN, head of the department of civil engineering, Lehigh University, has issued a circular letter to the County Commissioners throughout the State of Pennsylvania, offering on behalf of the University, to make, without expense to the Commissioners, tests of hydraulic cement to be used on public works. In the report of the results of these tests no opinion will be expressed on the value of the cements.

At the annual meeting of the Washington Academy of Sciences, on January 17, 1901, the following officers were elected:

Chas. D. Walcott, *President*.

W. H. Holmes, *Vice-President* for the Anthropological Society.

F. A. Lucas, *Vice-President* for the Biological Society.

V. K. Chestnut, *Vice-President* for the Chemical Society.

John A. Kasson, *Vice-President* for the Columbia Historical Society.

H. G. Dyar, *Vice-President* for the Entomological Society.

A. G. Bell, *Vice-President* for the Geographic Society.

G. K. Gilbert, *Vice-President* for the Geological Society.

S. C. Busey, *Vice-President* for the Medical Society.

J. Howard Gore, *Vice-President* for the Philosophical Society.

Frank Baker, *Secretary*.

Bernard R. Green, *Treasurer*.

*Managers*: Class 1902—L. O. Howard, J. W. Powell, Carroll D. Wright. Class 1903—F. W. Clarke, C. Hart Merriam, Whitman Cross. Class 1904—Marous Baker, Geo. M. Sternberg, G. M. Kober.

THE Middleton Goldsmith Lecture for 1901, before the New York Pathological Society, will be delivered by Dr. Charles S. Minot on March 26th. The subject announced is 'The Embryological Basis of Pathology.' We learn that it is the lecturer's intention to discuss the general laws governing both the normal and pathological differentiation of cells.

THE Duke of the Abruzzi and Captain Cagni gave before the Italian Geographical Society, on January 14th, accounts of their recent Polar expedition. The King and Queen of Italy and a distinguished audience were present. The freedom of the City of Rome has been conferred on the Duke of the Abruzzi.

PROFESSOR FRANCIS H. HERRICK, of Western Reserve University, delivered an illustrated lecture before the Sigma Xi Society of Yale University on January 19th, on 'The Habits of Wild Birds.'

THE annual meeting of the Neurological Society of London was held on January 24th, when the presidential address was delivered by Dr. W. J. Mickle on 'Mental Wandering.'

PROFESSOR SILVANUS P. THOMPSON gave a lecture on January 10th, at the Urania, in Berlin, on 'Faraday and the English School of Electricians.'

THE Royal Geographical Society of Australasia has established a Thomson Foundation Medal in recognition of Mr. J. P. Thomson's great services to the Society, of which he is regarded as the founder, and which he has served in many capacities. The gold medal is to be awarded annually for the best original contribution to geographical literature, preference being given to the geography of Australasia.

THE annual meeting of the Geographical Association was held in London on January 9th, when Mr. Douglas W. Freshman was elected president and Mr. A. J. Herbertson, vice-president. The membership of the Association is now 134, representing 84 schools and colleges. Plans are being considered for the publication of a geographical journal for teachers of geography.

THE annual meeting of the Board of Regents of the Smithsonian Institution was held on January 23d. The following changes were announced in the membership of the Board: Hon. Richard Olney, to succeed Dr. William Preston Johnston, and Judge Gray of Delaware, to fill the vacancy caused by the death of Dr. William L. Wilson. The vacancy in the executive committee, caused by the death of Dr. Wilson, was filled by the election of Representative

Hitt of Illinois. It was decided in view of the proposed abolition of the English cemetery at Genoa which contains the remains of James Smithson, the founder of the Institution, that the Secretary be requested to arrange with the authorities of some other cemetery, at Genoa, for the re-interment of Mr. Smithson's remains and the transfer of the original monument. It will be remembered that the Smithsonian Institution placed a tablet on Smithson's tomb and that it is properly cared for.

AT a meeting held recently at Colchester it was decided to erect a marble statue of William Gilbert, whose great work, *De Magnete*, published just three hundred years ago, laid the foundation of electrical science. The statue, towards which £130 has been subscribed, is to occupy a niche in the façade of the new town hall of Colchester.

WE regret to learn of the death, at the age of sixty-six years, of Elisha Gray, which occurred on January 21st, from heart disease. Mr. Gray was the author of 'Experimental Researches in Electroharmonic Telegraphy and Telephony' and of 'Elementary Talks on Science,' and is well-known for his important inventions in telegraphy, telephony and electrical appliances.

COLONEL F. F. HILDER, chief clerk of the Bureau of American Ethnology, died of pneumonia at his home in Washington on January 21st, at the age of seventy-four years.

THE death is announced, at the age of thirty-eight years, of Mr. John Henry Leech, the English entomologist. He was the author of numerous works on this science including 'The Butterflies of China, Japan and Corea.' The collections made by him for this work are now partly in the South Kensington Natural History Museum. Mr. Leech was proprietor of *The Entomologist*.

WE also regret to learn from *Nature* that Mr. S. W. Egan, since 1868 connected with the Geological Survey of Ireland, died in Dublin on January 6th; and that Dr. Giulio Pacher, docent in experimental physics in the University of Padua, has died at the age of thirty-three years.

THE will of Oswald Ottendorfer sets aside about \$200,000 for public bequests, including

\$25,000 to the American Museum of Natural History, \$20,000 to the Cooper Union for the advancement of science and art, and \$20,000 to the New York Free Circulating Library.

THROUGH the liberality of T. M. Baird, Jr., Esq., of Victoria, B. C., a tract of land on the coast of Vancouver Island, opposite Cape Flattery, has been presented for a seaside botanical station of the University of Minnesota. The erection of a group of log buildings has been begun, and a party of thirty or more botanists has been organized to open the work of the station next June.

HALF the educational staff of the Royal Engineering College at Coopers Hill has been summarily dismissed, for the purpose, as it is somewhat oddly stated, of 'reducing the present excessive cost of the staff and increasing the efficiency of the teaching.' The College at Coopers Hill is primarily for the training of students for the public works—telegraphs, railways, etc.—of India, and appears to be under the direction of a military officer with no scientific or educational qualifications and a board of visitors. There is a general protest against this action, Lord Kelvin, for example, having written to the London *Times* as follows:

The correspondence which appeared in the *Times* of January 3d regarding Coopers Hill College has caused a painful shock to all who know of the good work which the college has done in giving to India the benefits of well-trained engineers in the service of its Government. No one can read that correspondence, I believe, without being convinced that the seven professors and teachers whose position is threatened are justified in asking for an inquiry.

The proposed action—a sudden and arbitrary dismissal of able and distinguished scientific teachers who have been doing duty for periods of from nine to thirty years in a satisfactory manner—is certainly not to be expected in institutions under the control of the British Government; and I sincerely hope that the Secretary of State for India in Council will see his way to granting the request for an inquiry.

ANOTHER case, in which the appointment of a military officer without scientific attainments as head of a scientific institution has worked unfortunately, is brought to our attention in the case of M. Charles Lagrange, director of the Royal Observatory of Belgium. It appears from the *Independence Belge*, as quoted in *Na-*

ture, that M. Lagrange has resigned his office and has presented to the Belgian Academy of Sciences his two years' arrears of salary, or a capital sum of ten thousand francs, to establish a prize to be awarded, at intervals of four years, for the best contribution to our knowledge of the physics of the globe. In expressing the thanks of the Academy for the gift, General Brialmont described the circumstances which led to M. Lagrange's resignation. It appears that for the past two years the position of director of the Observatory has been a humiliating one, because a young infantry officer, without scientific attainments, has controlled the establishment.

We are glad to notice that the House of Representatives has, under a suspension of the rules, passed a bill increasing the salary of the Commissioner of Education for Porto Rico from \$3,000 to \$4,000. If, however, our Government is generous in disposing of the money of the Porto Ricans, it should be just in distributing the greater wealth at its disposal, and the eminent Commissioner of Education for the United States should receive as large a salary as the commissioner for Porto Rico.

MR. STARK has introduced into the House of Representatives a resolution of the Legislature of the State of Nebraska, requesting the passage of the bill for the establishment and maintenance of a school of mines in every State where such does not now exist, which has been referred to the Committee on Public Lands.

At a recent meeting of the New England Anti-vivisection Society, Joseph L. Greene quoted from Senator Gallinger, of New Hampshire, to the effect that the bill against cruelty to animals in the district of Columbia would probably not be taken up at the present session, because of the pressure of business.

THE German budget for 1901 includes 200,000 Marks for the construction of a laboratory for hydraulic experiments at Berlin. The total cost of the laboratory will be about 365,000 Marks. It will be used by the administrations of the Imperial Marine and Inland Waterways and by the students of the technical school. The budget also provides for non-recurring ex-

penditures on science and art over 6,000,000 Marks.

GREAT interest is being taken in the imminent drying up of Great Salt Lake caused by irrigation. We are informed that the plan suggested by Mr. Marcus E. Jones to build a canal from the headwaters of the Snake river, and thus bring water into the Great Basin to replace the waste by evaporation is meeting with general favor. The Utah Legislature is expected to take up the matter at this session. The agricultural sections of Utah are threatened with disaster unless something is done soon.

UNDER the auspices of the International Aeronautical Committee balloon ascents for meteorological purposes were made on January 10th—in so far as the program was carried out—at London, Bath, Paris, Strasburg, Berlin, St. Petersburg and in Virginia.

We learn from the *Electrical World* that, at a recent meeting of the Frankfort-on-the-Main Association of Electrical Engineers, Herr Wolff, manager of the local branch of the Allgemeine Elektrizitäts-Gesellschaft, showed a new form of Nerst lamp. The necessary initial heating of this lamp is effected by a spiral of platinum embedded in fireproof composition. By means of a switch concealed within the base of the lamp, this spiral is automatically cut out of circuit after the lamp has been rendered sufficiently conductive by the imparted heat.

#### UNIVERSITY AND EDUCATIONAL NEWS.

YALE UNIVERSITY has received a bequest of \$50,000 by the will of Albert E. Kent of Chicago, a graduate in 1853. The money is to be used for the enlargement of the Kent Chemical Laboratory which Mr. Kent gave to the University twenty years ago. Yale University has also received during the week, by the death of Benjamin Douglas Silliman, the oldest alumnus of the University, a sum, said to be \$80,000, left by a brother in trust. It is expected that the University will also receive a bequest by the will of Mr. Silliman. Yale University would also receive a trust fund of \$500,000, left by T. B. Winthrop, an alumnus, in case neither of his children should survive.

MR. JOHN D. ROCKEFELLER has offered to give \$200,000 to Oberlin College, on condition that \$300,000 in addition be collected during the year.

THE sum of \$25,000 has been collected for Amherst College, making available \$75,000 promised by two alumni, Mr. D. Willis James and Mr. C. M. Platt.

MR. H. H. HUNNEWELL, of Wellesley, has given \$25,000 to Wellesley College for the department of botany.

THE will of the late Joseph Ricker, of Portland, Maine, provides for the distribution of about \$300,000 among charitable, religious and educational societies. Among the bequests are the following: Bowdoin College, \$20,000; Bangor Theological Seminary, \$25,000; Tuskegee Institute, \$2,500, and Bates College, \$10,000.

ON January 1, 1901, President Jas. W. Strong had secured gifts and pledges to the endowment fund of Carleton College amounting to \$100,000. This secured the conditional gift of \$50,000 from Dr. D. K. Pearsons offered a year ago. The college has always given unusual prominence to its scientific courses and has an exceptionally good equipment of scientific apparatus.

A UNIVERSITY for women has been founded in Tokio and is expected to open in 1901. A site and about \$120,000 have been donated to it.

THERE will be a second meeting of the Association of Universities in Chicago from February 26th to 28th. Among the subjects to be discussed are 'Migration among Graduate Students,' 'Examinations for the Doctor's Degree,' 'Fellowships' and 'To what extent should a Candidate for the Doctor's Degree be required to show a Knowledge of Subjects not immediately connected with his Major Subject?'

THE University of California will offer at its next summer session instruction in philosophy, education, history, Latin, Greek, physics, chemistry, botany, mathematics and other departments. A short course for farmers is being planned, in which practical instruction will be given in horticulture, irrigation, dairy husbandry, stock breeding, etc. The following

professors from eastern universities will take part in the work: James E. Russell, dean of the Teachers College of Columbia University; John Dewey, professor of philosophy in the University of Chicago; H. Morse Stephens, professor of modern history in Cornell University; James W. Bright, professor of English philology in Johns Hopkins University; Liberty Hyde Bailey, professor of horticulture in Cornell University; and Albert S. Cooke, professor of the English language in Yale University.

C. E. CHADSEY, Ph.D. (Columbia), has been appointed lecturer in the department of education, University of Colorado. He will lecture on sociological topics, etc. P. H. Keyser, M.D., has been appointed instructor in psychopathology in the department of psychology of the same university. Students in the law school are required to take the course, and it is an elective in the medical school.

DR. WM. G. SPILLER has been appointed demonstrator of neuropathology at the University of Pennsylvania, and will conduct an elective course for a limited number of graduates and students for the study of the pathology of the central nervous system and the preparation and examination of microscopic sections.

JOHN M. BUCHER, Ph.D. (Johns Hopkins), has been appointed associate professor of chemistry at Brown University. He recently graduated at Lehigh University and has been instructor in Tufts College. At the same university Mr. W. B. Jacobs has been appointed professor of the science and art of teaching.

JOSEPH S. CHAMBERLAIN, Ph.D. (Johns Hopkins), instructor in chemistry, Oberlin College, has accepted the position of private assistant to Professor Ira Remsen, Johns Hopkins University.

DR. MAX VERWORN, associate professor and assistant in the Physiological Institute in the University at Jena, has been called to an associate professorship of physiology at Göttingen, where he will be director of the Physiological Institute.

DR. H. GOLDSCHMIDT, associate professor of chemistry at Heidelberg, has been called to the University of Christiania.



# SCIENCE

A WEEKLY JOURNAL DEVOTED TO THE ADVANCEMENT OF SCIENCE, PUBLISHING THE OFFICIAL NOTICES AND PROCEEDINGS OF THE AMERICAN ASSOCIATION FOR THE ADVANCEMENT OF SCIENCE.

EDITORIAL COMMITTEE: S. NEWCOMB, Mathematics; R. S. WOODWARD, Mechanics; E. C. PICKERING, Astronomy; T. C. MENDENHALL, Physics; R. H. THURSTON, Engineering; IRA REMSEN, Chemistry; JOSEPH LE CONTE, Geology; W. M. DAVIS, Physiography; HENRY F. OSBORN, Paleontology; W. K. BROOKS, C. HART MERRIAM, Zoology; S. H. SCUDDER, Entomology; C. E. BESSEY, N. L. BRITTON, Botany; C. S. MINOT, Embryology, Histology; H. P. BOWDITCH, Physiology; J. S. BILLINGS, Hygiene; WILLIAM H. WELCH, Pathology; J. MCKEEN CATTELL, Psychology; J. W. POWELL, Anthropology.

FRIDAY, FEBRUARY 8, 1901.

## CONTENTS:

<i>The Endowment of Research</i> : PROFESSOR EDWARD C. PICKERING.....	201
<i>Research Work for Physics Teachers</i> : PROFESSOR EDWARD L. NICHOLS.....	202
<i>On Eclipse Photography</i> : PROFESSOR FRANCIS E. NIPHER.....	208
<i>The Probable Successors of Certain North American Primates</i> : DR. J. L. WORTMAN.....	209
<i>The American Psychological Association</i> : DR. LIVINGSTON FARRAND.....	211
<i>Iowa Academy of Sciences</i> : PROFESSOR L. H. PAMMEL.....	214
<i>The Nebraska Ornithologists' Union</i> : PROFESSOR ERVIN H. BARBOUR.....	216
<i>The Kansas Academy of Science</i> : PROFESSOR E. H. S. BAILEY.....	217
<i>The Stanley-McCormick Hopi Expeditions</i> : DR. GEORGE A. DORSEY.....	219
<i>Scientific Books</i> :—	
<i>An Atlas of Representative Stellar Spectra</i> : PROFESSOR EDWIN B. FROST. <i>Bureau of Steam Engineering of the U. S. Navy Department</i> : PROFESSOR R. H. THURSTON. <i>Geology of Texas</i> : DR. ROBT. T. HILL. <i>Books of Reference. Books Received</i> .....	222
<i>Scientific Journals and Articles</i> .....	227
<i>Societies and Academies</i> :—	
<i>Science Club of the University of Wisconsin</i> : PROFESSOR WM. H. HOBBS. <i>The Texas Academy of Science</i> : PROFESSOR FREDERIC W. SIMONDS. <i>The Engineering Association of the South</i> : H. M. JONES. <i>The Vermont Botanical Club</i> . 228	
<i>Discussion and Correspondence</i> :—	
<i>A Bibliographic Catch Title for Ever and Ever</i> : F. A. BATHER. <i>A Further Appeal to all Lovers of Birds</i> : ABBOT H. THAYER and OTHERS.....	230
<i>Shorter Articles</i> :—	
<i>The Proper Name of the Alpine Chough and of the Egyptian Crocodile</i> : WILLIAM J. FOX. <i>The Wood Buffalo</i> : DR. OTTO J. KLOTZ.....	232
<i>Current Notes on Meteorology</i> :—	
<i>The 'Boom' Population of Kansas; The Meteorology of Lower California; The Harvard Meteorological Stations in Peru; Recent Publications; Notes</i> .....	233
<i>The United States Naval Observatory in Congress</i> .....	234
<i>Scientific Notes and News</i> .....	236
<i>University and Educational News</i> .....	240

## THE ENDOWMENT OF RESEARCH.

Is investigation in the physical sciences now limited by the lack of men or money? In other words, is it limited by the insufficient number of investigators capable and ready to do work of the highest grade, or are they unable to secure the means needed to carry on such work? The income of several funds is available for aiding such investigation. In 1797, Count Rumford gave to the American Academy the sum of \$5,000, for awarding gold and silver medals for discoveries in light and heat. Until recently, so little use has been made of its income that this fund now amounts to \$58,000. The annual income, which exceeds \$2,500, may be used for researches in light and heat. The Elizabeth Thompson fund, amounting to \$26,000, according to the last circular issued, may be used for investigations in all departments of science. Seventy-one grants have been made from the income of this fund, generally in sums not exceeding \$300. Several funds, held in trust by the National Academy of Sciences, show unexpended balances equal to the income of several years. Thus, at the beginning of the present year, the Henry Draper fund of \$6,000 had an unexpended balance of more than \$2,000 available for investigations in astronomical physics, and no applications had been received for it. In 1886, the writer attempted to secure the sum of \$100,000, the income to be used for

aiding astronomers of all countries in their work. Miss Bruce, in 1890, besides her numerous other gifts to astronomy, gave the sum of \$6,000 to be distributed in this way. The 15 donations are described in a circular issued in 1891. Many investigations require such large sums of money that they could not be provided for by such funds as these. On the other hand, a small sum judiciously expended sometimes leads to much larger gifts, and may furnish an observer with an instrument, an assistant, or means for publication. A small gift may thus render available, resources of vastly greater value which would otherwise lead to no useful result. For instance, the writer in 1882 received an appropriation of \$500 from the Rumford fund, for an investigation in astronomical photography. Presenting the results of this work to the trustees of the Bache fund, he received an appropriation of \$3,000, with which an 8-inch photographic telescope was constructed. Twenty-six thousand photographs have since been taken with this instrument which for many years has been used throughout every clear night at the Arequipa Station of the Harvard College Observatory. The early results were presented to Mrs. Henry Draper, who accordingly had a similar 8-inch telescope constructed. This instrument is used here throughout every clear night, on the northern stars, thus supplementing the work of the Bache telescope. With this instrument, also, 26,000 photographs have been obtained. The early results of the Henry Draper Memorial led to the transfer of the Boyden fund, exceeding \$200,000, to the Harvard College Observatory, and also to the gift of \$50,000 by Miss C. W. Bruce, with which a 24-inch telescope, now successfully at work in Arequipa, was constructed. The results attained by each gift thus helped to secure the next. Again, an appropriation of \$500 from the Rumford fund, in 1899, enabled

the Directors of the Yerkes, Lick, McCormick and Harvard observatories to cooperate, so that telescopes of 40, 36, 26, 15, and 12 inches aperture are now being used in the same research on the light of very faint stars. The value of the plant utilized in this research exceeds a million dollars. It is hoped that similar cooperation can be secured in continuous observations of the variable stars of long period. In many cases an award of a small sum to an observatory will assure its friends of the value of the work and thus encourage them to contribute liberally. It is believed by the writer that the real difficulty lies in the lack of knowledge of what funds are available, diffidence in presenting applications, and in some cases objection to the restrictions under which the grants may be made. Could these difficulties be remedied by a permanent committee, and if so, how should it be appointed? In no country have such sums of money been given to science as in the United States; in fact, the success so far attained and our future prospects for research depend largely upon such gifts. It is believed that in many cases wealthy men and women would gladly aid scientific investigation if they could be sure that their gifts would be judiciously and economically expended. It is, therefore, of the greatest importance to all scientific men, not only to secure aid for important researches, but to prevent, if possible, the unwise or wasteful expenditure of such money. The writer desires to learn the views of others on this matter, either through the columns of SCIENCE, or by personal correspondence.

EDWARD C. PICKERING.

CAMBRIDGE, MASS., January 25, 1901.

---

*RESEARCH WORK FOR PHYSICS TEACHERS.\**

THE teaching of physics is in itself a delightful thing, but to be thoroughly enjoyed

\* An abstract of a paper read before the Physics Club of New York, December, 1900.

it should be plentifully seasoned with research. Science in the past has been indebted in a very great measure for its progress to the teaching class. An inquiry into the statistics of this subject, which I had occasion to make some years ago, and in which I attempted to classify the professions of all the authors up to the middle of the present century, who are sufficiently known to have found a place in the pages of Poggendorff's Dictionary, showed that nearly 90 per cent. of the scientific work of the world had been done by teachers. The remainder was divided almost equally between the members of the medical profession and the clergy. Law was found to be almost entirely unrepresented, the most notable instance of a lawyer who has left a name in science being that of Bacon. There has been of course a considerable number of amateurs in science, and the list contains some famous names, such, in physics, for examples, as Joule in England, and Holtz, Elster and Geitel in Germany; but taken numerically this class shows a very small percentage in the tables. Great as the attainments of the teacher in investigation have been when compared with those of the remainder of the community, the statistics show that in this country at least not more than ten per cent. even of college men engaged in the teaching of physics can be counted as belonging to the ranks of the producers. I have been unable to extend the inquiry to physics teachers in secondary schools, not through any difficulty in enumerating those whose names appear in scientific authorship, but through ignorance as to the total number who are engaged in teaching the subject in the United States. It is clear, however, that the ratio would be even smaller than in the case of those who are teaching in our colleges and universities.

That there are very great and very real difficulties any one who has attempted to

carry on research and teaching at the same time must admit. The principal excuses offered for the abandonment of any attempt at scientific performance are *lack of time*, *lack of apparatus* and *lack of the necessary qualifications for the work*. A comparison of college teachers with the teachers in the secondary schools in these respects has led me to the opinion that the differences of opportunity are much smaller than is commonly supposed. Science teachers, both in the college and in the school, are unquestionably overworked. The tax upon the nervous system of the proper teaching of science is very great, and it is more often the want of surplus energy with which to carry on investigation, than lack of actual time or of the necessary equipment that defeats us. The actual number of hours demanded of teachers is small as compared with that required by many other callings; so much so, that by the outsider the teacher is apt to be regarded as belonging to the leisure class; but measured in terms of vital energy those hours, as we all know, are quite long enough.

The plea of lack of qualification for research is one which the college man feels less free to make than does the teacher in the secondary schools; because he knows that whether he has such qualifications or not he is at least supposed to possess them; whereas it has not yet been demanded of secondary school teachers that they should be capable of actual scientific productiveness. This difference of standard I believe is a false one and most unfortunate; for it is certainly more difficult to teach successfully the beginnings of a subject than to conduct advanced work. The real explanation of the comparative unproductiveness of secondary school teachers lies, I am convinced, in the absence of *the habit of investigation*, a habit which like all others must be acquired by practise and maintained by continued practise. Research flourishes

only in a certain atmosphere, and this atmosphere is to be found only where scientific work is going on. Some little corner of time can always be found even by some of the most overburdened of us, and as to equipment, it should not be forgotten that the scientific appliances at command of the school teacher of the present day are greatly superior to those of the average college man of a generation ago, and are not greatly behind those of the average college man of the present. Yet there was great scientific activity in certain localities at a time when laboratories, as we know them, had not yet come into existence. Men are still living who can remember when the first chemical laboratory in Germauy was established by Liebig, and one need not be very old to look back upon the beginnings of laboratory instruction in this country.

Qualification for research must always be acquired by individual effort. Any one who is really fit to teach science has at least the latent gift necessary to the investigator. To develop the gift he must, however, cultivate the habit of scientific reading and the habit of experimentation. The number of science journals is now so great that no one can longer pretend to read them all; but we have in the admirable summary entitled, *Science Abstracts*, and in *Wiedemann's Beiblätter*, the results of the whole world of physics presented in brief form. One of these two journals should be taken by every physics teacher, and in addition he should subscribe to and read some one of the standard journals devoted to his subject.

Given a well-developed habit of experimentation, it only remains to select some topic and to study that persistently to the point of obtaining definite results before taking up another. All subjects for investigation are not equally within the reach of the teacher in the secondary schools. We can not, for example, expect to duplicate in our laboratories the thousands of

storage cells necessary to the carrying on of the researches upon which Professor Trowbridge, of Harvard University, is engaged, nor to lay out large sums for apparatus of any other kind. As a rule, the apparatus necessary to an investigation is, however, not very expensive; certain standard instruments, such as the balance, the thermometer, the spectroscope and the galvanometer, are to be found in every decently equipped school at the present day, and work of the highest interest can be done by supplementing these with special apparatus which may be either home-made or may be obtained at a small cost by employing our ordinary artisans.

The following suggestions of topics for research which may be pursued without elaborate or unusual apparatus in the spare time of any one who possesses the intense love of experimentation, characteristic of the true man of science, may serve to show that there is no lack of material within the reach of every ambitious physics teacher.

The temperature at which pure water reaches its maximum density has been carefully determined, and it is known that the introduction of a gas such as ammonia, which is largely absorbed by water, or of a salt in solution like sodium chloride, or of alcohol or sulphuric acid, not only lowers the freezing point and changes the density of the liquid, but that the point of maximum density falls, as the amount of added substance is increased, more rapidly than the freezing point itself; until finally the phenomenon of maximum density disappears altogether. Any one who possesses a good thermometer reading to low temperatures or who has sufficient skill and experience to make and calibrate a thermo-junction can readily extend this investigation to solutions and mixtures not yet studied. The only instruments required for such investigation, aside from the usual laboratory utensils, are a good thermometer and a

Fahrenheit hydrometer, or a hydrometer of the variable immersion type with the diameter of the neck reduced to the least practicable size. The work is of sufficient delicacy to tax the manipulative skill of the observer, and the investigation is on this account worth the doing simply as practise work, while the results of a careful study of the subject would be welcomed by any of our standard journals of physics. By a similar method, studies may be made of the density and coefficient of expansion of liquids having low freezing points, such as alcohol, ether and carbon disulphide. Something has been done in this line, but the subject is far from being exhausted. By the use of liquid carbon dioxide and ether one can readily reach the temperature  $-80^{\circ}$  C., and it is probable that the time is near when liquid air will be available for the extension of such work to much lower temperatures. Data upon subjects such as these are useful even though no startlingly new phenomena be brought to light, and the observer has before him the possibility of discovering new and important relations which may have a bearing upon our theories of the nature of matter. The verification through this extended range of temperatures, viz., from  $-80^{\circ}$ , and ultimately from  $-200^{\circ}$ , upwards, the law already theoretically established by Van der Waals\* for the relation of the expansion of liquids to their critical temperatures; or, failing in that, the experimental demonstration of the necessity of a modification of the theory, would be in itself ample incentive for the investigation.

The subject of specific heats at low temperatures is still awaiting the attention of our experimental physicists. H. F. Weber † a quarter of a century ago studied boron

and silicon, in this respect, down to  $-40^{\circ}$  C. and carbon to  $-50^{\circ}$  C., with most interesting results, after which comparatively little was done until 1898, when Behn\* obtained values for several metals down to  $-200^{\circ}$ . The specific heat of a great variety of solids and liquids still remains to be determined through the greater range of temperatures now within our reach, and the calorimetric observations are no more difficult nor elaborate at low than at high temperatures. Any one who can set up and calibrate a Bunsen ice calorimeter is in position to make the measurements. A cylinder of carbon dioxide and a can of ether will give refrigeration to  $-80^{\circ}$  C. and perhaps by the time the work for this range of temperatures is completed it may be possible to order a gallon of liquid air by telephone at a reasonable cost and thus readily extend the research to  $-200^{\circ}$  C. Temperature measurements are best made in such work by finding the change of resistance in a coil of fine copper wire.

What I have attempted to point out, in a fragmentary way in the case of two or three particular problems is true of the whole domain of physics. No research is ever complete. However exhaustive it may at first sight appear, it will, when critically considered, be found to afford merely a starting point from which to push further out into the infinite region of the unknown which lies beyond the boundaries of our present knowledge. Every theoretical discussion is based upon assumptions which must be tested experimentally, and such tests usually lead to new and more accurate knowledge of the properties of matter and ultimately to modifications of the theory. Thus Poisson, long since, pointed out that the numerical value of the ratio for the relative contraction of the diameter of a stretched rod to the elongation would be one-fourth for all substances for which the assumption

\* Van der Waals, 'Continuität des gasförmigen und flüssigen Zustandes.' Leipzig, 1881.

† H. F. Weber, *Poggendorff's Annalen*, 154, pp. 367 (1875).

\* Behn, *Wiedemann's Annalen*, 66, pp. 237 (1898).

made in his theory of elasticity holds true. Measurements, however, showed widely varying values for Poisson's ratio and led to important modifications of the theory. All this may be thought to belong to the ancient history of the science, but to-day, after nearly half a century, exact data are known for only a few substances. I do not mention this as one of the determinations especially adapted to the secondary school laboratory. The quantity to be observed is, of course, exceedingly small. Still the method by which I am accustomed to illustrate the phenomenon to my classes; that of stretching a glass tube filled with mercury and noting the fall of the liquid in the very fine capillary neck gives a good result with glass, and would probably be adaptable without serious difficulties to such other materials as can be obtained in the form of tubes. With the interferometer, direct measurements of the change of diameter ought to be readily made but this instrument is at present not a part of our school equipments.

Another field of work which is easily opened to physics teachers in our secondary schools is that of the study of flame temperatures. The temperatures of the Bunsen burner, the ordinary luminous gas flame, the candle flame and the acetylene flame are already pretty well established, although many important details which are capable of being worked out by a patient observer are still lacking. When it comes to the question of other flames than these, we have only the wildest estimates based upon measurements made by methods, the inadequacy of which has been abundantly demonstrated. The flames of alcohol, of ether and of carbon disulphide burning in air would afford subjects for an interesting and profitable study during one's leisure hours. The apparatus needed for such a research consists of a fairly sensitive galvanometer, a resistance box and a standard

cell, together with about one meter each of platinum and platinum-rhodium wire. The obstacles to even approximately accurate high temperature work have until recently been almost insuperable on account of the difficulty of calibrating the thermo-element used; but I have shown in a recent paper\* how the very elaborate and laborious methods of calibration hitherto employed by those engaged in such work may be avoided without loss of accuracy and how by the ingenious method first employed by Waggener† in the study of the Bunsen burner, and subsequently by myself for the measurement of the acetylene flame, the heat losses in the thermo-junction which had vitiated the results of earlier observers may be eliminated.

We physics teachers have amused ourselves at one time or another, like many other people, with photography, and a few of us, doubtless, deserve to be classed as experts in the fascinating art. Herein lies a double opportunity for research; in the further development of the science which underlies photographic processes and in the application of the photographic method to the numerous problems in physics to which it is especially adapted. Consider, for example, in illustration of the former, the fruitful field of inquiry suggested by Professor Nipher's‡ recent memoir upon the action of light and of the X-rays on previously exposed plates, and of the latter the countless investigations of recent years in which the photographic plate has been utilized for recording and studying the phenomena of our science.

By means of a camera containing a revolving drum, upon which a piece of the flexible film used in the making of ani-

\* Nichols, *Physical Review*, Vol. X., p. 324.

† Waggener, *Wiedemann's Annalen*, Vol. LVIII., p. 579.

‡ Nipher, *Transactions of the St. Louis Academy of Sciences* (1900).

ated pictures may be mounted, a great variety of interesting work may be performed. Professor Merritt\* and I have shown in a recent paper that very beautiful photographs of the manometric flame are obtainable with the aid of such an instrument, and Professor Hallock has made use of a similar method in an extended analysis of the human voice. Any one who has the patience to systematically study and interpret records of this sort, might add greatly to our knowledge of the physics of articulate speech. With the same instrument the motions of vibrating strings and rods and the decadence of overtones with the time may be studied. The instrument is, indeed, applicable to a very great variety of short-time phenomena, such, for example as the duration of exposure obtained by various flash powders, a subject of which at present our knowledge is very incomplete.

Still another interesting line of work within the reach of physics teachers in our secondary schools consists of the photography of the infra-red spectrum. Becquerel showed many years ago that the fluorescence of calcium sulphide and other substances could be checked and almost annihilated by the long waves of the spectrum, and Fomm, a student of von Lommel, in 1890 succeeded in photographing the infra-red spectrum of the sun by placing a fluorescent screen in the spectral image and subsequently making a contact print by laying the screen face to face with an ordinary sensitive dry plate. In this way he was able to identify and determine the wave lengths of numerous dark lines in the spectrum. The absorption spectra of chlorophyll, of water, of the salts of didymium, samarium, erbium and of other substances which possess well-marked bands in the visible spectrum, have been mapped in this way by Becquerel, but his work should be

repeated since his estimation of wave-lengths is known to be entirely at fault. The number of substances as yet untested is very great and the accurate investigation of them might lead to results of high importance. The method of direct photography by means of plates sensitized for the infra-red is probably to be preferred for such work, to the troublesome use of the fluorescent screen.

Finally, not to extend this list of feasible experiments further, permit me to remind my fellow teachers of physics that we have in the spectro-photometer, an instrument by means of which one may investigate visible radiation, reflecting power and the transmission of light, by all sorts of substances. It is a great convenience in such work to have at hand the very perfect modern instruments designed by Lummer and Brodhun or by Brace. I am aware that none of our school laboratories are likely to contain such apparatus; but it is only necessary to purchase a Vierordt slit and to adapt the same to any good ordinary spectroscope in order to be in position to do good spectro-photometric work.

I have attempted in this paper to mention only a few of the numerous topics of research available for physics teachers. It is one of the characteristics of our science, that every contribution to our knowledge brings with it a group of further problems to be solved. One can not read intelligently any memoir describing experimental work without perceiving the possibility of extending the investigation further. The one essential requisite to the carrying out of the suggestions thus received is that burning desire to try things for one's self which characterizes the investigator. Such a desire is the fruit of that habit of experimentation to which I have already referred, a habit which I deem it the first duty of every one, who has the ambition to lay claim to the title of man of science, to foster and

\* Nichols and Merritt, *Physical Review*, Vol. VII., p. 93.

cultivate. Given this desire for research, which is the inevitable result of the habit of experimentation in every one whose mind is fit for scientific pursuits, and all other difficulties, those of time, opportunity and equipment can be overcome. Certain lines of investigation which one would gladly follow must indeed be abandoned for lack of means with which to pursue them; but he who keeps alive his knowledge of scientific progress by the systematic reading of the literature of first sources need never lack topics of research.

The proper stimulus for scientific work is the love of experimentation for its own sake rather than any desire or expectation of fame; the delight of witnessing the wonderful performances of matter under conditions conceived and imposed by ourselves, rather than the hope of achieving some momentous result. At the same time we should not forget that the very simplest phenomenon of nature is worthy of our closest, even of our reverent attention and that some experiment as seemingly unimportant as the shooting of quartz fibers, may, like that now famous operation of a fellow teacher (Boys), be ultimately of inestimable value to science.

EDWARD L. NICHOLS.

PHYSICAL LABORATORY OF  
CORNELL UNIVERSITY.

---

ON ECLIPSE PHOTOGRAPHY.

SOME months ago the writer suggested that the dangers of over-exposure in photographing eclipses might be avoided by a long exposure covering the entire totality of the eclipse, and a development of the plate as a positive in the light. Since that time the interval of exposure in the camera has been considerably reduced by increasing the illumination of the plate while in the developing bath. Plates can with proper exposure be developed in direct sunlight, with a reflected beam of sunlight also

thrown down upon the plate. But while such pictures leave nothing to be desired for clearness and sharpness of detail, they do not show any details which can not be brought out in a negative. Moreover, the exposure required to produce a good positive is still rather too long to make this method in its present condition seem of much advantage in eclipse work.

But it has also been found that the developer best suited to producing fine positives will develop beautiful negatives in the dark-room, on plates that have been over-exposed as much as two thousand times. Such plates thus exposed may be developed either as negatives in a perfectly dark room, or as equally good positives in a light room, and with the same developer. Where the normal camera time is a tenth of a second, the exposure may be as great as three minutes and a half, and still secure a sharp crisp negative. With greater exposures it is better to develop the plate as a positive in the light room.

The developer recommended, as the best so far tried, is hydrochinone made up according to Cramer's formula, with the bromide left out. The sodium carbonate solution may be made up at half the strength given in the formula if the developing is to go on slowly. To half an ounce of the mixture of solutions one and two, add an ounce and a half of water and four or five drops of saturated hypo solution.

When the plate has been normally exposed and it is treated with this developer containing two drops of hypo, in a covered tray in the dark room, nothing will develop for 30 or 40 minutes. But in course of an hour and a half the picture will be fully developed. The details will show sharply through the film. The tray should be uncovered as little as possible. The plate is sensitive even to red light. Until the last stages of development are reached, the exposures for examination of the plate



should be as infrequent and as brief as possible.

A Cramer 'crown' plate placed in a printing frame under a thin or fast printing positive, will yield a negative picture when held for one second at a distance of three meters from a 16-candle incandescent lamp. The exposure may be gradually increased to an exposure of an hour at a distance of one meter from a 300-candle Packard incandescent lamp. How much longer the exposure may be is not yet known. All exposures up to three and a half minutes at a distance of one meter from the 300-candle lamp can be developed as fine negatives in the dark room. This last exposure may also be developed as a positive in light somewhat feebler than direct midwinter sunlight in St. Louis. With greater exposures, the illumination of the light room must be decreased, in order to obtain the best results. With the highest exposures producing developable results, the plate must be developed in the dark room.

The actinic values over this vast range are now being measured. The plates as developed are laid in proper position upon a series of large tables, about 40 feet in length. The coordinate values determining the position of the plate upon the tables are, exposure and illumination of the developing room.

The point which it is desired to urge in this communication is, that in the coming eclipses of this year and next, there is no need of losing any plates from over-exposure, even if they are exposed during the entire time of totality. It is hoped that this communication will cause those who are to take part in that work to lose no time in becoming familiar with the possibilities of development in a bath such as has been here described.

This communication has been prematurely published in order to direct the attention of those who are to take part in the

observations of the next eclipse to a matter which may have great importance. It may be that some of the statements may require modification. For example, it is perhaps questionable whether exposure in a printing frame at a distance of a meter from a 300-candle lamp for three and a half minutes is an over-exposure of 2,000 times.\* It is certainly a very great over-exposure.

FRANCIS E. NIPHER.

WASHINGTON UNIVERSITY.

THE PROBABLE SUCCESSORS OF CERTAIN  
NORTH AMERICAN PRIMATES.

THE credit for the discovery of the affinities of the fossil Primates of the Eocene deposits of this country have been variously claimed by both Marsh and Cope. Leidy, however, appears to have clearly preceded both these investigators in this respect in his 'Vertebrate Fauna of the Territories,' published in 1873. In this work, in describing the lower jaw of *Northarctus tenebrosus*, a fossil monkey from the Bridger Eocene, he makes the following significant remarks: "In many respects the lower jaw of *Northarctus* resembles that of some of the existing American monkeys quite as much as it does that of any of the living pachyderms. *Northarctus* agrees with most

\*Since writing the above it has been found that potassium bromide will do all that has been done with hypo as above described. The earlier failures in the use of bromide were due to insufficient quantity. In developing some good pictures near the zero condition a ten-per-cent. solution of bromide has formed a sixth of the bath. The bromide pictures are somewhat more brilliant, but do not seem so sharp and hard as some obtained by hypo. It may safely be stated that any camera exposure, from the shortest possible, to those lasting for hours, may be developed into a good picture. When the exposure is too great for development in the dark room as negatives, the plate may be as successfully treated in the light room and developed as a positive. A plate which will develop as a beautiful positive in the light of a 16-candle lamp, will develop a foggy mongrel picture, partly positive and partly negative in a perfectly dark room.

of the American monkeys in the union of the rami of the jaw at the symphysis, in the small size of the condyle, in the crowded condition of the teeth, and in the number of the incisors, canines and true molars which are also nearly alike in constitution. *Northarctus* possesses one more premolar and the others have a pair of fangs. The resemblance is so close that but little change would be necessary to evolve from the jaw and teeth of *Northarctus* that of a modern monkey. The same condition which would lead to the suppression of the first premolar, in continuance would reduce the fangs of the other premolars to a single one. This change with a concomitant shortening and increase in the depth of the jaw would give the characters of a living *Cebus*."

In studying the rich collections of this Primate material in the Yale Museum, I have been forcibly struck with the accuracy and wisdom of Leidy's comparison. Not only does it appear to me that there is a decided resemblance between these extinct North American forms and the living South American Cebidæ, but I am firmly of the opinion that the one was the direct descendant of the other. This proposition I find is sustained by a number of trenchant osteological facts which I hope to fully elucidate in my forthcoming publication on the subject.

While they may in general be said to be in a corresponding stage of evolution to that of the living Lemurs, they nevertheless belong to a separate and distinct phylum. This phylum detached itself from the main Primate stem far back in early Tertiary time. When the tropical forests receded to the southward of the land bridge which connected Asia with North America during practically the whole of the Tertiary, the interchange of species which were dependent upon this tropical vegetation was no longer possible, and at this point began the development of the two phyla, one of which

terminated in the Old World monkeys and man and the other the flat-nosed monkeys of the New World.

In the earlier half of the Middle Eocene or Wasatch these monkeys were abundant in northern Wyoming. During the deposition of the Bridger beds or first stage of the Upper Eocene, we find them in southern Wyoming, where they may be said to have reached their culmination, so far, at least, as numbers and variety are concerned. We are at liberty to infer from much collateral evidence that this region was at that time intensely tropical and was highly suited to their manner of life, since some of the more common species are represented by remains of thousands of individuals in the collections. Towards the close of the Bridger, however, premonitions of the coming changes began to make themselves felt, probably first in the altered character of the vegetation. These were of such a nature as to cause another retreat to the southward, which must have been more rapid, since in the succeeding Unita or uppermost Eocene stage we find but a few stragglers of the hardier and more abundant species left behind. Such, however, soon disappear, and with this record, so far, at least, as our knowledge at present extends, their history on the North American continent closes. It is a highly significant fact that in the succeeding Oligocene and Miocene deposits the remains of monkeys are wholly absent, in the northern latitudes, at least, where they were formerly so abundant. The only conclusion we can draw from this is that the tropical vegetation had receded to the south, and taken with it all the inhabitants dependent upon it.

We next hear of these Primates in the Miocene beds of Patagonia, showing clearly that they had not only reached the South American continent at that time in their southward peregrinations, but that they had spread themselves quite to its extreme south-

ernmost limits. This fact argues strongly for a pre-Miocene land bridge between North and South America, just as the North American ancestry of the Edentata, as I have already pointed out, calls for a similar explanation. Had the conditions been favorable, and the southern barriers been sufficient to arrest further progress, we could believe that through stress of environment a much higher type of monkey, and possibly a man, might have been evolved in the Western Hemisphere in the manner so ingeniously suggested by Duncan. But as it is the Cebidæ represent the highest expression of Simian development which has ever been attained on this continent.

J. L. WORTMAN.

YALE UNIVERSITY MUSEUM,  
January 23, 1901.

#### AMERICAN PSYCHOLOGICAL ASSOCIATION.

THE ninth annual meeting of the Association was held in Baltimore, December 27 and 28, 1900, in affiliation with the American Society of Naturalists. The President of the Association, Professor Joseph Jastrow, was in the chair, and on the afternoon of the 27th delivered the presidential address. At the business meeting held the same afternoon, Professor Josiah Royce was elected President of the Association for the ensuing year, and Professors J. Mark Baldwin and John Dewey were elected members of the Council for terms of three years. Several matters of interest were discussed at the business meeting. An invitation from President Harper to hold the next annual meeting at the University of Chicago was received and after full discussion it was voted unanimously that the invitation be accepted, power being given to the Council to arrange for the meeting.

A committee of five was appointed to consider the question of undertaking in part the publication of Dr. J. H. Leuba's proposed catalogue of psychological litera-

ture and to report at the next meeting of the Association.

A resolution was adopted that the Committees of Arrangements of Foreign Congresses of Psychology be requested to confer with the American Psychological Association with regard to the American representation at such congresses and the participation of American members in their proceedings.

Sessions for the reading of papers were held on the morning of the 27th and on both the morning and the afternoon of the 28th.

Professor Jastrow's presidential address was upon 'Currents and Undercurrents in Psychology.\*' The speaker took up in turn various aspects of modern psychology. After discussing the significance of the evolutionary conception of the science, he spoke of the three-fold mode of approach, viz., the genetic, the normal and the abnormal, to many of its problems as being productive of interesting and valuable advance, and outlined the advantages and limitations of each aspect. The contemporary interest in certain functional complexes, notably reading and writing was noticed and the whole question of the practical bearing of psychology was discussed, the speaker assuming a conservative position in the matter.

At the first session on Thursday morning, Mr. Robert M. Yerkes, of Harvard, read a paper on 'Habit Formation and Memory in Invertebrates and Lower Vertebrates.' This was a preliminary report of some experimental studies in animal psychology now being conducted in the Harvard Laboratory. The chief purposes of the work are (1) to determine to what extent, with what rapidity, and precisely how, animals learn; (2) to test the permanency of any associations formed and (3) to make as many supplementary observations on the

\* Published in full in the *Psychological Review* for January, 1901.

general habits and reactions of the animals used as possible. The labyrinth method, in various forms, has been used for all the work. Observations have thus far been made on the crayfish, green crab, fiddler crab, newt, frog and turtle. Crayfish in a simple labyrinth, involving choice of direction only once, improve rapidly from fifty per cent. correct in the first ten trials to ninety per cent. correct in the sixth ten. There is evidence of the habit (*i. e.*, memory) after two weeks' rest. Newts, judging from these studies, learn very slowly and there is successive variability among individuals. Frogs alone, of the animals named, have shown the formation of a habit as the result of a single experience. Turtles are very apt in the formation of labyrinth habits, and retain them for weeks. They give a curve of learning very similar to those of the cat and dog. In all the experiments record is kept of the time taken to escape from the labyrinth and of the course followed.

This paper was succeeded by one by Dr. Shepherd Ivory Franz, of the Harvard Medical School on 'Frontal Lobes and Association.' The experiments were undertaken to determine whether or not the frontal lobes in animals are concerned in the production of certain sensory-motor associations. Cats were given the opportunity of learning simple habits, after the learning of which the frontal area anterior to the crucial sulcus was excised. After the operation the habits previously learned were lost. A series of control experiments shows that this result cannot be accounted for on the supposition of surgical shock. The conclusion was drawn that the frontal lobes are normally concerned in the formation of these habits. The animals that had thus acquired and lost certain associations were found to have the ability for re-learning these habits and for acquiring new ones. This ability (re-learning) may be due to the

use of other association areas (either the parietal or the occipito-temporal lobes), but the evidence is not yet complete.

Dr. R. S. Woodworth and Dr. E. L. Thorndike reported the results of the continuation of their experiments on 'The Influence of Special Training on General Ability.' The following conclusions seem to them justifiable:

The mind is, on its dynamic side a machine for making particular reactions to particular situations. It works in great detail, adapting itself to the special data of which it has had experience. Change in the time or precision or quality of any one of these particular reactions need not and often does not influence appreciably other reactions, similar enough to be called by the same name. Change in any one almost never brings about an equal change in any other reaction, no matter how similar, for the working of every mental function is conditioned by the nature of the data on which the function is employed. The amount of influence of changes in any one mental function upon others is much less than has been supposed. The cases of such influence and of its absence make it seem probable that change in one function affects others only where and in so far as identical elements are present in both. By identical elements are meant concrete elements, such as sensations, images, movements, etc., the actual content of which is identical.

Professor J. McK. Cattell reported on 'Psychological Tests of Abnormal and Exceptional Individuals.' Attention was called to the desirability of extending physical and mental tests to those suffering from disabilities and disease on the one hand, and to those showing exceptional aptitudes on the other. A description was given of cases of nervous disease tested by the speaker, and it was shown how these differed from normal individuals and how far the nature and

progress of the disease could be deduced from such tests. Turning to an exceptional case, similar tests made on the chess player, Mr. Pillsbury, were described. The speaker also noted the correlation of the tests made on the freshmen and seniors of Columbia College, mentioned tests made on the cleverest and dullest children in a primary and in a high school, and described a photographic method of measuring the features.

The last paper of the morning, by Professor E. F. Buchner, on 'Volition and Experiment,' was read by title.

On Friday morning Professor Edward A. Pace presented 'A Note on Binocular Rivalry.' The purpose of the experiments was to determine whether the fluctuation of retinal fields is influenced by such mental factors as expectation and recognition. It was found that when the fields (colored squares or figures) are presented in succession, the new field dominates in consciousness. The mere fact that one field is familiar and the other strange does not affect the result. Efforts of the will to retain a field when a new stimulus is applied to the other retina are not at first successful. By repetition, however, control is gradually acquired, so that, in proportion as the novelty of the intruding field wears off, inhibition becomes easier.

Professor Charles H. Judd followed with a paper, 'The Analysis of Writing Movements.' The method consists in attaching a tracer to the hand in such a way that it will not be affected by the fingers, but will record any movement of the hand as a whole. If one writes with such a tracer attached to the hand, the written letters will contain the finger components as well as hand and arm movements, while the tracer record will not contain the finger components. Apparatus and records were exhibited to illustrate the method. It is found that the hand and arm do not participate in the finer formative parts of the writing movement,

but merely carry the fingers forward, thus contributing the grosser elements, especially those in a forward direction. Marked differences appear in the modes of coordination employed by different individuals.

Professor J. A. Bergström demonstrated an ergograph and reported studies made with the instrument.

Dr. Arthur MacDonal spoke on the susceptibility to disease and physical development in college women, the data on which his statistics were based having been furnished by the professor of physical culture and the resident physician in one of our woman's colleges.

Dr. E. W. Scripture described further experiments on rhythm made in the Yale Laboratory and Professor E. C. Sanford spoke briefly of some new apparatus.

In the Philosophical Section of the Association, which held meetings both in the morning and in the afternoon of Friday, Mr. Henry Rutgers Marshall spoke on 'Self-consciousness and its Physical Correlate.' If each special mental state in a given individual corresponds with a differentiation of process in that individual's nervous system, then 'self-consciousness' must have coincident with it some special form of neural activity. The neural process in man is the activity of an enormously complex neural system which itself is made up of minor neural systems: consciousness then, under this hypothesis, must be looked upon as a vast psychic system made up of minor psychic systems. System as a whole, any increment of activity in any minor system will stand in contrast with the mass of activity of the complex system as a whole. The most ordinary presentations to the Self correspond with such special increments of neural activity; hence we are led to ask whether the Self may not be that part of consciousness which corresponds with the mass of psychic activity in the complex neural system as a whole.

Mrs. Christine Ladd Franklin read a paper on the 'Reduction to Absurdity of the Ordinary Treatment of the Syllogism,' which will be published in *SCIENCE*. Other papers in the philosophical section were 'The Kantian Doctrine of Space,' by Professor George S. Fullerton; 'Nietzsche,' by Professor Grace Neal Dolson; 'Professor Ladd's Theory of Reality,' by Professor William Caldwell; 'The Doctrine of the Two-fold Truth,' by Professor F. C. French; 'A Study of Pluralism,' by Professor A. H. Lloyd; 'The Problem of an Emotional Logic,' by Professor W. M. Urban; 'Examination of Professor Sidgwick's Proof of Utilitarianism,' by Dr. Ernest Albee; 'A Peripatetic Formula for the Moral Ideal,' by Professor W. R. Newbold; 'Active and Passive Reason in the Writings of Aristotle,' by Professor W. A. Hammond. The last named paper was read by title.

LIVINGSTON FARRAND.

COLUMBIA UNIVERSITY.

*IOWA ACADEMY OF SCIENCES.*

THE fifteenth annual meeting of the Academy met in Des Moines, Iowa, on December 26, 27, 28, 1900. A lengthy and an excellent program was carried out. The annual semi-popular lecture was given by Dr. Wm. Trelease, of the Missouri Botanical Garden, on the 'Harriman Alaska Expedition' on Thursday evening to a large and highly appreciative audience. The president, Professor W. H. Norton, delivered his presidential address on the 'Social Service of Science' on Wednesday evening. Professor Norton sketched briefly the service of science to society. This service is not appreciated as it should be, and yet nearly every modern convenience in the industrial world had its origin in the discovery of some scientific truth by some scientist, as in medicine, physics, electricity and mechanics.

Geological papers were presented by Dr.

Charles R. Keyes on 'Depositional Equivalent of Hiatus at Base of our Coal Measures'; and the 'Arkansan Series,' a new terrane of the carboniferous in the western interior basin. The present Arkansas valley, however, has probably been formed entirely since Tertiary times, and by a system of drainage in no way dependent upon the carboniferous drainage. Where the great uplift of Missouri and Arkansas over the northern part—embraced by the so-called Ozark isle—and the southern part composing the Ouchita mountains were made up of resistant limestones, these yielded less quickly to erosion than the central soft shales; and the Arkansas river, which happened in old peneplain to traverse the central part of the uplifted area, was able to cut its way down as fast as the region rose, and was thus able to maintain its old course. In his paper on 'Names of Coals West of the Mississippi River' he indicated the stratigraphical units of the carboniferous in the western interior coal fields—the terranes of the Missourian, Des Moines and Arkansan being given. In a paper on the volcanic necks of Piatigorsk, Southern Russia, he briefly described the highest peak in Europe, Mt. Elburz, which is 18,526 feet above the level of the sea. Mr. T. E. Savage briefly gave an account of the 'pre-Kansan Drift Exposure in Tama County, Iowa.' His conclusions were based on the buried soil, in which organic matter was found, leaching, and an oxidized zone. Professor Shimek made a comparison of the loess and modern 'Molluscan Fauna of Iowa City and Vicinity.' A large number of the species enumerated are aquatic.

Of chemical papers, Professor Nicholas Knight, on 'Some Recent Analyses of Iowa Building Stones,' stated that the chemical composition varied from nearly typical dolomite to admixtures in different proportions of calcium carbonate and dolomite. In his paper on 'Potable Waters' chemical an-

alyses were recorded for deep wells in Mount Vernon as well as analyses from the Cedar river. The wells were all more than 100 feet deep, the albuminoid ammonia running as high as .088, free ammonia .084, nitrates 1.38; the latter amount of nitrates was found in an artesian well which supplies the city of Mount Vernon and is 330 feet deep.

Dr. J. B. Weems and Mr. J. C. Brown presented a paper on 'The Influence of Chlorin as Chlorid in the Determination of Oxygen consumed in Water Analysis.' In this paper attention was called to the large amount of chlorin as chlorids in the deep well waters of the State. Naturally in the determination of the oxygen consumed in these waters there is a question of interest as to the effect of the chlorids in the potassium permanganate solution. The effect of chlorin in the form of sodium chlorid, in amounts from 5 parts to 1,800 parts per million of water, was investigated, using the Kubel, Schultz, Tidy or English, and the Association methods.

Another paper by the same authors considered the chemical investigation of a well which was the probable cause of an epidemic of typhoid fever.

Dr. J. B. Weems and Mr. H. N. Grettenberg presented a paper on 'A Study of Some Cotton-seed Oils' in which the analytical results of nine samples of cotton-seed oils were given and the results compared with the usual standards for oils of this class. Professor Alfred N. Cook discussed the 'Diphenyl Ether Derivatives,' being a summary of our present knowledge of the subject, as well as some original work on the diphenyl ether derivatives.

Zoological papers were presented as follows: Professor H. M. Kelly, 'Notes on the Time of Sexual Maturity in Certain Unios.' He believes that the period of sexual maturity does not always recur every year. Professor H. W. Norris in a paper on a

'Combination of Chromic Acid, Acetic Acid and Formalin as a Fixative for Animal Tissue,' gave excellent results for fixing mammalian tissues—in some tissues better results than he has been able to obtain with any other fixing fluid; it is especially good for glands and mucous epithelium. It is not satisfactory for nervous tissue. In his paper on the 'Morphology and Function of the Amphibian Ear,' Professor Norris stated that in this transition class of vertebrates, the Amphibia, the organ of hearing originated from an organ of equilibration which latter function is always retained. Professor H. E. Summers presented a paper on the 'Generic Synopsis of the Nearctic Scutelleridæ and Cydnidæ.' Professor E. D. Ball presented a monograph on 'A Review of the Tettigonidæ of North America North of Mexico.' Of the 500 or more described species the great majority are found in the region between Mexico and Brazil. Seven genera are represented in America north of Mexico.

Bacteriological papers were presented as follows: C. H. Eckles, 'A Comparison of Media for the Quantitative Estimation of Bacteria.' It was noted that ordinary peptone agar is not suitable for the development of a large number of bacteria, especially the lactic acid species. Both lactose gelatine and lactose agar gave much better results than either peptone agar or peptone gelatine. L. Russell Walker, in a paper on 'Sewage Disposal,' with special reference to the number of bacteria found in the sewage and effluent of the Iowa State College sewage plant from September 1, 1899, to September 1, 1900, stated that it was found that the percentage of gas-producing bacteria was greatest in the manhole and least in the effluent, while the number in the tank lies between. L. H. Pammel, in 'Notes on the Bacteriological Analysis of Water,' gave the results of an examination of the water supply of the Iowa State Col-

lege as well as other wells in the vicinity of Ames, and especially the wells that were supposed to have conveyed typhoid fever to the students of the college. There was shown to be a very wide variation, but in the case of the epidemic at Ames the milk was shown to have been the agent that conveyed the disease.

Botanical papers were presented by H. A. Mueller on the 'Shrubs and Trees of Madison County'; T. J. Fitzpatrick, on the '*Cupuliferae* and *Juglandaceae* of Iowa,' and one by F. M. Witter, on 'Some Observations on the Flora of Southern Alabama and Louisiana.' James E. Gow presented a 'Preliminary List of the Flowering Plants of Adair County.' Mr. F. W. Faurot described the early development of *Astragalus caryocarpus*. In fixing, best results were obtained by the use of Flemming's, although platonic chloride also gave good results. Professor Shimek, in his paper, 'Addenda of the Flora of Lyons County,' reported *Juglans nigra* and several herbaceous plants for that county. L. H. Pammel presented a paper on the 'Thistles of Iowa.'

An expedient for maintaining a constant temperature through the process of salt-glazing clay was presented by Ira J. Williams.

A committee on pure food legislation, consisting of C. O. Bates, J. B. Weems, Nicholas Knight, M. Ricker and W. S. Hendrixson was appointed, and also one on forestry, consisting of L. H. Pammel, T. H. Macbride and H. A. Mueller.

L. H. PAMMEL.

#### THE NEBRASKA ORNITHOLOGISTS' UNION.

THE annual meeting of the Nebraska Ornithologists' Union was held in the lecture room of the Omaha City library, January 12, 1901. President J. S. Trostler called the meeting to order for a business session which occupied the morning. During the noon hour the visiting members were the

guests of the resident members, who had a luncheon prepared in the dining-room of the Omaha Commercial Club. The afternoon was devoted to the reading and discussion of papers. Measures were adopted and resolutions drafted in the interest of greater protection for all birds of the State. It was the expression of the body that the growing revulsion of feeling against bird slaughter would soon lead to such improved sentiment that the hunter's path through the woods could not be tracked by the blood of birds shot indiscriminately.

In the absence of Mr. J. H. Ager, State Warden of the League of American Sportsmen, Professor Lawrence Bruner reported upon an important measure for the protection of fish, game, and birds, to be presented for legislative action at the present session. The recent balloting for officers resulted as follows: *President*, Erwin Hinckley Barbour, Lincoln; *Vice-President*, Miss Elizabeth Van Sant, Omaha; *Corresponding Secretary*, J. C. Crawford, Jr., West Point; *Recording Secretary*, Robert H. Wolcott, Lincoln; *Treasurer*, Charles Fordyce, University Place; *Executive Committee*, Lawrence Bruner, Lincoln; F. H. Shoemaker and J. S. Trostler, Omaha. The Secretary announced the present membership as ninety-five.

#### PROGRAM.

President's Address, 'History of Ornithology in Nebraska and of State Ornithological Societies in General,' by J. S. Trostler, Omaha.

'The Relation of Birds to Agriculture,' by L. Bruner, Lincoln.

'Injurious Traits of the Blue Jay,' by E. D. Howe, Table Rock.

\* 'Ornithology in the Schools,' by Wilson Tout, Utica.

'The Value of Birds as Objects of Study in the Grades,' by Chas. Fordyce, University Place.

'A Late Nest of the Ruby-throated Hummingbird,' by Frank H. Shoemaker, Omaha.

'Young Rose-breasted Grosbeaks,' by Elizabeth Van Sant, Omaha.

'The Breeding of the Prothonotary Warbler in the

\* Read by title.



Missouri River Bottom,' by M. A. Carriker, Nebraska City.

'Observations on Traill's Flycatcher,' by M. A. Carriker, Nebraska City.

\* 'On the Distribution and Breeding Habits of Bell's Vireo,' by Merritt Cary, Neligh.

'Some Notes on a Chimney Swift Tree,' by J. S. Trostler, Omaha.

'Birds that Nest in the State,' by L. Bruner, Lincoln.

'A Peculiar Disease of Birds' Feet Observed in Western Nebraska,' by E. H. Barbour, Lincoln.

\* 'Intestinal Parasites of Nebraska Birds,' by H. B. Ward, Lincoln.

\* 'Changes in the Bird Fauna of the Prairies in the Last Thirty Years,' by L. Sessions, Norfolk.

'Additional Observations on the Birds of Northwest Nebraska,' by J. M. Bates, Long Pine.

'Results of a Collecting Trip to Sioux County,' by J. C. Crawford, Jr., West Point.

'Notes on Cherry County Birds,' by J. S. Hunter, Lincoln.

'Notes on Birds from Western Nebraska,' by A. R. Graves, Kearney.

'Notes on Some of the Rarer Birds of Gage County,' by M. H. Swenk, Beatrice.

'Additional Observations on the Keeping of Records,' by R. H. Wolcott, Lincoln.

'Sketch of M. L. Eaton,' by R. H. Wolcott, Lincoln.

\* 'Behavior of Birds when driven from their Nests,' by W. Edgar Taylor.

'Miscellaneous Notes.'

After President Trostler had inducted the newly elected President into office, the meeting was adjourned.

EDWIN H. BARBOUR,

UNIVERSITY OF NEBRASKA.

Secretary.

#### THE KANSAS ACADEMY OF SCIENCE.

THE thirty-third annual meeting of this Academy was held at Topeka on Dec. 28-29. The following papers were read:

E. B. Knerr reported upon an artesian well at Muskotah, from which a very potable water flows at the rate of fifty-five gallons per minute. This water has a temperature of 56° F. J. T. Willard gave an account of some experiments on the relative digestibility of raw and cooked proteids. The experiments were made upon peas, beans, oat-

\* Read by title.

meal, and flour, with a weak pepsin solution. The general results showed that the proteids in all these articles were much more digestible raw than cooked. While cooking diminishes the digestibility of the proteids, it of course increases that of the carbohydrates. The same author reported some results obtained at the Experiment Station in reference to the effect on the soil of continuous cropping of wheat. The figures given showed that the soil was in a marked degree deprived of soluble phosphoric acid by this continuous cropping. Parallel analyses were made of the soil of a field where wheat had been grown continuously for many years, and of an adjoining field where a variety of crops had been grown, and in the latter this loss of phosphoric acid did not occur. Professor Willard also discussed the effect of oxygen upon organic life. The tests made showed that, as far as the lower animals were concerned, it made very little difference whether they breathed oxygen or ordinary air.

A. E. Langworthy gave a complete report of a diamond drill boring recently made at Atchison. The drill disclosed no less than sixteen seams of coal, having together a thickness of fourteen feet and six inches. The most interesting of these seams are a 36-inch seam at a depth of 1,123 feet, a 28-inch seam at 1,187 feet, and a 15-inch seam at 1,197 feet. The 36-inch vein is a specially good quality of coal. An analysis of the Mississippian limestone, from this boring, is reported by Fred. B. Porter. W. C. Bauer reported on the work of the United States Coast and Geodetic Survey as carried on at Baldwin.

C. N. Gould read a paper on the salt plains of Oklahoma. The largest of these covers an area of nearly 50 square miles. Salt springs are found in various localities, so that a practically inexhaustible supply of salt can be obtained. The same author reported on the 'Southern Extension of the

Marion and Wellington Formations' and on 'The Dakota Cretaceous of Kansas and Nebraska.' A. S. Hitchcock gave a list of the plants collected in Lee County and other localities in Florida, a region of great interest to the botanist on account of the diversity of the flora.

Warren Knaus, in reporting on the additions to Kansas coleoptera, stated that the number of known species is now 2,500. W. K. Palmer gave an illustrated paper on 'The Value of Geographical Methods in the Teaching of Thermodynamics'; also on 'The use of Ball-bearings for General Machinery and on Principles of Chimney Design.' E. C. Franklin discussed the experiments that he has been conducting during the past year, upon the use of 'Liquid Ammonia as a Solvent.' Many of these experiments, which have already been published, throw a great deal of light upon the new theories of solution. An interesting paper on the Americus limestone, was presented by Alva J. Smith. The area covered by this excellent building stone was discussed, and an analysis given. L. E. Sayre spoke on the 'Medicinal Plants of Kansas.' He mentioned the medicinally valuable plants of the Asclepiadaceae and gave the geographical distribution of the medicinal plants of this genus and the commercial value of the products.

J. R. Mead gave an interesting paper on the peculiar formation known as the 'Flint Hills'; and also one upon the 'Archeology of Catalina Island,' illustrating the latter paper with fragments of ancient vessels. S. W. Williston described a new cretaceous turtle which he has recently studied. A paper from Edward Bartow gave an account of the work being carried on at the Laboratory of the State University on 'Sanitary Water Analysis of the Kaw River' and other streams and miscellaneous sources of supply in the State. Grace B. Meeker read a paper that attracted much interest,

upon the wild flowers of the locality that are adapted to cultivation. This brought out a discussion in which much valuable information was elicited. J. W. Beede reported on 'Some Contributions toward a Monograph of the Permian of the central United States' and also, in connection with C. N. Gould on 'The Kansas-Oklahoma Triassic and its Invertebrate Fauna.' The same author discussed the 'Atchison Shales.' E. H. S. Bailey gave the analysis of a Mangano-ferrous mineral water, that contains more manganese than any water that has been previously noticed. L. N. Morscher read a paper on 'The Rôle of Isostasy.'

H. P. Cady has devised a new method for the detection of arsenic, antimony and tin. The arsenic is precipitated in a concentrated hydrochloric acid solution by a current of hydrogen sulfid gas, and to the solution hydrogen sulfid water is carefully added, when the antimony will be precipitated, and upon the further addition of the same reagent tin will be precipitated, so that at the end of the operation there will appear three distinct layers of sulfids of the metals in the test tube. Geo. H. Curtis read a paper on 'The Food of Fishes in central Kansas.' J. C. Cooper reported on some interesting specimens of nodular pyrites.

Several valuable lists were placed on record, as that of 'The Spring Flora of Cowley Co.,' by Mark White; a catalogue of the 'Goss Ornithological Collection' by B. B. Smyth; a list of 'Birds observed in Dickinson County' by D. E. Lanz; a catalogue of the 'Crayfishes of Kansas' by J. A. Harris.

The evening of Friday was occupied by the address of the retiring president, A. S. Hitchcock, on 'Ecology, or the Effect of Environment upon Plants,' an illustrated lecture on 'The Milky Way,' by E. Miller, and another paper, also illustrated, on 'Mines and Minerals of Kansas,' by G. P. Grimsley. E. H. S. BAILEY.

*THE STANLEY-McCORMICK HOPI EXPEDITIONS.\**

IN 1897 the Hopi collections of the Field Columbian Museum were comprised within three cases and consisted chiefly of a gift from Mr. Ayer, supplemented by a small collection purchased from Mr. Keam, a Hopi trader. During this year I made an extended collecting trip through a number of the Western States, visiting on my return the Hopi pueblos, where I remained five days, which were spent in collecting ethnological material. From several sources, previous to my visit, I had heard of a collection which the missionary Mr. H. R. Voth had been forming during a number of years, to assist him in his studies. While examining this collection I was at once impressed not only with its great beauty and richness, but with the detailed knowledge which Mr. Voth possessed concerning every object in his collection. At that time there was no willingness on his part to sell any or even a portion of the collection, and in fact its sale was not even seriously considered.

In December, 1897, I revisited Oraibi, the largest of the Hopi villages, in company with Mr. Melville, an attaché of the department as modeler and sculptor. The object of this visit was to secure life casts of several Hopi for the production of a large group which would illustrate certain phases of their house life. Mr. Voth had in the meantime enlarged his collection, and I was more than ever brought to a realization of the value of its accession for our Museum. I returned to Chicago with the idea that we should secure the Voth collection, as well as the services of Mr. Voth that he might arrange the collection and construct certain altars, etc., illustrative of the religious life of the Hopi.

Shortly after my return I consulted with Mr. Ayer in regard to the matter, and it was

through his interest in the Museum that the subject was brought to the attention of Mr. Stanley McCormick, who, in January, 1899, notified me that he would contribute a certain sum toward the work, as had been outlined by me. Within a few days after this announcement of McCormick's intention, Mr. Voth arrived at the museum and began work, continuing with the museum uninterruptedly until May 1, 1900, when he left for Oraibi again to assume his duties as missionary. During Mr. Voth's connection with the museum his entire collection was installed, nine altars, involving an immense amount of detailed labor, were constructed, and over 1,700 labels were written. While Mr. Voth had never had previous experience in museum work, his natural ability was so great, his knowledge of the subject so profound and his earnestness so intense, that a great deal of work was accomplished in that time, and it was with no little degree of regret that I saw Mr. Voth leave for his field of work as missionary.

While the collection acquired from Mr. Voth contained a large amount of ancient pottery, yet the major part of the collection was purely ethnological, and it soon became evident that if we were to derive full benefit from the opportunities which presented themselves in Arizona for a complete exhibit of a single tribe, we must at once set about to secure a proper representation of ancient Hopi life, as remained concealed within the ancient house ruins and burial places. Much archeological investigation of this sort had already been carried on by other investigators, especially by Dr. Fewkes of Washington, who for many years had devoted much time to this work and always with consummate success. I decided, therefore, that while attempting to make our collection representative of all parts of the territory covered by the ancient Hopi, we should pay especial attention

\* Read before the Chicago Society of the Archeological Institute of America, December 18, 1900.

to the ruins which heretofore had been lightly passed over; especially was it my desire that we might discover new ruins where yet remained interesting material. In accordance with this idea Mr. Burt, an assistant in the department, left Chicago early in December of 1899, and began a series of explorations in the well-known ruins of Homolobi near Winslow, on the Little Colorado River. He pushed on to the west, following the course of the river, and investigating one ruin after another for a distance of seventy-five miles. The result of this expedition was that our knowledge of the Hopi was considerably extended in a hitherto unexplored region, which was occupied by several clans, where the manufacture of the so-called yellow ware of the Hopi had not been practised. In none of the ruins explored by Mr. Burt beyond the point known as Cable Crossing, did he encounter any of this so-called yellow ware, but large quantities of other ware, the black and white predominating. About the same time that Mr. Burt left for the Little Colorado, Mr. Voth and I left Chicago for Oraibi, where we spent a little less than a month. The object of this—the second McCormick expedition—was not so much to secure material as to get additional information regarding certain altars. In this we were entirely successful, and while there had the good fortune to witness the nine day Soyal or Winter Solstice ceremony. Full notes were taken on this interesting ceremony and it will form the subject of a Museum publication shortly forthcoming. A number of interesting objects were also added to the collection on this expedition, of special interest being a number of masks and certain *tihus* or dolls which had never before been reproduced for the purpose of trade. Early in the present year, Mr. McCormick's attention was called to the fact that additional funds would be needed if the work was to be carried on, and he very

generously announced his intention of making provision for the continuation of the work and above all for an extension of archeological investigations among the ruins.

Early in May of this year I again sent Mr. Burt, on the third McCormick expedition, to the Lower Colorado, in order that the work which had been abandoned on the previous year, on account of the setting in of winter, might be continued. Mr. Burt continued his explorations on into the country of the lower Little Colorado river, reaching on this occasion Black Falls. As a result of this expedition many additional specimens, including a large number of turquoise beads, implements, utensils and ornaments of stone, bone and shell were secured, as well as a number of skeletons which will prove of the greatest value when the time comes to attempt to reconstruct the past life of the Hopi, so far as relates to their physical characteristics. It is only just to Mr. McCormick to say that he very generously made special provision for this second expedition of Mr. Burt's. The fourth and last McCormick expedition has just terminated after a period of eight months; this was in charge of Mr. C. L. Owen, also an assistant in the department, who left Chicago early in May. Mr. Owen confined his attention to the ruins located within the limits of the so-called Province of Tusayan, and the first five months of his time were spent in excavating at the great ruins of Sikyatki, Awatowi, old Mishonovi and old Cunopavi. All these ruins were well-known to scientists, and from many of them collections of considerable importance had been made, but so valuable are they for the purpose of reconstruction of the past history of the Hopi that it was considered especially desirable to form as large a collection as possible from each one. In this Mr. Owen was entirely successful, finding a hitherto unknown burying ground at

Sikyatki which yielded important results, and from Mishonovi—one of the most important of the Hopi ruins—securing over 600 pieces of decorated pottery alone, while from other regions he secured representative collections. Having exhausted the region in the immediate vicinity of the present Hopi villages he turned his attention to ruins of the North, many of which had never been previously visited by any scientist. While in this region he discovered ruins which we have reason to believe had never been seen by any white man. As a result of this expedition the Museum acquired nearly three thousand invaluable specimens, comprising every object which we might reasonably expect to find in graves or house ruins, and including a large number of rare forms of bahos or prayer offerings. Many unusual forms of stone implements, idols, and mask forms were found, while especially noteworthy are four painted stone slabs which probably once served in some Hopi altar and of which specimens have rarely ever before been found. Concerning the exact value of the contributions which may be made to science as a result of this last Hopi expedition it is of course too early yet to speak, but that our knowledge of the Hopi and of their migrations has been extended in many ways there is no question.

Finally there may be considered the contents of the two halls in the Field Columbian Museum devoted to the Hopi, for here, it may be properly assumed, are the visible, tangible results of these McCormick expeditions. Of the thirty-four cases which contain these collections, eleven are devoted to the ordinary every-day life of the Hopi. Here we may trace in detail, by means of thoroughly labeled specimens, models and three life-like groups, the domestic life of the Hopi through every phase of industry—such as pottery-making, basketry, spinning and weaving, costumes,

stone and bone utensils of various sort, etc. In the same room with these domestic collections are to be found several cases containing such of the material from ancient ruins as has been put on exhibition. These collections, however, it is to be expected, will be removed from this hall and shown in an adjoining hall along with collections which have been derived from the last two expeditions and which may be derived from further expeditions.

Much might be said of the interest attaching to the numerous specimens which these expeditions have yielded, but attention can only be directed to a single group of objects, namely, the yellow ware food bowls. Each one of these bowls is beautifully made (in fact no finer pottery has been found in America) and they are generally decorated on the interior with certain mythological figures or symbols. Among these bowls are very few duplicates, each one having its own story, having served during the life of its owner its own peculiar mission.

The second Hopi room is devoted to ceremonies and to the religious life in general of the Hopi. In this hall no distinct phase of the ceremonial or religious life has been omitted, and simply to show the fullness and richness of the collection, mention may be made of two or three categories of objects. While the Hopi are not greatly addicted to smoking, yet the use of tobacco forms a very important part in all of their ceremonies, and, for the production of smoke which shall symbolize clouds, special forms of pipes are used, known as cloud blowers. In other ways also during ceremonies pipes of special construction or design are used. The collection numbers over sixty interesting and carefully labeled specimens of pipes, many of which are extremely rare forms. During the ceremonies many forms of bahos or prayer messengers are used, and as these bahos are not made

for the purpose of trade, but as a rule are immediately after consecration deposited in shrines or springs, they are rather difficult to obtain, yet the collection numbers over 150 specimens of these interesting objects, representing nearly every form of *baho* known to the Hopi.

The figurines produced by the Hopi men and given by the mothers to the children during the *Niman*, or Farwell ceremony, and known as *tihus*, are objects found in all Hopi collections, but as a matter of fact these *tihus*, which represent certain mythological personages called *Katcinas*, are only reproduced for a limited number of characters. Owing to the unusual zeal shown by Mr. Voth toward the collection of this class of objects, the collection, with the recent addition of specimens brought home by Mr. Owen, numbers not less than 275, comprising over two hundred distinct varieties, a great many of which were reproduced for Mr. Voth only after earnest endeavor on his part. Inasmuch as these *tihus* represent *Katcinas* and as these *Katcinas* play a very important part in the religious life of the Hopi the importance of a collection of this magnitude, carefully arranged and labelled, can not be overestimated. Even more difficult than these *tihus* to obtain are the masks which are worn by the Hopi as they personate deities in the *Katcina* dances. The Hopi regard these masks with considerable reverence and do not willingly part with them, yet the collection numbers one hundred and thirty specimens, many of them being made of elk or buffalo hide.

But more important than these collections, however valuable and interesting, are the altars and sand mosaics, which are faithful, painstaking reproductions of altars which are erected year after year in the underground *kivas* of the Hopi. There may come a time when the actual altars themselves may be obtained, but up to the

present, so highly are they revered by the Hopi that no sum of money, however great, would induce them to part with a single slab from a single altar. The altars reproduced by Mr. Voth number nine, namely—the Antelope, Snake, Flute, Powamu, Powalawu, Katcina, Soyal, Marau and Oöquol. These altars are such as are erected by the Hopi during the great nine-day ceremonies, and while they do not exhaust the subject for even a single Hopi village, they are by far the most important altars and comprise within their number all those which contain images or fetishes. In most of the ceremonies represented by these altars, during the years when initiations are performed, sand mosaics are added to the altar, and comprised within the altars which have been reproduced are all those which contain this additional feature of interest. Mr. Voth also reproduced the great Ballülukon screen which is erected in the *kiva* during one of the ceremonies, and which is manipulated by means of concealed wires, to the intense delight of priests and the great mystification of the novitiates present.

The work which has been accomplished by the McCormick expeditions up to the present time has, I believe, been thorough and in every sense worthy the generosity of the patron. It must be admitted, however, that much yet remains to be done of equal value and importance among the Hopi of to-day and among the ruins of the past.

GEORGE A. DORSEY.

FIELD COLUMBIAN MUSEUM.

#### SCIENTIFIC BOOKS.

*An Atlas of Representative Stellar Spectra from  $\lambda$  4870 to  $\lambda$  5300*, together with a Discussion of the Evolutional Order of the Stars, and the Interpretation of their Spectra, preceded by a Short History of the Observatory and its Work. By SIR WILLIAM HUGGINS and LADY HUGGINS. London, William Wesley & Son.

This sumptuous volume of 165 folio pages worthily represents a part of the work which has been quietly in progress during the past forty years at the little private observatory at Upper Tulse Hill, London, one of the most important outposts at the frontier of astrophysical science. The additional title, 'Publications of Sir William Huggins's Observatory, Vol. I.,' leads us to hope that this introductory volume may soon be followed by others which shall give in similar manner the results which have been gained from the minute study of the large store of photographs which have been secured by the talented authors during many years of patient experiment and observation.

The first chapter gives a brief 'history of the observatory, and of the work done therein.' At the present day, when a photograph of the spectrum of a bright star may be obtained with an exposure of but a few minutes,—or even seconds, we are likely to fail to appreciate the difficulties and discouragements of the pioneers in these delicate researches, and we may forget how our present large and rigid instruments have slowly evolved from the first combinations of spectroscopes and telescopes. It was soon after the establishment of the private observatory that Mr. Huggins learned of the discovery by Kirchhoff and Bunsen of the true nature of the dark lines of the solar spectrum, which had been unexplained for more than half a century after their discovery. It at once suggested a wide field of research, and, as the author states, 'then it was that an astronomical observatory began, for the first time, to take on the appearance of a physical laboratory.' With the collaboration of Professor W. A. Miller, the spectra of forty stars and of Jupiter and Mars had been observed at the end of 1862. The news of the similar work of Mr. W. M. Rutherford in America arrived on the day the preliminary paper was to be read at the Royal Society.

The photography of stellar spectra was attempted in 1863, the wet process, of course, being employed, but the dark lines were not shown on the plates until the attempt was resumed in 1875. Meanwhile the chemical origin of a number of the lines in stellar spectra was established, and in 1864 Mr. Huggins made his

famous observation on the spectrum of a nebula, demonstrating its gaseous constitution. In 1866 a temporary star, *Nova Coronæ*, was first observed spectroscopically; and in the same year was begun the construction of a spectroscope for determining the velocity of stars in the line of sight, the results of the use of which were published in the *Philosophical Transactions* in 1868. Later, attention was given to the spectra of comets, and to attempts at the spectroscopic observation of the red prominences previously only seen during solar eclipses. Although the principle underlying their visibility in the spectroscope was clearly stated by Mr. Huggins early in 1868, he did not actually succeed in detecting them until after their discovery by Lockyer and Janssen later in that year.

Larger instruments and the dry-plate process permitted much progress in the work on stellar spectra after 1875, which is recorded in numerous papers read before the Royal Society in the subsequent years. The titles of eighty-two papers on work done at the observatory are given in the second chapter of the work. Chapters III. to V. describe the instruments and methods of obtaining the spectra, and of broadening them, the descriptions being largely quoted from the journals in which they were originally printed.

Chapter VI. occupies one quarter of the volume, and is entitled 'Discussion of the Evolutional Order of the Stars and the Interpretation of their Spectra,' with sections on (1) the types of stellar spectra, (2) original differences of stellar constitution, (3) classification of stellar spectra, and (4) physical and chemical interpretation of stellar spectra by means of terrestrial spectra observed in the laboratory.

In addition to its absorbing interest to students of astronomy, this chapter can hardly fail to be attractive to the general reader of scientific topics. The author quotes freely from his published addresses bearing upon this subject, and brings into discussion the work of other astronomers and physicists, although drawing his observational data chiefly from his own work. In the matter of classification of stellar spectra the author follows in the main the scheme suggested by H. C. Vogel in 1874.

The white stars are considered to be in a more diffuse state than our Sun, and hence in an earlier stage of development. The subdivision represented by Bellatrix, which has a characteristic spectrum of the 'Orion type,' is placed first in the order of stellar evolution. Considerable space is devoted to the question of which class of spectrum corresponds to the highest temperature of the radiating photosphere, and numerous lines of evidence are adduced to support the view that this is found in case of the stars with spectra of the solar type. The argument based upon the relative extension of the continuous spectrum into the ultra-violet region, the extension of the solar type being regarded by the authors as the greatest, is not wholly convincing, as the difficulty of securing identical conditions of exposure, atmospheric absorption, etc., in the case of different stars of different types, is very great. But emphasis is well placed upon the importance of taking into account more fully than has hitherto been done the large diminution in the star's effective radiation from the integrated effect of the selective absorption of its atmosphere; that is, from the absorption represented by the very numerous dark lines in spectra of the solar type.

Attention is drawn to the important effect of the convection currents in stellar atmospheres, and their increasing activity in the region where the dark lines originate, as the stars advance in age. This increase is assigned as a possible cause of the diminished prominence of the hydrogen lines in the spectra of the second and later types.

The reasons for the presence of certain particular lines of certain particular elements in the spectra of stars at different stages are considered by the authors to lie in the conditions of the absorbing region, as to density and composition, particularly the mixing of various vapors. The absence of the metallic lines from the spectra of the first type is attributed in part to the slight convective effects in the very diffuse atmospheres of these stars, so that as a result of diffusion hydrogen and the lighter elements preponderate in the region where absorption occurs; and in part to a slow temperature gradient, so that the vapors just above

the photosphere might differ in temperature too little from the photosphere for their lines to be seen as dark on the continuous spectrum.

The effect of density of the vapor is quite fully considered, particularly in connection with the laboratory experiments of the authors on the behavior of the calcium lines.

The twelve half-tone plates which illustrate the volume are admirably done, and represent extended and skilful work by the authors in their arrangement. Plate II. contains reproductions of numerous 'historical spectra,' as they are well named, obtained by the authors between 1876 and 1895. These are fully described in Chapter VII. The remaining plates receive a 'preliminary discussion' in Chapter VIII.

The treatment of the subject as a whole is qualitative rather than quantitative, and is not mathematical, so that the general reader can follow the clear and philosophical reasoning of the authors without the necessity of a previous familiarity with technical symbols.

Artistic head pieces and initials appropriate to the subject, the hand work of Lady Huggins, complete the adornment of the volume. The work has received the Actonian prize of the Royal Society, and the election of Sir William Huggins to the presidency of the Royal Society at this time will be recognized as highly appropriate.

EDWIN B. FROST.

*Annual Report of the Chief of the Bureau of Steam Engineering of the U. S. Navy Department, 1900.* Washington, Government Printing Office. 1900. 8vo. Pp. 123, pl. 17, folded.

This report, apart from its importance as detailing the work in applied science of one of the most important bureaus of the U. S. Government, has a peculiar interest at the moment to all who have become aware of the tendency illustrated, for example, in the operation of the National Observatory and of the Coast Survey, toward amateurism in all branches of the Government service. The Engineer-in-Chief of the Navy, Admiral Melville, is one of the most competent expert professionals in the Navy, or outside it, in his department, and his report, while giving an admirably condensed account



of the operations of his bureau during the official year 1899-1900, exhibits a state of affairs, in a vitally important department of public service, which must intensely interest, and at the same time alarm, every patriotic citizen.

The report includes a statement of the appropriations, and, in detail, the expenditures, of the branch of that departmental organization which is entrusted with the employment of two and a half to three millions of dollars annually in the design, construction, repair and maintenance of the naval machinery of our whole fleet. It gives an outline of the work in hand and an account of that performed during the past fiscal year, details of the inspection of contract work, and of the conduct and results of trial trips of new vessels in the Navy and of old craft repaired. It considers the character, numbers and efficiency of the personnel of the engineer department of the Bureau and of the fleet, the effect of recent and of proposed changes, and especially of such as affect the organization of the Navy Department and the crews of our vessels.

This Bureau has expended in the year reported upon over \$2,500,000, of which about one-half represents costs of labor and one-half expenditures for materials. In addition to extensive work in the designing of new machinery, the Bureau is compelled to examine and report upon several thousands of detail drawings submitted by contractors. Some conception of the extent and importance of this work may be obtained when it is known that, for a single ship, the *Kearsarge*, about 600 drawings were made of approved constructions and an uncounted number of proposed variations or expanded details. Even small craft, like the torpedo-boats, require almost as much work, though on a smaller scale, as they have nearly as many working parts as the largest vessels. There are seventy vessels under construction, or about to be contracted for. For all this work, and for the operations of the fleet, large numbers of engineer and constructing experts are needed; but, meanwhile, the number available, which has for years past been entirely inadequate, is constantly being reduced by retirement, death and resignation; no proper

arrangements having been made for its maintenance.

Where, for example, about twenty-five inspectors are needed, fifteen are to-day compelled to do the work as best they can, with evident risk to the efficiency of the service; where about thirty officers are needed at the Navy yards and stations, fourteen carry the burden, with similar risks to the service. 'The present force of engineer-officers is everywhere overtaxed,' but there is no way provided by which to relieve these officers or to add to their numbers, in a proper manner, the needed additional expert and experienced officers, possessed, as they should be, of an ample scientific and technical training and varied earlier experience. The ideal preparation is obviously some such preliminary general and special scientific education as is now, as a matter of course, presupposed in civil life, a professional apprenticeship and later experience in actual work of design and construction, and opportunities to exhibit that capacity for scientific work and for the management of productive organizations which, only, insures professional success, alike, in public and in private business. In fact, the tendency seems to be, in this as in so many other branches of the public service, to permit the most important affairs to drift into the hands of incompetents or, at best, of amateurs, personally clever, often, but entirely unequal to the conduct of affairs demanding special education, special experience, and native talent properly cultivated and developed by the common and essential process of evolution under the unsparing system of selection which obtains in a career of any sort in everyday life.

The Chief of Bureau protests, for example, against a proposed consolidation of the long-established bureaus of the Navy Department, in which a branch of the work of the service, as mechanical engineering, naval construction or navigation, is entrusted to a body of experts in that branch, presided over by a selected expert-chief detailed from the list of most experienced, talented and distinguished officers in the service. This must result, as is pointed out very clearly and convincingly, in either the introduction, as a general supervising officer,

of one who is expert only in his own special field or of one who has no expert knowledge of any branch. In the first case, the outcome would be what is seen in so many other governmental departments already: the subordination of able and competent men to an official without the ability to direct and who is made an official superior over men, each in his own department, without superior. In the second alternative case, the Secretary of the Navy, usually a man without any expert knowledge of the technical work of the service, will have, interposed between himself and the men who are competent to advise him, each in his own province, an officer equally incompetent with the Secretary himself—with the added and fatal disadvantage of giving to the new incompetent, authority over men technically educated and fully competent.

The vital principle that every important business should be conducted by an expert in that business is, in this case, ignored. Either course would, in the opinion of those most competent to judge, insure inefficiency in the operation of the naval service, of that arm on which the nation most relies to defend its honor and its rights in conflict with a foreign foe. But the most dangerous of foes is the amateur, in the position of an expert, controlling an important branch of public service.

The 'Personnel Bill,' passed by Congress as an emergency measure during the excitement attending the outbreak of the war with Spain, and which consolidates the whole Naval Engineer Corps with the Line of the Navy, seems to have worked a mischief in a similar manner. Amateur talent is entrusted with duties and responsibilities which can only be safely assigned to experts of high scientific education, thorough professional training and ample experience. The members of the old Engineer Corps are dying off and the whole business of engineering is nominally becoming shifted into the hands of line-officers without other than amateur knowledge of the business, and with obvious danger to the whole naval service. Either the law is defective or it is not found practicable to secure its intended results; but, whichever may be the fact, the important outcome is danger of sacrifice of the vital interests

of the Navy to amateur incompetence. Nor is there the excuse in lack of knowledge of the danger, in advance. Every report of the chiefs of bureau of earlier years, for a generation past, has included a warning, often earnest and impressive, of this coming danger; while, throughout the whole period, the steady reduction of the numbers of officers in this most vitally important of all divisions of the modern naval personnel has been progressing, and the dangerous change has been advancing toward a crisis, despite the constant warnings, not only of all chiefs of bureau, but of substantially all old members of the wrecked corps.

The constant danger to the Naval Observatory and its personnel through amateurism has been as constant a subject of protest, in the same manner and with no better result; but this introduction of amateurism into the sea-going navy is even more serious and is certain to result in more serious disaster.

R. H. THURSTON.

*A Record of the Geology of Texas for the Decade ending December 31, 1896.* By FREDERIC W. SIMONDS, Ph.D., Professor of Geology in the University of Texas—Transactions Texas Academy of Science for 1899, Vol. 3, Austin, Texas, October, 1900.

This work is deserving of more than passing notice for Professor Simonds has not only given a most painstaking and complete bibliography of the geology of the Texas region, but as truly expressed in the title a record of the same. Each of the 466 works noted is accompanied by an intelligent abstract or synopsis, so that this book becomes of greatest value to any one wishing to ascertain information concerning the Texas region for the decade ending with the year 1896. The task of compiling such a work at Austin, so remote from good library facilities, must have been enormous, and is a credit to Professor Simonds, the Texas Academy of Science and the University of Texas.

It is gratifying also to note that this work is but one of the recent manifestations of the quickened and improved condition of the University of Texas. Within the past ten years this institution has been gradually acquiring a faculty of progressive and able men and has made

a steady growth in every department, which places it in the front rank of Southern institutions and equal, if not ahead, of many of the older colleges of the North. Under the administration of President Prather its work is steadily advancing and it is to be hoped that the Legislature of Texas will see the necessity of an enlarged and ample endowment.

ROBT. T. HILL.

#### BOOKS OF REFERENCE.

WE have received from Messrs. Lemcke & Buchner, New York, the tenth volume of the invaluable year-book of the learned world, 'Minerva,' which is now a volume of 1,235 pages. The frontispiece is an etching of Professor W. C. Röntgen, the other men of science selected for this purpose in previous volumes having been Pasteur, Kelvin, Schiaparelli and Nansen. The editor has been compelled to give up his plan of including in the work data of international congresses, which is regrettable, though the task of securing such information is doubtless difficult. As it is the work contains a vast mass of information—a rough calculation indicates that the names of about 32,000 scientific and learned men, connected with the world's institutions of learning, are included. The statistics of students given at the end show that the universities having an attendance of over a thousand students are distributed as follows: United States, 26; Germany and Austria, 24; Italy, 10; Great Britain and France, 8 each; Russia, 7; Spain, 4; Norway and Sweden, 3; Switzerland, Belgium and Canada, each 2; Denmark, Portugal, Egypt, Brazil, Chili, Philippines, New Zealand and Japan one each.

'Who's Who' for 1901, published in London by the Blacks, and in New York by the Macmillans, is also a useful work of reference, giving as it does short biographies of the leading men and women of Great Britain and of a few Americans. All the leading British men of science are included, and it is interesting to note how many there are and what important work they have accomplished. It is impossible to discover by what principle or lack of principle the Americans have been selected. The provost of the University of Pennsylvania is

there, but not the president of Harvard University. Mr. Tesla is included, but not the two or three of our most eminent men of science who have been looked up. The editing of the book appears to be careful, but not perfect. Thus to take a somewhat trivial example, Francis Darwin is said to be the son of 'Charles Robert Darwin,' George Howard Darwin is said to be the son of 'the late Charles Robert Darwin (author of the 'Origin of Species,' etc.)' and Leonard Darwin is said to be the son of 'the celebrated Charles Darwin, Down, Kent.' The 12,000 biographies, more or less, which the volume contains are certainly most useful for reference. In this connection it may be stated that a new edition of the American 'Who's Who' is in preparation, and the editor Mr. John W. Leonard, care of A. N. Marquis & Co., Chicago, will be glad to secure corrections and additions to the last edition.

#### BOOKS RECEIVED.

- Practical Electro-chemistry.* BERTRAM BLOUNT. New York, The Macmillan Company; London, Archibald Constable & Company. 1901. Pp. xi + 374.
- Electricité et Optique.* H. POINCARÉ. Paris, Georges Carré and C. Naud. 1901. Pp. ii + 641.
- The Bird Book.* FANNIE HARDY ECKSTORM. Boston, D. C. Heath & Company. 1901. Pp. xii + 276. \$60.
- Elevation and Stadia Tables.* ARTHUR P. DAVIS. New York, John Wiley & Sons; London, Chapman Hall, Limited. 1901. Pp. 43.
- Laboratory Instructions in Chemistry.* ERNEST A. CONGDON. Philadelphia, P. Blakiston's Son & Company. 1901. Pp. viii + 110.
- Studien über den Milchsaft und Schleimsaft der Pflanzen.* HANS MOLISCH. Jena, Gustav Fisher. 1901. Pp. viii + 111.
- Die Reizleitung und die reizleitenden Strukturen bei den Pflanzen.* B. NEMEC. Jena, Gustav Fisher. 1901. Pp. 153. Tafeln 111.
- Seventeenth Annual Report of the Bureau of American Ethnology.* J. W. POWELL. Washington, Government Printing Office. 1893. Part II. Pp. 752.

#### SCIENTIFIC JOURNALS AND ARTICLES.

THE *Botanical Gazette* for January, 1901, contains a second contribution by Professor C. S. Sargent, 'On New or Little Known North American Trees.' This special fascicle of descriptions

includes a new honey locust from Texas and eight new species of *Crataegus*. Mr. Theo. Holm contributes an 'Anatomical Study of *Eriocaulon decangulare* L.,' from which he concludes that this genus and its allies are somewhat unique among the monocotyledons. Mr. B. M. Duggar, of Cornell University, records the results of 'Physiological Studies with reference to the Germination of certain Fungous Spores.' The number closes with the usual book reviews, notes for students and news items.

The February number of *Popular Astronomy* contains an article by R. G. Aitken, of Lick Observatory, on the 'Orbit of Sagittarii,' accompanied by a plate of the orbit; the second part of Mr. How's article on the 'Best Astronomical Books for the Use of Students' takes up historical and biographical works in detail; J. F. Lanneau contributes notes on the eclipse, and Asaph Hall a note on 'Clairaut's theorie de la figure de la terre.' J. K. Rees, of Columbia University Observatory, presents a full report of the observations on the November meteors during the years 1898, 1899 and 1900. An abstract is also given of the article by Kretz on the 'Star Coma Berenices' and a full account of the recent reports of the Board of Visitors of the Naval Observatory. An article by Professor W. W. Campbell shows how the observations of Eros will determine the sun's distance from the earth and a résumé of the scientific progress of the nineteenth century closes the general department of the number. In addition to the usual notes a new department is opened which gives news of 'Double-Stars, their Observations and Observers.'

#### SOCIETIES AND ACADEMIES.

##### SCIENCE CLUB OF THE UNIVERSITY OF WISCONSIN.

THE December meeting of the Science Club of the University of Wisconsin was addressed by Dr. C. R. Van Hise on the topic, 'The Earth's Story of the Ore Deposits.' This address, which was delivered to a large audience, treated in a briefer and simpler manner a subject which has recently been given an ex-

haustive treatment in addresses before the American Institute of Mining Engineers and the Western Society of Engineers, and which under the title, 'Some Principles controlling the Deposition of Ores' has been printed in the *Transactions* of the first-mentioned Society. The thoroughness of Professor Van Hise's investigations, which, starting on different lines, have converged upon a common point, set to rest many hitherto controverted questions and, from an application of newly determined principles in the fields of physical chemistry, applied mathematics and soil physics, as well as in geology, there has been evolved a theory of ore deposition which is both logical and in accord with observed facts. The theory may be said to be grounded on two important earlier investigations: one by Van Hise, showing that at the moderate depth of 20,000 meters all save the smallest cavities must close in even the hardest rocks, whereas in most rocks they must close at one-half that depth, and one on Slichter's elaborate investigation of the flow of underground waters, an investigation which has been considerably extended by Van Hise.

From the first-mentioned study it follows that the circulating waters, which it is almost universally admitted deposit the ores from solution, could not have come from below the depth of 20,000 (or perhaps 10,000) meters. The excessive friction of liquids moving in capillary tubes, and the consideration that probably 100,000 times as much liquid as ore must be transported seem to exclude the possibility of ascensional currents below this level, thus restricting their circulation to the thin outer shell of the earth's crust—the *zone of fracture*. This requires that the circulating water shall be of meteoric origin, and the fundamental premise is made that the motion of the waters is a result of gravitative stress.

Water flowing under head from one point to another through a homogeneous medium will utilize the entire cross-section (indefinitely extended), though the major portion will pass by the shortest route. If vertical fissure planes exist in the course of the liquid the lines of flow will be deflected so that above a certain point they will enter the fissure in a downward direction and below another point they will be di-

rected upward, while between the two points they enter laterally. It follows from this that a particular body of ore may have been formed by ascending, descending or laterally moving currents, or by any or all combined.

The level of ground water separates an outer *belt of weathering*—a belt in which oxidation, carbonation and hydration are producing soluble bodies—from an underlying *belt of cementation* in which deposition is continually taking place, often in connection with solution. In many mining regions the processes of degradation have removed several thousand meters of rock from above the present belt of weathering, but as the belt removed has all at some time been included within the belt of weathering, it is an adequate storehouse from which the ore bodies of the present belt of cementation have been supplied. Another fundamental premise is that materials will be more generally taken into solution during the descending course of waters and be deposited during the upward course toward the surface, both because the increasing pressure and temperature with increasing depth favor solution, and because the larger fissures near the surface—the trunk channels—allow the mingling of solutions. Since the same fissure may near the surface be receiving descending waters, a little lower down laterally moving currents, and at still greater depth ascending currents, it follows that as degradation brings successively lower and lower belts within the realm of action of ground waters, the first concentration of ores will, in general, be produced by ascending currents and the later concentrations (if there be any) by laterally moving or descending currents. The first concentration should be less in amount than later concentrations, a conclusion which is supported by observation, since nine mines out of ten are poorer below the 300 meter level than above it, and still poorer below the 600 meter level. Inasmuch as the deep water circulation is deficient in oxygen but contains reducing agents, while the shallow water circulation contains free oxygen, it is easy to explain the development of oxide ores in the belts near the surface. Dr. Van Hise holds that oxidized salts, such as sulphates, carried to greater depths, react upon the lean sulphides so as to

precipitate the metals as sulphides from the solution. The above are only the broader generalizations in the earth's story of the ore deposits as read by Professor Van Hise.

WM. H. HOBBS.

#### THE TEXAS ACADEMY OF SCIENCE.

DURING the quarter ending December 31, 1900, there have been three noteworthy meetings of this organization. At the first, held in the Chemical Lecture Room of the University of Texas, Friday evening, October 26th, Dr. Simonds, the retiring President of the Academy, introduced his successor, Henry Winston Harper, M.D., F.C.S., who then delivered the Presidential Address, his subject being 'Some Advances in our Knowledge of Immunity and Protective Inoculation.' This address will be published in full in SCIENCE.

The second meeting of the quarter was held in the Chemical Lecture Room of the University, Friday evening, November 23, 1900. The program was as follows:

1. 'The Present Foundation of the Austin Dam,' by Professor T. U. Taylor, University of Texas.
2. 'An Application of the 57.3 Rule,' by Professor T. U. Taylor.
3. 'Eros and the Solar Parallax,' by Dr. Harry Y. Benedict, University of Texas.

The third and last meeting was held at Baylor University, Waco, Texas, December 28–29, 1900. The program was of unusual interest and covered a wide range.

1. 'The Problem of Forest Management in Texas,' by Dr. William L. Bray, University of Texas.
2. 'Recent Progress in Insect Warfare' (by title), by Professor F. W. Malley, Agr. and Mech. College of Texas.
3. 'The Value of Coal Tar Products as Practical Wood Preservers,' by Instructor E. P. Schoch, University of Texas.
4. 'A Mathematical Problem,' by Professor J. B. Johnson, Baylor University.
5. 'The Cretaceous—the Kindergarten of Paleontology,' by John K. Prather, B.S., Waco.
6. 'The Silt Problem in connection with Irrigation Storage Reservoirs,' by Professor J. C. Nagle, Agr. and Mech. College of Texas.
7. 'The Need of Technical Education in the South,' by Dr. William T. Mather, University of Texas.
8. 'The Modern Presentation of Botany,' by Instructor A. M. Ferguson, University of Texas.

9. 'Note on the Occurrence of Mammoth Remains in McLennan County,' by Professor O. C. Charlton, Baylor University.

10. 'The Hydrographic Survey of Texas,' by Professor T. U. Taylor, University of Texas.

11. 'Theorem concerning Centers of Curvature of a Roulette' (by title), by Dr. M. B. Porter, Yale University, New Haven, Conn.

12. 'On the Floral Provinces and Vegetative Formations of the West Texas Region' (by title), by Dr. William L. Bray, University of Texas.

FREDERIC W. SIMONDS,

UNIVERSITY OF TEXAS. *Secretary.*

#### ENGINEERING ASSOCIATION OF THE SOUTH.

THE regular monthly meeting of the Association was held on the evening of January 10th, at Vanderbilt University.

The death of Maj. Niles Meriwether, President of the Association was announced, and Messrs. J. S. Walker and Hunter McDonald were appointed a committee to prepare a memorial sketch of his life. The Association will feel most keenly this loss, for Maj. Meriwether has been a most active member.

A communication from Mr. J. C. Truatwine, Jr., Secretary of the 'Journal of Association of Engineering Societies,' was read. After some little discussion it was the unanimous opinion that the continuance of an individual publication was far preferable to uniting with the 'Journal of the Association of Engineering Societies,' and the Secretary was instructed to so notify Mr. Truatwine.

The first paper was a description of the methods of doing some bridge pier and foundation work in Chemulpo, Korea, by W. H. Holmes, an American engineer who has recently returned from that country. The system of keeping records of rivers in that ancient country was briefly described. They extended back into the past for many centuries and are said to be very accurate. Mr. Holmes stated that where an opportunity offered itself for a check the records were in every case sustained. The record for the river in question extended back 509 years and explanation was made at the beginning of the records that the history of the river previous to that time had been consumed in a fire which had burned the house and all contents.

The second paper was presented by Mr. Julian W. Kendrick, city engineer of Birmingham, Ala. It was an exhaustive study of the sewerage problem now confronting the Birmingham district. The geographical features of the drainage area were described, the difficulties in carrying out the various methods of sewerage set forth, and finally a plan proposed. The paper had been carefully prepared and was an interesting contribution on the sewerage question.

H. M. JONES,  
*Secretary.*

#### VERMONT BOTANICAL CLUB.

AT the annual winter meeting of the Club on January 25th and 26th the following program was presented:

'The Finding of a Plumose Variety of *Asplenium cbeuncum*,' by Mrs. Frances B. Horton.

'Some Common Confervæ,' by T. F. Hazen, Columbia University.

'Some Interesting Mosses Collected in Vermont in 1901,' by Dr. A. J. Grout, Boys' High School, Brooklyn.

'Are there Two Kinds of Hemlock in Vermont?' by Elroy C. Kent.

'Note on *Tremella mycetophila* Pk.,' by Dr. E. A. Burt, Middleburg College.

'Notes on the Last Season's Botanizing,' by Mrs. Nellie F. Flynn.

'Report of Progress on the Maple Sap Problem,' by A. B. Edson, University of Vermont.

'The Flora—What Next?' by Clifton D. Howe, University of Vermont.

'The Present Status of Vermont Botany,' by President Ezra Brainard, Middleburg College.

'A Botanical Trip to Joe's Pond,' by Mrs. Carrie E. Straw.

'Botanizing in the Bermudas,' by Dr. M. A. Howe, Columbia University.

'What Text-book of Botany shall be used in the High School?' by Miss Phoebe Towle.

'Wild Violets in the Garden,' by Miss E. Mabel Brownell.

'Are the Equisetums or Ferns Poisonous?' by Professor L. R. Jones, University of Vermont.

C. D. DIXLOWE,  
*Secretary.*

#### DISCUSSION AND CORRESPONDENCE.

A BIBLIOGRAPHIC CATCH TITLE FOR EVER AND EVER.

PROFESSOR MARK's method of referring to bibliographic lists by name of author and number of year is worthy of general adoption; but it is not surprising that a difficulty should be

met with when an attempt is made to depart from the principle of the method by the introduction of an arbitrary symbol. Professor Mark (SCIENCE, January 4, 1901) proposes that the sixteen hundreds shall be denoted by 1600, etc., the seventeen hundreds by 1700, etc., the eighteen hundreds by '00, etc., and the nineteen hundreds by :00, etc. This method could be of value only if accepted universally, or at least by all scientific writers. The confusion introduced by inadvertently writing '23 for 1923 will be as great as if one had actually written 1823. But is it likely that this confusion will be avoided, seeing that many people already have dated letters and so forth '00 or '01, meaning 1900 and 1901? Setting this objection aside for the present, we note what difficulty Professor Mark has in finding a suitable symbol for the nineteen hundreds, and we wonder what is to be done with the next century, and with the one after that, and so on. If we are to settle this question in a scientific spirit, let us attempt something better than an apostrophe for 18, a colon for 19, a hyphen, say for 20, a dagger for 21, and such arbitrary methods, all for the sake of saving an *em* space here and there or a few tenths of a second *per annum*. The irritation induced by the constant repetition of 18 or 19 is the least of the penalties we have to pay for the possession of ten fingers, and it is hardly enough to induce us to attempt yet once more some new method of notation. I therefore dismiss as impracticable all suggestions that familiar numerals should arbitrarily or even with some show of reason be replaced by punctuation marks, or by letters of any alphabet, or by ideographs, or by musical notes. But, seeing that the majority of papers referred to by any writer are, and in most cases will be, those of the hundred years immediately preceding the date of his own writing, I suggest that the apostrophe should be used, by those who like such self-saving devices, for all those years and for them alone. Professor Mark when he wrote in 1899 used the apostrophe for all the years 1800 to 1899. In 1901 let him use it for the years 1802 to 1901; in 1923, if, as we hope, he be still active, let him use it for the years 1824 to 1923. This plan seems to be more in accord with general usage. 'Who fears to

speak of '98?' did not cease to be intelligible to everyone, until the year '98 again came round. For all years more than a hundred back, or in any case of doubt, let us use the full number; and more particularly should it be used in the dating of important letters, of publications, and of formal entries in museum registers, or similar volumes of permanent historic importance.

F. A. BATHER.

NATURAL HISTORY MUSEUM,  
LONDON, ENGLAND.

#### A FURTHER APPEAL TO ALL LOVERS OF BIRDS.

ONE year ago all the sea birds breeding along our coasts seemed doomed to extinction at the hands of the milliners, in spite of their beauty and incalculable services as scavengers, and as guides to fishermen and mariners.

The American Ornithologists' Union, alarmed at the prospect, appointed a special committee to devise means for the preservation of these birds. This committee, aided by the press, appealed to the bird-loving public for funds with which to hire wardens to guard the sea birds while they were on their breeding grounds.

The contributions received in response to this appeal were sufficient to secure faithful wardens for the protection of all the colonies still left on the coast from Cape Charles, Virginia, northward to Maine.

The encouraging results of the efficient protection given the birds during the season of 1900 prompts the American Ornithologists' Union to continue its efforts during the coming breeding season and to extend, if possible, the work to the South Atlantic and the Gulf coasts, where there is even greater need of bird protection than in the north.

At the last session of Congress a Federal law was enacted, known as the Lacey Act, which gives by far the strongest protection ever furnished to bird or beast in the United States, as it makes it a punishable offense to export from a State any bird or animal unlawfully killed therein, or to receive such bird or animal in any other State. The common carriers are even now refusing to transport birds and animals in view of the heavy penalty attached to a violation of the Lacey law. It is believed by the committee that the vigorous enforcement

of this law by the United States Department of Agriculture, which has the matter in charge, and the proposed extension of the warden system, will in a very short time break down the whole plume trade so far as it lives upon the birds of the United States.

In addition to the special protection given to the birds by wardens, the American Ornithologists' Union, through its Protection Committee, is taking very active steps in a large number of States to improve the bird laws by amendments, or through the enactment of entirely new and effective statutes.

In view of the urgent need for a continuance of the work, and of the encouraging results of the first year's systematic efforts, the undersigned committee of the Union feel justified in making a second urgent appeal to every bird lover, and to every one who desires the preservation of these beautiful and economically valuable birds, to contribute to the fund necessary for continuing the work on a more extended scale.

Contributions should be sent to the treasurer, Mr. William Dutcher, No. 525 Manhattan Avenue, New York City.

[Signed.] Abbott H. Thayer; William Brewster, President Mass. Audubon Society; Witmer Stone, Chairman A. O. U. Com. on Bird Protection; Robert Ridgway, Curator of Birds, U. S. Nat. Mus.; C. Hart Merriam, Chief U. S. Biological Survey, Pres. A. O. U.; A. K. Fisher, Ass't Biologist, U. S. Biological Survey; J. A. Allen, Curator Vertebrate Zoology, Am. Mus. Nat. His.; Frank M. Chapman, Ass't Curator Ver. Zoology, Am. Mus. Nat. His.; William Dutcher, Treasurer, A. O. U.

#### SHORTER ARTICLES.

##### THE PROPER NAMES OF THE ALPINE CHOUGH AND OF THE EGYPTIAN CROCODILE.

IN a recent number of SCIENCE attention was called to some names of animals proposed by Osbeck (*Reise nach Ostindien und China*, 1765), which had been overlooked by subsequent writers and should replace several names in common use. Since then I have had the opportunity of examining a copy of the German translation\* of Hasselquist's *Iter Palæ-*

\* 'Reise nach Palästina.' Rostock, 1762.

*stinum eller Resa til Heliga Landet, etc.*, 1757; and among the many interesting questions of synonymy that are opened by this book there are two to which I desire to call attention at the present time, viz., the proper names of the Alpine Chough and of the Egyptian Crocodile.

In the first edition (1757) of Hasselquist that author describes the Alpine Chough as *Monedula pyrrhacorax* (p. 238), which was referred to the genus *Upupa* by Linné in his 10th edition (1758), and subsequently, in the 12th edition (1766), described as *Corvus pyrrhacorax*. As the German translation of Hasselquist's work appeared in 1762, in which the name *Monedula pyrrhacorax* occurs with a full description on pages 238, 239, that author must be credited with first removing the Alpine Chough from *Upupa*, and restricting it under the name *Monedula pyrrhacorax* which is the proper name of the bird. Several changes in the synonymy of the species are necessary which should stand as follows:

MONEDULA PYRRHOCORAX (L.) Hass.

*Upupa pyrrhacorax* Linné. 1758.

*Monedula pyrrhacorax* Hass. 1762.

*Corvus pyrrhacorax* Linné. 1766.

*Pyrrhacorax alpinus* Viell. 1816.

*Pyrrhacorax pyrrhacorax* (L.) Temm. 1820.

*Monedula* Brehm (1828), being preoccupied by *Monedula* Latr. (1802), has been replaced by *Colæus* Kaup. Latreille's generic name must likewise fall in view of Hasselquist's prior use of *Monedula*.

The use by Hasselquist of Linné's name, *Lacerta crocodilus*, for the Egyptian crocodile has an important bearing as to the proper name of that animal. The *Lacerta crocodilus* of both editions of Linné was a composite species, and for that reason the name has been dropped by recent writers, the Egyptian species generally carrying the name *Crocodilus niloticus* Laur. 1769. It seems evident that its proper name is *Crocodilus crocodilus* (Linné), 1758, in consequence of Hasselquist's restriction of *Lacerta crocodilus* to the Egyptian animal in 1762.

I am indebted to Mr. Witmer Stone for suggestions regarding the synonymy of the Alpine Chough.

WILLIAM J. FOX.

ACADEMY OF NATURAL SCIENCES,  
PHILADELPHIA.



## THE WOOD BUFFALO.

THE following information has just come into my possession from the Inspector of Indian Agencies and Reserves, Mr. J. A. Macrae, who has recently returned from the far north. He writes: "At Fort Chipewyan, Fort Smith and Fort Resolution, I made close enquiries into the number of wood buffalo remaining, having an opportunity—owing to meeting so many Indians fresh from their grounds—such as I think no one else has enjoyed, to do this. Some of the Indians who were to meet me at each place had lately been near the Buffalo and had counted the different herds, which are generally speaking, three in number—one ranging from Salt River to Peace Point on Peace River; one from Salt River north to Great Slave Lake; and one from Salt River east and west. They number, I conclude, from 500 to 575. I understand that there has been an increase of perhaps a couple of hundred, and it would appear only to be necessary to continue vigorous protective measures in order to perpetuate the herd. It is noticeable that the fur of the wood Buffalo, owing no doubt to climatic conditions, is longer and thicker than was that of its brother of the plains, and it has that straightness and thickness which characterized the musk ox robe."

OTTO J. KLOTZ.

DEPARTMENT OF THE INTERIOR,  
OTTAWA, CAN.

## CURRENT NOTES ON METEOROLOGY.

## THE 'BOOM' POPULATION OF KANSAS.

SOME interesting facts concerning the change in the number of inhabitants of Kansas as a result of the rise and collapse of the 'boom' of the latter part of the decade 1880-1890, are given by Gannett in an article on 'The Population of the United States' in the last number of the *Bull. Amer. Geog. Soc.* (No. 5, 1900). It will be remembered that a succession of unusually rainy seasons at that time was followed by a large increase in land values, the whole region witnessing a tremendous 'boom.' There was a rapid gain in population. A number of dry seasons following, the settlers were literally starved out, and the country was quickly depopulated again. In 1885, at the beginning of the 'boom,' Kansas had a population of 1,268,-

530; in 1888, near its crest, the population numbered 1,518,552; in 1890 the figures were 1,427,096, and in 1895 only 1,333,734. The State thus gained nearly 250,000 inhabitants in three years, and later lost nearly 200,000. Similar conditions obtained in Nebraska and the two Dakotas.

## THE METEOROLOGY OF LOWER CALIFORNIA.

IN an article on 'Explorations in the Central Part of Baja California,' in the *Bull. Amer. Geog. Soc.* (No. 5, 1900, 397-429), Dr. Gustav Eisen gives a brief account of the rainfall and climatic conditions of the meteorologically practically unknown peninsula of Lower California. There are two sources and two seasons of rainfall. The summer rains extend from Todos Santos and Cabo San Lucas, in the south, as far up as the Sierra Nevada, in the northern part of Alta California. These summer rains are most frequent and heavy in the backbone of the Sierra which runs along the eastern coast of Baja California. The winter rains flow and then extend from Alta California down to the Pacific Coast, even as far south as San José del Cabo. These winter rains never enter the Gulf of California, and diminish in quantity and regularity to the south. As far south as San Quentin they are fairly regular, but beyond that point they are uncertain. In spite of these two sources of supply, the peninsula of Lower California is but very scantily supplied with rain.

## THE HARVARD METEOROLOGICAL STATIONS IN PERU.

THE 55th Annual Report of the Director of the Astronomical Observatory of Harvard College contains an announcement which will fill meteorologists the world over with regret. Speaking of the meteorological stations of the Harvard College Observatory in Peru, concerning which mention has frequently been made in the columns of SCIENCE, Professor Pickering says: "The observations at these different stations have now been continued in many cases for eight or ten years. At such stations, where, from the necessities of the case, the observers are generally men of limited education and experience, observations of the greatest accuracy cannot be expected, except by maintaining trained observers at greatly in-

creased expense. \* \* \* Taking into consideration the striking uniformity of conditions which prevail in different years in this region, it is probable that additional observations would not greatly increase our knowledge. It has been decided, therefore, to suspend, at the end of the year 1900, the meteorological observations of all the stations, except those at Arequipa."

#### RECENT PUBLICATIONS.

C. F. MARVIN: *Anemometry*. U. S. Department of Agriculture, Weather Bureau. Circular D, Instrument Division. 2d Edition. Washington, D. C. 1900. 8vo. Pp. 67.

This is a circular of general information respecting the theory and operation of instruments for indicating, measuring and automatically recording wind movement and direction, with instructions for the erection and care of such instruments of the Weather Bureau pattern.

C. F. MARVIN: *Psychrometric Tables for Obtaining the Vapor Pressure, Relative Humidity and Temperature of the Dew Point*. U. S. Department of Agriculture, Weather Bureau. Washington, D. C. 8vo. 1900. Pp. 84. Price, 10 cents.

These are the tables for the reduction of the psychrometric observations at the regular and volunteer stations of the Weather Bureau. The use of these tables began Jan. 1, 1901.

#### NOTES.

DR. H. R. MILL has become the Editor of *Symons's Monthly Meteorological Magazine*, in place of Mr. H. Sowerby Wallis, who has held that position since the death of Mr. G. J. Symons.

ACCORDING to Professor A. J. Henry (*Monthly Weather Review*, Oct. 1900), a conservative estimate of the total loss of property by lightning in the United States during the year 1899 would probably be \$6,000,000.

R. DEC. WARD.

#### THE NAVAL OBSERVATORY IN CONGRESS.

THE Observatory was discussed in the Senate on January 22d in view of an item in the naval appropriation bill. Mr. Morgan said:

I want to call the attention of the Senate to the fact that this great Observatory is without any real organization in law, and it is a haphazard, piecemeal

sort of arrangement by which it has been put under the Navy Department. It was first called the National Observatory of the United States. It was afterwards called the Naval Observatory of the United States, and was put under the Navy Department. No head or management of the Observatory, as I understand it, has ever been appointed or given the direction of it, but an officer of the Navy is detailed to take charge of the Observatory from time to time, who controls this matter. However, it is not a military office in any sense of the word, and it does not follow that a man educated at Annapolis has any very special training in astronomy. It seems to me that that great institution is very badly crippled for want of a proper organization.

We have here, upon the recommendation of what is called the chief astronomer, a provision by which an assistant spectroscopist is to be appointed, and yet they have made no reports recently of any work of that kind in the Observatory. I suppose there must be work of that kind going on, but the reports ought to show it if they are of any value at all.

Now, this great Observatory, perhaps the largest national observatory in the world—I think it is the largest one in the world—not larger, perhaps, though more costly, than some of the private observatories—has cost the Government of the United States for the site, buildings, grounds, and outfit \$655,845, and the roads, pathways, and gradings, \$95,900, making a total cost of \$751,745.

As I understand it, the Observatory does not have the rank amongst the observatories of the United States that it ought to have. There is very valuable work done there, a great deal of it, no doubt, but simply for the want of proper organization the work has not been conducted in the way it ought to be. I have introduced a bill in the Senate to organize the Observatory, for it has never had any organization.

I wanted to call the attention of the chairman of the committee to this particular appropriation, with a view of drawing out some expression from him, or from some one who is informed particularly on the subject, about certain points. Congress, it seems, has neither defined the objects for which the Observatory was founded, made any provision for its control, or appointed any authority to determine what it should do or to report upon its work, nor assigned to it any public function. What the Navy Department has been able to do is to provide for its government as a naval station, appoint an officer to command it, detail professors in the Navy for duty, give to the senior of these professors the title of astronomical director, and charge him with the duty of determining what astronomical work shall be done. But, as far as known, it has never been able to provide the head of the es-

tablishment, or the astronomical director, with any instructions or suggestions as to what the Observatory should do.

I am willing that this assistant spectroscopist shall be appointed and that he shall have the salary proposed to be paid under this proposed act, at the present time, because it seems that everything which is suggested here by a naval officer who is connected with the Observatory goes without any regulations of law at all. There is no law to regulate the National Observatory.

Mr. Chandler said :

When the naval appropriation bill comes up I hope the Senator will aid myself and the committee in securing some appropriate legislation to improve the management of the Observatory ; but it is not proposed by that bill to take the Observatory wholly away from naval control. It is proposed to establish a permanent board of visitors, on which shall be some of the most eminent astronomers, and also to make the astronomical corps a corps of civil officers, instead of a corps of life officers in the Navy. There are other incidental improvements of administration which are recommended. I hope there will be some legislation on the subject.

There is not, I will add, perfect satisfaction among the astronomers of the country with the work of the National Observatory ; and it was that dissatisfaction which led to the appointment of this board of visitors.

The subject is worthy of the very careful consideration of the Senate and of Congress.

Mr. Allison said in reply to Mr. Morgan :

I agree with the Senator that it may be necessary to reorganize the Naval Observatory. That has been in contemplation for some years.

On January 25th the same question was raised in the House, sitting as Committee of the Whole in connection with an item in the naval appropriation bill, appropriating \$18,000 for the building of three houses for the astronomers of the observatory. Mr. Newlands said :

I would like to ask the gentleman from Illinois whether he has any views in regard to the taking of this observatory out of the control of the Navy Department? My information is that it is really of no scientific value to the country or to the world, and that the observatory would be much better administered by some other department of the Government, with really scientific men at its head, instead of naval officers detached for duty there.

Mr. Cannon. The gentleman asks me a question of policy that is not necessarily connected with the building of these houses. I would say to my friend that no doubt my friend from West Virginia would

not agree with me. I do not believe, to answer his question, that the Astronomical Observatory ought to be under the control of the Navy or the Army or any other department in Washington. I think that we should have better administration and more economic administration if we were rid of that expensive house out there [the superintendent's house] under a direction that does not direct in scientific lines.

Mr. Newlands. I wish to state to the gentlemen that I understand that the naval observatory in England is of great scientific value, not only to that country but to the world, for the reason that the men in charge of the observatory are trained scientific astronomers and not naval officers. Now, I would call his attention to that and ask him whether it is not advisable that this entire department of the Government be placed under scientific control, with a view to the advance of scientific information.

Mr. Cannon. I will say to my friend now, if he will not call on me for names, because I do not like to give these in a city of official direction—I will say to him that men who have been in the service, scientific men, astronomers of this Naval Observatory, and men I apprehend that are in its service now, have protested to me time and time and time again that it was not so efficient as it ought to be ; that it was under a direction that was not in harmony, but that with less expense more efficiency could be had.

Subsequently Mr. Dayton described in some detail the work of the Board of Visitors to the Observatory of which he was a member. He said :

We went over, as far as was possible, as thoroughly as possible, the condition of the Naval Observatory and its management and its cost, and the result of our investigation is embodied in the report which I hold in my hand. We took occasion to investigate its history from start to finish and its management from start to finish. In addition to that, in order that there might be full and complete information presented to Congress and the country, certain questions set forth in this report were sent to almost every astronomer of reputation in the country.

Among those questions was one whether or not this Observatory should be transferred from the Navy Department to some other department, whether its efficiency would be promoted by such transfer, and whether, if such transfer was made, with what Department this Observatory should be connected. The answer to these questions presented an anomalous state of affairs. There was an absolute division of opinion that was nearly equal. For instance, my recollection is that 19 of the prominent astronomers suggested thought it ought to be disconnected from

the Navy Department, and 19 said no; but when it came to their suggestions as to what department it should be connected with, if disconnected from the Navy Department, the disagreement was enough—not to speak too lightly—to make any man's head ache.

There was almost as wide a divergence of opinion as opinions expressed. Some suggested the Treasury Department, some suggested the Geological, some the Interior Department, and some the Smithsonian Institution. Many thought—and I am sure the gentleman from Illinois would not be in favor of it—that it was immediately necessary to establish a new department of the Government, that of a department of science, and for the appointment of a secretary of that department, in order that this Bureau and this Observatory and one or two others might be connected with it and embodied in one institution. Others suggested that it was necessary for the Government in order properly to administer the Observatory to establish a national university.

This board, composed, as I say, of a member of the Senate and a member of the House and these three representative astronomers, after considering the whole matter from one end to the other, reached the conclusion that in the absence of the department of science or of the national university the management of the Observatory could be and would be as properly carried out under the control of the Navy Department as any other and at a probably less expense than any other.

Now, as I stated a moment ago, the Observatory work is done, as far as the executive head is concerned, by an officer detailed from the United States Navy, but who does not have control of the astronomical work. To a certain extent he is the head of the Observatory, but the responsibility for the astronomical work is placed upon the astronomical director.

The question whether or not it would be better for the head of the institution to be an astronomer, either from civil life or from the corps of mathematics, is one which can not in this connection be determined. But, so far as the scientific work is concerned, I am satisfied that it is now being well done; and I want to call attention to the fact that in a two-page article in *SCIENCE* of recent date, criticising Captain Davis's report to the Secretary of the Navy, it is admitted that the work is well done so far as the scientific part of it is concerned.

Therefore, I am sure my friend from Nevada [Mr. Newlands] will not hereafter desire in any way to do injustice to an institution of this country which may stand at the head, and should stand at the head, of all similar scientific institutions throughout the world.

#### SCIENTIFIC NOTES AND NEWS.

AN American Association of Pathologists and Bacteriologists was formed at a meeting held in New York on January 26th. The following officers were elected: *President*, Dr. W. T. Councilman; *Secretary*, Dr. H. C. Ernst; *Treasurer*, Dr. Eugene Hodenpyl. The first regular meeting of the Society will be held in Boston on April 5th.

ON the occasion of the retirement of Sir Archibald Geikie, F.R.S., of the Geological Survey of Great Britain and Ireland, he will be entertained at a dinner and presented with an address.

AMONG the honors conferred on the occasion of the bi-centenary of the Prussian monarchy is the patent of hereditary nobility to Dr. Emil Behring, professor of hygiene and the history of medicine at Marburg.

WE learn from *Nature* that the Manchester Literary and Philosophical Society has awarded the Wilde medal for 1901 to Dr. Elias Metchnikoff, of the Institut Pasteur, Paris, for his researches in comparative embryology, comparative anatomy, and the study of inflammation and phagocytosis; and the Wilde premium to Mr. Thomas Thorp, for his paper on grating films and their application to color photography, and other communications made to the Society. The Dalton Medal for 1901 has not been awarded.

THE Maximilian order for science and art of Bavaria has been conferred on Dr. Hugo Seeliger, professor of astronomy in the University at Munich.

PROFESSOR R. BLANCHARD, who for twenty-three years has filled the position of secretary to the Zoological Society of France, has presented his resignation to take effect on the twenty-fifth anniversary of the foundation of the Society. On this occasion a commemorative medal will be conferred on Professor Blanchard in recognition of his great services to the Society.

MR. W. H. DINES has been appointed president of the Royal Meteorological Society, London.

PROFESSOR GEORGE E. HALE, of the Yerkes Observatory, gave an address before the Boston

Society of Arts on January 31st, on 'Astronomical Photography with the Great Visual Telescope of the Yerkes Observatory.'

DR. C. W. ANDREWS, of the Geological Department of the British Museum, has, on account of ill health, been granted leave of absence for three months, which he proposes to employ in studying the geology of Egypt and the Soudan. It is earnestly hoped that he may be able to return to his excellent work on fossil reptiles and birds.

PROFESSOR W. B. SCOTT, of Princeton University will deliver a course of sixteen lectures before the Wagner Institute in Philadelphia, the first one to be given early in February.

THE officers of the Entomological Society of London have been elected as follows: *President*, the Rev. Canon Fowler; *Treasurer*, Mr. Robert McLachlan, F.R.S.; *Secretaries*, Mr. Herbert Goss and Mr. H. Rowland Brown; *Librarian*, Mr. George C. Champion; and as other *Members of Council*, Professor T. Hudson Beare, F.R.S., and Messrs. R. Adkin, Charles G. Barrett, William L. Distant, H. St. J. Donisthorpe, Charles J. Gahan, Robert W. Lloyd, Edward Saunders, G. H. Verrall and Colbran J. Wainwright.

THE Geological Society of France has elected the following officers for the year 1901: *President*, M. Carez; *Vice-Presidents*, MM. Haug, van den Broeck, Dereims, Nicklès; *Secretaries*, MM. Gentil, and Pervinquière; *Vice-Secretaries*, MM. Giraud, Mémin, *Treasurer*, M. Léon Janet; *Librarian*, M. Ramond.

WE regret to record the death of Mr. Frederic W. H. Myers, which occurred on January 17th at Rome, where he had gone, we understand, at the invitation of Professor William James. Mr. Myers was an accomplished poet and man of letters, but is best known to the general public for his enthusiastic devotion to the cause of psychical research. Mr. Myers was born in 1843, being a son of the Vicar of Keswick, and was elected Fellow of Trinity College, Cambridge in 1865. Since the establishment of the Society for Psychical Research in 1882, he devoted himself largely to its work, being its honorary secretary. He was one of the authors of 'Phantasms of the Living,' and has left

ready or nearly ready for publication a work on 'Human Faculty.'

DR. SEDGWICK SAUNDERS, the medical officer of health and public analysis for the city of London, and the author of numerous contributions to hygiene and public health, died on January 18th, at the age of seventy-six years.

CONSUL GENERAL McNALLY has reported to the State Department the death of Miles Rock, in Guatemala. Mr. Rock was born at Ephrata, Lancaster County, Pa., October 10, 1840. He was graduated from Lehigh University, in 1868 as civil engineer. From 1868 to 1869 he taught mathematics and mineralogy at Lehigh University. In 1870 went to the observatory at Cordova, Argentine Republic as astronomical assistant to Dr. B. A. Gould. remained in Cordova for three years, mapping the stars of the Southern heavens. From 1874 to 1877 he was employed by the United States hydrographic office, determining latitude and longitude in the West Indies and Central America. In 1878 he was an assistant on the Wheeler survey west of the 100th meridian, determining latitude and longitude, and from 1879 to 1883 he was assistant astronomer at the United States Naval Observatory at Washington, and observed the transit of Venus at Santiago in 1882.

THE five series of Alaskan birds secured at Point Barrow by Mr. E. A. McIlhenny has been divided into several representative collections. Most of these have now been disposed of, the best ones going to the Academy of Natural Sciences, Philadelphia, to the Hon. Walter Rothschild, Tryng, England, and to the Carnegie Museum at Pittsburgh, Pa.

THE Board of Estimate and Apportionment of New York City has approved the plans and specifications of the New York Public Library building, and appropriated \$2,850,000 for its erection. This is in addition to the \$540,000 already appropriated for the removal of the old reservoir and the building of vaults. The total cost of the library will consequently be \$3,390,000. It has been decided to build the library of white marble which adds about \$400,000 to the original estimate.

MR. ANDREW CARNEGIE has offered to give

\$50,000 to Lewiston, Me., for a public library on condition that the city will provide a site and \$5,000 annually for its support.

The Detroit Branch of the Archeological Institute of America, held its annual meeting in January. During the past year 64 new members were admitted and the fund contributed to the Institute reached \$1,042. The New York and Boston branches are now the only ones surpassing the Detroit branch in membership and activity. The committee, appointed to take steps for an archeological survey of Michigan, was increased to five, with instructions to work for the passage, at the present session of the Legislature, of a bill appropriating \$2,500 annually for investigating the antiquities of Michigan.

THE Turin Academy of Sciences will award, at the end of the year, its Bressa prize, of the value of nearly \$2,000, for the most important investigation or invention made during the past four years.

THE Röntgen Society, London, offers as a gift from its president, Dr. J. Macintyre, a gold medal to be awarded to the maker of the best X-ray tubes. They must be forwarded to 20 Hanover Square, London, so that they arrive not later than May 1st of the present year.

SOME of the specimens in the Virchow collection in the Pathological Museum of the University of Berlin were destroyed by a fire on January 16th.

IN the House of Representatives, on February 1st, Mr. Southard, of Ohio, chairman of the Committee on Coinage, Weights and Measures, asked unanimous consent to consider a bill to establish a national standardizing bureau. After some discussion it was agreed that the bill should be made a continuing order after the disposal of the bill to promote efficiency of the revenue cutter service.

THE New York State Medical Society, meeting at Albany, has passed the following resolution:

*Whereas*, Believing that the citizens of the State of New York, and liberal-minded men everywhere, are to be congratulated upon the establishment of the Pathological Institute of the New York State Hospitals, an institution founded for the investiga-

tion of the problems connected with insanity and related diseases and unique in the annals of medicine for the greatness of its opportunities, and most strongly recommending that the work of investigation for which the Institute was founded be sustained along its present lines of organization and principles of research;

*Therefore be it resolved*, That we, the members of the Medical Society of the State of New York, respectfully request his Excellency the Governor to sustain the Pathological Institute of the New York State Hospitals; that we beg him to give his support to its growth and development; to protect it against further difficulties, and that we submit to his attention protests against the subversion of the work of the Pathological Institute along the lines laid out by the director, the work being upheld by a wide movement of the medical profession and prominent scientific men of this country and of Europe.

THE Forest, Fish and Game Commission bill introduced into the New York Legislature to carry out the Governor's recommendation, and abolishing the Fish and Game Commission, and turning its powers over to the Forest Preserve Board, was reported favorably in the Senate, amended so as to abolish the Forest Preserve Board, and substitute for the present Forest, Fish and Game Commission, a commission of three similar to the proposed new Prison Commission. One member of the commission will receive a salary which has been fixed at \$5,000. The other two will be selected from among the constitutional State officers, one of whom, it is agreed, will be Lieut.-Gov. Woodruff.

At the monthly general meeting of the Zoological Society of London on January 18th, it was stated that there had been 211 additions made to the society's menagerie during the month of December, amongst which special attention was directed to seven specimens of Verreaux's guinea fowl (*Guttera edouardi*), presented by J. F. Walker, of Bulawayo; and to a valuable series of Indian birds lately presented to the society by Mr. E. W. Harper, F.Z.S., of Calcutta, consisting of examples of 20 species all new to the Society's collection. It was further stated that during the past month 20,931 persons had visited the Society's gardens, showing an increase of 6,605 as compared with the corresponding period of 1899.

MR. C. COLERIDGE FARR, in charge of magnetic work in New Zealand, has sent a letter to the editor of *Terrestrial Magnetism* in regard to the magnetic observatory soon to be erected at Christchurch, approximately in latitude  $43^{\circ} 30' S.$ , and longitude  $172^{\circ} 38' E.$  New Zealand will owe this observatory to the labors of a committee, of which Mr. Farr is secretary, appointed at the beginning of last year by the Australasian Association for the Advancement of Science. It will be the most southerly observatory in the world and will have an ideal situation in a magnetically uniform district, except for the possibility of disturbance by electric tramways, which, however, is not likely to occur, for some years and may be prevented altogether by legislation. It is hoped that the observatory will be in operation by the end of this year. Dr. Chree has undertaken the supervision of the construction of the magnetographs by Adie. Mr. Farr invites the various Antarctic expeditions that are soon to leave Europe to make any use they care of of the observatory, and expresses his willingness to give magnetic information or any other assistance. The Lyttelton Harbor Board has offered dock accommodation to the British National Expedition, and Mr. Farr thinks would doubtless extend the same courtesy of other expeditions. Another result of the labors of the above-mentioned committee is a small appropriation by Parliament to carry out some sort of magnetic survey of New Zealand. The Kew Observatory Committee has aided the work by the loan of a set of absolute instruments, with which observations have so far been made at 100 stations, chiefly in the middle island. In this Mr. Farr was ably assisted by Mr. H. F. Skey.

THE *British Medical Journal* reports that in the Budget of the Italian Minister of the Interior there will be included a sum of money for the prosecution of the campaign against malaria, which has already been begun in various parts of Italy under the influence of the experiments of Professors Celli and Grassi. This money will be devoted by the Government to the carrying out of new experiments and the establishment of prizes. The Italian parliament has before it a bill for the prevention of malaria, by which it would be made compulsory on all em-

ployers of labor in malarial districts to make provision for the lodging of laborers with proper precautions against infection in accordance with the present state of knowledge. They would further be compelled to supply remedies gratuitously to laborers who contract the disease until they have recovered their health. They would also have to build suitable dwellings for their laborers and proper lodging places for casual hands, all properly protected against malaria. Loans at  $3\frac{1}{2}$  per cent. would be advanced out of the public funds to small proprietors in order to enable them to comply with the obligations placed upon them by the bill. There is a clause exempting from taxation for twenty-five years new buildings erected for industrial purposes in malarial regions. Another clause provides that indemnities at fixed rates are to be paid to sick laborers and to their families by employers who fail to comply with the requirements of the bill.

THE *Evening Post* states that in consequence of the growth of German trade and commerce in all parts of the world, the German Emperor has decided to establish an institute for the study of oceanology, in Berlin, in connection with a naval museum. Both are to be part of the Berlin University, and will serve as an academy for naval instruction on the most modern system and in the widest sense of the word. One of the main objects is the instruction, not only of students in the subjects dealt with, but of all persons interested in them, including ships' captains, ship-owners, merchants, etc. The museum will be formed on a very large scale, the Emperor having ordered that all the naval collections at Wilhelmshaven, Dantzic, Kiel, and Hamburg shall be brought to Berlin, as well as all special collections in other museums, and the greater part of the German naval section exhibited in Paris last year. The Emperor has allotted two hundred and fifty thousand Marks for this purpose, and the Prussian Landtag has also made an appropriation. Though the institutions are still in course of formation, a series of free public lectures on oceanology, etc., by several of the leading German professors will be started at once. The program includes lectures on 'History and the Influence of Navigation,'

'The German Deep Sea Expedition,' 'The Polar Oceans and their Discovery,' 'Astronomy and Navigation,' 'The History and Use of Warships,' 'Oceanology and Navigation,' 'The Influence of Sea Power in History,' etc.

#### UNIVERSITY AND EDUCATIONAL NEWS.

By the provisions of the will of the late Benjamin D. Silliman, \$110,000 will ultimately revert to Yale University and \$10,000 to Columbia University. Yale University has also received from an anonymous donor \$100,000 for a new building for the medical school and \$6,000 from the family of the late Robert Callender, class of 1898, to found a scholar-ship.

JOHN D. ROCKEFELLER has agreed to give \$15,000 each to Mercer College, at Macon, Ga., Carson Newman College, at Mossy Creek, Tenn. and Des Moines College, at Des Moines, Ia., on the condition that each will raise subscriptions of \$60,750, to be paid in four annual payments.

THE Assembly of the State of California on January 29th passed the bill conferring full corporate powers and privileges on the trustees of Stanford University.

A SPECIAL committee of the Alumni of Stanford University, appointed last November, reported on January 26th, to a meeting of the alumni at San Francisco on the case of Professor Ross. The committee calls attention to Professor Ross's pamphlet entitled 'An Honest Dollar' illustrated by political cartoons, published during the campaign of 1896, and states that Mrs. Stanford regarded this as undignified. The report continues:

The justice of the criticism expressed at the time the pamphlet was published must be deemed to be conceded by Dr. Ross, since it has been admitted by him to your committee that he would not again pursue the same course under similar circumstances.

Your committee has been unable to find any evidence that Mrs. Stanford ever took exception to Dr. Ross's economic teachings.

That her ultimate demand for his resignation was not due to opinions expressed in his speeches on 'Coolie Immigration' and the 'Twentieth Century City,' but was because she deemed that her original estimate had proved correct and that he was re-dis-

playing, after three years of trial, those qualities found objectionable in the instance of her original action.

The admission of Dr. Ross to your committee that he would not regard a university rule against the participation in politics by a university professor of economics during the progress of a political campaign, as impairing the proper right of academic freedom, disposes of his contention that the criticism of his conduct in 1896 is capable of that construction.

From the foregoing facts and upon the testimony as a whole your committee concludes that the action of Mrs. Stanford in asking the dismissal of Dr. Ross involved no infringement of the right of free speech.

The London *Times* devotes to the troubles at Coopers Hill College an editorial which begins as follows: "The Secretary of State for India will be guilty of a grave and lamentable error if he is induced by the promptings of official pedants to refuse the demand for inquiry into the recent dismissals at Coopers Hill College, so vigorously pressed in Lord Kelvin's succinct and forcible letter published in our columns on Saturday last. It is well to remember that one of the causes which contributed to the downfall of Mr. Gladstone's powerful administration in 1874 was Mr. Ayrton's insolent treatment of men of science. His contemptuous reference to his intellectual superiors, Sir Joseph Hooker and staff at Kew, as 'gardeners' placed a black mark against the name of the First Commissioner of Works of that day which was never obliterated and which drove him out of political life. The man in the street may not understand much about science, but he has a feeling of respect for scientific men who work for small rewards in the interests of truth and knowledge. The public is quick to resent injustice inflicted on a class who have little power of defending themselves and whose services are of enormous and increasing value to national progress."

It is reported in the papers that serious riots have occurred at Kieff University. Conflicts have taken place between the students and Cossacks, in which many of the former were killed or wounded.

DR. RICHARD EWALD has been promoted to a full professorship of physiology in the University at Strasburg.



# SCIENCE

A WEEKLY JOURNAL DEVOTED TO THE ADVANCEMENT OF SCIENCE, PUBLISHING THE OFFICIAL NOTICES AND PROCEEDINGS OF THE AMERICAN ASSOCIATION FOR THE ADVANCEMENT OF SCIENCE.

EDITORIAL COMMITTEE: S. NEWCOMB, Mathematics; R. S. WOODWARD, Mechanics; E. C. PICKERING, Astronomy; T. C. MENDENHALL, Physics; R. H. THURSTON, Engineering; IRA REMSEN, Chemistry; JOSEPH LE CONTE, Geology; W. M. DAVIS, Physiography; HENRY F. OSBORN, Paleontology; W. K. BROOKS, C. HART MERRIAM, Zoology; S. H. SCUDDER, Entomology; C. E. BESSEY, N. L. BRITTON, Botany; C. S. MINOT, Embryology, Histology; H. P. BOWDITCH, Physiology; J. S. BILLINGS, Hygiene; WILLIAM H. WELCH, Pathology; J. MCKEEN CATTELL, Psychology; J. W. POWELL, Anthropology.

FRIDAY, FEBRUARY 15, 1901.

PHYSICS AND FAITH.\*

## CONTENTS:

<i>Physics and Faith</i> : DR. H. CARRINGTON BOLTON .....	241
<i>The Society for Plant Morphology and Physiology</i> : PROFESSOR W. F. GANONG.....	246
<i>Washington University</i> : CHANCELLOR W. S. CHAPLIN, PROFESSOR EDWARD H. KEISER.....	258
<i>Scientific Books</i> :—	
<i>Boveri Ueber die Natur der Centrosomen</i> : PROFESSOR EDMUND B. WILSON. <i>Moses and Parsons's Mineralogy, Crystallography and Blowpipe Analysis</i> ; <i>Tillman on Minerals and Rocks</i> : C. H. W. <i>Erdmann's Lehrbuch der anorganischen Chemie</i> : PROFESSOR EDWARD RENOUF. <i>Notes</i> .....	264
<i>Societies and Academies</i> :—	
<i>The Geological Society of Washington</i> : DR. F. L. RANSOME, DAVID WHITE. <i>Section of Biology of the New York Academy of Sciences</i> : DR. HENRY E. CRAMPTON. <i>The Academy of Science of St. Louis</i> : PROFESSOR WILLIAM TRELEASE. <i>Science Club of the University of Wisconsin</i> : E. R. MAURER.....	270
<i>Discussion and Correspondence</i> :—	
<i>The Sidgwick Memorial</i> : PROFESSOR J. MARK BALDWIN.....	274
<i>Shorter Articles</i> :—	
<i>Radio-active Minerals</i> : GEO. B. PEGRAM. <i>The Musical Bow in California</i> : ROLAND B. DIXON.	274
<i>Current Notes on Physiography</i> :—	
<i>The Yosemite Valley</i> ; <i>Patagonia</i> : PROFESSOR W. M. DAVIS.....	275
<i>Zoological Notes</i> : C. B. D.....	276
<i>A Bill Establishing a National Observatory</i> .....	276
<i>The Reorganization of the Department of Agriculture</i> .....	277
<i>Scientific Notes and News</i> .....	278
<i>University and Educational News</i> .....	279

Our knowledge concerning the properties of and changes in matter is gained in the first place through our bodily senses, and secondly through the intellect; the primary concepts thus acquired are confirmed, modified and enlarged by operations of the imagination and of the reason. The five senses with which we are endowed are of very unequal value in the acquisition of knowledge of natural objects; smelling, tasting and hearing make but small and unimportant contributions compared with those communicated by the senses of sight and of feeling.

An intelligent being, having only the single sense of feeling, would nevertheless be able to handle a large number of objects within his reach and to study their properties; he would early distinguish between matter at rest and matter in motion; he would notice the properties of inertia and of weight; he would perceive in his person the effects of heat and of cold, of dryness and of moisture; he would become acquainted with the shape of bodies of moderate size and with their superficial properties, such as smoothness or roughness, softness or hardness; he might, if he made sagacious use of his one power, recognize the distinction between matter in its three states—solid, liquid and

MSS. intended for publication and books, etc., intended for review should be sent to the responsible editor, Professor McKee Cattell, Garrison-on-Hudson, N. Y.

\* Address of the retiring President of the Chemical Society of Washington, February 14, 1901.

gaseous, though it would be difficult for him to comprehend their relations to one another. Air in motion makes itself felt, but of gaseous matter in general his knowledge would be very limited and vague. The simplest of tests would make him acquainted with elasticity, malleability and ductility, as well as with density and tenacity; fusibility and solubility would undoubtedly greatly puzzle him, and he would of course remain ignorant of light, of sound and of the physical universe beyond his limited sphere.

If to this being of one sense the so-called 'chemical senses' of taste and of smell were added, he would acquire greater insight into the special qualities of bodies that affect these organs; he would observe the agreeable odors of the natural products of the soil and forest as well as the offensive ones in the three kingdoms of nature; he would learn to differentiate many gases previously regarded as identical; he would learn to distinguish between alkaline and acid, sweet and bitter substances, and to recognize those having particular flavors. On the other hand, the intelligent being of three senses would fail to comprehend the physiological processes by which the sensations are perceived, and in this respect he would be little less ignorant than are beings of five senses.

On endowing this imaginary person with the sense of hearing his knowledge of the external world would be greatly enlarged and his personal comfort increased, he would also acquire a more exact knowledge of some of the properties of matter; he would become conscious of vibrations in the air conveying sounds, and by listening to the roar of a Niagara or to the chirp of a cricket, to the melodies of song birds or to the fierce growl of a beast of prey, he would attain to more lofty ideas of the marvels of nature than in his deaf state. He could now learn of the crackling of brimstone, the 'cry' of

tin, the snapping of electric sparks, and the startling detonations caused by combustion of 'villainous saltpetre' and of certain gaseous mixtures.

If finally, the precious gift of sight should be bestowed upon the subject of four senses a new world would be opened to him, and his intellectual and emotional capacities would be enhanced immeasurably; for the first time he would be able to realize the full meaning of the word beautiful as applied to nature. With the fifth sense he would perceive the beauty of form, of color, of luster, of ornamentation in the flower, the bird, the insect, the floating clouds and in the rainbow; he would have opened to him the magnificent spectacle of a starry firmament, of an aurora and of the sun in its noon-day glory. He would now be fairly equipped for investigating physical science.

At a remote period *seven* senses were attributed to man; these are given by the Hebrew author of the ancient book Ecclesiasticus as seeing, hearing, tasting, feeling, smelling, understanding and speech. They are referred to by the poet Pope in the couplet:

"Good sense which only is the gift of Heaven,  
And though no science, fairly worth the seven,"

and the idea survives in the singular phrase in common use: 'Frightened out of one's seven senses.'

The nature of a sixth sense has been a matter of speculation, but it is hardly less difficult for individuals with five senses to form a conception of an extra sense, than it is for a sightless person to acquire any adequate idea of the true significance of seeing. The sixth sense has been called the muscular sense as distinguished from touch, but we prefer to think of it as a sense for cognizing forms of energy whose seat of action lies in the ether supposed to pervade space.

While it is absolutely impossible for a finite mind to plan the structure of an or-

gan that would give us this power or to conjecture its mode of action, in discussing it, we find it convenient to use terms analogous to those that we employ for the eye. We need, then, a keen sense that will enable us to 'see' what takes place in the interior of masses in their several states of aggregation; to 'see' the arrangement of the atoms within the molecule, and to study their behavior under the influence of the well-known as well as obscure forms of energy. Even as Röntgen rays force a passage through the intermolecular voids of certain kinds of masses, a sixth sense might enable us to 'see' the action of heat in separating the molecules and the influence of chemism in uniting or in parting the atoms within them; to perceive the mechanism of solution, to 'see' the infinitesimal particles of sodium chlorid penetrate the aqueous liquid to form a homogeneous solution. To 'see' the exact manner in which an electrical 'current' (so-called) exerts its separating power when brought to bear upon a liquid; to test whether the theory of ionization has any substantial foundation. A sixth sense might permit us to 'see' the energy manifested by the Hertzian waves which under the skilful management of Marconi are just beginning to serve the interests of man; to learn the secrets of that medium permeating interstellar and intermolecular space which becomes the adjunct of sight; the art of photography has made visible views of the interior of masses impermeable to rays of light and has yielded permanent records of the sound waves of the air, but we seem to need a sixth sense to cognize the operations of the luminiferous ether.

In the fantastic conception in which we have indulged the imaginary being is supposed to be intelligent, for mere sense-perception without the cooperation of the intellect could not augment one's knowledge of the physical universe to any great extent.

Through our bodily senses we learn the existence of natural phenomena, but it is through operations of the intellect that we acquire the deeper knowledge which becomes the subject of imagination, of reason and, eventually, of faith.

After observing that some kinds of matter suffer changes in form, in properties, in potential energy when subjected to the influence of heat, of light, as well as to the action of other kinds of matter, and that certain causes produce uniformly identical results, thinking men made endeavors to explain the phenomena by inventing hypotheses as to the essence of the material objects and of the various kinds of energy acting upon them. In the infancy of learning, Greek philosophers of wonderful intuition conceived a theory of the constitution of matter that has made a lasting impress on physical science; the theory possessed marvelous adaptability, and when a Manchester schoolmaster grafted upon the aged trunk the tender shoot of his genius, it soon grew to be a vigorous branch that bore fruit of unsuspected value. Nearly a century has elapsed and the atomic theory has secured a strong hold upon the minds of physicists and of chemists; maintained by men of sound judgment and great authority, imparted by teachers of recognized ability to successive generations of pupils, it has become a matter of belief, adopted with a few exceptions by scientists throughout the enlightened world, and in their hands it has become a potent factor in the progress of physical science. Yet this theory is purely a figment of the imagination and makes extraordinary assumptions difficult of credence; it supposes that matter is made up of very minute particles, indivisible, indestructible, and unchangeable, separated from one another by void spaces larger than the particles themselves; these diminutive atoms are of definite, uniform and constant figure, and are in perpetual motion in all

conceivable directions at exceedingly high rates of speed; moreover, the atoms composing the different chemical elements are of determinate weights corresponding to their equivalents of combination; these minute particles attract each other with varying degrees of strength and unite in simple ratios to form larger particles called molecules; agglomerations of these molecules constitute masses, visible to the eye and subject to the laws of mechanics.

Faith in this purely intellectual conception has enabled men of genius to refer to it the explanation of many facts, and the hypotheses resulting have developed into laws of prime importance in chemical philosophy; Dalton discovered facts in the union of chemical bodies whose interpretation he found in the doctrine of atoms; Humboldt and Gay-Lussac reinforced the Daltonian laws by their labors on the ratios in which the volumes of gases combine; Avogadro, by purely physical researches established the relation between the volumes of gases and the number of their constituent molecules; and Gerhardt, working in the field of organic chemistry, observed the bearing of these discoveries on chemical philosophy and, by clearly establishing the distinction between atom and molecule, gave to the atomic theory its modern aspects.

Faith in this theory has made it possible to devise a scheme of notation that in spite of its defects has proved of great utility in promoting the advancement of chemistry; the multitudinous problems of stoichiometry, the modern theories of solution and of electrolysis, the doctrines of isomerism and of stereo-chemistry are achievements of the intellect and of the reason based upon a belief in an imaginary condition of matter. To crown the whole, Newlands, the Englishman, originated, Meyer, the German, and Mendeléeff, the Russian, brought to a high state of perfection, the Periodic law which has given to chemistry that prophetic power,

long regarded as the peculiar dignity of its sister science, astronomy.

Quite apart from these abstract principles, based upon a belief in the atomic constitution of matter, is the practical side of the question, of which the analytical chemist avails himself in determining the value of substances submitted to him; on the results of his figures thousands of dollars may change hands in the manufacturing, mining and commercial world. A ship-load of material is bought and sold on the result of the analysis of a sample conducted by a chemist, who bases his procedure on the supposed numerical relations of the invisible, intangible, immeasurable particles he calls atoms and in his calculations he relies on the constants determined by others, in whom he has confidence, and the accuracy of which constants he has to accept on faith. Reliance on the *dicta* and *data* of investigators whose very names may be unknown lies at the very foundation of physical science, and without this faith in authority the structure would fall to the ground; not the blind faith in authority of the unreasoning kind that prevailed in the middle ages, but a rational belief in the concurrent testimony of individuals who have recorded the results of their experiments and observations, and whose statements can be verified.

This faith in the fundamental principles of physical science persists notwithstanding it encounters insurmountable difficulties. Many problems defy the efforts of materialistic philosophers to solve them; the origin of matter and of motion; the initial source of energy as well as the relation of gravitation to other forces; the positive nature of the interstellar ether imagined as a vehicle for the transmission of light, not to mention proofs of its existence; the true inwardness of actinism, of Röntgenism, and of the rays named after Becquerel; the ultimate identity in es-

sence of the so-called elementary bodies. Some of these problems will undoubtedly be solved as knowledge of the material world increases, but others are destined to remain inscrutable to finite minds and as such may be called scientific 'mysteries.' We can construct ingenious arguments based largely on assumptions, and reason ourselves into the notion that our hypotheses explain the questions at issue, but after all we know very little beyond the effects observed.

These problems arise in every department of organized knowledge; the student of chemistry does not have to look far afield to encounter mysteries, though he does not commonly so style them; phenomena of ordinary experience challenge the interpretation of philosophers. What do we actually know of the chemical force called affinity? Who can tell why the attraction between A and B is so much stronger than between A and C, or why one element forces another out of its combination with a third? What chemist who has watched under the microscope the beautiful, symmetrical manner in which minute particles of a substance separating in solid form from solution, arrange themselves in geometrical figures obeying well established mathematical laws, can pretend to explain the cause of the astounding behavior of the inert, lifeless matter?

But I desist from propounding further queries, the answers to which are buried in impenetrable mystery. A student of elementary chemistry, impressed with the ability of the teacher to explain natural phenomena, asked him: 'Professor, why is gold yellow?' Whereupon the professor, waiving the customary explanation [?], reverently answered: 'Because God made it so!'

Is it unfair to scientists to say that they sometimes take refuge in obscure language to veil their ignorance? It may help our

imagination to affirm that carbon and other elements occur in 'allotropic' forms, but does this statement adequately explain the phenomenon? To term the peculiar action of certain bodies, which themselves suffer no change while they effect decompositions or combinations in others with which they are brought in contact, as 'catalytic' may be soothing to the mind, but is it scientific? Is it satisfactory? One hundred and fifty years ago the properties of water were said to be caused by its 'aquosity'!

In this study we have confined our illustrations to the physical and chemical branches of science, but they might well be drawn from astronomy and from the biological sciences; in the former, one becomes acquainted with

"Realms yet unrevealed to human sight,"

as well as with the conception of infinity in space and in time; in the latter, one encounters the unfathomable mystery of the origin of life. It is evident that in pursuing any branch of knowledge the seeker has opportunities of familiarizing himself with ideas contained in the phrases, 'invisible world,' 'infinity,' 'mystery,' and with facts that require application of all the powers of the imagination and of reason, to grasp which he exercises faith.

Most scientists having this mental training, in which acts of faith are demanded at every step, find it natural to apply this faith to their hypostasis of the spiritual world; they thus acquire belief in an inscrutable Divine Being, who exercises almighty wisdom and power in the guidance of the material universe, and who has made Himself known to humanity by revelation. To such persons it does not seem more difficult to believe in spiritual force and its influence on mankind, than to believe in the existence of energy and its effects on matter. Huxley, who certainly can not be accused of religious bias, is said to have

remarked: "The doctrine of the immortality of the soul is not so wonderful as that of the conservation of energy or of the indestructibility of matter."

The evidence of the existence of spirit is precisely analogous to the evidence for matter; matter, as we have seen, is revealed to us only as its phenomena, extension, weight, color, behavior when subjected to heat, etc., affect our senses; of its essence we know nothing; spirit, likewise, is revealed to our consciousness through its powers of thinking, feeling and willing, but of the essential spirit the finite mind knows nothing. "Matter," writes an American scientist, "is the thing perceived, spirit the thing perceiving, matter is the passive, spirit the active principle. Without a belief in spirit, therefore, not only can there be no religion, no virtue, but there can be no philosophy or science. \* \* \* The very origin of our notion of force is the consciousness of our own mental energy, and this universal energy of Nature is an effluence of the Divine Being."

Faith, both in science and in religion, is belief based on suitable evidence from sources outside of personal experience, both are fruitful in different ways, the former affecting the intellect and the latter the heart of man; scientific faith bears fruit in the steamship and in the telegraph, Christian faith in works of mercy and charity and in a life of love shown toward mankind and to God; it is

"The subtle chain  
That binds us to the Infinite."

On the other hand, some students of science, accustomed to exercise faith in their attempts to solve obscure problems in the material world, hesitate (and a few refuse) to extend this intellectual power to the spiritual universe; this is undoubtedly due to the operation of the will, for

"A man along that road is led  
Which he himself desires to tread."

The supreme goal of the student of science was admirably conceived and expressed in a single sentence by the renowned Kepler, when he wrote nearly three centuries ago:

"The scientist's highest privilege is to know the mind and to think the thoughts of GOD!"

H. CARRINGTON BOLTON.  
WASHINGTON, D. C.

*THE SOCIETY FOR PLANT MORPHOLOGY  
AND PHYSIOLOGY.*

The Society met, together with the American Society of Naturalists and the Affiliated Societies, at Johns Hopkins Medical School, Baltimore, Md., December 27-28, 1900, under the presidency of Professor D. P. Penhallow. There was a large attendance of members, and the meeting was in all ways profitable and successful. The presidential address dealt with 'A Decade of North American Paleobotany'; it was published in this Journal for February 1st. The most important business of general interest was the presentation of the report of the Committee (Messrs. Farlow, MacDougal and von Schrenk) appointed to consider methods of securing improvements in reviews of current botanical literature. Copies of the report were distributed to members present, and have been sent to other botanists throughout the country. It shows a completely successful result of the Committee's work, and comments upon it will appear later in this Journal. A committee was also appointed (consisting of Messrs. Ganong, Lloyd and Atkinson), to take into consideration the formulation of a standard college entrance option in botany. On Saturday, December 29th, the members of the Society, with guests, made an excursion to Washington, where they were shown the work of the Department of Agriculture, and were received by the Honorable Secretary for Agriculture,

who made a brief informal address. Later they were entertained at luncheon by the botanists resident in Washington. The following new members were elected: M. A. Carleton, Department of Agriculture, Washington, D. C.; F. D. Chester, Delaware Agricultural College, Newark, Del.; E. B. Copeland, University of West Virginia, Morgantown, W. Va.; T. H. Kearney, Department of Agriculture, Washington, D. C.; J. W. Toumey, Yale Forest School, New Haven, Conn. Officers for the ensuing year were elected as follows: *President*, Erwin F. Smith; *Vice-Presidents*, F. C. Newcombe and L. M. Underwood; *Secretary*, W. F. Ganong. The following papers were presented, the abstracts of which in most cases have been furnished by the authors:

*Notes upon Albinism in Sweet Corn:* PROFESSOR BYRON D. HALSTED, Rutgers College.

Complete albinism has been found in a sweet corn cross between 'black Mexican' and 'Egyptian' after the second year. The tests show that the albinos come from the white, pink and purple grains in about equal numbers and in some instances fifteen per cent. are white plants. These albinos have the normal vigor and in every way adhere to the type, except in the lack of a capacity to produce chlorophyll. They begin to lag behind their green mates after two weeks and perish a fortnight later. In the dark they grow like the normal plants, except that no etiolin is produced. A large number of seeds, germinated under unfavorable conditions, were not influenced in the percentage of albinos, and it seems quite certain that the albinism is acquired before the tests were made. Some ears in the lot of crossed corn produced no white plants, while others show many, and it seems to be a fact that grains from overburdened plants, *e. g.*, where there are three large ears, are more apt to produce albinos than

those from stalks with a single ear. The cross may have been such that the last act in the drama of perfect seed-production was not reached. Again, the close breeding of the crossed grains, all plants in the plot being of the same mother and with no pollen from other plots, may have had its effect in the manner mentioned.

*A Disease of the Locust:* DR. HERMANN VON SCHRENK, Shaw School of Botany.

A destructive disease of the black locust (*Robinia Pseudacacia*), due to *Polyporus rimosus*, was described. The fungus destroys the heart wood of this tree, leaving a soft, yellow mass. The fruiting organs form on the trunk and larger branches for many years, discharging their spores in the summer and fall. Attention was called to the fact that the mycelium grows only in the heart wood of living trees, and dies as soon as a tree is cut down. This is probably due to changed conditions of aëration, moisture and temperature. This fungus must be considered as a special class of saprophyte.

*Observations on the Mosaic Disease of Tobacco:*

MR. ALBERT F. WOODS, Department of Agriculture.

The author presented the results of numerous experiments showing that the mosaic disease of tobacco may be artificially produced in the following ways: (1) By cutting plants back during any stage of active growth, thus removing most of the reserve organic foods and stimulating rapid growth of lateral buds in the absence of sufficient albuminoid reserve. This causes a remarkable increase in the activity of oxidizing enzymes. These enzymes inhibit the action of the translocation diastase of the cells, thus preventing the movement and assimilation of starch. When a plant once reaches this stage it seldom recovers, all new growth becoming diseased. He was able to produce the same disease in

the same way, in tomato, potato, petunia, phytolacca, violet and other plants. (2) The disease may be reduced by repotting or transplanting a plant in active growth, thus stimulating a rapid root development. New leaves that form at this time often come diseased. Leaves that form at the time of the development of the flowers also often come diseased, as do also rapidly developing suckers. The pathological changes are the same in these cases as when the disease is produced by cutting back. (3) The disease may be produced by injecting the sterile juice of diseased plants into the growing bud or by pouring it on the roots. Peroxidase obtained from healthy or diseased plants and injected into the bud or poured on the roots may also cause the disease. The author concludes as follows: "The evidence which I have collected, taken along with that obtained by other workers, especially Mayer and Beijerinck, is therefore very strongly in favor of the infectious nature of the trouble under certain conditions. The matter can not, however, be considered as settled. So far as the evidence at hand goes, it appears that in growing cells there is possibly a definite relation between active oxidizing power, through the medium of oxidizing enzymes, and the availability of reserve food to the growing cells. It appears that this balance between the oxidizing enzymes and the availability of reserve foods can be broken by removing, on the one hand, the supply of reserve foods, in any way during growth, in which case the enzyme content of the cell is increased from two to four times the normal activity. This removal of reserve food may be either the result of diversion to other parts of the plant or of direct removal, as in the case of cutting back or of sucking insects, and possibly also can be brought about by other conditions not at present understood. On the other hand, the most remarkable thing is that the in-

roduction of the enzyme in question (peroxidase) sets up the same series of pathological changes as is brought about by the removal of reserve food, namely, the increase of the normal enzyme of the cell, and the decrease of availability of reserve foods. When this pathological condition is reached it is very difficult for the plant to correct the trouble. The peroxidase probably moves from one part of the plant to another, though how much of the general spread of the disease in the plant is due to such movement has not been determined. The evidence of the communicability of this disease is quite as strong, if not stronger, than that upon which rests the belief in the communicability of ordinary variegation through grafting on healthy plants. The two groups of diseases are at least very closely related and are probably simply different phases of the same malady. Possibly peach yellows and the California vine disease belong here also and are to be similarly explained. Die-back of the orange may also belong here.

The paper was illustrated by two colored-plates and four half-tones, and will be printed as a bulletin of the U. S. Department of Agriculture.

*Report of the Committee appointed to consider Methods of securing Improvements in Reviews of Current Botanical Literature:* Presented by the Chairman, PROFESSOR W. G. FARLOW, Harvard University.

This report has already been referred to, and a further account of it will be found in a later number of this Journal.

*The Cause of the Red-brown Color in certain Cyanophyceae:* DR. G. T. MOORE, Dartmouth College.

The various theories which have attempted to explain the cause of the red-brown color in *Anabaena*, *Gloiothrichia*, *Oscillatoria* and other so-called 'blue-green algae,' were discussed. It was shown that this



color could not be due to sulphur granules, as has been supposed,—neither was it possible to demonstrate any definite coloring matter within the cell itself. Numerous experiments with *Oscillatoria prolifica*, Gorn., a plant particularly favorable for study, showed that the red color must be caused by the refraction due to the presence of large numbers of gas vacuoles, as suggested by Klehban. The effect of a large number of reagents, spectroscopical analysis and the examination of microtome sections, all strengthened this theory. As far as could be determined the enclosed gas seemed to be nitrogen. It would seem that the buoyancy common to so many Cyanophyceae, is particularly due to the presence of these vacuoles, for in material of the normal blue-green color the plants remained at the bottom of the dish, while those containing vacuoles and consequently of a red-brown appearance, always floated upon the surface.

*Improved Methods for obtaining Pure Cultures of Fresh-water Algae:* DR. G. T. MOORE, Dartmouth College.

The results of some methods for obtaining pure cultures of algae, by the modification of the nutrient medium, were shown. It was found that algae might be separated from contaminating forms by a very slight modification of the salts upon which they are grown. Luxuriant growths of Cyanophyceae were obtained upon a decoction of *Zamia*, with the addition of peptone and sugar. It required less than one-half the time for algae grown on this medium to nearly double the growth of those on mineral salt solutions. The possibility of using heat in separating blue-green algae from grass-green forms was also referred to.

*A Second Preliminary Report on Plant Diseases in the United States due to Rhizoctonia:* DR. BENJAMIN M. DUGGAR, Cornell University and MR. F. C. STEWART, New York Experiment Station.

This report presented notes upon the occurrence and destructiveness of American forms of *Rhizoctonia* observed by the authors. Since the first report (presented to this Society in 1898), the occurrence of *Rhizoctonia* on some entirely new hosts has been observed, and also upon other hosts new to America. As principal host plants among vegetables may be mentioned bean, sugar-beet, cabbage and cauliflower, carrot, celery, cotton, lettuce, potato, radish and rhubarb; and among flowers, asparagus, china aster, carnation, coreopsis, sweet william and violet; also about ten other less important hosts. In many cases the *Rhizoctonia* is truly parasitic and undoubtedly the cause of the disease in question, as has been abundantly proved by experiment; but in other cases inoculation experiments are yet lacking. Morphological studies and extensive inoculation experiments are in progress to determine more carefully the physiology of the forms and the limitations of species.

*The Bacterial Diseases of Plants:* DR. ERWIN F. SMITH, Department of Agriculture.

This consisted of a stereopticon lecture before a joint meeting of the Society for Plant Morphology and Physiology and the Society of American Bacteriologists. Three diseases were described, namely, the wilt of cucurbits due to *Bacillus tracheiphilus*, the brown rot of solanaceous plants due to *Bacillus solanacearum*, and the black rot of cruciferous plants due to *Pseudomonas campestris*. Fifty-eight slides made from the author's clear and beautiful photographs and photomicrographs were exhibited, showing symptoms, location of the bacteria in the tissues, etc. Many of these illustrations will be published in the near future in *Centralblatt für Bakteriologie*, 2te Abteilung.

*Notes on the Life History of certain Uredineae:* M. A. CARLETON, Department of Agriculture. (By invitation.)

Four species of rust fungi were investigated. In the case of *Uromyces euphorbiae* Cooke & Peck, the well-known rust of *Euphorbia*, it was demonstrated by three separate series of experiments that the rust is able to propagate itself constantly through the germinating seed of its host, and therefore becomes in that way practically a perennial species. It is the only demonstrated example of this manner of propagation in the whole order of Uredineae. Actual cluster cups may be seen in the hulled seeds of *Euphorbia dentata*. Seedlings kept under bell jars become rusted three months from the date of planting, showing all stages of the rust, while seeds disinfected with mercuric chloride produce no rusted plants.

Culture experiments were also performed with the common sunflower rust, which showed that the *Puccinia* and *Aecidium* found on sunflower are stages of one and the same species. At the same time it is made probable that all the species of *Helianthus* affected bear the same rust and that there is no distinction of host forms. The peculiar, thick-walled, one-celled spores of *Puccinia vexans* Farl., have at last been successfully germinated after repeated failures, and it is now seen that these spores are neither properly uredospores nor teliospores, but partake of the nature of both. They make up a distinct new spore form for this order of fungi, and may be called *amphispores*. True uredospores were also found and germinated. Other experiments and observations have shown that *Aecidium tuberculatum* Ell. & Kell. is commonly a perennial species in its perennial host *Callirhoe involucrata*, producing spores able to germinate during the coldest winters.

*Rheotropism of Roots:* PROFESSOR FREDERICK C. NEWCOMBE, University of Michigan.

The phenomenon of rheotropism is manifested by a curvature of the root when growing in streaming water. In all cases so far

observed the response has been positive, *i. e.*, the root-tip curves against the stream. The present research has included 32 species of plants, of which 15 have shown themselves rheotropic and 17 insensitive. Nearly related plants behave similarly; but of two genera of the same family, one may respond to the current of water, and the other may be insensitive. Species differ greatly in degree of response. Members of the *Cruciferae* are among the most sensitive plants found, their roots often attaining an angle of 90° from the vertical.

The velocity of current calling forth the best response lies between 100 cm. and 500 cm. per minute. A velocity of 2,000 cm. per minute will in most plants bring a mechanically negative curve, and the responses in currents less than 100 cm. per minute are weak and transitory. However, a velocity as low as one cm. per minute will bring a curvature in the majority of roots of the garden radish.

The latent period at the optimum temperature for growth is one hour or more.

The area which perceives the stimulus includes the apex of the root and the elongating zone.

Roots of mature plants as well as those of seedlings are responsive.

The author four years ago suggested that the stimulus might really be referred to the one-sided pressure of the water upon the root. Considerable evidence is now offered to confirm this view.

*Thigmotropism of Roots:* PROFESSOR FREDERICK C. NEWCOMBE, University of Michigan.

Only two authors have claimed for ordinary roots the presence of sensitiveness to contact or pressure. Darwin believed he had found a negative response (a turning away), when the sloping side of the root apex touched a foreign body; and Sachs in a single and simple experiment found some

roots bending positively when a pin or a thin wooden rod was brought against the root 2 to 4 mm. back from the apex. Wiesner and others have shown Darwin to be mistaken, and the author of the paper here abstracted has repeated Sachs' tests many times without convincing results.

That roots are, however, responsive to pressure on the elongating zone can be shown by two kinds of experiments. Seedlings of buckwheat or radish are placed upright with their roots immersed in water, and a loop of very thin rice paper attached to a light pendulum is made to pull lightly on the elongating zone. Not more than half the roots bend, but all that do curve become concave on the side pressed by the paper. A better method is employed when gravitation is neutralized by revolving the seedlings in a vertical plane by the use of a klinostat. In this experiment the seedlings are supported in a damp chamber while their elongating zone rests lightly on a fixed glass rod. In sensitive roots, the tip of the root curves partially around the glass rod as growth goes on. These experiments show that some species respond and some do not respond to pressure. As far as the study has been carried, roots which are rheotropic are also thigmotropic. This agreement is strong evidence for the view that rheotropism is really thigmotropism. Neither rheotropism nor thigmotropism would seem to be of biological import to the plant. The response may be of the same class of phenomena as shown by tendrils when in contact with a solid object.

*The Effect of Mechanical Shock on Longitudinal Growth of Plant Organs:* DR. JAS. B. POLLOCK, University of Michigan.

The plant organs used were hyphæ of *Phycomyces*, hypocotyls of *Brassica*, *Raphanus*, *Helianthus*, *Lupinus*, and *Cucurbita*, the epicotyl of *Phaseolus*, and the leaf sheath and first leaves of *Avena* and *Triticum*.

Single shocks were given by pressure (*Phycomyces*) as by forcibly bending from side to side.

In *Phycomyces* there was a retardation after pressure, then a recovery in 5-30 minutes, usually in about 10 minutes, and the growth was then sometimes faster and sometimes slower than at first.

On bending, the larger plants first elongated considerably, were then retarded for a short time and recovered in 20-50 minutes, so they grew at a fairly constant rate, this rate being sometimes greater, sometimes less than at first.

Continuous shock was produced by several pieces of apparatus worked by electricity, water motor or clockwork, and was either a swaying from side to side or a jolting upon a board hinged at the middle.

The results were very decisive only in the case of *Cucurbita*, and showed a decided acceleration, due perhaps to the swaying from side to side. With all the other plants used the results were quite variable, but, taken as a whole, give evidence of acceleration as the result of not too vigorous swaying from side to side.

*The Limits of Variation in Plants:* DR. JOHN W. HARSHBERGER, University of Pennsylvania.

The study of the limits of variations in plants was undertaken as in part a contribution to the problem of species. It was stated, as a well-known fact, that more plants are produced than can survive, necessitating the destruction of many, and the survival of those that have fitted themselves by certain aptitudes to do so. As in part an answer to the evolutionary difficulty of small or initial variations, a careful statistical inquiry was made by comparative measurements of various plant parts. It was found, that the size and shape of leaves, the weight and size of fruits varied by mathematically ascertainable quantities. These

were determined for a number of plants and tabulated. It was discovered that in *Liriodendron tulipifera*, *Sanguinaria Canadensis*, *Ailanthus glandulosus* variations in the size and configuration of the leaves were in part due to the persistence of juvenile forms, to the arrested development of some leaves, and to their evolution and transformation to higher forms. The amount of these differences was ascertained, contrasted and tabulated. In conclusion, it was stated that these changes are in most cases due to two causes, viz., the internal hereditary impulse determining, as in *Ailanthus glandulosus*, the asymmetry of the lateral, paired, leaflets, and to the direct, environmental influence, fitting the leaf to utilize the space at its disposal, thus enabling it to present the largest amount of leaf surface to light action.

*Critical Points in the Relation of Light to Plants:*

PROFESSOR D. T. MACDOUGAL, New York Botanical Garden.

The following statements, upon the basis of accepted facts, may be made as to the influence of light upon plants:

1. Light exercises a direct chemical effect upon the substances of which protoplasm is composed.
2. It stimulates protoplasm to the formation of chlorophyll, although its action is not necessary to the process, and its direct chemical effect disintegrates this substance.
3. It constitutes a source of energy, which is absorbed by the chloroplasts.
4. Absence of light constitutes a specific stimulus, calling out the various reactions of etiolation.
5. Light acts as a directive or orienting stimulus to which the plant responds by locomotory or bending movements.
6. Different portions of the spectrum are operative in producing these separate effects.

If an examination is made of the facts

upon which these generalizations rest, with reference to the current conceptions of phototonus, paratonic influence of light, maximum, minimum and optimum, it will be found that illumination is not necessary to the motility of protoplasm, and conversely that deprivation of light does not induce a condition of rigor, but sets up various pathological phenomena, among which is the breaking down of chlorophyll.

Light does not exert a paratonic or retarding effect upon growth. Its chemical action may hinder the accumulation of somatic material however. The altered development of plants in darkness is an adaptive response which has for its purpose the elevation of the chlorophyll screen and reproductive bodies.

Chemical, photosynthetic and phototropic maxima, minima and optima are so widely separated that phototonus as a term to designate the condition of a plant when acted upon by light of an optimum intensity, or of an intensity between the maxima and minima, is useless and untenable, as are also light optimum, maximum and minimum when applied in generality to the light relations of the plant.

*Propagation of Lysimachia terrestris:* PROFESSOR D. T. MACDOUGAL, New York Botanical Garden.

The development of the secondary and tertiary branches of the stems of *Lysimachia terrestris* is arrested by condition unfavorable to seed formation, and these branches assume the form of short cylindrical organs less than 1.5 cm. long without epidermal openings, and consisting of 3 to 5 internodes. The stele shows only protoxylem and protoxylem. These bulbils fall to the ground and may survive under the cover of dead leaves to reproduce the plant in the next season. The bulbil completes its development as a rhizome and does not perish, as in most cases of bulbs and bulbils. Bul-

bils are quickly killed by desiccation and freezing temperatures.

*Seedlings of Arisæma*: PROFESSOR D. T. MACDOUGAL, New York Botanical Garden.

The seedlings of *Arisæma Dracontium* generally do not develop the plumule. The cotyledon pushes down into the soil carrying the hypocotyl, the base of which enlarges to form a bulb, in which is stored the reserve material withdrawn from the seed and not used. In a few instances, however, a single small leaf is developed; usually this does not take place until the second season of activity or the third season of existence of the seed. Similar saptrophytism is exhibited by the seedlings of *Arum maculatum* which never develop the plumule until the second year of growth.

*The Insular Flora of Mississippi and Louisiana*:

PROFESSOR FRANCIS E. LLOYD, Teachers College, and PROFESSOR S. M. TRACY, Biloxi, Miss.

The paper deals with the climate, physiography and the vegetation of the Mississippi Sound Islands and Delta, and is especially concerned with a comparison of the ecological conditions in this region and that recently studied by Kearney, namely, Ocracoke. The results show for the former a longer growing season, more favorable wind conditions and a greater amount of sunshine.

The islands of the Delta region are of three kinds, the sand islands, the muck-marsh islands and the mud-lumps.

These islands have a strand vegetation of which four formations are recognizable, viz., the beach, sand plain, dune and salt marsh formations.

The beach formation contains succulent annuals of a halophytic character such as *Sueda linearis*, *Salsola kali* and *Sesuvium portulacastrum*, and in its upper zone some tropical strand plants such as *Ipomœa pes-capræ*, *I. acetosæfolia* (two prostrate leaf-succulent

morning-glories), and rarely *Canavalia obtusifolia*. The back beach plants are chiefly grasses, of which *Panicum amarum*, common along the north Atlantic Coast, and *Uniola paniculata*, a more southern strand plant, are the leading elements.

The sand plain contains succulent perennials as well as annuals, of prostrate and caespitose habit. The most striking plants of the sand plain are *Iva imbricata* and *Serenoa serrulata*, a prostrate palmetto, both of which build a pedestal dune.

The dune formation has two leading associations. One of these is the thicket (*Ilex-Myrica*) association inhabiting small established dunes which support a plentiful herbaceous undergrowth. The larger dunes are inhabited by *Serenoa serrulata*, *Rhus copalina* and several grasses. These dunes may attain a height of twenty meters and in their leeward march may bury the trees in their path.

The salt-marsh associations of chief interest are those of the muck-marshes. Two such are to be seen, namely the *Batis-Salicornia* association composed of leaf and stem succulents, and the grass association of which *Spartina* (two species) is the leading type. On the muck-marsh is sometimes superposed a water-moved shell dune composed of shell fragments and supporting a vegetation of annual and perennial plants of less marked halophytic character.

*Some Problems connected with Fertilization in Plants*: Lecture by PROFESSOR G. F. ATKINSON, Cornell University. (Illustrated by stereopticon.)

Professor Atkinson discussed recent advances which have been made in the study of fertilization in plants and their significance, and pointed out the problems still awaiting solution.

*The Morphology of the Fruit of Opuntia*: PROFESSOR J. W. TOUMÉY, Yale University. (By invitation.)

Primarily the function of fruits is seed production, secondarily protection of seeds and aid in their dissemination. The fruit of the *Opuntia* does not deviate from this general law; although, in many instances, it has developed special adaptations. Under their desert environments, with many species, the germination of seeds and development of seedlings are rarely attained, the dependence for reproduction being almost entirely upon vegetal dissemination. In *Opuntia fulgida* the fruit is mostly sterile, but is particularly adapted to aid in the dissemination of the tumid spine-covered terminal joints, as these joints become attached to animals that feed upon the spineless fruit and thus become scattered by them. In this special case the function of the fruit is no longer to produce seeds, but to entice animals to the plant that the fragile, terminal branches may adhere to them and become disseminated. As before stated, the fruit is frequently sterile. In some instances, however, we find clusters of spineless, short, proliferous joints which resemble the fruits externally, but are entirely without evidences of even an abortive ovary. These proliferous clusters of spineless stems, in the economy of the plant, serve the same purpose as the fruit clusters and without the necessity of floral development, which would be a useless waste of energy on the part of the plant.

*Notes on Long Island Pine Barrens:* DR. HERMANN VON SCHRENK, Shaw School of Botany.

Photographs were exhibited illustrating the manner in which young trees of *Pinus resinosa* form basal shoots after the tops have been killed by fire. Some trees do this four years in succession, showing an unusual vitality in the root system. The effect of repeated fires on the barrens was discussed, and it was pointed out that a

gradual degeneration of the forest is very marked.

*Suggestions for an Attempt to secure a Standard College Entrance Option in Botany:* PROFESSOR W. F. GANONG, Smith College.

The author pointed out the advantage to any science of the interest taken in its teaching by experts and scientific societies. The increasing use of botany as a college entrance option is emphasizing the lack of differentiation and definiteness in the secondary teaching of the science, as well as the diversity of requirement through which a great burden is placed upon those preparatory schools which fit students for a number of colleges. A summary is given of the requirements made in this subject by leading colleges. The history of the efforts to secure the formulation of a widely acceptable standard preparatory course was traced, culminating in the 'Report of the Committee of the National Educational Association in 1899.' The reasons why the latter is not more widely adopted were traced, and suggestions made as to the characteristics of a course likely to be more generally accepted. It was recommended that a committee be appointed to take the subject into consideration, and to endeavor to secure the formulation and adoption of such a course. This committee was appointed, as already mentioned in the introduction to this article.

*Further Notes on Spermatogenesis of Zamia:* DR. HERBERT J. WEBBER, Department of Agriculture.

The mature pollen grain of *Zamia* was found to contain two well-marked prothallial cells, and besides these a dark, refractive slit could frequently be observed in the wall of the pollen grain, at the base of the other prothallial cells, indicating that the first prothallial cell cut off becomes oppressed and largely resorbed during the development of the pollen grain as in *Ginkgo*.

These cells the writer referred to as the first, second and third prothallial cells, in the order of their formation.

During the development of the pollen tube and prothallial apparatus in the nucellar tissue after pollination, the second prothallial cell crowds out into the third prothallial cell which meanwhile retains its original point of attachment and comes to surround the second prothallial cell like a root-cap. When the third prothallial cell divides to form the stalk cell and central cell (Körper cell, generative cell), the spindle is formed diagonally in the cell, the nucleus of the forming stalk cell being crowded to one side by the intruding second prothallial cell. When the stalk cell is cut off by the completion of the division, it appears nearly cylindrical and completely surrounds the second prothallial cell except at the base, where both cells retain their original attachment. This same structure and development have been found by the writer to occur in *Ginkgo* also, and while in *Ginkgo* the division of the third prothallial cell has not been observed, the writer thinks there can be no doubt that the development is the same as in *Zamia*. This interpretation, it should be added, is totally different from that described by Ikeno and Hirase as occurring in *Cycas* and *Ginkgo*, but neither of these investigators observed the division of the third prothallial cell.

During the development of the apical end of the pollen tube in the tissue of the nucellus, the vegetative nucleus passes into the tube and during the growth of the latter remains near its apex. When the proximal end of the tube (the pollen grain end) begins to grow down toward the archegonia, shortly preceding fecundation, the vegetative nucleus travels back through the entire length of the tube, two or three millimeters, and takes position in the proximal end of the tube near the central cell. This change of position suggests that the nucleus

governs and directs growth, and changes its location in the cell in order to be nearest to the point of most active growth, a factor emphasized by Haberlandt in his 'Function und Lage des Zellkernes.'

*Notes on the Spermatozooids of Ginkgo:* ERNST A. BESSEY, Department of Agriculture. (By invitation.)

In Washington the spermatozooids of *Ginkgo* are developed between August 25th and September 10th, as extremes, the most favorable time for finding them being September 1st to 3d. They are developed in the night or early morning. They are about  $105 \times 75-82 \mu$  in size, with nucleus  $71-75 \mu$ . The nucleolus is  $7.5 \mu$  in diameter. The cilia are about  $15 \mu$  long. There are three turns in the spiral band which bears the cilia. The spermatozoid has no tail such as Hirase described, the latter's observation being probably on injured specimens, as Fujii has recently pointed out.

The ciliar motions are the regular tremulous motions of the cilia and also a series of waves passing from the apex to the base of the spiral. The body of the spermatozoid is very movable, especially the ciliferous portion, twisting, bending, elongating and contracting very remarkably. At the base of the cell, exactly opposite the apex of the spiral, there is a trembling motion apparently coincident with, and connected with the movement of the cilia. Its significance has not been determined.

*Spherites and Sphere Crystals and their Relation to Plant Structures:* DR. HENRY KRAEMER, Philadelphia College of Pharmacy.

On the basis of their physical properties the author has grouped the substances making up the contents and walls of plant cells into (1) the cell liquids or cell fluids; (2) sphere crystals; and (3) spherites. The cell liquids include the organized contents of the cell and a portion of the unorganized contents as cell sap. The sphere

crystals are spherical aggregates of crystals with sharp angular contours, which are made up of but one substance and include various calcium salts, alkaloids, glucosides, etc.

The spherites resemble somewhat the sphere crystals, but are distinguished from them by the fact that the molecule is complex and the individual crystals have either a somewhat rounded outline or are imbedded in colloidal substances in which the crystalline or crystalloidal character is more or less obscured and hence with difficulty discerned. These include inulin, starch and the principal substances entering into the composition of the cell wall. The spherites are further distinguished from the sphere crystals in that they are capable of taking up or holding certain coloring principals as safranin, gentian, violet, etc.

The mode of formation of spherites and sphere crystals appears to be the same whether observed in nature or as carried out artificially by crystallization of salts from solutions or by precipitation, and hence the conclusion is reached that there is a play of similar forces in their formation.

An examination of the crystal masses remaining in watch crystals after the spontaneous evaporation of various substances under varying conditions, shows not only the formation of crystals which resemble those produced in the plant cell, but other rather striking forms of combination which are very suggestive indeed. Indeed the arrangement of the crystals in such a watch crystal reminds one of the appearance of our woods, at this season of the year, when the absence of leaves permits the observance of the fundamental lines of development in shrubs and trees.

*The Cardinal Principles of Morphology:* PROFESSOR W. F. GANONG, Smith College.

Although in most of its phases botany is

making remarkable advances in America, it is still in one respect very backward, namely, in the morphology of the higher plants. Not only is little research being carried on in this direction, but it is still treated, particularly in its teaching, in the old formal idealistic manner, with little of the modern realistic spirit which the research of the past quarter century has infused into it elsewhere. The characteristics of the two systems, which differ less in fact than in point of view, are contrasted, and the attempt made to reduce these characteristics to definite named principles. Of these principles the author recognizes seven, in five of which the two systems do not differ materially, but in the other two they differ greatly. These are, the principle of metamorphosis by transformation or alteration as contrasted with metamorphosis by differentiation, a principle which is fundamental with the modern school of morphologists of which Goebel is the leader, and the principle of the existence of degrees of morphological rank culminating in morphological independence to which any part may attain. On this principle any part may become a center of variation and modification, and hence a true morphological member, and the number of members is not limited to three or four for the higher plant, as generally taught by us, but is indefinite.

*Relation of Water-plants to the Solid Substratum:*

R. H. POND, Maryland Agricultural College. (By invitation.)

Many of our well known text-books contain the statement that the roots of water plants serve for attachment only; that the function of absorption is unnecessary because transpiration is absent and the plant is bathed in a nutrient solution.

The evidence now at hand seems to require a modification of this statement. Six of our common and widely distributed



aquatic species have been investigated. The results in general are:

1. Plants rooted in soil exceed in vegetation and dry weight plants rooted in sand or merely suspended.

2. Plants rooted in sand or merely suspended contain starch, calcium and magnesium in excess, while they are lacking in nitrogen, potash and phosphoric acid.

3. Lithium nitrate is absorbed by the roots and conducted to the upper portions of the plant where it may be detected with the spectroscope.

4. A volumetric measurement of root absorption has been made.

The work which has yielded these results has been done by the author while a special assistant to the U. S. Commission of Fish and Fisheries.

*Positive Geotropism in the Hypocotyl:* PROFESSOR E. B. COPELAND, University of West Virginia. (By invitation.)

The curve by which the primary root is bent downward if it emerges from the seed in any other direction is usually executed in the hypocotyl. By decapitation experiments and by a careful study of the location of the curving region, with reference to the growing tip, it is shown that the stimulus causing this curve is received by the root tip. To distinguish between the parts played by the root tip and the hypocotyl Czapek's terminology is adopted, the latter being geotropic, the former, geoaesthetic. The positive geotropism of the cotyledon of the date and other plants, where it is the first part of the embryo to elongate actively, is explained in the same way; the stimulus is received by the root tip, and the response is executed in the elongating zone above it, which is here in the cotyledon.

*The Toxic Action of certain Salts on Marine Algae:* DR. BENJAMIN M. DUGGAR, Cornell University.

Plasmolytic studies upon some marine

algæ at the Naples Biological Station demonstrated that  $\text{KNO}_3$  is too toxic to be used for such work. This led to a study of some of the common nutrient salts as toxic agents in comparison with some salts of the heavy metals and with certain acids.

In general the results indicate that potassium salts are much more toxic than those of sodium and magnesium. All the algæ used were killed by an exposure

of three days in  $\frac{n}{25} \text{K}_2\text{HPO}_4$  in sea water

$\text{K}_2\text{SO}_4$ ,  $\text{KNO}_3$ , and  $\text{KCl}$  were also toxic in a slightly decreasing ratio. With the magnesium and sodium salts used, and for a similar period of time, no injury occurred

at  $\frac{n}{5}$ . Salts of the heavy metals were

much more toxic than for the fungi; and in general, the acids used were very slightly

toxic at  $\frac{n}{1000}$ . With no salt tested was

it possible to keep the plant alive for more than a few hours in a solution of that salt isotonic with sea water. *Griffithsia Schousberi*, *G. opuntioides*, *Pleonasporium coccinivum*, and *Chatomopha* sp. were the algæ used.

*Loss of Vigor in Corn from Inbreeding:* DR.

HERBERT J. WEBBER, Department of Agriculture.

In maize the loss of vigor caused by close inbreeding was found to be very marked. Seeds of Hickory King, a race grown commonly in the eastern States, produced by inbreeding with pollen of the same stalk, yielded the next year at the rate per hundred stalks of 46 ears, weighing  $9\frac{1}{2}$  pounds. Seeds of the same race in every way comparable, but produced by crossing different seedlings, yielded under the same conditions at the rate per 100 stalks of 82 ears, weighing  $27\frac{1}{2}$  pounds.

In attempting to fix hybrids of Hickory King  $\sigma$   $\times$  Cuzco or Peruvian Corn  $\delta$ , some ears were inbred with pollen from the

stalks bearing them, while others were pollinated with pollen from other hybrid seedlings of the same parentage. The hybrids of the second generation, where the seed was inbred with pollen from the same stalk, showed great loss of vigor, being small in stature and almost totally sterile; while those produced from seed which was inbred with pollen from a different seedling were much more vigorous and productive, seeming to have lost but little by this process of inbreeding.

Judging from these observations, it would seem that in fixing corn hybrids in practical plant-breeding it will be found desirable to cross different hybrid seedlings of the same parentage, which are found by careful observation to present the same characters, rather than inbreed a hybrid with its own pollen, as is somewhat generally directed by plant-breeders. It is of the utmost importance in plant-breeding that the best methods of fixing hybrids of various kinds of plants be determined, and further observations on this point with other plants are greatly needed.

W. F. GANONG,  
*Secretary.*

#### WASHINGTON UNIVERSITY.

THE new grounds of Washington University are situated at the western boundary of the city just west of Forest Park. The distance from the Mississippi River is about six miles and from the business center of the city about five miles. The most direct approach from the city is along Lindell Avenue. The site covers 153 acres and cost \$350,000. The eastern boundary of the ground is Skinker Road, from which the land rises rapidly westward for about 1,000 feet. About 1,200 feet from Skinker Road is placed the main building of the institution, to be called University Hall and to be devoted to the offices of administration and to those subjects which do not require

a laboratory or a drawing room. This building forms the eastern side of the first quadrangle; the other buildings on this quadrangle are Busch Hall, to be devoted to chemistry, Cupples Hall No. 1, to be devoted to Civil Engineering and Architecture, and the Library which separates the first quadrangle from the second.

On the second quadrangle are also to be Cupples Hall No. 2, which is to be devoted to electrical and mechanical engineering, a building for physics, and sites for other buildings not yet planned. The first and second quadrangles are to be devoted exclusively to buildings for instruction. The other quadrangles are to be devoted to dormitory buildings. Those to the north of the Broad Walk are intended to be occupied by women students and those to the south of the Broad Walk by men students. The Broad Walk, something over a third of a mile long, leads to the gymnasium, near which is the athletic field, which will be excavated in the top of the hill in the form of an amphitheater. The architects, Messrs. Cope & Stewardson, of Philadelphia, have so arranged the quadrangles as to occupy the highest land of a long hill whose general direction is east and west.

Seven of the buildings shown on the general plan are to be constructed at once, and five of them are already under construction. The St. Louis, Kansas City and Colorado Railroad, running along the north line of the property at the bottom of the hill, makes it easy to bring in the supplies for the University. The power house, located beside the railroad track, will provide heat, light and power for all the buildings. The buildings generally will be two stories high on the quadrangles and three stories high on the opposite sides. The buildings to be erected immediately will cost about \$700,000, and about \$100,000 will be expended in the grading and planting of the grounds.

The style of architecture is what is called

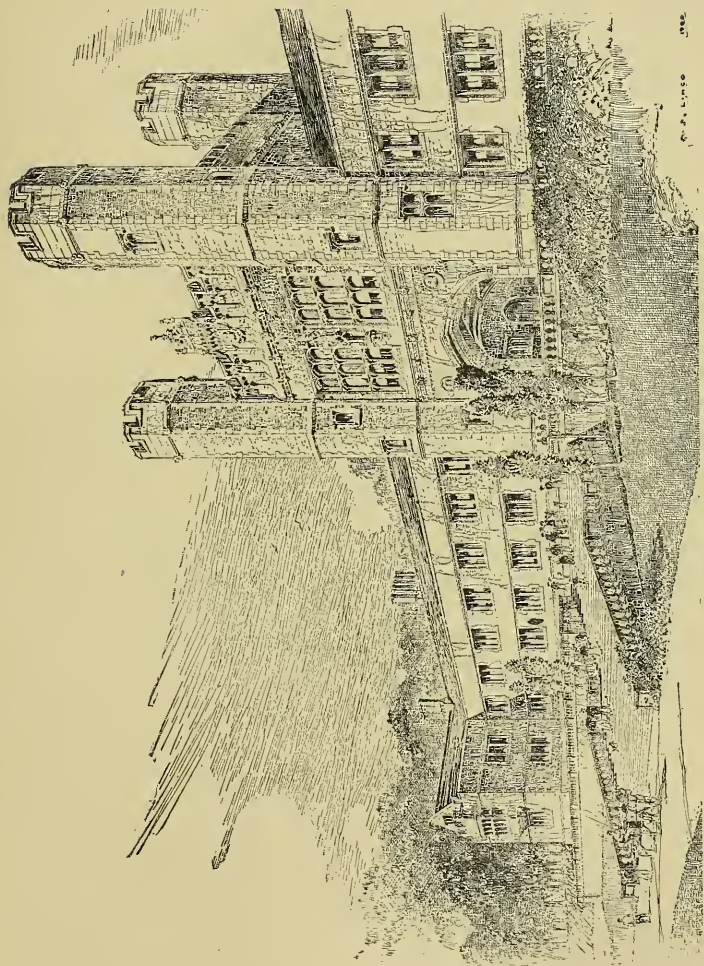

University Hall, Washington University.

P. S. LYCO  
DRE

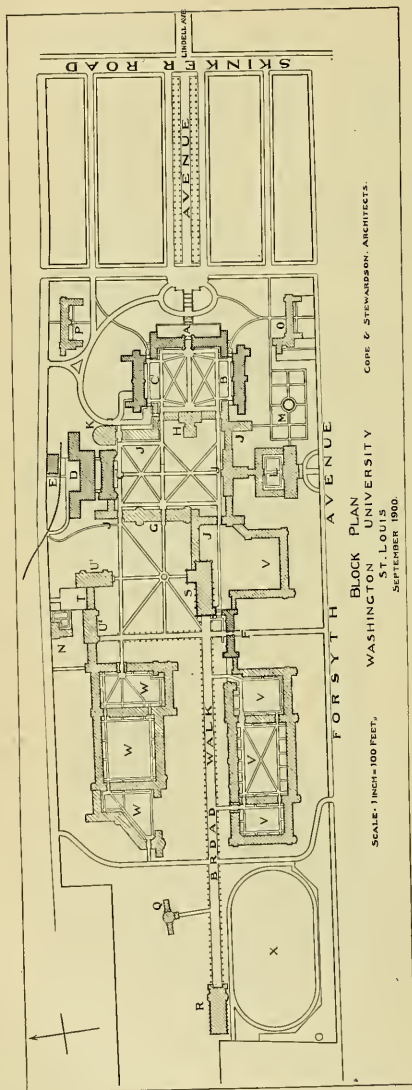

A—University Hall—Administration.  
 B—Busch Hall—Laboratory of Chemistry.  
 C<sup>1</sup>—Cupples Hall, No. 1—Civil Engineering and Architecture.  
 C<sup>2</sup>—Cupples Hall No. 2—Mechanical and Electrical Engineering.  
 D—Laboratories of Mechanical and Electrical Engineering.  
 E—Power House.  
 F—Liggett Hall—Men's Dormitory.

## INDEX.

G—Laboratory of Physics.  
 H—Library.  
 J—Position of Future Extension of Scientific Schools.  
 K—Auditorium.  
 L—Museum.  
 M—Botanic Garden.  
 N—Gardener's House.  
 O—Instructors' Houses—Men.  
 P—Instructors' Houses—Women.

Q—Observatory.  
 R—Gymnasium.  
 S—Chapel.  
 T—Kitchen Service.  
 U<sup>1</sup>—Commons Hall—Men.  
 U<sup>2</sup>—Commons Hall—Women.  
 V—Dormitories for Men.  
 W—Dormitories for Women.  
 X—Athletic Field—Running Track, 3 laps to the mile.

Now  
 being  
 erected.

Tudor Gothic which appears so prominently in the buildings of the Universities of Oxford and Cambridge. The amount of cut stone in the buildings will be large; the material used for this purpose comes from the Bedford quarries of Indiana. The field of the walls is to be of rubble masonry of red Missouri granite. It is expected that the five buildings now under way will be completed in about one year.

Besides these gifts, the University has recently received gifts for its endowment fund of three and a half million dollars, part available at once and part available after a few years.

W. S. CHAPLIN,  
*Chancellor.*

#### THE BUSCH CHEMICAL LABORATORY.

THE new chemical laboratory of Washington University, the plans of which appear in this number of SCIENCE, is the generous gift of Mr. Adolphus Busch of St. Louis, who has given the University \$100,000, for its construction and equipment. The building is situated on the south side of the university quadrangle, and as the ground slopes away on this side, the new laboratory is two stories high on the north front and three stories on the south. Directly opposite on the quadrangle is the Cupples Hall No. 1 devoted to Civil Engineering and Architecture, while adjoining it on the east is the large and beautiful University Hall. The windows of the Busch laboratory command a beautiful view of the campus to the north and west, while to the south and east they overlook the wooded hills of Forests Park. The laboratory stands to-day as an enduring monument to the liberality of Mr. Busch.

The architects of the building are Messrs. Cope and Stewardson of Philadelphia and St. Louis, who a few years ago designed the John Harrison Laboratory of Chemistry of the University of Penn-

sylvania. In planning this laboratory they have retained all of the desirable features of the Pennsylvania laboratory, they have avoided everything that experience has shown to be undesirable and have in a number of ways improved upon their earlier work.

The building is of Tudor Gothic design, the walls are of Missouri granite, the ornamental cut stone work of the windows and doors is of Bedford limestone. It is of fire-proof construction throughout. From the illustrations it will be seen that the building is long and narrow. The length is 291 feet and the width 60 feet. This plan was adopted in order that all the rooms may be well lighted, and since the main length of the building extends from east to west, a long north front with ample window space is secured for the main working laboratories.

Entering at the east front door, one finds immediately on the left the large lecture theater, a room 46 feet by 30 feet 10 inches. The rows of seats rise one above another, and there are places for 186 students. The front of the lecture room is half a flight lower than the rear. Immediately in the rear of the lecture theater and communicating with it is the preparation room. Here the lecture experiments are prepared and the apparatus and chemicals used in the lectures are stored.

Passing westward in the main corridor on the first floor, one finds on the right a large laboratory devoted to general chemistry. This room is 130 feet 6 inches by 18 feet. Here are working tables for the accommodation of 125 students. The new feature in this laboratory is that each working table is placed with one end against a window. On each side of the table are drawers and cupboards for four students. Each table, having a window at the end, is well lighted, and no student works further than twelve feet from a win-

dow. On the wall opposite the windows there is a continuous line of hoods extending from one end of the room to the other. hydrogen sulphide room, the other as a storeroom for keeping the stock bottles of reagents.

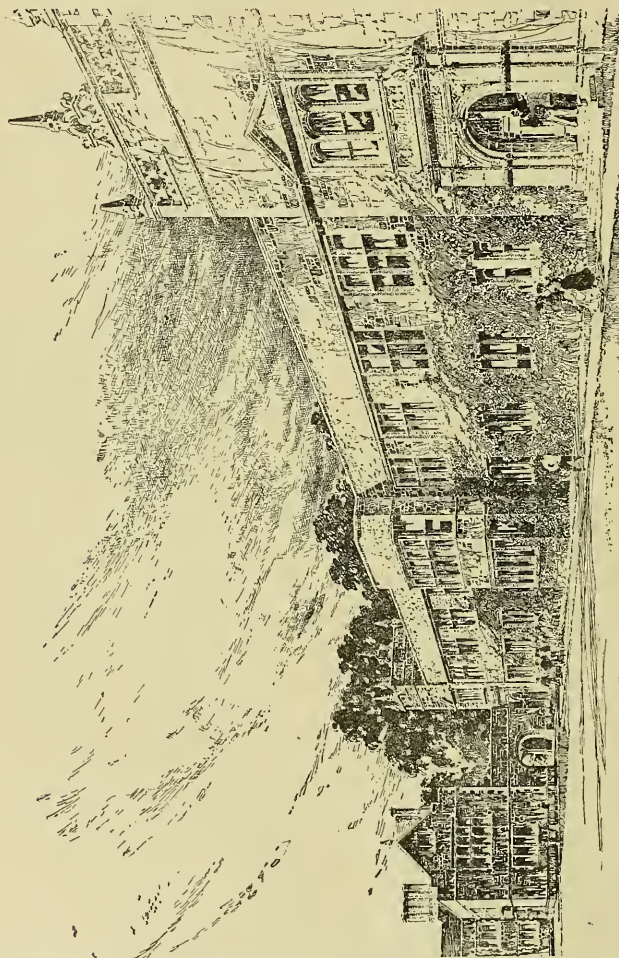

The Busch Chemical Laboratory.

At each end of this large laboratory there is a small room, one of these is used as a professor's office and private laboratory,

the library and balance room, a lecture room, 23 feet by 32 feet, seating 60 students, a museum and storerooms for apparatus and chemicals. At the west end of the building and half a flight lower there

downs on the north and south sides. This is the laboratory for quantitative analysis, and communicating with it at the western end are smaller rooms for balances, reagents and a private laboratory for the in-

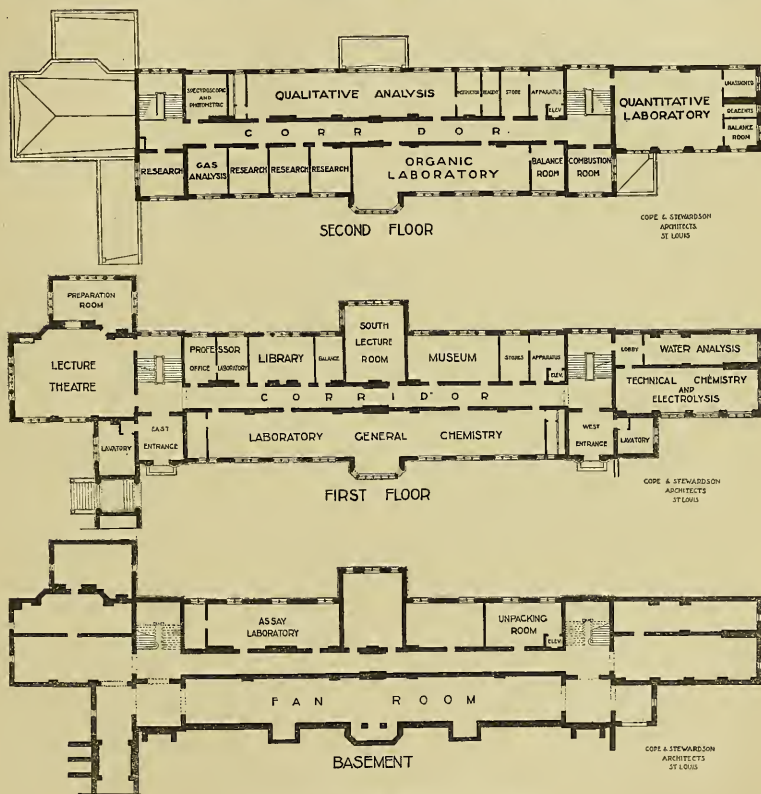

Ground Plan of Busch Chemical Laboratory.

are rooms for special kinds of chemical work, such as water analyses, electrolytic work and technical chemical operations.

Ascending the western stairway one-half flight, one reaches a large room, 41 feet 9 inches by 32 feet, lighted with large win-

structor. On the main second floor there are two laboratories, one of these, with working tables for sixty students, is devoted to qualitative analysis, the other, with places for thirty students, is arranged for work in organic chemistry. As

in the large laboratory on the first floor, the tables have their ends against the windows and the hoods extend along the interior walls. On this floor there are also four smaller rooms for research work, a room for photometric and spectroscopic work, a balance room, a room for organic combustions and store rooms for apparatus and chemicals. These last are immediately over the store rooms on the first floor, and communicate with them and with the unpacking room in the basement by means of an elevator.

In the basement, besides the unpacking room, there are two large well lighted rooms fitted up with furnaces for work in assaying. There is also a room for the apparatus used in preparing distilled water.

In the rooms on the north side of the basement are located the ventilating fans. These are driven by electric motors. In the system of heating and ventilating adopted cold air from the outside is drawn in by the fans and is forced over steam radiators and into the rooms. The warm air enters the rooms near the ceiling and the outlet flues have their openings near the floor. A separate system of fans, also driven by electricity, is placed immediately under the roof. These are connected with the hoods and with the hydrogen sulphide room, and they have been so arranged that they can be made to draw air from all the hoods or they can be made to draw simultaneously from the hoods of any one laboratory.

EDWARD H. KEISER.

DEPARTMENT OF CHEMISTRY.

#### SCIENTIFIC BOOKS.

*Ueber die Natur der Centrosomen.* By THEODOR BOVERI. Zellenstudien, Heft 4. Fischer, Jena. 1901. Pp. 220, 8 plates, 3 text-figures.

Probably the most remarkable series of cytological papers yet published by a single author are the 'Cell-Studies' of Theodor Boveri,

which have placed before students of cellular biology not only a wealth of original discoveries, but also a model of critical analysis and lucid exposition that has hardly been surpassed. They form to-day a fine example of the value of intensive work in this field, for although they have extended over a period of nearly fifteen years they have been mainly devoted to the examination of but two objects, namely, the eggs of *Ascaris* and of the sea urchin; yet few works have accomplished more for the advancement of the general subject.

The first three parts, which appeared successively in 1887, 1888 and 1890, were inspired by the epoch-making researches of Van Beneden on the eggs of *Ascaris*, and the first two were entirely devoted to the same object. The first cleared away the confusion of the earlier work regarding the formation of the polar bodies and laid the basis for most of the subsequent work on the reduction of the chromosomes, a subject which was thrown into especial prominence through the theoretical essays of Weismann. The second was a masterly study of the phenomena of fertilization and cleavage, with a full development of the hypotheses of the individuality of the chromosomes and of fibrillar contractility in mitosis, which exerted a far-reaching influence on all subsequent work in this field. The third placed upon a broad comparative basis the epoch-making discoveries of himself and Van Beneden on the equivalence of the paternal and maternal chromosomes in fertilization ('Van Beneden's Law'). The fourth, which appears eleven years after the third, deals with the nature and function of the centrosome, which has become one of the most difficult and perplexing problems of cytology. Students of cellular biology have eagerly awaited a critical discussion by Boveri of the later and in many respects conflicting aspects of this subject, in which he was one of the ablest pioneers. The present work contains a detailed study of the centrosomes in the segmenting eggs of *Echinus* and *Ascaris*, a valuable critique of technical methods, and a critical examination of the literature, with chapters on the structure and division of the centrosome in general, its relation to cell-division, its origin and physiological activity, and related questions.



All these matters are treated in the lucid and attractive style characteristic of the author, and the work easily takes its place as a worthy companion to its predecessors.

The portion of the work that will be read with greatest interest is that which deals with the vexed question as to whether the centrosome is a permanent cell-organ, comparable with the nucleus in point of morphological persistence. The independent discovery by Van Beneden and Boveri in 1887, that the centrosome in the *Ascaris* egg is such an organ, since extended to many other cases, was at first hailed as the most important step taken since the establishment of genetic continuity in the case of the nucleus. That a like principle applies to the centrosome, as was first stated by Van Beneden and Boveri, has been widely accepted by cytologists, but of late years a marked reaction against this view has taken place, a considerable number of competent observers having been led to conclude that centrosomes may form *de novo*, as well as by the division of pre-existing centrosomes. While recognizing that the centrosome theory has been in some directions pushed too far, Boveri regards the present reaction as a backward step. Nevertheless, in the course of a highly interesting discussion, he makes a large concession to the advocates of formation *de novo*, though his general theory is developed with the utmost ingenuity so as to save the principle of genetic continuity for which he has always contended. He sharply distinguishes between a protoplasmic (cytoplasmic) and a nuclear origin of centrosomes. While formation of centrosomes *de novo* in the protoplasm is denied, such an origin is admitted in case of the nucleus, though with qualifications that involve only a modification and not the abandonment of his original theory.

The strongest evidence in favor of the cytoplasmic formation of centrosomes *de novo* is afforded by the observation of the American observers, Lillie, Mead and Morgan; but all arguments based on this evidence are regarded as 'in high degree vulnerable.' The multiple asters observed in the eggs of *Chaetopterus*, *Arbacia* and other animals are believed by Boveri to be 'almost certainly' of two kinds, the one (polar asters, cleavage-asters) being true asters

arising through the activity of the egg centrosome or its derivatives, the other being 'pseudospheres' of different nature from the former and containing no true centrosomes. All arguments based on the apparent disappearance and reappearance of the centrosomes in the cytoplasm during fertilization (as described for instance, by Lillie and MacFarland) are regarded as having little weight, in view of the impossibility of distinguishing the centrosome amid other granules when not surrounded by astral rays. On the positive side the persistence of the centrosome in *Ascaris* is once more demonstrated, step by step, throughout the first cleavage, and the same phenomenon is for the first time fully demonstrated in the egg of the sea urchin (*Echinus*) which, as Boveri emphasizes, is one of the most difficult of objects. These cases are illustrated by a large number of new and very convincing figures.

When Boveri turns to the nuclear origin of centrosomes he takes a different ground, basing his conclusions on the absence of centrosomes in the higher plants, on the phenomena of division in the Protozoa and on the experimental evidence brought forward especially by Hertwig and Ziegler. This interesting discussion is based primarily on the fact that in Infusoria and some other Protozoa a spindle is formed from the achromatic substance of the elongated nucleus, the bipolarity of the division figure being determined by the nucleus without the appearance of individualized centrosomes; and with this is compared the formation of the polar spindle in the eggs of *Ascaris*. To such a spindle the new term 'netrum' is applied ( $\nu\eta\tau\rho\nu\nu$ , spindle), and its mode of origin is assumed to be a primitive mode of spindle-formation to which all other types may be referred. The accumulation of substance at the poles of such a spindle to form 'pole-plates,' as occurs in some Protozoa, represents an incipient centrosome-formation, with which is compared the peculiar mode of division of the centrosome in *Diatala* as described by MacFarland. In the latter case the centrosome is extra-nuclear, but its mode of division closely resembles the phenomena observed in Infusoria, the mother-centrosome elongating to form bodily the spindle from the ends of which are differentiated the daughter-

centrosomes. This case gives the transition to the usual types (*Ascaris*, cleavage, etc.) where the extra-nuclear centrosome divides bodily.

Boveri is thus led to regard the centrosome of the higher types as equivalent to the intra-nuclear material from which the 'netrum' of the lower types (*Infusoria*) arises, and he characterizes the nucleus of the latter as a 'centronucleus'—a view which is nearly identical with that of Richard Hertwig. In the higher types in general, individualized and permanent centrosomes have been differentiated, and as it were emancipated, from the primitive 'centronucleus,' and as a rule lie outside the nucleus in the cytoplasm; but the nucleus has in some cases retained the power to give rise, upon occasion, to a karyokinetic spindle (as occurs in the polar spindles of *Ascaris*), or even to produce new centrosomes. This, Boveri believes, is the case with the egg-nucleus in echinoderms, and he would thus explain the division figures formed as a result of chemical stimulus. In normal fertilization, on the other hand, the centrosome-producing power of the egg-nucleus remains latent, since the spermatozoon imports an active individualized centrosome. How far the nuclei of higher forms in general have remained 'centrouclei' and still possess the power of forming centrosomes, how far they have lost this power, remains to be determined; but Boveri does not consider it probable that such a mode of centrosome-formation is wide spread. It is worth pointing out that Boveri regards as not improbable the view of Calkins that phylogenetically the primitive form of nucleus (centronucleus) may have arisen through the union in one body of a cytocentrum and other elements (chromatin) originally scattered through the general cell substance.

It is evident from the foregoing that the original centrosome theory of Van Beneden and Boveri, as commonly understood, has thus undergone a considerable modification, which will very likely be regarded by some readers as a virtual abandonment of that theory. Such is not, however, Boveri's own view. "Strictly speaking the cases in question do not involve a new formation. For even though the centrosome may not preexist as an individualized structure, it does not arise as something really

new \* \* \* but only by the final transformation of a preexisting cytocentrum" (p. 193).\* If, however, we accept the widely held view that the achromatic nuclear substance is closely related to the cytoplasm, the step does not seem very great from the formation of 'individualized' centrosomes *de novo* out of the achromatic nuclear material to such a formation in the cytoplasm. Boveri's denial of such cytoplasmic centrosome-formation rests upon a series of assumptions, some of which are opposed by the recent discovery that Morgan's 'artificial astrospheres' may multiply by division, even in enucleated egg-fragments. He has nevertheless entrenched the centrosome theory in a strong position, from which it can only be dislodged by a stronger attack than has yet been made upon it.

Other valuable discussions deal with the relation of centriole and centrosome, and of centrosome and sphere, and with the physiological activities and cyclical changes of the centrosome. Without attempting to review these *in extenso* it may be pointed out that Boveri holds fast to the view that the centrosome passes through a regular cycle of changes, during one part of which it is a body of considerable size within which lies a smaller 'centriole.' He repudiates some of the interpretations that have been placed by other writers upon his own earlier observations, and identifies his 'centrosome' with Van Beneden's 'corpuscule central,' and not with the latter author's 'medullary zone' of the sphere. He overturns Kostanecki's and Siedlecki's contention that the size of the centrosome depends merely on the degree of extraction of the hæmatoxylin or other dye, by the highly important observation that when at its greatest size the centrosome in *Ascaris* is clearly visible not only in unstained material but also in the living object. He believes that the so-called pluricorpular centrosome, such as he himself and others earlier described in echinoderms, is an artifact; but his observations justify some severe strictures that are passed on the scepticism of such writers as Fischer, who have more than hinted that the centrosome itself is an artifact. Fischer's valu-

\* For a related though not identical interpretation see Wilson, 'The Cell,' pp. 111, 215.

able experiments, with those of Bütschli, Hardy and others, have shown how much caution is necessary in the interpretation of the coagulated material observed in sections; but they have produced in some minds a pessimism regarding the morphological investigation of the cell that is without justification. The cyclical changes observed in sections of fixed material are not a matter of chance, but form a highly significant connected series, and many of them have been fully confined by comparison with the living material. The experiments in question have provided us with a valuable critique of our methods, but have not destroyed their value. Even though we may not agree with all the conclusions set forth in the present paper, we must regard it as weighing heavily on the side of the view that the cell possesses a definite and complex morphological organization that passes through perfectly ordered cyclical changes, and of which our cytological methods give us not indeed a photographic image, but still a definite record.

EDMUND B. WILSON.

*Elements of Mineralogy, Crystallography and Blow-pipe Analysis.* By ALFRED J. MOSES and CHARLES L. PARSONS. New York, D. Van Nostrand Co. 1900.

The edition of the book before us is in plan essentially like the former edition of 1895. Many parts have, however, been re-written and considerable additions are to be noticed in text and illustration.

The part devoted to crystallography has undergone complete revision, and in its treatment of the subject conforms to the prevailing classification. Over one hundred figures, for the most part excellent, have been added and we are pleased to note a new chapter treating entirely of twin crystals. The chapters on blow-pipe analyses treat of the apparatus used in, and the operations of, blow-pipe analyses. A summary of blow-pipe tests is also given with a short scheme for qualitative blow-pipe analysis.

The descriptive mineralogy opens with chapters treating of the various characters of minerals, that on optical characters being intended as introductory to a subsequent study of minerals in thin sections under the microscope. In the part describing the individual minerals we

find them grouped according to the economic classification, viz., iron minerals together, copper minerals together, etc. Before each group a brief discussion is made of the uses of the particular metal in hand, the minerals from which it is obtained and the metallurgical processes involved in its production. We think this an excellent feature of the book. The silicates do not yield to such a classification and are grouped according to the usual chemical classification. While the descriptive part as a whole and in many of its details seems to us excellent and worthy of commendation, we can not but express our regret that it should be marred by so many poor illustrations. The crystal drawings are excellent, but with few exceptions the other illustrations are not what they should be. It is doubtless difficult to represent the characteristic appearance of a mineral on paper and unless great pains is taken in this regard it were better for both books and mineralogy not to attempt such illustration.

In describing the crystallization of the minerals we notice that the real angle between the crystal faces are given instead of the supplementary angle as is customary. As the latter angles are the ones most convenient for use in calculation it would seem desirable to have had them given.

The book is concluded by a series of tables designed for the rapid determination of the common minerals.

C. H. W.

*A Text-Book of Important Minerals and Rocks.*

By S. E. TILLMAN. New York, John Wiley and Sons; London, Chapman & Hall. 1900.

Professor Tillman has prepared this book with the idea of furnishing the general student of mineralogy with a convenient and serviceable book, condensed in form, yet sufficiently complete in descriptive matter to equip the student with a good general knowledge of the subject.

The opening chapter consists of a very brief outline of the crystallographic character of minerals. The second treats of other physical characters and of the chemical properties of minerals. With the latter is included a brief description of blow-pipe and chemical tests. That four pages should be deemed sufficient for

the treatment of a subject so very important is rather astonishing, and it is the deficiency in this regard that will we fear detract from the general usefulness of the work. The main part of the book contains the descriptions of the individual mineral species, of which some seventy-five are described, and their occurrence and uses commented on. A series of tables for the determination of the minerals, chiefly by means of their physical characters, are included in the descriptive part and is designed to supplement the latter. Part II. furnishes a brief description and classification of the more common rocks.

C. H. W.

*Lehrbuch der anorganischen Chemie.* Von PROFESSOR DR. H. ERDMANN, in Halle. Zweite Auflage, mit 287 Abbildungen, einer Rechen-tafel und sechs farbigen Tafeln. Braunschweig, Druck und Verlag von Friedrich Vieweg und Sohn. 1900.

To quote from the author's preface. "First of all a text-book of chemistry should give reliable data concerning the properties and reactions of substances; here were gaps to be filled, for our larger manuals generally take without criticism the frequently contradictory statements and figures of different authors. The most accurate data, however, remain lifeless matter for reader and student unless the book explains the occurrence of substances on a geological basis, gives due attention to their therapeutic and toxic properties, and due recognition of their importance for the common weal by a consideration of their varied application, and by statistics of production and price; nor should the historical aspect of the subject be neglected."

Through certain improvements in this edition "somewhat more space could be devoted to those theories which have sprung up on the boundary space between physics and chemistry. Yet their views should never occupy the main place in the presentation of chemistry. He who leads the student into our science by a by-path instead of stimulating him to *pure chemical thought*, does in verity make chemistry a 'science of inferior worth'" (Ostwald).

"As Clemens Winkler aptly says, 'physical chemistry in no sense covers the same field as

inorganic chemistry, for the latter, far from being a closed branch of science, offers countless problems which must be solved by quite other methods than those furnished by the theory of ions.'"

The quotations indicate the character of the book. It is a masterpiece of descriptive chemistry, a book written for riper German university students. If a translation is made it will doubtless be harmfully introduced into our colleges, possibly into high schools. As there is fortunately no translation as yet, the use of the book will be limited to teachers and older students reading German, and to them it will be a benefit and a pleasure.

As introduction, the author in seventy-five pages discusses weight and measure, heat, theories of gases, Avogadro's law, laws of chemical changes, etc. In short, he has brought together what is generally scattered throughout the book. If this were a book for beginners this method would be open to adverse criticism. For older students the reviewer believes it to be the better arrangement, especially when the treatment is as good as here. The author tacitly assumes that the reader is prepared by previous study to follow him without diffuse explanations.

The next division covers the non-metals in 400 pages, the last division the metals in 320 pages. Erdmann divides the non-metals as follows: *Chief gases*, oxygen, hydrogen, nitrogen. *Noble gases*, helium, neon, argon, krypton, xenon. *Air. Sulphur group*, sulphur, selenium. *Halogens*, fluorine, chlorine, bromine, iodine. *Phosphorous group*, phosphorous, arsenic, antimony. *Carbon group*, boron, carbon, silicon, germanium.

It is evident from this division that the author does not utilize the periodic system as a means of instruction; indeed he only devotes three pages at the close of the book to the system, his treatment coinciding with that of Ostwald's 'Grundlinien der anorganischen Chemie' in this respect, but in no other. This shelving of the periodic system is to be regretted; it does not accord with the influence which this system exerted and still exerts in the chemical thought and chemical work of the last thirty years and of the present.

At the close of each chapter is a beautifully

illustrated section headed 'Technique and Experiments'; these sections are very pleasing. The apparatus is of the most modern type, many experiments are new.

The author had Professor Ramsay's cooperation in rewriting the chapter on noble gases for this edition. The chapter includes full illustrated descriptions of the methods for obtaining argon and helium, and colored tables of the spectra of all the noble gases, showing the three spectras of argon—the blue, the red and the green. Another interesting chapter is that devoted to flame, illumination, photometry, burners, furnaces, fuel gases, fuels and heat values. In this, as indeed in the whole book, we find the newest methods and the latest statistical results. Striking examples of this are shown in the references to persulphuric acid and to radium; in the first instance the work of Baeyer and Villiger on 'Caro's Reagent' in the *Berichte* of June 7th is utilized for the book which appeared in October; in the latter instance we find in the chapter on barium a brief discussion of radio activity, radium and polonium and of the work of Becquerel, of the Curie's and of Lengyel.

Of more vital importance to the student are the methods of formation of substances and their use in modern technical chemistry, which are not found in any other text-book. For example, recently published books state that hydrochloric acid is obtained technically only as a by-product in the Leblanc process. Erdmann says that while in England one-half million tons of salt are used yearly for Leblanc soda, in other countries this process has only 'historical interest.' Hydrochloric acid, he says, is now made in Germany either as a by-product in the Glauber salt industry from salt and sulphuric acid, or by decomposing magnesium chloride with superheated steam. We find that magnesium chloride is obtained from Strassfurt Carnallite as by-product in crystallizing potassium chloride from Carnallite solution or as a by-product in the manufacture of Glauber salt by action of a solution of Strassfurt Kieserite on salt at low temperatures, 8,000 tons Glauber salt being made yearly by the latter method.

The theoretical side of the book is also well

developed. Physical chemical theories are, it is true, but little utilized. The author explains the theory of ions briefly under the head of acids, and refers to this and other theories from time to time throughout the book, devoting seven pages at the end to a condensed discussion of the laws of electro-chemistry and of electrolytic dissociation; that is all. But if we examine Erdmann's treatment of any class of compounds in detail we find that more space is given to the theoretical side—as we have hitherto been accustomed to define 'theory'—than by Ostwald, despite the demand of the latter author that a text-book of chemistry shall devote all its space to 'pure chemistry.'

A comparison is justified by the decided stand both authors take. Both volumes are alike in size of page and type, Ostwald having 795 pages and Erdmann 757. The reviewer has chosen at random the oxygen and hydrogen compounds of nitrogen for the purposes of comparison. Ostwald devotes 36 pages to the subject; about one-half of this space is devoted to physical chemical considerations of great interest; the other half is descriptive chemistry in the narrowest sense, no reference being made to any modern work on structure. Erdmann gives 58 pages, of which 14 are given to illustrated experiment and technique; the remaining 44 pages give fact, theory and statistics; he opens the subject with 5 pages devoted to a study of the constitution of the compounds, relations of the different hydroxyl-acids, etc. Six pages follow on the formation, decomposition and properties of nitric acid, a full but carefully condensed statement. Ostwald gives  $1\frac{1}{2}$  pages to nitric acid, namely, composition  $\text{HNO}_3$ , saltpeter, Chili saltpeter, decomposition of Chili saltpeter by sulphuric acid in two stages, and a few words on the properties of nitric acid. In short, no more than is contained in an average school chemistry. Erdmann gives  $4\frac{1}{2}$  pages to hydrazine and hydrazoic acid; Ostwald, 1 page. Erdmann gives 2 to hyponitrous acid, explaining the stereoisomeric forms, which are ignored by Ostwald in the 15 lines given by him.

In a recent review of Ostwald's book it is said, "Every chemist should own a copy of this book and should conscientiously study it."

The present reviewer subscribes heartily to these words and intends no belittling of this brilliant book, but the fact remains that so much space in it has been required for the applications of physical-chemical theory, that much of what we have hitherto considered higher inorganic chemistry has been crowded out, theory as well as fact, and that Erdmann's book supplies those facts and those theories which are lacking in Ostwald's. Every chemist should own and study both books.

EDWARD RENOUF.

#### NOTES.

Copies of the 'Descriptive Catalogue of Government Publications of the United States from September 5, 1774, to March 4, 1881, compiled, by order of Congress, by B. Perley Poore, Clerk of Printing Records, are now for sale for \$1.90. Remittance should be by money order payable to W. H. Collins, Chief Clerk, Government Printing Office, Washington, D. C.

THE work on the 'Mammals of Egypt,' left unfinished by the recent death of Dr. John Anderson, will be completed under the supervision of Mrs. Anderson.

UNDER the title 'First on the Antarctic Continent' Mr. Borchgrevink, the commander of the recent Antarctic expedition, has now completed the account of his voyage in the *Southern Cross* and of the adventures and incidents in the land near the South Pole. The volume will be published very shortly by George Newnes (Limited).

PROFESSOR WILBUR C. KNIGHT has published a large-sized block-line geological map of Wyoming in Bulletin 45 of the Wyoming Experiment Station, accompanying 'A Preliminary Report on the Artesian Basins of Wyoming.'

D. K. KEILHACK has issued, through the Gebrüder Borntraeger of Berlin, the fourth yearly edition of his *Taschenbuch für Geologen, Palæontologen und Mineralogen*.

#### SOCIETIES AND ACADEMIES.

##### GEOLOGICAL SOCIETY OF WASHINGTON.

AT the 109th meeting, held at the Cosmos Club, January 23, 1901, the following papers were presented:

*Shell Bluff, Georgia, one of Lyell's Original Localities*: T. WAYLAND VAUGHAN.

This locality is in Burke county, Georgia, on the Savannah River, about 20 miles in a straight line below Augusta, and about 100 miles above Savannah. It was examined by Sir Charles Lyell during his first visit to the United States and was first brought into prominence by him. Subsequently Conrad visited and studied the bluff, and considering it paleontologically peculiar, gave the name Shell Bluff Group to the beds there exposed, correlating them with the base of the bluff at Vicksburg, Miss., and placing them in the columnar section immediately beneath the Jackson. Later several other geologists, including Loughbridge and Professor W. B. Clark, visited the locality. Because of the prolonged discussion as to the precise position of the Shell Bluff section in the Eocene series, Mr. Vaughan visited the locality during December, 1900, and made a considerable collection of fossils. All the face of the bluff, something over 70 feet, except the uppermost 10 feet, contains a fauna identical in essential species with the Lisbon beds of Alabama, the Wautubbee beds of Mississippi, and the Texan and Louisianan Lower Claiborne of Harris and Vaughan. The uppermost layers contain almost exclusively *Ostrea Georgiana* Conrad, no fossils that could be used as positive stratigraphic indices being found, but it is most probable that this portion of the section also belongs to the same horizon. Compared with the section at Claiborne, Alabama, the section of Shell Bluff can be correlated with the Lisbon, the second horizon beneath the Claiborne sands proper, *i. e.*, it is below the *Ostrea settoniformis* bed which immediately underlies the Claiborne sands.

A few of the species are: *Turbinolia pharetra* Lea, *Endopachys maclurii* (Lea), *Mesalia obruta* (Conrad), *Venericardia planicosta* Lam., *Venericardia alticostata* (Conrad), *Corbula oniscus* Conrad, *Pteropsis lapidosa* (Conrad). Approximately forty species were collected.

*Trias in Northeastern Oregon*: WALDEMAR LINDGREN.

As a preliminary, the occurrences of marine Trias in the western part of North America

were reviewed. It was shown that a gap existed between the known localities in northern Nevada and California on one hand, and those of British Columbia on the other. This gap has partly been bridged by the discovery of an extensive series of marine Trias in northeastern Oregon. No Trias has previously been found in this State.

The result of a reconnoissance during the past field season has shown that the larger part of the Blue Mountains of Oregon are made up of older rocks of probably Carboniferous age. In the Eagle Creek Mountains, however, which form a circular mountain group in the extreme northeastern corner of Oregon, surrounded on nearly all sides by Columbia River lava, the marine Trias was found very strongly developed, although the fossils thus far obtained do not afford paleontological subdivisions. The fossils, though scant, unquestionably indicate a Triassic age. They consist, besides pentacrinus stems and fragments of echinoids and ammonites, of various specifically indeterminate Halobias and Danonellas. The series consists of a great thickness, probably several thousand feet of shales and limestones. Associated and interbedded with these are vast masses of tuffs and various old lavas. The limestone is very prominently developed and its weathering gives rise to peaks and cliffs of Alpine character.

The same series was found well represented in the Snake River canyon on the boundary of Idaho and Oregon. Here, however, the volcanic material predominates, the sedimentary rocks appearing as intercalated masses. Halobias were again found in this series. It appears that these Triassic rocks continue with a northeasterly strike into Idaho across the Seven Devils and the lower Salmon River Canyon, until at some point in the vicinity of the Clear Water River, they give place to intrusive granites and older schists.

*A Comparison of the Ouachita and Arbuckle Mountain Sections, Indian Territory: J. A. TAFF.*

The Ouachita mountain range extends from the vicinity of Little Rock, Arkansas, to the Missouri, Kansas and Texas Railway, near Atoka, in Indian Territory. The hard sandstone and novaculite formations make ridges

rising from 1,000 feet at the end of the range, to nearly 2,000 feet in the central part. The high ridges have strikingly level crests which probably represent a Cretaceous plain. The softer rocks are generally worn down to heights between 600 and 1,000 feet above the sea.

The Arbuckle range, with the exception of a central igneous peak, contrasts strongly with the Ouachita range in physiographic aspects. It is strictly a plateau, only partially dissected and but little below the original Cretaceous base level. It rises gradually to about 1,350 feet on the west, from the Cretaceous contact having an average elevation of 750 feet, on the east and southeast. The gap between the Ouachita and Arbuckle uplifts is about 20 miles wide and is occupied by slightly disturbed coal measures and Cretaceous rocks.

The lowest rocks in the section of the Ouachita range are Lower Silurian sediments in the heart of the uplift near the Tertiary border southwest of Little Rock. Above these are the Lower Silurian novaculites, 1,200 feet thick, which were the highest Silurian strata recognized by L. S. Griswold, of the Arkansas Geological Survey. In Indian Territory above the novaculites are about 5,000 feet of shale. These are in turn succeeded by about 5,000 feet of sandstone. Above these sandstones comes limestone of Ordovician age. Lower Helderberg cherts and limestone, Mississippian shales and coal measures, complete the section above the Ordovician.

The section of the rocks in the Arbuckle mountain uplift from the Lower Helderberg upward is a repetition of the Ouachita mountain section upward from the same terrane, but is not nearly so thick. Below the lower Helderberg is a mass of Ordovician limestone with shale and sandstone of minor importance, reaching a total thickness of more than 6,500 feet. These cannot be compared lithologically with the known Ordovician in the Ouachita mountain uplift. The limestones rest unconformably upon a mass of older granites with a variable intervening bed of arkose and conglomerate.

The structure of the Ouachita range is typically Appalachian. The rocks for the most part have been sharply folded and very extensively overthrust. The structure of the eastern

half of the Arbuckle uplift consists of relatively wide shallow folds. The axial portions of the synclines have been dropped down by opposite normal faults. In some instances the vertical displacements amount to many thousand feet. The softer and thinner formations, from the upper Ordovician to the coal measures, which occupy the downthrown blocks, were crumpled into narrow folds prior to the faulting.

F. L. RANSOME,  
DAVID WHITE,  
Secretaries.

SECTION OF BIOLOGY OF THE NEW YORK  
ACADEMY OF SCIENCES.

THE regular monthly meeting for January was held on the 14th, Professor C. L. Bristol presiding. Dr. H. E. Crampton was elected Secretary, in place of Professor F. E. Lloyd, resigned.

The following program was offered:

- (1) 'A New Species of *Phoronis*': H. B. TORREY.
- (2) 'Characters and Relationships of the Belodont Reptiles': J. H. MCGREGOR.
- (3) 'Notes on *Chrysoma paucifosculosa*'; 'On the Occurrence of Nectaries in *Pteris aquilina*': F. E. LLOYD.

Mr. Torrey described a new species of *Phoronis*, the first that has been collected upon the western coast of America. It is intermediate in its characters between the European and eastern American species, and those found in Australia and the Philippines. In size it agrees with *P. Buskii*. The lophophore, though spirally coiled—thus differing from that of the European species—is less complex than that of *P. Buskii*, and the tentacles are fewer in number (200). The longitudinal muscles are stouter than those of *P. Buskii*, agreeing more nearly with the condition in *P. architecta* of the east coast. The new species agrees with this latter species in habit, in the possession of a longitudinal ciliated ridge in the digestive tract, and in the possible separation of the sexes.

Dr. McGregor presented the results of a recent study of the Belodonts, a group of fossil reptiles occurring in the Triassic of Germany and North America. The Belodonts have usually been regarded as ancestral crocodiles, though many students of the group have ad-

mitted possible affinities with Rhynchocephalia and Dinosauria. The material used in the present study, chiefly from the genera *Mystriosuchus* and *Rhytinodon*, yielded some parts new to science, *e. g.*, the atlas and clavicle. The presence of two cervical intercentra and a large clavicle tends to ally the group more closely to the Rhynchocephalia. The hyoid apparatus was found to be suspended from the skull as in Hatteria; and there is strong evidence that the carpals (and probably also the tarsals) remained cartilaginous throughout life. Some doubt was expressed regarding the Belodont ancestry of the crocodiles, though it was admitted that the Belodonts stand near the crocodilian stem. The suggestion was made that the Belodonts may belong on or very close to the line of descent of the Ichthyosauria, occupying a position midway between some Permian land-living Rhynchocephalian and the marine Ichthyosauria of the Jurassic. In support of this theory, many structures of the Belodonts were shown to be such as one would expect to find in an ancestor of the Ichthyosauria, *e. g.*, position of the nares, elongated premaxillary, bicipital ribs, form of the shoulder-girdle, etc. Some other structures, apparently incompatible with this view, were shown to be in reality not inconsistent with it.

In a discussion of Dr. McGregor's paper, Professor Osborn emphasized the importance of the Belodonts, and the conflicting nature of the opinions regarding them. Huxley placed them near the crocodiles, as evidenced by the choice of the name *Parasuchia* for the group. The paleontologists of the Stuttgart school relate them to Dinosauria. Dr. McGregor is the first to bring out the idea of their relationship to the Ichthyosauria; and, based as it is upon many new characters described for the first time, the theory is of great interest and importance.

Professor Lloyd stated that the chief point of interest in *Chrysoma paucifosculosa*, a sub tropical marine form, is in the structure of the leaves. The surface of these is sculptured in the form of a mosaic. This appearance is caused by deep and regularly-arranged involutions of the epidermis. At the bottom of each sulcus are to be found flagellated and glandular hairs, such as have been described by Vesque for



the Compositæ. Transverse sections show that each element of the mosaic contains chlorenchyma, which, though packed densely around the edges, forms in the middle a large air-chamber, suggesting in appearance the air-chambers of certain Hepaticæ. The leaf, a bifacial one, is maintained in a vertical position.

In a second paper, Professor Lloyd drew attention to the occurrence, in *Pteris aquilina*, of nectaries near the bases of the pinnæ. The activity of these glands reaches a maximum during the development of the frond in spring and early summer, at which time large drops of syrupy nectar exude from the openings, which are modified stomata. The object of the speaker was to call the attention of teachers of general biology to the presence, in a much-used laboratory type, of organs which, though discovered by Francis Darwin in 1877, were generally overlooked.

In discussion of Professor Lloyd's first paper, Professor Britton remarked that the author's results were of value as throwing light upon the vexed question of the relationship of *Chrysonoma* to the golden-rods (*Solidago*). The two groups were probably distinct. It was also recalled that the late Dr. Gregory had worked extensively upon this problem, but her full results had never been published.

HENRY E. CRAMPTON,  
Secretary.

#### THE ACADEMY OF SCIENCE OF ST. LOUIS.

At the meeting of the Academy of Science of St. Louis of January 21, 1901, twenty-seven persons present, the following subjects were presented:

Rev. M. S. Brennan read a short sketch of the progress of astronomy in the United States, in which the material equipment and the discoveries made in that science in this country during the past century were passed in review.

A paper by Professor T. G. Poats, entitled 'Isogonic Projection,' was presented in abstract.

Professor F. E. Nipher showed by means of the lantern a series of negatives printed by contact from a lantern slide or positive picture, by the light of a 300 candle incandescent lamp. The unit of exposure adopted was one lamp-meter-second. The exposures varied from

0.0054 to 4,800. All were developed in the dark room with hydrochinon, those above 0.1 exposure having in the bath one drop of saturated hypo to the ounce of bath. The plate having an exposure of 0.1 seemed to be normally exposed. An exposure 210 gave a negative showing some fogging, but a print from it by ordinary methods gave a very satisfactory result. With longer exposures, the plate began to reverse, locally. With an exposure of 3,600, which was an exposure of one hour at a distance of one meter from a 300-candle lamp, half of the plate still showed as a negative. The shadow on the gown of a figure in the landscape showed white as a negative, and the part of the gown in sunshine showed white as a positive. The penumbra between light and shadow was darker. All the details were sharp, but lights and shadows were somewhat incongruous. With an exposure of 4,800 the details had not yet all reversed, but the greater part of the plate had become a positive.

The greatest exposure giving a negative which would yield an acceptable print was 210, which was 39,000 times the least exposure which would give a good negative. All exposures of 210 and over gave complete positives when the plates were developed 1.41 meter from a 16-candle lamp, or in stronger light. As good a picture as has been obtained had an exposure of 4,800, and was developed within half a meter of a 300-candle lamp. A fair picture had even been obtained from a two-hour exposure to direct sunlight with a Cramer 'Crown' plate. This plate was developed in a perfectly dark room.

It was stated that hypo in the developing bath did not affect the zero condition, or change the character as regards positive and negative. When no hypo is used, the plate fogs so quickly that the picture is invisible, before it has time to fully develop. After fixing, the thin shadowy picture showing on the fogged plate has the same local positive and negative characters that are shown on the clearly defined picture of the same exposure, when developed in the hypo-hydrochinon bath.

The greatest exposures giving good results that have been measured with reasonable accuracy were about 900,000 times as great as the

least exposure giving a good negative in the dark-room. This factor can certainly be trebled. A plate having any intermediate exposure can be developed either as a good positive in the light, or as a good negative in the dark-room.

It was stated that the best results with plates near the zero condition had been reached with a rather strong bath, with two drops of saturated hypo to the ounce of bath.

Three persons were elected to active membership.

WILLIAM TRELEASE,  
*Recording Secretary.*

SCIENCE CLUB OF THE UNIVERSITY OF  
WISCONSIN.

THE January meeting of the Club was held on the evening of the 24th inst., President Birge in the chair. Professor J. M. Coulter, of the University of Chicago, delivered his address on 'The Teaching of Science' (substantially as published in this JOURNAL, Vol. XII., p. 281). At the close the president related an incident from his own early experience to show how completely scientific education was misunderstood by the classicists, and he expressed the opinion that the quality of science teaching in the universities is not so poor as Professor Coulter would have us believe. The president extended the very evident thanks of the audience to the speaker for his address.

E. R. MAURER,  
*Secretary.*

DISCUSSION AND CORRESPONDENCE.

THE SIDGWICK MEMORIAL.

TO THE EDITOR OF SCIENCE: I have been asked to act in America for the English committee on a memorial to the late Professor Henry Sidgwick. Other Americans are probably acting also, but of this I do not know. A meeting in the interests of such a memorial was recently held at Cambridge, and an influential committee was appointed. The memorial will probably take the form of an endowed scholarship at Cambridge, though other projects are also before the committee. Seeing the services Sidgwick rendered to education—notably woman's education—and the very large use made of his books in American universities, it

is hoped that a considerable sum will be raised in this country. Contributions, to be forwarded through me, may be sent direct to Princeton, New Jersey.

J. MARK BALDWIN.

SHORTER ARTICLES.

RADIO-ACTIVE MINERALS.

IN searching for radio-active substances with one of Professor Rood's new electrometers, an instrument particularly well adapted to the purpose, several minerals not hitherto noted were found to be radio-active. Professor Rood suggested that I should try columbite, and gave me some specimens. The electrometer immediately shows that the air in the neighborhood of the mineral is ionized, and later photographic tests confirm the radio-activity of columbite. A chemical analysis of the specimens has not yet been made, but according to Dana, columbite does not contain uranium or thorium.

Specimens of erbium oxide and niobium oxide, from the museum of the chemical department, also show with the electrometer a slight ionizing effect. Further investigations are being made.

GEO. B. PEGRAM.

PHYSICAL LABORATORY OF COLUMBIA  
UNIVERSITY, January 26, 1901.

THE MUSICAL BOW IN CALIFORNIA.

IN view of the present discussion in regard to the existence of the musical bow in America, and of its independent development on this continent, the occurrence (quite rare at present, however,) of a form of this instrument among the Maidu Indians of Northern California appears worthy of a brief note.

The bow as used by the Maidu is a simple bow of cedar, some 2½ feet in length, at present strung with wire, but formerly with a fine sinew cord. In playing the instrument it is held in the left hand (the hand grasping the center of the bow, thumb inside and palm facing forward), the bow extending horizontally to the left. The right-hand end of the bow is placed in the open mouth, and the bow string tapped rapidly with a small flexible twig held in the right hand. By varying the size of the resonance chamber (the mouth) with the aid of the tongue, and by opening or closing the mouth to a greater or

less extent, notes are produced as in a Jew's harp. The tones are, however, very faint, and are audible only at a short distance.

The use of this bow, known as 'kăwōtōne panda,' is restricted to the medicine-men or shamans, and other persons are rarely allowed to see and never allowed to touch the instrument. The sacredness of this bow, the fact that it is used by the medicine-men only in communicating with and praying to the 'kukini' or spirits, and that its manufacture is accompanied by ceremonial observances, including the rubbing of the bow with human blood—all seem to point to the bow as being of native origin. The limited contact of these Indians with the negro, and the place held by the instrument in the religious life of the people, here as well as elsewhere in America, would seem to militate against the view that the musical bow is on this continent the result of acculturation.

ROLAND B. DIXON.

#### CURRENT NOTES ON PHYSIOGRAPHY.

##### THE YOSEMITE VALLEY.

A CAREFUL study of 'the Pleistocene Geology of the south central Sierra Nevada with especial reference to the origin of the Yosemite valley,' by H. W. Turner (*Proc. Cal. Acad. Sci.*, 3d ser., Geology, i, 1900, 261-321, 8 pl.) is of much interest, but still leaves this interesting problem without definite solution. The suggestion that the valley is a *graben* is discarded, yet direct proof or disproof of this view can be gained only when identifiable structures are found in the rocks of the valley floor and of the uplands, as has been done in the case of the Rhine *graben*. It is concluded that 'the canyons of the Sierra Nevada, like most other canyons the world over, were formed in the main by river erosion'; but it is suggested that after a rather extended glaciation of the Sierra highlands, narrow and deep canyons were cut in an interglacial epoch, and that ice streams of a second glacial epoch 'greatly modified the new-cut canyons of the interglacial epoch, and gave them, within the glaciated area, substantially their present form.' The contrast between the broad U-shaped section of the Yosemite and the sharp V-shape of the Merced canyon farther

west seems to favor this view. Moraines are found on the valley floor at six points, the westernmost being where the open valley ends and the V-canyon of the Merced begins; it is pointed out that the size of the moraines would be greater if their bases were not generally buried in river sands and silts.

Gannett, commenting on Turner's article, forcibly maintains the glacial origin of the Yosemite, appealing especially to its hanging lateral valleys in support of his opinion (*Geogr. Mag.*, XII., 1901, 86-87).

##### PATAGONIA.

THE geographical results of the Princeton expeditions to Patagonia are presented by Hatcher in most interesting form. ('Some geographic features of southern Patagonia, with a discussion of their origin,' *Nat. Geogr. Mag.*, xi, 1900, 41-55.) The eastern coast shows a line of sea cliffs, from 300 to 500 feet high, seldom broken except at river mouths where the few harbors are found. The strata in the cliffs are nearly horizontal, but by following them for long distances two marine formations separated by a continental formation are discovered, all being covered by 20 or 30 feet of unstratified boulders and clays, the great shingle formation, of glacial and aqueous origin. Vast plains stretch inland from the coast, subarid, bearing thin grass and scattered bushes; guanacos and rheas are found here in abundance. The plains are broken by escarpments, often several hundred feet high, trending north and south, and interpreted as sea cliffs formed during the latest emergence of the region. Recent lavas cover considerable areas in the central interior, forming scoriaceous plains of large extent, here and there dissected by canyons. Indeed, all these features are broken by the valleys of rivers coming from the back country. One of these valleys, that of San Julian, has at present no stream; its waters having been captured by a northern tributary of the Santa Cruz, 100 miles in from the coast. Numerous depressions holding small salt lakes are interpreted as remnants of an ancient valley system, now masked by deposits formed during the last submergence of the region. The district piedmont to the Andes is sheeted with morainic

drift, the most fertile part of the plains; water is here plenty in small lakes. The peculiar drainage system of the Andean region is explained chiefly by the Pliocene depression and elevation of a previously dissected mountain range. Glacial erosion is not especially considered as contributing to the present topography.

W. M. DAVIS.

#### ZOOLOGICAL NOTES.

DURING the past year, L. Camerano has published (in *Atti della R. Accademia delle Scienze di Torino*, Vol. XXXV., and *Arch. Ital. de Biol.*, Vol. XXXIII., fasc. 2) papers on the 'somatic coefficient.' These are based on a plea made by Andres that ichthyologists and others express the proportion of parts of the body not in relation to any other convenient organ, as is often done, but rather in thousandths of the total body length. Thus, if  $x$  is the proportion to be expressed,  $l$  is the observed dimension, and  $L$  is the total length of the body, in millimeters, then,  $x = \frac{1,000}{L} l$ . The factor  $\frac{10,000}{L}$

is the somatic coefficient and is constant for all organs of the body. Camerano makes the suggestion that the number 360, being readily divisible by more integers, is preferable to 1,000 and he publishes a convenient table of values of  $\frac{360}{L}$  for every quarter unit from 1 to 360. It is to be hoped, however, that those who express the dimension of organs in multiples of the somatic coefficient will not fail to give also the absolute lengths of the organs, as these are of no less importance.

C. B. D.

In describing to the Zoological Society of London, on January 15th, the collection of fishes brought home from Lakes Tanganyika and Kivu by the Tanganyika exploring expedition, under the leadership of Mr. J. E. S. Moore, Mr. G. A. Boulenger pointed out that the study of this important collection did not modify the conclusions embodied in his first report published in 1898. The exploration of Lake Kivu had thrown no light on the origin of the Tanganyikan fauna; the smaller lake proved to be very thinly populated with fishes, which all belonged to widely distributed genera,

the species showing a mixture of Nile and Tanganyika elements, with two that might prove to be endemic. The list of the fishes from the two lakes comprised 91 species, 74 of which had been named by the author. The collection now described consisted of examples of 50 species, 26 of which were new to science, 2 being made the types of additional genera of the family *Cichlidae*.

#### A BILL ESTABLISHING A NATIONAL OBSERVATORY.

WE are now able to publish the text of the bill introduced into the Senate by Mr. Morgan on January 21st. The provisions seem to be all that could be asked, and it is to be hoped that men of science will unite in urging its passage. Personal letters to members of Congress and resolutions adopted by societies and institutions and forwarded to the Committee on Naval Affairs are the most effective way to advocate the measure. The bill is intended 'to organize the National Observatory of the United States' and reads as follows:

*Be it enacted by the Senate and House of Representatives of the United States of America in Congress assembled,* That the United States Naval Observatory shall hereafter be known as the National Observatory of the United States, and shall be governed by a Director thereof, who shall report directly to, and be under the supervision of, the Secretary of the Navy.

SECTION 2, That the Director of the National Observatory shall be an eminent astronomer, appointed by the President, by and with the advice and consent of the Senate, at a salary of five thousand dollars per annum, and shall be selected from the astronomers of the National Academy of Sciences unless, in the judgment of the President, an American astronomer of higher scientific and executive qualifications shall be found.

SECTION 3, That the Secretary of the Navy may detail for duty as astronomers at the National Observatory such professors of mathematics and other officers of the Navy as he shall deem necessary in the interests of the public service; but on and after the

passage of this Act no appointments shall be made of such professors unless required for service at the Naval Academy.

SECTION 4. That there shall be a Board of Visitors of the National Observatory, to consist of one Senator, one member of the House of Representatives, and three astronomers of eminence, to be selected by the Secretary of the Navy. The Board of Visitors shall make an annual visitation, or more frequent visitations, of the Observatory, advise with the Director thereof as to the scientific work to be prosecuted, and report to the Secretary of the Navy on the work and needs of the Observatory on or before the first day of November in each year. The members of the said Board may receive an allowance not exceeding ten dollars per day each during their actual presence in the City of Washington while engaged on the duty of the Board and their necessary traveling expenses; but no officer of the Government appointed on the Board shall receive any additional compensation for such duty above his actual expenses.

#### THE REORGANIZATION OF THE DEPARTMENT OF AGRICULTURE.

THE Agricultural Appropriation Bill, as presented to the Committee of the Whole of the House of Representatives, contained provisions for the reorganization of the Department of Agriculture, which we much regret were afterwards withdrawn, owing to the point of order being raised that new legislation had been attached to an appropriation bill. It is well-known that the salaries in the Department are too small, and that the Government is constantly losing the services of its trained scientific men. Thus Dr. Loew received a salary of \$1,800 in the Department of Agriculture, and has now accepted a position under the Japanese Government at a salary of \$7,000. The plan proposed by the Committee on Agriculture would have created four new bureaus, the chiefs of which would have received a salary of \$3,500 a year, and who would have been the chiefs of divisions who now receive \$2,500 a year, and

the salaries of the other scientific experts would have been increased by sums varying from \$200 to \$500 each. The total increase in salaries would have been \$26,000. In recommending this plan the Secretary of Agriculture, the Hon. James Wilson, wrote to the Chairman of the Committee on Agriculture, the Hon. J. W. Wadsworth, on January 15th, as follows:

Having gone over with care the proposed plan for the reorganization of the Department of Agriculture, I am pleased to state that it has my entire approval. The grouping together of scientists in kindred lines of work will enable us to bring to bear on each subject considered and on each undertaking before it is begun the experience of all the division chiefs interested, avoiding duplication of work, which quite frequently occurs under our present divisional system, and in that regard will enable us to economize.

The salaries as proposed are not in excess of what is paid to scientists doing like work in educational and experiment station institutions throughout the country, and are, in fact, much below the salaries paid by many institutions in the land that seek men of the greatest experience and highest attainments. The work now being carried on by this Department and the amount of money being expended by Congress justify the employment of the foremost scientists in every line.

We are not able to retain our best men at the present time. Other countries, as well as home institutions, take them away from us by offering more money than our statutory salaries. If it were possible for this Department to go to the country, through the Civil Service Commission, and get scientists well informed regarding the work we are doing for the farmers, the loss of a man now and again would not be so serious.

But this Department is compelled, in many of its divisions, to educate its own men. When they leave us, on account of getting better pay elsewhere, our work in some cases stops until new men can be trained.

I therefore sincerely hope that you will succeed in having the proposed rearrangement enacted into law. It will do much to facilitate our work, and I believe will in the end be economical.

It is to be hoped that the reorganization of the Department, approved by the Secretary of Agriculture and the House Committee on Agriculture, will be introduced as a special bill. Scientific men at Washington can not well advocate a measure that increases their salaries, and there is consequently every reason for those interested in science and not connected with the Government service to use all efforts to secure the introduction and passage of a measure that is essential for efficiency and economy.

#### SCIENTIFIC NOTES AND NEWS.

At a meeting of the Prussian Academy of Sciences, held on January 24th, the announcement was made that the Helmholtz Medal had been conferred upon Sir George Gabriel Stokes, of Cambridge University. The medal has hitherto been conferred only on Professor Virchow and Lord Kelvin.

At a meeting of the Council of the Astronomical and Astrophysical Society of America, held in New York, on January 29th, at which all members of the Council save one were present, the previous action by which Denver was designated as the next place of meeting for the Society was reconsidered, and by unanimous vote the Council determined to hold no meeting during the summer of 1901. In lieu of the customary summer meeting of the Society, a winter meeting will be held in the City of Washington during the next Christmas holidays, and Professors Newcomb and Brown were appointed a local committee to arrange the details of such meeting. The Committee upon Legislation affecting astronomical interests made through its chairman a report of progress, and was continued. Professor W. W. Campbell, director of the Lick Observatory, was elected a member of the Council in place of the late Professor James E. Keeler.

PROFESSOR R. W. WOOD, of the University of Wisconsin, has decided not to accept the invitation of the director of the U. S. Naval Observatory to go to Sumatra as a member of the eclipse expedition, but he has fitted up a polarizing spectroscope to test the method, recently

described by him in SCIENCE, of photographing the Fraunhofer lines in the spectrum of the corona, by placing a Nicol prism in front of the slit of the instrument in such a position as to transmit the polarized light reflected by the coronal particles. Dr. Norman E. Gilbert, of the Johns Hopkins University, will operate the instrument, the observations being both visual and photographic. The visual work will be confined to the few moments at second and third contact, when the flash spectrum is seen.

THE Reale Accademia dei Lincei of Rome has elected to membership the Duke of the Abruzzi.

DR. M. CANTOR, honorary professor of mathematics in the University of Heidelberg, has been elected a corresponding member of the St. Petersburg Academy of Sciences.

MR. EVELYN B. BALDWIN returned to New York on February 3rd, after having arranged, while abroad, for two vessels for his North Polar Expedition.

PROFESSOR FRANCIS E. LLOYD, of Teachers College, Columbia University, has gone abroad on a leave of absence, and will spend the next eight months at Bonn.

DR. WILLIAM R. BROOKS, director of the Smith Observatory and professor of astronomy in Hobart College, Geneva, N. Y., recently delivered two illustrated lectures in the opera house of that city on 'The Wonders of the Sun and the late Eclipse.' The stereopticon views included a large number of photographs of the eclipse in its partial phases, made at the Smith Observatory, and others taken at different points along the total belt.

A BRONZE bas-relief of the late Professor M. S. Newberry, the eminent geologist, has been presented to Columbia University by his children.

A BUST of Dr. Horace Green, who died in 1866, was presented to the New York Academy of Medicine on February 8th by Mrs. Green and George Walton Green. Dr. D. B. St. John Roosa made a commemorative address.

MILES ROCK, whose death in Guatemala was noted in SCIENCE of February 8th, was from 1883 to 1898 chief engineer and president of the Guatemala Commission to locate the

boundary between that country and Mexico. His services to Guatémala were so important that he was given an imposing public funeral at the expense of the government, the ceremonies taking place at the National School of Engineers and being attended by President Cabrera and his cabinet.

PROFESSOR MAX VON PETTENKOFER, of the University of Munich, the eminent authority on hygiene and bacteriology, has committed suicide at Munich. He was eighty-three years of age.

MR. R. D. LACOE, well known among geologists and paleontologists for his great aid in the advancement of the sciences of paleobotany and pale-entomology, died at his home in West Pittston, Pa., on the fifth of February.

PROFESSOR JOHN POTTER MARSHALL, until his retirement in 1899, professor of geology and mineralogy in Tufts College, died at his home at Tufts College on February 4th in his seventy-seventh year. He graduated from Yale College in 1844 and was one of the founders of Tufts College, where at first he had charge of all the scientific work, including mathematics, and where he held a professorship continuously for forty-five years.

PROFESSOR EDWARD ELBRIDGE SALISBURY, for sixty years professor of Arabic and Sanscrit at Yale University, died at New Haven on February 5th.

DR. WALTER MYERS, a member of the expedition of the Liverpool School of Tropical Medicine to Brazil, has died from yellow fever while engaged in investigating the disease. Dr. Myers was a graduate of the University of Cambridge and was only twenty-nine years of age.

THE death is announced in his seventieth year of Dr. Bernhardt Danckelmann, for the last 35 years director of the Prussian Royal Academy of Forestry at Eberswalde. He was one of the first to advocate the training of foresters in special colleges, and was the author of important works on forestry.

THE London *Times* announces the death, at Bois de Colombes at the age of 74, of M. Gramme, the eminent Belgian electrician. Brought up as a carpenter, he attended scientific lectures at Liège, where he showed a talent

for machinery, and then went to Paris to a manufactory of light house electric lamps. He next worked under Ruhmkorff and Disderi. In 1867 and 1872 he patented electric batteries and the dynamo. For the latter he received 20,000 f. from the French Government and the Volta prize of 20,000 f. from the Academy of Sciences.

THE will of the late Charles F. Emerson gives \$100,000 to the town of Castine, Maine, for a library.

WE learn from the *Electrical World* that the private electro-chemical laboratory of Mr. C. P. Steinmetz has been destroyed by fire, which probably had its origin in a coal stove. A considerable part of the apparatus was saved, but a number of interesting investigations being carried out in the laboratory are indefinitely delayed.

THE National Academy of Sciences has made a grant of \$500 to the University of California from the Draper fund for the promotion of scientific research, the money to be used in the construction of a first-class one-prism spectrograph for the Lick Observatory.

LORD RANFURLY, Governor of New Zealand, has secured a fine collection of birds for the British Museum, including the *Merganser Australis*, which is almost extinct, and specimens of two species new to science.

THE collection of birds and mammals formed by the late Geo. A. Boardman, of Calais, Me., will be removed to Fredericton, N. B., and will occupy a conspicuous place in one of the Government buildings.

#### UNIVERSITY AND EDUCATIONAL NEWS.

MESSRS. WILLIAM KEYSER, William Wyman and Francis W. Jenks have offered to give the Johns Hopkins University a new site, on condition that \$1,000,000 be collected for the University. The proposed site is some hundred and seventy acres in extent, and is valued at \$750,000. It is in the northern part of the city of Baltimore and is well adapted for the purposes of the University.

It will be remembered that at the recent election an amendment to the constitution of the State of California was adopted, permitting the

Legislature to exempt portions of the property of Leland Stanford Junior University from taxation. A bill has now been passed to the third reading in the Assembly by a vote of 47 to 15, exempting from taxation the real estate occupied by the University and bonds held by it.

THE higher court has sustained the decision upholding the validity of the will of Colonel Joseph M. Bennett which, it will be remembered, left a large estate to the University of Pennsylvania.

By the will of Daniel A. Buckley, late publisher of the Cambridge (Mass.) *News*, an estate, valued at between \$50,000 and \$60,000, is bequeathed to the city of Cambridge to be used for the education at Harvard of such graduates of non-sectarian schools as a committee may deem worthy.

It appears that the school fund of the State of Minnesota has been increased by the discovery of iron ore. Ten million tons have been sold in position for \$2,500,000, and it is said that at least 50,000,000 tons can be disposed of in the same way. The State school fund now amounts to \$12,500,000, invested in bonds and securities, and the school and university lands are valued at more than \$20,000,000.

THE Rensselaer Polytechnic Institute at Troy, N. Y., has in operation a new electrical laboratory containing sixteen machines, generators and transformers, together with a full equipment for practical tests. The laboratory for the testing of materials of engineering has been increased by the addition of one 300,000 pound testing machine and one 100,000 pound testing machine; and a 10,000 pound wire testing machine. There is also a new cement testing laboratory fully equipped for the most approved modern tests.

THE ladies of the Temple Emanu-El in San Francisco, one of the largest Jewish congregations on the Pacific Coast, have founded two graduate fellowships in Semitic languages in the University of California. They have pledged themselves to pay to the University in cash, within two years, the full amount of the endowment, \$15,000. Some years ago the ladies of the congregation presented to the university a

Semitic library of over three thousand volumes. Jacob Voorsanger, D.D., rabbi of the Temple Emanu-El, has for some years served without remuneration as professor of Semitic languages and literature in the university.

LORD GEORGE HAMILTON has refused to grant the inquiry asked for by the dismissed members of the teaching staff at the Royal Indian Engineering College at Coopers Hill, but it is understood that leading English scientific men will continue the agitation for such an inquiry.

JOHN HUDSON PECK has resigned the presidency of the Rensselaer Polytechnic Institute, and a committee of the Board of Trustees is considering a successor.

DR. FRED. C. ZAPFFE has been appointed professor of histology in the medical school of the University of Illinois.

DR. WALTER T. KRETZ has been appointed lecturer in astronomy in Columbia University.

W. SMYTHE JOHNSON, Ph.D. (Yale), has been appointed to the chair of psychology in the State Normal School at Natchitoches, and Dr. Matataro Matsumoto, assistant in the psychological laboratory of Yale University, has been appointed professor of psychology in the Imperial Normal School of Tokyo, Japan.

MR. P. V. BEVAN has been appointed an assistant demonstrator in physics at Cambridge University, and Mr. H. A. Wilson, has been elected to the Clerk Maxwell studentship in experimental physics.

MR. W. H. WILLCOX, M.B., B.Sc. (Lond.), has been elected to the post of lecturer on chemistry and physics at St. Mary's Hospital Medical School, London.

DR. G. C. SCHMIDT, of Eberswalde, has been elected to an associate professorship of theoretical physics in the University of Erlangen. Dr. H. Boruttan, docent in the University of Göttingen, has been promoted to a professorship of physiology. Dr. Heyn, of the Mechanical Institute of Berlin, has been appointed professor of engineering in the Technical Institute at Stuttgart. At the same institution Dr. Englisch has qualified as docent in scientific photography. Dr. Max Reess, professor of botany in the University of Erlangen, has retired.



# SCIENCE

A WEEKLY JOURNAL DEVOTED TO THE ADVANCEMENT OF SCIENCE, PUBLISHING THE OFFICIAL NOTICES AND PROCEEDINGS OF THE AMERICAN ASSOCIATION FOR THE ADVANCEMENT OF SCIENCE.

EDITORIAL COMMITTEE: S. NEWCOMB, Mathematics; R. S. WOODWARD, Mechanics; E. C. PICKERING, Astronomy; T. C. MENDENHALL, Physics; R. H. THURSTON, Engineering; IRA REMSEN, Chemistry; JOSEPH LE CONTE, Geology; W. M. DAVIS, Physiography; HENRY F. OSBORN, Paleontology; W. K. BROOKS, C. HART MERRIAM, Zoology; S. H. SCUDDER, Entomology; C. E. BESSEY, N. L. BRITTON, Botany; C. S. MINOT, Embryology, Histology; H. P. BOWDITCH, Physiology; J. S. BILLINGS, Hygiene; WILLIAM H. WELCH, Pathology; J. McKEEN CATTELL, Psychology; J. W. POWELL, Anthropology.

FRIDAY, FEBRUARY 22, 1901.

THE MIND OF PRIMITIVE MAN.\*

## CONTENTS:

<i>The Mind of Primitive Man</i> : PROFESSOR FRANZ BOAS.....	281
<i>Association of American Anatomists</i> : DR. D. S. LAMB.....	289
<i>The Eleventh Meeting of the American Morphological Society</i> : DR. THOS. H. MONTGOMERY, JR.....	296
<i>The Projection of Ripples by a Grating</i> : PROFESSOR C. BARUS.....	297
<i>Reviews of Current Botanical Literature</i> : PROFESSOR CHARLES E. BESSEY.....	298
<i>Scientific Books</i> :—	
<i>The Society for the Promotion of Engineering Education</i> : PROFESSOR R. H. THURSTON. <i>Kant's Cosmogony</i> : PROFESSOR R. M. WENLEY. <i>Waddell's School Chemistry</i> : J. E. G. <i>Books Received</i> .....	301
<i>Scientific Journals and Articles</i> .....	305
<i>Societies and Academies</i> :—	
<i>The Philosophical Society of Washington</i> : CHAS. K. WEAD. <i>Biological Society of Washington</i> : F. A. LUCAS. <i>Anthropological Society of Washington</i> : WALTER HOUGH. <i>Chemical Society of Washington</i> : DR. WM. H. KRUG. <i>Section of Anthropology and Psychology of the New York Academy of Sciences</i> : PROFESSOR CHAS. H. JUDD.....	306
<i>Discussion and Correspondence</i> :—	
<i>Free Speech in Universities</i> : PROFESSOR F. W. CLARKE.....	309
<i>Shorter Articles</i> :—	
<i>The Relation of Seediness to Quality in Melons</i> : PROFESSOR E. S. GOFF. <i>Predetermined Evaluation</i> : PROFESSOR T. D. A. COCKERELL.....	310
<i>Notes on Physics</i> :—	
<i>Non-permanence of Weight</i> ; <i>The Electromagnetic Theory of Radiation</i> : W. S. F.....	312
<i>Notes on Inorganic Chemistry</i> : J. L. H.....	313
<i>The Naval Observatory</i> .....	314
<i>The Department of Agriculture</i> .....	315
<i>Scientific Notes and News</i> .....	315
<i>University and Educational News</i> .....	320

ONE of the chief aims of anthropology is the study of the mind of man under the varying conditions of race and of environment. The activities of the mind manifest themselves in thoughts and actions, and exhibit an infinite variety of form among the peoples of the world. In order to understand these clearly, the student must endeavor to divest himself entirely of opinions and emotions based upon the peculiar social environment into which he is born. He must adapt his own mind, so far as feasible, to that of the people whom he is studying. The more successful he is in freeing himself from the bias based on the group of ideas that constitute the civilization in which he lives, the more successful he will be in interpreting the beliefs and actions of man. He must follow lines of thought that are new to him. He must participate in new emotions, and understand how, under unwonted conditions, both lead to actions. Beliefs, customs, and the response of the individual to the events of daily life, give us ample opportunity to observe the manifestations of the mind of man under varying conditions.

The thoughts and actions of civilized man and those found in more primitive forms of society prove that, in various

\*Mss. intended for publication and books, etc., intended for review should be sent to the responsible editor, Professor J. McKeen Cattell, Garrison-on-Hudson, N. Y.

\* Address of the retiring president before the American Folk-Lore Society, Baltimore, Dec. 27th.

groups of mankind, the mind responds quite differently when exposed to the same conditions. Lack of logical connection in its conclusions, lack of control of will, are apparently two of its fundamental characteristics in primitive society. In the formation of opinions, belief takes the place of logical demonstration. The emotional value of opinions is great, and consequently they quickly lead to action. The will appears unbalanced, there being a readiness to yield to strong emotions, and a stubborn resistance in trifling matters.

In the following remarks I propose to analyze the differences which characterize the mental life of man in various stages of culture. It is a pleasant duty to acknowledge here my indebtedness to my friends and colleagues in New York, particularly to Dr. Livingston Farrand, with whom the questions here propounded have been a frequent theme of animated discussion, so much so, that at the present time I find it impossible to say what share the suggestions of each had in the development of the conclusions reached.

There are two possible explanations of the different manifestations of the mind of man. It may be that the minds of different races show differences of organization; that is to say, the laws of mental activity may not be the same for all minds. But it may also be that the organization of mind is practically identical among all races of man; that mental activity follows the same laws everywhere, but that its manifestations depend upon the character of individual experience that is subjected to the action of these laws.

It is quite evident that the activities of the human mind depend upon these two elements. The organization of the mind may be defined as the group of laws which determine the modes of thought and of action, irrespective of the subject matter of mental activity. Subject to such laws are

the manner of discrimination between perceptions, the manner in which perceptions associate themselves with previous perceptions, the manner in which a stimulus leads to action, and the emotions produced by stimuli. These laws determine to a great extent the manifestations of the mind.

But, on the other hand, the influence of individual experience can easily be shown to be very great. The bulk of the experience of man is gained from oft-repeated impressions. It is one of the fundamental laws of psychology that the repetition of mental processes increases the facility with which these processes are performed, and decreases the degree of consciousness that accompanies them. This law expresses the well-known phenomena of habit. When a certain perception is frequently associated with another previous perception, the one will habitually call forth the other. When a certain stimulus frequently results in a certain action, it will tend to call forth habitually the same action. If a stimulus has often produced a certain emotion, it will tend to reproduce it every time.

The explanation of the activity of the mind of man, therefore, requires the discussion of two distinct problems. The first bears upon the question of unity or diversity of organization of the mind, while the second bears upon the diversity produced by the variety of contents of the mind as found in the various social and geographical environments. The task of the investigator consists largely in separating these two causes and in attributing to each its proper share in the development of the peculiarities of the mind. It is the latter problem principally which is of interest to the folk-lorist. When we define as folklore the total mass of traditional matter present in the mind of a given people at any given time, we recognize that this matter must influence the opinions and activities of the people more or less according to

its quantitative and qualitative value, and also that the actions of each individual must be influenced to a greater or less extent by the mass of traditional material present in his mind.

We will first devote our attention to the question, Do differences exist in the organization of the human mind? Since Waitz's thorough discussion of the question of the unity of the human species, there can be no doubt that in the main the mental characteristics of man are the same all over the world; but the question remains open, whether there is a sufficient difference in grade to allow us to assume that the present races of man may be considered as standing on different stages of the evolutionary series, whether we are justified in ascribing to civilized man a higher place in organization than to primitive man. In answering this question, we must clearly distinguish between the influences of civilization and of race. A number of anatomical facts point to the conclusion that the races of Africa, Australia, and Melanesia, are to a certain extent inferior to the races of Asia, America and Europe. We find that on the average the size of the brain of the negroid races is less than the size of the brain of the other races; and the difference in favor of the mongoloid and white races is so great, that we are justified in assuming a certain correlation between their mental ability and the increased size of their brain. At the same time it must be borne in mind that the variability of the mongoloid and white races on the one hand, and of the negroid races on the other, is so great, that only a comparatively speaking small number of individuals belonging to the latter have brains smaller than any brains found among the former; and that, on the other hand, only a few individuals of the mongoloid races have brains so large that they would not occur at all among the black races. That is to say, the bulk of the two

groups of races have brains of the same capacities, but individuals with heavy brains are proportionately more frequent among the mongoloid and white races than among the negroid races. Probably this difference in the size of the brain is accompanied by differences in structure, although no satisfactory information on this point is available. On the other hand, if we compare civilized people of any race with uncivilized people of the same race, we do not find any anatomical differences which would justify us in assuming any fundamental differences in mental constitution.

When we consider the same question from a purely psychological point of view, we recognize that one of the most fundamental traits which distinguish the human mind from the animal mind is common to all races of man. It is doubtful if any animal is able to form an abstract conception such as that of number, or any conception of the abstract relations of phenomena. We find that this is done by all races of man. A developed language with grammatical categories presupposes the ability of expressing abstract relations, and, since every known language has grammatical structure, we must assume that the faculty of forming abstract ideas is a common property of man. It has often been pointed out that the concept of number is developed very differently among different people. While in most languages we find numeral systems based upon the 10, we find that certain tribes in Brazil, and others in Australia, have numeral systems based on the 3, or even on the 2, which involve the impossibility of expressing high numbers. Although these numeral systems are very slightly developed as compared with our own, we must not forget that the abstract idea of number must be present among these people, because, without it, no method of counting is possible. It may be worth while to mention one or two

other facts taken from the grammars of primitive people, which will make it clear that all grammar presupposes abstractions. The three personal pronouns—I, thou, and he—occur in all human languages. The underlying idea of these pronouns is the clear distinction between the self as speaker, the person or object spoken to, and that spoken of. We also find that nouns are classified in a great many ways in different languages. While all the older Indo-European languages classify nouns according to sex, other languages classify nouns as animate or inanimate, or as human and not human, etc. Activities are also classified in many different ways. It is at once clear that every classification of this kind involves the formation of an abstract idea. The processes of abstraction are the same in all languages, and they do not need any further discussion, except in so far as we may be inclined to value differently the systems of classification and the results of abstraction.

The question whether the power to inhibit impulses is the same in all races of man is not so easily answered. It is an impression obtained by many travelers, and also based upon experiences gained in our own country, that primitive man and the less educated have in common a lack of control of emotions, that they give way more readily to an impulse than civilized man and the highly educated. I believe that this conception is based largely upon the neglect to consider the occasions on which a strong control of impulses is demanded in various forms of society. What I mean will become clear when I call your attention to the often described power of endurance exhibited by Indian captives who undergo torture at the hands of their enemies. When we want to gain a true estimate of the power of primitive man to control impulses, we must not compare the control required on certain occasions

among ourselves with the control exerted by primitive man on the same occasions. If, for instance, our social etiquette forbids the expression of feelings of personal discomfort and of anxiety, we must remember that personal etiquette among primitive man may not require any inhibition of the same kind. We must rather look for those occasions on which inhibition is required by the customs of primitive man. Such are, for instance, the numerous cases of taboo, that is, of prohibitions of the use of certain foods, or of the performance of certain kinds of work, which sometimes require a considerable amount of self-control. When an Eskimo community is on the point of starvation, and their religious proscriptions forbid them to make use of the seals that are basking on the ice, the amount of self-control of the whole community, which restrains them from killing these seals, is certainly very great. Cases of this kind are very numerous, and prove that primitive man has the ability to control his impulses, but that this control is exerted on occasions which depend upon the character of the social life of the people, and which do not coincide with the occasions on which we expect and require control of impulses.

The third point in which the mind of primitive man seems to differ from that of civilized man is in its power of choosing between perceptions and actions according to their value. On this power rests the whole domain of art and of ethics. An object or an action becomes of artistic value only when it is chosen from among other perceptions or other actions on account of its beauty. An action becomes moral only when it is chosen from among other possible actions on account of its ethical value. No matter how erude the standards of primitive man may be in regard to these two points, we recognize that all of them possess an art, and that all of them possess

ethical standards. It may be that their art is quite contrary to our artistic feeling. It may be that their ethical standards outrage our moral code. We must clearly distinguish between the æsthetic and ethical codes and the existence of an æsthetic and ethical standard.

Our brief consideration of the phenomena of abstraction, of inhibition and of choice, leads, then, to the conclusion that these functions of the human mind are common to the whole of humanity. It may be well to state here, that, according to our present method of considering biological and psychological phenomena, we must assume that these functions of the human mind have developed from lower conditions existing at a previous time, and that at one time there certainly must have been races and tribes in which the properties here described were not at all, or only slightly, developed; but it is also true, that among the present races of man, no matter how primitive they may be in comparison with ourselves, these faculties are highly developed.

It is not impossible that the degree of development of these functions may differ somewhat among different types of man; but I do not believe that we are able at the present time to form a just valuation of the power of abstraction, of control and of choice among different races. A comparison of their languages, customs, and activities suggests that these faculties may be unequally developed; but the differences are not sufficient to justify us in ascribing materially lower stages to some peoples, and higher stages to others. The conclusions reached from these considerations are therefore, on the whole, negative. We are not inclined to consider the mental organization of different races of man as differing in fundamental points.

We next turn to a consideration of the second question propounded here, namely, to an investigation of the influence of the

contents of the mind upon the formation of thoughts and actions. We will take these up in the same order in which we considered the previous question. We will first direct our attention to the phenomena of perception. It has been observed by many travelers that the senses of primitive man are remarkably well trained, that he is an excellent observer. The adeptness of the experienced hunter, who finds the tracks of his game where the eye of a European would not see the faintest indication, is an instance of this kind. While the power of perception of primitive man is excellent, it would seem that his power of logical interpretation of perceptions is deficient. I think it can be shown that the reason for this fact is not founded on any fundamental peculiarity of the mind of primitive man, but lies, rather, in the character of the ideas with which the new perception associates itself. In our own community a mass of observations and of thoughts is transmitted to the child. These thoughts are the result of careful observation and speculation of our present and of past generations; but they are transmitted to most individuals as traditional matter, much the same as folk-lore. The child associates new perceptions with this whole mass of traditional material, and interprets his observations by its means. I believe it is a mistake to assume that the interpretation made by each civilized individual is a complete logical process. We associate a phenomenon with a number of known facts, the interpretations of which are assumed as known, and we are satisfied with the reduction of a new fact to these previously known facts. For instance, if the average individual hears of the explosion of a previously unknown chemical, he is satisfied to reason that certain materials are known to have the property of exploding under proper conditions, and that consequently the unknown substance has the same qual-

ity. On the whole, I do not think that we should try to argue still further, and really try to give a full explanation of the causes of the explosion.

The difference in the mode of thought of primitive man and of civilized man seems to consist largely in the difference of character of the traditional material with which the new perception associates itself. The instruction given to the child of primitive man is not based on centuries of experimentation, but consists of the crude experience of generations. When a new experience enters the mind of primitive man, the same process which we observe among civilized man brings about an entirely different series of associations, and therefore results in a different type of explanation. A sudden explosion will associate itself in his mind, perhaps, with tales which he has heard in regard to the mythical history of the world, and consequently will be accompanied by superstitious fear. When we recognize that, neither among civilized man nor among primitive man, the average individual carries to completion the attempt at causal explanation of phenomena, but carries it only so far as to amalgamate it with other previously known facts, we recognize that the result of the whole process depends entirely upon the character of the traditional material: herein lies the immense importance of folk-lore in determining the mode of thought. Herein lies particularly the enormous influence of current philosophic opinion upon the masses of the people, and herein lies the influence of the dominant scientific theory upon the character of scientific work.

It would be in vain to try to understand the development of modern science without an intelligent understanding of modern philosophy; it would be in vain to try to understand the history of medieval science without an intelligent knowledge of medieval theology; and so it is in vain to try to

understand primitive science without an intelligent knowledge of primitive mythology. Mythology, theology and philosophy are different terms for the same influences which shape the current of human thought, and which determine the character of the attempts of man to explain the phenomena of nature. To primitive man—who has been taught to consider the heavenly orbs as animate beings, who sees in every animal a being more powerful than man, to whom the mountains, trees and stones are endowed with life—explanations of phenomena will suggest themselves entirely different from those to which we are accustomed, since we base our conclusions upon the existence of matter and force as bringing about the observed results. If we do not consider it possible to explain the whole range of phenomena as the result of matter and force alone, all our explanations of natural phenomena must take a different aspect.

In scientific inquiries we should always be clear in our own minds of the fact that we do not carry the analysis of any given phenomenon to completion; but that we always embody a number of hypotheses and theories in our explanations. In fact, if we were to do so, progress would hardly become possible, because every phenomenon would require an endless amount of time for thorough treatment. We are only too apt, however, to forget entirely the general, and, for most of us, purely traditional, theoretical basis which is the foundation of our reasoning, and to assume that the result of our reasoning is absolute truth. In this we commit the same error that is committed, and has been committed, by all the less civilized people. They are more easily satisfied than we are at the present time, but they also assume as true the traditional element which enters into their explanations, and therefore accept as absolute truth the conclusions based on

it. It is evident that, the fewer the number of traditional elements that enter into our reasoning and the clearer we endeavor to be in regard to the hypothetical part of our reasoning, the more logical will be our conclusions. There is an undoubted tendency in the advance of civilization to eliminate traditional elements, and to gain a clearer and clearer insight into the hypothetical basis of our reasoning. It is therefore not surprising, that, with the advance of civilization, reasoning becomes more and more logical, not because each individual carries out his thought in a more logical manner, but because the traditional material which is handed down to each individual has been thought out and worked out more thoroughly and more carefully. While in primitive civilization the traditional material is doubted and examined by only a very few individuals, the number of thinkers who try to free themselves from the fetters of tradition increases as civilization advances.

The influence of traditional material upon the life of man is not restricted to his thoughts, but manifests itself no less in his activities. The comparison between civilized man and primitive man in this respect is even more instructive than in the preceding case. A comparison between the modes of life of different nations, and particularly of civilized man and of primitive man, makes it clear that an enormous number of our actions are determined entirely by traditional associations. When we consider, for instance, the whole range of our daily life, we notice how strictly we are dependent upon tradition that can not be accounted for by any logical reasoning. We eat our three meals every day, and feel unhappy if we have to forego one of them. There is no physiological reason which demands three meals a day, and we find that many people are satisfied with two meals, while others enjoy four or even

more. The range of animals and plants which we utilize for food is limited, and we have a decided aversion against eating dogs, or horses, or cats. There is certainly no objective reason for such aversion, since a great many people consider dogs and horses as dainties. When we consider fashions, the same becomes still more apparent. To appear in the fashions of our forefathers of two centuries ago would be entirely out of the question, and would expose one to ridicule. The same is true of table manners. To smack one's lips is considered decidedly bad style, and may even excite feelings of disgust; while among the Indians, for instance, it would be considered as an exceedingly bad taste not to smack one's lips when one is invited to dinner, because it would suggest that the guest does not enjoy his dinner. The whole range of actions that are considered as proper and improper can not be explained by any logical reason, but are almost all entirely due to custom; that is to say, they are purely traditional. This is even true of customs which excite strong emotions, as, for instance, those produced by infractions of modesty.

While in the logical processes of the mind we find a decided tendency, with the development of civilization, to eliminate traditional elements, no such marked decrease in the force of traditional elements can be found in our activities. These are almost as much controlled by custom among ourselves as they are among primitive man. It is easily seen why this should be the case. The mental processes which enter into the development of judgments are based largely upon associations with previous judgments. I pointed out before, that this process of association is the same among primitive man as among civilized man, and that the difference consists largely in the modification of the traditional material with which our new perceptions amalgamate. In the case of activities, the

conditions are somewhat different. Here tradition manifests itself in an action performed by the individual. The more frequently this action is repeated, the more firmly it will become established, and the less will be the conscious equivalent accompanying the action; so that customary actions which are of very frequent repetition become entirely unconscious. Hand in hand with this decrease of consciousness goes an increase in the emotional value of the omission of such activities, and still more of the performance of actions contrary to custom. A greater will power is required to inhibit an action which has become well established; and combined with this effort of the will power are feelings of intense displeasure.

This leads us to the third problem, which is closely associated with the difference between the manifestation of the power of civilized man and of primitive man to inhibit impulses. It is the question of choice as dependent upon value. It is evident from the preceding remarks that, on the whole, we value most highly what conforms to our previous actions. This does not imply that it must be identical with our previous actions, but it must be on the line of development of our previous actions. This is particularly true of ethical concepts. No action can find the approval of a people which is fundamentally opposed to its customs and traditions. Among ourselves it is considered proper and a matter of course to treat the old with respect, for children to look after the welfare of their aged parents; and not to do so would be considered base ingratitude. Among the Eskimo we find an entirely different standard. It is required of children to kill their parents when they have become so old as to be helpless and no longer of any use to the family or to the community. It would be considered a breach of filial duty not to kill the aged parent. Revolting

though this custom may seem to us, it is founded on an ethical law of the Eskimo, which rests on the whole mass of traditional lore and custom.

One of the best examples of this kind is found in the relation between individuals belonging to different tribes. There are a number of primitive hordes to whom every stranger not a member of the horde is an enemy, and where it is right to damage the enemy to the best of one's power and ability, and if possible to kill him. This custom is founded largely on the idea of the solidarity of the horde, and of the feeling that it is the duty of every member of the horde to destroy all possible enemies. Therefore every person not a member of the horde must be considered as belonging to a class entirely distinct from the members of the horde, and is treated accordingly. We can trace the gradual broadening of the feeling of fellowship during the advance of civilization. The feeling of fellowship in the horde expands to the feeling of unity of the tribe, to a recognition of bonds established by a neighborhood of habitat, and further on to the feeling of fellowship among members of nations. This seems to be the limit of the ethical concept of fellowship of man which we have reached at the present time. When we analyze the strong feeling of nationality which is so potent at the present time, we recognize that it consists largely in the idea of the preeminence of that community whose member we happen to be,—in the preeminent value of its language, of its customs and of its traditions, and in the belief that it is right to preserve its peculiarities and to impose them upon the rest of the world. The feeling of nationality as here expressed, and the feeling of solidarity of the horde, are of the same order, although modified by the gradual expansion of the idea of fellowship; but the ethical point of view which makes it justifiable at the present time to increase



the well-being of one nation at the cost of another, the tendency to value one's own civilization as higher than that of the whole race of mankind, are the same as those which prompt the actions of primitive man, who considers every stranger as an enemy, and who is not satisfied until the enemy is killed. It is somewhat difficult for us to recognize that the value which we attribute to our own civilization is due to the fact that we participate in this civilization, and that it has been controlling all our actions since the time of our birth; but it is certainly conceivable that there may be other civilizations, based perhaps on different traditions and on a different equilibrium of emotion and reason which are of no less value than ours, although it may be impossible for us to appreciate their values without having grown up under their influence. The general theory of valuation of human activities, as taught by anthropological research, teaches us a higher tolerance than the one which we now profess.

Our considerations make it probable that the wide differences between the manifestations of the human mind in various stages of culture may be due almost entirely to the form of individual experience, which is determined by the geographical and social environment of the individual. It would seem that, in different races, the organization of the mind is on the whole alike, and that the varieties of mind found in different races do not exceed, perhaps not even reach, the amount of normal individual variation in each race. It has been indicated that, notwithstanding this similarity in the form of individual mental processes, the expression of mental activity of a community tends to show a characteristic historical development. From a comparative study of these changes among the races of man is derived our theory of the general development of human culture.

But the development of *culture* must not be confounded with the development of *mind*. Culture is an expression of the achievements of the mind, and shows the cumulative effects of the activities of many minds. But it is not an expression of the organization of the minds constituting the community, which may in no way differ from the minds of a community occupying a much more advanced stage of culture.

FRANZ BOAS.

#### ASSOCIATION OF AMERICAN ANATOMISTS.

THE fourteenth session of the Association of American Anatomists, meeting with the American Society of Naturalists and Affiliated Societies in Baltimore, Md., was held in the Anatomical Laboratory of the Johns Hopkins University, December 27 and 28, 1900.

The meeting was called to order, December 27th at 10:20 A.M., by President George S. Huntington.

The Executive Committee reported and recommended the names of eleven candidates for membership. Also a recommendation that at the discretion of the secretary the first five 'Proceedings,' now out of print, should be reprinted. Also a recommendation that the Association endorse the proposition for the establishment of a psycho-physical laboratory in the Bureau of Education, Washington, D. C.

By unanimous consent the secretary cast the ballot for the nominees for membership. The Association also authorized the secretary to reprint the five 'Proceedings' as recommended. The recommendation to endorse the psycho-physical laboratory was not agreed to and was referred to a committee to be appointed by the president to report at a future meeting. It was discussed unfavorably by Drs. Holmes and Hrdlicka.

The Secretary made his yearly report, which stated, among other things, that he had in hand copies of the 'Proceedings'

of the Association from the 6th to the 13th meeting, which were available for distribution to members and especially to libraries. There were 33 libraries and journals on the regular mailing list. The financial exhibit showed a balance in the treasury of \$177.47; total receipts \$492.25; expenditures \$314.78. He suggested the desirability of having a summer meeting with the American Association for the Advancement of Science. The Association had lost several members since May, 1900, when a provisional report had been made. Professor Wm. Anderson of London, an honorary member, died Oct. 27th. Dr. A. L. T. Schäper, of Harvard Medical School, had left this country, having been appointed a professor at the University of Breslau, Prussia. There were now 116 active and 9 honorary members, total, 125.

No reports were received from the delegate to the executive committee of the Congress of American Physicians and Surgeons, nor from the committee on anatomical peculiarities of the negro, nor from the committee on table at Naples. The committee on anatomical nomenclature reported progress.

The President appointed a committee consisting of Drs. Huber, Carmalt and Barker to report nominations for delegates to the executive committee of the Triennial Congress and a new member of the executive committee of this Association.

Dr. Huntington then read the Presidential address, taking for his subject 'The Morphological Museum as an Educational Factor in the University System.'

The following papers were read:

*The Use of Wet Specimens:* DR. HOLMES, Philadelphia.

The cry of the general public for practicability and the desire of the recent graduate for rapid success, and strangely enough the theory of our medical schools, 'science

for its own sake,' are all tending to the same point, namely, the training of students to be scientists before they have been educated as physicians. As a resultant of these forces, our medical schools are getting away from their original intent of turning out practising physicians and are evolving one-sided specialists, which again, strangely enough, the tendency to laboratory and section teaching only seems to increase, by compelling men to choose certain subjects to the exclusion of others. Following this has come a disinclination to instruct and a neglect of teaching method, so that, as has been said in anatomy, 'a man who has a book, a subject and a scalpel, ought to be able to work it all out for himself.' The most obvious improvement in our branch is the teaching in small sections; next the methodical daily apportionment of the work. If we could have our way, we would not only assign the same dissection for the same hour, but if it were possible we would have our scalpels ply together with the same unison as the violin bows in a well-trained orchestra. To be ahead of the assignment is a crime, to be behind it far better, if it implies not sloth nor ignorance, the most careless students being the most rapid slashers. Methodical and clean dissection implies a foreknowledge of the structure, but it is difficult to impress the fact that the dissecting room is a laboratory and not a library alcove, didactic reading should be done at home, the only use of the book being in connection with the cadaver. Explanations should be from the wet specimen and not merely a worded exposition. The wet specimen of muscle, artery or joint should be kept continually before the student as a pattern, to supply the defects of his own work, to study the deeper connections or to review the more superficial which must necessarily be cut away and, at the conclusion of the dissection, for a review of the whole part. Equally for the alumnus

dissector whose time is limited. With a book upon applied anatomy such hurried practitioners with a dissected subject before them can get ten times more practical benefit than could possibly be accomplished by an individual not an expert. If we were given a choice with the average man between a course of study upon the cadaver with carefully prepared wet specimens and the hacked up dissection, we should without hesitation recommend the former. For intelligent comprehension, based on sound pedagogical principles, instruct your student, first, as to what to find, and where, 'in the wet,' and then careful, neat, systematized dissection can not be done too often. For the preservation of wet specimens cold storage is by far the best, with the 'Kaiserling' next. Alcohol hardens them too much, solutions of chloral waterlog them, formalin preparations favor mold of any part from which the fluid is allowed to evaporate.

Dr. Corson, of Savannah, Ga., not being able to be present, his paper, '*The Value of the X-ray in the Study of Normal Anatomy*,' illustrated by photographs of the human membral epiphyses at the thirteenth year, was read by Dr. Kerr of Cornell University. The paper contended that the X-ray would prove of value, first, in the study and demonstration of bone development the growth of the epiphyses, the schema of their development and the study of joints as joints, with their movements; second, in the demonstration of the internal structure of the bones; third, in the study and demonstration of the exact spacings and positions of the bones in the skeleton as a guide to its proper articulation and mounting; this would find its widest application in comparative osteology; fourth, in the study and demonstration of the arteries on the cadaver, where properly injected, they can be skiagraphed in their absolute relations to other structures. The

possibility of this work is wholly due to great improvements in apparatus and technique, and without doubt we can look for even greater improvements in the future in X-ray intensity, which will widen its present field of usefulness. By the X-ray we can really watch the bones grow, and we get certain projected plans of bones and their exact positions in the skeleton which give us new ideas of function as well as of form. Thus physiology as well as morphology will benefit by the discovery of Röntgen.

*The Levator Ani Muscle*: DR. HOLMES, Philadelphia.

The levator ani muscle arises internal to the obturator fascia, on a line from the posterior surface of the crest of the pubes to the spine of the ischium; the fibrous leaf-lets, projecting proximal and distal to the muscle, and running downwards and inwards parallel to its fibers, being called the rectovesical and anal fascias, which for our purpose form a sheath for the levator ani, but in reality constitute the true supporting floor of the pelvic outlet. The levator ani muscle in its origin is unique. At its insertion it is fixed only at the perineal center and the coccyx, while at the median raphe it is movable throughout, though counterbalanced by its fellow of the opposite side; and at the sphincters it is as yielding as the soft viscera themselves. None of the fibers are attached to the prostate gland, though they go behind it to join with the opposite muscle constituting a compressor as well as a levator prostatae; so to the sphincters of the anus and of the vagina we can trace the muscular fibers, but not to the walls of the vagina nor of the rectum. The rectovesical fascia which forms the proximal side of the muscular sheath blends with the fibrous coat of each canal, but the only direct interlacement of the muscular fibers is with the sphincters.

It would seem, therefore, as if the authors were in error in asserting that the levator ani is inserted 'into the lateral aspect of the prostate,' 'into the side of the rectum' or 'into the walls of the vagina,' but as in its origin, the muscles are attached to a narrow linear movable insertion.

It is more a tensor of the fascia, either at its origin or insertion, the fixed point being interchangeable, so that it should be called the 'Tensor perineæ' rather than 'Levator ani.'

*Development of the Human Diaphragm:* DR. MALL, Baltimore. (Illustrated by diagrams and specimens.)

In human embryos four weeks old the pericardial and peritoneal cavities freely communicate. At this time, however, a ridge of tissue is formed in the wall of the cœlom opposite the ductus Cuvieri and cardinal veins which grows rapidly and encircle the lungs to form the pulmonary ridge. A week later the ridge widens to form the beginning of two membrae. The first of these, the pleuro-pericardial membrae, contains within it the phrenic nerve and soon separates the pleural from the pericardial cavity. The second, the pleuro-peritoneal membrane, grows towards the tail with the rotation of the liver and the degeneration of the Wolffian body, and at the end of the sixth week completes the diaphragm.

Dr. Stroud, of Cornell University, was unable to be present. A photograph sent by him, showing *apparatus for demonstrating the circulation of the blood*, was passed around among the members.

The apparatus is an imitation of the actual blood vascular system. The heart, arteries, capillaries and veins are represented by a rubber bulb with valves, very elastic rubber tubing; capillary glass tubing and thinner rubber tubing. The bifurcation of arteries is shown in Y-shaped, of

veins by U-shaped, glass tubes. The circulation is continuous as in the living body. Manometer tubes indicate the difference in pressure in arteries and veins.

*Advantages and Limits of the Methods of Reconstruction with Wax Plates in Anatomical and Embryological Investigations.* DR. CHAS. R. BARDEEN, Baltimore. (Illustrated by specimens, etc.)

Discussed by Drs. Huber, Minot, Barker, W. S. Miller and Huntington.

*Demonstration of a New Freezing Microtome:* DR. BARDEEN.

*Specimen of Cyclopia:* DR. CARMALT, New York City. (With cast and photographs.) Discussed by Dr. Minot.

*A Caudal Appendage in a Human Infant:* DR. HARRISON, Baltimore. (Illustrated by specimen and photographs.)

Discussed by Dr. Hrdlicka. A tail-like appendage, measuring  $2\frac{1}{2}$  inches in length, was present in an infant of four months. The tail arose close to the tip of the coccyx, although not a direct continuation of the latter. It contained no cartilage nor bone, but did contain voluntary muscle fibers, and was movable to a considerable degree.

*Typical Forms of Shaft of Long Bones other than the Tibia:* DR. HRDLICKA, New York City. (Illustrated by specimens.)

Discussed by Drs. Huber and Huntington. The paper presents the further results of the writer's investigations on Professor Huntington's osteological collection in the Medical Department of Columbia University, New York City. It deals with the variations in shape of long bones and classification of these shapes in a similar manner as the former (1898) communication on the tibia. An inference will be drawn as to the causes of the variation.

*Notes on the First and Second Ribs and a Demonstration of Bicapital, Bicaudal, Notched and Perforated Ribs in Man; also Notes and*

*Articulation of Ribs with each other*: DR. HRDLICKA. (Illustrated by specimens.)

Discussed by Dr. Huntington. Variations in shape of normal first and second ribs; the scalene tubercle, its frequency and real nature, and a similar tubercle on the second rib; peculiarity of the normal ossification of the cartilage of first rib. Demonstration of anomalous specimens.

*Variations of the Inferior Cava*: DR. HUNTINGTON. (Illustrated by photographs.)

*The Origin of the Lymphatics of the Liver*: DR. MALL.

When Prussian-blue gelatin in which cinnabar is suspended is injected into either the portal or hepatic vein, it is found that the blue filters through the capillary wall, leaving the red granules in the capillaries. The capillaries are surrounded by the perivascular lymph spaces which communicate with perilobular lymph spaces. These, in turn, communicate freely with the interlobular lymphatics.

*The Lobule of the Lung*: DR. W. S. MILLER, Madison, Wis. (Illustrated by models, diagrams and lantern slides.)

Discussed by Drs. Huntington and Huber. The term lobule as applied to the unit of the lung has been used in an exceedingly vague sense both by anatomists and pathologists. It is the purpose of the paper to give a definite meaning to the term.

*The Epithelium of the Pleural Cavities*: DR. MILLER, Madison, Wis. (Illustrated by lantern slides and preparations.)

Since the time of v. Recklinghausen and Oedmansson certain dark spots seen in many preparations of serous membranes stained by the silver nitrate method have been called *stomata* and *stigmata*. Ludwig and Dybkowsky described such structures in the pleura. Muscatello has recently shown that such openings do not exist normally in the peritoneum. It is the pur-

pose of the paper to show that they do not exist in the pleura when studied in the normal condition, and that they can be produced artificially at the pleasure of the investigator.

*Preliminary Report with Projection Drawings, illustrating the Topography of the Paracoles in their Relation to the Surface of the Cerebrum and Cranium*: MR. E. A. SPITZKA, New York City. (Illustrated by drawings and diagrams.)

Since the tapping and injecting into the ventricles have become definite procedures in surgery, it would greatly aid the operator to have a more accurate conception of the extent, depth and contour of the cavities, with their variations, than can be had from the bare rules and measurements set forth in most surgeries. With this view the author utilizes the entire head, hardened by injection of, and submersion in, formal. After a time the cranium is opened and the brain is accurately sliced, correct drawings being made at each step and projected for the delineation of the final plates. Two heads have so far been completed. It is proposed to decalcify the skulls of subsequent material, the entire head being then subjected to the slicing method. [Published in *New York Medical Journal*, February, 2, 1900.]

*Bilateral Relations of the Cerebral Cortex*: DR. MELLUS, Baltimore.

Hastily reviewing bilateral relations previously demonstrated, he called attention to a series of his recent experiments on the monkey. After extirpation of a small portion of cortex from that part of the so-called motor area situated on the boundary line between facial and upper limb centers, he showed degenerated fibers passing from the lesion across the middle line in the corpus callosum. These fibers were distributed to cortical areas of the opposite hemisphere corresponding to the convolutions upon the

side of the lesion, to which association fibers were traced directly from the lesion. This distribution of association fibers to the convolutions of the two hemispheres was quite symmetrical, and by far the greater number passed to that portion of the opposite hemisphere which corresponded to the situation of the lesion. In addition to these association fibers a large portion of the degenerated tract crossing in the corpus callosum turned down into the internal capsule of the opposite side. These fibers mostly terminated in the thalamus and hypothalamus, but in a number of instances a few of these fibers passed on through the pons and medulla into the cord. Owing to the degeneration in both pyramids above the decussation, it could not be determined whether or not these fibers recrossed in the decussation. Dr. Mellus stated that after unilateral lesions in the brain of the dog he had found fibers crossing in the corpus callosum and passing down the internal capsule of the opposite side. In no instance, however, had he found these fibers in the dog passing through the capsule. They all passed out of the capsule and ended in the thalamus of the side opposite the lesion.

*Methods of Statistical Study in the Dissecting Room with special reference to the Peripheral Nervous System:* DR. BARDEEN. (Illustrated by charts.)

Discussed by Dr. Huntington.

*Wandering of the Skin during Development, in Relation to the Distribution of Cutaneous Nerves:* DR. HARRISON. (Illustrated by diagrams.)

By a process of transplantation, embryos of two species of frogs may be combined, and through contrast in pigmentation, wandering of the epidermis may be accurately observed as the embryo develops. There is a definite relation between this movement and the course of the cutaneous nerves in the adult. The wandering of the

skin is, at least to a great extent, passive, and is due to mechanical causes.

*Intrinsic Blood Vessels of the Kidney and their Significance in Nephrotomy:* MR. MAX BRÖDEL, Baltimore.

The pelves of most kidneys are on the posterior part of the hilum and pass obliquely forward to the center of the kidney. The calices are grouped in two rows, anterior, pointing forward, and a posterior, pointing laterally. The arteries usually divide into two main trees, an anterior, carrying three-fourths to four-fifths of the blood, and a posterior furnishing the remainder. There is neither anastomosis nor crossing between the branches of these two trunks; they are completely separated by the pelvis and its calices. The superficial and deep collecting veins of the cortex empty into the venous arches at the base of the pyramids, forming the peripheral system of venous anastomoses. There is, however, a second more central system around the necks of the calices. Practically all the veins at the hilum pass anteriorly to the pelvis. The form of the pyramids and their relations to the blood vessels and surface, and also the columns of Bertini, have been studied. Although many kidneys deviate in their construction, all conform more or less to the rules mentioned. The studies reveal several points of interest to the surgeon, among which are: (1) The most advantageous incision for nephrotomy. (2) The appropriate method of suturing an incised kidney. (3) A very satisfactory method of fixing the kidney. (4) The insufficiency of the method of opening the pelvis at the hilum.

*Histology of the Endometrium:* DR. T. S. CULLEN, Baltimore. (Illustrated by specimens and drawings.)

*The Architecture of the Gall-bladder:* DR. M. T. SUDLER, Baltimore. (Read by title.)

*The Classification of Glands:* DR. MINOT, Boston. (Read by title.)

*Contribution to the Question of Fissural Integrality of the Paroccipital; Observations on 100 Brains:* MR. SPITZKA. (Illustrated by drawings.)

Examination of 100 brains in the anatomical laboratory of the College of Physicians and Surgeons, New York City, yielded results similar to those of Professor Wilder. The question of the integrality, with the hypotheses of Cunningham, Wilder and Parker, are briefly discussed. The writer inclines to the opinion that it is not an integer, but a partial and modified segment of the simian exoccipital; and, further, that its confluence with, or separation from, the parietal should be regarded as of secondary significance and importance.

*The Mesial Relations of the Inflected Fissure.*

*Observations on 100 Brains:* MR. SPITZKA. (With about 60 illustrations.)

The chief points are: (1) the normal position of the inflected fissure on the meson is caudad of the cephalic limb of Wilder's paracentral fissure in other words, its mesial portion indents and partly lies within the paracentral lobule (or as Broca prefers to call it, 'oval lobule'). (2) There is considerable confusion in modern encephalic literature concerning the synonymy of the inflected fissure. The most erroneous statements come from Eberstaller, and consist in a misinterpretation of Broca's 'incisure pré-ovale' and Schwalbe's 'sulcus paracentralis,' with the 'inflected fissure' of Lussana and Wilder, 'X-fissure' of Benedict and Flesch, or 'sulcus præcentralis medialis' of Eberstaller and other European writers. Broca's and Schwalbe's fissure corresponds to the cephalic limb or limiting ramus of Wilder's paracentral. (3) The condition presented in the mulatto brain described by Wilder (see Figs. 4766 and 4772 of his article,

*Handbook*, Vol. VIII., 1889) is anomalous and rare, since the inflected appears wholly without the paracentral gyrus, and therefore cephalad of Broca's 'pre-oval incisure' or Wilder's cephalic paracentral limb. The explanation appears to be that the cephalic limb is obliterated, while simultaneously one of the intraparacentral elements, of which there seem to be several, has effected a junction with the paracentral stem, and thus appears, at first glance, to be a well-defined cephalic ramus.

*The Brains of Two Distinguished Physicians, Father and Son; a Comparative Study of their Fissures and Gyres:* MR. SPITZKA. (Illustrated by drawings and photographs.)

Discussed by Drs. Lamb and Huntington. The paper treats carefully and at length of the brains of Dr. Edouard Seguin and his son, Dr. Edward C. Seguin. The learning and progressiveness of these men are well known in the educational and scientific world. Both were interested in the study of idiocy and medical thermometry; the father was especially instrumental in introducing the metric system into this country, while the son, as one of the pioneers of American neurology, made many valuable contributions to the pathology and therapeutics of nervous diseases. The brains show a general similarity and refined development, but with differences as puzzling as profound; and many interesting features appear in the comparison. So far as the author knows, this is the first instance in which the brains of blood relatives have been compared and described.

*Method of Utilizing Frozen Sections for Class Demonstrations of Visceral Anatomy and the Epiphyses:* PROFESSOR PRIMROSE, Toronto, Canada.

The exhibition of lantern slides was a series of photographs made from sections through the trunk and extremities of chil-

dren. The sections were prepared in a special manner so as to present a perfectly smooth surface with clear outlines of the various structures. These sections were photographed and lantern plates made from the negatives. They were cut in sagittal, coronal and horizontal planes through the trunk, and in longitudinal and transverse directions through the extremities. The method adopted in the University of Toronto is that permanent preparations are made of the sections, which are mounted in flat dishes, and thus exposed, so that they are accessible for the students at any time in the Anatomical Department. The lantern demonstration of these sections is given from time to time at the close of a lecture. It proves to be a very useful adjunct to the ordinary methods of demonstration, and the student always has the opportunity of studying the actual section in the dissecting room, the photograph of which is thrown upon the screen in the lecture theater. It is claimed that these photographs of actual sections are of much greater value from an educational standpoint than the drawings reproduced from the sections.

*Method of Teaching the Anatomy of the Central Nervous System to Large Classes of Students:*  
DR. BARKER, Chicago, Ill. (Read by title.)

D. S. LAMB,  
Secretary.

THE ELEVENTH MEETING OF THE AMERICAN MORPHOLOGICAL SOCIETY.

THE American Morphological Society held its eleventh annual meeting in the Anatomical Laboratory of Johns Hopkins University, on the 27th and 28th of last December. A good proportion of members was present.

The following officers were elected for the present year: *President*, J. S. Kingsley; *Vice-President*, E. A. Andrews; *Secretary-Treasurer*, Thos. H. Montgomery Jr.; *Mem-*

*bers of the Executive Committee*, C. F. W. McClure and C. W. Hargitt. Twelve new members were elected; and the Society voted fifty dollars for the support of the University table at the Naples laboratory.

The following papers were read (abstracts of which will be published in the *Biological Bulletin*):

*Fission and Regulation in Stenostoma leucops:*  
C. M. CHILD.

*On Gunda segmentata in America:* W. C. CURTIS.

*Exhibition of Pacific Coast Nemertean:* W. R. COE.

*Some Disputed Points in the Anatomy of Limpets:* M. A. WILLCOX.

*The Habits and Life History of Argulus, with reference to its Economic Relations:* C. B. WILSON.

*A Comparative Study of the Development of the Germinative Tract of Termites:* H. McE. KNOWER.

*The Anatomy and Development of the Vena cava in Didelphys Virginiana:* C. F. W. McCLURE.

*The Crossing of the Optic Nerves in Teleosts:*  
G. H. PARKER.

*A New Type of Budding in Annelids:* H. P. JOHNSON.

*Amphibian Studies:* J. S. KINGSLEY.

*Phagocytosis in a Mammalian Ovary:* M. M. METCALF.

*The Mammalian Lower Jaw:* W. H. RUDDICK and J. S. KINGSLEY.

*An Apparatus in the Central Nervous System of Vertebrates for the Transmission of Motor Reflexes arising from Optical Stimuli:* P. E. SARGENT.

*The Structure of the Testis in Desmognathus fuscus:* B. F. KINGSBURY.

*The Synopsis Stage of the Germ Cells:* T. H. MONTGOMERY, JR.



*A Study of the Phenomena of Cleavage in Etherized Eggs*: E. B. WILSON.

*The Influence of the Germ Cells upon the Somatic Cells*: G. W. FIELD.

*Two Improved Forms of Automatic Microtomes*: C. S. MINOT.

*A Study of the Phenomena involved in the Chemical Production of Parthenogenesis in Sea Urchins*: E. B. WILSON.

*Centrosomes and Spheres in the Maturation, Fertilization and Cleavage of Crepidula*: E. G. CONKLIN.

*Independence of the Germ Nuclei in Cleavage.*

*A New Method of Preservation of Fragile Specimens*: A. D. MEAD.

*Larval Stages and Metamorphosis of the Hermit Crab*: M. T. THOMPSON.

*Regeneration in Planaria maculata*: C. W. BARDEEN.

*Histogenesis of the Peripheral Nervous System in Salmo salar*: R. G. HARRISON.

*Asexual Reproduction of Planaria maculata*: W. C. CURTIS.

*Variation in Hydromeduse*: C. W. HARGITT.  
*The relative Proportion of the Sexes in Poultry*: G. W. FIELD.

*Notes on Variation in the Shells of Purpura capillus*: R. P. BIGELOW and H. S. CONANT.

*Variation and Elimination in Philosamia cynthia*: H. E. CRAMPTON.

*The Tentacles of Gonionemus*: H. F. PERKINS.  
THOS. H. MONTGOMERY, JR.,  
Secretary.

#### THE PROJECTION OF RIPPLES BY A GRATING.

AFTER obtaining the condition under which one grating is projected by another, it seemed not unlikely that the method might be used for projection of ripples. If the latter are obtained in a trough of rectangular outline, the light reflected from them breaks up into two series of equi-

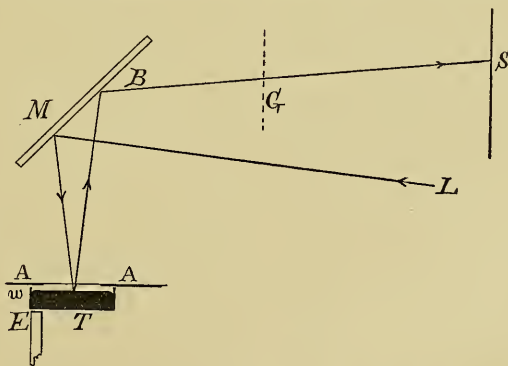

*The Mesentric and Spermatic Arteries of Didelphys Virginiana*: C. F. W. McCLURE.

*Observations upon the Regeneration of Renilla*: H. B. TORREY.

*Certain Points in the Structure of the Lower Vertebrate Brain*: J. B. JOHNSON.

distant bright lines intersecting each other orthogonally. Hence the first grating\* may be dispensed with, being replaced by

\*See preceding article, SCIENCE, XII., pp. 617-627, October 26th, 1900. The bars of the grating *G* must be parallel to the projection of ripples at *S*, both being vertical lines like the axis of *G*.

the illuminated ripples which are then projected by the second grating. In the figure sunlight arriving at  $L$  is reflected from the large mirror  $M$  (one foot square), passing thence to and from the shallow rectangular trough  $T$ , containing mercury, to be again reflected by  $M$ , to the screen  $S$ . If a lens is placed at  $B$ , so that  $T$  is the conjugate focus of  $S$ , magnificent ripple patterns are seen on the screen whenever the table is slightly jarred by drumming on it with the fingers. These are stationary capillary waves originating at each of the straight edges of the trough. They may be obtained in different wave lengths in the ratio of 1:2, according as the table is more or less sharply rapped. Gravitational waves, though always markedly present, do not appear in the picture and may be ignored. To produce them observably it is necessary to have some special device for starting them. Two or three straight iron or steel wires, lying stably at  $w$ , on the capillary edge of the trough, are an excellent wave producer if controlled by the electromagnet  $E$ . Among interesting experiments of this kind I will only mention the reflection of waves, which advance with a crest and return with a trough, from a fixed obstacle, the lines in the image being respectively light and dark. It takes some practise, however, to see this, for with troughs as shallow as convenient the velocity will not lie much within six inches or a foot per second.

Returning from this digression, let the lens be removed and replaced by a grating,  $G$ , capable of rotation about a vertical axis. When the proper angle is obtained, a fairly sharp image of the ripples may be seen whenever the table is jarred. Care must be taken to avoid errors due to the diffraction by the grating of the light issuing from the round capillary edge of the mercury in  $T$ . These lines of light give rise to extensive streamers on the screen, intersected by sharp diffraction cross bands,

the streamers intersecting each other at right angles in the patch of light due to the mercury surface proper. Hence an annular screen,  $AA$ , is added to blot out the convex edges.

If  $x$  is the (broken) distance between mercury and grating,  $G$ , if  $y$  is the distance between grating and screen,  $\theta$ , the azimuth angle of  $G$  for which the image appears sharpest, finally if  $a$  is the distance apart of the ripples and  $b$  the grating space, the relation  $a = b \cos \theta (1 + x/y)$  is available. To give an example of experiments tried in this way, I found roughly,  $x = 105$  cm.,  $y = 670$  cm.,  $b = .21$  cm.,  $\theta = 30^\circ$ , whence  $a = .2$  cm.

If the trough  $T$  is long (say two feet long and three inches broad), the waves from the end are dampened out before they reach the middle, and the cross waves are alone in presence there. These lines of light, if the long edge is parallel to the direction of projection, give sharper images. I have not yet, however, been able to develop this method to a degree useful for measurement, and I merely communicate it here as an interesting experiment. I may note, in conclusion, that if progressive instead of stationary ripples be produced, and if the grating move in a direction opposite to the ripples, with a velocity increasing until the shadow bands moving in the first instance become stationary, the velocity of the ripples would be deducible as well as their wave length.

C. BARUS.

BROWN UNIVERSITY, PROVIDENCE, R. I.

#### REVIEWS OF CURRENT BOTANICAL LITERATURE.

A LITTLE more than a year ago at the annual meeting of the Society for Plant Morphology and Physiology, held in New Haven, a committee, consisting of Dr. Farlow of Harvard University, Dr. MacDougal of the New York Botanical Garden and Dr.

von Schrenk of the Missouri Botanical Garden, was appointed to consider the question of securing better reviews of current botanical literature. A preliminary report was made by this Committee last June, at a special meeting of the Society held in New York at the time of the meeting of the American Association for the Advancement of Science. In this report the committee includes the correspondence between the secretary of the Society, Professor Ganong of Smith College, and Dr. Oscar Uhlworm of Cassel, Germany, the Editor-in-Chief of the *Botanisches Centralblatt*. Realizing that the aim of the *Centralblatt* is to publish such reviews and that it is inadvisable to multiply journals, the committee suggested some changes in the plan and management of that publication. In the words of Professor Ganong's letter :

The chief cause of dissatisfaction with the *Centralblatt* in this country is its policy of publishing only a part of the reviews in the *Centralblatt* itself, relegating the remainder to *Beihefte*, for which a considerable additional subscription must be paid. If this were rendered necessary by the number of the reviews there could be no objection to it, but obviously the additional reviews necessitating the *Beihefte* are crowded out by the publication of the *Originalmittheilungen*. Those who subscribe for the *Centralblatt* do so for the sake of the reviews and announcements of new literature, and not for the original articles, which have no logical place in a journal devoted to reviews. The Committee feels assured that the relegation of the *Originalmittheilungen* to the *Beihefte*, or their omission altogether, and the inclusion of all the reviews in the *Centralblatt* itself would make the *Centralblatt* much more widely and completely acceptable to botanists. They believe, also, that the increased support which would be given it would compensate for any loss of subscriptions by the cessation of the *Beihefte*, and also (and this they regard as of much importance) it would tend to prevent the appearance of any competing journal.

In regard to matters of detail the committee's letter continues :

The Committee, with other botanists, believes that the reviews of a journal devoted to communicating the appearance of new literature should be, above all, *prompt* and *descriptive*. What botanists mainly wish to learn from reviews is whether the work reviewed is important to their particular interests, and what its contribution is to the science as a whole. The abstracting of the contents of a book or paper in detail seems rather to belong to such a work as Just's *Jahresbericht*, and may well be left to it, thus shortening the descriptive reviews, and making it the easier to include them all within the limits of a journal without the need for *Beihefte*. Promptness in the appearance of reviews is particularly desirable, particularly to those who live at a distance from the place of publication.

The reply to this communication, while encouraging, was not all that the committee desired. Thus, while the editors of the *Centralblatt* were willing to confine the reviews to the journal itself, relegating the original articles to the *Beihefte*, they wished to be guaranteed a certain annual subsidy, and to still retain the right to require the subscriber to pay for both *Centralblatt* and *Beihefte*. To these stipulations the committee very properly demurred, and after discussing other proposed plans, *e. g.*, the printing of such reviews in the form of a card catalogue, or the establishment of a new journal, asked for more time for further consultation with the publishers and editors of the *Centralblatt*.

Accordingly a second interchange of letters was had, and the results were laid before the Society as a second report, in December last, during the annual meeting held in Baltimore. Professor Ganong's letter is as follows (omitting some formal matters which need not be repeated here) :

The Committee has given very careful consideration to the letter of the editors and publishers of the *Centralblatt*, and has gathered all available data from the discussions of the society and by correspondence with many botanists in America and elsewhere. As a result the Committee has to present the following

reply to the propositions contained in your recent letter :

1. You propose that, in return for certain specified changes in the *Centralblatt*, a certain annual subsidy (or else a certain number of subscriptions) to the *Centralblatt* shall be guaranteed by this Committee or by some other body of American botanists. The Committee is firmly assured that such a guarantee in either form could not secure the support of any botanical organization in this country, and hence regards it as useless to consider this point further.

2. Your offer to increase the size of the *Centralblatt* from 104 to 129 Bogen yearly does not appear to the Committee an improvement in the direction desired by American botanists. As pointed out on page 6 of the report, there is no dissatisfaction on the score of relatively insufficient attention to American literature, and hence no reason on that account for an increase in the size of the *Centralblatt*.

3. You propose to separate the *Referate* from the *Originalmittheilungen* and to publish *Referate* in one *Abtheilung*, and *Originalmittheilungen* and *Neue Litteratur* in another, the two, however, not to be obtainable separately by subscribers. While the proposed separation has certain advantages, its value is practically entirely destroyed by the condition that the two *Abtheilungen* cannot be subscribed for separately. The Committee regards it as an indispensable condition to the future active support of the *Centralblatt*, or any other journal of like aims, that it shall be possible to subscribe for *Referate* and *Neue Litteratur* without being obliged to pay for *Originalmittheilungen*, which have no logical place in a journal devoted to reviews.

4. You propose the establishment of an American Board of Editors. This proposition has been received by the Committee, and as well by the members of the Society and by other botanists, with much satisfaction. The opinion appears to be general that such a step would contribute greatly to make the *Centralblatt* acceptable to American botanists.

The Committee finds itself obliged to state, therefore, that in its opinion no change in the *Centralblatt* will make it acceptable to American botanists which does not permit of subscribing for *Referate* and *Neue Litteratur* without having to pay for *Originalmittheilungen*. If this change were made in the *Centralblatt*, and if an American Board of Editors were appointed as proposed by you, the Committee has no doubt that the minor reforms, the need for which was referred to in its former letter, could gradually and satisfactorily be brought about. Such changes would remove all reason for the existence of another and competing journal, and would, in the opinion of the Committee, attract to the *Centralblatt* an additional support which

would not only compensate for any present pecuniary loss, but prove ultimately greatly to its financial advantage. The opinion appears to be nearly unanimous among botanists consulted by the Committee, that it would be far better that the *Centralblatt* should be modified to meet what appear to be but reasonable requirements in a journal devoted primarily to reviews than that a new journal should be started, and that the starting of a new journal should be resorted to only after every effort has been made to secure the desired reforms in the *Centralblatt*.

Under these circumstances the committee ventures to hope that the editors and publishers of the *Centralblatt* will take these matters again into consideration, and may be able to return a reply that will be proved a solution of all present difficulties.

To this letter, Dr. Uhlworm replied as follows :

After mature consideration of your propositions, in regard to the justice of which we have had no objections from the beginning, we have come to the conclusion to publish nothing but *Referate* and *Neue Litteratur* in the regular series of the *Botanisches Centralblatt*, which is to be of the same size and price as heretofore, and which can, of course, be subscribed for by itself. The *Beihefte*, however, which appear from time to time and may likewise be subscribed for alone, would then contain the original articles. In regard to the financial support of the American botanists, concerning which we had spoken only because we had concluded from your first communication that you proposed a considerable increase in the size of the *Centralblatt*, we shall of course say nothing more under the existing circumstances. We should feel deeply grateful, however, if your Committee, and especially the two gentlemen whom you select as associate editors, would give us your support by an active cooperation, and would bring the *Centralblatt* to wider notice in America. \* \* \* Above all things, I am naturally desirous of presenting the new American literature as rapidly and completely as possible to our readers in the future. In this connection, however, I must ask for support from you to the extent that you cause the American authors, institutions, societies and periodicals to send me a copy of newly published articles as quickly as possible for publication in *Neue Litteratur*. Written titles conduce, as I know from years of experience as a librarian and editor, only to unfortunate errors and to confusion.

It is to be hoped that a union of the American and European botanists will result in a real advance in the *Centralblatt*. I shall do all in my power to bring this about. I shall do my best to make this

joint work a most successful undertaking. I hope that I shall succeed in making similar arrangements with the botanists of other countries.

The report comments upon the foregoing as follows :

The committee feels that the Society is greatly indebted to the editors of the *Centralblatt* for their courteous letter and must be highly gratified with their statement of the changes which they express themselves prepared to make in the near future. The changes, as will be seen from Dr. Uhlworm's letter, are in conformity with the suggestions made by the committee in its report and will meet with the approval of all American botanists. It is proposed to include in the *Centralblatt* proper, only reviews and the index of literature; the *Beihefte* will contain only original articles; the *Centralblatt* may be subscribed for without also subscribing for the *Beihefte*, and, lastly, the price of the *Centralblatt* is to remain as at present. On these points, therefore, the letter of Dr. Uhlworm is entirely satisfactory.

The suggestions that American editors be nominated by a representative body of American botanists seem to be excellent and likely to prove helpful to the *Centralblatt* by stimulating our botanists to make a determined and combined effort to do all in their power to enable the editors of the *Centralblatt*, so far, at least, as American botanical literature is concerned, to make their journal indispensable to all botanists. Hereafter, it will be a matter of pride to us to show that our interest is not merely passive, but that we are ready to make active individual and collective effort to secure a desirable result.

The Committee closes its report with the following recommendations :

*First*, that the Secretary be directed to write to Dr. Uhlworm and express our hearty approval of the changes proposed, and our readiness to cooperate.

*Secondly*, that a committee of three be appointed by the Society with full power to represent the Society in further negotiations with the management of the *Centralblatt* up to such time as the selection of American editors shall have been definitely made, the committee to report to the Society at its next annual meeting.

*Thirdly*, that the committee thus appointed be requested to invite one botanist from the Central States and one botanist resident on the Pacific Coast to serve with them in the selection of American editors, and in such preliminary business as may be necessary for the furtherance of the plans proposed by the editors of the *Centralblatt*.

*Fourthly*, that a copy of this report, or of such

parts of it as may seem desirable in order to call the attention of our botanists to the changes to be made in the *Centralblatt*, be sent to the *Botanical Gazette*, the *Bulletin of the Torrey Club* and to SCIENCE.

In accordance with the second recommendation, Messrs. Farlow, MacDougal and Ganong were appointed upon the new committee to carry out the work to completion, and Messrs. Trelease and Campbell have since been added, in accordance with section three above. The botanists of the country are to be congratulated upon the results achieved by these negotiations. The changes proposed, and in part already put into effect, promise to make the *Botanisches Centralblatt* an efficient and economical journal of reviews indispensable to every working botanist. It is hoped that those of America will manifest their appreciation of its advantages, and their acknowledgment of the efforts of its editors and publishers to meet their wishes, by a cordial and practical support. Upon this latter subject a further communication is expected from the Committee. CHARLES E. BESSEY.

#### SCIENTIFIC BOOKS.

*Proceedings of the Society for the Promotion of Engineering Education.* Vol. VIII. 1900.

Edited by PROFESSORS JOHNSON, KINGSBURY and JACOBY. New York, Engineering News Publishing Co. 1900. 8vo. Pp. 377.

It may be doubted whether, in any other department of applied science, a larger, a more important, or a more fruitful work is being done than in the field occupied by the Society of which the transactions are here recorded. The members of the Society are engaged in the technical schools and colleges of the country in the professional training of men who are to hereafter lead in the application of the discoveries of science, of the inventions of the useful arts and of the methods of modern industrial operation in the new century. Their work is the instruction of youth who, having completed the general education that their parents' money and their own time and scholarly proclivities may afford them, turn their attention to the

scientific principles which are the recognized foundation of their professional work and the basis of professional success. The work is that which has brought Germany up from insignificance, industrially, and made her one of the world's most important producers, placing her people in the foremost rank in all applied sciences and in all arts based upon science. Their opportunities are greater than those of their German colleagues; they recognize the facts and are evidently seeking to make the most of them. The record is rich in instructive and suggestive matter.

The earlier pages of the volume are given to the lists of officers, council, committees and members. The last number already—the Society was organized at the World's Congress at Chicago in 1893—nearly 300, of whom New York and Massachusetts claim 29 each; Ohio, 20; Pennsylvania, 18; Indiana and Illinois, each 15; Michigan, 13; Minnesota, 12, and other States smaller numbers; 36 States being represented, one Territory, and also Canada, England, France, Germany, Switzerland and Australia, mainly single representatives, although Canada has six. Any one occupying, or who has occupied, a position as a teacher in any branch of work in the engineering school or college is eligible to membership. The conventions occur annually and usually in conjunction, as to time and place, with the American Association for the Advancement of Science. The finances of the Society seem to be in admirable shape.

The proceedings for the year 1900 include an address by the President on the work of the nineteenth century in this field, the report of the committee appointed to answer the question, regarding industrial education generally: 'What shall it be?' an abstract of which has already been given in these columns, and a total of about twenty papers and reports of committees of a most valuable and interesting character. Those on the form of the industrial educational system, on 'Personality in Teaching' and on 'Business Methods in Teaching Engineering,' gave rise to earnest and helpful discussions of very general interest; as did, also, the two papers, coupled together, on the 'Present Status and Tendencies of Engineering Educa-

tion in the United States' and on 'The Promotion of Engineering Education.' The last two papers on the list, one on 'The Modern Mechanical Laboratory,' presented simultaneously, also, to the Paris Congress on Applied Mechanics, and the other on 'Operating Work as a Feature of Electrical Laboratory Training,' were received too late for discussion.

Of these papers, the report first alluded to above, already noticed in these columns, is here printed, with a discussion of great extent and exceeding interest and in some respects perhaps more valuable than the report which provoked it. The report of the committee is strongly endorsed, and the speakers, including some of the ablest in the field, present a great variety of new views and of crucial problems such as must long afford food for thought to all interested in this subject. And what intelligent citizen is not thus interested? Heads of engineering and technical schools, practitioners, famed and expert, teachers, distinguished and likely to become distinguished, and every department of technical instruction and practise give testimony. The paper on 'Secondary Technical Education' and those on details of work may be taken to be extensions of this discussion; and most helpful they are likely to prove to all who are either directly or indirectly concerned in this most important to the industrial community of all modern departments of applied science.

R. H. THURSTON.

*Kant's Cosmogony.* Edited and Translated by W. HASTIE, D.D., Professor of Divinity in the University of Glasgow. New York, The Macmillan Co. 1900. Cr. 8vo. Pp. cix + 205. Price, \$1.90.

This is an excellent bit of work, not only admirable in the scholarship and learning that go to its execution, but noteworthy in its timeliness as a contribution to English 'Kant philology.' So far as the editor is concerned, the book means that the days of heat and partisanship about the critical philosophy are past, that a man dare call attention to Kant's place in scientific evolution and yet keep a whole skin. No doubt there are those who will squirm uncomfortably when they read; Kant's 'Natural

History and Theory of the Heavens,' as he ultimately designated its exposition, will probably be regarded hereafter as the most wonderful and enduring product of his genius" (Introduction i); and will write Dr. Hastie down a philosophical Dogberry. "It is a charming incongruity to find, while Leonato rages and Benedick offers his challenge, that Dogberry is the one to unravel the tangle of threads." Our editor, untrammelled by the faction of recent schools, sees more clearly than those who, distraught by preconceived opinion, have dealt us our Kant *schillernä*. In view of their battles, it may be added that the 'Natural History' possesses this chance of future fame—it can be understood.

Some of Dr. Hastie's friends may be inclined to regret that he has elected to enlist his uncommon erudition, strong personality and vital enthusiasm in the work of making other authors known, rather than in the production of original books. This regret is mitigated, in the present case, by the fascinating 'Introduction,' which is a real addition to our literature on Kant. Indeed, Dr. Hastie has done much more than 'edit and translate,' as the modest legend runs on the title page, and the result is a highly composite production, the contents of which it were well, therefore, to set forth in detail. The book falls into three distinct portions. *First*, comes the 'Translator's Introduction,' extending to 101 pages, and divided into eight sections, as follows: (1) 'Relation of Kant's Science to his Philosophy'; (2) 'the Scientific Return to Kant'; (3) 'Kant's Scientific Environment and Antecedents'; (4) 'Kant's Discovery of the Retardation of the Rotation of the Earth'; (5) 'Kant's Natural History and Theory of the Heavens'; (6) 'Kant's Cosmogony in its Historical Relations'; (7) 'Kant's Cosmogony in Relation to Religion and Theology'; (8) 'Kant's Scientific Achievement Generally.' The appropriateness of the dedication of the book to Lord Kelvin becomes apparent on this recital. *Second*, the main body of the work, presenting (1) a translation of Kant's essay on the question (proposed by the Royal Academy of Sciences at Berlin), 'Whether the Earth has undergone an Alteration of its Axial Rotation' (1754); (2) a translation of Kant's 'Universal Natural His-

tory and Theory of the Heavens; or an Essay on the Constitution and Mechanical Origin of the Whole Universe, treated according to Newton's Principles' (1755). These translations fill 167 pages. *Third*, the Appendices, giving (1) a translation of Konrad Dieterich's 'Summary of Kant's Theory of the Heavens,' taken from his 'Kant und Newton' (1876); (2) a translation of the 'Hamburg Account of the Theory of Thomas Wright of Durham,' taken from the MS. in the library of the university of Edinburgh. This MS. is an excerpt copy transcribed from the 'Freye Urtheile und Nachrichten zum Aufnehmen der Wissenschaften,' a periodical published at Hamburg. The Wright account came in the first number of the eighth year (January, 1751). Wright's work, there summarized, was entitled, "An Original Theory or New Hypothesis of the Universe, Founded upon the Laws of Nature, and solving by Mathematical Principles the General Phenomena of the Visible Creation; and particularly the *Via Lactea*. Comprised in Nine Familiar Letters from the Author to his Friend. And illustrated with upwards of thirty graven and mezzo-tinted Plates by the best Masters. London, MDCCL." This portion is embellished with a portrait of Wright. (3) A reprint of 'De Morgan's Account of the Speculations of Thomas Wright of Durham.' This is taken from the 'London, Edinburgh and Dublin Philosophical Magazine and Journal of Science,' volume xxxii (1848). These appendices fill 38 pages.

By merely glancing over these titles, any one can infer that, if the labor involved be well done, the book constitutes a most valuable contribution to a chapter in the history of the relation between science and philosophy. As I have already said, Dr. Hastie's part is admirably sustained. Indeed, I would have scientific men, in particular, read the book carefully, for it must act as a powerful solvent upon certain unfortunate prejudices.

A word, in passing, about Wright. Like many another, so unfortunate as to live ere the times were ripe, he has been consigned to unmerited oblivion. Even the writer of the entry upon him in the 'Dictionary of National Biography'—a work so uniformly accurate—is un-

aware of the sources from which information could have been obtained, and so has nothing to tell,—does not even know the dates of his birth and death, or why he was called ‘of Durham.’ Wright was born at Byer’s Green, near Durham, in 1711, and died there in 1786. Brought up as a ‘philosophical instrument-maker,’ his attention was called early to mathematico-physical problems and, by his thirty-first year, he had gained such reputation as a teacher of mathematics (like other eminent English scientists, a *private* teacher) that he was called to the chair of navigation by the Imperial Academy of St. Petersburg, an offer which he did not accept. There would seem to be no reasonable doubt that he was the first to light upon the modern physico-philosophical theory of the material universe. As De Morgan says, ‘He gave the theory of the milky way which is now considered as established,’ and he predicted ‘the ultimate resolution of the rings of Saturn into congeries of small satellites’ (203). The conclusion of Wright’s seventh letter furnishes a striking instance of his remarkable prevision. “Thus, Sir, you have had my full opinion, without the least reserve, concerning the visible creation, considered as part of the finite universe; how far I have succeeded in my designed solution of the *Via Lactea*, upon which the theory of the whole is formed, is a thing will hardly be known in the present century, as in all probability it may require some ages of observation to discover the truth of it” (202). The ‘ages of observation’ and the Lick Observatory have not failed him. An edition of the ‘Original Theory’ was published in this country, at Philadelphia, by Rafinesque (1837). If Dr. Hastie had done no more than rescue this man’s name from blank oblivion, he had deserved well of students of science. And he has accomplished much besides.

Apart altogether from its contribution to our knowledge of the manner in which Kant’s early scientific studies influenced his later philosophical speculation—a contribution by no means inconsiderable as our somewhat scanty literature in English goes, the book ought to have distinct effect in bringing us to a clear consciousness of the close and friendly relations between science and philosophy main-

tained from the days of Bacon, Galileo and Descartes till broken off, during the estrangement between the German idealists and modern scientific men, since 1840. This is a long story, upon which I can not enter now. Further, it happens to have been misunderstood or forgotten till within the last few years. An earnest of better things appears to some at least to be one of the most interesting features of contemporary tendencies. To build this promise into actual fact, we need just such books as this. And, accordingly, Dr. Hastie has fairly won our warmest thanks. It is one of his greatest merits that he stands clear from all scientific and philosophical controversies, and so can state what he knows in its definite bearings, not in those which he might desire it to assume.

There must be some good hope for the future of Scottish theology when, at the university which has recently lost from its staff the most eminent living British physicist and the greatest living British Kantian scholar, the chief chair of the divinity faculty is ornamented by the occupancy of a thinker so successful in appreciative unification of the sundered learning of his famous colleagues.

R. M. WENLEY.

UNIVERSITY OF MICHIGAN.

*A School Chemistry.* Intended for use in High Schools and in Elementary Classes in Colleges. By JOHN WADDELL, B.A. (Dal. Coll.), B.Sc. (Lond.), Ph.D. (Heidelberg), D.Sc. (Edin.). Member of the American Chemical Society; formerly Assistant to the Professor of Chemistry in Edinburgh University; Lecturer in Chemistry in the School of Mining, Kingston.

So far as the general method of arrangement and treatment is concerned, this book is similar to others intended for the same purpose; but there are several points to which attention might be called. The author has avoided the error so often made of subordinating facts to theories, and says in the preface: “The endeavor is made in this book to help the pupil in the discovery of new facts, to enable him to see their connections, and to show how facts lead to theory and theory aids in investigation



and in the discovery of further facts. The subject is presented in what seems to me the correct perspective, theory being subordinated to fact." The method of treatment is the interrogatory one and an effort is made to teach the student to observe for himself. While this method is an excellent one in theory it is doubtful whether it can be used with success with a class of beginners who have had no experience in scientific methods. In the early stages of the work they must be taught how to observe, and their powers of observation must be trained by showing them what they should see in each case. In some cases the important features of the experiment might be entirely overlooked and unimportant details magnified if the attention is not directed to the desired points. Of course, this might be overcome by constant personal contact with the student; but such is hardly possible in many institutions.

J. E. G.

BOOKS RECEIVED.

- Les diastases et leurs applications.* E. POZZI-ESCOT. Paris, Masson et Cie. 1900. Pp. 217.
- Alcyonium.* SYDNEY J. HICKSON. London, Williams & Norgate. 1901. Pp. viii + 22. 3 Plates.
- Lehrbuch der vergleichenden Anatomie der wirbellosen Thiere.* ARNOLD LANG. Jena, Gustav Fischer. 1901. Pp. vi + 311.
- Proceedings of the Iowa Academy of Sciences for 1899.* SAMUEL W. BEYER. Des Moines, F. R. Conway. 1900. Volume VII. Pp. 212.
- Bibliotics or the Study of Documents.* PERSIFOR FRAZER. Philadelphia, J. B. Lippincott Company. 1901. Pp. xxiv + 226.
- Thirty-second Annual Report of Births, Deaths, Marriages and Divorces in Michigan.* JUSTUS S. STERNS. Lansing, Robert Smith Printing Co. 1900. Pp. xvi + cixxii. Tables, 189.
- Laboratory Companion.* W. A. SHENSTONE. London, Edward Arnold. 1901. Pp. viii + 117.
- Theoretical Mechanics.* L. M. HOSKINS. Stanford University, Cal., published by the Author. 1900. Pp. x + 436. \$3.25.
- Reservoirs for Irrigation, Water-Power and Domestic Water-supply.* JAMES DIX SCHUYLER. New York, John Wiley & Sons; London, Chapman & Hall, Limited. 1901. Pp. xviii + 414.

SCIENTIFIC JOURNALS AND ARTICLES.

In the January number of the *Physical Review* Theodore Lyman presents the results of a study of the 'false spectra' often produced by a Rowland concave grating. These spectra are most clearly seen in the extreme ultra-violet, and are shown to be diffraction spectra of much less dispersion than the ordinary spectra. They appear to be due to errors of ruling, extending over the whole surface of the grating. A. A. Noyes describes in the same number a modification of the usual method of determining transference numbers, and applies the method to a large number of salt solutions of varying concentration. The application of interference methods to the determination of Poisson's ratio forms the subject of an article by J. R. Benton; while two articles by Chas. T. Knipp deal respectively with the employment of the bicycle wheel in illustrating the principles of the gyroscope, and with a new form of automatic temperature regulator. The former article describes a number of simple experiments with an ordinary bicycle wheel which are readily performed, and at the same time illustrate very strikingly the properties of the gyroscope and gyroscopic pendulum. Experiments are described by E. C. Roberts to determine whether the dielectric constant is altered by a magnetic field. The results are wholly negative.

THE January number of the *American Journal of Mathematics* (Vol. XXIII., No. 1), contains the following articles: 'Die Typen der linearen Complexe rationalen Curven im  $R_r$ ,' by S. Kantor; 'Transformation of Systems of Linear Differential Equations,' by E. J. Wilczynski; 'Distribution of the Ternary Linear Homogeneous Substitutions in a Galois Field into Complete Sets of Conjugate Substitutions,' by L. E. Dickson; 'Distribution of the Quaternary Linear Homogeneous Substitutions in a Galois Field into Complete Sets of Conjugate Substitutions,' by T. M. Putnam; 'On the Determination and Solution of the Metacyclic Quintic Equation with Rational Coefficients,' by J. C. Glashan; 'Construction of the Geometry of Euclidean  $n$ -Dimensional Space by the Theory of Continuous Groups,' by E. O. Lovett; 'A Table of Class Numbers for Cubic Number

Fields,' by L. W. Reid; 'On Certain Properties of the Plane Cubic Curve in Relation to the Circular Points at Infinity,' by R. A. Roberts. The number contains a portrait of the venerable ex-mathematician, George Salmon, Provost of Trinity College, Dublin.

*The Popular Science Monthly* for February has for its leading article 'Huxley's Life and Work,' by Lord Avebury, being the first Huxley Memorial Lecture of the Anthropological Institute of Great Britain. 'Malaria,' by Geo. M. Sternberg, being the address of the President of the Philosophical Society of Washington, gives a *résumé* of our knowledge of this subject and brings it up to date. 'A Study of British Genius,' by Havelock Ellis, is based on the Dictionary of National Biography and this, the introductory paper of a series, explains how the selections were made and gives the names of those selected. 'The Weather vs. the Newspapers,' by Harvey Maitland Watts, is an excellent brief exposition of the main facts of weather phenomena and of the general misunderstanding by the press and public. A brief and interesting article on 'The Philippines Two Hundred Years Ago,' by E. E. Slosson, is culled from the writings of Father Dominick Fernandez Navarette and Dr. John Francis Gemilli Careri. 'The Prehistoric Tombs of Algeria' are described by Alpheus S. Packard. Charles L. Bristol treats of 'The York Aquarium,' and in 'Chapters on the Stars,' Simon Newcomb discusses their clustering, the Milky Way, and stars with waning brightness. Finally Oliver C. Farrington, in 'A Century of the Study of Meteorites,' gives a brief summary of our knowledge of these bodies. Discussion and Correspondence comprises two contributions that especially deserve to be read, the one 'A Defense of Christian Science' as a fine example of this peculiar style of 'scientific' writing; the other 'Mr. Tesla's Science,' for its temperate criticism of certain kinds of 'science.' The departments of 'Scientific Literature and the Progress of Science' contain much good reading.

*Bird Lore* for February opens with an article on 'Pelican Island Revisited,' by Frank M. Chapman, with numerous and admirable illustra-

tions from photographs by the author. 'Elliott Coues on Audubon' is a verbatim report of an address delivered by Dr. Coues before the American Ornithologists' Union in 1897, and this is followed by 'Three Letters to Audubon's 'Kentucky Lads'' (his sons Victor and John), contributed by Maria R. Audubon. 'An Adirondack Lunch Counter,' with illustrations, describes the habits of some of the winter visitors. The second series of 'Birds and Seasons' discusses the birds to be met during February and March in various sections of the country, and then comes 'The Christmas Bird Census,' giving a list of the birds noted on that day at various places from Massachusetts to California and Canada to Louisiana. There is an interesting paper, by C. William Bebee, of a pair of Bald Eagles in the New York Zoo, who built a nest and have placed therein a good-sized stone on which they sit. Reviews and the department devoted to the Audubon Societies complete the number.

*The Vermonter*, St. Albans, Vt., C. S. Forbes, publisher, begins the year in magazine form and proposes to print monthly articles on the history, science and mineral interests of Vermont. The February number contains an interesting article on the geology of Vermont by Professor Henry M. Seely, of Middleburg College.

THE University of Missouri is about to publish, under the editorship of Frank Thilly, professor of philosophy, a series of *University Studies*, containing contributions by members of the faculty and graduate students.

#### SOCIETIES AND ACADEMIES.

##### PHILOSOPHICAL SOCIETY OF WASHINGTON.

At the 529th meeting held February 2, 1901, three reports were made of observations during the solar eclipse of May 28, 1900.

Professor S. P. Langley reported on the Smithsonian observations at Wadesboro, N. C., exhibiting many lantern slides of the apparatus used and superb photographs of the corona and sky. He stated that direct photographs were taken showing the moon 15 inches in diameter, and that the bolometric work, performed by Mr. Abbot, showed the heat from the corona to be only five eighty-fifths of that received from

the full moon. He dealt particularly with the interest that attached to further photography of the region of the sun independently of the corona, and pointed out that with a wider shadow track, such as might be expected in Sumatra in next May, there was reason to expect that stars as small as the ninth magnitude might be secured; and he showed that on a reasonable supposition as to brilliancy the diameter of such a body might be supposed to be something like the one one-hundredth part of that of Mercury, or in a rough way, one-tenth of a second on the solar disk. The observers were aided of course by irradiation in seeing this as a star, while on the surface of the sun he could say from a good deal of experience that such a body would be invisible.

The argument against the existence of a zone of such small bodies, from their never having been seen on the sun's face, was therefore inconclusive. He did not himself look forward with confidence to any new discovery being made in this direction, but he was encouraged by the opinion of a very competent adviser to think that the observation was worth repeating under better conditions. It was also desirable to repeat and extend the observations on the heat of the inner corona made at the late eclipse, and he had decided to send out a very small expedition to Sumatra in the immediate charge of Mr. C. G. Abbot, of the Smithsonian Astrophysical Observatory. The ultimate station in the interior of the island has not yet been determined.

Professor S. J. Brown, of the Naval Observatory, showed slides from some of the photographs taken by his party in North Carolina, those of the flash spectrum being specially interesting, and other slides from Mr. Burckhalter's photographs in which the outer portions of the corona had a progressively longer exposure than the inner parts.

Dr. L. A. Bauer reported on 'The Coast and Geodetic Survey, Magnetic Observations During the Late Eclipse.' Records from several stations within and without the belt of totality showed that at all of them the regular morning change of declination was interrupted very nearly at the time of totality and reversed in direction for half an hour to an hour, the aver-

age magnitude of the reversed movement being about 30 seconds, while the probable error of a reading is not over 3 seconds. At one station the intensity was observed, and here a similar reversal of the regular change was noted, amounting to three times the probable error of a reading, the intensity being diminished. No satisfactory explanation has yet been given of these reversals.

CHARLES K. WEAD,  
Secretary.

#### BIOLOGICAL SOCIETY OF WASHINGTON.

THE 333d meeting was held on Saturday evening, January 26th, and was devoted to a discussion of the question of 'Former Land Connections between Asia and North America.' In introducing the subject F. A. Lucas said the questions to be considered were the existence and probable geologic time of such connections and their place, whether by way of the Aleutian Islands or across Bering Strait. The distribution of the North American sheep and brown bears, the presence of abundant and comparatively fresh remains of the northern mammoth, *Elephas primigenius* in the northwest, and the fact that the remains of a bison, *B. crassicornis*, were found in Alaska only pointed to a rather recent and brief land connection. Hints of a much earlier land connection were shown by the existence of a fossil *Nemorhedus* in Colorado and by the occurrence of the southern mammoth, *Elephas columbi*, from Oregon southwards and eastwards.

Theo. Gill said that the fossils and recent mammals pointed to a recent brief connection between the continents, but that a more ancient one was indicated by the distribution of certain fresh-water fishes. The pike, *Lucius lucius*, was common to Europe, Asia and America and the nearest allies of the American *Polyodon* and *Scaphirhynchus* were *Psephurus* and several relatives of *Scaphirhynchus* found in Asia. These fishes were of old types, while the existing Cyprinoid fishes so characteristic of the streams of North America did not occur in Asia.

W. H. Dall discussed the geology of the contiguous portions of Asia and North America, and described the hydrographic and climatic conditions existing in Bering Sea, saying that

owing to the depth of water and configuration of the bottom between the western Aleutian Islands and Asia no land connection could have taken place there. That even man could have crossed at this point on the ice was also out of the question, as the pack ice rarely reached even the easternmost islands of the chain. The speaker spoke of the conditions under which the excrement of the Mammoth was found in the body of land ice about Kotzebne Sound, as this showed that the animal actually traveled over the ice now in place. The water of Bering Strait was stated to be so shallow that it might readily have been filled with ice during the glacial period, and the Mammoth might have crossed over this ice bridge.

F. V. Coville discussed the character and distribution of the vegetation of the adjacent regions, stating that the absence of trees, common to the adjacent portions of Asia and North America, showed that there could have been no recent land communication of any long duration. The smaller plants pointed to a brief recent union of the continents.

L. Stejneger said that the genus *Alligator* of the southern United States also occurred in Asia, and the nearest relatives of the hell-bender, *Cryptobranchus*, of the eastern United States were the giant salamanders of Japan and western Asia, and that these facts indicate an old land connection of long duration. The existence of a circumpolar fauna, which had been lightly treated by previous speakers, also appeared to Dr. Stejneger to corroborate the evidence of the reptiles and batrachians.

F. A. LUCAS.

#### ANTHROPOLOGICAL SOCIETY OF WASHINGTON.

THE 312th meeting was held on January 29th.

Dr. George M. Kober exhibited an antique German clock which he collected in Hesse Darmstadt. This clock, though only 125 years old, is closely patterned after the clock of Henry de Wyck (1364).

W J McGee gave an interesting account of his explorations in Sonora, Mexico, and in Southern Arizona. The search for the Tepoca Indians, relatives of the Seri, which was the principal object of the expedition, proved futile, the Te-

pocas recently having disappeared from their former location. Mr. McGee also visited the Cocopas living on the tide flats near the mouth of the Colorado in an isolated locality. It was observed that the Cocopas are not fishermen, though their situation offers great advantages for that pursuit. They practise agriculture in a primitive manner and make use of few introduced plants. These Indians are declining rapidly in number, the chief cause stated by Mr. McGee being the adoption of European clothing. Mr. McGee during this expedition found along the Colorado a new method of picture writing, pebbles having been removed from an even gravelly surface to form various designs.

Owing to the illness of the President, Professor W. H. Holmes, the exhibition and unwrapping of a Peruvian mummy by Professor Holmes and Walter Hough was postponed.

Major Powell's important paper on 'Philology' occupied the greater part of the evening and was discussed by Albert S. Gatschet and Alice C. Fletcher. The paper is the fourth of a series of five on Demonology, or human activities. Major Powell in a closely reasoned paper treated of language under the heads of emotional language, oral language, gesture language, written language and logistic language. His treatment of emotional language was especially attractive. He insisted that languages were formerly more numerous than now, the tendency being toward coalescence.

At the close of the paper the discussion was participated in by P. B. Pierce, Rev. Henry M. Bann, J. H. McCormick and W J McGee.

WALTER HOUGH.

#### CHEMICAL SOCIETY OF WASHINGTON.

THE regular meeting was held on January 10, 1901. The following officers were elected for the ensuing year: *President*, Mr. V. K. Chestnut; *Vice-Presidents*, Dr. W. F. Hillebrand, Dr. F. K. Cameron; *Secretary*, Mr. L. S. Munson; *Treasurer*, Mr. F. P. Dewey; *Additional Members of the Executive Committee*, Dr. H. N. Stokes, Dr. H. C. Bolton, Mr. E. E. Ewell, Mr. L. M. Tolman.

WILLIAM H. KRUG,  
*Secretary.*

SECTION OF ANTHROPOLOGY AND PSYCHOLOGY  
OF THE NEW YORK ACADEMY OF SCIENCES.

A REGULAR meeting of the Section was held on January 28th. A paper on 'Certain Racial Characteristics of the Base of the Skull' was presented by Dr. A. Hrdlicka. The paper dealt with the middle lacerated foramen, the petrous portions of the temporal bones and the styloid. The author demonstrated the different stages of development of these parts in primates and at different stages of life in the whites, and the differences of those parts, fully developed, in the negroes, Indians and whites. In the adult whites the average middle lacerated foramen is large, the petrous portions appear considerably sunken (bulging of surrounding parts), the styloid is well developed. In the Indian the foramen is but a moderate size, in negro small, in apes absent; the petrous portions are less sunken in the Indian than in the white, on, or almost on, the level with the surrounding parts in the negro, bulging more or less beyond these in the primates; the styloid is in the majority of cases small in the negro and small to rudimentary in most of the Indians. Where the styloid is rudimentary, the vaginal process often plays a compensatory part. In whites all the mentioned stages of the parts described may be observed at different periods of life. Brain development accounts for the differences in the size of the middle lacerated foramen and the relative position of the petrous portions.

The second paper was on 'The Alesia Indians of Oregon' and was read by Dr. Livingston Farrand. The paper reported observations made by the author on the language customs and traditions of this tribe.

CHARLES H. JUDD,  
*Secretary.*

## DISCUSSION AND CORRESPONDENCE.

## FREE SPEECH IN UNIVERSITIES

RECENT events in certain American universities have again raised the old question as to the right of the professor to freedom of speech. Sensational reports in the newspapers have loosened floods of sympathy for the alleged victims of tyranny, and the popular belief is

that great wrong has been done. Whether this belief is correct or not, few men are in a position to know, for the complete evidence has not been made public, and in default of that no reasonable criticism is possible. But a discussion of the principles involved in such cases is in order, and, indeed, it seems to be most necessary.

That a university professor should be free to teach his honest convictions would seem at first sight to be a most reasonable proposition. But the rights of the teacher are not absolute; they are limited by the rights of the pupils and the rights of the institution in which he is employed. The institution must protect its own dignity and reputation; the student is entitled to protection against obvious error and against the wastage of his time; and to these rights the rights of the professor are subordinate.

Suppose for example that a professor of mechanics should spend his time in teaching his class the possibility of perpetual motion. Or that the professor of mathematics should try to demonstrate in the class-room the squaring of the circle. Or that the professor of astronomy should denounce the heliocentric theory of the solar system and adopt the mediæval teachings of Cosmas Indicopleustes. His right to freedom of teaching would avail him little, and he would be promptly invited to resign his position. The right of the professor to teach is conditioned by the right of the pupil to learn, and the latter right is entitled to first consideration. The teacher has no right to teach nonsense nor to waste the time of his students over his own personal vagaries. Irresponsible freedom of speech or of teaching is plainly inadmissible; a point which certain sentimentalists have failed to see.

The present controversy, however, has not dealt with obvious questions of truth or error, but with subjects which are still under discussion and unsettled. In sociology and economics we find the chief difficulties, and here the rights of the professor are not quite so clear. Still, the responsibility on his part remains, and it cannot be honestly evaded. If a professor of sociology, speaking in his class-room, should denounce the present institution of marriage

and advocate either polygamy or free love, his honesty of purpose, his right to teach his views, would not protect him from dismissal. This is an extreme case, a case not likely to arise, but it serves to illustrate the principles at issue. All the rights of the professor are governed by reasonable limitations.

Unfortunately, at the present time, the leading economic and social questions are partly political in their nature. Their public discussion is almost wholly partisan, rarely scientific, and violent passions are easily aroused. The tariff, the coinage, the question of the so-called trusts are all alive in the public mind, and the professor of economics therefore stands on very precarious ground. What are his rights and his duties now? They are still limited, and his responsibilities are greater than ever.

Whatever a teacher may be in his private life, his personal bias is to be put under strict control the moment he enters his lecture room. There the partisan is out of place, and the interests of science rule. The professor now should cease to be an advocate, seeking to win converts, and become the equivalent of a judge who sums up the case before a jury. He must be fair, judicial, tactful and dignified; and failure in any one of these particulars is a serious limit to his usefulness. He may believe in free trade, but he should give the evidence and arguments upon both sides of the question. If he neglects to do this he defrauds the students of their rights and is a failure as a scientific teacher. He need not efface himself, he need not suppress his preferences, but he must be fair and thorough. The pupil can not understand an economic controversy without hearing both sides, and his rights in this respect are entitled to consideration. The class-room is no place for political tirades, nor for partisan denunciation, either of institutions or of individuals; it should be sacred to honest scientific discussion, regardless of parties or persons. A want of tact upon the part of the teacher, a lack of dignity in his treatment of a doubtful question, may easily become a source of trouble and justly lead to his dismissal.

That some teachers may have been unfairly treated I will not deny, for in the conflict of

rights it is sometimes difficult to strike an even balance. What I have said applies to general principles, not to any special, concrete cases. Each case stands upon its individual merits, which are rarely known except to the parties who are immediately affected. The principles, however, are clear, and should be borne in mind whenever the management of a university is criticized. The latter may be in the right, despite appearances; and it is quite conceivable that a teacher may be in the wrong.

F. W. CLARKE.

#### SHORTER ARTICLES.

##### THE RELATION OF SEEDINESS TO QUALITY IN MELONS.

IN the *Memoirs of the Torrey Botanical Club*, Vol. 1, No. 4, issued May 30, 1890, the late Dr. E. Lewis Sturtevant contributed an article on 'Seedless Fruits' in which he presented a large amount of data compiled from various sources relative to seedless fruits as correlated with quality. Some of his statements I quote as follows: "There seems to exist in fruits a correlation between seedlessness and quality, especially when that quality is expressed by the term tenderness of tissue." "The better varieties of the apple usually contain some abortive seeds, and are sometimes individually to be found seedless. As a rule, where there is a tendency to abortive seeds, the larger and finer the apple the greater the number of abortive seeds." "Melons of the highest quality contain fewer seed than do varieties of medium or inferior quality, as I have often observed. This even seems to hold true as between individual fruits of the same variety to a marked extent."

In the autumn of 1893, my assistant, Mr. Cranefield, made a study of thirty-five muskmelons to ascertain to what extent Dr. Sturtevant's conclusions would be verified. The data have been preserved, but the results have not before been published.

These melons were the result of a cross between the Algiers cantaloupe and several American varieties. The fruits were picked when the stem readily detached, and weighed on a torsion balance that is sensitive to the

tenth of a gram. They were then cut into halves and the seeds were taken out and weighed with the adhering pulp, after which the seeds were removed from the pulp, wiped as dry as possible on a towel and weighed. The percentage of seeds was computed by dividing the weight of the seeds by the weight of the melon. The diameter of the melon was then measured, also the thickness of the flesh and of the rind. The flesh was then tested for firmness, texture and flavor. The flavor was rated on the scale of five as best.

In five melons rated poorest in flavor, the weight of the seeds averaged 1.636 per cent. of that of the melon; in five rated of best quality, the weight of the seeds averaged 1.34 per cent. of that of the melon.

In five melons of 'coarse' texture, the weight of the seeds averaged 1.764 per cent. of that of the melon; in five of 'fine' texture, the weight of seeds averaged 1.364 per cent. of that of the melon.

In five melons having the thickest flesh, the weight of the seeds averaged 1.53 per cent. of that of the melon; in five having the thinnest flesh, the weight of seeds averaged 1.54 per cent. of that of the melon.

In five of the heaviest melons, the weight of the seeds averaged 1.34 per cent. of that of the melon; in five of the lightest, the weight of the seeds averaged 1.684 per cent. of that of the melon.

It appears that so far as texture of flesh and flavor are concerned, Dr. Sturtevant's conclusions were verified.

E. S. GOFF.

WISCONSIN AGRICULTURAL EXPERIMENT STATION.

#### PREDETERMINED EVOLUTION.

THE American Redstart (*Setophaga ruticilla*) is structurally very widely separated from the true Redstart (*Ruticilla phoeniceus*) of Europe, and yet outwardly resembles it to an extraordinary degree. This fact has caused Professor Alfred Newton (*Ency. Brit.*, XX., 318) to write as follows: "The wonderful likeness, coupled of course with many sharp distinctions, upon which it would be impossible to dwell, between the birds of these two genera of perfectly distinct

origin, is a matter that must compel every evolutionist to admit that we are as yet very far from penetrating the action of creative power, and that especially we are wholly ignorant of the causes which in some instances produced analogy."

Cases of this sort may excite our wonder, but they are much more common than is often realized. In New Mexico and Arizona we have a series of numerous species of snails, which possess shells in no way distinguishable, except in a specific sense, from those of the genus *Polygyra*, which is dominant in the eastern States. During the last two years the anatomy of several of these species has become known, and it turns out that they are not even closely allied to *Polygyra*, but represent a peculiar genus which has been named *Ashmunella* (Pilsbry and Cockerell). In Arizona and southern New Mexico there is another series of snails, which has nearly the shell of *Epiphragmophora*, a genus of the Pacific coast. The species were always referred to the last-mentioned genus until Professor Pilsbry recently dissected one of them, *E. hachitana* of Dall. It then appeared that we had here another perfectly distinct genus, which was named *Sonorella* (Pilsbry). But not only do these interesting resemblances occur between species of our continent; they are seen equally between species of different continents. Some of the California species of *Epiphragmophora* so closely resemble the European *Arionta* that naturalists were for a long time deceived. I have recently had occasion to notice the extraordinary resemblance between certain Japanese snails and those of the United States. Thus, *Eulota connivens* (Pfr.) of Japan might easily be taken for *Sonorella hachitana* of Arizona; and *Eulota mercatoria* (Gray) is remarkably similar to *Epiphragmophora fidelis* (Gray), the first being from Japan, the second from Oregon.

Is it possible that we may find a real, if imperfect, parallel between this independent development of similar species and the development of diverse cells in the metazoa? A human being, for instance, contains innumerable cells of very diverse nature, all descended directly from the ovum or germ-cell. If these cells were not parts of an organic whole, but lived separate lives, we should speak of their descent

from a primitive common ancestor (the germ-cell) and their evolution in the course of countless generations into distinct genera and species. Coues, in fact, has gone so far, in writing of bird-anatomy, as to treat the different kinds of cells as pertaining to several genera and species, which he names.

But we are here met by the extraordinary fact that all this complicated development and evolution is repeated anew in every individual, and that, speaking broadly, the course of cellular evolution is predetermined in the germ. This fact is so commonplace to us that we have ceased to realize the wonder of it, or its possible significance as a hint of the method of evolution among species.

Why may it not be that the evolution of species, to a greater or less extent, is similarly predetermined, and that here is to be found the explanation of the phenomena described in the beginning of this note? If life exists in Mars, a knowledge of it would go far toward answering such a question. How much similarity would there be between creatures evolved on two planets, with all the diversity of conditions which this implies?

T. D. A. COCKERELL.

EAST LAS VEGAS, N. M.,  
January 29, 1901.

#### NOTES ON PHYSICS.

##### NON-PERMANENCE OF WEIGHT.

EXPERIMENTS by Heydweiller (*Phys. Zeitschr.* Aug. 25, 1900), similar to those of Laudolt (*Zeit. für Phys. Chem.*, 12, p. 1, 1893), seem to show that a slight change of total weight accompanies some chemical reactions. These experiments have been interpreted by some reviewers as throwing doubt upon the axiom of the conservation of matter. This axiom is not, however, incompatible with variation of total weight in chemical or even in physical changes. If it should be found, for example, that the weight of a given amount of lead and of a given amount of oxygen varied with physical and chemical conditions, a *standard state* of lead and a *standard state* of oxygen would have to be adopted in which state these substances would always have to be weighed, and the principle of the conservation of matter would

have to be stated thus: Given so much lead and so much oxygen, measured by weighing under standard conditions, then, whatever changes these substances undergo, the amount of each is found to be unchanged if both are brought back to standard conditions and weighed.

Variation of weight with physical and chemical conditions would, no doubt, throw light upon the nature of gravitation, but if such a variation becomes established it will have but little disturbing influence upon the notion of the indestructibility of matter.

In the light of Professor Fessenden's electrical theory of gravitation, it would seem that the change of state most likely to produce a change of weight would be the dissolving of an electrolytic salt in water. For, assuming electrolytic dissociation to be a separating of positively and negatively charged atoms or *ions*, the region throughout which the electric force of the atom is exerted would be greatly extended by the dissociation.

#### THE ELECTRO-MAGNETIC THEORY OF RADIATION.

PROFESSOR M. PLANCK, of Berlin, published some months ago a derivation of the formula connecting energy and wave-length in the spectrum of a black body at a given temperature, the derivation being based upon the notion of an electrical resonator enclosed in a space surrounded by perfectly reflecting walls. It is remarkable that this formula should agree with the formula of Stefan obtained by thermodynamical considerations. In the *Verhandlungen d. Deutschen Phys. Gesellschaft*, for December 1900, Professor Planck has given an outline of some work, soon to be published in full, in which he applies the method of probabilities to the determination of the partition of energy among a vast number of electrical resonators enclosed within a reflecting boundary. A consequence of the theory developed by Professor Planck, which gives some check upon its legitimacy, is a formula which permits the calculation of the number of actual molecules of any salt in a gram-molecule (the number of atoms in a gram of hydrogen), the basis of the calculation being the energy curve of the spec-



trum of a black body as determined by Lummer and Pringsheim and by Kurlbaum. It is thus found that an atom of hydrogen weighs  $1.64 \times 10^{-24}$  grams. Professor Planck compares this result, together with other results depending upon it, with previous approximate determinations of this quantity, and he remarks that the values determined by his formula are *not approximations*, but that the calculations are absolutely valid, provided that his theory is true.

W. S. F.

#### NOTES ON INORGANIC CHEMISTRY.

IN an article by Berthelot in the *Annales de Chimie et de Physique* on Egyptian gold, it appears that in the earliest epochs, argentiferous alluvial gold was used for coins and other articles. Only later, from the time of Croesus down, was the gold refined. The period of manufacture can be approximately told by analysis, owing to the rarity of minerals which yield gold free from silver. Specimens of gold from the fifth and twelfth dynasties show about four per cent. of silver, but those from the Persian epoch consist of almost pure gold.

IN a recent number of the *Chemical News*, Dr. J. H. Gladstone gives an account of analyses made of specimens of gold leaf from Egyptian mummies, supplementing the work of Berthelot spoken of above. Down to the time of the eighteenth dynasty the foil is evidently made from the native alloy, containing from four to eighteen per cent. of silver, the latter alloy closely approaching electrum. The specimens from the first dynasty show a similarity of composition, coming from a single source, but those from the later dynasties differ among themselves, and evidently had different origins. Little copper is found in any of the foils. A very thin superficial crust of chlorid of silver is found in some of the foil, indicating a slow diffusion of one part of the alloy—the silver—till it reaches the outside surface, where it meets with the chlorid that exists in the sands of the desert. That the Egyptians were acquainted with different qualities of gold is evidenced by the Harris papyrus, containing the annals of Rameses III., about B. C. 1200, where mention is made of gold, pure gold, good gold, white gold, best gold,

gold of the second quality, fine gold of the land, gold of the land of Koebti, and of Kush.

THE recent cases of poisoning in England from arsenic contained in beer, and the differing results obtained by the chemists who have analyzed the beer in question, have given rise to an extended discussion in the *Chemical News* and elsewhere, as to the value of the tests for arsenic which are commonly relied upon to detect and estimate the amount of arsenic in suspected substances. This discussion is well timed, for, in the whole field of toxicology, no substance is more frequently to be tested for than arsenic. The test most generally depended on is Marsh's, and this is taught in almost every laboratory, of college and medical school. As a matter of fact, while this test is thoroughly reliable in the hands of a skilled analyst, it is beset with so many difficulties, which interfere with its accuracy, that it is of little value except when carried out by a chemist who has had long experience with it; indeed in the hands of a neophyte it is often wholly misleading. This is well shown in the recent cases, where the results obtained by the different analysts were very conflicting. On the other hand, even with unskilled chemists, Reinsch's test, when properly carried out, is thoroughly to be depended on, and is under ordinary circumstances more delicate than that of Marsh. Not the least of its advantages is the fact that it requires but a short time and the simplest apparatus only. Its value is well brought out by no less an authority than A. H. Allen, writing in the *Chemical News*. It is greatly to be hoped that the present agitation will result in placing the tests for arsenic on their proper relative basis.

SOMETIME since attention was called in this column to the fact that in the examination of quite a number of canned goods, tin was found present in every instance. A paper on the same subject by F. Wirthle has appeared in the *Chemiker Zeitung*, dealing with canned meat, mostly beef. The goods were from one to five years old, and in each case tin was found, and, as was also true of the experiments above referred to by Cowan and the writer, only the

slightest trace of lead. The quantity of tin found increased from year to year, as would have been inferred from the greater corrosion in the interior of the can in the older specimens. Wirthle concludes that the tin was in the form of the basic chlorid, and due to the action of the common salt in the meat, though in one instance the sulfid of tin was found. On the other hand tin was found by Cowan in canned fruits and tomatoes, and by Weber in canned pumpkins. It is greatly to be wished that a series of experiments should be carried out with a view of determining the effect of tin in small quantities upon the human organism, for little is known of its physiological action. From the amounts which are constantly ingested with canned goods, and seemingly without injury, it is to be inferred that it has little if any deleterious action, but it would be well were this established.

IN this connection, Roman and Delluc call attention in the *Journal de Pharmacie et de Chimie* to the presence of zinc in some samples of 95 per cent. alcohol examined by them. Since similar alcohol showed a reaction for zinc after being kept in contact with galvanized iron scrap for two days, the presence of the zinc in alcohol was accounted for by its having been kept, as is often the custom, in a galvanized iron vessel.

J. L. H.

#### THE U. S. NAVAL OBSERVATORY.

THE Naval Appropriation Bill, as passed by the Senate, contains the following provisions, authorizing the appointment of a board of visitors to the Naval Observatory and incidentally requiring the superintendent to be a line officer of the Navy :

For the expenses of the board of visitors to the Naval Observatory, two thousand dollars. There shall be appointed by the President from persons not officers of the United States a board of six visitors to the Naval Observatory, four to be astronomers of high professional standing and two to be eminent citizens of the United States. Appointments to this board shall be made for periods of three years, but provision shall be made by initial appointments for shorter terms so that two members shall retire in each year.

Members of this board shall serve without compensation, but the Secretary of the Navy shall pay the actual expenses necessarily incurred by members of the board in the discharge of such duties as are assigned to them by the Secretary of the Navy or are otherwise imposed upon them. The board of visitors shall make an annual visitation to the Observatory at a date to be determined by the Secretary of the Navy, and may make such other visitations not exceeding two in number annually by the full board or by a duly appointed committee as may be deemed needful or expedient by a majority of the board. The board of visitors shall report to the Secretary of the Navy at least once in each year the result of its examinations of the Naval Observatory as respects the condition of buildings, instruments, and apparatus, and the efficiency with which its scientific work is prosecuted. The board of visitors shall prepare and submit to the Secretary of the Navy regulations prescribing the scope of the astronomical and other researches of the Observatory and the duties of its staff with reference thereto. When an appointment or detail is to be made to the office of astronomical director, director of the Nautical Almanac, astronomer, or assistant astronomer, the board of visitors may recommend to the Secretary of the Navy a suitable person to fill such office, but such recommendation shall be determined only by a majority vote of the members present at a regularly called meeting of the board held in the city of Washington. The Superintendent of the Naval Observatory shall be a line officer of the Navy of a rank not below that of captain.

This is what Senator Chandler promised as legislation to improve the management of the Observatory, but it is not likely to meet with the approval of those interested in the efficiency of the institution. A board of visitors of this character has but little real power, whereas it would serve as an excuse for any shortcomings there may be in the work of the Observatory. The board may recommend persons to fill vacancies in the staff, but it is not clear that the Secretary of the Navy is under any obligations to follow its recommendations. The astronomers apparently remain naval officers and the superintendent must be a line officer. These provisions make it still more desirable to urge the passage of Senator Morgan's bill, presented in the last issue of this JOURNAL.

### THE DEPARTMENT OF AGRICULTURE.

THE provisions reorganizing certain divisions of the Department of Agriculture which, as we noted last week, were omitted from the appropriation bill as it passed the House have been reinserted by the Senate. The four bureaus provided and the staffs, as the bill now stands, are as follows:

*Bureau of Plant Industry.*—One plant physiologist and pathologist, who shall be chief of bureau, \$3,000; 1 plant pathologist, \$2,500; 1 botanist, \$2,500; 1 pomologist, \$2,500; 1 agrostologist, \$2,500; 1 assistant pathologist, \$1,800; 1 assistant botanist, \$1,800; 1 assistant pomologist, \$1,800; 1 assistant agrostologist, \$1,800; 2 clerks, class 3, \$3,200; 3 clerks, class 2, \$4,200; 3 clerks, class 1, \$3,600; 5 clerks at \$1,000 each; \$5,000; 2 clerks at \$900 each, \$1,800; 2 clerks at \$840 each, \$1,680 in all, \$39,680.

*Bureau of Forestry.*—One forester who shall be chief of bureau, \$3,000; 1 assistant forester, \$2,500; 1 assistant forester, \$1,800; 1 assistant forester, \$2,000; 1 chief clerk, \$1,800; 1 stenographer, \$1,200; 1 field assistant, \$1,500; 1 field assistant, \$1,400; 1 field assistant, \$1,200; 1 field assistant, \$1,000; 1 field assistant, \$720; 10 collaborators at \$300 each, \$3,000; 1 clerk class 3, \$1,600; 1 photographer, \$1,200; 1 computer, \$1,000; 3 clerks, class 1, \$3,600; 2 clerks at \$1,000 each, \$2,000; 4 clerks at \$900 each, \$3,600; 7 clerks at \$720 each, \$5,040; in all, \$39,160.

*Bureau of Chemistry.*—One chemist, who shall be chief of bureau, \$3,000; 1 assistant chemist, \$2,500; 1 assistant chemist, \$1,800; 1 assistant chemist, \$1,600; 2 clerks, class 1, \$2,400; in all, \$11,300.

*Bureau of Soils.*—One soil physicist who shall be chief of bureau, \$3,000; 1 scientist, \$2,500; 1 scientist, \$1,800; 1 scientist, \$1,000; 1 chief clerk, \$2,000; 1 stenographer, \$1,200; 3 clerks, class 1, \$3,600; 1 clerk, \$1,000; 1 clerk, \$840, 1 watchman, \$720; 1 charwoman, \$480; in all, \$18,140.

### SCIENTIFIC NOTES AND NEWS.

THE gold medal of the Royal Astronomical Society has been awarded to Professor E. C. Pickering, director of the Harvard College Observatory.

THE Amsterdam Society for the Advancement of Natural Science and Medicine has awarded its gold Swammerdam medal for 1900 to Professor Gegenbanr, of Heidelberg. The medal was established in 1880, and is awarded

once in ten years for researches in the biological sciences, having hitherto been conferred on Professor C. Th. von Siebold and Professor Ernst Haeckel.

PROFESSOR E. A. SCHÄFER, of the University of Edinburgh, was presented, on January 30th, with a testimonial by his former pupils at University College, London. The presentation took the form of silver plate and a sum of money to be used for the foundation of a Schäfer physiological research medal.

PROFESSOR MATHIAS DUVAL, of the École de Médecine at Paris, who has been obliged by the condition of his eyes to forego work for two years, has undergone a successful operation. We understand that he will now be able to resume his important embryological researches, which have already given him a foremost place among the embryologists of the world.

At a meeting of the trustees of the American Museum of Natural History, held on February 11th, the formal announcement was made of the gift to the Museum by Mr. J. Pierpont Morgan of the Tiffany collection of gems and of the famous Bement collection of minerals. Another very important gift is the ethnological collection brought together for the past twenty-five years by Andrew Ellicott Douglas. Mr. William E. Dodge was elected first vice-president of the Museum. Professor Henry F. Osborn was elected a trustee and second vice-president.

PROFESSOR J. PLAYFAIR McMURRICH, of the Medical Department of the University of Michigan, has been asked by the Government of the Netherlands to take charge of, and make a report on, a collection of actinians secured from the neighborhood of the Malay Archipelago. The collection includes specimens from along the shore and from the deep sea.

PROFESSOR WILLIAM DEWITT ALEXANDER, head of the survey department of Hawaii, has resigned to accept a position on the United States Coast and Geodetic Survey. He will have charge of that branch of the department which has to deal with Hawaii and Samoa.

DR. JOHN S. BILLINGS, JR., has resigned his position of instructor in clinical microscopy in the University and Bellevue Hospital Medical College, New York, and has become assistant

director of the Bacteriological Laboratory of the Department of Health.

COLONEL PETER SMITH MICHIE, professor of natural and experimental philosophy at the West Point Military Academy, died on February 16th, of pneumonia. He was born in Scotland in 1839, graduated from West Point in 1863, and has been professor there since 1871. He was the author of a number of scientific and other works, including 'Elements of Wave Motion relating to Sound and Light,' 'Elements of Analytical Mechanics,' 'Elements of Hydro-Mechanics' and 'Practical Astronomy.'

DR. J. H. LINSLEY, director of the Vermont Laboratory of Hygiene, died on February 17th at the age of forty-one years.

THE expedition sent by the U. S. Naval Observatory to observe the eclipse of May 17th was expected to leave San Francisco for Manila on February 16th. From Manila it will be transported to Sumatra by a U. S. warship, and headquarters will be established at Padang about a month before the occurrence of the eclipse. The party includes Professor Skinner, of the U. S. Naval Observatory; Professor Barnard, of the Yerkes Observatory; Dr. Mitchell, of Columbia University; Dr. Humphreys, of the University of Virginia, and Mr. Jewell, of the Johns Hopkins University.

It is reported in the *N. Y. Evening Post* that Mr. Marshall A. Saville, of the American Museum of Natural History, has made important discoveries in the ruins of the Palace of Mitla, in the state of Oaxaca, Mexico, his excavations having disclosed a number of chambers under the palace.

THROUGH the efforts of Mrs. William Bouton, the St. Louis Academy of Science has secured a fine collection of native and foreign butterflies.

MR. J. STANLEY-GARDINER, M.A., fellow of Gonville and Caius College, Cambridge, has presented the university with a collection of ethnological objects from the Maldive Islands and Minikoi Island.

THE Medical Department of the University of Buffalo is in receipt of a gift of \$50,000 for the purpose of erecting a laboratory to be devoted

to research work and to be known as the Gratiwick Research Laboratory.

WE learn from foreign exchanges that at a recent conference of German biologists, held at Berlin, a resolution was passed calling the attention of the Imperial Government to the importance of establishing five floating stations on the Rhine for the purpose of biological investigation. Great stress was laid on the practical advantages which pisciculture would derive from these establishments, and it was resolved that if the Government failed to provide the necessary funds, an appeal should be made to the States of Baden, Bavaria, Alsace-Lorraine, Hesse and Prussia.

PROFESSOR J. A. FLEMING reports that Mr. Marconi has succeeded in sending wireless messages between St. Catharine's, Isle of Wight, and the Lizard, a distance of two hundred miles.

THE Portuguese Government is sending a commission to the Portuguese possessions in West Africa to study the sleeping sickness which occurs there.

It appears that the plague is increasing in Bombay, about 1,000 deaths having occurred during the last week of which reports are at hand.

It is proposed to hold an Industrial and Polytechnic Exhibition in Birmingham during the coming summer, with the object of raising funds to endow scholarships at the University for the benefit of the children of the working classes.

THE inauguration of the work of the British National Physical Laboratory has been delayed by the opposition to the site at Richmond first proposed and by the alterations required in Bushy House, the building finally granted for the laboratory. The report of the executive committee for 1900, of which an abstract is given in *Nature*, describes the building and the alterations that are in progress. Bushy House itself will be used for the more delicate physical measurements; for the engineering work a new building, 80 by 50 feet in area, will be constructed. The work in prospect for the laboratory includes the connection between a magnetic quality and the physical, chemical and electrical

properties of iron and its alloys, with a view specially to the determination of the conditions for low hysteresis and non-ageing; the testing of steam gauges, indicator springs and the like, for which a mercury pressure gauge will be provided; standard screw-gauges; electrical standards, and optical, thermometric and photographic tests.

WE learn from the *London Times* that, by his will, Mr. Philip Crowley, F.L.S., F.Z.S., of Croydon, who died on December 20th last, and whose collections of birds' eggs and of exotic butterflies are among the largest known to exist, bequeathed to the Trustees of the British Museum, from his natural history collections, whether of eggs or insects or other objects, all up to four species, and of eggs, if in clutches, four clutches, and if there should be more than four specimens, in his collection to allow them to take half the extra, and should any species be useful or interesting by reason of variety or locality to allow them to take the whole series if they should think fit so to do—his idea being that what was really useful and wanted they might have, but that they should not take simple duplicates.

PENNSYLVANIA is a good second to New York in the forestry movement. Already it has secured 150,000 acres for its State forestry reservations. It will probably have 500,000 acres before the year ends, and looks forward to the acquisition of 1,500,000 or 2,000,000 acres. Its State College is now preparing to begin teaching practical forestry, and a bill has just passed the second reading in the House of Representatives which provides for the creation of a State Department of Forestry which shall be of equal importance with any other department of the Government. For years a campaign of education has been conducted in that State on very liberal lines, and it is largely to this that the popularity of forestry in Pennsylvania is due.

SANITARY science has scored two points of advantage during the month of January in two decisions of the New York Supreme Court, which make the pollution of streams by municipal corporations and private concerns actionable. Judge Houghton in General Term has granted an injunction against the city of

Gloversville for discharging its sewage into the Cayadutta creek, a tributary of Mohawk river. The Appellate Division has also affirmed the decision of Judge Stover in General Term, granting an indemnity against the Geo. West Paper Co., of Ballston, N. Y., for the pollution of the Kayaderosseras creek, a tributary of the Hudson river. Both suits were brought by private riparian owners, the former in spite of a bill passed by the New York Legislature of 1900, giving the city of Gloversville the right of disposal now denied it by the Court.

A LAW has recently been passed which permits the French Government to forbid the manufacture and sale of absinthe and certain other fabricated articles of drink, recognized and declared to be dangerous by the Academy of Medicine. The Chamber has now voted to request the Academy to indicate those drinks which contain substances dangerous to the public health, so that their manufacture and sale may be prohibited.

THE Right Honorable R. W. Hanbury M.P., President of the Board of Agriculture, has appointed a committee for the purpose of conducting experimental investigations with regard to the communicability of glanders under certain conditions, and as to the arresting and curative powers, if any, of mallein when repeatedly administered. The committee will consist of Mr. A. C. Cope, chief veterinary officer of the Board of Agriculture (chairman); Professor J. McFadyean, principal of the Royal Veterinary College; Mr. William Hunting, one of the veterinary inspectors of the London County Council; Mr. J. McIntosh McCall, assistant veterinary officer of the Board of Agriculture; Mr. H. A. Berry, of the Board of Agriculture, will act as the secretary to the committee.

BEFORE the Pan-American Medical Congress, which met recently at Havana, the board which has been engaged in the investigation of yellow fever, consisting of Drs. Reed, Carroll and Agramonte, made a report. According to despatches to the daily papers, it was stated that two of the main conclusions were that the specific cause of the disease is unknown, and that it can be carried only by mosquitoes. Conse

quently the disinfection of clothing and houses is useless. The fever can be produced by a subcutaneous injection of blood from a patient who must have had the disease for not more than two days. Mosquitoes must also bite the patient during the first two days of his illness or they cannot transmit the disease. The board kept an infected mosquito for fifty-one days, when it was allowed to bite a person who contracted the disease. The board differs from Dr. Finlay in that the latter holds that more than one kind of mosquito can convey yellow fever. The board says there is only one kind that can do so. Dr. Finlay also says that a mosquito can transmit the disease the fourth or fifth day after biting a patient, while the board says that twelve days must intervene. The board reported that non-immunes were allowed to sleep in infected clothing and bedding, but none contracted the disease. A member of the Congress objected that these so-called non-immunes might really have been immunes. The board replied that two of these were subsequently subjected to the bites of infected mosquitoes and contracted the disease. The moral aspect of the experiments was touched upon. It was pointed out that members of the board were themselves bitten and one of them died. Yellow fever is not due to dirt. It may occur in the cleanest localities. Dr. Wilde of the Argentine Republic proposed the creation of an international yellow fever board to study means of exterminating the disease.

THE Illinois Society of Engineers and Surveyors held its sixteenth annual meeting at Bloomington on January 23d-25th.

At a meeting in San Francisco a committee of fifteen was authorized for the preparation of plans for a Pacific Coast Medical Association.

A CONFERENCE of science masters in public schools was held recently in the rooms of the University of London, at South Kensington, with Sir Henry Roscoe in the chair and about fifty members in attendance. The subjects discussed included the order of science teaching, the coordination of the teaching of science and mathematics, natural history societies, and science and examinations.

The Council of the St. Louis Academy of

Science announces that it has arranged for a series of addresses on the progress made in the several departments of pure and applied science during the nineteenth century. These addresses, to which the public is welcome, are given at the Academy Rooms, 1600 Locust street, at the second stated meeting of each month, at 8 P. M. Subject to revision due to unforeseen causes, the following program is announced for these meetings:

January 21st, Rev. M. S. Brennan, 'Astronomy.'  
February 18th, Professor J. L. Van Ornum, 'Engineering.'

March 18th, Dr. E. H. Keiser, 'Chemistry.'  
April 15th, Mr. C. F. Marbut, 'Geology.'  
May 20th, Professor George Lefevre, 'Zoology.'  
October 21st, Professor F. E. Nipher, 'Physics.'  
November 18th, Mr. Herbert F. Roberts, 'Botany.'  
December 16th, Mr F. Louis Soldan, 'Education.'

THE public lectures under the auspices of the department of zoology of Columbia University are being given this year by Dr. Gary N. Calkins, the dates and titles being:

February 15—'The Simplest of Living Animals. General Sketch.'

February 19—'The Sarcode Animals; Naked bits of Protoplasm.'

February 26—'The Flagellated Organisms, the Most Important Group, theoretically, of the Protozoa.'

March 1—'The Malarial Germ and other Sporozoa.'

March 5—'Infusoria, the Highest Type of Protozoa.'

March 8—'The Loss of Vitality in Protozoa and its Renewal through Conjugation.'

March 12—'The Protozoon, a Physiological Machine.'

PROFESSOR NIPHER, of Washington University, is still making progress in his photographic work. If his pictures are unsatisfactory on first development, he destroys the picture chemically and starts again with a clean film. If the picture is started as a negative in the dark room and is unsatisfactory, he first dissolves the picture with the fog on the plate, then a fresh picture is developed on the same film. This picture may be a negative in the dark room, or it may be a positive, if the development takes place in the light. In a similar way, if the first picture is a positive, the second picture may be either a positive or a negative, according as the second development is in the light or in the dark room. There is a great advantage in start-

ing the secondary treatment with a clear film. A picture started as a negative may be reversed by turning on the light, but the high lights are already dark and the shadows must then become dark in contrast with them. The whole picture will then be very dark. By this new process the second picture may be as perfect as if the original treatment had been properly started.

THE directory of the Washington Academy of Sciences and affiliated societies for 1901, compiled by Dr. Marcus Baker, and corrected to about January 10th, has been distributed to members. The membership of the societies, excluding corresponding members in some cases, is 2,557 and the number of persons 2,013. The membership is distributed among the different societies as follows:

Academy of Sciences .....	291
Anthropological Society.....	125
Biological Society.....	171
Chemical Society.....	121
Entomological Society.....	52
National Geographic Society.....	1059
Geological Society.....	147
Columbia Historical Society.....	180
Medical Society.....	309
Philosophical Society.....	102

THE American Metrological Society has issued a circular, primarily for distribution among members of Congress, entitled 'A Few Reasons Why the Metric System of Weights and Measures should be Adopted in the United States.' It presents very clearly the great advantages of the metric system and should be widely circulated. Copies can probably be obtained from the president of the Society, President T. C. Mendenhall, Worcester, Mass., or the secretary, Professor J. H. Gore, Columbian University, Washington, D. C.

It is proposed in Dundee to erect a granite monument over the grave of James Bowman Lindsay, in the Western Cemetery of the city. *Nature* calls attention to the fact that Lindsay was a remarkable man, whose memory should not be permitted to fade. He was born in 1799, and taught electricity, magnetism and other subjects in Dundee for many years, dying there about forty years ago. In 1834 he foresaw that 'houses and towns will in a short time be lighted by electricity instead of gas, and ma-

chinery will be worked by it instead of steam.' This prediction was the result of his own observations of effects produced by the electric current, and not merely imaginative suggestions. In 1854 Lindsay transmitted telegraphic signals through water electrically; and when the British Association visited Aberdeen in 1859, he demonstrated the success of his method by transmitting signals across the harbor. He also read a paper upon it, entitled, 'Telegraphing without wires.'

It is stated in the *Lancet* that, in consequence of a movement which was started two years ago, a salmon hatchery for the river Tweed has just been erected. The hatchery, which is fitted with all the modern improvements, is situated at East Learmouth, about a mile from Cornhill-on-Tweed, on an excellent site which has been granted by Earl Grey. The management of the hatchery is under the supervision of Mr. F. J. Douglas, Springwood Park, Kelso, and Mr. George Grey of Millfield. The hatchery is a private undertaking with which the River Tweed Commissioners have no official connection, and the cost of which has been subscribed to by every river proprietor from Torwoodlee to Tillmouth. The building is 48 feet long by 20 feet wide and seven feet high inside. It is fitted with 12 boxes capable of holding in all 18 grilles, so that the 12 boxes combined have a capacity for about 300,000 salmon ova. If the fry were hatched three times in a season the output would not fall far short of 1,000,000 salmon fry. The water supply is carefully filtered before passing into the boxes. There is in the hatchery an impounding tank of 1,100 gallons capacity for keeping the salmon in after capture until they are ready for spawning. The young fry will be kept until they are six months old. For this purpose six ponds are to be constructed 40 feet long by eight feet wide by four feet deep. There are those who think that fish-culture may play an important part from a medical point of view in the future.

THE Prussian Minister of Public Instruction has issued an order regulating experiments in hospitals which is quoted by the London *Times* as follows: "I hereby call the attention of those who have the management of clinical and

polyclinical hospitals and similar institutions to the fact that medical operations for any purposes save those of the diagnosis, cure, and prevention of disease are forbidden, even when otherwise permissible from the legal and moral point of view—(1) in the case of a person who is a minor or for other reasons is not entirely responsible; (2) in cases where the person in question has not explicitly given permission for the operation; (3) in cases where this permission has not been preceded by a proper statement of the injurious consequences which might possibly result from the operation. I likewise order that operations of this nature shall be undertaken only by the director of the institution himself or by his special authorization. Whenever such an operation is performed the register of the case must contain a statement that the above conditions have been fulfilled, and must also give a detailed account of the circumstances. The existing regulations affecting medical operations for the purposes of the diagnosis, cure, or prevention of disease are not affected by these instructions.’

#### UNIVERSITY AND EDUCATIONAL NEWS.

By the will of the late Professor Edward Edridge Salisbury, Yale University will receive on the death of Mrs. Salisbury a certain part of the residue of the estate, the amount being estimated at \$150,000. One-half of the sum is to provide an additional income for the Salisbury professorship of Sanskrit and comparative philology, and the other half is to accumulate until it reaches \$100,000, when the income is to be used for such purpose as the trustees may determine.

By the will of the late J. A. Vanderpoel, Rutgers College will receive \$25,000 on the death of Mrs. Vanderpoel, the money to be used for scholarships in chemistry.

A BILL has been introduced at Albany providing for the establishment of a State electrical school at Schenectady, which would be a part of Union College. The bill appropriates \$150,000 for the establishment of the school and \$25,000 for maintenance. Union College is to offer 100 scholarships and the General Electrical Com-

pany is to give the use of its shops for observation and instruction.

A BILL has also been introduced at Albany appropriating \$100,000 for the establishment of a State Veterinary College for the eastern part of the State to be consolidated with the College of New York University.

THE Paris faculty of medicine has established a school for the study of tropical diseases, with special chairs of bacteriology and parasitology.

A MEMORIAL to the Secretary of State for India, begging for an inquiry into the recent dismissal of seven of the staff of Coopers Hill College, has been signed by Lord Kelvin, Lord Lister, Lord Rayleigh, Sir Frederick Abel, Sir Frederick Bramwell, Sir William Huggins, Sir Norman Lockyer, Sir Andrew Noble, Sir William Crookes, Sir Archibald Geikie, Sir Henry Roscoe, Professor Dewar, Professor J. J. Thomson, Professor Armstrong, Professor Marshall Ward, Professor Ewing, Mr. W. H. M. Christie, Mr. R. T. Glazebrook, Mr. W. N. Shaw, and by some seventy other Fellows of the Royal Society.

At the Rush Medical College, University of Chicago, Dr. G. S. Lingle has been appointed professor of experimental physiology, and Dr. W. D. Zoethout laboratory professor of neurology.

It is reported that Professor Frank Thilly, of the University of Missouri, has been offered the chair of ethics at Leland Stanford Junior University.

At the Massachusetts Institute of Technology the following promotions have been made: Dr. Henry Fay, assistant professor of analytical chemistry and metallography; Dr. James F. Norris, assistant professor of organic chemistry; Dr. F. H. Thorp, assistant professor of industrial chemistry, and Dr. W. R. Whitney, assistant professor of theoretical chemistry and proximate analysis. In the department of physics, Messrs. L. Derr, C. L. Norton and Dr. G. V. Wendell have been promoted to assistant professorships.

DR. F. SCHENCK, of Würzburg, is to succeed Kossel as professor of physiology at Marburg.



# SCIENCE

A WEEKLY JOURNAL DEVOTED TO THE ADVANCEMENT OF SCIENCE, PUBLISHING THE OFFICIAL NOTICES AND PROCEEDINGS OF THE AMERICAN ASSOCIATION FOR THE ADVANCEMENT OF SCIENCE.

EDITORIAL COMMITTEE: S. NEWCOMB, Mathematics; R. S. WOODWARD, Mechanics; E. C. PICKERING, Astronomy; T. C. MENDENHALL, Physics; R. H. THURSTON, Engineering; IRA REMSEN, Chemistry; JOSEPH LE CONTE, Geology; W. M. DAVIS, Physiography; HENRY F. OSBORN, Paleontology; W. K. BROOKS, C. HART MERRIAM, Zoology; S. H. SCUDDER, Entomology; C. E. BESSEY, N. L. BRITTON, Botany; C. S. MINOT, Embryology, Histology; H. P. BOWDITCH, Physiology; J. S. BILLINGS, Hygiene; WILLIAM H. WELCH, Pathology; J. MCKEEN CATTELL, Psychology; J. W. POWELL, Anthropology.

FRIDAY, MARCH 1, 1901.

THE AMERICAN SOCIETY OF BACTERIOLOGISTS.

## CONTENTS:

<i>The American Society of Bacteriologists</i> : PROFESSOR H. W. CONN.....	321
<i>Work and Expenditure of the Agricultural Experiment Stations for the year ended June 30, 1900.</i>	331
<i>The Development of the Exact Natural Sciences in the Nineteenth Century</i> : PROFESSOR HARRY C. JONES.....	338
<i>Bufo Agua on the Bermudas</i> : F. C. WAITE.....	342
<i>Scientific Books</i> :—	
<i>De Mortillet's Le préhistorique, origine et antiquité de l'homme</i> : DR. GEORGE GRANT MAC-CURDY. <i>Pozzi Escot's Analyse des Gaz</i> : PROFESSOR AUGUSTUS H. GILL.....	343
<i>Scientific Journals and Articles</i> .....	346
<i>Societies and Academies</i> :—	
<i>Section of Astronomy, Physics and Chemistry of the New York Academy of Sciences</i> : DR. WILLIAM S. DAY. <i>The Torrey Botanical Club</i> : PROFESSOR EDWARD S. BURGESS.....	346
<i>Discussion and Correspondence</i> :—	
<i>The Supposed Tertiary Sea of Southern Brazil</i> : DR. ORVILLE A. DERBY. <i>Geological Map of Europe</i> : WM. G. INGHAM.....	348
<i>Notes on Inorganic Chemistry</i> :—	
<i>Rock Formation; Arsenic in Copper; Atmospheric Hydrogen</i> : J. L. H.....	349
<i>Current Notes on Physiography</i> :—	
<i>The Cascade Mountains; The Glacier of Mt. Arapahoe; Rhine, Danube and Neckar</i> : PROFESSOR W. M. DAVIS.....	351
<i>Current Notes on Meteorology</i> :—	
<i>A Notable Study of Eclipse Meteorology</i> : PROFESSOR R. DEC. WARD.....	352
<i>The Magnetic Survey of the United States</i> : T.....	353
<i>Advance in Forestry Legislation</i> : PROFESSOR B. E. FERNOW.....	354
<i>Scientific Notes and News</i> .....	355
<i>University and Educational News</i> .....	359

The American Society of Bacteriologists held its second annual meeting at Baltimore, at the end of December under the presidency of Professor Wm. T. Sedgwick, whose address has already been published in SCIENCE. The following papers were presented:

*Distribution of Bacillus aerogenes capsulatus*: W. H. WELCH.

Dr. William H. Welch presented the results of investigations of Mr. L. K. Hirshberg in the Pathological Laboratory of the Johns Hopkins University. There can be no question but that the bacillus discovered by Welch in 1891 and fully described by Welch and Nuttall in the following year is identical with Fraenkel's *B. phlegmones emphysematose*, with Veillon and Zuber's *B. perfringens*, and with Schattenfroh and Grassberger's *Granulobacillus saccharobutyricus immobiles liquefaciens* described in 1900. It is possible that Klein had in his cultures *B. aerogenes capsulatus*, but his description of his *B. enteritidis sporogenes* can not be reconciled with the properties of the former bacillus, especially his statements as to motility and peptonization of milk. It has already been demonstrated by Welch, by Howard, and by Hirschmann and Lindenthal that *B. aerogenes capsulatus* is a widely distributed organism, its natural habitats being especially the intestinal canals of man, animals

MSS. intended for publication and books, etc., intended or review should be sent to the responsible editor, Professor J. McKeen Cattell, Garrison-on-Hudson, N. Y.

and the soil. Mr. Hirschberg has, during the past summer, made a systematic study of the distribution of this bacillus in various situations. Various methods were employed for its isolation, one of the most useful being the inoculation into the circulation of rabbits, which were then killed according to the procedure described by Welch and Nuttall. In each instance the bacillus, if found, was isolated in pure culture, and identified by its characteristic properties. *B. aerogenes capsulatus* was found by Mr. Hirschberg regularly in the feces of man (being isolated from all parts of the intestinal canal), of swine, of dogs and of cats, and was found with varying frequency, as a rule, in 50 to 80 per cent. of the animals examined, in the feces of rabbits, guinea-pigs, mice, rats, chickens, pigeons and cows. It was likewise obtained from the excrement of flies hovering around the bodies of infected animals or human cadavers. It was isolated constantly from garden earth, rarely from street dust. It was detected four times out of eighteen examinations of dust swept from the floors of hospital wards, the dispensary or the laboratory. Once it was obtained in scrapings from the human skin. It was isolated twice from cesspools. The results of Schattenfroh and Grassberger concerning the presence of this bacillus in market milk were confirmed. In the light of these and previous investigations *B. aerogenes capsulatus* must be regarded as the most widely distributed of bacteria.

*The Bacterial Condition of City Milk and the Need of Health Authorities to prevent the Sale of Milk containing Excessive Numbers of Bacteria:* H. W. PARK, New York.

The author raised the question whether it is possible for health boards to set a limit to the number of bacteria which milk may contain, and above which its sale could be prohibited. During the coldest weather the milk in New York City averages about

250,000 bacteria per cc., during cool weather about 2,000,000 and during hot weather about 5,000,000. The milk in other large cities is, from all accounts, in about the same condition. The above statement does not apply to the special milks which contain only from 5,000 to 20,000 bacteria at the different seasons of the year. In answer to the question whether these enormous numbers of bacteria found in milk during the hot weather are harmful, reference need only to be made to the universal clinical experience that a great number of children in cities sicken on the milk supplied in summer; that those who are put on milk that is sterile, or contains few bacteria, as a rule, mend rapidly, while those kept on the impure milk continue ill, or die. We probably have, as yet, insufficient knowledge to state just how many bacteria must accumulate to make them noticeably dangerous in milk, but it is a safe conclusion that no more bacteria should be allowed than it is practicable to avoid. Any intelligent farmer can use sufficient cleanliness and supply sufficient cold, with almost no increase in expense, to supply milk 24 to 36 hours old which will not contain in each cc. over 100,000 bacteria, and no milk poorer than this should be sold. The most deleterious changes which occur in milk during its transportation are now known to be due to the changes produced by bacterial growth and activity. These add to the milk acids and distinctly poisonous bacterial toxins to such an extent that much of the milk, by the time it is used in summer, has become decidedly injurious to invalids and infants. While it is the universal custom of the health authorities to guard their milk in many ways, they nevertheless entirely fail to prevent the sale of milk rendered unfit for use through excessive numbers of bacteria and their products. This seems all the more remarkable when we consider how comparatively easy the

test, and how rapidly the farmer and middle-man could greatly improve the bacterial purity of their milk if only their dense ignorance and lack of desire to improve could be removed.

*Duration of Life of Typhoid Bacilli, derived from Twenty Different Sources, in Ice; Effect of Intense Cold on Bacteria:* W. H. PARK, New York.

Cultures derived from twenty different cases of typhoid fever were grown 28 hours in nutrient agar. From each one a loopful was inoculated into 300 cc. of sterile distilled water and this was poured into thirty glass tubes. These were kept in a room averaging 23° F. (-5° C.). From time to time a tube was removed and the number of bacilli which should develop in nutrient agar tested. The following table gives the results:

Number of weeks frozen.	Per cent. of bacilli living.	Per cent. of cultures living.
0 (Original)	100	20
½ week	42	20
1 week	14	20
2 weeks	7.50	20
3 "	.4	20
5 "	.11	18
7 "	.09	18
9 "	.05	17
12 "	.005	11
15 "	.002	8
18 "	.0001	3
22 "	none	0

Watery suspensions of typhoid, colon diphtheria and hay bacilli and of the *Staphylococcus pyogenes aureus* were placed in small tubes and dropped into liquid air. From time to time the tubes were removed and the contents plated in nutrient agar. The percentage living was as follows:

Per cent. living after exposure of	Typhoid.	Colon.	Staph.	<i>B. subtilis.</i>
3 min.	18	19		
20 "	10	11	85	80
60 "	7.5	8	51	67
130 "	3	5.5	27	55

The virulence of the organisms was only slightly diminished by this intense cold for two hours.

*The Use of Paraffin to exclude Oxygen in growing Anaerobic Bacteria:* W. H. PARK.

Nutrient glucose bouillon in tubes or flasks covered with a layer of paraffin, melting at 42° C., has proved very useful in the development of tetanus cultures and toxins and of other anaerobic bacteria. With bacteria not possessing spores the medium is quickly cooled and inoculated and then covered by a layer of very hot sterile paraffin. The accumulation of gas forces the paraffin up in the tube or flask, but does not allow the entrance of oxygen. When absolute exclusion of oxygen is desired, the tubes with their layer of paraffin are sterilized in an autoclave which renders them free from oxygen. Spore-bearing bacteria are inoculated through the liquid paraffin before the bouillon is fully cooled. Bacteria without spores are inoculated by breaking through the paraffin film or by heating the paraffin in a gas flame. A pipette can then be carried through the hot paraffin into the cool liquid below. The paraffin layer has also been found useful in preserving media from drying or from changes due to the absorption of gases of the air.

*Bacteria in the Ames Sewage Disposal Plant:*

L. H. PAMMEL, Ames, Iowa.

The author describes a sewage plant designed for the disposal of the sewage of about six hundred people. The plant is of the ordinary type, consisting of two beds, each covering about 0.2 of an acre. The filtration in the beds was at the rate of about 100 gallons a day, per acre. The whole plant was installed for about \$3,000. The efficiency of the filter bed was shown by bacteriological analysis. The effluent of the filter bed for 1899 showed an average of 5,127 bacteria per cubic centimeter, and at no time did it rise over 11,075 per cc.

The number of bacteria in the water in the tank varied largely with the temperature, rising in September to 9,000,000, and falling in colder weather to a little over a hundred thousand in March. The filter bed was, therefore, extremely efficient in removing bacteria. In the study of the species of bacteria found in the effluent, some of the common sewage types were found. The author found, also, in this effluent, *Bacillus prodigiosus*. This was interesting inasmuch as it made its appearance in the sewage after it had been introduced into the laboratory in Ames. It was not believed, however, to be a native of the locality, but an introduced species.

*Variations of Bacillus rosaceus metalloides* (Dowdeswell): NELSON G. DAVIS, Lewisburg, Pa.

During the summer of 1896 a series of experiments was begun on the variations of *Bacillus rosaceus metalloides*. In making a pure culture of the organism, it was noticed that one colony was much paler in color than the others. No pigment appeared until the colony was some days old. Replating from this colony, all the daughter colonies were colorless until the fourth day, when a pale pink pigment appeared. After a time the characteristic metallic luster became visible. A continuation of the replating and selection of colonies was kept up for nine months. By that time cultures of the *Bacillus rosaceus* varying in color from colorless to a deep red, deeper than the original variety had been obtained. The darkest variety of all appeared as a 'sport'; so did also the first pale colony. The other variations appeared as gradual modifications. An attempt was made to produce a variety that would not liquefy in gelatin. This was unsuccessful, although in two instances the colonies were obtained, much slower than usual in their action. Similar selection experiments dem-

onstrated great varieties in the size of the organism. After about two hundred replatings, there appeared in one of the gelatin plates a colony in which the length of the elements was the same as the breadth. In other words, it appeared to be a coccus  $0.5 \mu$  in diameter, and was so described by students. This variety was cultivated in various media, at various temperatures, in light and darkness. It remained constant in size.

*Some Varieties of Bacillus pyocyaneus found in the Throat*: F. P. GORHAM, Providence, R. I.

*Bacillus pyocyaneus* is a comparatively frequent form in the nose and throat. Two varieties can be distinguished, one producing both pyocyanin and a fluorescent pigment, the other producing only pyocyanin. These forms are often present in almost pure culture, and may persist in the same individual for several months. The cultures are virulent for guinea-pigs and rabbits.

*Demonstration of Photogenic Bacteria*: F. P. GORHAM.

Cultures of several varieties of phosphorescent bacteria were exhibited at the evening session. They were growing on fish, fish-agar and fish-bouillon. Some of the cultures were remarkably luminous.

*Bacillus Lactis Viscosus, a Cause of Ropiness in Milk and Cream*: ARCHIBALD R. WARD, Ithaca, N. Y.

The writer has closely observed the occurrence of the milk fault, known as 'ropy milk,' in the creameries of three different milk dealers in widely separated localities in New York State. *Bacillus lactis viscosus*—Adametz, has been found to be the cause of trouble in each outbreak. The identification of the organism found in the ropy milk was confirmed by Dr. Adametz, who studied a culture sent for identification, and pronounced it identical with the one first de-

scribed by himself. Attention is called to the fact that in several text-books there occurs an erroneous statement to the effect that the organism brings about the viscid condition in milk very slowly, and that it is, therefore, of no practical importance to dairymen. The statement is founded upon a misconception placed upon a sentence written by Dr. Adamez. The organism is found in water, and multiplies at a temperature as low as 8° C. These characteristics, together with the method of keeping the milk, account for the persistence with whichropy milk appears on a milk route when the creamery is once infected. In all the cases coming under my observation, the milk dealer has cooled the milk in long, open-topped cans standing in ice water. In each case the ice water was found to contain the organisms. These might readily be introduced into the milk by the spattering of water incident to the removal of cans, addition of ice, etc. That the ice water was the immediate cause of trouble was indicated by an experiment in which potassium bichromate was added to the ice water in the proportion of one part to one thousand parts of water. The trouble did not recur in those cans of milk which were placed in the water after the addition of the disinfectant. In this case scrupulous care was observed in sterilizing vessels which had been infected.

*Concerning the Presence of Streptococci in the Healthy Udder of a Cow:* R. C. REED and A. R. WARD.

At intervals between November, 1897, and July, 1900, the presence of streptococci in the freshly drawn milk of a cow in the Cornell University herd was noted. While some cases of mammitis, associated with streptococci, were known to have occurred in the herd during this period, yet we had no record that this cow ever suffered an attack. The fact that she led the herd in

butter production during the period in which the streptococci were observed in the milk indicates that the cow was not suffering from a chronic form of the disease. This fact is significant in view of the serious effect of mammitis on the secretion of milk. The slaughter of the animal in the summer of 1900 afforded an opportunity to study the bacterial flora of the udder by means of cultures made directly from all parts of the gland. In addition to some organisms commonly found in the udder, streptococci appeared in all the thirty-six cultures. In conjunction with the streptococcus under consideration one culture from a sporadic case of mammitis and one from an epizootic of the same disease were studied. In their cultural, morphological and pathogenic properties the streptococcus from this healthy udder was indistinguishable from those isolated from the cases of mammitis. None were pathogenic to guinea-pigs or rabbits, but all three induced mammitis when injected into a healthy udder. While these observations are incomplete, they can not but suggest the idea that the streptococci associated with mammitis may, like the specific organisms of diphtheria and pneumonia in the healthy throat, be harbored in the healthy udder without producing disease.

*Immunization of Animals to Rattlesnake Venom, and some studies of Antivenine:* JOSEPH MCFARLAND, Philadelphia, Pa.

In order to determine whether the experimental immunity to serpents' venom, upon which Calmette has done such interesting work, applied equally well to venoms of the cobra and rattlesnake. The endeavor was made about two years ago to immunize several horses to the venoms of American rattlesnakes. The problems encountered were more difficult than those with which Calmette had to contend, be cause of the intense local irritative action

of the venom. Cobra venom possesses this local irritative property in very slight degree, and Calmetti found that when the cobra venom was heated to 70°C., for an hour, it was completely set aside. It was found, however, that when rattlesnake venom was heated sufficiently to annul its irritative qualities its toxic properties were almost destroyed. The horses at first received heated venom, but later were injected with solutions of the dried venom in its normally active state. The injections were given subcutaneously and were followed by enormous edemata, necroses and sloughs, so that after determining that no immunity to the local action developed, this method was abandoned and the intravenous used. The interior of the vessels showed no sign of injury, probably because the well-diluted venom at once met with greater dilution in the circulating blood. No local or other irritative disturbances followed the intravenous injection, but the nervous impression was profound; the horses often fell, and remained unconscious for some minutes after injection, and, to prevent injury to themselves, required to be suspended. Two of three horses died before antivenine developed from the damage to their tissues caused by the irritation of subcutaneous injections. The third horse lived for a long time and developed a very marked immunity associated with the appearance of antivenine in the blood. The death of the horse finally resulted from the unfortunate accidental entrance of some venom into the sheath of the jugular vein during one of the injections. Not being immuned to its irritant effects, the venom produced a local edema which killed the animal by suffocation. The antivenine produced by this horse was of such strength that 2 cubic centimeters of the serum protected a rabbit—an adult rabbit—against a fatal dose of either rattlesnake (0.002 gram) or cobra (0.001 gram) venom.

*How can Bacteria be Satisfactorily Preserved for Museum Specimens?* H. W. CONN, Middletown, Conn.

A method of preparing museum specimens was described. A 2-per-cent. agar culture medium is placed in large test tubes and tilted so as to make agar slants. The tubes are left undisturbed for from six to eight weeks, in order to allow the surplus moisture to evaporate. They are then inoculated in long streaks and immediately sealed with plaster of Paris and paraffin. The cultures grow for a few days, then cease growing, and remain unaltered indefinitely. No disinfectant is needed. The cultures remain alive for many months, and possibly for years. The method is satisfactory except for one fact—the atmosphere in the tube becomes filled with moisture and this condenses on the inside of the tube with changes of temperature. No method has yet succeeded in avoiding this condensation of water, which in most cases renders the tube cloudy, and injures its value as a display specimen.

*The Effect of Salt Solution and other Fluids on Bacteria compared with Serum Reaction:* ADOLPH GEHRMANN.

The author described, first, a series of experiments to determine the effect upon bacteria (typhoid and colon bacilli) of transferring them from one solution to another in which the percentage of salt is less. These experiments showed that, if the salt was not stronger than one per cent., the solution did not materially injure the bacteria, and did not produce the plasmolysis and plasmotypsis described by Fisher. Solutions of one per cent. have an inhibiting action and cause typhoid cultures to develop long chains and to lose their motility. A second series of experiments tested the effect of salt in the diluting fluids which were used in making the serum tests. Distilled water, normal salt

solution, and a bouillon culture fluid, made both with .5-per-cent. salt and without salt, were compared side by side, and were found to be fully equivalent. Blood diluted with any of the above readily produced the agglutination test, about the same time elapsing in all cases before the agglutination occurred. A further series of experiments tested the influence of the viscosity of fluids upon motile bacteria, as aiding in explaining agglutination. These experiments showed that the typhoid bacillus becomes readily agglutinated in fluids having considerable viscosity. For testing this phenomenon, gelatin and egg albumen were used both of which caused the bacilli to adhere in clumps, which, however, were dissipated if the solutions were diluted. While these observations were regarded as having significance in interpreting the serum test, the author was of the opinion that, when properly conducted, the agglutination obtained in the serum test can readily be distinguished from that which is the result of such physical conditions.

*Growth of Bacteria in the Presence of Chloroform and Thymol:* ERWIN F. SMITH, Washington, D. C.

As an illustration of the frequent dependence of bacteriologists and physiological chemists upon chloroform as an antiseptic, the speaker cited various passages from the recent valuable English work of Green on 'The Soluble Ferments and Fermentation.' In this book there are many statements and implications that animal and vegetable infusions can be preserved from bacteria growths during their examination by the addition of chloroform. Twelve micro-organisms are known which grow readily in test-tube cultures of milk, beef bouillon, etc., to which an equal volume of chloroform has been added. This probably by no means exhausts the list.

Test-tube cultures of eight of these organisms growing readily in presence of chloroform were exhibited. Two organisms are also known which grow readily in beef bouillon to which thymol has been added. It would appear, therefore, that there is no general rule, but that each bacterial organism must be tested by itself as to the effect upon it of chloroform, thymol, etc. If chloroform is used to preserve fluids or macerations of animal and vegetable substances from the growth of micro-organisms, it would be well to seal the flasks and keep them constantly agitated. Moreover, if one would be certain of their continued sterility, the freedom from bacteria growth of the substances under examination must be determined from time to time by microscopic examination and by cultures made from the fluids or macerations, otherwise, especially where bacterial organisms are able to produce the same substances as those sought for in plant or animal tissue, *e. g.*, cytase, diastase, etc., there can be no certainty as to the exact origin of the substance in question.

*Infection by means of Modeling Clay:* M. O. LEIGHTON, Montclair, N. J.

The author's attention is drawn to the possibility of the distribution of infectious disease among school children by the common use of model-clay. In the ordinary schools such clay, after having been used by one student, is returned to the stock box and subsequently used again. Study of clay thus obtained from schools showed bacteria to be tolerably abundant in the clay. The species of bacteria identified were those which ordinarily occur in pus formations, thus showing that clay may be capable of distributing these organisms. An attempt to sterilize clay showed that the only efficient means of accomplishing this purpose is by the use of superheated steam under the pressure of 15-20 pounds for 45 minutes. Next, an attempt was made to

determine how long certain pathogenic bacteria could remain alive in the clay. Sterilized clay was inoculated under proper precautions, with the bacilli of typhoid, diphtheria and tuberculosis. The clay was then kept moist and warm, and studied periodically for the presence of these organisms. The results were, briefly, as follows: *B. Typhi abdominalis* grew vigorously after having been enclosed in the clay for 32 days. After that no colonies were found. *B. diphtheria* grew after having been enclosed in the clay for 18 days. *B. tuberculosis* was alive after 18 days. How much longer the latter two bacilli would remain alive in the clay the author did not determine. The experiments, however, sufficiently demonstrate that the indiscriminate use of modeling clay in the schools is unwise, and liable to distribute communicable diseases, if such are present among the pupils.

*A Preliminary Report upon a Hitherto Undescribed Pathogenic Anaërobie Bacillus:*  
NORMAN HARRIS, Baltimore, Md.

This organism was isolated, post-mortem, from one of several abscesses in the liver of a man who had entered the service of Professor Halsted in the Johns Hopkins Hospital of Baltimore. He complained of great pain in the hepatic region of the abdomen, accompanied by nausea, vomiting and jaundice. Blood examination showed a marked leucocytosis. Exploratory laparotomy was performed and the condition was found to be one of multiple abscess of the liver, and beyond radical treatment. The patient died the fourth day after operation. The autopsy disclosed the presence of numerous abscesses throughout the liver, as well as in the right lung and spleen. Petri dish cultures were made in plain and in hydrocele fluid agar and grown both aëroically and in an atmosphere of hydrogen for a period of seventy-two hours. All dishes showed no growth,

except the undiluted hydrocele fluid culture which had been in the hydrogen atmosphere. This developed four colonies surrounded by a halo of growth, and these appeared to arise from small particles of liver detritus. Subcultures were successfully grown only when the media were made up with hydrocele fluid or human blood, and when oxygen was excluded. Characteristics: the organism is a bacillus which in general is not minute, although its size varies somewhat on the various media. It may occur as cocci diplococci, very short rods, longer rods, filaments, or more rarely as chains of cocci or very short rods. Occasionally some rods are seen to have swollen ends, or may show distinct polar granules, or may be slightly curved. It is non-motile; it is decolorized by Gram's method of staining; it does not liquefy gelatin; it does not appear to have spores; its thermal death point is an exposure of ten minutes at 50° C. In all media it gives off a very strong fecal odor, and forms gas from the ordinary and sugar-free beef broth, when made up with either hydrocele fluid or blood. It likewise actively ferments glucose, forming CO<sub>2</sub>, H<sub>2</sub>, and H<sub>2</sub>S, the gas igniting readily. Experimentally, lesions similar to those found in the human subject were produced in rabbits and guinea-pigs, and mice succumbed to subcutaneous inoculation with a local necrotic lesion only. The name proposed for the organism is *Bacillus mortiferus* or *Bacterium mortifer*. The organism differs essentially from any of anaërobie bacilli hitherto described.

*Concerning the Theories of Silage Formation:*

H. L. RUSSELL and S. M. BABCOCK, Madison, Wis.

The authors instituted along series of experiments to determine whether the changes that take place in the silo are due to microorganisms, as has been believed, or to other



kind of action. Their conclusions are: (1) Silage can be made under conditions that exclude bacterial activity. (2) The initial heating of the silage is due, mainly, to the respiratory processes of the cut plant tissues. (3) The peculiar characteristic of good silage is due, not to bacteria, but to changes inaugurated under the more or less direct control of the activity of the protoplasm of the plant tissues. The acids of silage seem to be for the most part a product of the intra-molecular respiration, and in quantity are roughly proportional to the length of time that ensues before the cells stop respiring. This fact explains the reason that silage from immature corn has a higher acidity, and is more likely to undergo putrefactive changes due to bacteria growing in the succulent tissues than silage made from mature corn. (4) The aroma of good silage can be produced under conditions in which all vital processes are suspended. This seems to point strongly to the idea that enzymes are operative in the production of this aroma. It has previously been shown that such ferment bodies are liberated from dying vegetable cells and that they continue to act after the cells lose their vitality.

*Demonstration of some New Laboratory Devices:*

F. P. GORMAN, Providence, R. I.

The following laboratory devices were demonstrated: (1) The application of the incandescent electric lamp to heating incubators, water and paraffin baths. (2) Culture tubes with etched surface for writing data. (3) Large slides for the examination of series of cultures. (4) Cotton 'silver' for plugging tubes, etc.

*A Low Temperature Incubator:* E. H. WILSON, Brooklyn, N. Y. (Read by title.)

*Preservation of Sputum for Microscopic Examination; A New Fermentation Tube:* A. ROBIN, Newark, Del.

The author has experimented with some of the active germicides with a view to pre-

serving tuberculosis sputum. Carbolic acid, 5-per-cent. solution; trikresol, 2-per-cent.; formaldehyde, 5 per-cent., and hydrochloric acid, 10-per-cent., were added to sputum containing large numbers of tubercle bacilli. The coagulation resulting from the addition of carbolic acid or trikresol to sputum containing pus was largely overcome by vigorous shaking, the coagulation being thus finely broken up. The sputum was examined at the end of 24 to 48 hours. Weekly and then monthly examinations were made for a period of four months. Except when hydrochloric acid was used, the bacilli were found well preserved and, if anything, stained much more deeply. HCl, on the other hand, seemed to have either so disorganized the bacilli or so changed their staining properties that they could not be

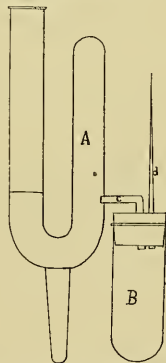

FIG. 1. A New Fermentation Tube.

found at the end of 24 hours. As a result of these experiments the author recommends the addition of an equal volume of a 5-per-cent. solution of carbolic acid to the sputum, which should be vigorously shaken up in the bottle so as to break up the lumpy coagulation. The apparatus is illustrated by the accompanying drawing. The side-tube *c* is packed with non-absorbent cotton; the arm *A* of the U-tube is filled with mer-

cury, the tube *B* is filled with the culture, when the rubber stopper holding the side-tube *d* and straight tube *d* is tightly inserted. When this is done the end of *d*, which serves for the escape of air displaced by the stopper, is sealed in the flame. The gas generated in *B* escapes into the closed arm *A*, displacing the mercury. To determine the  $\text{CO}_2$  ratio, the tube *B* is filled to the rubber stopper. Two fermentation tubes are used. In one, the arm *A* is filled with mercury, and the other half of the arm is filled with a saturated solution of sodium or potassium hydrate, this being readily accomplished by inclining the *U* tube towards the operator. The  $\text{CO}_2$ , passing through the caustic solution, is absorbed, and the unabsorbed gas (*H*) is left. The ratio between the two is then determined. This apparatus is manufactured by Eimer and Amend, New York.

*A New Method of applying the Rabies Test :*  
CHAS. F. DAWSON, Detroit, Mich.

The author, in his work upon rabies, was dissatisfied with the current method of inoculating animals in the cerebrum, which involved trephining the animals, with occasional death from hemorrhage, possibility of self-inoculation and other difficulties. He has, therefore, devised a method of inoculation in which these difficulties are reduced or eliminated. The method is as follows: A bit of the brain of the suspected animal is ground in a mortar containing sterilized 6-per-cent. sodium solution, and is then filtered through sterilized cotton. Two minims of this solution are then injected on the base of the anterior cerebrum by way of the optic foramen. To accomplish this, full grown rabbits are used which are thoroughly anesthetized with ether. A hypodermic syringe is used with a needle seven-eighths of an inch long. The inoculation is made by lifting the nictitating membrane out of the way by means of the syringe

needle, and then forcing the needle upwards and backwards through the orbital tissues until it enters the optical foramen. The contents of the syringe barrel are then injected and the needle carefully withdrawn. By this means the solution is injected underneath the cerebrum and the chances of injury to the animal are much lessened. In a series of comparative tests made with this and the ordinary method, the author reaches the conclusion that the new method is fully as satisfactory as the old, and much easier to apply.

*The Use of Carbolic Acid in isolating the Bacillus Coli Communis from River Water :*  
WILLIAM B. COPELAND, Pittsburg, Pa.

The author described a method which he had devised for the purpose of separating the coli bacillus in river water, by the use of solid media. For this purpose he used Wurtz's agar, inasmuch as it could be incubated at  $37^\circ$  and the acid colonies were readily distinguishable by the reddening of the litmus. Inasmuch, however, as many other bacteria are present in river water, especially after a rain, which can develop at  $37^\circ$ , it is quite desirable to devise some means by which they may be reduced without affecting the colon bacillus. The author accomplishes this by adding to the agar two-tenths cc. of a 2-per-cent. solution of carbolic acid. Experiments showed that such addition of carbolic acid reduced the total number of bacteria about 45 per cent., while it had no effect, apparently, upon the colon bacillus. This makes it possible to determine the number of colon bacillus in water much more readily than if all bacteria are allowed to grow. By the use of this method, a study of the relation of the muddiness of river water and the number of colon bacilli was made. The result showed that, leaving out certain irregularities due to abnormal conditions, the number of colon bacilli increased with the turbidity of the water, a

relationship pointing to an increase in sewage pollution at times when the water of the river becomes turbid. The author recommends the use of carbolic acid as described in the employment of solid culture media for the determination of the number of colon bacilli present in surface waters without dilution.

*A Few Experimental Data on Hypodermic Injections:* S. J. MELTZER, New York City.

From two series of experiments, Meltzer arrived at the conclusions: (1) That the effect of subcutaneous injection depends to a very large degree upon the concentration of the injected fluid, and very little, if any, upon its bulk; (2) that the effect is distinctly increased by a distribution of the injected quantity over several areas. The author employed crystalloid solutions, and restricts his conclusions to this kind of liquids.

*The Utility of a Supply of Live Steam in the Laboratory:* H. A. HARDING, Geneva, N. Y.

The expense connected with cooking and sterilizing in the bacteriological laboratory is usually great, because of the high cost and low efficiency of gas. As a saving of time and money, the advantage of using steam, generated directly by coal, is obvious. In fitting up the bacteriological laboratory at the New York Agricultural Experiment Station, the following devices have been tried and found satisfactory: In the case of the Arnold sterilizer, a steam pipe was introduced through the wall of the passage in which the steam normally rises into the sterilizing chamber, and an elbow screwed to the end of this pipe and turned downward. With this connection, the Arnold can be brought to a temperature of 99° C. within five minutes, without any unpleasant noise or undue waste of steam. An autoclave was constructed, differing from

the ordinary type in that steam was introduced from a high pressure boiler. By means of a reducing valve the steam pressure and, consequently, the temperature within the autoclave, can be held within very narrow limits. A ten-minute exposure at 120° C. suffices to render tubes of gelatin and other media sterile. Steam cups were installed, having the shape of an ordinary water-bath, except that their depth was considerably increased. A steam inlet was placed at the bottom, and a waste pipe provided for carrying off the condensation. In these cups water is heated and agar is melted much more quickly than it could be done over an ordinary Bunsen burner, and in cooking media there is no possibility of boiling over or burning. The above pieces of apparatus, together with the hot air sterilizer, are placed upon an eight-foot bench, and nearly all the heat radiated is carried off by a galvanized iron hood. These devices have been in use for nearly two years and are giving good satisfaction.

H. W. CONN,

Secretary.

*WORK AND EXPENDITURES OF THE AGRICULTURAL EXPERIMENT STATIONS FOR THE YEAR ENDED JUNE 30, 1900.*

THE Secretary of Agriculture has recently transmitted to Congress the annual report on the work and expenditures of the Agricultural Experiment Stations, made by A. C. True, Director of the Office of Experiment Stations. The following paragraphs are taken from the introduction to this report:

THE WORK OF THE STATIONS AS RELATED TO PRACTICAL AGRICULTURE.

In making our examination of the work of the experiment stations during the past year we have particularly inquired whether their operations are conducted with special reference to the agricultural needs of their

respective States and Territories. The results of this inquiry are embodied in the accounts of the individual stations given in this report. From these it will be seen that by far the largest part of the work of our stations has direct relation to the important agricultural interests of the communities in which they are located. The stations are, in fact, very responsive to the immediate demands of their farmer constituencies. Their greatest danger is not that they will undertake too much work of remote practical bearing, but that in the effort to meet the calls made upon them for immediate assistance they will attempt individually to cover more fields of investigation than the funds at their disposal will permit them to treat thoroughly. This temptation the stations generally are, however, resisting more successfully as their work is becoming better organized and their investigations are more carefully planned and supervised. The nature of their operations is also becoming better understood by the farmers, and the desirability of more thorough and far-reaching investigations is much better appreciated than formerly. A broader and deeper foundation of scientific inquiry is being laid each year, and there is a constant accumulation of data regarding the general agricultural conditions of the different regions of the United States. The climate, soil, water supply, native and cultivated plants, injurious insects, fungi and bacteria are being studied in more detail and with greater thoroughness than ever before. The principles of nutrition of animals and the causes of their diseases are being subjected to more elaborate and fundamental scrutiny. Methods of investigation and the improvement of apparatus for research are being given increased attention. Much of this work is done without public observation and in the intervals of other operations. Without doubt it should receive more definite recognition and encour-

agement. But it is cause for congratulation that so much patient labor of this character is being performed by station officers, who, as a rule, are seeking to advance the boundaries of knowledge for useful ends and are not deterred by a multiplicity of duties from giving attention to the more fundamental concerns of agricultural science. And this work is having its effect on the more practical operations of our stations. These are assuming a more substantial and systematic character and are being conducted with more definite relation to actual conditions. They have, therefore, a greater assurance of successful practical outcome. Questions relating to the introduction of plants or to the improvement of the live-stock industry in any region, for example, are now being investigated with a strict relation to the real requirements of the agriculture of that region which would have been impossible a few years ago. The present activity in plant breeding, as distinguished from the indiscriminate testing of varieties, is a good example of the raising of the level of experiment-station work as applied to directly practical ends. The plant breeder now sets definitely before him the kind of variety needed by the farmer in a given region or for a given purpose and applies all his scientific knowledge and practical skill to the production of such a variety. The notable success of some of the efforts in this direction already made are but a foretaste of much wider practical results as knowledge and experience in this line of endeavor increase. To do such work effectively there must be an almost ideal combination of science and practise. And the more we can learn definitely regarding the underlying principles, the more surely shall we be able to make successful practical applications. In such investigations science becomes more practical and art more scientific.

## PROBLEMS OF STATION ORGANIZATION.

Much attention has been given during the past year to questions relating to the more perfect organization of the stations. As the stations develop, the importance of a clearer definition of the functions of different officers in administration and investigation becomes more apparent. Conditions which existed when institutions for higher education and research were established in this country have materially changed, and the old forms of organization are now, in many cases, a serious hindrance to their best development. For example, the theory on which the laws relating to the governing boards of many of the State colleges and experiment stations are based is that the board is to have the direct control and management of the institution. For this purpose it is to meet frequently, keep the details of the business of the institution well in hand, consult freely with officers of various grades and pass rules and regulations governing every operation. This may, perhaps, have been well enough when the institutions were in a formative period and trained executive officers were scarce, but to-day this theory is out of date and its application to the intricate and specialized business of our colleges and stations is highly injurious to their best interests. It works just as badly when applied to a college or experiment station as it would in the case of a railroad or a bank. The fact is that boards of control are most useful when their functions are confined to a broad, general supervision of the policy, finances and work of the institution and the choice of its chief officers. For this purpose annual or semi-annual meetings would ordinarily be sufficient, since the number of matters requiring the attention of the board should be reduced to a minimum. The best reason for the continuance of such boards is that when composed of broad-minded and successful citizens they

represent the best sentiment of the community regarding these institutions, and are able to give the public an adequate guaranty for the wise and liberal management of the great interests involved in the State colleges and universities. Otherwise it would probably be best to do away with the boards and make the heads of the colleges directly responsible to some State officer of high rank. One especially annoying and unjustifiable feature of the present system is the maintenance at many of the colleges of an officer, commonly designated secretary of the board, who acts as a representative of the board in the intervals between their meetings and exercises important functions relating to the business of the institution independently of its president. There is thus divided responsibility in the daily administration, and in case of friction between the president and faculty or students often a convenient center for discontent and disloyalty is ready at hand. All the legitimate functions of a secretary of the board might easily be performed by a registrar or other officer attached to the president's office, and thus an important 'rock of offense' might be removed from the administrative systems of these institutions.

The successful college president is no longer preeminently a great scholar, but rather a broad-minded and well-trained man of affairs, understanding the requirements of modern educational and scientific institutions and able to administer the affairs and manage the personnel of such institutions. He will look to his governing board for advice and counsel on the larger matters of general policy, but he ought not to have their intervention in the details of the business. To his hands should be fully committed the administration of the whole institution, and his work should be judged with reference to its successful issue. There should be no doubt in the mind of any offi-

cer connected with the institution that he is responsible to the president for his official conduct, and that an appeal to the board can be made only in extreme cases.

The institution will naturally be divided into a limited number of departments, at the head of each of which will be placed an officer competent to plan and manage the business of the department intrusted to his charge. The amount and character of the administrative duties which these officers will be called upon to discharge will vary with the nature of the department. The agricultural experiment station is by law to be organized as a department of the college with which it is connected. It differs from the ordinary college department in being charged with the work of investigation rather than instruction and in having definite relations with a great industry for whose promotion it is especially established. Through its correspondence, publications, inspection service and association with the farming community it has an increasing amount of business not immediately relating to its investigations, but requiring special knowledge and skill for its successful discharge. To do most effective work the operations of the station must proceed in accordance with a well-matured plan which involves the cooperation of different members of the staff. So extensive and important has the business of the stations become that their proper management requires the time and energy of an executive officer, or director. In some cases it may still be possible for the director to conduct investigations in some special line or do a limited amount of teaching, but as a rule he can do little beyond attending to administrative duties. In a number of institutions prudential reasons of various kinds have led to the combination of the offices of president and director. Whatever justification there may have been for this in the past there is little excuse for it in the present. The du-

ties of a college president are too multifold and onerous to permit his giving much attention to the special needs of an experiment station. His directorship almost necessarily becomes a nominal affair and the general business of the station is actually performed by some one member of the staff or distributed in a desultory way among a number of subordinate officers. This arrangement has not worked well and should be universally abandoned.

As regards the business of the station, the director should be clothed with a large measure of authority and consequent responsibility, should plan and supervise its work and expenditures, and control its staff to such an extent as will bring them together to work as a unit for the promotion of the station's success. The members of the staff should be directly responsible to the director on all matters relating to the station, whatever their position may be in other departments of the college, and should expect to transact station business through the director rather than through the college president or the governing board. A proper independence in the conduct of investigations, or parts of investigation, in their respective specialties, and just credit for their share in the station's operations as set forth in publications or otherwise may, it is believed, be amply secured for the expert officers of the stations at the same time that good discipline is maintained and ample provision made for united effort.

No class of men need to readjust their professional code to the modern requirements of the organization of great scientific and educational enterprises more than college professors and scientific specialists. A way must be found by which teaching and research can be conducted on a system which combines liberty with law. The old régime of the entirely independent teacher and investigator has passed away. The specialization which is simply a form of the

division of labor well known in industrial pursuits carries with it a necessity for combination of workers in educational and scientific institutions, as well as in manufacturing establishments. In a way hitherto unknown, scientific men will be called in the future to work together for common ends. No matter is of more vital importance in the organization of our colleges and experiment stations than the securing of harmonious and concerted action on the part of faculties and staffs for the common good of the institution to which they are attached. One of the greatest difficulties now attending the successful management of these institutions is the fact that while specialization has narrowed the field and outlook of the individual officer, there has not been a corresponding recognition of the necessity of readjusting the form of organization and the spirit of the worker to meet these new conditions. At no time has there been greater need of the cultivation of an earnest and enthusiastic *esprit du corps* among the rank and file of educational and scientific workers. There are many individual examples of men impressed with this lofty sentiment, but the whole body is not yet animated with it. Obviously it should especially be a virtue characteristic of men connected with public institutions. The officers of our agricultural colleges and experiment stations are public functionaries employed to advance very important public interests. With them the good of the community, as involved in the success of the enterprise with which they are connected, should be the ruling motive of action. The fame and emoluments of the individual worker should be subordinated to the requirements of concerted action for a common end. And yet in the long run it is believed the individual worker as well as the institution will profit by a loyal and self-sacrificing discharge of common duties, for union of effort will bring greater success;

and whenever a college or a station is strong and flourishing, credit is reflected on every worker who has contributed to this issue.

The general considerations affecting the efficient organization of our experiment stations have thus been dwelt upon because a survey of these institutions during the past year has brought additional evidence that the problems of organization are being more generally considered than ever before. The tide is running strongly toward a more compact organization and a greater unification of the work. On the whole, those stations which have a strong organization and administration are meeting with the largest measure of success.

#### THE ORIGINAL WORK OF THE STATIONS.

There is also unusual interest in the discussion of problems relating to the functions of the stations and the specific duties of station officers. There is quite general agreement that each station should conduct a considerable amount of original investigation; but in what way this should be provided for and what should be its character are variously regarded. There is still great variety in the assignment of teaching and investigation to officers in different stations, and the relative amount of work of research which is left to assistants differs very greatly in different places. Considerations relating to the financial conditions of college and station still affect the assignment of work in a number of institutions. Our observation of the situation leads us to the belief that there is actually going on a widespread differentiation of the investigator from the teacher, and that this is not prevented, though it may be hindered, by the varying arrangements made at the colleges and stations. A certain number of men are more and more devoting themselves to the work of investigation, and succeeding in it. Others are just as certainly losing their interest and activity in

such work. Because a man is required to teach many hours he does not thereby become a successful teacher. The research which he is compelled to carry on during vacations and at night may nevertheless be his real mission, and it will be well if his superiors discover this. The leaving of details of research work to assistants often means that the principal has largely lost his interest in it or considers other duties more important. We are getting an increasing body of competent investigators by this process, though in too many cases their training is proceeding under untoward conditions. It will be well if boards and presidents will consider more fully the actual state of things and make as far as possible such a readjustment that the investigator will be left very largely to investigate and the teacher to teach. It continues to be a weakness of a considerable number of our stations that they are organized on too broad a scale for their resources. Too great a portion of their funds is going into salaries, leaving too little to pay the miscellaneous expenses of important investigations. Here and there only have the authorities had the wisdom and courage to confine the operations of the station within comparatively narrow lines, leaving important departments of work entirely without recognition. It is encouraging, however, to observe that where this has been done success has brought additional funds with which the scope of the station's work could be safely extended.

On the whole, the amount of what may fairly be called original investigation is, in our opinion, steadily increasing. To determine this it is not sufficient to consider simply the bulletins of the stations. These have in various ways been made more popular in form and matter. A larger amount of the more original work is being recorded in the annual reports and the records of more investigations are being withheld from pub-

lication until results of value are obtained. While there is still need of urging the advancement of the general standard of investigations, there is every reason to believe that our stations are moving onward and upward as agencies for the original investigation of agricultural problems.

#### THE INSPECTION SERVICE OF THE STATIONS.

The amount and variety of inspection service required of our experiment stations continue to grow from year to year. Beginning with commercial fertilizers, it now includes feeding stuffs, dairy products and other foods for man, creamery glassware, insecticides, nursery stock for injurious insects, and plant and animal diseases. For a considerable period this matter affected only the stations in the East, where commercial fertilizers were largely used, but it is now a live question in all sections of the country, since there is no region which does not have some evil against which the agricultural public is demanding protection by inspection under State or national auspices. Questions relating to the attitude of the stations toward this work are therefore engaging the attention of station officers throughout the country. Wherever this work has assumed considerable magnitude it is evident that it requires very careful organization in order that it may be conducted so as not to interfere with the work of investigation. Where the same officers are charged with both kinds of work there is constant danger that the severe routine duties of the inspection service will diminish the ability of these officers to conduct thorough original investigation. It is essential that there should be a distinct differentiation of this service from the other work of the stations as regards both funds and time of performance. Unless this is done and close supervision is exercised, the inspection work is inevitably a drain upon the resources of the station



and a hindrance to its more important operations. While our stations have from the beginning been engaged in inspection work, and this has met with increasing popular favor because of its efficient performance, it is still doubtful whether it is the best ultimate arrangement. Almost all our experiment stations are organic parts of educational institutions. As such they are essentially university departments devoted to research and to the dissemination of new knowledge. To a certain extent they may naturally and properly engage in the various forms of university extension work through their more popular publications and connection with farmers' institutes, etc. They are organized to conduct investigations on a great variety of subjects, and the scope of their work of investigation can be almost indefinitely extended as their funds increase. They do not need, therefore, to go outside of that work which would be universally considered within their rightful domain as departments of colleges and universities in order to secure a wide field of operation. On the other hand, as the range of inspection service enlarges and its duties become more onerous and complicated it becomes very questionable whether this service should be connected with our educational institutions. It is essentially a part of the police functions of the State and National Governments. It involves many questions on which sooner or later the courts will have to pass. It may even excite public attention to such an extent as to be reckoned worthy of consideration by the people in their choice of administrative and legislative officers. In many ways this kind of business is much more appropriate to bureaus of the State government than to educational institutions.

Thus far the arrangement by which much of it has been connected with the experiment stations has been largely a matter of convenience, and in many States the amount

of work to be performed has been so inconsiderable that it has not seemed worth while to create special agencies for its performance. We have now reached a stage in the development of this work when it is believed that this matter should receive careful attention from the managers of our agricultural colleges and experiment stations, in order that a sound policy may be established which will provide for the best future development of these institutions. In our judgment, this would involve efforts to relieve the colleges and stations of the inspection service rather than to increase its scope at these institutions and make it a permanent portion of their work.

#### STATE AID TO THE EXPERIMENT STATIONS.

A number of the States continue to liberally supplement the national funds, and thus to extend and strengthen the investigation of the stations within their borders. This is done by specific appropriations for substations or special investigations, or by general appropriations for the current expenses of the colleges with which the stations are connected. Often the printing of station publications is provided for by the State. During the past year notable additions have been made to the buildings and equipment of the agricultural colleges, and the experiment stations have received much benefit from these increased facilities. At the University of Illinois a building costing \$150,000 has been erected for the use of the agricultural college and experiment station. This will be thoroughly equipped with apparatus and other facilities for instruction, and when completed will form the largest single plant for agricultural instruction and research in this country. At the University of Nebraska a building costing \$35,000 has been erected for the special use of the experiment station. At the Washington Agricultural College a science hall costing \$60,000 has been erected, which provides

greatly improved facilities for the work of the college and station. At the Texas Agricultural College there is a new agricultural and horticultural building costing over \$30,000, and at the Kansas Agricultural College an agricultural building of the same value. At the Oklahoma Agricultural College there are new chemistry and library and science buildings, and at the Virginia Agricultural College and the University of Tennessee new and commodious barns have been erected, each costing about \$5,000. At the latter institution a dairy building has also been constructed. At the Agricultural College of the University of Minnesota a horticultural-botanical building costing \$35,000 has been erected.

It is believed that the successful work of the experiment stations has been a large factor in arousing the attention of the public to the benefits of instruction as well as research in agriculture, and to the importance of equipping the agricultural colleges more amply and giving them increased funds for the extension of their work in both directions. It is well that this fact should be brought to the attention of legislators when appropriations for these institutions are being made. Funds are needed for the extension of investigations as well as for better equipment, and oftentimes a comparatively small sum added to the current revenue of the station will enable it materially to strengthen its work. This is so because the broad organization of our stations requires that a relatively large portion of the national funds must be expended for salaries and wages. This leaves so little for the general expenses of investigations that they can not as a rule be made very extensive. If it is desirable that particular investigations should be conducted on a somewhat extensive scale or in different localities, the State can often secure this desirable result by providing funds for these specific purposes. As regards the investigations which

need to be carried on in different localities, it is, in our judgment, a much wiser policy to give the stations funds for such special investigations than to establish permanent substations, which have universally proved to be relatively expensive and unsatisfactory.

THE DEVELOPMENT OF THE EXACT NATURAL SCIENCES IN THE NINETEENTH CENTURY.\*

THE lecture delivered by Van't Hoff, under the above title, although scarcely an hour in length, contains so much important material that a brief account of its contents cannot fail to be of interest to the readers of SCIENCE. The lecture deals only with the sciences of inanimate nature, and, therefore, does not touch any branch of the biological sciences.

Although the question of utility has had much to do with the development of many branches of science, yet the highest aim has not been reached in this way. The sciences have, then, been divided into *theoretical* and *applied*. And we must make the further division into the *general* and the *concrete* or *special* sciences.

The general sciences are dealt with first. These are divided into two classes. First, the *three fundamental mathematical sciences*, which center around the three fundamental conceptions of quantity, space and time. The science of quantity is analysis, including arithmetic, algebra and the higher analysis. The science of dimensions is geometry; while in mechanics, the science of force and movement, time enters as a factor. Second, the two *experimental natural sciences*—physics and chemistry.

Almost an unlimited amount has been accomplished in the nineteenth century in the field of the mathematical sciences. It is only necessary to mention such names

\* Lecture delivered by Van't Hoff at the seventy-second meeting of the Society of German Men of Science and Physicians, in Aix-la-Chapelle.

as Abel, Cauchy, Gauss, Jacobi, Riemann, Weierstrass. The general laws of these sciences were established at the beginning of the century, and remain essentially unaltered. The great discovery for mechanics in the nineteenth century is the law of the conservation of work. Since this law lies at the very foundation of mechanics, it is of fundamental importance for the whole science. The discovery and development of this law belongs to the field of physics, yet it was not developed by physicists alone. Mayer was a physician, Joule a brewer, Colding an engineer, and Helmholtz was at that time a physiologist.

The influence of this law on mechanics was pointed out by Lagrange in two equations—the one for motion, the other for rest or equilibrium. In the light of the law that the amount of work cannot change, these two equations became relatively very simple. This law is as follows: *The total amount of work is unalterable.* It should be observed that work can have two forms, the form of movement (or kinetic energy), and the form where a weight moves a clock—where the capability of doing work is connected with the weight, therefore, with a force, (potential energy). The law should be expressed thus: *The sum of the two kinds of work is unalterable.*

We can then say, in general, of our three fundamental sciences, that at the close of the nineteenth century they rest on a foundation that is practically perfect.

If we now turn to the experimental sciences, physics and chemistry, we find that there is no sharp division between them. Recently a celebrated chemist said that Lavoisier and Bunsen, were not chemists, but physicists, and to show what inherent connection exists between the two, Bunsen himself said '*a chemist who is not a physician is nothing.*'

The physicist has to do chiefly with the

transformations of *force*; the chemist with the transformations of *matter*.

Turning now to physics, therefore, to the problem of the transformations of natural forces or corresponding work forms, the developments in the nineteenth century are closely connected with the fundamental conceptions that natural processes are to be referred to purely mechanical movements and forces. Since light, sound, heat, electricity and magnetism are only different forms of movement, the possibility exists of transforming these into one another. This is the first great advance in physics. It was Faraday especially who believed in the correlation of energy. This reciprocal transformation of work forms, of course, takes place in daily life in the steam engine, dynamo, etc., and from this energy heat and light can be reproduced.

The second great advance is, of course, the law of the conservation of energy, or of work, in terms of which the total amount of work remains unchanged.

A third important step was taken. If one form of work can be transformed into another and this transformation takes place quantitatively, then the question still remaining is, Which way will the transformations take place? This was answered by Carnot and Clausius in what has become the second law of thermodynamics. This is often formulated thus: Heat always flows from a warmer to a colder body. Helmholtz formulates it in terms of 'free work.'

We now consider the *last fundamental step* which has been taken—how *quickly* do transformations take place in nature? This brings us to the views in reference to the inner nature of natural processes—views which have been developed in the nineteenth century. As an example, let a local increase in pressure be produced in the air by, say, an explosion. This increase in pressure tends to equalize itself, and the excess of pressure moves through the air as

sound. From the assumption that sound is a wave movement in an elastic medium like air, Newton and Laplace calculated its velocity accurately as 330 meters per second.

That sound is a vibratory movement is not theory but fact. In other regions, however, we have only theories as to the nature of the phenomena. We have had to distinguish between matter and ether; the former consisting of very small, perfectly elastic parts, which are different for each element; the latter, a medium everywhere present, penetrating everything. The ether is the carrier of all radiation, as for example, light.

Let us trace the development of the views concerning light. According to Newton light was produced by light particles which moved with great velocity. The discovery of interference by Fresnel at the beginning of this century showed that light was a wave motion, as Huyghen's had supposed. The vibrations took place in the ether, and light moved with a velocity about one million times that of sound. In order to explain the phenomenon of polarization it was necessary to assume that the vibrations are transverse and not longitudinal.

The view that the ether is a simple elastic medium could not account for the relations between light, electricity and magnetism. Those substances which are the best conductors of electricity, as the metals, are opaque to light; while glass, which is transparent to light, does not conduct electricity. Relations such as these led Maxwell, Helmholtz and others to the assumption that the vibrations in the ether are of an electrical nature. This was the origin of the electromagnetic theory of light. In terms of this theory, light is only an electromagnetic vibration of the ether of very small period. The number of vibrations per second is about 400 billions for red and

800 billions for violet light. But there is still an infinite field for slower and also for more rapid vibrations, and here we meet with the greatest discoveries of the nineteenth century. The somewhat slower vibrations are heat rays; the somewhat more rapid are chemical rays; the still more rapid are the Röntgen rays, corresponding to the Helmholtz very rapid electromagnetic vibrations; while the very slow vibrations (about 100 million per second) are the Hertz waves. These electrical vibrations behave just like light, only they are invisible. They find application in wireless telegraphy.

The assumption is, therefore, plausible that light also is produced by electrical vibrations of the charged atoms or ions in the source of light. This is confirmed by the discovery of the Zeeman effect.

Let us now turn to chemistry. Substances like potassium and sodium, which at the beginning of the century were regarded as elementary, have been decomposed by Davy. The remaining elements have, however, maintained their elementary nature, and about 80 are now known. That an organic connection exists between the elements has been shown by Newlands, Lothar Meyer and Mendeleff. In terms of this relation new elements have been predicted and they have since been discovered by Loçoq de Boisbaudran, Winkler and Nilson. These elements are, of course, gallium, germanium and scandium.

The *synthesis* of compounds has been carried very far indeed. The synthesis of urea by Wöhler broke down the distinction between the compounds prepared in nature and in the laboratory. And we can now prepare optically active substances in abundance. Synthesis has reached its climax in the preparation of the artificial dyes. Graebe and Liebermann have made alizarin. Baeyer has effected the synthesis of indigo. Ladenburg of the alkaloid coniine, while

Emil Fischer has effected the synthesis of grape sugar.

It now only remains to make artificially the enzymes and albumens. Up to the present these require the intervention of life.

The most careful quantitative study of the transformations of matter have shown that mass remains unchanged. A definite quantity of every element was, is, and will be. This recalls the law of the conservation of work, and is perhaps connected with it.

The atomic hypothesis, which was proposed by Dalton as a convenient means of explaining the laws of definite and multiple proportions, has been given new meaning by Avogadro, and Kekulé, in terms of valence, has shown how the atoms are united in the molecule. Stereochemistry has even thrown light on the arrangement of the atoms in space, and Mitscherlich has shown that there are relations between the external crystal form and the atomic composition and constitution of the molecules.

The chemistry of the nineteenth century is also characterized by the introduction of physical methods and principles, which have almost always produced marked advances, and frequently fundamental changes. Among the physical methods should be mentioned the balance, the spectroscopic methods of Bunsen and Kirchhoff, and the electrical methods, which, in the hands of Clausius and Arrhenius have led to the theory of electrolytic dissociation.

The introduction of physical principles has also accomplished much. Bertholet, Guldberg and Waage have explained the facts of chemical equilibrium, showing that a transformation only proceeds to a definite limit. They have introduced the idea of general attraction, and have shown how the active mass can be ascertained. Thomsen and Berthelot have attempted to apply the law of the conservation of work to

chemical problems, and have developed the principle, which, however, does not always hold, that the heat evolved in a reaction is a measure of the affinity.

Through the united efforts of mathematicians, physicists and chemists, chemistry has, then, been placed upon a sure foundation. The second law of thermodynamics has been applied to chemical processes first by Horstmann, and then by Gibbs, Helmholtz, Duhem and others. This is, however, difficult for the chemist, since it involves a fairly good knowledge of mathematics and physics. It is, therefore, the problem of the physical chemists to give their well-established fundamental principles the simplest possible form. Something has been already accomplished.

1. The laws of dilute solutions, involving the conception of osmotic pressure, are just as simple as those of dilute gases, indeed, they are identical with them.

2. The heat evolved in a reaction determines the direction in which the equilibrium will be displaced by change in temperature. That which is formed with evolution of heat comes more and more to the front with decrease in temperature.

3. Affinity is closely connected with the conception of free work and is measured, not by the heat developed, but by the electrical work developed (electromotive force). Of these three principles, special stress is to be laid upon the importance of the last.

A very brief discussion of the *concrete* or *special sciences* follows. These include astronomy, meteorology, geography and geology.

Astronomy, by means of the spectroscope, has shown that in the spaces, so distant that it requires light many years to reach us, there is the same kind of matter as here on the earth. This includes iron, hydrogen and about twenty other elements, and these obey the same laws of reciprocal attraction as they do here on the earth. Astronomy

also calculates the history of the world in the future.

Geology gives us similar knowledge of the past, and shows that the world has not developed by sudden changes, as was formerly supposed, but that it has developed in accordance with the same laws which now reign.

HARRY C. JONES.

*BUFO AGUA IN THE BERMUDAS.*

ONE of the characteristics of the fauna of the Bermudas is the scarcity of terrestrial vertebrate forms. At present there is known but a single reptile (*Eumeces longirostris*) and a single amphibian (*Bufo aqua* Daudin). In 1884 Jones and Goode ('Contributions to the Natural History of the Bermudas,' Bull. U. S. Nat. Mus.) recorded no amphibian. Heilprin ('The Bermudas,' Philadelphia, 1893, p. 84) says that in 1888 he saw a few individuals of *B. aqua* in the salt marshes. As far as recorded, no amphibian had been known in the colony until the introduction of this species.

The history of its introduction, as gained from an interview with Captain Vesey in July, 1900, is as follows: Captain Nathaniel Vesey (at present a member of the Colonial Parliament from the parish of Devonshire) 'about fifteen years ago' engaged the master of a vessel plying between Hamilton and Demarara, British Guiana, to secure for him some of the Guianan toads, with a view to using them to catch garden insects. The toads were brought from Demarara to Hamilton, and were carried out to Devonshire by a native, who must have purloined some of the animals, for individuals were seen near the native's home (Tuckerstown), ten miles distant, soon afterward. Captain Vesey liberated 'about two dozen' individuals in his garden, where they thrived from the first and ate many insects.

From these two centers the animal has spread until it is common throughout the

colony. In its search for moist places it often gets into the cisterns, fouling the water. This fact, together with its ugly appearance and the common opinion that it is venomous, has brought it into disfavor with the inhabitants.

The porosity of the rock permits no springs, streams or ponds in the islands. The only bodies of water are several brackish tidal ponds near the shore. There are some brackish marshes the salinity of which is less than that of the ponds, but which are by no means fresh. It is in these marshes that the animal breeds. It seems to have adopted these from necessity rather than from preference, for in Jamaica (Andrews) and in Brazil (Hensel) it spawns in fresh-water pools.

The eggs are extruded 'early in the spring,' according to local report, but this must be regarded as uncertain until we have better evidence. In Jamaica spawning is said to occur in October, and in Rio Grand do Sul, Brazil, in the middle of winter (June). In July, while at the Biological Station of New York University at Hamilton, I found large numbers of young, nine to fourteen millimeters long, in the grass and on the roads near the brackish marshes. They were especially abundant just after a shower.

*Bufo aqua* is the largest living Anuran known. The largest specimen I have seen from Bermuda was collected by the New York University Expedition of 1898 and is now in the Zoological Museum at Columbia University. It measures 155 mm. from snout to vent, and weighs 960 gm. after having been two years in a four per cent. solution of formalin.

This toad is found in South and Central America and in the warmer parts of Mexico. It has not been included in the Neartic fauna by either Cope or Garman. I have found no record of it west of the Andes further south than Chimbo, Ecuador (about

2° S.). The expeditions to the Andes have not recorded it above altitudes of 1,500 feet nor more than about a hundred miles back from the coast. On the east coast it is recorded as far south as the Sierras del Tandel, Argentina (38° S.) by Berg. It is found throughout Brazil and in eastern Ecuador well up towards the headwaters of the Amazon.

It has been introduced into many of the Lesser Antilles to catch insects (Herrera). In 1844, according to Gosse, it was introduced into Jamaica from the Barbadoes, where it has been used to catch field rats. It had been brought from Martinique to Barbadoes, and had been carried to Martinique from Cayenne. It appears doubtful that it is indigenous to any of the islands with the possible exception of Trinidad. Faunal lists from Cuba, Porto Rico and the Bahamas do not include it.

Bermuda is now its northern limit, both in latitude (33° N.) and in mean annual isotherm (70° F.), but this distance from the equator is exceeded on the east coast of South America both in latitude (38° S.) and in mean annual isotherm (58° F.). It is essentially a tropical and subtropical form, and I do not find record of it in the region of frost in either latitude or altitude, except for a small area in Argentina.

*Bufo aqua* is known by various local names. The natives of parts of Brazil call it *aguaguacan*, from which comes its specific name. In Jamaica it is known as a 'bull-frog.' The inhabitants are prejudiced against it throughout its range and it is killed at every opportunity.

There is a general belief that it is venomous. One Brazilian writer (Filho) says that travelers report the use of its venom in place of curari by the natives of the upper Amazon region.

Experiments show that the secretion of its cutaneous and parotoid glands, when injected into the circulation of dogs, fowls or

frogs has poisonous effects, and in moderate doses causes convulsions, followed by death. There is no evidence that mere external application causes more than a slight irritation unless it reaches mucous membrane, when ulceration follows, or the cornea, which is rendered temporarily opaque.

There is not sufficient evidence to substantiate the popular belief among the natives of Bermuda that the animal can eject its secretion to a distance. There is some evidence that the secretion when taken into the digestive tract—as in the case of a dog getting it into the mouth—will cause death in a few hours, but there are no careful records of the physiological effects of the secretion beyond the fact that subcutaneous injections cause tetanic convulsions, followed by death in from one-half to two hours, according to dose.

F. C. WAITE.

UNIVERSITY HEIGHTS, NEW YORK CITY.

#### SCIENTIFIC BOOKS.

*Le préhistorique, origine et antiquité de l'homme.*

Par GABRIEL et ADRIEN DE MORTILLET.

121 figures dans le texte. 3e édition. Paris, Schleicher frères, 1900. Pp. xxii + 709. Bibliothèque des sciences contemporaines.

The first edition of *Le préhistorique* dates from 1883. A second edition appeared two years later and was exhausted at the end of ten years. The value of the work, as well as the rapid growth of the science, has made a third edition imperative. Gabriel de Mortillet devoted the closing year of his life to this task, which was destined to be completed by his son and collaborator, Adrien de Mortillet.

The incorporation of an immense amount of new and valuable material, made possible by a recasting of the work, has of necessity limited its scope. The Neolithic period is left to be treated in a separate volume together with the Bronze age.

The two main divisions of the present volume are devoted to the Tertiary and early Quaternary, respectively. The authors are inclined to make the most of the evidence bearing on a

Tertiary precursor of man, devoting twelve chapters to it. The accounts of the discoveries at Thenay, Saint Prest and Puy-Courny, in France; Otta, Portugal; Yenangyoung, Upper Burma, and as core of others are faithfully reviewed.

The Calaveras skull is rejected. The deposit in which it was said to have been found is Quaternary instead of Tertiary, and the skull, besides being of doubtful origin, bears not a single mark of antiquity. Neither are the human remains from Olmo, Colle del Vento and Castenedolo, Italy, accepted as Pliocene.

The chapter on fossil monkeys closes with *Pithecanthropus erectus*, which is considered the immediate precursor of man. The authors conclude that while man did not exist during the Tertiary, there did exist precursors of man more intelligent than any of the living anthropoids.

Part second is devoted to the Early Quaternary, which, according to de Mortillet, corresponds to the Paleolithic period. The method of treatment here is less didactic than in the earlier editions, the subject matter being grouped under the following headings:

- I. Industry, or Technology.
- II. Man, or Anthropology.
- III. Fauna, or Zoology.
- IV. Flora, or Botany.
- V. Geology.
- VI. Geography.

The first successful attempt to establish a scientific system of relative chronology for prehistoric times was made by Thomsen of Copenhagen, in 1836. Of the subsequent writers who have contributed to the elaboration of Thomsen's triple division, Gabriel de Mortillet unquestionably ranks first. His classification is very generally accepted, and ought to be familiar to every one who wishes to keep abreast of archaeological literature.

De Mortillet's system is based on the development of human industry, the successive steps of which are grouped under epochs. Following the method of nomenclature adopted by the geologist, he has given to each epoch the name of some well-known locality where the culture-stage in question is to be found in its purity.

The six epochs into which the Paleolithic

period is divided, beginning with the oldest, are: Chellean, Acheulian, Monsterial, Solutréan, Magdalenian, and Tourasséan, the Acheulian and Tourasséan being regarded merely as epochs of transition.

After tracing the steps in the industrial evolution of the Paleolithic period, the authors pass in review all the discoveries of fossil human bones supposed to belong to the same period. The existence of two races is recognized—an earlier, referred to the first three epochs of the Paleolithic period and called Neanderthal, and a later, referred to the last three epochs of the same period and named Laugeriean, or race of Laugerie-Basse. The Laugeriean race is derived from the Neanderthal without intermixture from any foreign source. The transition may be traced in the human remains from Arcy, Eguisheim, Marcilly and Bréchamps.

Acting on the safe principle that it is better to discard correct testimony than to accept doubtful, of the 33 discoveries of human remains attributed to the lower half of the Paleolithic, 18 are discarded altogether, 4 are put in the doubtful list, and only 11 classed as authentic. Those accepted are: Neanderthal in Prussia, and Eguisheim in Alsace; La Naulette and Spy in Belgium; Tilbury and Bury Saint Edmunds, England; Denise, Marcilly, Bréchamps, Malarnaud and Arcy, in France. The doubtful are: Canstadt, in Würtemberg; Brûx, Bohemia; Schipka, Moravia; Hamilton, Ireland. Those to be discarded are: Nagy-Sap, Hungary; Brünn and Predmost, in Moravia; Podbaba, Bohemia; Stängenäs, Sweden; Gaylenreuth, Lahr and Bolwiller, Germany; Engis, Belgium; Maestricht, Holland; Kirkdale, Victoria Cave and Galley Hill, England; Moulin-Quignon, Clichy, Grenelle, Graveuroire and Estalás, France.

Of the human remains attributed to the second half of the Paleolithic period, the authentic are: the skeletons of Laugerie-Basse, Chancelade and Sorde inférieure, all in France. A number of finds, including Cro-Magnon, Furfooz and Baoussé-Roussé are classed as Neolithic sepulchres.

Ten chapters are devoted to the contemporary fauna, and three to the flora. The question of the domestication of animals is decided



in the negative. There is also no evidence that the Paleolithic hunter-populations knew anything about agriculture.

A comparative study of the fauna and flora of France and England leads to the conclusion that the British Isles were united to the continent during the early Quaternary. The Seine, instead of reaching the sea at Le Havre, flowed westward along the coast of Calvados, then north and west past the site of the present city of Cherbourg, to empty into a gulf of the Atlantic separating Cornwall from Brittany. The Somme traversed rather obliquely the Channel, and being augmented on the way by affluents from both France and England, passed between the Isle of Wight and England by way of Spithead and the Solent, where it emptied into the same gulf of the Atlantic some distance north of the Seine.

It is interesting to compare this view with that of Sir John Evans,\* Mr. Codrington and the Rev. W. Fox.† The latter agree among themselves, although their conclusions were arrived at independently. They agree with de Mortillet in one respect only, viz., the river origin of the Solent. But in their opinion, that river flowed east and not west, joining the sea at Spithead. It was not the Somme, but a considerable stream, some of whose tributaries still exist in the small rivers which form the drainage of Dorset and Wilts.

There was also, during the Chellean epoch, a junction of Europe with America by way of the British Isles, the Faroes, Iceland and Greenland.

The volume closes with the geographic distribution of the types of industry characterizing the six epochs of the Paleolithic period. The abundance of rudely chipped Paleoliths in North America is recognized, but they are not considered as synchronous with the Chellean epoch in Europe. The Trenton terrace is referred to the same epoch as the Mousterian station of Santerno, Italy, which corresponds to 'the grand extension' of the glaciers.

In conclusion, by applying an absolute chronometric scale to the adopted system of relative chronology, the following results are obtained:

\*'Ancient stone implements of Great Britain,' 2d edition, p. 690.

† *Geologist*, Vol. V., p. 452.

Chellean epoch (preglacial).....	78,000	years.
Mousterian epoch (glacial).....	100,000	"
Solutréan epoch.....	11,000	"
Magdalenian epoch.....	33,000	"
Total.....	222,000	"

To the 222,000 years of early Quaternary is to be added 'the 6,000 years since the beginning of the historic period in Egypt and a probable 10,000 years of the Protohistoric and Neolithic.' The authors believe this to be a very moderate estimate for the antiquity of man.

There is a limit to the amount of matter that can be pressed into a single volume. The one in question is exceedingly rich as it stands, being far more comprehensive than any other attempting to cover the same field. Yet many will regret that so few references were cited and that a series of maps was not incorporated. The science of prehistoric anthropology is sadly in need of cartographic enrichment. It would be difficult to conceive of a more fruitful source for such an enrichment than the combined knowledge of the de Mortilletes.

We may, however, hope that the desired maps, augmented by others, will be included in the promised additional volume. May it soon appear!

GEORGE GRANT MACCURDY.

*Analyse des Gaz.* By M. E. Pozzi Escot. Paris, Gauthier-Villars. 1900. Pp. 200.

Chapter I., on 'Sampling,' is by far the best in the book, being complete and well written; the writer regrets that the same can not be said of the following chapters. In the important branch of analysis by explosion not one of the later forms of explosion pipette is given. In Chapter III., on reagents, no mention is made of fuming sulphuric acid, which Winkler showed ten years ago to be the best absorbent for 'heavy hydrocarbons'; nor is any statement made of the limitations of the use of various reagents, nor of their capacity of absorption.

Chapter IV., on the analytical characters and methods of estimating the principal gases, might almost—as far as any special information about gas analysis is concerned—have been taken from any treatise on chemistry.

Chapter V., on qualitative analysis, is admirable.

In Chapter VI., on the analysis of gaseous mixtures, especially by combustion, no directions or precautions are given necessary for a successful result, nor is the treatment of the analysis of illuminating gas at all satisfactory.

Chapter VII., on gas analytical apparatus, describes in a general way a number of the important forms of apparatus.

Chapter VIII., on the calorific power of gases, is especially disappointing, the only methods given being that of Mahler—by the bomb, and by calculation, no mention being made of the excellent apparatus of Junkers.

In conclusion, the work, so far from being 'essentiellement pratique,' as reviewed in the *Comptes Rendus*, appears to be superficial, better adapted to give a general idea of the subject than for a laboratory manual.

AUGUSTUS H. GILL.

#### SCIENTIFIC JOURNALS AND ARTICLES.

The *American Naturalist* for January begins with a list of 'Plants used by the Indians of Eastern North America,' by Lucia B. Chamberlain. The plants are arranged in alphabetic order under the name of each of the tribes considered and the uses of the plants are noted. R. W. Shufeldt has an article 'On the Systematic Position of the Sand Grouse (*Pterocletes; Syrrhaptes*),' concluding that they belong where they are usually placed, between the Galli and Columbæ. G. H. Parker discusses 'Correlated Abnormalities in the Scutes and Bony Plates of the Carapace of the Sculptured Tortoise,' concluding that there is a more intimate relation between the plates and scutes than has been generally admitted. Roswell H. Johnson describes, with outline and skiagraph illustrations 'Three Polymelous Frogs' and C. H. Eigenmann and Ulysses O. Cox consider 'Some Cases of Saltatory Variation.' James Perrin Smith treats of 'The Larval Coil of Baculites' and deduces that Baculites probably originated from *Lytoceras*, and some 'Variation Notes' are given, taken from the *Bulletin of the Société d'Anthropologie*. The Editor announces that the 'News' department will be discontinued as the same field is covered by SCIENCE more promptly, but that the record of appointments, retirements and deaths will be

continued and that there will be added notices of gifts to educational institutions, all to be published quarterly.

#### SOCIETIES AND ACADEMIES.

##### SECTION OF ASTRONOMY, PHYSICS AND CHEMISTRY OF THE NEW YORK ACADEMY OF SCIENCES.

A REGULAR meeting of the Section was held at 12 West 31st Street, New York, on February 4, 1901. Professor George E. Hale, director of the Yerkes Observatory, gave a lecture on 'Astronomical Photography with a Visual Telescope.' The following is an abstract:

Photography was discovered in 1837, and the first astronomical photograph was taken in 1840 by Dr. Draper of New York. It was a photograph of the moon made on a daguerreotype plate, and gave great promise of future work. Bond in 1850 made the first photograph of the stars. Rutherford of New York, in 1858, made some remarkable photographs of the moon, and later some star photographs.

Photography has now become so valuable in astronomy that it is applied in every department. It is not true, however, that it will displace the eye. There are certain fields where the eye will be superior to the photographic plate, but in many other fields photography has led to results that never could have been obtained by visual observation. I shall speak tonight of work done at the Yerkes Observatory with a telescope designed for visual observation. It is fortunate that this telescope was not designed for photography alone, for by the use of methods recently devised it has been possible to use it for photography and the results are not at all inferior to what they might have been on a telescope designed for photography alone.

The forty inch telescope of the Yerkes Observatory can be considered as a long camera with a focal length of about sixty-four feet. Its field of view embraces a circle in the sky of only about five minutes of arc in diameter. In photographing groups and clusters of stars this long focal length makes it possible to separate stars which would have been run together into one mass with an instrument of shorter focal length. A means of counteracting the uncor-

rected chromatic aberration has been devised by Mr. Ritchie of the Yerkes Observatory. He employs a yellow collodion film in front of the photographic plate at the eye end of the instrument, by which the blue rays are cut off. Suitable isochromatic plates, such as can be found on the market, are used. This is a very inexpensive means of using the telescope for photography. A special form of guiding apparatus to keep the star image at the same point of the plate has to be employed. On account of the unavoidable flexure of the large telescope tube, an auxiliary telescope placed parallel to the telescope tube cannot be used. The image of another star just outside the photographic plate is made use of. By means of a little eyepiece with a fine pair of cross-hairs, attached to the plate holder which is adjustable in two directions at right angles to each other, the image of the guide star is kept on the intersection of the cross-hairs during the entire time of the exposure. The photographs taken at the Yerkes Observatory in this manner by Mr. Ritchie are much finer than those taken at Potsdam with a photographic telescope.

A most important application of photography with this telescope will be the determination of the parallax of stars, which has not yet been done to any extent by photographic means.

Photographs of the small planetary nebulae taken with this telescope show more than can be actually seen with our eyes, as in some cases a radial structure.

The instrument can also be used to study stellar spectra and stellar evolution. We can pass by gradations from the type of hot and white stars like Sirius, to the more developed and colder ones like our sun, and then to the red stars. There are two types of red stars, and by the aid of their spectra photographed with this telescope, we have detected a relationship between the two types, through the presence of carbon bands. Even in the atmosphere of the sun there is a very thin layer of carbon vapor and above this the gases of the chromosphere. In the red stars we have this carbon vapor, which is very dense in one of the types.

Another important line of work is that of measuring the motion of stars in the line of sight. Professor Frost uses the titanium line

for this purpose, and has just had a new spectrograph constructed for the work.

In photographing the spectrum of Saturn with its rings, we find a faint band in the red indicating the presence of a comparatively dense absorbing atmosphere on the planet which is absent from the rings.

With the help of a spectroheliograph we are able to photograph solar phenomena. These photographs show that the mottling of the sun's surface persists throughout the minimum period of sun spots as well as through the maximum. Prominences can be photographed nearly as well with it as at times of total solar eclipse.

Mr. W. G. Levison presented a 'Note on a Cause of the Deterioration of Gelatin Photographic Dry Plates.' The author suggests that there is some emanation, probably Becquerel rays, from the pasteboard of the boxes in which the plates are packed for the market, which causes their deterioration. He found that if he cut a star from the pasteboard of a plate box and laid it on the sensitive side of a plate, the whole then being enclosed in a box for a week, when he developed the plate he obtained an image of the star. This would explain the deterioration at the edges of plates where they come nearly in contact with the box, or the deterioration due to the pasteboard separators at the edges of the plates. The author's experiments led him to the suggestion that metal boxes would be better for the plates than the pasteboard boxes. Wrapping with paraffine paper might also have the same effect.

WILLIAM S. DAY,  
*Secretary.*

#### TORREY BOTANICAL CLUB.

At the annual meeting, January 8, 1901, the Secretary, Professor E. S. Burgess, reported 15 meetings held during the year, with an average attendance of 33; 19 active members were elected. The active membership is now 233, the total membership 383; 20 papers have been presented, with addition of 26 brief notes of collections or of botanical progress.

The editor, Professor L. M. Underwood, reported a continued increase in the number of pages and of plates in the Club's publications,

including in Volume 27 of the *Bulletin*, 666 pages and 33 plates, and including Volume 9 of the *Memoirs*, with 292 pages and 9 plates. The articles printed in the *Bulletin* have numbered 63, by 48 different persons; 19 articles have contained descriptions of new species among the higher plants.

The Club voted to begin the publication of an additional monthly of about 12 pages, to include botanical notes and jottings, with reference to the local flora and to other subjects, and to bear the name *Torreya*, in honor of Dr. John Torrey, founder of the Club. Dr. M. A. Howe was made editor. The pressure of more extended technical matter upon the pages of the *Torrey Bulletin* has so far developed as to crowd out minor and more popular notes, and it was thought desirable to provide an opportunity for them by the establishment of this new journal, *Torreya*, which will be sent free to all Club members; to others at one dollar.

The officers elected for 1901 include the following: *President*, Hon. Addison Brown; *Treasurer*, Dr. H. B. Ferguson; *Recording Secretary*, Professor E. S. Burgess; *Editor*, Professor L. M. Underwood; *Associate Editors*, Dr. C. C. Curtis, Dr. M. A. Howe, Professor F. L. Lloyd, Dr. D. T. MacDougal, Dr. H. M. Richards, Miss Anna Murray Vail, Dr. N. L. Britton.

Recent papers read include Mr. J. E. Kirkwood's studies on the embryology of the Cucurbitaceae, the types selected for comparison being *Sicyos angulatus*, L., *Micranpelis tobata* (Michx.) Greene, and *Mornordica charanta*, L. These three types resemble one another in some features of their earlier development; in each case a cup-like structure is formed on the inner side of which the ovules are differentiated. In each case the normal definite embryo-sac is a typical one. Some ovules of *Sicyos* exhibited an embryo-sac abnormally developed. Endosperm is formed soon after fertilization, and seems to have the function of digesting the tissue of the nucellus and supplying the young embryo with food material. No suspensor was found in *Sicyos*, but in *Micranpelis* and *Mornordica* it is usually formed with two or three cells.

EDWARD S. BURGESS,  
*Secretary.*

#### DISCUSSION AND CORRESPONDENCE.

##### THE SUPPOSED TERTIARY SEA OF SOUTHERN BRAZIL.

IN an article entitled 'The History of the Neotropical Region,' published in No. 310 (Dec. 7, 1900) of SCIENCE, Dr. H. von Ihering, in order to account for certain zoogeographical facts reported by him, proposes the somewhat startling hypothesis of a tertiary sea separating two faunal sub-regions that he denominates 'Archiplata' and 'Archamazonia,' and gives the purely zoological evidence as sufficient, in his opinion, to positively establish the existence of this important geological feature. As the boundaries of these faunal sub-regions are not clearly defined the position of this sea remains doubtful, but from the context it is clear that it must have tied in with the known marine tertiary deposits of the Argentine province of Entre Rios and extended across the present mass of Brazilian highlands in such a way as to leave in the southern division a great part, if not all, of the States of Rio Grande do Sul and Santa Catharina, that is to say, in some part of the present basin of the Rio Uruguay.

Unfortunately our knowledge of the geological structure of this portion of Brazilian territory is extremely defective, but enough is known to make it certain that a presumably pre-tertiary formation stretches entirely across the region in question and thus far no geological observations or topographical features are known that suggest the slightest suspicion of any important break in its continuity. This is a formation characterized, like the triassic belt of eastern North America which it much resembles, by dykes, intercalated sheets and outflows of trappean rocks (diabase-porphyrite of Rosenbusch) of very uniform mineralogical composition, but very varied physical structure and aspect, by means of which it can readily be traced. Its geological age is undetermined, except that it is almost certainly post-paleozoic, since it overlies permian beds containing the Glossopteris flora. From this circumstance and from the strong resemblance to the above mentioned North American region, it has generally been referred to the triassic, though there is nothing to prove that it might not be cretaceous

or even tertiary. To refer it to the latter age would not, however, help the hypothesis here discussed, since there is no evidence whatever of its being of marine origin, and its northward extension well into the heart of central Brazil makes it embrace a very considerable portion of the Archamazonia faunal region of Dr. von Ihering.

The heavy trap dykes and sheets of this formation give very marked topographical features (lines of escarpments and obstructions in rivers) by which it can be traced even in regions that have not been geologically examined, and for some years I have occupied myself in tracing its distribution through such chance information and specimens as were obtainable from regions not personally known to me. Particularly valuable for this purpose was the material which for years has been accumulating in the Museum National of Rio de Janeiro and which for the region under discussion is especially important and authentic, since it contains a complete duplication of the material collected by Sellow on which Weiss' paper, the most important that has yet appeared on the geology of Rio Grande do Sul and Uruguay, was based. Without going into detail, suffice it to say that there is evidence that I consider sufficient to establish the general fact that this formation extends without a break and in the form of a great tableland, from 600 to 1,000 meters high, from near the headwaters of the Paraná in southern Goyaz and western Minas Geraes to the line of escarped hills that cross nearly in the middle, the State of Rio Grande do Sul from east to west. To the south of this line, which seems to be a giant fault, the formation lies lower and has been much denuded, so that it is frequently interrupted by areas of older rocks appearing from underneath, but thus far no evidence whatever has been presented of the occurrence of any overlying formation of marine origin.

Of special significance for our present purpose is the fact that the falls and rapids of the river Uruguay, down to the Brazilian limit and beyond, are composed of the hard traps of this formation which would thus present a barrier to the sea which in tertiary times undoubtedly occupied a part of the Argentine province of

Entre Rios. The only point where the deposits of this sea are known to extend to the eastern bank of the Uruguay is near the town of Colonia, too far south to suit the hypothesis here discussed. Topographically considered, the only line in which there was a possibility of a break across this barrier is a depressed area in front of the above mentioned line of escarpments, occupied by parts of the valleys of the rivers Ybicuhy, flowing westward to the Uruguay, and Jacuhy, flowing eastward to the Atlantic. These two valleys are, however, separated by a considerable spur that unites like an isthmus the highlands of the upper Uruguay basin with those of southern Rio Grande do Sul and Uruguay. Thus far no evidence has been presented that this isthmus was ever submerged, or that the depressed portions of the Ybicuhy and Jacuhy valleys are occupied by other than fluvial deposits. It is quite possible that in secondary or tertiary times an arm of the sea may have extended into the region of the lower part of the present Jacuhy valley, but if so there is slight probability that it extended westward into those of the Ybicuhy and Uruguay, and even if such a connection be admitted it could only have been a narrow strait quite incapable of producing the 'colossal' faunal difference that it is attempted to explain. Speculation as to the probable existence of this strait is, moreover, quite gratuitous, since, if I rightly understand Dr. von Ihering, its position is entirely within his Archiplata sub-region.

ORVILLE A. DERBY.

SÃO PAULO, BRAZIL,  
Jan. 8, 1901.

#### GEOLOGICAL MAP OF EUROPE.

WHAT has become of it? Why does Dietrich Reimer not publish it?

WM. A. INGHAM,  
*Ex-Secretary Penna. Geol. Survey.*

#### NOTES ON INORGANIC CHEMISTRY.

##### ROCK FORMATION.

AN important contribution to the study of solid solutions has been made by Professor W. Spring in the *Revue Générale des Sciences*, under the title of 'The Plasticity of Solid Bodies and

its Connection with Rock-Formation.' Experiments were carried out to determine whether under the influence of great pressure solid particles, which do not under ordinary circumstances unite, might be made to cohere. The pressure used in the experiments was about 10,000 atmospheres, and this pressure could be exerted if necessary at a temperature as high as 400°. All bodies which are plastic under pressure were found to cohere as if they had been fused, while those substances which are not malleable remained in a powder after exposure to the greatest pressures. Thus sand, calcium carbonate, alumina and oxid of iron did not cohere, and since the pressure used corresponds to a column of sand fifty kilometers in height, pressure alone can not be the cause of the formation of rocks from these materials. Metallic powders, on the other hand, cohere perfectly, which must be due to a kind of solid solution. That this is probable is shown by using mixtures of different metals, in which case alloys are formed as perfectly as by fusion. Those metals, however, which do not alloy by fusion, as lead and zinc, will not alloy under pressure. That these alloys were not occasioned by a mere mixing under pressure was shown by placing together without pressure cylinders of the same and of different metals. Even in the cold there was some adherence and, when heated to a temperature far below the point of fusion, a perfect union was obtained in a few hours. In the case of the union of different metals, an alloy was formed at the line of junction, which with tin and lead was six millimeters in thickness. Compounds were readily formed by pressure in those instances where the volume of the compound is less than that of its constituent elements, as with silver and sulphur; on the other hand, compounds which occupy more space than their constituents were dissociated by pressure. Thus copper calcium acetate was decomposed into copper acetate, calcium acetate and water. In those cases where solution is accompanied by contraction, the presence of water was found to greatly assist in the formation of solid masses from the powders, and solid carbonates were readily formed. A solution of silicic acid alone did not cause agglutination of sand, owing to the great

contraction on drying, but when combined with even low pressure, solidification to a considerable extent was obtained. All these influences have played a part in rock formation.

#### ARSENIC IN COPPER.

LITTLE is given in chemical literature regarding the effect of small quantities of arsenic upon copper, a subject of much importance at the present day. A series of experiments is described by Ernest A. Lewis in the *Chemical News*, in which arsenic was added to a copper 99.843 per cent. pure, and the resultant metal studied photomicrographically and as to its physical properties. Malleability is not appreciably affected by small quantities of arsenic (up to 1.8 per cent.), the samples with 1 per cent. and with 1.37 per cent. rolling particularly well. The tensile strength is from 3 to 5 tons higher than that of ordinary sheet copper, the limit of elasticity is about 3 tons per square inch higher, and the elongation is not reduced. From micrographical examination, the metal appears to consist of crystals of copper, in a eutectic of copper arsenid or a solution of copper arsenid in copper. In copper intended for rolling, except that for electrical purposes, the presence of a small amount of arsenic appears to be a distinct advantage, but nothing is gained by having more than 0.5 per cent. present.

#### ATMOSPHERIC HYDROGEN.

AN interesting result of Professor Dewar's latest experiments, in conjunction with Professor Liveing, on the more volatile of the inert gases of the atmosphere is the demonstration that hydrogen exists free in the atmosphere in sensible proportion. There has been much question in the past as to its presence, which has not been heretofore satisfactorily proved; indeed the velocity of the hydrogen molecule renders it doubtful as to whether hydrogen would not escape from the earth into interplanetary space. On this basis there must be a continual accession of hydrogen to this planet from the interplanetary space, and hence possibly of the elements which occasion the lines of the nebular and coronal spectra. Some indications in this direction have been found in the atmospheric inert gases, and these are now being studied from this standpoint. J. L. H.

CURRENT NOTES ON PHYSIOGRAPHY.

THE CASCADE MOUNTAINS.

THE Cascade mountains are genetically described by I. C. Russell (A Preliminary Paper on the Geology of the Cascade Mountains in Northern Washington, 20th Ann. Rep. U. S. Geol. Surv., 1900, pt. II., 83-210; 10 pl., 3 maps) with such success as to give much support to rational or explanatory methods in place of the absolute or empirical methods that have long prevailed. Instead of being a sharp crested uplift, the mountains constitute a plateau, believed to have been produced by the elevation of a peneplain, but now maturely dissected. The area described, from 100 to 150 miles wide east and west, and of greater but unknown length north and south, seems to have been once a nearly flat-topped dome, 7,500 to 8,000 feet in altitude, composed of greatly disordered rock masses, whose tilted strata had been broadly truncated by long-continued erosion when the whole region stood lower. The uplift of the dome is given a late Tertiary date, because the sediments and lavas of the Columbia basin are tilted up along the eastern slopes of the elongated dome; here landslides, to be counted not by hundreds but by thousands, have occurred along the escarpments formed by the resistant lava sheets overlying weaker sediments. The granite mountains about Lake Chelan and the dissected volcano known as Glacier peak overtop their surroundings; the former are thought to owe their height not so much to resistant structure as to local uplift in excess of their neighbors. (An alternative explanation is offered, but discarded, to the effect that the ancient peneplain lay at the level of the granite summits 2,000 or 3,000 feet above the present skyline.) It is explicitly stated that no remnants of the uplifted peneplain are to be seen to-day in the form of even uplands at mountain-top height; dissection has everywhere advanced so far as to leave only sharp ridges between deep valleys. The work of the glacial period is indicated in countless cirques or corries, whose floors were so far widened that the spurs between them became sharply serrate; by numerous trough-like main valleys, with hanging lateral valleys; by lakes and moraines. The depth to which certain valleys, like that of Lake

Chelan, have been eroded is taken to prove that the region stood about 1,000 feet higher than now in preglacial time; the capacity of glaciers to over-deepen their valleys not being accepted.

THE GLACIER OF MT. ARAPAHOE.

W. T. LEE describes 'The Glacier of Mt. Arapahoe, Colorado' (*Journ. Geol.*, VIII., 1900, 647-654, 2 pl.) as occupying a cirque opening to the north beneath a summit whose altitude is 13,520 feet. The front of the ice shows a stratified structure, and crevasses are believed to break its surface, while a moraine follows its front, and a stream, whitish with rock flour, issues from its base. The valley into which the cirque opens has a broad floor and precipitous sides; it holds several small lakes, sometimes in rock basins, sometimes behind barriers of waste. Evidently the existing glacier is a small affair compared with the ice stream that once stretched down the valley towards Boulder creek.

RHINE, DANUBE AND NECKAR.

THE deprivations committed by the Rhine and its large branch, the Neckar, on the headwaters of the Danube, already somewhat studied by others, are clearly set forth by Penck

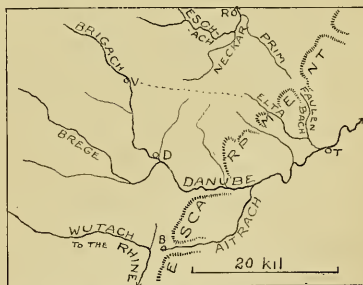

FIG. 1. Headwaters of the Danube between those of the Rhine and the Neckar. B, Blumberg; D, Donau-eschingen; R, Rottweil; T, Tuttlingen; V, Villingen.

(*Thalgeschichte der obersten Donau. Verein f. Geschichte des Bodensees u. s. Umgebung*, 1900?). He shows that several ancient consequent streams flowing down the eastern slopes of the Black forest entered the Miocene sea of the

Bavarian foreland; and that as the sea withdrew the Danube was developed along its trough, engrafting into its trunk the many smaller streams that before had independent courses. As the valleys of the consequent streams were deepened, trenches were cut through the resistant strata of the white Jura, whose retreating margin was in time worn back (southeast) to form a *cuesta* with an infacing escarpment, while an inner lowland was opened on the weak Lias beds between the escarpment and the crystallines of the Black forest. To-day only one of the consequents (Brege-Danube) retains its course through the *cuesta*. The Wutach has been diverted from the Aitrach to the Rhine; the Brigach has been captured from the Elta by the Danube itself; and the Neckar has taken the Eschach from the Faulenbach. Similar changes are known for a long distance northeast of the Eschach, where the phenomena associated with the drainage of *cuestas* are illustrated in great variety. Penck uses the terms *Folgefluss*, *Schichtfluss* and *Gegenfluss* for consequent, subsequent and obsequent streams.

W. M. DAVIS.

#### CURRENT NOTES ON METEOROLOGY.

##### A NOTABLE STUDY OF ECLIPSE METEOROLOGY.

In his paper on 'The Eclipse Cyclone and the Diurnal Cyclone' (*Proc. Amer. Acad. Arts and Sci.*, XXXVI., Jan., 1901, 307-318) Clayton has gone far ahead of all previous investigators of the phenomena of eclipse meteorology. Hitherto, as a general rule, we have had little more than a few scattered observations of temperature, pressure, wind direction, etc., taken during an eclipse, and tabulated, with a brief summary of the results. In his study of the meteorological data obtained in connection with the total solar eclipse of May 28th last, Clayton has derived results of far-reaching importance, which throw light on two of the largest problems in meteorology.

The meteorological changes due to the eclipse were first separated from other changes, such as the diurnal and the cyclonic, and were then plotted on maps of the United States for 8.15 and for 9 A. M., May 28th, 75th meridian time. These maps show that the winds were practically reversed in direction as the umbra

moved from one side of the continent to the other, both maps showing a distinct anticyclonic circulation and an outflow of air extending from the umbra to a distance of about 1,500 or 2,000 miles. The temperature depression due to the eclipse appears on the 9 A. M. chart as an oval area. At the central portion of this area the depression exceeds 8° Fahr., and this area of greatest cold lags behind the umbra about 500 miles. A third chart was constructed by plotting the stations at their proper distances from the path of the umbra, and plotting the successive 15-minute observations at intervals of about 500 miles, the result being a synoptic chart showing the conditions observed at any station or group of stations when they were in different portions of the eclipse area. This synoptic chart indicates distinctly an anticyclonic circulation of the wind around the center of the eclipse, extending out to a distance of about 1,500 miles from the umbra. Beyond this there are indications of another ring of outflowing winds. The isotherms show an elliptical area of cold air (inner isotherm 6° Fahr.) central about 500 miles in the rear of the umbra. There was a rise of absolute and of relative humidity during the eclipse, the shape and position of the areas showing the humidity departures being very similar to those of the temperature. The pressure changes in this eclipse, and in other eclipses, show that in normal eclipses there is a central area of relatively high pressure; surrounding this a ring of minimum pressure, and beyond this, outside the edge of the penumbra, is a ring of maximum pressure.

The low temperature, the circulation of winds and the form of the pressure curve, all proclaim the development by the eclipse of a *cold air cyclone*, as described by Ferrel. Mr. Clayton points out that the eclipse may be compared with an experiment by Nature in which all the causes that complicate the origin of the ordinary cyclone are eliminated, except that of a direct and rapid change of temperature. The result shows that a fall of temperature is capable of developing a cold-air cyclone in an astonishingly short time, with all the peculiar circulation of winds and distribution of pressure which constitute such a cyclone. The fall of temperature acts primarily to cause a cyclone, and



the anti-cyclone is a secondary phenomenon—a part of the cyclone. The eclipse cyclone, to keep pace with the eclipse shadow, must continuously have formed within the shadow, and must have dissipated in the rear almost instantly. The motion may thus be considered to have a certain analogy to wave motion.

In the light of his discovery that the brief fall of temperature in the eclipse can produce a well developed cyclone, which accompanies the eclipse shadow at the rate of about 2,000 miles an hour, Clayton believes that the fall of temperature due to the occurrence of night must also produce, or tend to produce, a cold-air cyclone. Since the heat of day produces, or tends to produce, a warm-air cyclone, there must tend to occur, each day, two minima of pressure, one near the coldest part of the day and another near the warmest part of the day, with areas of high pressure between them due to the overlapping of the pericyclones surrounding the cold-air and the warm-air cyclones, respectively. These causes must, in the opinion of the author, produce entirely, or in part, the well-known double diurnal period in air pressure, a question which has long puzzled meteorologists and for which as yet no wholly satisfactory explanation has been offered. The surface winds at Cordoba (Argentina) and at Blue Hill are in general found to be in opposite directions, and to indicate a circulation of the wind around two cyclonic centers passing along the equator, and an outflow from high pressures half way between them.

Clayton's conclusions, which are to be presented in greater detail in a forthcoming *Bulletin of the Blue Hill Observatory*, are of the greatest interest and importance. His explanation of the diurnal variation of the barometer seems to have in it many evidences of being the best yet offered to account for this puzzling phenomenon. Meteorologists will now look forward to future solar eclipses with greatly increased interest because of the importance which Mr. Clayton has shown to be attached to eclipse meteorology. It is to be hoped that Mr. Clayton may have the time and the opportunity to extend his investigation further in connection with previous eclipses.

R. DEC. WARD.

#### THE MAGNETIC SURVEY OF THE UNITED STATES.

ON July 1, 1899, a special division of the Coast and Geodetic Survey Office was created by the Superintendent to take charge of the magnetic survey of the United States and the countries under its jurisdiction, which up to that time had been conducted under the supervision of the Computing Division of the Coast and Geodetic Survey. Since that date magnetic observations, namely, declination, dip and intensity of magnetic force, have been made up to December 31, 1900, at about 500 stations distributed over the United States, Alaska and the Hawaiian Islands. At most of the stations permanent marks have been established for the use of the surveyor. Special consideration has also been given to the needs of the mariner, especially in Alaskan waters, where occur places of pronounced local attraction, affecting the compasses on board ship all the way from one-fourth of a point to four points.

Special stations known as 'repeat,' or 'secular variation' stations, have also been established in different parts of the country. At these, observations will be repeated at stated intervals in order to determine the amount of secular change in the magnetic elements. It is the endeavor whenever possible to establish such stations in the vicinities of colleges and universities, as experience has shown that on college grounds we may hope for a permanency of station for a fairly long interval.

Of special state surveys mention may be made first of the completion of the magnetic survey of Maryland, which was undertaken primarily by the Maryland Geological Survey, with assistance rendered by this Bureau; second, the completion of the magnetic survey of North Carolina, conducted under the joint auspices of this Bureau and the North Carolina Geological Survey; third, the completion of the magnetic survey of West Virginia, and fourth, the completion of the magnetic survey of Iowa.

Fair progress has also been made in the establishment of the Magnetic Base Stations, where the countless variations of the earth's magnetism will be recorded photographically. Thus a temporary magnetic observatory has been in operation at Baldwin, Kansas, since

July 1, 1900, and the buildings for the primary, or principal Magnetic Base Station, located at Cheltenham, Md., 16 miles southeast of Washington, have been completed and the installation of the instruments is now taking place. Special declination readings from 7 A.M. to 4 P.M. have been made at Gaithersburg, Md., since March 22, 1900, and at Sitka, Alaska, since October 1, 1900. The sites for the Magnetic Base Stations at Sitka, Alaska, and near Honolulu, Hawaiian Islands, have been determined and preparations made for the erection of the buildings. It is intended to have these magnetic observatories completed in time for cooperation with the proposed Antarctic expeditions.

Special simultaneous observations have also been made on special days at various times, the purpose of these special observations being to determine over how large an area the variations as recorded at the Base Stations may be regarded as applying.

Various special investigations, both of an experimental and of a theoretical character, have been undertaken, and considerable attention paid to the thorough training of observers and to the proper correlation of the various magnetic instruments. During the fall of 1899 a set of Coast Survey magnetic instruments was compared with the standard instruments at the following foreign observatories: Kew, England; Potsdam, Germany; Pavlovsk, Russia, and Parc St. Maur, France.

The following publications have been issued: Appendix No. 9, giving a general report of the magnetic survey of North Carolina, and Appendix No. 10, on the magnetic work of the U. S. Coast and Geodetic Survey; both appendices appearing in the 'Report of the Survey for 1898-99.' Good progress has also been made with the new edition of the Coast and Geodetic Survey magnetic declination tables and Isogonic charts for the United States and Alaska for 1900, designed especially for the use of surveyors and mariners. There has also been issued recently Bulletin No. 41, giving a general summary of magnetic declinations and of secular variation tables in North Carolina.

T.

#### ADVANCE IN FORESTRY LEGISLATION.

ONE by one the different States are awakened to their duty in providing for the future of our forest supplies. The latest development is the introduction on January 23d of two bills into the Legislature of Michigan, which aim to place the two most needful foundation stones for the future State policy. One bill is a most comprehensive 'Forest Fire Protection Act'; the other recognizes the forest reservation policy by establishing a State Forest Reserve.

There had been previously (in 1899) created a Forestry Commission of three members, and the bills were undoubtedly drawn by that Commission with great care.

The Fire Bill is based, in general principles, upon that in existence in the State of New York, which the writer had formulated in 1885, but is improved in several directions. It provides an organization of town fire-wardens under district forest-wardens, with a single Chief Forest-Warden responsible to the Forestry Commission. It places responsibility carefully and, with rather too much prescriptive detail, tries to meet any possible case. The main improvement upon the New York State law, besides the greater coherency of the organization, is the manner in which the expense is distributed. The State pays the entire expense and then collects three-quarters of it from the counties involved, namely, one-half from the county in which the fire originated, the other half from the counties, in proportion to the area burned over in each. But, if neglect on the part of a fire-warden or a responsible county officer can be proved, the whole charge goes against that county. This provision should create a wholesome solidarity and watchfulness in the whole community.

The State Forest Reserve, or rather several reservations, are to be made up of 'delinquent tax lands' within certain districts of the southern peninsula. The area desirable to reserve is to be determined by the Forestry Commission; future tax sales are to increase this area in a similar manner, and also voluntary contributions by private individuals. A novel idea in favor of educational effort is introduced for the acquirement of additional lands

by these last means. Such grantors may, in their deed, provide 'a trust of the lands so deeded in favor of the State University or State Agricultural College, or both, whereby all income and revenue from the lands so deeded shall be paid to the beneficiary named in such deed, as a permanent endowment \* \* \* for the purposes of its work in the line of forestry.'

The possession, care, control and management of the State Forest Reserve lands are vested in the Forestry Commission, as well as the administration of the trust lands, and ample powers and legal authority are given to the Commission to secure the greatest benefit from the Reserves. It shall not only investigate modern forestry methods, etc., but has power to cut, remove, sell and contract away any timber it deems desirable, opening the way to a rational forest management.

For the purpose of carrying on this practical forestry work, provision is made for a Chief Forest Warden with a salary of \$2,000, which is rather small for a really efficient man; he is made superintendent of all Forest Reserve Lands, with a number of deputy forest-wardens, with salaries not to exceed \$3.00 per day, and the fire-wardens to assist.

The conferment of sheriff's power upon the forest officers, the provision of penalties for various acts of trespass and methods of procedure are prescribed in greatest detail, and the sum of \$25,000 for the first two years is set aside to carry out the program.

This legislation is undoubtedly the most comprehensive and carefully drawn which has so far been introduced in any of the states. Under it a properly constituted Commission, properly supported with appropriations, should certainly make a successful beginning in establishing a permanent State Forest Policy. A provision which would make the administration independent of annual appropriations later on, and make it rely on its income, in part at least, would be the next desirable step. The present Forest Commission, as is evident from the care with which these bills are drawn, would seem most excellently fitted for its task.

B. E. FERNOW.

#### SCIENTIFIC NOTES AND NEWS.

At a meeting of the American Geographical Society, on February 20th, the Cullum Medal was conferred on Dr. T. C. Mendenhall in recognition of his services as Superintendent of the United States Coast and Geodetic Survey and as a member of the Alaskan Boundary Commission.

The gold medal presented by the Royal Astronomical Society to Professor E. C. Pickering, director of Harvard College Observatory, on February 8th, was received by the United States ambassador, Mr. Choate, who made a speech in acknowledgment.

The students of the University of California celebrated the 77th birthday of Professor Joseph Le Conte on February 26th. Professor Le Conte has just returned to Berkeley from a visit to Georgia.

The Senate of the University of St. Andrews has resolved to confer the degree of LL.D. on Mr. Alexander Agassiz, of Harvard University, and on Dr. J. A. Ewing, professor of applied mechanics in Cambridge University.

MR. ALEXANDER AGASSIZ was entertained at a banquet given by the French Zoological Society on February 1st. Speeches were made by MM. Perrier, Delage and Blanchard, to which Mr. Agassiz replied.

The University of Pennsylvania has conferred the degree of LL.D. on President Henry S. Pritchett, of the Massachusetts Institute of Technology, and the degree of D.Sc. on Rear-Admiral George W. Melville, engineer-in-chief of the United States Navy.

DR. J. K. REES and Professor H. M. Howe, of the departments of astronomy and metallurgy of Columbia University, have been decorated as Chevaliers of the Legion of Honor by the President of the French Republic for services in connection with the Paris Exposition.

At the convocation of the University of Oxford, on February 12th, the degree of D.Sc., *honoris causa*, was conferred upon Oliver J. Lodge, LL.D., F.R.S., principal of the University of Birmingham. He was presented by Dr. Love, Sedleian professor of natural philosophy, who briefly sketched his career, his distinctions and his investigations.

THE fourth banquet of the Paris *Scientia* was given to M. Marey on January 14th. Speeches were made by MM. de Parville, D'Arsonval and Richet. M. Marey made a reply, in the course of which he called attention to the progress of the plans for the standardization of physiological instruments. It appears that the City of Paris has set aside a building where the commission may carry on tests.

THE Adams Prize for 1901, open to the competition of all persons who have at any time been admitted to a degree in Cambridge University, has been awarded to Hector Munro Macdonald, M.A., fellow of Clare, for an essay on 'Electric Waves.'

PROFESSOR A. D. MEAD, of Brown University, has been appointed a member of the Inland Fish Commission of Rhode Island, in succession to Professor H. C. Bumpus who resigned, owing to his removal to the American Museum of Natural History, New York City.

AT the meeting of the Paris Academy of Medicine on January 29th, M. Jaccoud was elected to the post of permanent secretary, vacant by the death of M. Bergeron.

PROFESSOR DAVID P. TODD, of Amherst College, will sail next week for Singapore, to observe the total eclipse of May 18th in the Island of Sinkop. Mrs. Todd will accompany the expedition to accumulate material for revising her work on 'Total Eclipses of the Sun,' a new edition of which was published by Little, Brown & Co. a year ago. A botanist, also possibly an anthropologist, will be attached to the expedition, which is expected to return in August.

WE learn from the *Electrical World* that Professor R. A. Fessenden and his corps of assistants, sent out by the Government to establish wireless telegraph stations down the coast, have completed the first installation off Roanoke Island, N. C. The station is not far from Cape Hatteras.

DR. FREDERICK A. COOK has returned to New York after having attended a meeting at Brussels of those interested in the publication of the reports of the Belgian Antarctic expedition.

PROFESSOR M. I. PUPIN, of Columbia University, delivered an address on February 13th be-

fore the Scientific Association of Johns Hopkins University, his subject being 'Recent Improvements in Long Distance Telephony.'

WE learn from *Nature* that Professor J. A. Ewing, F.R.S., has been elected a member of the Athenæum Club under the provisions of the rule which permits of the election of persons of 'distinguished eminence in science, literature, the arts or for public service.'

DR. J. W. L. GLAISHER, F.R.S., has been elected president of the Royal Astronomical Society of Great Britain.

THE following members of the Paris Academy of Sciences have been elected officers of the Bureau des Longitudes for the year 1901: *President*, M. le commandant Guyon; *Vice-President*, M. le général Bassot, and *Secretary*, Professor G. Lippmann.

THE following were elected president and members of the council of the Physical Society of London for the ensuing year at the annual general meeting held on the 8th inst.: *President*, Professor S. P. Thompson, F.R.S.; *Vice-Presidents*, Mr. T. H. Blakesley, Mr. C. Vernon Boys, F.R.S., Professor J. D. Everett, F.R.S. and Mr. J. Walker; *Secretaries*, Mr. H. M. Elder and Mr. W. Watson, Physical Laboratory, South Kensington; *Foreign Secretary*, Professor R. T. Glazebrook, F.R.S.; *Treasurer*, Professor H. L. Callendar, F.R.S., University College, Gower-street; *Librarian*, Mr. W. Watson, Physical Laboratory, South Kensington; *Other Members of Council*, Professor H. E. Armstrong, F.R.S., Mr. W. R. Cooper, Mr. G. Griffith, Mr. E. H. Griffiths, F.R.S., Mr. R. A. Lehfeldt, D.Sc., Mr. S. Lupton, Professor J. Perry, F.R.S., Mr. A. W. Porter, D.Sc., Mr. W. A. Price and Mr. R. Threlfall, F.R.S. Professor Willard Gibbs, of Yale University and Dr. Rudolph Koenig, Paris, were elected honorary fellows of the Society.

DR. JACOB GEORG AGARDH, the eminent Swedish phycologist, died at Lund, Sweden, on January 17th, aged eighty-eight years.

FRANCIS KENNEDY, PH.D., since 1898 professor of philosophy in the University of Colorado, died on February 19th of heart failure. Although but 26 years of age, Dr. Kennedy had done much research work, and

his last illness was brought on by too close study and attention to the work of his department.

THE House of Representatives has agreed to the Senate amendments to the Agricultural Appropriation Bill, reorganizing the Department of Agriculture in the direction explained in recent issues of this JOURNAL.

THE following amendment to the General Deficiency Appropriation Bill was introduced into the House of Representatives on February 21st, by Mr. Ray, of New York:

That facilities for study and research in the Government Departments, the Library of Congress, the National Museum, the Zoological Park, the Bureau of Ethnology, the Fish Commission, the Botanic Gardens and similar institutions hereafter established shall be afforded to scientific investigators and to duly qualified individual students and graduates of institutions of learning in the several States and Territories, as well as in the District of Columbia, under such rules and restrictions as the heads of the Departments and Bureaus mentioned may prescribe.

A joint resolution to the same effect was introduced in the Senate on February 18th, by Mr. Perkins and referred to the Committee on Education and Labor.

MME AZOULAY has endowed, at the University of Lyons, a lectureship for foreign men of science. Professor Forel, of the University of Zurich, lectured on this foundation on January 27th, and Professor Schreiner, director of the observatory at Potsdam, is expected to lecture next month.

GIFTS for public libraries, conditional on their maintenance, have been made by Mr. Andrew Carnegie, to the following towns: Schenectady, N. Y., \$50,000; Marion, Ind., \$50,000; Galesburg, Ill., \$50,000; Mount Vernon, N. Y., \$35,000; Cumberland, Md., \$25,000 and Port Jervis, N. Y., \$20,000.

THE Royal Institution, London, has received gifts of £50 each from Sir Frederick Abel and Professor Dewar for the fund for the promotion of experimental research at low temperatures.

A TELEGRAM was received at the Harvard College Observatory, on February 22d, from Dr. T. D. Anderson, at Edinburgh, stating that a

new star had been discovered by him in the constellation Perseus. The position is R. A.  $3^{\text{h}} 24^{\text{m}} 24^{\text{s}}$  and Dec.  $+43^{\circ} 34'$ . Its magnitude on February 21st was 2.7 and its color bluish-white. This star was observed at the Harvard College Observatory through clouds on February 22d. It was then first magnitude. A photograph of this region taken on February 19th showed that it was then fainter than the magnitude 10.5. This result was confirmed by photographs taken on February 2, 6, 8 and 18, 1901.

WHILE making an examination of the copper deposits in the vicinity of La Barranea, Sonora, Mexico, Mr. J. Owen, assistant to Dr. E. T. Dumble, found two deposits of torquoise. They occur in what is regarded as the equivalent of the volcanic complex described as 'Trincheras.' The deposits at Turquoise, Ariz., are in similar rocks.

MICHIGAN has long been known as a producer of copper and iron, and, more recently, as a source of salt supply for the West and the middle West. Still more recently large quantities of the secondary product of salt—caustic soda, soda ash and sodium carbonate have been sent out from the various plants in the neighborhood of Detroit. This has stimulated the search for coal, and Michigan coal, mainly from the Saginaw Valley, is now largely used. Within the past year attention has been called to the numerous deposits of marl and clay suitable for the manufacture of Portland cement, in Southern Michigan, and this interest is being rapidly developed.

THE seventy-third annual meeting of the German Men of Science and Physicians will be held this year at Hamburg from the 27th to the 29th of September.

THE French Association for the Advancement of Science will hold its annual meeting this year at Ajaccio, in Corsica, probably about the middle of September, and will be presided over by Dr Hamy.

THE *British Medical Journal* states that an Italian Society of Biology has recently been founded on the initiative of Professors Albertoni, Antonelli, Bizzozero, Bonome, Borzi Briosi, Bufalini, Camerano, Celli, Cervo, Chiarugi,

DeGiaxa, Delpino, Di Veste, Emery, Fano, Ficalbi, Foà, Fusari, Gaglio, Giacosa, Golgi, Grassi, Guarnieri, Luciani, Lustig, Marcacci, Marchiafava, Martinotti, Mattiolo, Mosso, Pagniani, Pavesi, Pirota, Romiti, Roster, Schrön, Stefani, Tizzoni and Todaro. The first meeting of the Society will probably be held in Rome during the coming Eastertide. The object of the Society is to promote the study of the biological sciences and everything relating to the advancement and teaching of these. The Society will publish a bulletin giving an account of its proceedings. It is divided into eight sections as follows: anatomy, physiology, pathological anatomy, general pathology, pharmacology, hygiene, zoology and botany.

THE February meeting of the Faculty Science Club of Wellesley College was held in the library of the Whitin Observatory, the paper being by Dr. Eleanor Gamble, of the Department of Psychology, on 'Certain Data for the Classification of Smells.'

THE Royal Geographical Society held a meeting on February 12th in commemoration of the reign of Queen Victoria, who was for sixty-three years the patron of the Society. The chair was taken by the president, Sir Clements Markham, who read the first paper on 'Her Majesty's Connection with the Society and Interest in Geography and on Polar Exploration during her Majesty's Reign.'

PROFESSOR WILLIAM H. BREWER, of the Yale Scientific School, lecturing at New Haven on the Antarctic Continent on February 15th, said, according to the report in the *New York Times*, that "This, the seventh and last continent of the world, which for several hundred miles extends parallel to the Antarctic circle, offering an effectual barrier to further navigation south, a New Havener had the honor of discovering. He was Lieut. Eld of the United States Navy. The memorial tablet to Lieut. Eld, which now stands in the Grove Street Cemetery, reads that he was born in New Haven in 1814 and died of yellow fever on board the U. S. S. *Ohio* in 1850. He was a member of the exploring expedition sent into the Antarctic regions by the United States Government in 1838-42 under command of Capt. Wilkes." "At 10 A.M. on

January 16, 1839," so reads the tablet, "Lieut. Eld cried out 'Land.' Turning to Lieut. Reynolds who stood by he pointed out the range of icebound cliffs, along which the expedition afterward skirted for several hundred miles before it was compelled to turn back homeward. The peak which Eld first discovered was named Eld's Peak. The Antarctic continent which has never been penetrated goes by the name of Wilkes Land." The date of the tablet, which reads January 16, 1839, was discovered to be erroneous by Professor Brewer, while he was preparing this lecture. In looking through the ship's log of the expedition he found the true date to be January 16, 1840.

REUTER'S Agency gives out the following interview with Captain Joseph C. Bernier, of Quebec, regarding his proposed polar expedition: "I have two plans to lay before the Canadian Government on my return, each of which are based upon my long personal acquaintance of Arctic seas and have been approved by the best Arctic authorities. My first plan is to start by way of Behring Straits, follow the coast of Siberia and enter the ice between 165 and 170 degrees of longitude East. I shall then push north as far as the ice will permit. When my ship gets into the ice I shall then place myself in the hands of nature. If she gets into a better position than the track of the *Jeannette* I shall expect to reach the Pole, and return in between three and four years. This will not be so difficult as in the case of the *Jeannette*, because the polar basin at the present time has more openings than in past years, this being due to the changed climatic conditions. My second plan, which has already been privately submitted to the Quebec Geographical Society, is to start from Franz Josef Land with a large number of dogs and reindeer and travel during the summer to the Pole by sleighs, taking with me concentrated provisions and killing my reindeer day by day for food. Elaborate calculations have been made as to the number of dogs and reindeer required for sleighing and for food. Traveling at an average of six miles per day the journey to the Pole should occupy 150 days, at the end of which time I should still have enough provisions to return towards Spitzbergen before winter set in. The point of

the whole thing is that I intend to reach the Pole—I say I ought to get there in 150 days, but I have allowed 180 for the purpose. If I leave Franz Josef Land when the sun rises this would still leave (allowing 180 days for the journey), ten days of remaining light for me to travel towards Spitzbergen. At the expiration of this time I should put myself in winter quarters on the ice, kill the remaining reindeer for food and all the dogs not required for the rest of the homeward journey in the spring.

#### UNIVERSITY AND EDUCATIONAL NEWS.

PRESIDENT FAUNCE has announced that Mr. John D. Rockefeller has offered to give \$250,000 to Brown University if a million dollars is collected. It will be remembered that a million dollars has already been obtained for Brown University, of which Mr. Rockefeller gave \$250,000.

MRS. ANNA C. HOUGH, of Los Angeles, has offered \$25,000 to the University of Southern California in case an additional sum of \$75,000 be collected.

THE proprietors of the Baldwin Locomotive Works have subscribed \$25,000 towards a new engineering building for the University of Pennsylvania.

A BILL has just passed the Senate granting the North Dakota Agricultural College one-fifth mill on all taxable property, thus ensuring the continuous support of the Agricultural College in place of the uncertain biennial appropriation. Plans are being prepared for a new chemical laboratory and for a science hall to be built during the present year, also for a new barn to replace the one recently destroyed by fire; loss \$18,000, insurance \$12,000.

THE legislature of Wyoming has made an appropriation to complete the Science Hall of the University of Wyoming and to enlarge the campus. The new building will contain the geological museum and preparation rooms, the botanical and chemical laboratories and a large lecture room. A central heating plant for all the buildings will also be built.

BEGINNING with June of the present year the

University of Michigan will confer but one degree, that of bachelor of arts, on graduates from the undergraduate courses. The degrees of bachelor of philosophy, bachelor of science and bachelor of letters, which have been conferred for more than twenty years, are to be dropped. This change is brought about by the following resolution, which was passed by the literary faculty on February 18th and by the Board of Regents on February 21st:

Beginning in June of 1901, the degree of bachelor of arts shall be conferred on any student who has satisfied any one of the four sets of requirements for graduation now in force in the department of literature, science and the arts.

THE annual commemoration day exercises at Johns Hopkins University on February 22d, were unusually impressive, as they marked the quarter centennial of the founding of the university and the formal announcement of the resignation of President Daniel Coit Gilman. The address was made by the Hon. David Jayne Hill, Assistant Secretary of State and formerly president of the University of Rochester.

THE following memorial on the subject of Coopers Hill College has, as we learn from the *London Times*, been signed by some 374 leading men of science and others interested in education:

The correspondence regarding Coopers Hill College which has been published in the *Times* of January 3, 1901, which includes Sir Horace Walpole's letter to Colonel Otley of December 14, 1900, and Colonel Otley's letter of December 17, 1900, has caused a painful shock to those engaged in higher education throughout the United Kingdom, and to all who are interested in the training of engineers.

This correspondence relates to the sudden and arbitrary dismissal of able and distinguished scientific teachers who have been doing duty in the college for periods of from nine to thirty years, and the value of whose past services is at the same time officially recognized.

Such arbitrary dismissal is likely to affect adversely the cause of scientific teaching in the United Kingdom. It cannot fail to injure the future of the college. During the correspondence which has ensued it has become apparent that the teaching staff have no voice in the educational policy of the college and are not consulted when any change in the curriculum

is contemplated. We wish to draw the attention of the Secretary of State to this unsatisfactory state of affairs, which must militate against the success of the college as an educational center.

The sudden dismissal is action of a kind which we were not prepared to expect in any institution under the control of the British Government, and we think that the seven members of the staff who are required to retire at three months' notice are justified in asking for the inquiry into the working of the college for which they have petitioned in their memorial of December 27, 1900.

We therefore desire to express our hope that the Secretary of State for India will see his way to grant their request, and to suspend proceedings until an adequate inquiry by competent persons shall have been held.

In support of this memorial a deputation waited on Lord George Hamilton, Secretary of State for India, and addresses were made by Lord Kelvin, Lord Lister, Lord Raleigh, Sir Henry Roscoe, Professor H. E. Armstrong and Dr. G. J. Stoney. Lord George Hamilton made a reply defending the action of Colonel Otley and the Board of Visitors. He stated that the Board of Visitors recommended the action unanimously after careful examination and that it included Sir J. Wolfe-Barry, Sir William Preece and other competent scientific men. Pensions had been granted to members of the staff. Thus Professor McLeod, whose salary was £600, received a pension of £466 and a gratuity of £185. Sir George Hamilton deprecated the agitation through the newspapers and refused a further inquiry. The following letter from Lord Kelvin is published in the *Times* for February 13th.

*Sir*:—Lord George Hamilton's answer to the deputation regarding Coopers Hill, yesterday, was certainly far from satisfactory in respect to the dismissal of members of the scientific staff. It gave no reason to believe that any one of those threatened with dismissal had been found in any respect incompetent or negligent in the performance of duty. Evidence brought forward by myself showed that members of the Board of Visitors were astonished to hear of seven of the scientific teachers being threatened with dismissal by Sir Horace Walpole's letter of date December 14th, and believed that the recommendations referred to in the first paragraph of that letter did not imply the supersession of more than two of the teaching staff.

Nothing in Lord George Hamilton's statement was directed to show that the recommendations for amendment in the college teaching by the Board of Visitors could not have been carried out in a thoroughly satisfactory way by the president and his present teaching staff; with perhaps some moderate change in the allocation of their duties. I had suggested in my own statement of the objects of the deputation that the official prospectus issued on January 1, 1901, which promised to the public the present staff and the present allocation of subjects, should be allowed to hold good until the end of the present session. I have ventured respectfully to repeat the suggestion to-day to Lord George Hamilton, to whom I send a copy of the present letter.

Yours faithfully,

KELVIN.

15, EATON-PLACE, S. W., Feb. 13.

PRESIDENT MCKINLEY has appointed Capt. William Crosier, of the Ordinance Department, to succeed the late Col. Michie at West Point as professor of natural and experimental philosophy.

A CHAIR of irrigation has just been established in the University of California, and Professor Elwood Mead, of the United States Department of Agriculture, has been called to it. Professor Mead will not resign charge of the irrigation investigation of the United States, but will take his class into the field with him during the proper months, giving up two months to lectures at Berkeley.

ELMA CHANDLER, who has been an assistant in the botanical laboratory of the University of Michigan for the past four months, has accepted a position in the schools of Elgin, Ill.

MR. E. J. GARWOOD has been appointed to the Yates Goldsmid chair of geology and mineralogy at University College, London, in succession to Professor T. G. Bonuey.

At Christ's College, Cambridge University, Dr. Alfred Cort Haddon, formerly scholar of the college, university lecturer in ethnology and professor of zoology at the Royal College of Science, Dublin, has been elected to a junior fellowship.

THE Isaac Newton Studentship in physical astronomy, of Cambridge University, has been awarded to Mr. S. B. McLaren, of Trinity, third wrangler, 1900.



# SCIENCE

A WEEKLY JOURNAL DEVOTED TO THE ADVANCEMENT OF SCIENCE, PUBLISHING THE OFFICIAL NOTICES AND PROCEEDINGS OF THE AMERICAN ASSOCIATION FOR THE ADVANCEMENT OF SCIENCE.

EDITORIAL COMMITTEE: S. NEWCOMB, Mathematics; R. S. WOODWARD, Mechanics; E. C. PICKERING, Astronomy; T. C. MENDENHALL, Physics; R. H. THURSTON, Engineering; IRA REMSEN, Chemistry; JOSEPH LE CONTE, Geology; W. M. DAVIS, Physiography; HENRY F. OSBORN, Paleontology; W. K. BROOKS, C. HART MERRIAM, Zoology; S. H. SCUDDER, Entomology; C. E. BESSEY, N. L. BRITTON, Botany; C. S. MINOT, Embryology, Histology; H. P. BOWDITCH, Physiology; J. S. BILLINGS, Hygiene; WILLIAM H. WELCH, Pathology; J. McKEEN CATTELL, Psychology; J. W. POWELL, Anthropology.

FRIDAY, MARCH 8, 1901.

THE CASE OF PROFESSOR ROSS.

IN view of the interest excited in academic and scientific circles by the circumstances connected with the dismissal of Professor Ross from Stanford University, we publish in full the report of the committee of San Francisco Alumni and of a committee of economists. It will be observed that they come to exactly opposite conclusions. The alumni maintain that the dismissal of Professor Ross did not infringe on the right of free speech, while the economists side with Professor Ross in his claim that he is a martyr. It may seem ungracious for men of science, who have in the past suffered for truth's sake and have won the right to free scientific investigation, not to take sides with their colleagues in sociology and economics when they unite to urge the right of academic freedom. But we can not escape the conviction that the report of the three economists is a partisan rather than a judicial document.

A distinction must be made between freedom of speech and license of speech, between the right to investigate and the desirability of using a university as a point of vantage for propagandism. Our universities should be conservative—they should

## CONTENTS:

<i>The Case of Professor Ross</i> .....	361
<i>The Second Meeting of Naturalists at Chicago</i> : PROFESSOR CHAS. B. DAVENPORT.....	370
<i>Annual Meeting of the New York Academy of Sciences</i> : PROFESSOR RICHARD E. DODGE.....	379
<i>Recent Progress in Geodesy</i> : DR. JOHN FILLMORE HAYFORD.....	381
<i>The San Jose Scale</i> : PROFESSOR VERNON L. KELLOGG.....	383
<i>Scientific Books</i> :—	
<i>Scott's Studies in Fossil Botany</i> : PROFESSOR D. P. PENHALLOW. <i>Howard's Study of the Insect Fauna of Human Excrement</i> : PROFESSOR D. T. A. COCKERELL. <i>Books Received</i> .....	386
<i>Scientific Journals and Articles</i> .....	390
<i>Societies and Academies</i> :—	
<i>Anthropological Society of Washington</i> : DR. WALTER HOUGH. <i>Biological Society of Washington</i> : F. A. LUCAS. <i>The New York Section of the American Chemical Society</i> : DR. DURAND WOODMAN. <i>The Western Philosophical Association</i> .....	391
<i>Discussion and Correspondence</i> :—	
<i>Crocodylian Nomenclature</i> : DR. LEONHARD STEJNEGER.....	394
<i>Shorter Articles</i> :—	
<i>Stratigraphical Note</i> : DR. H. M. AMI. <i>The Influence of Light on the Length of the Hypocotyl in Indian Corn</i> : PROFESSOR E. S. GOFF.....	394
<i>Current Notes on Physiography</i> :—	
<i>Alleghany County, Maryland</i> ; <i>The Philippine Islands</i> ; <i>Overdepened Alpine Valleys</i> : PROFESSOR W. M. DAVIS.....	395
<i>Botanical Notes</i> :—	
<i>Elliot's Grasses</i> ; <i>Wood's Holl Botany</i> ; <i>New Species of North American Trees</i> ; <i>Selby's Handbook of Plant Diseases</i> : PROFESSOR CHARLES E. BESSEY.....	397
<i>Scientific Notes and News</i> .....	398
<i>University and Educational News</i> .....	400

MSS. intended for publication and books, etc., intended or review should be sent to the responsible editor, Professor J. McKeen Cattell, Garrison-on-Hudson, N. Y.

be careful in the appointment of professors and doubly careful in their dismissal. But the freedom of the individual must be subordinate to the freedom of the university. Academic freedom is the right to speak academically, and the university professor not only enjoys privileges, but also undertakes obligations.

There is no reason why as an individual Mr. Ross should not have supported by illustrated pamphlets and stump speeches free silver and Mr. Bryau in the campaign of 1896, but he should not have done so to the injury of the university. Professor Ross's methods of treating social problems may be illustrated by an extract from an article published by him the month of his dismissal. He writes in the *American Journal of Sociology*:

A predatory minority, then, presents itself at first as a governing class that by its toils, cares, and risks contrives to draw to itself the surplus goods of the governed. But, at a later stage of development, enjoyment and control are no longer vested in the same persons. The anatomy of a parasitic organization now shows at the center certain idle enjoyers surrounded by a great number of unproductive laborers who share in their spoil, and who in return busy themselves, as retainers, mercenaries, police, priests, teachers, or publicists, in intimidating, cajoling, or beguiling the exploited majority.

As President Jordan has stated, Professor Ross has many admirable qualities and his extravagances were long born with. If we understand the matter correctly President Jordan fully concurred with Mrs. Stanford in recognizing Professor Ross's disabilities, but wished to avoid the publicity which has been brought on the university. There is no doubt but that Professor Ross has shown his unfitness for an academic

position by the way he has acted since presenting his resignation to President Jordan. He said he resigned because "I am unwilling to become a cause of worry to Mrs. Stanford or of embarrassment to you." As soon as the resignation was accepted, which was done in as kind a way as possible, he does all he can to annoy Mrs. Stanford, to embarrass President Jordan and to injure the university.

The fact that Mrs. Stanford has recently given twenty-seven million dollars to the university and has retained for the present the rights that will later devolve on a board of trustees makes it somewhat easy to attack the university, but puts heavy responsibility on those who carry on such an attack. We are aware of the dangers due to the fact that many of our institutions are supported by rich men and to a certain extent controlled by them. But an impartial review of the history of university development in America shows that great tolerance has been allowed to university professors. The call of President Andrews and Professor Ross to a university supported by a State and controlled by a political party seems to be more dangerous for academic freedom than their dismissal from other universities. But on the whole there is no valid reason to criticize either our privately endowed or our State universities on the ground of suppression of legitimate freedom of speech.

REPORT OF THE COMMITTEE OF SAN FRANCISCO ALUMNI.

Your committee elected at the meeting of the association held November 20, 1900, to ascertain the confidential and other reasons

for Dr. Ross's enforced resignation begs leave to report :

That inasmuch as those interviewed, on both sides, have stipulated that the detailed information received should be treated as confidential, your committee is able to report only the ultimate facts. These are as follows :

First. Mrs. Stanford shared in the opinion general in university circles in 1896 that Dr. Ross's pamphlet entitled 'An Honest Dollar,' illustrated by political cartoons, signed by him as 'Professor of Economics in the Leland Stanford Jr. University,' and published and circulated by one of the political parties during the campaign of that year, was undignified in its form and manner of treatment, and that it was unwise in the point of the time and manner of its publication, because jeopardizing the University's right to a reputation for political non-partisanship. This incident, together with Dr. Ross's general conduct throughout that campaign, was deemed by Mrs. Stanford a symptom of unfitness for the responsible position of head of the economics department of the University.

Second. The justness of the criticism then expressed must be deemed to be conceded by Dr. Ross, since it has been admitted by him to your committee that he would not again pursue the same course under similar circumstances.

Third. Your committee is unable to find that Mrs. Stanford's objection arose because Dr. Ross's opinion differed from her own, since it is in evidence that she had at that time no opinion upon either side of the particular financial theories then in issue, and since she has not abandoned her objection to his conduct in the campaign of 1896, although his views upon the silver question thereafter radically changed.

Fourth. That from December, 1896, when Dr. Ross's chair was changed from economics to social science, until the time

of his dismissal his position in the University was probational.

Fifth. That the want of confidence engendered by the incidents of 1896 was never removed from Mrs. Stanford's mind, but was accentuated by other incidents impairing her faith in his good taste and discretion. Among these your committee has found : The use of slang in his public and classroom lectures, brought to her attention by friends present, and by lampoons in the college annuals, and reports that his classroom lectures contained references derogatory to her deceased husband.

Sixth. Your committee has been unable to find any evidence that Mrs. Stanford ever took exceptions to Dr. Ross's economic teachings.

Seventh. That her ultimate demand for his resignation was not due to opinions expressed in his speeches on 'Coolie Immigration' and the 'Twentieth Century City,' but was because she deemed that her original estimate had proved correct, and that he was redisplaying, after three years of trial, those qualities found objectionable in the instance of her original action.

In passing upon the question whether Mrs. Stanford's action involved any abridgment of the right of free speech, your committee has considered very carefully the published statement of Dr. Ross, and the proofs upon which it is founded. In deliberating upon these, however, your committee has been unable to escape the force of the following facts :

First. Dr. Ross was not in the position of one able to remain in the University who chose to resign, but of one who, willing to remain, was forced to resign. His statement, therefore, necessarily attempted to tell Mrs. Stanford's reasons for forcing him out and not his own for going; hence it cannot have the probative force of his own reasons for his own acts.

Second. Dr. Ross's statement ignores the

criticism arising from his conduct during the campaign of 1896; notwithstanding that he knew at the time of publishing his statement that it was one of the operative reasons for his dismissal.

Third. The established fact that Dr. Ross desired to remain at Stanford, notwithstanding Mrs. Stanford's criticism, is inconsistent with the theory that he really regarded those criticisms as involving any abridgment of his right of free speech.

Fourth. The admission of Dr. Ross to your committee that he would not regard a university rule against the participation in politics by a university professor of economics during the progress of a political campaign as impairing the proper right of academic freedom, disposes of his contention that the criticism of his conduct in 1896 is capable of that construction.

From the foregoing facts and upon the testimony as a whole, your committee concludes that the action of Mrs. Stanford in asking the dismissal of Dr. Ross involved no infringement of the right of free speech.

#### REPORT OF A COMMITTEE OF ECONOMISTS.

The committee, appointed at the meeting of the economists in Detroit, December 28, 1900, to enquire into the cause of the dismissal of Professor Ross from Leland Stanford University, has earnestly endeavored to learn the facts of the case. In addition to a careful examination of the statements made in the newspapers, we have asked Professor Jordau for a full and frank statement of the causes which led to Professor Ross's removal, and have obtained the replies printed in the appendix, in which Professor Jordan declines to give specific information in regard to them. We have also in our possession copies of letters bearing upon this case from various persons, including letters from Professor Ross, as well as from President Jordan, not only to Professor Ross, but also to others.

The following facts are, we believe, undisputed:

It is customary for professors in the Leland Stanford University to be reappointed early in May of each year. Professor Ross failed to receive his annual reappointment early in May, 1900. He was, however, reappointed on June 2d. On June 5th, he handed to President Jordan his resignation as follows:

*Dear Dr. Jordan:* I was sorry to learn from you a fortnight ago that Mrs. Stanford does not approve of me as an economist, and does not want me to remain here. It was a pleasure, however, to learn at the same time of the unqualified terms in which you had expressed to her your opinion of my work and your complete confidence in me as a teacher, a scientist and a man.

While I appreciate the steadfast support you have given me, I am unwilling to become a cause of worry to Mrs. Stanford or of embarrassment to you. I, therefore, beg leave to offer my resignation as professor of sociology, the same to take effect at the close of the academic year, 1900-1901.

This resignation was not acted on until November 12th, when it was accepted by President Jordan in the following letter:

I have waited till now in the hope that circumstances might arise which would lead you to a reconsideration. As this has not been the case, I, therefore, with great reluctance, accept your resignation, to take effect at your own convenience. In doing so I wish to express once more the high esteem in which your work, as a student and a teacher, as well as your character as a man, is held by all your colleagues.

On November 14th, Professor Ross authorized the publication in the newspapers of a statement setting forth the causes of his resignation and its acceptance, attributing it to a dissatisfaction felt by Mrs. Stanford with his expressions of opinion on questions of public policy, particularly Coolie Immigration and Municipal Ownership of public service corporations. On the following day, President Jordan wrote Professor Ross to the effect that, in view of his published statement, it was desirable that

his connection with the University should terminate immediately.

The evidence which we have been able to obtain indicates clearly also the following facts :

1. The causes which led to the dismissal of Professor Ross existed in May, 1900.

2. Although the dismissal of Professor Ross may have been occasioned by his published statement of November 14th, his resignation was practically forced by the wish of Mrs. Stanford. This fact is distinctly stated in the report of the Alumni Committee of Investigation which report apparently has the full endorsement of the University authorities.

3. Mrs. Stanford's wishes in the matter were expressed as early as May, 1900.

4. The delay in the acceptance of Professor Ross's resignation was due to an effort on the part of Professor Jordan to overcome Mrs. Stanford's objections.

The question in regard to which we have been called upon to express an opinion is : What were the reasons which led Mrs. Stanford to force Professor Ross's resignation ?

Two classes of reasons have been alleged :

1. Dissatisfaction on the part of Mrs. Stanford with Professor Ross's expressions of opinion on questions of economic policy, notably in regard to the free coinage of silver in the campaign of 1896, and more recently in regard to coolie immigration and municipal monopolies.

2. It has been asserted or suggested that Professor Ross had made statements before his classes reflecting upon Senator Stanford, that he had shown himself selfish and lacking in loyalty to the University, that he was erratic and frequently overstepped the bounds of academic propriety in the manner of giving expression to his opinions, that his publication of November 14th was a violation of confidence, and that

there are facts which, if disclosed, would reflect upon his personal character.

While it is, of course, impossible for us definitely to determine what facts, or reports of supposed facts, may have weighed with Mrs. Stanford, the evidence in the possession of the committee seems to justify the following conclusions :

1. There is no evidence to show that Professor Ross gave occasion for his dismissal by any defect in moral character. On the contrary, President Jordan states in his letter of February 7th to the committee : " No ground exists for any interpretation of his dismissal reflecting on his private character."

2. There is no evidence to show that Professor Ross gave occasion for his dismissal by incompetence. On the contrary, President Jordan stated in a letter of May, 1900, that he was a ' careful thinker and a patient investigator'; ' a constant source of strength' to the University and ' one of the best teachers, always just, moderate and fair.'

3. There is no evidence to show that Professor Ross gave occasion for his dismissal by any unfaithfulness in the discharge of his duties. On the contrary, President Jordan stated in a letter of May, 1900, that ' he has been most loyal, accepting extra work and all kinds of embarrassments without a word of complaint,' and that he was ' a wise, learned and noble man, one of the most loyal and devoted of all the band' at the University.

4. There is no evidence to show that in his published statement of November 14th Professor Ross violated any confidence reposed in him. On the contrary, in a letter of December 24th, President Jordan states : " I wish after conversation with Dr. Ross to withdraw anything I may have said implying that he had knowingly used confidential material, or in any other way violated personal proprieties in making his statement."

5. Concerning the point that Professor Ross gave occasion for his dismissal by remarks derogatory to Senator Stanford, your committee finds in a statement by Mr. C. F. Lummis, in *The Land of Sunshine*, dated Christmas, 1900, the following passage :

The precise words Professor Ross may have used I do not know, but I do know that he has stated in his classes in Stanford many things which his students understood to be reflections on Senator Stanford, and I know also that Mrs. Stanford firmly believes that he did slur her husband's memory.

In *The Independent* of February 7, 1901, Mr. Lummis repeats this charge, quoting Mrs. Stanford's reasons for his dismissal :  
' \* \* \* He has called my husband a thief.'

The committee also finds that President Jordan in a letter of November 16, 1900, states :

Mr. Keesling informs me that he and others of the alumni have heard you in your classes condemn the means by which Mr. Stanford became rich in such a way as to make it clearly a personal reference, and that some time last year Mrs. Stanford was told this by a prominent alumnus, Mr. Crothers, if I understood correctly.

In a letter of the next day, however, President Jordan retracts this by saying :  
"Mr. Crothers tells me that he has never mentioned the matter in question to Mrs. Stanford. I was not sure that I understood my informant to say so."

Professor Ross, moreover, at the time, unqualifiedly denied all such charges, and insisted that statements to this effect were 'a thorough-paced falsehood and a disingenuous attempt to befog the real issue.' In another place he says : "The charge from any quarter that I have ever made remarks derogatory to the character of Senator Stanford is false—absolutely without foundation." In a subsequent letter he states : "I have never referred in a derogatory way to Senator Stanford, nor have I reflected upon the manner in which he accumulated his fortune. Both my sincere respect

for the Senator and my sense of the proprieties of my position forbade anything of the kind."

Moreover, that this charge could not have been a determining cause in President Jordan's acceptance of Professor Ross's resignation, is shown by the fact that in a letter of November 16th, two days after his dismissal, President Jordan says, in reference to these charges : "I never heard anything of the sort before."

6. There is no evidence to show that in the opinion of the President of the University, Professor Ross, in his utterances on the silver question, on coolie immigration, or on municipal ownership, overstepped the limits of the professorial propriety. On the contrary, President Jordan stated in May, 1900, that his remarks on coolie immigration and on municipal ownership were in accord with the drift of public sentiment on those subjects, and that even on the silver question 'he never stepped outside of the recognized rights of a professor.'

7. There is evidence to show :

(a) That Mrs. Stanford's objections to Professor Ross were due, in part at all events, to his former attitude on the silver question, and to his utterances on coolie immigration and on municipal ownership; and

(b) That while the dissatisfaction of Mrs. Stanford due to his former attitude on the silver question antedated his utterances on coolie immigration and municipal ownership, her dissatisfaction was greatly increased by these utterances.

As to (a). This is shown by the fact that President Jordan at first attempted to deter Mrs. Stanford from taking any action for such reasons, stating in a letter of May, 1900 : "I feel sure that if his critics would come forth and make their complaints to me in manly fashion I could convince any of them that they have no real ground for complaint." President Jordan, moreover,

intimated that to dismiss him for such reasons would be improper in the extreme, for 'no graver charge can be made against a University than that it denies its professors freedom of speech.'

As to (b). This is shown by the fact that not until immediately after the delivery of the coolie immigration speech did Mrs. Stanford force Professor Ross's resignation as well as by the fact that in a letter of June, 1900, President Jordan stated: "The matter of immigration she (Mrs. Stanford) takes most seriously."

In the same letter, while Mrs. Stanford's objection is declared to be due to the fact that the reputation of the University for serious conservatism is impaired by the hasty acceptance of social and political fads, it is added, that these 'local criticisms' which weighed with Mrs. Stanford 'unfortunately are based on chance matters and *obiter dicta* not at all upon your serious work.'

We have not deemed it wise to publish in full the letters upon which we have based our conclusions, but we stand ready to publish them if such a course is necessary to establish the truth in this matter.

We are aware that, owing to the failure of President Jordan to give definite replies to all our questions, there may be important facts with which we are unacquainted. On the other hand, we cannot but feel that a refusal to furnish specific information in a case of such importance—in which it is charged that the freedom of speech is at stake—is itself a fact of significance, which, to say the least, is much to be regretted.

All of which is respectfully submitted.

EDWIN R. A. SELIGMAN, Professor of Political Economy and Finance, Columbia University.

HENRY W. FARNAM, Professor of Political Economy, Yale University.

HENRY B. GARDNER, Professor of Political Economy, Brown University.

February 20, 1901.

The undersigned have examined the evidence submitted by the above committee, and believe that it justifies the conclusions which they have drawn.

HORACE WHITE, Editor of the *Evening Post*, New York.

JOHN B. CLARK, Columbia University.

HENRY C. ADAMS, University of Michigan.

FRANK W. TAUSSIG, Harvard University.

RICHARD T. ELY, University of Wisconsin.

SIMON N. PATTEN, University of Pennsylvania.

RICHMOND MAYO-SMITH, Columbia University.

JOHN C. SCHWAB, Yale University.

SIDNEY SHERWOOD, Johns Hopkins University.

FRANKLIN H. GIDDINGS, Columbia University.

WILLIAM J. ASHLEY, Harvard University.

CHARLES H. HULL, Cornell University.

DAVIS R. DEWEY, Massachusetts Institute of Technology.

HENRY C. EMERY, Yale University.

HENRY R. SEAGER, University of Pennsylvania.

#### APPENDIX.

DECEMBER, 30, 1900.

PRESIDENT JORDAN,

*Leland Stanford Junior University,  
Palo Alto, Cal.*

Dear Sir: In behalf of a considerable number of economists, recently assembled in Detroit and much interested in the resignation of Professor Ross from the Leland Stanford University, we venture to address you on the subject. We understand from the public prints as well as from other sources, that Professor Ross was asked to sever his connection with the University owing to the loss of confidence in him by Mrs. Stanford, and that this loss of confidence was due primarily to the opinions expressed by him in a lecture on the subject

of coolie immigration as well as to incidental remarks on the problems of municipal ownership.

May we inquire whether, as it has been alleged in some of the Eastern journals, there are any other reasons than those mentioned for the resignation of Professor Ross, and may we hope that, if such other reasons exist, you may be disposed to communicate them to us? Many university men have been led to believe that in this case the legitimate freedom of thought without which no progress in science is possible has been discouraged. As this is a matter which concerns not a single university, but the interests of scholarship all over the country, we believe that we are not overstepping the bounds of propriety in asking information which will enable university teachers to form a just opinion on the merits of the case.

We desire to add that Dr. Ross is neither the instigator of this letter nor aware of its contents. Very truly yours,

EDWIN R. A. SELIGMAN,  
Columbia University.

HENRY W. FARNAM,  
Yale University.

HENRY B. GARDNER,  
Brown University.

LELAND STANFORD JUNIOR UNIVERSITY,  
STANFORD UNIVERSITY, Cal.,  
January 7, 1901.

PROFESSOR EDWIN R. A. SELIGMAN,  
Columbia University, New York City.

*My Dear Sir:* In response to your kind letter of December 30th, permit me to say that in view of the importance of the matter I have referred the contents of your letter to a committee of three of our professors, Vice-President J. C. Branner, Dr. J. M. Stillman and Dr. C. H. Gilbert. They are in possession of the facts and are at liberty to answer any questions which your committee may desire to ask. For reasons

which will readily appear it has not been deemed advisable for us to state the reasons why Dr. Ross was dismissed. His statement to the press does not assign any of the true reasons. Very truly yours,

DAVID JORDAN,  
President.

LELAND STANFORD JUNIOR UNIVERSITY,  
January 14, 1901.

PROFESSOR EDWIN R. A. SELIGMAN,  
PROFESSOR HENRY W. FARNAM,  
PROFESSOR HENRY B. GARDNER.

*Dear Sirs:* Your letter of December 30th addressed to President Jordan has been referred by him to us for reply.

In your letter you say: "We understand from the public prints as well as from other sources that Professor Ross was asked to sever his connection with the University owing to loss of confidence in him by Mrs. Stanford, and that this loss of confidence was due primarily to the opinions expressed by him in a lecture on the subject of coolie immigration as well as to incidental remarks on the problem of municipal ownership."

In reply we beg to say that the dissatisfaction of the University management with Professor Ross antedated his utterances on the topics you refer to. His removal was not due primarily to what he published, said or thought in regard to coolie immigration or in regard to municipal ownership.

We can assure you furthermore that in our opinion his removal cannot be interpreted as an interference with freedom of speech or thought within the proper and reasonable meaning of that expression.

These statements are made with a full knowledge of the facts of the case.

Very truly yours,  
J. C. BRANNER,  
J. M. STILLMAN,  
C. H. GILBERT.



January 30, 1901.

PRESIDENT JORDAN,

*Leland Stanford University,  
Palo Alto., California.*

Dear Sir: We beg to acknowledge receipt of your letter of January 7th, as well as the letter of your committee of three, of January 14th.

You state in your letter that you are ready to answer all questions. May we venture to put the following:

1. In the committee's letter of January 14th, it is stated that the 'dissatisfaction of the University Management with Professor Ross antedated his utterances on the topics you refer to.' How can this dissatisfaction of the University management be made to agree with the statement of the President, speaking for himself and the faculty, and quoted in the public prints of November 14th as follows:

*a.*—Extract from a letter from Professor Ross to President Jordan: "It was a pleasure, however, to learn from you of the unqualified terms in which you have expressed to her (Mrs. Stanford) your high opinion of my work and your complete confidence in me as a teacher, a scientist, and a man."

*b.*—Quotation from a letter from President Jordan to Professor Ross: "I wish to express once more the high esteem in which your work as a student and a teacher, as well as your character as a man, is held by your colleagues."

2. In your letter of January 7th, you say: "His (Professor Ross's) statement to the press does not assign any of the true reasons." If the speeches on coolie immigration and municipal ownership did not constitute any of the reasons for his dismissal, why was the dissatisfaction, which in your judgment antedated these speeches, not manifested until immediately after the delivery of the same? Why was the re-appointment so dubious and tardy while Professor Ross had no intimation of his possible non-appointment till May 18th?

3. In saying that Professor Ross does not assign any of the true reasons for his dis-

missal, do we understand you to deny the truth of Professor Ross's published statement, containing quotations from your remarks to him:

*a.*—That "he (Dr. Jordan) had heard from her (Mrs. Stanford) just after my address on coolie immigration."

*b.*—That "quite unexpectedly to him (President Jordan) Mrs. Stanford had shown herself greatly displeased with me (Professor Ross)."

*c.*—That "he (President Jordan) was profoundly distressed at the idea of dismissing a scientist for utterances within the scientist's own field."

*d.*—That "he (President Jordan) made earnest representations to Mrs. Stanford."

4. What are the real reasons for the dismissal of Dr. Ross? In your letter of January 7th, you say: "For reasons which will readily appear, it has not been deemed advisable for us to state the reasons why Dr. Ross was dismissed." Will you pardon us for saying that we fail readily to recognize any such reasons? If the reasons are that you fear to injure the personal reputation of Professor Ross, may we venture to suggest that nothing that you could do would be more calculated to injure Dr. Ross than the insinuation that there are some secret reasons which cannot be divulged. It is just because some such innuendoes have been printed in the papers that our committee addressed itself to you, in order to ascertain the true state of affairs.

While we regret to prolong this correspondence, you will readily see that unless we can give the members of the American Economic Association some explicit reasons for Professor Ross's dismissal other than those assigned by him, they will naturally adhere to the opinion based upon the statements first made in the public press. A mere denial of the truth of the statements made by him will not be apt to satisfy gentlemen who are not willing to believe that any of the parties concerned in the question would intentionally make a false statement, and facts alone will enable them

to reconcile assertions that would otherwise seem contradictory. It is for that reason that we venture again to express the hope that a more explicit answer may be given to our questions.

Very truly yours,

EDWIN R. A. SELIGMAN,  
HENRY W. FARNAM,  
HENRY B. GARDNER.

LELAND STANFORD UNIVERSITY, CAL.,  
February 7, 1901.

PROFESSOR EDWIN R. A. SELIGMAN,  
PROFESSOR HENRY W. FARNAM,  
PROFESSOR HENRY B. GARDNER.

*Gentlemen:* Your letter of January 30th is at hand asking further information as to the reasons for the dismissal of Professor Ross. When I expressed my willingness to answer further questions I did not mean to indicate that I would enter into any circumstantial description of events leading to or following from Professor Ross's dismissal. Nor do I consider it expedient or proper to go into a discussion of extracts from my letters or conversations or of my statements or alleged statements, or those of others, as published in the newspapers. There are, however, certain assurances which it is within the privilege of the public to ask, and which it is my desire to furnish, that the public may be assisted in forming a judgment as to the position of the University upon important questions. It seems to me that I shall answer these questions best by certain plain statements which involve the important facts concerning the University. It will be necessary for you to assume my knowledge of all the facts, also that the interpretation herewith presented is authoritative from the University standpoint.

First. Professor Ross was not dismissed on account of his views on Oriental immigration nor on account of his opinion on any economic question.

Second. Professor Ross was dismissed

because in the judgment of the University authorities he was not the proper man for the place he held. The responsibility for the correctness of this judgment belongs to the University authorities and to them alone.

Third. No ground exists for any interpretation of his dismissal reflecting on his private character, of which your letter seems to imply a fear.

Fourth. The judgment that Professor Ross was not the proper man for the place he held is not incompatible with my appreciation of many good qualities he possesses, nor with my wishes or efforts at any time to further his prospects. I have been neither ignorant of his professional shortcomings nor inappreciative of his good qualities. Of such appreciation Professor Ross has himself adduced several expressions from my letters.

In the hope that you may find in the above a substantial answer to the questions involved in your inquiries, I remain,

Very truly yours,

DAVID S. JORDAN.

*THE SECOND MEETING OF NATURALISTS AT CHICAGO.*

THE committee appointed by the meeting of 1899 issued a call for a second meeting of Naturalists at Chicago, December 27th and 28th. About one hundred naturalists were in attendance or three times the number present last year. Among those present in addition to the Chicago Naturalists were Messrs. Folsom, Hart, Holferty, Mills and Frank Smith of University of Illinois; Professors Loey and Charles Hill of Northwestern University; Needham of Lake Forest; Atherton, Birge, Juday, and Timberlake of Wisconsin; Densmore, and Grant Smith of Beloit; Lee, MacMillan and Nachtrieb of Minnesota; Osborn of Hamline; Nutting and Shimek of Iowa; Kelly of Cornell College; Thorn of Missouri; Ward of

Nebraska; Dr. Ida Hyde of Kansas; Rameley of Colorado; Eigenmann, King, Mottier and Slonaker of Indiana; Tower of Antioch College; Williams of Miami University; Grover of Oberlin; Guyer of Cincinnati; Williamson of Vanderbilt; Copeland and Parke of West Virginia; Holmes, Jennings and Pearl of Ann Arbor; Clark of Olivet; Bensley and Jeffrey of Toronto. The attendance was drawn from a much larger territory than last year and included proportionately far more botanists. Professor Nutting presided at Thursday's session and Professor Birge at Friday's.

All day Thursday papers were read at a general session and in the evening a dinner attended by forty-one persons was held at the Quadrangle Club. Friday morning was devoted to a discussion on 'State Natural History Surveys; methods, results and co-operation.' Professors Birge, Nachtrieb and Frank Smith opened the discussion in which Professors Eigenmann, MacMillan, Nutting, Ward, Cowles, Hartzell and others also took part. The papers of Professors Birge, Nachtrieb and Smith will appear in SCIENCE. As a result of an eloquent plea for higher ideals of university and college administrators with reference to research, made by Professor Loeb at the dinner, the following committee on the relations of colleges to research was appointed: Professors Loeb, Cowles, H. M. Kelly, MacMillan, Nachtrieb, Nutting and Ward. As the relation of the Naturalists' meeting at Chicago to the American Society of Naturalists was still undefined no definite organization was effected but the following committee on a meeting in 1901 was appointed: Professor S. A. Forbes, University of Illinois, Chairman; W. A. Loey, Northwestern University; Conway MacMillan, University of Minnesota; D. M. Mottier, University of Indiana and C. B. Davenport, University of Chicago; the last as Secretary.

On Friday afternoon separate sections in botany and zoology were organized for the reading of papers. Abstracts of the papers read at the meeting follow:

*On the Absorption of Water by Frogs:* HENRY H. DONALDSON.

A group of frogs that had been dried for hours was weighed and it was shown that through exposure to the air of the laboratory in a dry dish, they had lost 14 per cent. of their body weight. These frogs were at once placed in a dish containing water about 1 cm. deep, and in 24 hours had regained nearly the entire weight lost by drying. This gain in weight was attributed to the absorption of water through the skin, and the fact that frogs never took water by the mouth was emphasized. Both the loss and the absorption of water are more rapid during the summer season than in the period of hibernation. The general influence of this capacity of the frog to lose and gain water readily was pointed out, and the evidence adduced that the amount of water normal to the spinal cord varied with the season of the year, being high from the last of May to the first of July, a season during which growth probably occurred, and gradually diminishing from this period to the time of hibernation.

*Heterogeneous Induction in Tadpoles:* E. B. COPELAND.

In water deficient in oxygen tadpoles swim like fish, with their noses to the surface. This behavior, though, is not a direct search for oxygen, but a manifestation of negative geotaxis. If the water is covered with oil they stick their noses into it and keep them there, or in full and closed glass vessels they keep their noses against the glass above. When in the greatest need of oxygen they remain, as under ordinary conditions, negatively phototactic. Their behavior with reference to gravity is not the result of their own experience.

*The Reactions of Hydra to the Electric Current*: RAYMOND PEARL.

An expanded hydra with the long axis of the body at right angles to the direction of the current becomes oriented with the head towards the anode shortly after the current is made. This orientation is brought about by a contraction at a point just above the foot on the anode side of the body. The bending of the body at this point is very slow, but continues until the long axis is parallel to the direction of the current and the head is towards the anode, *i. e.*, until the Hydra is oriented. The details in the mechanism of this orientation are modified with increasing intensity of current, but the essential factor, namely, contraction on the anode side, is constant except when the very strongest currents are used. On making a current of such strength as practically to kill the hydra, immediately there occurs a slight muscular spasm on the *kathode* side of the body. If at the time of making the long axis of the body is already parallel to the direction of the current and the head is towards the anode, the animal contracts immediately and violently, while in the opposite position there is no immediate contraction. The contraction phenomena of the tentacles are different from those of the body as a whole.

*The Effect of some Climatic Factors upon the Color and Color-patterns of Insects*: W. L. TOWER.

The effect upon variations of color and color patterns of the environmental factors, temperature, moisture, food and light has been investigated experimentally during the past two years. Coleoptera and Lepidoptera have been used and have been subjected to the conditions of the experiments throughout the life cycle. The results represent more nearly the effects these factors produce as they act in nature, than when applied at one stage alone, *i. e.*, pupal.

The most extensive work has been done with *Leptinotarra decem-lineata* Say, and these results will be published soon.

*Additional Remarks on Cave Salamanders*: C.

H. EIGENMANN.

The types of a new cave salamander from Missouri were exhibited, also a specimen of the bleached cave salamander, *Typhlotriton* from Marble Cave, Mo. The latter had been kept in the light for a few weeks and showed a marked increase of pigment in its chromatophores. The amount of bleaching in cave animals is directly proportional to the degree of degeneration reached by the eye. Whether there is any connection between the two is under investigation. Epigeal species, if living in caves for any length of time, become bleached. The presence or absence of color is, then, due in the first instance to the environment. The cave fishes of Indiana no longer respond to the change in their environment, as the salamander does, and even the young of the cave fishes, if reared in the light, do not take on color. The bleached condition has become hereditary in their character. In the establishment of the bleached condition, which in the first case is an individually acquired character in the hereditary mechanism, we have an instance of the transmission of the direct effect of environment.

*The Relation between Base-leveling and Plant*

*Distribution*: HENRY C. COWLES.

The local distribution of plants depends largely upon the character of the topography. The topography constantly undergoes well-known changes, hence the vegetation must change. In other words the ecological study of plants and plant societies should be based on dynamical principles. The growth of a river well illustrates these principles; first, there is a xerophytic gully, then a ravine, whose slopes soon become mesophytic. As the valley widens the

slopes become xerophytic. In the valley itself a flood plain eventually develops which has at first a hydrophytic and finally a mesophytic flora. There are local digressions from this history, but in general it may be said that mesophytic flood plain vegetation is ever on the increase and may be regarded as the ultimate type.

*Base-leveling and its Faunal Significance, with Illustrations from Southeastern United States:*  
CHARLES C. ADAMS.

Attention was called to the necessity of correlating the influences of the base-leveling processes with the distribution of habitats, and especially the importance of a knowledge of river histories in the study of fresh-water faunas. An outline was given to illustrate the principles involved in the reduction of an elevated country to sea-level. By the growth of valleys there is a decrease of uplands, a premium being placed upon those forms whose habitat is increasing in area; thus tension lines are produced. There is a definite succession of forms advancing up a valley, and thus in descending a river one may find a rough recapitulation of the types of faunas which occupy a stream during its ideal history. With a reduction of divides, rapid water, upland faunas are the first to mix. Attention was attracted to the importance of the base-leveling factors about two years ago, in connection with the studies on the *Pleuroceridae*. The anomalous distribution of this family in the Tennessee and Coosa-Alabama river systems was at once explained upon learning, at that time, that formerly the Tennessee river from Chattanooga flowed to the Gulf via the Coosa-Alabama system. Valley faunas are isolated by uplands and *vice versa*. The Cumberland Plateau and the Smoky Mountains have been isolated by the Tennessee valley and consequently have peculiarities in their fauna. The land shells, according to Pils-

bry, of the Cumberland Plateau have about 20 characteristic species or varieties and the Smoky Mountains about 25. The geologists (Woodworth) have had a better appreciation of these factors. Students of distribution should give more importance to habitat as a dynamical factor in their study of faunal problems. This will lead to the study of faunas in a comparative and genetic way.

*Demonstration of certain Features in the Reactions of Infusoria:* H. S. JENNINGS.

Demonstrations by means of the projecting microscope and stereopticon, of the reactions of unicellular organisms toward carbon dioxide and various other chemicals. The demonstrations were essentially the same as those described in SCIENCE for January 11, 1901, pp. 74, 75.

*On certain Methods by which Organisms Regulate their Movements with Relation to the Position of External Objects acting as Stimuli:* H. S. JENNINGS and RAYMOND PEARL.

The paper showed the biological significance of the revolution on the long axis, with the resulting spiral path, which is a feature of the swimming of many lower organisms. These organisms usually tend to swerve toward one side, and thus to swim in circles; the revolution on the long axis converts this circular path into a spiral one, and thus permits an unsymmetrical organism to follow a course which is in effect a straight one. The paper gave an account of very simple mechanisms for turning to or from a source of stimulus in a number of organisms, Rotifera, ctenophores, flatworms, and the earthworm.

*Experiments in Artificial Parthenogenesis:* J. LOEB. Already described in SCIENCE.

*Cenogametes:* DR. B. M. DAVIS.

The peculiar multinucleate gametes of the *Phycomyces* were considered and the results of Dr. Stevens' studies and the writer's on *Albugo* were described. These

peculiar structures (Cœnogametes) are likely to be found far more generally in this group of fungi than has been imagined, and the subject takes on considerable biological interest.

The fusion of multinucleate gametes results in the pairing of the sexual nuclei and consequent union, two by two, giving about half as many fusion products as the original number of sexual nuclei. The phenomenon recalls the conjugation of swarm spores in water outside of the parent gametangium, the difference being that here the sexual elements are retained in the parent structure.

The origin of these cœnogametes is uncertain. It was suggested that they may have come from a much simpler condition of sexual organs than has been supposed. They are possibly derived from a gametangium of the lowly type presented in several algal groups where motile gametes are discharged into water. An alternative hypothesis demands that the behavior is exceptional and derived from a condition of heterogamy. But a serious objection will be raised to such a view if the cœnogametes, as seems likely, are found to be far from exceptional among the *Phycomycetes*.

*Early Development in certain Hybrid Species.*

W. J. MOENKHAUS.

In more than 20 crosses among fishes, there was not a single failure of impregnation, although some of them were between species of different orders. The per cent. of impregnation ranged from 1 to 95. The highest per cent. may be between the most distantly related species. Eggs normally impregnated complete the segmentation stages. Two crosses and their reciprocals largely went to closure of the blastopore with the main axis of the embryo apparently normally formed. Only the closely related species went far enough to hatch. The cross between brook trout ♀ and lake trout re-

sulted in 'fingerlings,' a large per cent. of which had the caudal peduncle aborted and many had the anal fin wanting.

The rate of development was in all cases that of the egg species or slower. The conjugation of the pronuclei is normal. In the first cleavage spindle of the cross between *Fundulus heteroclitus* ♀ and *Menidia notata* the ♀ chromosomes appear as long, slightly wavy rods, and the ♂ chromosomes as short, comma-shaped rods. This difference is maintained to the 16-celled stage, as far as they have been followed. In the cross between *Fundulus heteroclitus* ♀ and *Ctenolabrus adspersus* the ♂ chromosomes are scattered along the spindles. This condition obtains as far as the third cleavage and there is some evidence that some or all of the ♂ chromatin may be lost in the course of development.

*Abnormalities on the Horny Plates of the Turtle, Chrysemys marginata:* S. E. MEEK. (Will appear in the *American Naturalist*.)

*Variation in the Madreporic Body and Stone Canal of Asterias vulgaris:* GERTRUDE C. DAVENPORT.

A number of cases of multiple madreporic plates were observed in the starfish *Asterias vulgaris*, of Cold Spring Harbor. This multiplicity may occur either in one interradius, in several of them, or in all. Thus three plates were observed in one and the same interradius and in another case five. In one case five plates were observed in one interradius, and one in another of the same starfish. A six-rayed individual had one madreporic plate in each of the six interradii. When only one madreporic plate is present it may be lobed or partially divided by cross seams into 2, 3, 4, 5 and 6 parts.

The multiplicity of plates may or may not be accompanied by a multiplicity of stone canals. A group of four plates had only one canal, while one of five had two.

In European starfishes multiple madreporic plates occur in those forms that multiply by self division. Hence they are the result of regeneration. This multiplicity is more frequent in starfishes, normally or abnormally, with more than five rays. The Cold Spring Harbor starfishes very freely cast off their arms when handled. Do they practice autotomy in nature?

*Some Variations in Lucanus placidus, Statistically Examined:* ELIZABETH B. MEEK.

The mandibles of the stag beetles, especially in the male sex, are extraordinarily developed and armed with teeth or projections. These vary greatly in different species and in different individuals of the same species; correlative with these differences there are extreme differences in body length. In some species the variations are so great that dimorphism exists, resulting in a division into high and low males. A quantitative expression for these differences in size and form in *Lucanus placidus*, was sought, with the following results: The average body length is .4 mm. greater in the male than in the female and the coefficient of variation is greater; this is also true of the mandibles where the average length is 2 mm. greater in male than female. The coefficient of correlation between length of body and length of mandible is .2 greater in the male than female. The teeth on the mandibles may be termed primary and secondary. A large or primary tooth is invariably present on the mandibles of both male and female, but there is great variation in position, form and number of the secondary teeth even on the same pair of mandibles, as one cutting edge may have only one while the opposite has any number of secondary teeth. Average number of teeth on mandible of male is 4 more than on female. There is a correlation between the number of teeth and length of mandible which is .2 mm. higher

in males than females. Number of spines on fore tibiæ varies from 6 to 11, with an average of 4 more upon tibiæ of males than females.

It is thus found, as should be expected that variation is greater in the males than females. Also that there is no dimorphism in length of bodies, mandibles nor tibiæ. There is positive skewness in the body lengths and negative in the mandibles, but just what this may mean I am, at present, unprepared to say, as this study is preliminary to a more complete one of the variation and distribution of representative Lucanidæ in the United States.

*The Place-mode of Daphnia pulex, for Cold Spring Harbor, Long Island:* H. M. KELLY.

The results of measurements of many organs on a large number of individuals.

*Contributions to the Biological Interpretation of Skew Variation:* C. B. DAVENPORT.

The paper presented conclusions based on a study of many cases of skew variation in organisms.

*The Genetic Development of the Forests of Northern Michigan:* H. N. WHITFORD.

This article will appear in full in an early issue of the *Botanical Gazette*. The factors controlling the distribution of plant societies and formations are divided into three groups—climatical, ecological and historical. These are discussed with special reference to their effects on forests.

A succession of plant societies on four sets of physiographic formations is recognized. In each instance the climax society is the deciduous forest.

In the sand series the stages are beach, heath, coniferous forest and deciduous forest. Here a controlling factor is the accumulation of humus. The pre-Cambrian rocks of the Marquette region offer an admirable field for the stages in the life-history of rock societies. Here not only humus, but inorganic soil, has to be accu-

mulated before the deciduous forest appears. Swamp series and clay soil series show similar stages before the climax deciduous forest society is made possible. In every instance there must be a coniferous or poplar-birch forest before the maple-beech deciduous forest, for in that way only can shade conditions be obtained for the protection of maple and beech seedlings.

*Application of the Quantitative Method to the Dynamical Study of Plant Societies:* HENRY C. COWLES.

The vegetation in the vicinity of Chicago is being systematically mapped from an ecological standpoint, topographic maps being used as a basis for work. By means of accurate mapping and recording of field observations at selected points, it is hoped that sets of data may be obtained showing the rapidity of encroachment of one plant society upon another. By means of photographs taken at one-year intervals considerable change has been found in the dune region, and this suggests the desirability of a similar study for other plant societies.

*An Anatomical Classification of Vascular Plants:* E. C. JEFFREY.

The use of the skeleton in the phylogenetic study of plants has been almost entirely neglected. In recent years paleobotanists have done something to remedy this defect, but they have been without the important aid furnished by the study of development. The present article, illustrated by a large number of photographs of the vascular skeleton of living and fossil plants, and especially the developing skeleton of extant groups of plants, is intended to show that there are a number of absolutely constant and characteristic anatomical criteria.

*Stomata of some Liliaceæ:* E. P. COPELAND.

The stomata of Liliaceæ are very diverse in structure, but most of them are well built to open and shut. Many of them (*Uvularia*,

*Smilacina*, *Polygonatum*, *Dracænam*, *Smilax*, et al.) are so circular in surface view that an increase in turgescence would not open the pore if the walls at the ends of the guard cells were not much more rigid than those of their backs. This rigidity is secured by special local thickening, or by the mode of insertion of the walls of adjacent cells. The stomata of *Medeola* are also circular, but the backs are strengthened by folds in the wall. The pore opens by an increase in the depth of the guard cells, i. e., at right angles to the surface of the leaf. It is a perfect development of what has been called the Mucinus type of stoma.

*Methods of Plankton Measurement:* JACOB REIGHARD and HENRY B. WARD.

The paper presented a brief review of methods introduced by Hensen, and used by a number of observers for computing the amount of plankton obtained by hauls of a vertical net, and of the calculations on theoretical and experimental bases given by Hensen, Reighard and others for determining the coefficient of the net, i. e., the fraction of the column of water which actually passes through it. The authors propose to determine the coefficient by actually measuring the amount of water passing the mouth of the net. This is to be accomplished by means of a three-vane meter suspended in the axis of the net opening a short distance inside its upper rim. By means of an electric pen register the revolutions of meter are recorded on a tape, and parallel to them, both the starting and stopping signals, and the time record from the chronometer, from which it is possible to calculate the number of revolutions in the time of the haul, or the time or revolutions in any desired fraction of the haul. The difficulties and errors in the management of the apparatus were discussed, together with the means for detecting them. The rating of the meter by two different methods was



also considered, and the coefficient of the net shown in the plottings of the rating experiments. Experiments without a meter were also used to demonstrate that the efficiency of Hensen's net had not been diminished, but rather increased by the addition of the brass cylinder and meter at the net opening.

As prominent factors in determining the efficiency of the net were mentioned the size of the orifice, and the ratio between the area of the orifice and the area of the filtering surface. Various details in improvements of apparatus were mentioned, and the laboratory of the United States Fish Commission at Put-in-Bay, together with the steamer and apparatus used and the records obtained, were illustrated from lantern slides.

*A New Method of Reproduction in Tubularian Hydroids*: C. C. NUTTING.

The medusæ of *Hybocodon prolifer* were found to be reproducing by means of actinules formed on the manubrium. The process of development of the actinules was described, and the intergradation between this process and the production of actinules in the gonophores of ordinary tubularians was traced through a series of forms including *Tubularia spectabilis* (Agassiz), *Tubularia cathouyi* Ag., and *Corymorpha pendula* Ag. The paper was illustrated by charts prepared by the author.

*Remarks on the Distribution of Hydroida on the North Pacific Coast*: C. C. NUTTING.

The basis of this paper was a study of the Hydroida of the Harriman Alaska Expedition. The division of the Pacific Coast fauna made by Dall in 1876 was found to be untenable in the light of our present distribution of the hydroids. It was shown that there was no marked differentiation between his Aleutian and Oregonian faunæ, on the one hand, and that the Oregonian fauna does not extend to Monterey, California,

on the other. The facts seem to indicate a division between an Alaskan and a Californian province just south of Puget Sound. The author pointed out that this arrangement was only tentative, and that the distribution of other groups of marine animals of that region would be necessary before any conclusive statement could be made.

*The Holothurians of the Pacific Coast of North America*: H. L. CLARK.

The examination of 52 specimens, representing 11 species, from Pacific Grove, California, has thrown considerable light on the holothurians of the Pacific Coast. The occurrence of three species (*Synapta inhærens*, *Cucumaria calcigera*, *Psolus squamatus*) which also occur on the Atlantic Coast would seem to indicate that these species either are now, or have been, circumpolar forms with southward prolongations of their range on the east and west sides of the continent. The most interesting feature of the collection is the occurrence of three new species, all of which show some peculiarity in the manner of caring for the young. A small, black *Cucumaria* broods its eggs and young, while a small, red *Thyone* is viviparous, the young being found in the body cavity of the mother, as in *Synapta vivipara*. The most remarkable species, however, is the representative of a new genus, *Thyonepsolus*, which is perfectly intermediate in character between *Thyone* and *Psolus*, having the ventral surface flattened to a creeping sole covered by a thin skin, while the dorsal surface is convex and soft. On the sole the feet are in three longitudinal rows, while dorsally they are numerous and irregularly scattered. The young are carried on the back of the mother, partially imbedded in the thick, soft skin.

*Structure of Clinostomum* (Preliminary notice): HENRY L. OSBORN.

The finding of *Clinostomum* at Neebish, Chippewa Co., Michigan, in August, 1900,

encysted in the black bass and yellow perch, and adult in the mouth and throat of the great blue heron, gave me an opportunity to examine this form. It appears to be specifically identical with the one described by MacCallum in the *Journal of Morphology* (vol. xv, p. 697, 1899), as *C. heterostomum*, and by Braun (*Zool. Jhrb. abt. f. System*, 14, p. 1, 1900), as *C. marginatum*. There are, however, a number of points in which my material differs from the account given by MacCallum. The cuticle is armed with spines, they are very numerous, acutely tapering, run obliquely backward and are located wholly within the cuticle, barely projecting beyond its outer boundary in a few places. There is a single genital opening leading into a common chamber into which the uterus opens from in front and the cirrus sack from behind. A pharynx as described by MacCallum is wanting. The oral sucker, as surmised by Braun, is directly followed by a characteristic œsophagus, lined with cuticle and supplied with usual longitudinal and circular muscle fibers—and surrounded by glandular cells, apparently forming the customary œsophageal gland. Circular muscle fibers are demonstrated in the intestines as well as longitudinal ones in iron hæmatoxalin stained sections. The oviduct opens into the uterus near its anterior end and not posteriorly as indicated by MacCallum. Glandular cells abound in the area directly in front of the ventral sucker, but ducts from them to the oral disk, as described by Braun, have not as yet been recognized in my material.

*Note on the Marginal Sense Organs of Cotylogaster occidentalis*: W. S. NICKERSON.

(Paper accompanied by demonstrations.)

Members of the Trematode family Aspidobothridæ, with but one known exception (*Stichocotyle*), have a series of organs in the margin of the large multilocular sucker

which have been generally regarded as sensory structures. These organs in *C. occidentalis* appear to be both sensory and glandular in function. Each is made up of a bulb-shaped body measuring about  $38 \times 27 \mu$ , which communicates with the exterior by means of a narrow tortuous duct whose outer portion is lined by cuticle continuous with that covering the body. The duct arises from the distal end of the bulb, making first a sharp bend downward beside the bulb for about one-half the length of the latter, then making a second sharp turn toward the surface, where it opens directly over the bulb. The appearance of the contents of the bulb varies from finely granular to coarsely vesicular, corresponding probably with different phases of activity of the glandular protoplasm. Nuclei (except those of nerve cells) are not distinguishable in the bulb. The duct is capable of eversion so that the interior of the bulb may be protruded through the opening. A bundle of delicate nerve fibers enters the bulb at its basal end. The chief interest in the organ centers, however, in a cluster of bipolar cells lying upon the side of the bulb toward which the duct turns. These are undoubtedly sensory cells, and their peripheral processes are probably distributed upon the walls of the duct, although the exact place and method of their termination could not be made out in the specimens studied. The presence of the bipolar sensory cells establishes the sensory character of the organs which hitherto has been a matter of conjecture.

*The Changes in the Facial Cartilaginous Skeleton of the Flatfishes, Pseudopleuronectes americanus (a dextral fish) and Bothus maculatus (sinistral)*: S. R. WILLIAMS.

In specimens of *P. americanus* about  $3\frac{1}{2}$  mm. long whose eyes are still perfectly normal in position the two supra-orbital

bars are present as in other fishes, extending from the ec-ethmoid cartilages to the otic capsules. The first indication of the coming transformation is the thinning out and disappearance of the left supra-orbital in its middle region just above the eye. Sections give evidence of the pressure exerted, since the eyeball is indented where it touches the supra-orbital. For a short time there are two regions of degeneration, one progressing toward the ec-ethmoid and the other toward the otic capsule. By the time the supra-orbital bar is resorbed the fish is at least 5 mm. long. The left eye begins to pass around to the right side of the animal through the gap prepared for it. This part of the process is comparatively rapid. After the eye shows evidence of elevation it may take the fish three or four days to assume the adult position. Nishikawa, a Japanese observer, described the passage of the eye in 24 hours in one case. Fishes of 15 mm. in length are all transformed and many take the adult position at the length of 9 mm. The twisting from left to right is greatest in the plane of the eyes, being about 120°. The brain case shows little asymmetry. The left nasal pit is raised about 30° and the anterior part of the ethmoid not much more. The mass of the ethmoid is twisted so that the left ec-ethmoid points directly up and the right down—90° from their first position. The dorsal fin, after the passage of the eye, extends forward as far as the middle of the eye.

*Bothus*, the sand dab, lies on its right side, whereas *P. americanus* lies on its left. But by merely transposing the terms, using *right* supra-orbital instead of *left*, the description just given for *P. americanus* will hold in general for *Bothus*. The dorsal fin extends to the nose ultimately in this species. The sand dab is more symmetrical than is *P. americanus*. This is correlated with its greater free-swimming habit. The

flounder and the sole cling most closely to the bottom and are the most distorted.

*The Cardiac Gland of the Mammalian Stomach with Remarks on the Evolution of the Stomach of the Artiodactyla*: R. R. BENSLEY.

(Read by title.)

CHAS. B. DAVENPORT,

Secretary.

ANNUAL MEETING OF THE NEW YORK  
ACADEMY OF SCIENCES.

The Annual Meeting of the New York Academy of Sciences was held at 12 West 31st Street on Monday, February 25th, under the presidency of Professor Robert S. Woodward, of Columbia University. The meeting opened with the annual reports of the officers for the year just closed. The Corresponding Secretary reported that the Academy had on its list 41 Honorary Members and 206 Corresponding Members, and that five members had been lost by death during the past year. The report of the Recording Secretary was as follows:

During the last Academy year the business of the Academy has progressed in the customary paths. The several sections have held their usual meetings, with ordinarily the same attendance as in former years. The Council has held the meetings prescribed by the by-laws, and has accomplished several important objects. On the whole, however, the year can not be called a year of progress. The accomplishments of the year leading to increased efficiency in the Academy work are first, the establishment of a series of publication rules that will make the future work of the Editor, and the cost of publication much less than formerly; secondly, the vote to establish a budget for the next fiscal year, within the limits of which each officer will be required to work; thirdly, the hiring of the rooms of the Chemists' Club for the meetings of the next year, at a greatly reduced rental, with accommodations equal to those which

we now enjoy; and finally, a vote to send the *Annals* and *Memoirs* only to those members of the Academy signifying their desire to receive them. The publications of the Academy have been unfortunately delayed during the last year, owing to no fault of the Editor, but the current volume will be very shortly completed and issued. Owing to the expense of the current volume the amount of publication possible by the Academy during the next year will be seriously reduced, unless a publication fund can be established.

The report of the Treasurer showed the following receipts and expenditures for the year:

RECEIPTS.	
Balance as per last report . . . . .	\$2,239.11
Mortgage paid off, <i>a/c</i> Permanent Fund . . . . .	\$1,202.75
Mortgage paid off, <i>a/c</i> Audubon Fund . . . . .	1,797.25
	3,000.00
Income, Permanent Fund . . . . .	426.38
Income, Audubon Fund . . . . .	99.04
Income, Publication Fund . . . . .	90.00
Life Membership Fees . . . . .	615.42
Initiation Fees . . . . .	200.00
	75.00
Annual Dues, 1897 . . . . .	\$ 10.00
1898 . . . . .	30.00
1899 . . . . .	170.00
1900 . . . . .	2,395.00
1901 . . . . .	50.00
	2,655.00
	\$8,784.53

DISBURSEMENTS.	
Cost of Publications, \$2,499.72 . . . . .	
Less Sales . . . . .	30.06
	\$2,469.66
Cost of Publication (paid by Audubon Fund) . . . . .	\$309.72
Rent of Rooms . . . . .	510.00
Seventh Annual Reception . . . . .	329.68
Dues to Scientific Alliance . . . . .	32.58
Lectures . . . . .	20.00
Expenses of Recording Secretary . . . . .	291.44
Expenses of Librarian . . . . .	363.95
Expenses of Treasurer . . . . .	41.93
General Expenses . . . . .	73.37
	4,447.33
Balance on hand . . . . .	\$4,337.20

The Librarian then presented the following report:

The work of the library during the past year has been mainly directed toward keep-

ing the accessions catalogued and in order. This, it is believed, has been successfully carried out. The current numbers of the more prominent periodicals are placed upon accessible shelves and upon the completion of any volume, are arranged permanently with their respective sets. In this connection it is desirable to call attention to the crying need of binding many of the accessions of late years. Hundreds of volumes are stored in their pamphlet form and much injury and loss is the result. During the last year the Librarian was able to have some sixty volumes bound, but financial stringency has prevented any considerable work in this direction.

By arrangement with the authorities of the New York Botanical Garden, the bulk of the botanical portion of the library, which since the removal to Schermerhorn hall at Columbia University, had been stored in boxes, has now been deposited in the Library of the Garden at Bronx Park, and is thus more available than heretofore to general reference.

The Librarian takes pleasure in reporting a gift to the Academy from Professor D. S. Martin of about a hundred volumes of miscellaneous scientific interest.

The statistics of the Library are at this date approximately as follows:

Volumes (bound and unbound) at Columbia University . . . . .	9,000
Pamphlets, at Columbia University . . . . .	2,000
Volumes and pamphlets, at Botanical Garden . . . . .	350

Thanks to the activity of Messrs. Van Ingen and White, assisted by Mr. Graham, the files of the Academy's publications have been brought from a state of chaos to one of order, the exchange list has been revised, and the business of correspondence and exchanges is now carried on with promptness and regularity.

The Librarian takes this opportunity to call the attention of the Academy to the

absolute necessity of considering the disposition of the library in the immediate future. We have practically reached the limit of accommodations in the library room, and the department of exchanges is housed in the Gallery of the Museum of Fossil Plants and Vertebrates, in Schermerhorn Hall of Columbia University, solely by courtesy of the Department of Geology, and it has already exceeded the space which that department can conveniently spare. Radical measures must be adopted in the near future or the library must close its doors.

Following the reports of officers was the election of the honorary members listed below :

Charles Vernon Boys, 66 Victoria St., S. W., London, England.

Emil Fischer, Professor of Chemistry, University of Berlin, Germany.

William Ramsay, Professor of Chemistry, University College, London, England.

James Geikie, Professor of Geology, University of Edinburgh, Scotland.

The Academy also voted to elect the following resident members to be fellows :

Dr. Henry E. Crampton, Dr. J. G. Curtis, Dr. C. A. Herter, Professor Graham Lusk, Professor Charles Lane Poor, Mr. C. A. Post, Dr. E. L. Thorndike, Dr. R. S. Woodworth. "Fellows are limited to one hundred in number, and are chosen from among the resident members in virtue of scientific attainments or services."

Tellers were then appointed, and the officers for the ensuing year were elected by ballot as follows :

*President*, Robert S. Woodward.

*1st Vice-President*, Nathaniel L. Britton.

*2d Vice-President*, J. McKeen Cattell.

*Corresponding Secretary*, Harold Jacoby.

*Recording Secretary*, Richard E. Dodge.

*Treasurer*, Charles F. Cox.

*Librarian*, Livingston Farrand.

*Councilors*, Franz Boas, Charles H. Judd, Charles A. Doremus, M. I. Pupin, Frederic S. Lee, L. M. Underwood.

*Curatols*, Harrison G. Dyar, George F. Kunz, Alexis A. Julien, Louis H. Laudy, E. G. Love.

*Finance Committee*, John H. Hinton, C. A. Post, Cornelius Van Brunt.

Following this routine business President Woodward delivered his annual address, entitled 'Observation and Experiment,' which will shortly be printed in this JOURNAL. After a vote of thanks to the President for his address, proposed by ex-President Henry F. Osborn, the meeting adjourned.

RICHARD E. DODGE,  
*Recording Secretary.*

#### RECENT PROGRESS IN GEODESY.\*

So much has been published during the past year in regard to recent events in the world of geodesy that there is apparently little to be said upon this occasion. But a bird's-eye or general view of a subject has its own special interest and value even to those who are familiar with the details.

It is not necessary to review the recent progress in geodesy in foreign countries, since such a review was presented in January before the Society in the form of a report upon the International Geodetic Association Conference of 1900, by Mr. Isaac Winston, the delegate on the part of the United States to that conference, and this report is in print.†

The principal geodetic enterprise now on foot in the United States is the measurement of a great arc along the 98th meridian from the Rio Grande to the Canadian border. Work upon this arc was commenced in 1896. The present state of the undertaking is that the reconnaissance is complete from northern Nebraska to the Rio Grande; that the triangulation, that is, the measurement of the horizontal and vertical angles, is complete from latitude  $42\frac{1}{2}^{\circ}$  in northern

\* Read before the Philosophical Society of Washington, February 16, 1901.

† See SCIENCE, January 25, 1901, pp. 129-133. A more complete report upon the conference is published in *Revue générale des sciences*, Nov. 15, 1900, pp. 1175-1183; Nov. 30, 1900, pp. 1224-1233.

Nebraska to latitude  $38\frac{1}{2}^{\circ}$  in southern Kansas, a distance of about 300 miles along the meridian. Nine bases have been measured along this arc in addition to the Salina Base on the 39th parallel arc, which serves also to control the lengths on a portion of the 98th meridian arc. But four more bases are necessary for this arc, one at the Rio Grande and three in the Dakotas.

During the year 1900 two triangulation parties were in operation, one working northward in Nebraska and the other southward in Kansas. A base party of ten officers and men, which arrived on the working ground on July 16, 1900, in Nebraska, had by January 23, 1901, standardized the base apparatus twice, at the beginning and end of the season, and had measured the nine primary bases referred to above. The probable error of each base is less than one part in a million. If this feat of measuring nine bases as well as standardizing the apparatus in but little more than six months, while holding the accuracy up to the best standards of the past, is considered with reference to the moderate size of the party and the time which has been required for former primary base measurements, it will be seen that there has been no lack of progressiveness along this line.

One of the events of the year has been the connection of the gravity measures in the United States with those in Europe by swinging a set of the half-second pendulums, which serve to determine the relative values of gravity, at the base station at Washington and at the European stations at London, Paris and Potsdam, at which the more important European absolute measures have been made. The result of this expedition is to impart, at a very small cost in time and money, the expensive and laborious determinations of the absolute value of gravity which have been made in Europe.

During the last two years the instrument and the methods used in precise leveling of the Coast and Geodetic Survey have been radically changed with a view to increasing both the accuracy and the rapidity of the work.\* The evidence as to the accuracy of the new work is rapidly accumulating and so far fully justifies the changes made. The lines of leveling are being rapidly extended, a total of 1750 miles having been run during the last two years.

The most marked progress, however, in the matter of leveling has been the adjustment of the level net covering the eastern half of the United States. More than 13,000 miles of precise leveling had been run by various organizations in the United States. But until within a year the results had not been correlated. To obtain the results it was necessary to search through scores of volumes, and even when this had been done it was found that the results had been published as if each line or group of lines was entirely independent of the others, whereas in fact the connections existed for treating the whole as a single net upon one basis. The adjustment of this net has now been made. The elevations and descriptions of the four thousand permanent bench marks connected with the net, and the principal items of information in regard to each of the lines, have been published in a single volume.†

During the year the report upon the transcontinental triangulation, which marks an epoch in the history of geodesy in the United States, has been published.‡ The computation of the eastern oblique arc, extending from Maine to Louisiana has been

\* See Proceedings of the American Society of Civil Engineers, November, 1900, pp. 1113-1161.

† See Appendix 8 of the Coast and Geodetic Survey Report for 1898-99, pp. 347-886.

‡ The Transcontinental Triangulation, Special Publication No 4, of the Coast and Geodetic Survey, Washington, 1900, 4to, 871 pages.

also completed\* and the report will soon be ready for the printer. The relations between the measures of the earth made in the United States and the previously accepted values for the earth's size are shown in the table given below.

The last two determinations shown in the table are of light weight in comparison with the preceding three.

A study of these values will show that the modern observations in the United States indicate that the true value of the equatorial radius lies between the Clarke and Bessel values, but nearer the Clarke value, and for the polar semi-axis is a little greater than the Clarke value.

axis so computed will differ from the Clarke values of 1866 by as much as 500 meters, and it is about an even chance that either value will not differ from the corresponding Clarke value by more than 170 meters, this being about the height of the Washington monument. In other words, there is little likelihood that the Clarke spheroid of 1866 now used as the standard in this country differs from the spheroid which will most nearly fit this country alone by more than one part in 12,000, and there is an even chance that it does not differ from it by more than one part in 36,000.

It is reasonably safe to make the same prediction in regard to the earth spheroid,

	Equatorial radius, $a$ , in meters.	Polar semi-axis $b$ , in meters.	Compression $(a-b)/a$ .
Bessel spheroid of 1841 .....	6,377,397	6,356,079	1/299.2
Clarke spheroid of 1866 .....	6,378,206	6,356,584	1/295.0
Harkness, 1891. From 'The Solar Parallax and Related Constants,' Washington, 1891, p. 138. From a variety of sources...	6,377,972	6,356,727	1/300.2
The spheroid determined by the 39th parallel triangulation and the Lake Survey arc of the meridian .....	6,377,912	6,356,309	1/295.2
The spheroid determined by the 39th parallel triangulation and Peruvian arc .....	6,378,027	6,356,819	1/300.7
Eastern oblique arc of the United States .....	6,378,157	6,357,210	1/304.5
Nantucket and Panlico-Chesapeake arcs of meridian and Peruvian arc of meridian .....	6,378,054	6,357,175	1/305.5
Lake Erie arc of parallel and Peruvian arc of meridian .....	6,379,822	6,357,716	1/288.6

Having in mind the large number of astronomical stations attached to, and the large area covered by, the arcs already utilized in the United States, as indicated above, it is reasonably safe to predict that if the United States is eventually completely covered by triangulation and astronomical stations are liberally supplied everywhere, and the mean figure deduced from these observations alone, regardless of those made in other countries, neither the equatorial radius nor the polar semi-

axis of the spheroid which will most nearly fit all the measures which may hereafter be made in all countries, as has been made above for the spheroid which will most nearly fit the United States.

JOHN FILLMORE HAYFORD.

U. S. COAST AND GEODETIC SURVEY.

#### THE SAN JOSE SCALE IN JAPAN.

THE insidious invasion of the eastern United States by the San Jose scale (*Aspidiotus perniciosus*)—the name gives undeserved notoriety to the California city—has come to be so formidable that the pest is now recognized as one of the most seriously threatening dangers to American

\* See 'Recent Contributions to our Knowledge of the Earth's Shape and Size by the United States Coast and Geodetic Survey.' C. A. Schott, *The National Geographic Magazine*, January, 1901, pp. 39-41.

fruits. In thirty-five or more States and Territories, and in Canada, the insect is recognized as a scourge. The invasion has been met by the active antagonism of economic entomologists, State Legislatures and fruit growers. A dozen or more States have passed laws providing for the inspection of nursery stock and fruits brought into the State, and for the destruction of stock found to be infested by the scale. The life history of the insect has been carefully studied, the effects of new climatic and topographic environment noted, and new remedies devised and tested. The attention this tiny degenerate insect has received puts it in that notorious list of insect scourges of the first class which includes the chinch bug, the Hessian fly, the Colorado potato beetle, the codlin moth and other familiar pests.

It is recognized more clearly to-day than ever before, how all important in keeping insect pests in check are their natural enemies, predaceous and parasitic, and of how much less avail in most instances are the artificial defenses and offenses which man has devised. The natural remedies are immensely more effective than the artificial remedies. Indeed so extreme a view of the whole matter of insect-fighting is held by some entomologists that they openly commend a 'laissez-faire' policy in economic entomology except as regards purely localized efforts. My own feeling is that of much sympathy with this reaction against the multiplied, expensive and oftentimes conspicuously ineffective artificial panaceas. On the other hand, where the economic entomologist bases his war strategy on a thorough study of the life history and ecology of the particular insect enemy engaged with, and where he seeks primarily to discover natural aids for his attacks, where he thinks first of encouraging and strengthening the natural defenses of the attacked and of reenforcing the natural barriers to

the spread and increase of the attacking pest, he is, it seems to me, on the way to do the best work for the suffering orchard or grain field.

One of the promising lines of work of this kind is the search for and the importation and propagation of the natural enemies (usually predaceous or parasitic insects) of introduced foreign pests. The too successful naturalization of these foreigners is in most instances due, presumably, to the fact that they come to us unaccompanied by their natural native enemies. Free from the principal check to their increase, they multiply and spread with alarming rapidity (providing the conditions of climate and topography permit), giving us a momentary glimpse of life uncontrolled by the balance wheel of one phase of the struggle for existence. It is quite true that much that is ill-considered and imaginative has been spoken and written regarding the success of the importation of parasites. And the expectations of the uninformed, or rather of the falsely informed, are hardly likely to be met soon. But there is an encouraging residuum of fact left after the froth and bubble have been blown from the California stories. The *Vedalia* has really eaten up about all the cottony cushion scale (*Icerya*); and some other imported lady-birds are really eating up a good many other scales. I believe that it is at least worth while to see if there is any hope of getting some active and competent lady-bird beetle to look after the San Jose scale.

But to search for the native enemies of the San Jose scale it is necessary to know the nativity of the scale itself. And this is something as yet undetermined (unless, it has been determined by the investigation about to be written of). Without canvassing in detail opposing claims for the honor, it is sufficient to say that Japan and California are the two leading claimants in the



matter; each claiming that the other is the native home of the pest. With this generous rivalry in mind, and with the further thought of the desirability of finding an effective natural enemy of the San Jose scale, Mr. Shinkai I. Kuwana, Assistant in Entomology at Stanford University, spent all last summer in Japan collecting and studying in the field the Japanese scale insects (the first attempt at a systematic investigation of the Japanese Coccidæ), paying special attention to the San Jose scale. Mr. Kuwana's collections are large, and his notes many, and interesting. His familiarity with the language, the customs and the geography of Japan gave him special advantages in the work.\* He visited all the large islands of the empire, penetrating into the interior among the mountains, as well as examining the coast line orchards. He was greatly aided by Japanese naturalists and fruit growers, and altogether was able to make an extended reconnaissance.

As a result of this exploration it is certain that the San Jose scale is widely and commonly distributed over the whole empire of Japan (excepting on the island Shikoku), though in but few places is it a serious pest. It is found on the following hosts: Pear, apple, plum, peach, Japanese quince, currant, willow (*Salix gracilistyla*), and *Paeonia montana*. It is found especially common in young orchards where its chief injuries are done. It is present in certain of the very old interior orchards, where it has been known, under the name Ki-Abura, for more than thirty years. It is attacked by several enemies, Mr. Kuwana personally finding one chalcid, three lady-bird beetles and one moth, the larva of which feeds on the scale. Of these enemies the chalcid fly and one of the lady-bird beetles are

everywhere common, and are effective checks to the increase of the scale. It is probable that the comparatively little injury produced by the scale in Japan, widespread as it is, is due to the presence of these natural enemies. The artificial remedies used in Japan against the scale include 'soap water,' solution of caustic soda, and kerosene. The soda solution (one pound caustic soda to 10 gallons of water) is applied with cloths and the trees then washed with pure water. The other insecticides are applied with a Japanese paint brush. After a rain the fruit growers go into the orchards with ropes or cloths and rub off the scales while wet.

Variation among individuals of the scale is apparent but not considerable. The scales are uniformly dark, either black or dark brown. The white secretion covering the exuviae of the males is comparatively scant, in some cases almost wanting. The chitinous processes on the posterior margin of the abdomen of the female vary somewhat, but the relative size and arrangement remain fairly constant. There may be as much difference, indeed, between the processes of the two sides (lateral halves) of this margin as between the processes of two individuals.

Mr. Kuwana's observations point strongly to the Japanese nativity of the scale, or at least to its inhabitation of Japan prior to its brilliant career in North America. It must be noted, however, that the scale was not found strictly 'wild' in Japan; that is, it was not found on any wild (uncultivated) tree in its natural habitat. The willow trees found infested with scales were in the ground of the Government Forestry Station at Nishigawara. The scale was, indeed, found on mountain (or wild) pear trees, but these trees were in or near an old apple orchard.

VERNON L. KELLOGG.

STANFORD UNIVERSITY, CAL.

\* Mr. Kuwana's own detailed report of his investigation can not be ready for publication for several months.

## SCIENTIFIC BOOKS.

*Studies in Fossil Botany.* By DUNKINFIELD HENRY SCOTT, Ph.D., etc. London, Adam and Charles Black, The Macmillan Company. 1900. Pp. 533. Illustrated. Price, \$2.75.

The gathering force represented in the paleontological researches of the last quarter of a century is now finding expression in publications which not only summarize the results reached by individual investigators, but which coordinate them and thereby give them a positive value as contributions to our knowledge of the character and succession of plant life in past times. The closing years of the nineteenth century witnessed the issue of three important works by Potonié, Seward and Zeiller. The initial work of the twentieth century by Scott may well take rank with them, and it offers the most hopeful indication of what we may reasonably expect from the paleobotanical work of the future. All these works have the common characteristic that they approach the subject from the standpoint of modern phylogeny, and we may, no doubt, safely conclude that they represent the completion of that 'harmony between the botany of extinct and existing forms' which botanists have always regarded as most essential, but the realization of which has been long deferred. They place the whole subject of paleobotanical research upon an entirely new basis, and this branch of botanical inquiry is now emerging from a condition which may well be compared with the transition from the Old to the New School of Botany in 1860.

In presenting his 'Studies in Fossil Botany,' Dr. Scott does not wish us to infer that he is attempting to produce a manual or even a textbook; but his contribution is founded upon a course of lectures delivered in 1896, which he has now brought down to date, and the title clearly indicates that he avoids the particular field already occupied by Potonié, Seward and Zeiller, whose works follow parallel though dissimilar lines of treatment. The purpose of the author is expressed in the statement that the work is designed to present results which appear to be of fundamental importance, and he therefore confines his attention to a few of the leading groups of plants within which the

greatest advances of recent years have been made, and where most tangible results have been secured. Other publications give greater detail respecting species, taxonomy and geological relations, but the present work acquires special importance and value because of the close insight into relationship disclosed by a detailed study of comparatively few types on the bases of ample material and remarkably well-preserved specimens. His presentation is a statement of facts rather than an exposition of views. We may not only sympathize with him in the hope that the paleontological record will no longer be ignored by students of the evolution of plants, but also express the conviction that in the future botanists will *not* ignore such evidence, simply because they can not afford to do so.

The material used is primarily that which Williamson gathered during his lifetime, together with such additional material as has come to the hands of Dr. Scott and others in more recent years. The author adopts Solms-Laubach's principle of 'the completion of the natural system' as his point of departure. He therefore discards all problematical forms and confines his attention solely to the relatively few types which contribute well-ascertained data. All discussions center in phylogeny, and the work stands as one of the best expositions of the importance which attaches to the study of fossil plants as a necessary means of completing such data.

After a brief discussion of the relations of plants in geological time and their methods of preservation, the author immediately proceeds to a consideration of the Pteridophyta and the lower Seed Plants, and in a very lucid and convincing manner places before the reader the essential facts in the structure, reproduction and relationships of those plants in which the paleontological progress of the past twenty years has centered. In the main, the illustrations are taken from Williamson's works, and a very striking and pleasing feature appears in a skilfully executed restoration of *Lyginodendron Oldhamianum* which is introduced as a frontispiece.

In the present condition of our knowledge, a classification of the Calamariæ is difficult in

consequence of the fragmentary character of the material. For this purpose the fructification which, as also the stem, had a complexity of structure unknown in modern representatives of the Equisetinae, affords the most satisfactory basis, and the system proposed by Weiss, in which he makes use of such external characters as scars, is shown to be of no value except for geological purposes. In *Calamostachys Casheana* the axis of the cone shows a secondary growth in the vascular system and thus gives a final negative to the view so strongly advocated by Brongniart, that secondary growth in the wood is a certain characteristic of the phanerogams. The Calamariae show no transitional forms with the Coniferae, and can not be regarded as their progenitors. In fact, our knowledge of these plants is at present so inadequate, that we can not regard them as anything more than a highly organized family of the vascular cryptogams closely allied to the Equisetinae. But the question still arises if they show any affinities with any of the seed plants? If such affinity exists, it would probably appear in the direction of the Coniferae or possibly of the Gnetaeae. The anatomy of the stem certainly approaches the former, while the structure and simple form of the leaf are not without significance. It is also true that the relative positions of the sporangiophore and bract in *Paleostachys* have been compared with those of the ovuliferous and carpellary scales of the Abietinae, but it is altogether probable that these examples are nothing more than interesting parallels in development which have no force in establishing relationships, and these latter must be sought in other directions, especially as there are no transitional forms connecting the two groups.

The Sphenophylleae represent a group of the greatest phylogenetic interest, inasmuch as they occupy a position of which there is no representative among existing species. The genus *Sphenophyllum* constitutes a perfectly distinct group of which all the parts are well known in one species or another, and there is no longer room for the idea that these plants represent the foliage of a Calamite. Heterospory may have been present, but so far there is no direct evidence in support of such a view.

The remarkable cones known under the name of *Cheirostrobos pettyurensis* have as yet not been found in connection with other parts of the plant, so that it is impossible to determine the exact nature of the organism to which they belonged. So far as known, however, they were homosporous, but the material now available does not admit of final conclusions in this respect. It is nevertheless certain that these cones were of a remarkably complicated type, and while in the character of the sporangio-phores, and in the insertion and structure of the sporangia they exactly agree with the Calamarian type, the anatomy of the axis shows them to approach the Lepidodendroid lycopods, whence we may conclude that they represent a synthetic type combining the characters of different groups of plants.

From these facts Dr. Scott draws the inference that the Sphenophyllaleae were highly modified representatives of an ancient stock from which both the lycopods and the Equisetae have diverged, but our knowledge of these phyla rests at present entirely upon the evidence of fossil plants.

In *Lepidodendron*, the well-defined presence of ligules serves to indicate a connection with *Selaginella* rather than with *Lycopodium*, a view which would seem to gain additional strength from the observed heterospory of *Lepidostrobos Veltheimianus*. Another feature of exceptional interest is the fact that in some of the cones of Paleozoic lycopods, the origin of which has been fully traced, an integument is formed about the macrosporangium in such a way as to produce a seed like body which eventually becomes detached, as exhibited in the well-known *Cardiocarpon anomalum* of Williamson; and this development is repeated in *Lepidostrobos*, where the microsporangia are similarly invested by an integument. In this we obtain the first definite indication of those transitional forms which serve to connect the Cryptogams with the higher seed plants.

The earlier views of Brongniart, which placed the *Sigillarias* among the Gymnosperms, are shown to rest primarily upon the fact that the first described *Lepidodendron* (*L. Harcourtii*) is devoid of secondary wood growth, and emphasis is placed upon the now well-known

fact that the Sigillariæ have not even a remote connection with those plants.

*Stigmaria* is held to represent a rhizophore, of which the stigmarian appendages would therefore be the roots. From this point of view these remains must be regarded as representing organs comparable with the rhizophores and roots of existing Selaginellas.

Dating from Silurian time, the ferns gained special prominence in the Carboniferous, where it is even yet difficult to separate the true ferns from fern-like plants. The author nevertheless adopts the conclusions of Bower and Campbell respecting the relative antiquity of the Eusporangiata and Leptosporangiata as amply justified by paleontological evidence, which also gives support to the classification of ferns by Bower on the basis of the development of the sorus and the output of the spores. In this, the division into Eusporangiata and Leptosporangiata is subordinated to the development of the sporangia with reference to time and place.

One of the most remarkable and significant results of paleontological research in recent years has been the recognition of the Cycadofilices as established by Potonié, thus forming a connecting link between the ferns and the Gymnosperms through the Cycads. Dr. Scott rightly places special stress upon an elucidation of the characters of this important group and shows:

1. That hitherto supposed forms of *Alethopteris*, *Sphenopteris* and *Neuropteris* types really represent the foliage of Cycadofilices.

2. The anatomical characters of the stem are in close agreement with those of the Cycadaceæ.

3. While the exact character of the fructification is not known with certainty, that which in all probability belongs to those plants is widely different from that of the ferns and approximates to that of the Cycads.

*Poroxyton* is shown to be a transitional form between the Cycadofilices and Cordaites through *Lyginodendron*. With respect to the Cordaitæ to which he deservedly devotes a large measure of space, he fittingly summarizes prevalent views respecting this most important group when he says that "Further investigation will doubtless modify greatly our conception of the Cordaitæ, and display a much greater variety

among the members of this family than we are at present prepared for. But whatever the future may have in store for us in this respect, there can be no doubt that the revelation of the existence of this fourth family of Gymnosperms was a discovery of the first magnitude, which reflects the greatest credit upon the investigators to whom it was due, and profoundly modifies our whole conception of an important sub-kingdom of plants."

Among the Mesozoic Cycadales, the genus *Bennettites* gains special prominence and importance, not only because of the great perfection with which important structures are preserved, but because of the character of the fructification and the relatively high development attained by these plants. The stem structure agrees closely with that of the Cycadaceæ, though representing a more primitive type. On the other hand, the fructifications of the two groups are totally different, and the greater complexity attained in the Bennettitæ points to a considerably higher degree of development. Thus in *B. Gibsonianus*, the seeds, many of which are to be found in a remarkable state of preservation, are dicotyledonous and exalbuminous, while the whole character of the fruit approximates to that of an Angiosperm. Here again we observe a repetition of that parallelism in development between various branches of the phylogenetic tree which was so well exhibited in *Cardiocarpus* and *Lepidostrobus*, and which goes far to sustain the idea so frequently suggested throughout the plant world, that in the general progress of development, the various branches are all extending forward in the same direction, whence arises a parallelism which indicates approximation to, without actual connection with, other yet higher phases of development; or, in other words, that deviation of a branch from the main line of descent involves certain inherent deficiencies which, while permitting development in the same general direction, impose a definite limitation of such a nature that the phylum is incapable of further variation, and hence can not extend beyond a limit which is always much inferior to that attained by the main line.

The work throughout affords one of the best evidences among recent contributions of the

primary importance of anatomical characters as the basis of true relationship, and this book will do much toward dissipating the older and altogether fallacious idea that a classification of fossil plants based upon external characters alone is possessed of permanent value. While the external forms of plants or their parts may possess a certain value for taxonomic purposes, such characters are in all probability least reliable in the case of fossils where they depend so largely upon the modifying influence of conditions under which the plant has been preserved. They are therefore oftentimes most misleading, and although we may admit their general value as a provisional means of classifying remains which cannot be otherwise distinguished, they possess no scientific merit and should be abandoned as fast as more accurate data become available.

That this book will do much to stimulate a more active interest in this important line of research we cannot doubt, but its mission will be well accomplished if it does no more than to finally convince botanists of their real dependence upon data derived from a study of the extinct forms of plant life.

D. P. PENHALLOW.

MCGILL UNIVERSITY,

Feb. 6, 1901.

*A Contribution to the Study of the Insect Fauna of Human Excrement.* By L. O. HOWARD. Proc. Washington Academy of Sciences, Vol. II., pp. 541-604. 2 pls.

A brief summary of the results obtained by Dr. Howard in his study of the insects affecting human excrement was given in the *Popular Science Monthly*, January, 1901. We have now before us the detailed work, in which the insects concerned are fully discussed and in many cases figured.

No resident of this country is likely to forget the deplorable outbreaks of typhoid fever which occurred in the military camps at the time of the war with Spain. It appears that every regiment in the United States service in 1898 developed typhoid, while more than 80 per cent. of the deaths in camp were due to this disease. This condition of affairs naturally aroused a great deal of popular anxiety and indignation, while medical men bestirred them-

selves to discover the exact causes of the spread of the fever. As a result, it came to be generally believed that flies had a great deal to do with the spread of typhoid bacilli, and one of the most prominent medical investigators concluded that 'flies undoubtedly served as carriers of the infection.'

Admitting, then, the agency of flies in the spread of typhoid fever and other ills, the question naturally arose, 'What flies?' This question the medical men did not pretend to answer, and the way was clearly open for an entomologist to supply the desired information. Dr. Howard, who loses no opportunity to make the Division of Entomology serviceable to the public, at once began an investigation which has now resulted in the publication of exact and minute details to take the place of supposition and vague surmise. Not only were the insects frequenting human excrement carefully watched and recorded, but feces were collected in great numbers, and the species breeding in them ascertained. As had been anticipated, flies were found in plenty; in fact, no less than 77 different species were obtained, of which 36 were actually found breeding in the feces. In addition to this, 23,087 flies were caught in kitchens and pantries in different parts of the country, in order to see how many of the kinds visiting or breeding in human excrement also visited places where food was kept, and were likely to crawl over the food. It appears that the flies most commonly found breeding in human excrement are not those which frequently enter dwellings, but there are several species which are likely to pass directly from the excrement to places where food is kept, and so become a dangerous source of infection. This is true of the common house fly (*Musca domestica*), the vinegar fly (*Drosophila ampelophila*), the stable fly (*Muscina stabulans*) and a number of others.

The practical conclusions reached by Dr. Howard should become known to all municipal authorities. It is shown that human excrement is much more dangerous to the public health than dead animals or other refuse. Every care should be taken to provide for its removal from those places where flies can gain access to it, and those depositing it in by-ways and vacant

lots should be severely punished. It seems to the present writer that the excrement nuisance, which now appears in a new and more serious light, cannot be got rid of until city authorities see their way to provide places of public convenience in every ward, so that no one need resort to either the alleys or the saloons to obey the dictates of nature. Dr. Howard has, indeed, provided the municipal reformer with a new and valuable argument, which it is to be hoped he will not fail to use.

From the standpoint of scientific entomology Dr. Howard's paper is of much interest. It records for the first time the breeding habits of a large number of insects, and also adds greatly to our knowledge of their distribution. Three species of flies proved to be new to science; these have been described by Mr. Coquillett in *Entomological News*, January, 1901.

In all the work Dr. Howard was ably assisted by several members of his office force, particularly Messrs. Pratt and Coquillett. To these careful credit is given, in accordance with Dr. Howard's invariable custom. The figures are numerous and clear, 25 species being illustrated, often with the early stages. By some slip, *Drosophila ampelophila* is called '*ampelophaga*' on the plate, but the name is given correctly in the text. *Limosina albipennis* and *L. crassimana*, to judge from the figures, should belong to different genera.

T. D. A. COCKERELL.

#### BOOKS RECEIVED.

*Les phénomènes électriques et leurs applications.*

HENRY VIVAREZ. Paris, Georges Carré et C. Naud. 1901. Pp. vi + 574.

*A Laboratory Guide in Elementary Bacteriology.*

WILLIAM DODGE FROST. Madison, Wis., published by the Author. 1901. Pp. viii + 205.

*Ausgewählte Methoden der analytischen Chemie.* A.

CLASSEN. Braunschweig, Friedrich Vieweg und Sohn. 1901. Vol. I. Pp. xx + 940.

*Essays in illustration of Astral Gravitation in Natural*

*Phenomena.* WILLIAM LEIGHTON JORDAN. New York and Bombay, Longmans, Green & Company. 1900. Pp. xiv + 192.

*General Report of the Investigations in Porto Rico of the United States Fish Commission Steamer Fish Hawk in 1899.* BARTON WARREN EVERMANN. Washington Government Printing Office. 1900. Pp. vi + 350, and 50 Plates.

#### SCIENTIFIC JOURNALS AND ARTICLES.

*The Journal of Physical Chemistry.* December. 'Reaction Velocity and Equilibrium,' by Wilder D. Bancroft; 'Differences of Potential between Metals and Non-aqueous Solutions of their Salts,' II, by Louis Kahlenberg. A formula has been deduced by Nernst for the E. M. F. of a galvanic chain of the type

$\text{Ag} | \text{AgNO}_3 \text{ (concentrated)} | \text{AgNO}_3 \text{ (dilute)} | \text{Ag}$  which shows a fair degree of agreement with the observed values when water is used as a solvent. The author has tested the formula experimentally in a number of cases in which non-aqueous solutions are used, and finds that Nernst's formula does not hold good under these circumstances; 'Solvent Action of Vapors,' by A. T. Lincoln. A study of the solvent action of the vapor of water, benzene and acetone upon salicylic and benzoic acids, and of alcohol vapor upon camphor and naphthalene.

January. 'Gas Polarization in Lead Accumulators,' by C. J. Reed; 'Two Devices for Circulating Liquids at a Constant Temperature,' by Ira H. Derby; 'On the Equilibrium of Chemical Systems,' by Paul Saurel. The translation of the more important parts of a thesis of the same title, presented to the Faculté des Sciences of Bordeaux.

THE first (January) number of Volume II. of the *Transactions* of the American Mathematical Society contains the following papers: 'Invariants of Systems of Linear Differential Equations,' by E. J. Wilczynski; 'Divergent and Conditionally Convergent Series whose Product is Absolutely Convergent,' by Florian Cajori; 'Sets of Coincidence Points on the Non-Singular Cubics of a Syzygetic Sheaf,' by M. B. Porter; 'Note on Non-Quaternion Number Systems,' by W. M. Strong; 'On the Reduction of the General Abelian Integral,' by J. C. Fields; 'Ueber Flächen von Constanten Gauss'scher Krümmung,' by David Hilbert; 'Note on the Functions of the Form  $f(x) = \varphi(x) + a_1x^{n-1} + a_2x^{n-2} + \dots + a_n$  which in a given Interval differ the least possible from Zero,' by H. F. Blichfeldt.

THE February number of the *Bulletin* of the American Mathematical Society contains the fol-

lowing papers: 'Report of the Annual Meeting of the Society,' by the Secretary; 'On Some Birational Transformations of the Kummer Surface into Itself,' by Dr. J. I. Hutchinson; 'Theorems concerning Positive Definitions of Finite Assemblage and Infinite Assemblage,' by Mr. C. J. Keyser; 'Dini's Method of showing the Convergence of Fourier's Series and of other Allied Developments,' by Mr. Walter B. Ford; 'Shorter Notices'; 'Fehr's Application of the Vectorial Analysis of Grassmann to the Infinitesimal Geometry,' by Mr. E. B. Wilson, and 'The Annuaire du Bureau des Longitudes,' by Professor E. W. Brown; 'Notes'; 'New Publications.'

The *Plant World* for January comes in a new and improved garb externally and internally. The first article, by Alice Carter Cook, entitled, 'Some Filipino Botany' comprises some curious extracts from Blanco's 'Flora.' C. F. Saunders contributes 'Hints for Beginners in the Determination of Grasses,' and an excerpt from Bulletin 28, Division of Forestry, discusses 'The Threatened Destruction of the Big Trees of California.' E. M. Williams describes 'The Rosy Tricholoma' and C. L. Pollard in the supplement continues 'The Families of Flowering Plants,' treating of various families of the orders Polygonales and Centrospermæ.

The *American Naturalist* for February is a particularly strong number in spite of the absence of 'Editorial Comment and Reviews.' It opens with a long and critical review of 'Scharff's History of the European Fauna' by Leonhard Stejneger, Scharff's work being praised for its admirable suggestiveness and treatment of the subject, though Dr. Stejneger combats, we think successfully, his advocacy of an invasion of Europe from North America by way of Greenland. B. Arthur Bensley discusses 'The Question of an Arboreal Ancestry of the Marsupialia and the Interrelationships of the Mammalian Subclasses,' considering that in spite of all evidence presented, Huxley's theory of a genetic succession of the former representatives of the Monotremata, Marsupialia and Placentalia is still entitled to first consideration. Arnold E. Ortman briefly reviews 'The Theories of the Origin of the Antarctic Faunas and Floras,'

stating that he accepts Hooker's general idea of the former existence of land connection between the southern portions of existing continents. Oldfield Thomas writes of 'The Generic Names *Myrmecophaga* and *Didelphis*,' claiming that the former name justly belongs to the Great Ant-eater and *Didelphis virginiana* to the Virginia opossum. The species *cinereus* and *alstoni* he considers as members of the genus *Marmosa*. Finally Edwin C. Eckel presents 'The Snakes of New York; an Annotated Check List,' giving twenty-five species and subspecies, this being the first paper on the ophidian fauna of New York since Baird's 'Serpents of New York.'

Numbers 62 to 66 of the interesting *Communications from the Physical Laboratory at the University of Leiden* have been received in this country. The preceding numbers of the series are mainly in English. These numbers are in German except No. 65, which is in French. All are reprints from the *Livre jubilaire dédié à M. Prof. Lorentz*.

THE MACMILLAN COMPANY, agents of the New York University Press, will publish early in March, the first number of a scientific quarterly under the title *New York University Bulletin of the Medical Sciences*, edited, under the auspices of the New York University Medical Society, by an editorial committee consisting of B. Farquhar Curtis, M.D., Robert J. Carlisle, M.D., E. K. Dunham, M.D., John A. Mandel and William H. Park, M.D.

#### SOCIETIES AND ACADEMIES.

##### ANTHROPOLOGICAL SOCIETY OF WASHINGTON.

THE 315th meeting of the Anthropological Society was held on February 12th. Mr. Paul Brockett gave a short paper on 'Ancient Mexican Books,' and exhibited a copy of the Borgian Codex, lately reproduced through the munificence of the Duc de Loubat. With the codex was shown a Japanese book, illustrating the similarity in methods of folding. 'The Unwrapping of a Peruvian Mummy,' by W. H. Holmes and Walter Hough, proved interesting. A mummy pack from Peru was divested of its wrappings and from the swathings of cotton-balls, leaves and cloth were taken the skeletons

of an adult and two infants. With the bodies were fabrics, pottery, gourds, a basket of two compartments containing a thorn needle, thread, red pepper and spinning apparatus. The presentation was further illustrated with plates from Reiss and Stübel's 'Necropolis of Ancon.'

W. H. Holmes presented a valuable paper on 'The Peopling of America,' in which a wide range of topics was discussed and illustrated by diagrams. It was aimed especially to bring forward the various problems involved in the new light thrown upon them by recent geological research. The biological problems were presented with the aid of a diagram outlining the history of the species and fixing the apparent position of the American people among the races of the world. Problems of chronology were elucidated by means of a diagram in which the genetic tree of the hominidæ was made to traverse the geologic time scale. Taking root in Tertiary times, the human stem is believed to have sent out four or more branches during Glacial and post-Glacial times, the latter period probably witnessing the specialization of the present American branch. The various views with respect to the geographical position of the cradle of the race were reviewed, and distribution and differentiation were discussed. Preference was given to the view that the eastern rather than the western continent was the original home of the group.

In the fourth section, the bridges and ferries by means of which America could have been occupied were passed in review, and the conclusion was reached that, so far as the present populations are concerned, they must have arrived by way of Bering Strait and that they were thus necessarily of Mongolian stock. Possible interference of the glacial ice sheet was considered, and the probabilities of pre-Glacial, inter-Glacial, and post-Glacial migration weighed.

The seventh section dealt with migration and the laws that govern movements of faunas and peoples, and the effects of movements of human groups from Asia to America by Bering Strait upon somatic and cultural conditions were carefully presented.

The eighth section included a comparative

study of American culture with reference to questions of origin; and the concluding section presented the archeological and paleontological evidence with the view of determining, as far as possible, its bearing upon questions of time, people and culture. It appeared that, although many phases of the investigation are yet in the speculative stage, comparative anthropology and geology are gradually but surely bringing order out of chaos.

Major Powell, in discussing Professor Holmes's paper, urged strongly that the tendency in culture development is toward integration and not toward differentiation. He pointed out that the number of languages in America evidences a low culture status, and affirmed that a similarly low status had been observed among certain tribes of Indians, as to artifacts. These remarks were in support of Major Powell's hypothesis that the precursor of man entered America destitute of speech and arts and at a period when Alaska was a land area coincident with Asia.

Mr. McGee said, in reference to the chronology of the hominidæ, he would place the precursor well down in the Glacial period, when the change began from divergence to integration. He said that development is by that process, and instead of representing the races by a number of radiating lines, he would show the divisions of the human race by converging lines developing toward unity.

Professor O. T. Mason, whose work on these problems is well known, was unfortunately unable to be present.

WALTER HOUGH.

#### BIOLOGICAL SOCIETY OF WASHINGTON.

THE 334th meeting was held on Saturday evening, February 9th. H. C. Oberholser spoke on the subject of 'A Naturalist in the Catskills,' describing at some length the topography of the region, the character of the vegetation and the more prominent birds and mammals, illustrating his remarks with numerous lantern slides. The remainder of the evening was devoted to a continuation of the discussion of the question of previous land connections between Asia and North America. Theo. Gill reviewed the evidence presented by the fossil mammals and existing fishes, saying that there



had not been one, but several land connections between the continents during the past.

Vernon Bailey said that nine species and subspecies of voles inhabiting the islands, coast and barren grounds of Alaska, belong to a well-defined group in the subgenus *Microtus* not represented elsewhere in America, but largely represented in Siberia and Northern Europe, *M. aperazius* of St. Michaels, for example, being closely related to *M. arvalis* of Europe. Among the red-backed voles *Evolotomys alascensis* of the barren grounds of Alaska is much more nearly related to *E. rutilus* of northern Siberia and Europe than to any other American species. As these animals were small and weak and must therefore travel and spread slowly, he concluded that they could not have crossed over an ice bridge, but that their affinities pointed to a comparatively recent and somewhat extended, in point of time, land connection.

F. A. LUCAS.

#### THE NEW YORK SECTION OF THE AMERICAN CHEMICAL SOCIETY.

THE monthly meeting of the New York Section of the American Chemical Society was held on February 8th at the Chemists' Club, 108 West Fifty-fifth street.

Dr. T. C. Stearns read a paper on 'The Chemistry of Materials used in Perfumery and Kindred Arts,' in which he described the methods of preparation and chemical relations of the essential odors of flowers and their synthetic imitations.

In the discussion it was suggested, and by some maintained, that the effect of the synthetic preparations was harmful to the human system, but nothing whatever in the way of proof was adduced.

Dr. C. W. Volney gave the results of his investigation of the 'Decomposition of the Chlorides of the Alkali Metals by Sulfuric Acid,' with exhibition of crystals, which he considered polysulphates, the most important being the trisulphate. Some of those present thought these salts were probably acid sulphates, with sulfuric acid of crystallization, and that even the thermal evidence was in support of this explanation.

A paper by Dr. H. T. Vulté and Harriet W. Gibson on the 'Metallic Soaps from Linseed Oil; an Investigation of their Solubilities in certain of the Hydrocarbons,' was read by Dr. Vulté. Professor Sabin said that a great many of the driers in use were made from rosin and contained no linseed soaps at all. Dr. Dudley said that he knew of no subject needing more study than the chemistry of the drying of oil, and that a great deal of time had been spent on it in his laboratory. He found that oil driers used in excess retard drying, but that gum shellac driers could be used in all proportions and drying would occur approximately in proportion to the drier used. He had also found that a lead and manganese drier could be prepared which would induce drying of linseed oil in two hours.

H. C. Sherman and J. F. Snell were represented by H. C. Sherman, who read a paper in two sections: (a) 'On the Heat of Combustion as a Factor in the Analytical Examination of Oils'; (b) 'The Heats of Combustion of some Commercial Oils.'

It was shown that in the case of a drying oil exposure to the air produced a reduction in the heat of combustion which may amount to ten per cent., whereas lard oil with the same exposure lost only one per cent. of its heat of combustion.

To ignite the oil in the bomb calorimeter it was found satisfactory to absorb it on asbestos wool, whereby the use of any special igniting substance, with its consequent introduction of a troublesome error, was entirely obviated.

DURAND WOODMAN,  
Secretary.

#### THE WESTERN PHILOSOPHICAL ASSOCIATION.

THE Western Philosophical Association held its first annual meeting at the University of Nebraska, Lincoln, on January 1st and 2d. The program was as follows:

Greetings—Chancellor E. Benjamin Andrews, University of Nebraska.

President's Address—'The Theory of Interaction'—Frank Thilly, Professor of Philosophy, University of Missouri.

'The Dominant Conception of the Earliest Greek Philosophers'—Frederick J. E. Woodbridge, Professor of Philosophy, University of Minnesota.

Discussion led by Arthur Fairbanks, Professor of Greek, University of Iowa.

'Martineau's Heredity and Philosophy'—Rev. J. R. Brown, of Kansas City.

Discussion led by C. B. McAfee, Professor of Philosophy, Park College.

'The Psychology of Profanity'—G. T. W. Patrick, Professor of Philosophy, University of Iowa.

Discussion led by D. D. Hugh, Professor of Psychology, State Normal School, Colorado.

'The Postulates of the Psychology of Style'—J. D. Logan, Professor of Philosophy, University of South Dakota.

Discussion led by L. A. Sherman, Professor of English Literature and Dean of the College of Arts, University of Nebraska.

'Some Philosophical Problems of the Present Time'—An informal address by J. E. Creighton, Professor of Logic and Metaphysics, Cornell University, and editor of the *Philosophical Review*.

'The Primacy of Will'—Edgar L. Hinman, Adjunct Professor of Philosophy, University of Nebraska.

Discussion led by W. M. Bryant, of St. Louis.

'The Psychology of Imitation'—T. L. Bolton, Instructor in Psychology, University of Nebraska.

Discussion led by H. Heath Bawden, Instructor in Philosophy, University of Iowa.

'The Theory of Imitation in Social Psychology'—C. A. Ellwood, Assistant Professor of Sociology, University of Missouri.

Discussion led by A. Ross Hill, Professor of Philosophy, University of Nebraska.

The meeting next year will be at the University of Iowa under the presidency of the University of Iowa.

#### DISCUSSION AND CORRESPONDENCE.

##### CROCODILIAN NOMENCLATURE.

MR. WILLIAM J. FOX (SCIENCE, February 8, 1901, p. 232) is maintaining that the name *Lucerta crocodilus*, given by Linnæus, has become restricted to the Nile crocodile by its exclusive use for the latter in Hasselquist's 'Reise,' 1762, has apparently overlooked the fact that the types of *Lucerta crocodilus* are still in existence. It has been shown both by Dr. Lønnberg and Mr. Andersson that the specimens which served Linnæus as types for his descriptions belong to the species which is commonly known as *Caiman sclerops*. As the generic name of the latter is also untenable, the species will stand in the future as *Jacaretinga*

*crocodilus* (Linnæus), while the name of the crocodile of the Nile remains as before: *Crocodylus niloticus* Laurenti.

LEONHARD STEJNEGER.

U. S. NATIONAL MUSEUM,

Feb. 16, 1901.

#### SHORTER ARTICLES.

##### STRATIGRAPHICAL NOTE.

IN SCIENCE, N. S., Vol. XIII., No. 317, January 25, 1901, p. 135, I notice that the order in which the proposed names of the geological formations occurring in the Devonian and Silurian of Antigonish County, Nova Scotia, is given, might lead to a misapprehension of the natural succession of the strata in question. I have much pleasure in drawing attention to the following notes on the names suggested and characteristics of the five geological formations as they appear, in descending order, as follows:

##### Devonian.

1. THE KNOYDART FORMATION. (Knoydart being the name of a settlement and brook in the vicinity of McArras brook, where this formation is well developed. The word is pronounced as if spelt Kroydiart.)

The Knoydart formation consists of red shales and sandstones, marls and tuffaceous strata holding pteraspidian and cephalaspidian fishes associated with crustaceans whose affinities are close to a number of forms described from the Cornstone or Lower Old Red Sandstone of Great Britain, especially as developed in Herefordshire.

This Knoydart formation is thus referred to the 'Old Red Sandstone' or Devonian System.

##### Silurian.

Unconformably (?) below the Knoydart formation we find just east of the mouth of McArras Brook and along the south shore of Northumberland straits at this point, Silurian strata, holding marine organisms, which may be provisionally divided into four distinct formations.

2. THE STONEHOUSE FORMATION. This consists for the most part of dark red thin-bedded, fine-grained, shales and mudstones with a conspicuous and abundant lamellibranchiate fauna,

of which *Grammysia Acadica*, Billings, is a well-known species, together with a number of interstratified, more or less, calcareous band-holding brachiopoda, gastropoda, trilobites and ostracods in abundance.

3. THE MOYDART FORMATION (pronounced Mödiart). This consists for the most part of heavy-bedded, light greenish gray and rusty, or buff-weathering, calcareous strata (in which the 'Red Stratum' of authors occurs) and holds a conspicuous fauna of brachiopods, trilobites, annelids, cephalopods, crinoids, etc. It is followed downward by

4. THE MCADAM FORMATION, which is characterized by dark gray or black fine-grained carbonaceous and oft times splintery shales holding a lamellibranchiate fauna in the upper half of the shale and graptolites in the lower half.

A number of thin lenticular sheets of impure light gray limestone abound in brachiopoda.

5. THE ARISAIG FORMATION. At the base of the Silurian succession, along the Arisaig shore, there occur buff-weathering fine-grained and compact indurated sandstones and shales holding corals (chiefly *Streptelasma*) brachiopods, trilobites, gastropods, etc. These are associated with black carbonaceous and graptolitic shales. The term *Arisaig formation* is suggested and proposed for the lowest Silurian horizon or formation in the section as developed at Beech-hill Cove. The term *Silurian* is here used in the restricted sense as equivalent to the Upper Silurian of Murchison. These formations tabulated would give the following arrangement:

System.	Formation.	Strata.
Devonian.	Knoydart.	Red shales and sandstone, marls and gray sandy shales with tufaceous layers.
Silurian.	Stonehouse.	Red shales and mudstones, with occasional thin bands of limestone.
	Moydart.	Greenish-gray and whitish colored impure limestones.
	McAdam.	Black carbonaceous shales and mudstones.
	Arisaig.	Buff-weathering sandy shales and sandstones, calcareous layers and black carbonaceous shales.

The amount of unconformity, if any, between the Stonehouse and Knoydart formations, *i. e.*, between the Devonian ('Old Red Sandstone') and the Silurian is a point of considerable importance and interest which will receive careful attention. H. M. AMI.

INFLUENCE OF LIGHT ON THE LENGTH OF THE HYPOCOTYL IN INDIAN CORN.

It is well-known that in vegetating plants of Indian corn, wheat and other cereals, the first node of the stem is found near the surface of the ground, regardless of the depth at which the seed was planted. If the seed is deeply planted, the hypocotyl elongates above the seed proportionally lifting the node almost to the surface. If the seed is planted shallow, on the other hand, the node is found at about the same depth.

That the checking of the elongation of the hypocotyl is due to the influence of light is strikingly shown by an experiment recently conducted in the laboratory of the Wisconsin Agricultural College. Kernels of Indian corn were planted by a number of students in galvanized iron seed pans nearly filled with garden loam, after which the pans were kept covered with close-fitting tin covers until the plantlets began to appear when the covers were removed.

In all plantlets which appeared above the soil before the cover of the seed pan was removed, the first node is above the soil, as is clearly shown by the fact that this node bears the cotyledon, while in those that have since appeared, the first node is just at the surface or below it. E. S. GOFF.

UNIVERSITY OF WISCONSIN.

CURRENT NOTES ON PHYSIOGRAPHY.

ALLEGANY COUNTY, MARYLAND.

THE first volume of a new series of county reports just begun by the Maryland geological survey gives an excellent description of Allegany county, which occupies a central position in the three western mountainous counties. Among nine chapters, treating subjects that range from geology and soils to climate and forests, the physiography of the county is described by C. Abbe, Jr. The three cycles of erosion, characteristic of a great stretch of the

Appalachians, are signalized; the first having witnessed the obliteration of the ancient mountains of deformation in the production of an extensive peneplain; the second, introduced by general uplift, sufficing to produce strips of peneplain on the weaker rocks, but leaving the harder rocks so little worn that their skylines suffice to guide the restoration of the earlier plain; the third, introduced by an uplift of less amount, a relatively brief episode up to to-day, inasmuch as it has permitted only the erosion of narrow valleys in the floor of the weak-rock intermont peneplains. Pauses in the later uplift are indicated by rock terraces on the sides of the young valleys; the recency of the latest uplift is proved by the occurrence of ungraded riffles of hard rock in the beds of the larger streams. The meandering courses of the young valleys in their longitudinal parts are thought to have been inherited from free meanders developed on the open floors of the intermont peneplains, before their upheaval. Several examples of stream adjustment are presented. The report includes many excellent plates; the view of Cumberland and the notch in the even-crested Wills mountains being most characteristic of Allegheny scenery. The report is accompanied by an excellent atlas of six mapsheets; three delicately contoured topographic sheets; and three with an overprint of geologic colors on the topographic base.

The author of the above chapter remarks that the modern method of studying the topography of a district 'seeks, from a study of the outward forms, to discover the reasons for their existence and the processes by which they have been produced. \* \* \* The present physiographic study of Allegheny county aims to so present its topography and topographic development as to make clear the reasons why the county has the surface features which characterize it.' A somewhat different wording would have expressed a shade of meaning which is believed to be more appropriate to a physiographic chapter, namely, 'this physiographic study of — county presents the reasons for the existence of the local topographic forms and the processes by which they have been produced in order that the forms themselves, as they now exist, shall be better

known.' The processes of the past are in themselves essentially of a geological nature; they gain a relation to physiography only when they illuminate the facts of the present. Their value to the physiographer lies in the power that they give him to see and to describe the existing facts of topographic form, for physiography is essentially a study of present conditions.

#### THE PHILIPPINE ISLANDS.

G. F. BECKER contributes a 'Brief Memorandum on the Geology of the Philippine Islands' (20th Ann. Rep. U. S. Geol. Surv., pt. ii, 1900, 1-7), which gives another kind of illustration of the point just made regarding the illumination of the present by the past.

Although strictly geological in having to do with past process and time, the essay has a great physiographic value in aiding the imagination to build up a conception of present forms. A strong deformation and uplift of Eocene and older strata was followed by extensive denudation. This was later accompanied by depression, which reduced a large land area to a group of small hilly islets. Volcanic eruptions, making vast additions of material to their denuded and submerged foundation, began during this submergence; then came a general emergence which, with eruptions, has continued ever since; Mayon, one of the most symmetrical cones in the world, having had a violent eruption in 1897. The emergence of the region has revealed coral deposits of the shore waters, which make nearly continuous mantles far up the land slopes, even to altitudes of 2,000 feet. Pauses during uplift allowed the waves to carve sea cliffs and benches, which now take the form of terraces, more or less dissected, as one of the most prominent topographical features of the islands. The last hundred feet of uplift have revealed extensive lowlands, the most valuable part of the archipelago. Considerable areas have been added in deltas, where the mangrove and the nipa palm aid in the deposition of river sediments.

#### OVERDEEPEINED ALPINE VALLEYS.

KILIAN, of Grenoble, dissents from the opinion that the overdeepening of glaciated Alpine valleys and the associated discordant mouting

of the hanging lateral valleys are results of glacial erosion. He concludes that the lateral valleys are the remains of an ancient topography in which the trunk and the branch valleys were accordant; that the lateral valleys, long occupied by névé and ice, have been preserved from erosion, while the trunk valley has been deepened chiefly by stream action during interglacial and postglacial epochs. Overdeepened valleys when thus interpreted are witnesses rather to the conservative action of glaciers than to their destructive action (Note sur le surcreusement ('Uebertiefung') des vallées alpines. C. R. Soc. géol. France. Dec. 17, 1900, 160-162). W. M. DAVIS.

---

BOTANICAL NOTES.

ELLIOTT'S GRASSES.

THOSE who are fortunate enough to possess a copy of Stephen Elliott's rare two-volume work entitled 'A Sketch of the Botany of South Carolina and Georgia' will be glad to know that Professor Scribner, of the Division of Agrostology of the United States Department of Agriculture, has published a circular (No. 29) giving the results, so far as the grasses are concerned, of a critical examination of Elliott's Herbarium, now in the possession of the College of Charleston, South Carolina. He has been able in this way to verify Elliott's determinations, and to make necessary corrections, the latter due to the fact that in many cases the species had been named previously by foreign botanists, and, also, that many changes in nomenclature have occurred in the eighty or more years which have elapsed since the publication of Elliott's 'sketch.' This herbarium is said to consist of twenty-eight volumes of folios, twelve by twenty-three inches in size, and that part containing the grasses is described as in a 'very good state of preservation.' It is curious that in working over the species, the author (who was assisted by Mr. E. D. Merrill) found it necessary to describe two or more species, viz., *Panicum amaroides* (to be separated from Elliott's *P. amarum*, and hitherto known as *P. amarum minor* Vasey), and *Panicum subbarbulatum* (the *P. barbulatum* of Elliott, but not the *P. barbulatum* of Michaux).

WOOD'S HOLL BOTANY.

THE announcement of the botanical work of the fourteenth season (1901) of the Marine Biological Laboratory, of Wood's Holl, Mass., has just been received. Dr. Bradley Moore Davis, of the University of Chicago, will be in charge again, as he has been for several years past. The session opens July 3d, and extends to August 14th. Work is offered along four lines, viz.: Cryptogamic Botany (algae or fungi, or both); Phanerogamic Botany (the outdoor study of flowering plants; Plant Physiology (experiments and lectures); and Plant Cytology (a laboratory course in methods). Lectures by specialists will be provided as in previous years. A special welcome will be accorded to investigators who desire to carry out special lines of research. Announcements giving further details may be obtained of Dr. Davis.

NEW SPECIES OF NORTH AMERICAN TREES.

IT will surprise many readers to learn that critical botanists have recently discovered many hitherto undescribed species of North American trees. In the January number of the *Botanical Gazette*, Professor C. S. Sargent discusses 'New and Little Known North American Trees,' in which he describes seven new species, viz.: *Gleditsia texana* (a tree one hundred to one hundred and twenty-five feet high, and two and a half feet in diameter, from the valley of the Brazos river, Texas); *Crataegus engelmanni* (fifteen to twenty feet high, and closely related to *C. crus-galli*, from Missouri to Alabama); *Crataegus canbyi* (twenty to twenty-five feet high, also related to *C. crus-galli*, from Delaware); *Crataegus peoriensis* (twenty to twenty-five feet high, from central Illinois); *Crataegus pratensis* (a small tree from central Illinois); *Crataegus submollis* (a large tree hitherto confounded with *C. mollis*, from Maine to Montreal and Massachusetts); *Crataegus dilatata* (a small tree related to *C. coccinea*, from Vermont, Massachusetts and Rhode Island); *Crataegus coccinea rotundifolia* (the *C. rotundifolia* of Moench, one of the commonest of New England forms); and *Crataegus jonesae* (a small tree closely related to *C. coccinea*, from southeastern Maine). Ashe's species, *C. holmesiana*, from Quebec and Ontario to Maine, Massachusetts, New York

and Pennsylvania, is redescribed, as also the original Linnæan *C. coccinea*.

In the February number of *Rhodora* the same author describes thirteen new species of *Crataegus* from the Champlain Valley, principally in the neighborhood of Middlebury, Vermont. The species described are the following: *C. champlainensis* and *C. pringlei*, both of the section 'Molles'; *C. lobulata* (of the section 'Flabellatae'); *C. acutiloba*, *C. matura*, *C. pastorum*, *C. pentandra* (all of the section 'Tenuifoliae'); *C. praecox*, *C. brainerdi* (of the section 'Coccineae'); *C. modesta* (of the section 'Tutricatae'); *C. scabrida*, *C. egglestoni*, *C. asperifolia* (all of the section 'Anomalaë').

#### SELBY'S HANDBOOK OF PLANT DISEASES.

PROFESSOR A. D. SELBY, of the Ohio Agricultural Experiment Station, has just issued as a bulletin (No. 121) a very valuable pamphlet of seventy pages entitled 'A Condensed Handbook of the Diseases of Cultivated Plants in Ohio.' It discusses in non-technical language the nature of disease, the structure and habits of parasitic fungi, and then takes up alphabetically the cultivated plants of the farm and garden, describing under each the diseases and their effects. Woodcuts are freely used to help the descriptions. A couple of pages are given to formulæ and directions for making different fungicides, and the pamphlet closes with a very suggestive 'spray calendar.' This bulletin must prove to be very useful to the farmers and gardeners of Ohio, and it will be found most helpful, also, to all who are studying the diseases of plants.

CHARLES E. BESSEY.

UNIVERSITY OF NEBRASKA.

#### SCIENTIFIC NOTES AND NEWS.

GOVERNOR STONE, of Pennsylvania, has appointed Dr. J. T. Rothrock forestry commissioner under the new act, which places the forestry interests of Pennsylvania under the charge of a separate department of the State Government.

GOVERNOR ODELL, of New York, has appointed Dr. Daniel Lewis, of New York City, State Health Commissioner. Dr. Lewis was

president of the State Board of Health which has been abolished.

DR. W. W. KEEN, professor of surgery in the Jefferson Medical College, Philadelphia, expects to spend next year in a trip around the world.

PROFESSOR JOHN GRIER HIBBEN, of Princeton University, has returned from his trip abroad and has resumed his work in the University.

THE Institution of Naval Architects has awarded a gold medal to Professor G. H. Bryan, F.R.S., for his paper on 'Bilge Keels.'

It is stated in *Nature* that the Brussels Academy of Sciences has awarded a gold medal, of the value of six hundred francs, to M. F. Swarts, for a memoir on the subject of carbonates of an element the compounds of which are little known. A similar award has been made to Professor J. Massart, for a memoir on the nucleus of Scizophytes, and the Edouard Mailey prize of one thousand francs, for assistance in the extension of the knowledge of astronomy in Belgium, has been awarded to M. F. Jacobs, the founder of the Société Belge d'Astronomie.

WE also learn from *Nature* that Mr. Vaughan Cornish, whose name is closely associated with the wave-like forms assumed by drifted materials, is now engaged on the Canadian prairies photographing and studying the forms assumed by drifting snow. Thanks to the liberality of the Canadian Pacific Railway Company and the interest evinced in the investigation by Sir William van Horne, Mr. Cornish writes that his work proceeds satisfactorily, and enough has already been done to justify the expedition.

PROFESSOR ERNST HAECKEL is expected to return from Java to the University of Jena at the beginning of the summer semester, when he will resume his regular lectures.

MR. SAMUEL HENSHAW, who has been head gardener of the New York Botanical Garden since its establishment, has resigned on account of advancing years, but is to act as adviser when his services are needed.

DR. F. BIDSCHOF, of the Observatory in Vienna, has been appointed assistant in the Observatory at Trieste.

THE Royal Swedish Academy of Sciences will celebrate the tercentenary of the death of Tycho Brahe by a special session on October 24th. The Academy has also undertaken to issue a facsimile reproduction of the astronomer's great work, 'Astronomiæ Instauratæ Progymnasmata,' which was printed under the author's direction and of which but five copies are known to exist.

THE death is announced of Dr. Robert Pöhlmann, the geologist, curator in the Natural History Museum at Santiago, Chili.

DR. OSCAR SCHLÖMILCH, formerly professor of mathematics at the Technical School at Dresden, died on February 7th, at the age of seventy-eight years.

MR. MAURICE THOMPSON, the eminent poet, critic and novelist, who died recently, did good work as a naturalist. He was originally a civil engineer and was at one time State geologist of Indiana.

ADVICES have been received from Para, Brazil, regarding the death of Dr. Walter Myers, of the expedition from the Liverpool School of Tropical Medicine. The attack of yellow fever followed a prolonged autopsy and Dr. Herbert Durham also contracted the disease. As cable advices to the contrary have not, however, been received, it may be assumed that he recovered.

A CIVIL SERVICE examination will be held on March 26th to fill the position of nautical expert in the hydrographic office, Navy Department, at a salary of \$1,000 per annum. The examination will be in pure mathematics, physical geography and navigation.

THE Department of State has received a note from the legation of Sweden and Norway, dated Washington, February 2, 1901, stating that the managers of the Nobel fund have been authorized to correspond directly with interested parties abroad without using the channel of the Ministry of Foreign Affairs at Stockholm.

THE London correspondent of the New York *Evening Post* cables that an extensive collection of Central American land fresh-water shells has been presented to the Natural History Mu-

seum by Mr. Frederick Godman, F.R.S. There are nearly 7,000 specimens, including types of 70 new species. Mr. Godman also presented a large and important collection of butterflies of Central America, containing 2,500 specimens.

THE Paris Academy of Sciences has decided to award annually in memory of Lavoisier a gold medal for distinguished services to chemistry.

THE fifteenth free lecture course of the Field Columbian Museum of Chicago will be given on Saturday afternoons at three o'clock, as follows:

March 2—'The Kiowa Indians—A Typical Buffalo Tribe,' by James Mooney, Bureau of Ethnology, Washington, D. C.

March 9—'The Hills and Valleys of Wisconsin and their Life History,' by Dr. E. R. Buckley, Wisconsin Geological and Natural History Survey.

March 16—'The Diamonds of the Kettle Moraine and their ancestral Home,' by Professor William H. Hobbs, University of Wisconsin.

March 23—'The Evolution of Means of Transportation in America,' by Professor Edwin Erle Sparks, University of Chicago.

March 30—'Some Interesting Insects,' by Mr. Edward Benjamin Chope, Assistant in Department of Zoology, Field Columbian Museum.

April 6—'Deep Sea Fishing and Fishes,' by Dr. S. E. Meek, Assistant Curator, Department of Zoology, Field Columbian Museum.

April 13—'The Ancient Pueblos of Arizona,' by Dr. J. Walter Fewkes, Bureau of Ethnology, Washington, D. C.

April 20—'Tour of the Plant World—West Indies,' by Dr. Charles F. Millspaugh, Curator, Department of Botany, Field Columbian Museum.

April 27—'Jamaica—The Princess of the Antilles,' by Dr. Charles F. Millspaugh, Curator, Department of Botany, Field Columbian Museum.

THE second annual banquet of the Sigma Xi Society of the University of Nebraska was held in connection with charter day and mid-winter commencement on February 14th. Afterwards an address was made before the Society by Professor C. C. Nutting, of the University of Iowa, his subject being 'The Conditions of Life at the Bottom of the Sea.'

DR. C. HART MERRIAN, chief of the Biological Survey, lectured before the Linnean So-

ciety of New York on February 28th, his subject being 'The Naturalist on the Coast of Alaska.'

MR. N. O. MACNAMARA delivered the Hunterian Oration before the Royal College of Surgeons of England on February 14th, taking as his subject the form of the human skull in relation to the origin of pre-historic man in western Europe.

It is reported that there is a serious outbreak of the bubonic plague in the Khirgiz steppes of western Siberia. Many thousands are said to have already died. The spread of the plague at Cape Town gives apprehension lest the army may be affected, and rumors to this effect are already current.

The last biennial report of the Illinois State Laboratory of Natural History indicates that some valuable investigations have been made in regard to the abundance, distribution and migration of Illinois fishes, their times and places of breeding, their feeding habits and their food preferences. Five stations have been established in the Illinois river for investigation, one in the Spoon river and three in the bottom-land lakes connected with the larger streams. Eighty species of fish were found near Havana, on the Illinois river, the families most characteristic of the region being catfish, suckers and sunfish. There are also a few very abundant species of other families, as the gar, dog-fish, gizzard-chad, yellow bass, sheepshead and carp. A considerable number of collections have been made by high school principals and science teachers and sent to the laboratory in aid of this survey. The laboratory collections of fishes for the last thirty years have been examined and catalogued and rearranged. The collections assorted to the present time are contained in 63 large copper tanks and in 2,827 jars and bottles. A beginning was made last summer in the preparation of colored plates for the report on the fishes of the State. Sixteen plates were finished during the summer, and the color drawings are accurate in detail, true to life in color, form and attitude. It is the purpose of Dean S. A. Forbes to have illustrated by such plates every species of fish found, and the result will be a more finished series of plates of

American fresh-water fishes than has ever yet been published.

#### UNIVERSITY AND EDUCATIONAL NEWS.

THE Chicago Institute of Pedagogy, endowed by Mrs. Emmons Blaine with, it is said, nearly \$2,000,000, has been united with the University of Chicago.

THROUGH Mr. Jonathan Bulkley, of New York, Yale University has received \$10,000 for the establishment of a fellowship in American history.

PRESIDENT MORLEY, of Fargo College, North Dakota, is making progress towards collecting the \$150,000 necessary to secure the pledge of Dr. Pearson, of Chicago, for \$50,000 before the end of the present year.

MR. ANDREW CARNEGIE has presented \$32,500 to the Iron and Steel Institute, London, for the foundation of a research scholarship.

THE troubles in the Russian universities appear to be serious, having spread from Kieff to St. Petersburg and Moscow. About 200 Kieff students have been compelled to serve in the army as a punishment for their objecting to one of the professors. It is reported that six of them have been shot for refusing to renew their oath of allegiance to the Czar, but this may be incorrect.

HOMER CHARLES PRICE, M.S., has been elected to the chair of horticulture and forestry at the Iowa State College of Agriculture and Mechanic Arts. At Wellesley College, Miss Margaret C. Ferguson, B.S., has been appointed instructor in botany and Roxanna H. Vivian, B.A., instructor in mathematics.

PROFESSOR FRANK THILLY, of the University of Missouri, asks us to state that there is no truth in the report that he had been called to the chair of ethics in Leland Stanford Junior University.

DR. F. PASCHEN, of the Technical Institute at Hanover, has been appointed full professor of physics in the University of Tübingen.

DR. FRANZ NISSEL, known for his work on the histology of the nervous system, has been promoted to an associate professorship of psychiatry at the University of Heidelberg.



# SCIENCE

A WEEKLY JOURNAL DEVOTED TO THE ADVANCEMENT OF SCIENCE, PUBLISHING THE OFFICIAL NOTICES AND PROCEEDINGS OF THE AMERICAN ASSOCIATION FOR THE ADVANCEMENT OF SCIENCE.

EDITORIAL COMMITTEE: S. NEWCOMB, Mathematics; R. S. WOODWARD, Mechanics; E. C. PICKERING, Astronomy; T. C. MENDENHALL, Physics; R. H. THURSTON, Engineering; IRA REMSEN, Chemistry; JOSEPH LE CONTE, Geology; W. M. DAVIS, Physiography; HENRY F. OSBORN, Paleontology; W. K. BROOKS, C. HART MERRIAM, Zoology; S. H. SCUDDER, Entomology; C. E. BESSEY, N. L. BRITTON, Botany; C. S. MINOT, Embryology, Histology; H. P. BOWDITCH, Physiology; J. S. BILLINGS, Hygiene; WILLIAM H. WELCH, Pathology; J. MCKEEN CATTELL, Psychology; J. W. POWELL, Anthropology.

FRIDAY, MARCH 15, 1901.

PHYSICAL HISTORY OF THE ROCKY MOUNTAIN REGION IN CANADA.\*

## CONTENTS:

<i>Physical History of the Rocky Mountain Region in Canada:</i> DR. GEORGE M. DAWSON.....	401
<i>Stereoscopic Study of the Moon:</i> G. K. GILBERT...	407
<i>Further Study of the Unit System of Laboratory Construction:</i> PROFESSOR CHARLES S. MINOT....	409
<i>The New York State Science Teachers' Association:</i> PROFESSOR CHARLES WRIGHT DODGE.....	415
<i>Scientific Books:—</i>	
<i>Turner on Knowledge, Belief and Certitude:</i> PROFESSOR R. M. WENLEY. <i>Ewart's Penycuik Experiments:</i> PROFESSOR T. D. A. COCKERELL. <i>The Geological Survey of Canada:</i> DR. H. M. AMI. <i>The Cratons of the United States. Proceedings of the American Association for the Advancement of Science. Books Received.....</i>	422
<i>Scientific Journals and Articles.....</i>	425
<i>Societies and Academies:—</i>	
<i>Geological Society of Washington:</i> DR. F. L. RANSOME and DAVID WHITE. <i>The Biological Society of Washington:</i> F. A. LUCAS. <i>Philosophical Society of Washington:</i> CHARLES K. WEAD. <i>American Mathematical Society:</i> PROFESSOR F. N. COLE. <i>The Academy of Science of St. Louis:</i> PROFESSOR WILLIAM TRELEASE...	426
<i>Discussion and Correspondence:—</i>	
<i>A Field for Mosquito Theorists:</i> G. R. S.....	431
<i>Shorter Articles:—</i>	
<i>Are the Australian Marsupialia of Opossum Derivation:</i> B. ARTHUR BENSLEY. <i>Work at the Marine Biological Laboratory at Wood's Hole.</i>	431
<i>Notes on Inorganic Chemistry:</i> J. L. H.....	434
<i>Zoological Notes.....</i>	435
<i>Nova Persel.....</i>	435
<i>The Association of American Universities.....</i>	436
<i>The Naval Observatory.....</i>	437
<i>Scientific Notes and News.....</i>	438
<i>University and Educational News.....</i>	440

It will now be endeavored to briefly review the orographic changes and the conditions of deposition of which the geological column gives evidence—in other words, to touch in outline the main facts of the physical history of the Rocky Mountain region of Canada.

Regarding the Archean, it need only be said that here, as in most parts of the world, we find, beneath any rocks that can be assigned to the Cambrian in the most extended sense of that term, and apparently separated from these rocks, by a great break and unconformity, a crystalline series or 'fundamental complex' composed of plutonic rocks with highly metamorphosed and vanishing sedimentary rocks in seemingly inextricable association. The similarity of this basal series in different parts of the world is so great as apparently to imply world-wide and approximately contemporaneous conditions, of a kind perhaps differing from any that can have occurred at later periods. The region here described is not, however, an ideal one for the study of these Archean rocks, because of the extreme metamorphism by which much newer formations

\* Concluding section of the address of the President of the Geological Society of America, the late Dr. George M. Dawson, read before the Society on December 29, 1900.

MSS. intended for publication and books, etc., intended for review should be sent to the responsible editor, Professor J. McKen Cattell Garrison-on-Hudson, N. Y.

have often been affected in it; nor has any series yet been defined that appears here to bridge the gap between the Archean and the strata that may with propriety be attached to the Cambrian.

In the earlier series of deposits assigned to the Cambrian, we discover evidence of a more or less continuous land area occupying the position of the Gold ranges and their northern representatives, and aligned in a generally northwesterly direction. The Archean rocks were here undergoing denudation, and it is along this axis that they are still chiefly exposed, for although they may at more than one time have been entirely buried beneath accumulating strata, they have been brought to the surface again by succeeding uplifts and renewed denudation. We find here, in effect, an Archean axis or geanticline that constitutes, I believe, the key to the structure of this entire region of the Cordillera. To the east of it lies the Laramide geosyncline (with the conception of which Dana has familiarized us) on the west another and wider geosyncline, to which more detailed allusion will be made later.

Conglomerates in the Bow River series indicate sea margins on the east side of this old land, but these are not a marked feature in the Nisconlith, or corresponding series on its western side. Fossils have so far been discovered only in the upper part of the Bow River series, but the prevalence of carbonaceous and calcareous material (particularly in the Nisconlith) appears to indicate the abundant presence of organisms of some kind at this time.

Although no evidence has been found of any great physical break, the conditions indicated by the upper half of the Cambrian are very different from those of the lower. Volcanic materials, due to local eruptions, were accumulated in great mass in the region bordering on the Archean axis to the west, while on the east materials of

this kind appear to be mingled with the preponderant shore deposits of that side of the Archean land, and to enter sparingly into the composition of the generally calcareous sediments lying still farther eastward. Where these sediments now appear in the eastern part of the Laramide range they are chiefly limestone, indicating marine deposition at a considerable distance from any land.

The history of the Ordovician, Silurian and Devonian times is very imperfectly known. Marine conditions still prevailed to the eastward of the Archean axis and were probably continuous there, but our knowledge of the region to the west, while as yet almost entirely negative in its character, is not sufficiently complete to enable us to assume the existence of any extensive land area in that quarter. In the Devonian the sea is known to have covered a great area in the interior of the continent, extending far to the north in the Mackenzie basin, and it appears probable that considerable portions of the western part of the Cordilleran region were also submerged, particularly to the north.

About the beginning of the Carboniferous period and thence onward the evidence becomes much more satisfactory and complete. In the earlier part of the Carboniferous, marine sediments, chiefly limestones, were laid down everywhere to the east of the Archean axis, while to the west of that axis (which was probably in large part itself submerged) ordinary clastic deposits, mingled with contemporaneous volcanic materials, were formed, tranquil epochs being marked by the intercalation of occasional limestone beds. It is not clearly apparent from what land the clastic materials were derived, but the area of vulcanism at this time was very great, covering the entire western part of British Columbia to the edge of the continental plateau and, as now known, extending northwest-

ward into Alaska and southward to California.

In the later time of the Carboniferous, however, the volcanic forces declined in their activity, and a great thickness of calcareous marine deposits occurred with little interruption of any kind. The area of land to the eastward was probably increased, for there is some evidence to show a first gentle uprising in the Laramide region at this time (or at least a cessation of subsidence), and no late Carboniferous strata have so far been found there.

No separate record for the Permian has yet been found in this part of the continent, but it must be remembered that, in view of the scanty character of the paleontological evidence, strict taxonomic boundaries can seldom be drawn. At about this time, however, very important changes occurred, for in the Triassic a great part of what is now the inland plain of the continent is found to have become the bed of a sea shut off from the main ocean, in which red rocks with salt and gypsum in some places were laid down. The northern part of this sea appears to have extended into the Canadian region for a short distance, covering the southern portion of the Laramide area. Farther north must have been the land boundary of this sea, and beyond this an extension of the Pacific ocean which swept entirely across the Cordillera. In the southern part of British Columbia, however, this ocean found its shore against the Gold ranges of the Archean axis, where the preceding Carboniferous beds had already been upturned and subjected to denudation. The Laramide region was not affected by volcanic action at this time, but vulcanism on a great scale was resumed in the entire western part of the Cordillera that had previously been similarly affected in the Carboniferous, and the ordinary marine sediments there form intercalations only in a great mass of volcanic products,

probably in large part the result of submarine eruptions.

Such definite indications as exist of the Jurassic must, as already noted, be considered as physically attached to the Triassic of the interior plateau of British Columbia. It is probable that the greater part of the Jurassic period was characterized by renewed orogenic movements and by denudation, for when we are next able to form a connected idea of the physical conditions of the region these are found to have been profoundly modified.

It is to about this time that the elevation of the Sierra Nevada and some other mountain systems in the western states is attributed. In the region here particularly described, the Triassic and older rocks of the Vancouver range, or that forming Vancouver and the Queen Charlotte islands, were upturned, while a similar movement affected the zone now occupied by the British Columbia Coast ranges. These may not have been elevated into a continuous mountain system and barrier to the sea, but in any case the ranges then formed were, before the beginning of the Cretaceous period, largely broken down by denudation, so that the underlying granitic rocks supplied abundant arkose material to some of the lowest Cretaceous beds.

It is also probable that subsidence marked the close of the Jurassic, for in southern British Columbia the Pacific of the Earlier Cretaceous extended more or less continuously across the line of the Coast ranges, finding its shore not far to the east of this line. Farther north, although not without insular interruptions, it spread over the entire width of the Cordilleran belt, repeating the conditions found in the Triassic, but with the difference that it extended far to the south along the axis of the Laramide geosyncline, in which rapid subsidence had been renewed. In this early Cretaceous sea and along its margins and lagoons the

massive fossiliferous rocks of the Queen Charlotte islands and Kootanie formations were accumulated and coal beds were produced. Volcanic activity was renewed in some places, particularly near the present seaward margin of British Columbia. Sedimentation evidently proceeded more rapidly than subsidence in many localities and coal-producing forests, largely composed of cycadaceous plants, took possession of the newly formed lands from time to time.

The era of later Cretaceous appears, however, eventually to have been introduced by a marked general subsidence, which, as already noted, carried the Dakota sea entirely across the inland plain of the continent. The distribution and character of the ensuing Cretaceous formations show that the whole southern part of what is now the mainland of British Columbia soon after became and remained a land area, while the sea was more gradually excluded from the northern part of the Cordillera and continued to occupy the area of the Great plains and the present position of the Laramide range. Along the margin of the continental plateau, however, a renewed subsidence was in the main progressing southward and resulted ultimately in carrying the later Cretaceous sediments into the region of Puget sound.

The closing event of this cycle was the deposition of the Laramie beds on the east and in some places to the north, with probably the Puget group and its representatives on the coast, and this was followed by the most important and widespread orogenic movement of which we find evidence in the entire Rocky Mountain region. At this time the great Laramide range, or Rocky Mountain range proper, was produced, rising on the eastern side of the Archean axis along a zone that had previously been characterized from the dawn of the Paleozoic by almost uninterrupted subsidence and sedimentation. That the pres-

sure causing this upthrust of the Laramide range was from the westward is clearly shown by the great overthrust faults in this range. The stability of the old Archean axis, which it may be supposed had previously sustained the tangential thrust from the Pacific basin must at this time have been at last overcome. As a part of the result of this, the chief belt of faulted strata in the Laramide range, originally about 50 miles wide, became reduced in width by one-half. How rapidly this great revolution may have occurred we do not know, but it probably did not occupy a long time from a geological point of view, and the Laramide range, as first produced, may very possibly have attained a height approaching 20,000 feet.\* The thickness of stratified rocks in the geosyncline was at the time probably more than 40,000 feet.

It is difficult to determine to what extent the Archean axis with the Gold ranges and other preexisting mountains was affected at this period of orogenic movement, because of the absence of the newer formations there, but it seems probable that no very important change took place. Farther west, however, the great zone of Coast ranges was elevated, and the corrugated and vertical Cretaceous beds, met with even on their inland side, show that large parts of the Interior plateau of British Columbia and of the country in line with it to the northward were flexed and broken. Similar conditions are found to have affected Cretaceous rocks of Vancouver and the Queen Charlotte islands, of which the

\* This refers particularly to the better known region near the Bow pass. See Annual Report, Geol. Surv. Can. (N. S.) Vol. II., p. 31 D, and *Am. Jour. Sci.*, Vol. XLIX., p. 463. The base of the mountains may at this time have been nearly at sea level, or 4,000 feet lower than at present, while the actual height at any time attained would depend upon the rapidity of uplift relative to denudation. The total height of folded strata is estimated at from 32,000 to 35,000 feet.

mountain axis, previously in existence, was evidently greatly increased in elevation.

The Laramide geosyncline has already been particularly referred to and allusion has been made to the now well recognized fact that by such zones of continued subsidence and deposition the lines of most mountain systems have been determined. To the Laramide geosyncline here, the mountains of the Archean axis—the Gold ranges—stood in much the same relation as the Archean western border of the Wasatch to the Laramide geosyncline in Utah (as described by Dana), but on a larger scale.

On the other or western side of this axis, as already noted, I am now led to regard the zone of country extending to the Vancouver range as a second and wider geosyncline with a breadth of about 200 miles, in which a thickness of deposits, perhaps greater than that of the Laramide, but in the main composed of volcanic ejectamenta, had by this time been accumulated. The volume of the Carboniferous and Triassic rocks alone must have exceeded 20,000 feet. It is probable that to this may be added a great thickness of older rocks,\* for the circumstance that volcanic action was so persistent here and the amount of extravasation resulting from it was so enormous, implies a recognition of the fact that, along this zone (not far from the edge of the continental plateau) the isogeotherms, with what we may call the plane of granitic fusion, had crept up to a position abnormally near the surface. It is to this probably that we may attribute the apparent absence of Archean rocks in the Coast ranges, or at least the impossibility of defining any rocks of that period there, for these, together, no doubt, with great volumes of later deposits,

\*Several thousand feet of Cretaceous rocks must also be added to this thickness near the line of the present Coast ranges, and the total thickness of deposits in the center of this geosyncline must probably have exceeded 40,000 feet.

may be assumed to have become merged in the rising granitic magma, on which strata of Triassic age are now often found lying directly, arrested in the very process of absorption.\*

When the Laramide revolution occurred, by reason of the increasing tangential pressure from the Pacific basin and the growing failure of resistance of the two great geosynclines of this part of the Cordillera, the Laramide range was produced by the folding and fracture of a very thick mass of beds, of which the crystalline base has not yet been revealed by denudation, while in the western trough an eversion of the axis of settlement seems to have occurred, resulting in the appearance of a granitic bathylite of nearly a thousand miles in length, from which the comparatively thin covering of unabsorbed beds was soon afterwards almost completely stripped away by ensuing processes of waste.

This last great epoch of mountain making doubtless left the surface of the Cordilleran belt generally with a very strong and newly made relief, which before the middle of the Tertiary period is found to have become greatly modified by denudation. Chiefly because no deposits referable to the Eocene or earliest Tertiary have been found in this part of the Cordillera, it is assumed with probability that this was a time of denudation. It is further indicated that it was a time of stability in elevation by the fact that the prolonged wearing down resulted, in the interior zone of the Cordillera, in the production of a great peneplain, the base-level of which shows that the area affected stood for a very long time 2,000 or 3,000 feet lower in relation to the sea than it now does. If, however, the Puget beds of the coast are correctly referred to the Eocene, it follows that the coast region was at the same period

\*Annual Report, Geol. Surv. Can., Vol. II. (N. S.), 1886, p. 11 B et seq.

only slightly lower than at present, and that the movements in subsidence and elevation between this and the interior region must have been differential in character and very unequal in amount.

As already noted, the earliest Tertiary sediments of the Interior plateau of the Cordillera are referred to the Oligocene. Probably some further subsidence at that time interrupted the long preceding time of waste. This period of deposition was in turn closed by renewed disturbance of an orogenic kind, comparatively slight in amount and local, chiefly affecting certain lines in a northwest and southeast direction. Next came renewed denudation or 'planation,' and this continued until the enormous volcanic extravasations of the Miocene began.

It is not proposed in this place to recapitulate in detail the physical conditions of the Tertiary period, for it has already been necessary to refer to these in connection with the description of the beds themselves, which, because they have not been materially changed since their deposition, really tell their own tale.

It need only be said that, after the Oligocene lake deposits had been formed, disturbed and denuded, new series of lakes were from time to time produced at different stages during the Miocene, their beds now generally appearing as intercalations in volcanic deposits of great mass. Both the coast and the interior region appear to have been subject to these conditions, while the Laramide range stood high, with the inland plain of the continent sloping eastward from its base.

Following the close of, or at least a great reduction in, volcanic activity in the early Pliocene, the interior zone of the Cordillera again assumed a condition of stability for a considerable time, during which wide and 'mature' stream valleys were formed. The elevation of the interior plateau region of

British Columbia must then have been about 2,000 feet less than it is at present.\* Further north, the yellow Pliocene gravels of Horsefly river and other places are attributed to this period, and the southern aspect of their contained fossil plants is such as to indicate that, in the given latitude, the height of that part of the interior can not have been much above the sea level.

In the later Pliocene a very marked re-elevation of the Cordilleran region evidently occurred, leading to the renewed activity of river erosion, the cutting out of deep valleys and canyons, and the shaping of the surface to a form much like that held by it at the present day. This elevation in all probability affected the coast as well as the interior, and it would appear that the rivers for a time extended their courses to the edge of the continental plateau.

The excavation of the remarkable fiords of British Columbia and the southern part of Alaska must, I think, be chiefly attributed to the later portion of the Pliocene, although it is quite possible that the cutting out of the valleys may have been begun soon after the Laramide upheaval. The antiquity of these valleys is evidenced by the fact that several comparatively small rivers still flow completely across the Coast ranges in their deep troughs. The fiords are now essentially the submerged lower parts of these and other drainage valleys of the old land, not very materially affected by the later glacial action, important as this has undoubtedly been from other points of view. The valleys of the fiord-like lakes that occur along the flanks of the Archean axis of the interior may probably also be referred to river erosion in the later Pliocene, but if so this mountain region must have been affected by a relatively greater uplift at that time, followed later by a subsidence of its central part. It appears,

\* *Trans. Royal Soc. Can.*, Vol. VIII., Sec. IV., p. 18.

however, that the excavation of valleys or gorges like these by rivers, when the slope and water supply are favorable, occurs with such rapidity relative to the wider effects of denudation, as to be almost negligible in any general view of the physical changes of an extensive region or in the accounting of geological time.

There is as yet some difficulty in connecting the later physical changes particularly referred to above with those which have recently come under observation far to the north in the Klondike region. It is probable, however, that the auriferous 'quartz drift' of that region, implying long subaërial decay and stability of level, may be attributed to the early Pliocene; while the river gravels found in the newer and deeper-cut valleys may be assigned to the later Pliocene time of greater elevation. During the Pliocene, and probably until its close, the mammoth, one or two species of bison, the moose and other large mammals roamed northward to the Arctic sea. Then came the Glacial period, with renewed great changes in levels and climate and its own peculiar records and history, which in many respects are more difficult of interpretation than those of more remote periods, because the whole time occupied by them has been relatively so brief. I have elsewhere endeavored to follow this history in detail, and do not propose on this occasion to deal with this latest chapter of the physical history of the Rocky Mountain region of Canada.

In conclusion, what appear to be the most striking points evidenced by the geological record of this northern part of the Cordillera may perhaps be specified as follows:

1. The great thickness of strata accumulated both to the east and west of an Archean axis. In the Laramide geosyncline the strata no doubt actually attained the volume stated. In the western and

wider syncline it is not so certain that all the formations in their full thickness were ever actually superposed at any one place or time (for reasons already alluded to), but the volume was probably not less than in the Laramide region.

2. The great proportion of volcanic materials accumulated in the western geosyncline and the recurrence of vulcanism throughout the geological time-scale in this region, resulting in the production of massive volcanic formations in the Cambrian, Carboniferous, Triassic, Cretaceous and Miocene.

3. The recurrence of folding and disturbance parallel to the border of the Pacific basin and the concurrent great changes in elevation of the land relatively to the sea, both continued down to quite recent geological times, the latter even into the Pleistocene.

4. The tremendous energy of denudation, in part due to the events last referred to, but also dependent upon the position of the region on the eastern border of a great ocean, where, in northern latitudes, an excessive rainfall must have occurred at all periods on the seaward mountain ranges. No comparable denuding forces were probably ever operative on the east side of the continent in similar latitudes since the definition of the ocean basins of the Pacific and Atlantic.

G. M. DAWSON.

GEOLOGICAL SURVEY OF CANADA.

#### STEREOSCOPIC STUDY OF THE MOON.

In looking at a terrestrial landscape we see that certain features are distant and others near. We also recognize the extension of objects in three dimensions, so that a tree, for example, is not a mere silhouette, but is perceived in its proper rotundity. The data for these automatic and instantaneous judgments as to distance and form are somewhat complex. The distance of

objects of familiar character is judged in part by their apparent size—the principle of lunar perspective. Distant objects, being seen through more air, have a different color from near objects—the principle of aerial perspective. For objects in the foreground we have two retinal pictures which are sensibly different, and from these the eyes estimate distance—the principle of optical parallax. The judgments arising from optical parallax are automatically combined into judgments of the rotundity or solidity of objects. If the sun shines, many objects show one side illuminated and the other side in shadow, and a shadow is also cast on the ground or on adjacent objects. From long association with judgments arising from optical parallax we have come to infer rotundity from the distribution of illumination and non-illumination—the principle of shadows. Finally, sunlight is scattered and reflected from particles in the air and from objects in the landscape so as to come with modified intensity from many directions, affording partial illumination to surfaces not directly exposed to the solar rays. This partial illumination we have learned to interpret in terms of rotundity—the principle of shades.

When one looks at the surface of the moon through a telescope of high power he sees a landscape from an unfamiliar direction and under unfamiliar conditions. As all the objects are strange, he is not aided by linear perspective. As there is no foreground, he is without the assistance of optical parallax. As the moon has no atmosphere his view is devoid of aerial perspective and of shades. It is true that the moon receives reflected light from the earth and there must also be reflection from lunar cliffs, but these reflected lights are so faint as not to help the seeing of surface details; so far as the eye can determine, the lunar shadow is absolutely black. The observer, being deprived of all other data,

has to depend wholly on light and shadow, complete illumination and the entire lack of illumination, for his determination of the configuration of the surface. The sense of sight, having been educated by terrestrial landscapes, is unprepared for the peculiar conditions of the lunar landscape and gives false judgments. Close to the terminator, or sunrise line, where light and shadow divide the field, the eye overestimates the relief and sees the topography as grossly exaggerated as some of the published sketches of lunar mountains. At a distance of  $40^\circ$  or more from the terminator the landscape is practically without shadows, but is diversified by spots of color representing the distribution of the various substances composing the moon's face. These colors, being chiefly light and dark grays, are interpreted by the eye as shades and give an impression of relief no less false than that obtained at the terminator. Along an intermediate zone the general effect as to altitude is substantially true, but it can hardly be doubted that many details of form are misconceived.

Professor W. Prinz, of Brussels, has hit upon an ingenious method of avoiding these difficulties and realizing the actual relief. For many years the rotundity of the moon as a whole has been exhibited by means of the stereoscope. The possibility of this depends on libration, which permits us to view the moon from different directions ranging through an arc of about  $16^\circ$ . Two photographs taken in different months and at times properly chosen, and afterward viewed through a properly constructed stereoscope, give the same fulness of relief which we obtain in observing an object at a distance of 9 inches. Professor Prinz has applied the same method to the examination of small portions of the lunar surface greatly magnified, and is thus enabled to see the craters and other details in their natural proportions. To get the best



effect he uses positives printed on glass and moderately illuminated before a specially arranged background. The details are set forth in a small pamphlet\* which may be advantageously studied by any one who cares to employ the new method.

It will be observed that the stereoscopic method gives the shapes of lunar features in terms altogether independent of those afforded by telescopic observation. The data furnished by the telescope serve through the principle of shadows; the data of the spectroscope serve through the principle of optical parallax. In the stereoscopic view light and shadow join with local color in defining points and spots, and all points are thrown into proper relation through their parallaxes.

G. K. GILBERT.

A FURTHER STUDY OF THE UNIT SYSTEM OF LABORATORY CONSTRUCTION.

It is desired to present a series of drawings with the necessary explanations to illustrate the practicability of designing a laboratory on a unit system. These drawings are the outcome of a somewhat careful study of the problem and of discussions with a number of experienced laboratory administrators. They seem to me to demonstrate the entire possibility of constructing a laboratory upon the unit system.

In a previous article, which was published in the *Philadelphia Medical Journal*,† it was maintained that the unit system of Laboratory construction offers real and very great advantages. The advantages are architectural, administrative and for the work of instruction.

The architectural advantages are those of facility and flexibility of design, and those of convenience and economy of con-

struction. It is evident that if the essential requirement is to provide a number of rooms of uniform and moderate size, abundantly lighted and conveniently accessible, then an architect has a comparatively simple problem, which may be carried out in a great variety of designs, and may be readily adapted to special situations and conditions. Such a requirement leaves an architect great freedom as to the exterior of the building, which generally seems as important to the architect as the interior arrangements are important to the owners and users of a building. One indispensable exception to the exclusive adoption of the unit rooms will recur, in probably every case—namely, that of lecture rooms. As regards the construction, I am informed that it would cost less for a building on the unit plan than for one of equal capacity but with rooms of the customary irregularity of size.

The advantages of administration are manifold. Most valuable will prove, I think, the possibility of changing the uses to which the rooms may be put, for not only may the use of a given room for one object or another of a given department be changed, but it may be transferred wholly to a different department, for a unit room as proposed will be equally adapted to the needs of, for example, chemistry, botany, anatomy or physiology—its adaptation to the special needs of any of these sciences depending only upon the furniture put into it. Within a single department a unit room may be applied to many different uses. It will be of convenient dimensions for a class of elementary study, a smaller class of advanced students, or a still smaller number of research men, or of assistants. It can be subdivided into two smaller rooms by temporary partitions. It will be convenient for collections, for a library or reading room, or for a small lecture room. The particular use of any room can be changed

\* De l'emploi des photographies stéréoscopiques en sélénologie. Extrait de l'annuaire de l'Observatoire royal de Belgique pour 1901. 27 pages.

† Vol. VI., p. 390, Sept. 1, 1900.

at any time by moving the furniture from one room to another. Another administrative advantage will be the ease with which the laboratory may be enlarged by adding a few more unit rooms, each of which will be as perfectly suited to all the varied requirements of the laboratory as the rooms already in use. Such enlargements may be indefinitely repeated as long as the building space holds out.

The advantages of instruction are those which ensue from having the students divided into small sections. These were considered in the previous article, reference to which has been made above. I venture to repeat what was there said. There are two principal alternatives between which we may choose—the adoption of large laboratories or of a series of small laboratories. The choice is between keeping the students in large classes and dividing them into small sections. Personally I can advocate only the latter choice and must plead for it very strongly. In a large laboratory with 75 or 100 or more students, the noise and confusion are necessarily great, and the detailed supervision of the work is extremely difficult. If the students are subdivided into small sections, these and other difficulties at once vanish, and if each section can be assigned a separate room it may be put under the charge of a special instructor, who shall be personally responsible for the work of that section. Thus each assistant can be given a certain independence. The sense of opportunity with the accompanying responsibility will tend to improve the quality of his teaching. He can be directed to carry his section over a certain part of the subject in a given time and left free to accomplish the result. If the section is small enough the work can be interrupted for an explanation, a direction or a quiz, and the students will ask more and better questions than in the large laboratory, where the many listeners embarrass them,

and where they may not find always the same instructor at hand. Finally, the instructor can learn the personal qualities and needs of the men in a small section and establish personal relations with the individuals. It should never be forgotten that such personal relations are most important factors in efficient teaching. It might be urged against the position here taken that the class could be divided into sections in a large room, but my experience convinces me that such a scheme is utterly impracticable. The advantages of moderate sized rooms for all advanced work and for investigations of every kind are so commonly admitted, that their justification by argument is uncalled for. The unit rooms should be therefore of suitable size for these purposes also.

Assuming now that the unit system is desirable, we pass on to the consideration of what may be the best dimensions. The problem resolves itself into three questions :

*First*, What is the best unit space to allow for each student?

*Second*, What is the most convenient maximum number of students to assign to a single room?

*Third*, What additional space must be provided in each room for passages, sinks, shelves, etc., so as to permit it to be fully equipped for the class work?

Let us now consider these questions in the order given.

*First*. The unit space required for each student. In the previous article twenty square feet was suggested as a preliminary estimate, or an area four by five feet. Since then a number of laboratories have been measured, and the relative advantages of various unit areas considered. It is of course desirable on the one hand to reduce the space reserved for each student in order to reduce the total size of the building required, and on the other hand to give each student ample room to carry on the prac-

tical laboratory work under favorable conditions and without interference from his neighbors. These somewhat contradictory requirements may, it seems to me, be reconciled. The study of the subject has led to the final proposition that we accept as the *unit space three feet six inches by five feet* (3 ft. 6 x 5 ft. 0).

By the metric system such a space would measure 1.067 x 1.524 m., or roughly 1.01 x 1.50 m. These values suggest the possibility of adopting one meter by one and one-half as the unit space. In our space there can be put a table measuring 3 ft. 6 x 2 ft., leaving 3 ft. 6 x 3 ft. clear space for the student to sit or stand at his work, and for the instructor or others to pass behind him. The table will be long enough to permit having, say, two drawers and a locker below them, making on one side a tier about a foot wide, and still leaving space for the student to sit comfortably at the table. There are doubtless many laboratories in this country in which less space is assigned to the individual student than is here advocated, but it seems to me that such crowding and cramping immediately lowers the quality of the teaching and the quality of the studying done. The bad result is due in part to the sheer discomfort of the conditions, but is chiefly due to the inferior opportunities which such crowding entails. When students are close together there can be but little room for laboratory apparatus, consequently the practical work for the students must be to a large extent made ready for them beforehand, so that what should be a laboratory exercise at once becomes barely more than a demonstration. If the students are not crowded, then each one may be supplied with a set of apparatus and be afforded an opportunity to perform himself the complete series of operations necessary to obtain and render available the material or phenomena he is to study. A true laboratory experi-

ence is thus placed within his reach, and the instruction is changed from the lower to the higher type. It may be said, therefore, that a fundamental pedagogical principle is involved in refusing to adopt a smaller unit area than above proposed.

*Second.* The convenient maximum number of students in a single room. This number it is very difficult to determine. It is essentially a question of experience and judgment, and as such, the question is inherently impossible to answer in a conclusive scientific manner. I can therefore only express my opinion that twenty-four is such a convenient maximum number. This opinion is based partly upon general considerations, partly upon an examination of the special requirements of medical instruction. Apparently the common American practise, where large elementary classes are taught, is to provide instructors about in the proportion of one to every twenty-five students more or less. In some universities, where the endowments are ample and the classes moderate in size, the proportion of students to each instructor is less, even in a few cases considerably less. In many universities, on the contrary, the opposite is true. A thorough study of the proportion as it actually exists in the various American institutions of higher instruction would be a valuable contribution to the discussion.

So far as I am aware this study has, unfortunately, still to be made. As regards the particular needs of medical instruction—and it is with this that I am personally most directly concerned—there are special conditions, which greatly facilitate the determination of our convenient maximum. The special conditions, alluded to, are furnished by the work of the dissecting room, because six students are assigned commonly to each subject, hence six forms a natural group in medical studies, and the number put in one room should be a multiple of

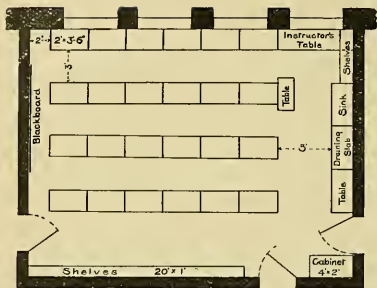

Histology

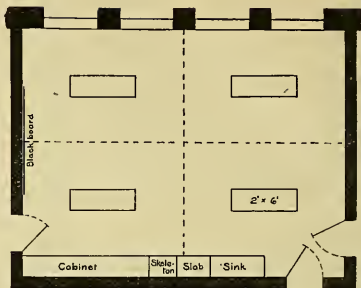

Anatomy

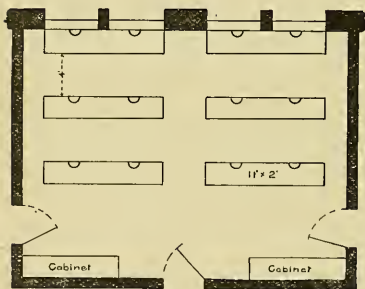

Physiology

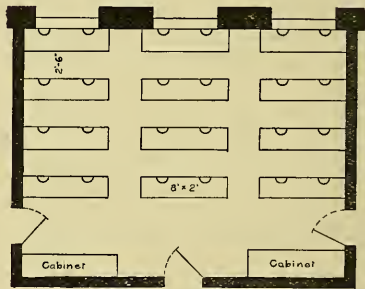

Chemistry

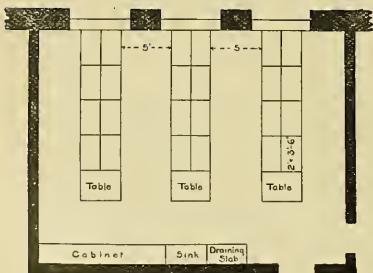

Zoology

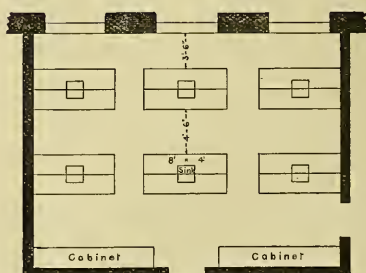

General Chemistry

six. This leads at once to the number twenty-four, four subjects in one room being convenient and having the advantage of allowing the room to approximate to the square form, which would not be practicable if the number of subjects be fixed at three or five. Twenty-four is close to twenty-five, the approximate number first determined, and being an even number it permits the formation of pairs, which has been found advantageous for certain kinds of laboratory experimental instruction. It appears also that this number commends itself to various professors, who have been consulted as heads of laboratories for histology, physiology, chemistry and pathology. While, therefore, no number can be asserted to be best, it is probably safe to accept twenty-four.

*Third.* The additional space to be allowed for passages, sinks, cabinets, etc., on the assumption that each room is to have an independent equipment, so that class-work in it can be carried along independently of the work in the other rooms. Measurements of several laboratories led to the supposition that for each student some ten or twelve square feet additional should be allowed. The supposition was then tested by drawing out several rooms, with varying dimensions, with detail plans of the arrangement of the furniture and fittings, until finally eleven square feet was fixed as a desirable allowance.

We are now in a position to calculate the desirable floor area on the following basis: There are to be twenty-four students in each room. Each student is to be allowed for his own use a space 3 ft. 6 by 5 ft., or  $17\frac{1}{2}$  square feet, or in all 420 square feet, each student also should be reckoned to require eleven square feet additional for the general use, or in all 264 square feet. Thence  $420 + 264 = 684$  square feet required for a room.

A room measuring 30 feet by 23 contains

a floor area of 690 square feet (about 10.67 meters by 5.20 m.), which is almost exactly the area desired, exceeding it only by six feet. Rooms of other dimensions have been drawn, but the propositions adopted seemed the best. The thirty-foot side should of course have the windows, and the narrower dimensions, twenty-three feet, correspond therefore to the depth of the room.

I offer herewith six studies of possible arrangements of the *unit room* which the preceding discussion establishes. The six plans are for convenience, though somewhat arbitrarily, named *Histology*, *Anatomy*, *Physiology*, *Chemistry*, *General Chemistry* and *Zoology*. Little need be said about these plans, because they are in the main self-explanatory. Various dispositions of the windows are indicated, but possibly three pairs of double windows would be better than any of the arrangements on the plans. Experience has led many scientific men to doubt whether any architect knows the meaning of the term 'a sufficiently lighted laboratory.' We have all seen inadequately lighted laboratories, but if an over-lighted laboratory exists anywhere in the world, I have yet to hear of it. As to the doors, it may be suggested that, in order to provide for a future possible subdivision of the room, the wall should be so built as to allow two doors, one towards each end of the room; one door space might be built up until needed. Doors are indicated by which adjacent rooms are directly connected. It might be preferable to arrange the rooms in pairs, as indicated by the distribution of the doors in the plans for *general chemistry* and *zoology*.

In *histology* the students are placed in four rows of six each, and a special table is provided for the instructor; a large black-board is called for on one wall, where it can be easily seen by all the students from their seats. The front edge of a table

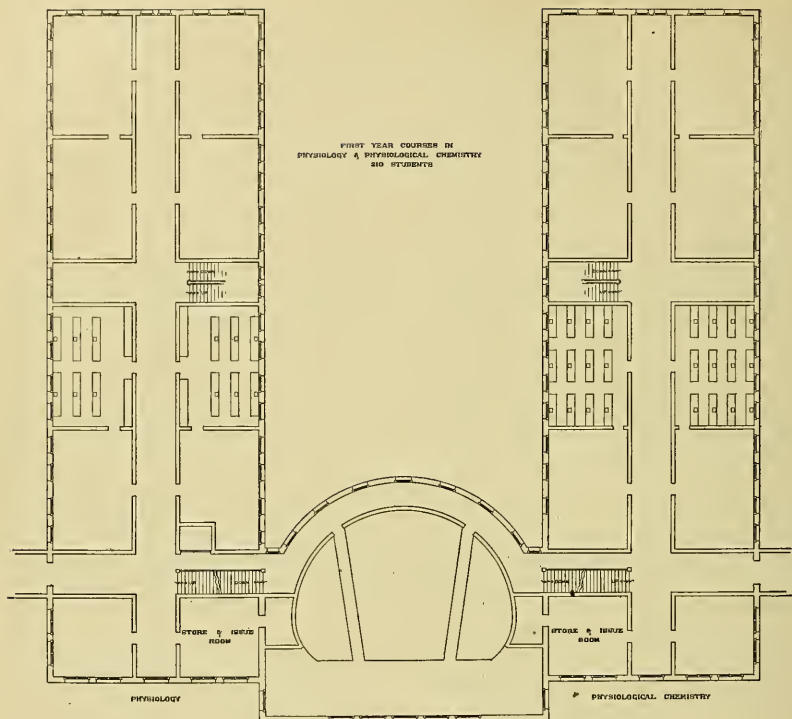

STUDY FOR FIRST FLOOR PLAN  
OF PHYSIOLOGICAL INSTITUTE BY  
W. T. PORTER.

in the fourth row is only fifteen feet from the windows. Every student will be able to obtain unobstructed light for his microscope, especially if the windows are high enough. In *anatomy* there are four dissecting tables, a blackboard, cabinet, sink, etc. In *physiology* the students are assumed to work in pairs, two pairs at each table; hence the design shows six long tables, with a separate sink for each pair of workers. In *chemistry* the tables are eight feet by two, with a separate sink for each student; as the men usually work standing, the tables are placed closer together, and since two

students are calculated to a table, twelve tables are provided. The whole or part of one of the spaces marked 'Cabinet' in this plan, as in *general chemistry* may be made into a hood. *General chemistry* shows the more usual grouping of the chemical desks, back to back, with one sink for four desks. Finally *zoology* shows an arrangement which is preferred by many, the tables forming rows at right angles to the line of windows. In many respects this arrangement is favorable. A special advantage is that, without overcrowding, it permits the addition of three tables, upon which appa-

ratus may be placed which is rather for general and common than for personal use.

A candid examination of these six plans will, I hope, convince the reader that the proposed unit-room provides thoroughly convenient, but not excessive, accommodations for twenty-four students, and that the students may be distributed in many differing ways, according to special needs. It has not seemed worth while to pursue these plans further, with a view of showing how a smaller number of advanced workers could be disposed. The solution of such a problem is so simple as not to require illustration. If such a room is to be used for a collection, two cases could be arranged along the side

there are two symmetrically placed wings, which, building space permitting, can be indefinitely extended, whenever enlargement shall become necessary. The second study, by myself, is merely a modification of the first: the size of the unit room is 23 x 30 feet, one room being drawn subdivided for assistant's use; the main building has been lengthened in order to provide small rooms near the lecture hall, and to increase the distance between the wings so as to secure better light; in order not to increase the floor space the wings are drawn shorter. Neither of these studies is to be regarded as more than a preliminary sketch, which needs competent revision and modification

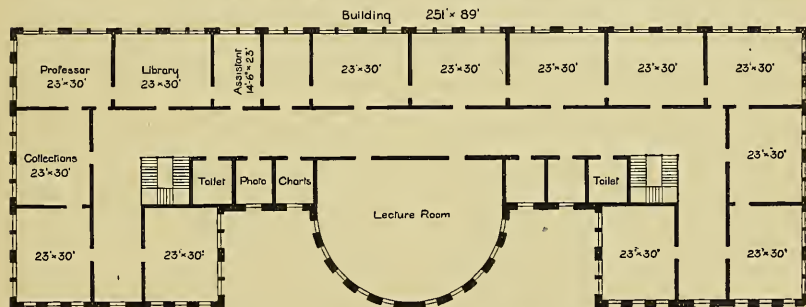

wall, and if there are three windows, two sets of double cases could be placed against the space between the windows and run into the room as do the double rows of tables in the *zoology* plan.

In conclusion, attention is asked to the two studies for a floor plan. The first study is by Professor W. T. Porter, of the Harvard Medical School, to whose generous courtesy I am indebted for the opportunity to publish the plan for the first time. In this study the unit size adopted is 20 x 30 feet, but I have Dr. Porter's permission to state that he considers 23 x 30 feet preferable. In this study there is a central large lecture room connected with the main building, and

by a professional architect before it can become practically available. They suffice, however, for the purposes of this article and to illustrate the construction of a laboratory upon the unit system.

CHARLES S. MINOT.

HARVARD MEDICAL SCHOOL, BOSTON,  
February 18, 1901.

THE NEW YORK STATE SCIENCE TEACHERS' ASSOCIATION.

THE fifth annual meeting of the Association was held at the University of Rochester, on Friday and Saturday, December 28 and 29, 1900, about two hundred members and others being in attendance. The

officers for the meeting were Charles Wright Dodge, University of Rochester, president; Albert P. Brigham, Colgate University, vice-president; O. C. Kenyon, Syracuse High School, secretary-treasurer.

After brief remarks by the retiring president, LeRoy C. Cooley, of Vassar College, an address of welcome by President Rush Rhees, of the University of Rochester, and the introduction of the president-elect, the opening address on 'The Method of Science and the Public Schools' was delivered in the general session by Professor S. A. Forbes, of the University of Illinois. The speaker held that while the methods of study pursued by the chemist, the physicist and the biologist in their various fields of investigation are by no means identical, there are certain underlying features common to all, and these may be abstracted and generalized and called the method of science. This does not mean mechanical manipulations of tools or of apparatus of any sort, but is essentially psychological in its nature. The study of this method is the study of the scientific mind while engaged in the pursuit of science. The application of the method was illustrated by descriptions of the mode of procedure followed in several recent pieces of investigation. The paper criticized much of the present science teaching in the schools as being unsuited to train the mind of the pupil in the mental operations of independent observation, classification, generalization, deduction and experiment which are the essential features of the scientific method.

The section meetings began on Friday afternoon. In the section of physics and chemistry Professor Henry S. Carhart, of the University of Michigan, gave an address on 'The Place of Physics in a Liberal Education.' As one of the oldest and most fundamental of the sciences, physics should have a prominent place in a general plan of

liberal education; its intrinsic interests make it attractive to those who study it; its laws are capable of exact quantitative statement, and it thus furnishes, with the reasoning involved, an excellent instrument of education; its applications to practical and every-day life are so numerous and so important that every intelligent citizen should have a good general knowledge of the subject; it ought, then, to be a part of every high-school course.

Following the paper, Professor Edward L. Nichols, of Cornell University, described a number of devices useful for demonstration purposes in physics. These were (1) an apparatus for showing, in a semi-quantitative way, the expansion of air at constant pressure; (2) floats adjusted to show the phenomenon of maximum density of water; and (3) the torsion balance electrometer.

Before the section in biology, Professor Frederic S. Lee, of Columbia University, spoke on 'The Teaching of Physiology in Secondary Schools.' Dr. Lee advocated a broader view of the subject than most teachers in secondary schools possess. Physiology is the science of the life processes in all organisms, not merely those of the human body. As the basis of all are the vital functions of protoplasm, and of these the pupil ought to have a clear conception. Plain distinctions should be made between gross and minute anatomy on the one hand and physiology on the other, and only so much of structure should be taught as will serve to elucidate function; the idea of physiology proper must be kept paramount. Instruction by practical experiments performed by the pupil or, failing this, demonstrations by the teacher was urged. The number of good laboratory manuals suitable for use in secondary schools now makes such a method entirely feasible. Physiology should follow physics and chemistry in the curriculum. Teach-



ers were urged to inform themselves as to the true status of the alcohol question since most of the statements in the text-books are misleading.

In the same section Professor W. J. Beal, of Michigan Agricultural College, read a paper on 'How shall a Young Person Study Botany?' The paper opened with a very interesting account of the reader's experience as a pupil of Agassiz and of Gray—"The work with Agassiz helped me more than that of any other teacher with whom I ever came in contact, and yet no teacher ever told me so little." The paper advocated the study of plants rather than the study of books about plants; the examination of many related species instead of so many isolated 'types.' The use of the compound microscope ought not to be learned until the latter part of the course. The formation of an herbarium was discouraged. The paper contained a list of most suggestive and interesting topics for individual work for beginners.

Professor W. M. Davis, of Harvard University, addressed the earth science section on 'Practical Experiments in Physical Geography.' Laboratory work for demonstration purposes is most important in this subject, and schools should have proper facilities for it, including sufficient room for practical work, flat roof for sky observations, basement room for experiments with earth and water, as well as an abundant supply of models and charts. The schedule of daily work should be so arranged as to provide for these practical exercises, just as in physics and chemistry. The exercises should include the study of the earth as a globe, the atmosphere, the oceans and the land. The study of the land must be of a kind which will lead pupils to understand what they see in a landscape. Geography ought to serve some other purpose than the education of post-office clerks and express messengers. The study should extend

through successive school years, and the speaker suggested that a committee of members of the Association plan a course in the subject to extend through as many years as seem suitable. Stress was laid upon the proper training of the teacher. The preparation of local guides for field work was strongly urged.

The 'Significance and Limitations of Nature' was discussed in the section in nature study by Professor Stanley Coulter, of Purdue University.

Dr. Henry A. Kelly, of the Ethical Culture Schools in New York City, spoke on 'Synthetic Nature Study.' The object of nature work is to interest the child in natural objects and phenomena rather than to give him definite courses in elementary science, to develop a sympathetic appreciation of living creatures and to encourage habits of observation and comparison. Too great emphasis is placed upon analysis in much of our school work, especially in the object lessons. More attention ought to be given to synthetic, creative work. This end may be accomplished by selecting for study topics which are naturally related. Productive results are often obtained by combining nature study with the work in literature.

After the section meetings a general session was held to listen to a discussion of the question, 'What does the College Instructor wish the Scientific Student to know and to be able to do when he enters College?' The speakers were Professors Nichols and Carhart for physics, Coulter for biology, Beal for botany, Lee for physiology and Davis for physical geography. The trend of opinion was to the effect that unless the student could have proper instruction in methods from a competent and well-trained teacher during his high-school course, he had better enter college without any previous study of science.

The evening session on Friday was held

in the new gymnasium at the University. The members of the Association, faculties of the University, the Theological Seminary and the Mechanics' Institute, members of the Academy of Science and of the Engineering Society, together with a number of guests assembled to listen to addresses by Professor J. B. Johnson, of the University of Wisconsin, and Dr. Robert H. Thurston, Director of Sibley College, Cornell University. The former spoke on 'The Scientific Basis of Modern Industry.' By modern industry is meant the entire productive activities of the machine-using nations. Since the introduction of the steam engine the world has made more progress than in all its former history. The steam engine does as much work in a year as all the men in the land could do in a century. Without knowing the real essence of things—gravity, heat, light, electricity—we can know in some degree the laws of their action, and this knowledge is scientific. The effect of this knowledge has been to revolutionize industrial methods. Scientific education is to-day the foundation of all material prosperity, hence industrial education on a scientific basis should receive the most liberal encouragement. Germany has been the first nation to recognize the importance of this work, and now the technical schools of that country are of the same educational rank as the great universities. The applied scientist must be a specialist, and must be given facilities for investigation if discoveries are to be made which shall extend our knowledge of the forces of nature and adapt their actions to human needs.

Dr. Thurston's address was entitled 'The Citizen, his Schools, his Industries, his Life.' Dr. Thurston emphasized the increasing need of every citizen to be educated and to be aided by the State to secure and maintain the best possible position among his fellow men, for individual effort alone avails much less now than when competi-

tion was less severe. The material progress of a nation may be measured by its consumption of iron and steel. A better gauge of advancement is the progress of higher education as supplementary to that of the common schools, particularly the development of the modern forms of technical school and the scientific departments of our colleges and universities. A comparison of statistics shows that during the century just closed there was a parallel advance in the development of technical education, the growth of that product of industrial activity which represents permanent wealth, the increase of national wealth, both aggregate and per capita, and the wealth which is secured by the people as wages. The larger educational institutions of this country now graduate yearly about a thousand students trained in the applied sciences. "The compulsion which has brought about this immense development of higher education has consisted of three main elements: (1) that ability attained, through increased and more widely and uniformly distributed wealth, on the part of the people, to secure higher education, which always marks such progress as we have traced in our material evolution; (2) that constantly growing demand for more generally learned men in the professions, including now the constructive professions; (3) that constantly growing and increasingly intense demand, in all industrial vocations, for a scientific basis for all industries and for highly trained, learned men in all great enterprises and in every system of industrial production. But all these elements of the aggregate compulsion rise out of and accompany the evolution of the modern industrial system, which, in turn, is based upon that progress in civilization through the work of the inventor, the mechanic and the man of science, which is giving us such marvelous accumulations of material wealth, with all its higher accompaniments

in the realms of the sciences, the literatures and the arts, fine, useful and æsthetic." For the past thirty years the demand for mechanical engineers has been increasing at a remarkable rate and is likely to continue. The sciences will more and more become the foundation for all industrial occupations, hence, scientific education should be begun in the preparatory schools, and instruction should be given by teachers who have received adequate training. "One great mind lost to the world through lack of the higher education which it is capable of utilizing is a more grievous loss than sunken fleets. \* \* \* One great exploiter of scientific knowledge counts for an army, for he makes effective an army, saves a country from ruin, raises a nation to previously unimagined heights, confers the comforts of the highest civilization upon the people, or gives his fellow men leadership toward hitherto unexplored realms of wisdom, knowledge and opportunity. The grandest financial expenditures by the state are those which develop new moral, intellectual and physical forces for the benefit of the nation."

After the addresses a reception was given by the Trustees of the University for the Association and guests.

The section meetings were resumed on Saturday morning. In the section in physics and chemistry John S. Shearer, of Cornell University, spoke on the 'Relation between High Schools and College Courses in Physics.' Struck by the fact that in the elementary college courses in physics those students who had received no previous training in the subject were capable of doing quite as good work as those who had taken a preparatory course, the speaker made a careful study of the average standing of the two groups of students and found that those in the second stood only about three per cent. higher than those in the first group. Among the apparent causes of this condi-

tion the following were mentioned: Formulæ are memorized without any clear understanding of their meaning; problems are solved by rule of three as a substitute for careful analysis; the student is carefully shielded from the real difficulties of the subject; the idea is too prevalent that physics pertains only to the class-room and the laboratory and has no connection with actual affairs; the habit of self-reliance in testing things by experiment and by deduction from known laws is not developed. In a word, poor teaching is at the bottom of it all.

'The Manual Training of Chemistry' was the title of a very practical paper written by Professor William E. Bennett, of the Rochester High School. The manual training of the trade school is purely utilitarian. It aims to develop manipulative skill to the point of being automatic or reflex, while in the larger and better sense such training should also stimulate mental activity and equip the student to cope with unexpected difficulties. This he can do only if he understands the reasons for each step in the progress of his work. Chemistry, with its delicate operations and manipulations was claimed to be one of the best disciplines to develop the faculties involved.

In a paper on 'The Relative Value of the Qualitative and the Quantitative in Laboratory Work,' Professor W. C. Peckham, of Adelphi College, Brooklyn, held that the greater part of laboratory work in physics should be quantitative in character and that the deductive method of presentation is preferable in high-school work.

Dr. Henry R. Linville presented in the section in biology a paper entitled 'The Framing of a Course in Biology for Untrained Minds: a Discussion of Principles.' The writer stated what he considered should be the main features of such a course and described the work planned for the boys from the 'East Side' in New

York City, outlining the course of study and method of work in zoology in the DeWitt Clinton High School.

'Zoology in Secondary Education' was discussed by Professor Jacob E. Reighard, of the University of Michigan. Professor Reighard held (1) that science teaching in secondary schools should have for its object the developing of scientific method (intellectual) rather than the imparting of information, and that it should be disciplinary rather than technical; (2) that biology does not resolve itself in the final analysis into physics and chemistry; that it is a distinct science with its own principles, and that its intellectual methods are therefore distinctive and different from those of physics and chemistry; (3) that the intellectual methods of the biological sciences are like those employed in the historical, social and other humanistic sciences; (4) that properly conducted biological work in secondary schools therefore affords the best possible training in those intellectual methods which are of the most value to the future citizen, for it trains for citizenship; (5) that the biological sciences are homogeneous, in the sense that there is no necessary sequence of parts, and, aside from practical considerations, their study may be taken up at almost any part and pursued in any order of parts. The paper also dealt with the question, What biology is it possible to teach in secondary schools, and what parts of the subject are of highest training value?

In the earth science section Professor F. M. McMurry, of Teachers College, Columbia University, spoke on 'Controlling Ideas in Geography Work in the Grade,' maintaining that the basal units of geography ought to be taught far more fully than has heretofore been the case, that the proper presentation of these units calls for numerous excursions and the type treatment of topics, that the latter provides for far more

frequent and effective reviews than have been customary, and that there is an extensive causal sequence in geography, the beginning point being physiographic and climatic conditions.

Professor Albert P. Brigham, of Colgate University, followed with an address on 'The Personal Equipment of Teachers of Geology and Geography.' The teacher should feel genuine interest in his work and ought to have had as much field experience as possible, including detailed and careful observation and description. Verification in the field of the results obtained by others should also be practised. The acquirement of full knowledge of some one phase of the subject is highly desirable. The economic bearings of the subject ought not to be neglected. Acquaintanceship with other workers in the same field is to be cultivated, and attendance at meetings of scientific societies should be both a duty and a pleasure. The teacher needs also to possess a well-selected library and to be familiar with its contents.

The last paper in the section was by Professor Amos W. Farnham, of the State Normal School, at Oswego, on 'The Purpose of Geography.' It is the purpose of geography to take into account all those physiographic elements, in a related way, which are of use to man, and those, also, which hinder his progress. The child regards the various earth forms of his environment as sources of enjoyment and of interest. Later, he learns the economic importance and the physiographic effect of climatic changes, rainfall, the flow of streams, the amount of sunshine, the effects of drought and so on. Geography cultivates the pupil's intellectual processes, stimulates his emotional nature, and leads him to realize man's dependence upon, as well as to understand his control over, the forces of nature.

In the nature study section, E. Howard Eaton, of the Bradstreet Preparatory School

for Boys, Rochester, spoke on 'Birds in Nature Study.' The rapidly increasing study of birds and bird-life is due, in part, to the general awakening of interest in nature; but there is also a wide-spread feeling that the number of our native birds is decreasing very rapidly, and that it is only by instructing the rising generation in the value of birds and the ways of protecting them that we can hope to preserve the varied, beautiful and highly beneficial species which are disappearing before the onward march of railroads, telegraph wires, plate-glass windows, electric lights, milliners, wood-choppers, ditch-diggers, English sparrows, murderous boys and untutored men. There is, moreover, a great inherent value in bird study. Children are interested in life, and birds are the most alive of all animals. Their highly specialized structure and life activities, their motion, song, language, arts, architecture, community interest, travel and personal traits are highly suggestive to the youthful mind. In this department of nature study there is also a chance of directing the dawning moral sentiments which can not be neglected. To tell children that life is sacred and that nothing that lives should be killed is weakly sensational, irrational and insulting to the ruler of the universe. Boys should be taught why, when and what to kill; not never to kill. The teacher of bird study must know not merely technical biology, but also the natural history of birds, and teach the general structure, relations, habits, food, song, flight, and special adaptations of the different families of birds and the common individuals of each family. Let the boys and girls become acquainted with our bird neighbors and their occupations, and when they know them as well as they do their own friends and recognize them as easily, then they will be good bird protectors.

Mrs. Anna Botsford Comstock, of Cor-

nell University, discussed the subject of 'Nature Study and the Grade Teacher,' describing the work being done in the State in the way of introducing nature study into the schools and mentioning the difficulties encountered in getting the work properly started, owing to the lack of preparation on the part of the grade teachers.

At the closing general session Professor Frank Carney, of Keuka Institute, presented a paper on 'The Moral Value of Science Studies,' and John W. Spencer, of Cornell University, described 'The Work of the Junior Naturalists' Clubs.' These clubs are composed of boys and girls in various parts of the State and were started for the purpose of developing interest in nature. The membership now includes several thousand.

At the business meeting with which the session closed it was announced that forty new names had been added to the membership roll and that the financial condition of the Association was satisfactory. The following officers were elected: *President*, Professor Franklin W. Barrows, Central High School, Buffalo; *Vice-President*, Professor Frank M. McMurry, Columbia University; *Secretary-Treasurer*, Professor A. R. Warner, High School, Auburn.

After adjournment many members took the opportunity to visit Ward's Natural History Establishment, the works of the Bausch and Lomb Optical Company, the Eastman Kodak Company and other places of interest.

Exhibits of scientific apparatus, museum and laboratory supplies, charts, etc., were made by Bausch and Lomb, Ward, Marine Biological Laboratory, Denton Brothers and others.

The proceedings of the meeting will be published in full by the Regent's Office in Albany.

CHARLES WRIGHT DODGE,  
*Secretary.*

## SCIENTIFIC BOOKS.

*Knowledge, Belief and Certitude, an Inquiry with Conclusions.* By FREDERICK STORRS TURNER, B.A. (Lond.). London, Swan, Sonnenschein & Co.; New York, The Macmillan Co. 1900. 8vo. Pp. viii + 484. Price, \$2.25.

This is a plain, straightforward bit of work, possessing the good qualities that, as a rule, mark first-hand thinking. Here and there Mr. Turner may be disposed to magnify his office in somewhat *naïve* fashion; but he is so much in earnest that one can forgive him readily.

The problem by which our author has been oppressed may be stated succinctly thus: What is Real Knowledge? In addressing himself to its solution, Mr. Turner distinguishes between what he calls 'abstract' and 'real' knowledge. He finds that the former is common to the many disciplines indicated usually by the generic names science and philosophy. In this connection he says a number of sane things about science, a majority of them, to be sure, quite familiar already. The manner in which he runs amuck among the philosophical dignitaries and their honored idols does him no small credit, if he be aware—which I do not think he is—of the enormities he commits. Some of the references to psychology look suspiciously second-hand, and the cavalier treatment of Wundt hardly reassures one regarding Mr. Turner's insight into contemporary problems and tendencies. Yet, be this as it may, our author suffers nothing on the score of tradition; and, if he contrive to annoy some few, he will, for similar reasons, amuse a great many more.

The portion of his book on which he lays the greatest store on the score of originality, is entitled 'Real Knowledge.' It may be of interest to note the precise import he bestows upon this rather optimistic phrase. For we all remember the proverb about the place where angels fear to tread. 'Real Knowledge,' then, is the "science of ends, of human causality, so far as man is a cause by his own will and according to his own design (351). \* \* \* In all its stages the *end* both is, and leads to, real knowledge. \* \* \* It seems to me that now in this knowledge of ends we have a full and sufficient answer to those psychologists and philosophers

who call in question the reality of the first fundamental certitude, that of the Self." (361-62). Thus, knowledge of the Self is 'real knowledge.' Again, "it is not too much to say that the knowledge of our own causal power is on a level with the most certain and the most important knowledge which we possess. This is real knowledge; compared with which mathematics and metaphysics seem shadowy and unsubstantial" (386). With this the 'nescience of science' is to be sharply contrasted. "Science is not a unity nor a system, but merely a general name for a number of separate sciences. All attempts to frame a tenable theory of the universe by means of abstract objective knowledge, or science, are necessarily doomed to failure" (439). On the other hand, positive conclusions are possible, to wit: "The first positive conclusion we have reached is that real knowledge is a state or mode of the conscious being of real living men and women. \* \* \* The second positive conclusion is that this real knowing is a knowing of real persons, real things, real events. \* \* \* The third positive conclusion is that the knowing and the known are united in the reality" (477-78). Such are Mr. Turner's constructive results, so impressive to him that he ends, "not with a feeling of self-complacency, but with joyful confidence in the truth that has been revealed to me (479)."

Needless to tell, all this happens to be one huge *ἵστερον πρότερον*. Mayhap, human experience must, by the very nature of the case, partake of this character. But a writer who would reveal the inwardness of 'knowledge, belief and certitude' can not be said to have solved his problem by the mere statement of a few among its obvious implications. No doubt, he may accomplish something along such a line—he may be assembling the factors involved. Just because this appears to be Mr. Turner's situation, his interesting book would serve better than some pretentious manuals as an introduction to philosophy for students whose intellectual fates had been committed to a skilled teacher. For it is not given to every author to be so frank when he sees men as trees walking.

R. M. WENLEY.

UNIVERSITY OF MICHIGAN.

*The Penyuik Experiments.* By J. C. EWART. London, A. and C. Black. 1899. Pp. xciii + 177.

*Experimental Contributions to the Theory of Heredity. A. Telegony.* By J. C. EWART, Proc. Royal Soc., Vol. LXV. 1899. Pp. 243-251.

*Guide to the Zebra Hybrids, etc., on Exhibition at the Royal Agricultural Society's Show, York.* By J. C. EWART. Edinburgh, T. and A. Constable. 1900. Pp. 51.

About ten years ago there was an agitation in England for the establishment of an institution to experimentally test current theories regarding the processes of evolution. A memorial was circulated, and signed by many eminent persons, but the castle—or rather menagerie—in the air which enthusiasts had built did not descend to solid ground. In the meanwhile, however, certain individuals were laying plans of their own. Experiments in breeding moths had already yielded remarkable results. The experimental method had become fashionable, at least in theory, and it seemed that there were large possibilities before those who had time and money at their command. Under these circumstances it was, perhaps, not remarkable that Professor Ewart, aided and abetted by various friends, should have undertaken to breed equine hybrids to prove the validity or otherwise of the theory of telegony. But if the Penyuik experiments were thus a natural product of the times, they were for that reason the more timely, and all biologists may be thankful to the Scottish professor for having planned them so carefully, and carried them out so satisfactorily.

And now that we have the published results before us, what of telegony? The evidence on which it rested, at least so far as the Equidae are concerned, is so thoroughly disposed of that it seems almost superfluous to discuss it. Professor Ewart did not start out with the proposition that telegony was absurd, and the statement that he would so prove. On the contrary, whatever he may have thought of the doctrine, he gave it every chance. He also got results similar to those which had been held to prove telegony. Mulatto, a West Highland pony, had a foal by Matopo, a Burchell's zebra. Subsequently Mulatto had a second foal by Benaz-

rek, a gray Arab. This foal, which, except telegony be true, had no zebra blood in its veins, had a number of stripes when a few days old. A figure of it is given, and it certainly has a very zebra-like appearance. At this point a less scientific investigator might have concluded that telegony was proved, and there was nothing further to be said. Not so Professor Ewart. He continued his researches, and in due time was able not only to show that such striping as that of Mulatto's second foal was not uncommon in horses, but also to produce equally striped foals from mares which had never seen a zebra.

In the course of the investigation, many facts of the greatest interest were ascertained. The hybrid between the Highland pony and Burchell's zebra showed a striking likeness to the Somali zebra in the plan of its stripes. This is considered by Professor Ewart to indicate reversion, and in this connection excellent reasons are given for considering that the common ancestor of the various breeds of horses was striped, and that among zebras the Somali species is in many respects the most primitive.

The whole question of reversion resulting from a cross is carefully discussed, and it is suggested when there is a sort of antagonism between the immediate parents or close ancestors, the more or less remote ancestors might contribute more than their normal share to the new individual. That is to say, the two incompatible parents annihilate one another, more or less, like the Kilkenny cats, and the ancestral traits, which otherwise would be crowded to the wall, come to the front. This sounds reasonable enough, but one may hazard a further suggestion that the two parents would contribute the *same* latent ancestral characters, but *diverse* modern ones, and so the characters of their common ancestor might be emphasized. Thus, let A be the characters of the common ancestor, and B and C the characters subsequently acquired by the race represented by each parent. Then the union would be that of  $AB + AC$ , which would give A the advantage, if for any reason B and C were less than ordinarily powerful. Dr. Max Standfuss, in breeding hybrid moths (*Entomologist*, 1900, p. 341), has found that the phylogenetically oldest

species appear to be prepotent over those of more recent origin. This may be understood if we represent the union as AA + AB, both contributing the same ancestral characters, and one the same modern ones as the ancestral.

A very interesting point brought forward by Professor Ewart is, that in some cases reversion may lead to a sort of rejuvenescence. For instance, "If there are any puppies in a grossly inbred litter that take after a good ancestor several generations removed, they invariably prove the strongest and best." If there is any truth in the idea that in man physical vigor is correlated not infrequently with a certain rusticity of mind, it may be that the phenomenon is one of a similar kind.

T. D. A. COCKERELL.

EAST LAS VEGAS, NEW MEXICO.

*Geological Survey of Canada, General Index to the Reports of Progress, 1863 to 1884.* By D. B. DOWLING, B.A.Sc. Ottawa. 1900. Pp. 475.

In the terms of the prefatory note by Dr. G. M. Dawson, Director of the Geological Survey, "the present General Index begins with the volume of 1863 for which an entirely new index has been made, and embraces the succeeding reports to that of 1882-83-84 inclusive. It covers sixteen volumes and two short summaries, making in all 6,585 pages of text to which more than 31,000 entries are given. It thus provides a ready means of reference to practically the entire body of observations published by the Geological Survey up to the year 1884."

From 1885 to the present time, 'Annual Reports' have been issued by the Department, each of which is separately indexed. The 'General Index' just issued forms publication No. 638, of the Geological Survey and contains 475 pages of text divided into three parts, viz :

Part 1. Districts described in the several reports.

Part 2. Special Examination.

Part 3. The General Index.

These include: (1) The reports analyzed geographically and arranged under Provinces, Counties and Districts, so that under any county or district in a province, a list of refer-

ences to reports, arranged in chronological order, is given. (2) Ores, rocks, minerals or fossils, that have been subjected to assay, analysis, microscopical examination, that were scientifically described. (3) The general index of which the following are the principal points: the arrangement under a reference to a place being usually chronological, while under a subject references will be found alphabetically arranged, or in case of common occurrences, as of iron, fossil, etc., localities may be grouped under provinces.

The 'Reports of Progress of the Geological Survey of Canada' and the 'Annual Reports' of the same contain a vast amount of useful and practical information on the mineral and other natural resources of the Dominion, as do also the maps which accompany these reports, giving in a graphic form the leading geological features of the territory included. This 'General Index' is therefore hailed with delight not only by all who are interested in the resources of the great Dominion as a work which gives ready reference to the various economic products in a series of volumes containing 6,585 pages of text, but also by all students in science who may desire to carry on further researches in the various districts comprised in the reports treated. The amount of time henceforth to be saved in searching for information on the thousand and one points referred to in each of the volumes indexed cannot be over-estimated, and all persons into whose hands this index falls will bless its projector as well as author. An index to all the geological maps referred to in the Reports may be found under the word 'Maps.'

Mr. Dowling's index will also be of special value for bibliographic references, as the work performed by various officers of the Geological Survey from 1866 to 1885 falls under the name of each officer; and, as the readers of the *Ottawa Naturalist* are aware, in Vol. XIV., No. 6, of that Magazine for September, 1900, Mr. Dowling gave a chronological index to the field work done by the officers of the Survey from its commencement to 1865, so that there is now available for ready reference a complete history of geological work done in Canada from 1843, the year when the Geological Survey of Can-



ada was instituted, to the present time. The price of the above is fifty cents. Copies may be obtained from the Librarian of the Geological Survey.

H. M. AMI.

THE CROTONS OF THE UNITED STATES.\*

The United States species of *Croton*, as represented in the principal herbaria of the country, have been monographed by A. M. Ferguson, formerly connected with the Missouri Botanical Garden, now at the University of Texas, whose paper, accompanied by ample analytic keys, and illustrations of all but the most commonly figured species, forms a rather thick octavo paper to constitute a part of the forthcoming 'Twelfth Annual Report of the Missouri Botanical Garden,' where the work was done. In addition to keys and synoptical headings, a citation of necessary synonymy and specimens examined, combined with short but clear descriptions, appears to ensure the easy understanding of the species of a genus that has always afforded a fair number of puzzles to the botanist.

PROCEEDINGS OF THE AMERICAN ASSOCIATION FOR THE ADVANCEMENT OF SCIENCE.

The Proceedings of the 49th meeting of the American Association for the Advancement of Science, edited and published by the permanent secretary, L. O. Howard, make a handsome volume of 500 pages. The volume has as a frontispiece a portrait of the late Edward Orton, who, it will be remembered, died before he was able to give the address of the retiring president at the New York meeting. The volume contains as usual the lists of past officers, the constitution of the Association and lists of members and fellows. There then follow the address of the president, Mr. Grove Karl Gilbert, of the U. S. Geological Survey, and the proceedings of the separate sections, including the addresses of the vice-presidents. The volume concludes with the reports of the secretaries and of the treasurer. It is gratifying to note that the membership at the time of the New York meeting was 1,921, as compared with

\* Ferguson, A. M. 'Crotons of the United States.' (Printed in advance from the Twelfth Annual Report of the Missouri Botanical Garden.) Issued February 16, 1901. Pp. 41, pl. 28.

1,695 the year before. One rather unexpected result of the change in the time of the meeting from August to June has been a delay in the publication of the volume. Immediately after the adjournment of the meeting the members separated widely for their summer vacations; those who did not go to Europe went into the field, and the secretaries of sections were among them. As a result it was impossible for the permanent secretary to get together the manuscript for a large part of the volume until after the return of the secretaries of sections and other members to their homes in the autumn. The volume was all in print, however, by December and would have been distributed before January 1st except for an accident in the bindery which again delayed the general distribution.

BOOKS RECEIVED.

*Proceedings of the American Association for the Advancement of Science, Forty-Ninth Meeting, held at New York, N. Y., June, 1900.* L. O. HOWARD. Easton, Pa., The Chemical Publishing Company. 1900. Pp. 409.

*Lecithoblast und Angioblast der Wirbelthiere.* WILHELM HIS. Leipzig, E. G. Teubner. 1900. Vol. IV. Pp. 328.

*L'Année biologique.* YVES DELAGE. Paris, Schleicher Frères. 1900. Pp. xxxi + 847.

*Report of the Census of Porto Rico for 1899.* LIEUT.-COL. J. P. SANGER. Washington Government Printing Office. 1900. Pp. 417.

*Electric Lighting.* FRANCIS B. CROCKER. New York, D. Van Nostrand Company; London, E. & F. N. Spon. 1901. Vol. II. Pp. vi + 505. \$3.00.

*Anatomy of the Cat.* JACOB REIGHARD and H. S. JENNINGS. New York, Henry Holt & Company. 1901. Pp. xx + 498.

SCIENTIFIC JOURNALS AND ARTICLES.

The *Journal of the Boston Society of Medical Sciences* for January 15th contains 'Notes on the Occurrence of *Anopheles Punctipennis* and *A. Quadrimaculatus* in the Boston Suburbs' by Theobald Smith, 'Notes on *Anopheles*' by Charles S. Minot, and 'Notes on Mosquitoes' by F. P. Gorham. E. R. Le Count presents a 'Report on the Histologic Changes found in the Tissues of Animals Inoculated with *Diplococcus Scarlatinæ* (Class),' stating that they differ from those noted in man by Pearce in

degree rather than character. A paper of very general interest is that on the 'Action of the Larynx in Relation to the Pitch of the Voice' by Thomas Fillebrowne showing that the larynx should *not* rise with the pitch if one wishes to retain the vocal powers. There are a series of abstracts of papers presented at the Indianapolis meeting of the Public Health Association as follows: 'Observations on Methods for the Detection of *B. coli communis* in Water' by E. E. Irons, 'Variation of the Properties of the Colon Bacillus, Isolated from Man' by W. W. Ford, 'Thermal Death Point of the Tubercle Bacillus and its Relation to the Pasteurization of Milk,' by H. L. Russel and E. G. Hastings, 'A Note on the Disinfectant and Deodorant Properties of Ammonium Persulphide,' by M. P. Ravenel and S. H. Gilliland, and 'An Inquiry into the Rôle of the Domestic Animals in the Causation of Typhoid Fever,' by W. R. Stokes and John S. Fulton.

IN *The Popular Science Monthly* for March Simon Newcomb continues his 'Chapters on the Stars' this instalment being devoted to statistical studies of proper motions, concluding that, so far as we can judge, our own system is near the center of the stellar universe. R. H. Thurston considers 'The Law of Substance,' substance being what we are familiar with as 'matter.' Dudley Allen Sargent discusses 'The Height and Weight of the Cuban Teachers' who were in Cambridge last summer, showing that in these points they fall below the average of our own teachers. The reasons for this and the remedy are suggested. Hudson Maxim treats of 'Throwing a High Explosive from Powder Guns' considering that this problem and that of firing high explosives through armor plate have been successfully solved. Harold W. Fairbanks describes 'Pyramid Lake, Nevada' and its curious tufaceous formations, and William H. Hobbs deals with 'The Geologist Awheel' believing that topographical work may be greatly expedited by the use of the bicycle. 'The Formation of Habits in the Turtle' by Robert Mearns Yerkes, describes a series of experiments showing how a turtle learned, or acquired, the shortest route around a number of obstacles to its nest. In

'The Science of Distances,' being the address of the President of the Geographical Section of the British Association, George S. Robertson shows how steam and electricity have shortened the time between distant places and hints at what may be hoped for in the future. Finally Havelock Ellis continues 'A Study of British Genius,' this instalment being devoted to a consideration of the influence of birth and race. Perhaps the most interesting of the brief articles are those discussing the relations between the Government and science.

#### SOCIETIES AND ACADEMIES.

##### GEOLOGICAL SOCIETY OF WASHINGTON.

THE 110th meeting was held at the Cosmos Club, February 13, 1901. The following papers were presented:

*Age of the Coals at Tipton, Blair County, Pennsylvania:* MR. DAVID WHITE.

It was shown that the coals occur in a down-faulted block of coal measure beds surrounded by Pocous strata.

*Production of the B. & M. Plant at Great Falls, Montana:* MR. R. H. CHAPMAN.

A view of the reduction works was shown and specimens of the copper products exhibited.

*Notes on Two Desert Mines in Southern Nevada and Utah:* MR. S. F. EMMONS.

The Delamar mine is situated on the western slopes of the Meadow Valley Range in southeastern Nevada. Its ore-body occurs in a heavy series of quartzite beds of Cambrian age, that strike in a northwesterly direction and dip 23° southeast. The so-called vein is a fracture plane whose strike varies but slightly from that of the enclosing quartzite, but its dip is 70° to 80° to the northwest, or nearly at right angles to the strata. It neither has vein-filling, nor is it mineralized to any considerable extent, but has zones or chimneys of crushed quartzite along it that have been mineralized and carry the ore values. Two granite-porphry dikes about 30 to 40 feet in width run nearly at right angles to the main fracture, and are crossed by a narrow dike 6 to 10 feet wide of basic lamprophyric rock, so decomposed that its mineral composi-

tion is difficult to recognize. It is sometimes called 'gouge' by the miners. The main fracture plane follows this dike, generally within its walls. The principal ore-chimney is a zone of crushed quartzite around the intersection of this dike and fracture plane with the first granite porphyry dike, where it approaches most closely to the second. All the dikes show evidences of deformation since their intrusion. Smaller ore bodies are found in the hanging wall of the dike to the northward and generally only a few feet in width, while the greater ore chimney, which is divided into four parts by the intersecting and practically barren dikes, has an area of about 200 feet square in horizontal section. The ore is an intensely crushed quartzite, recemented and largely replaced by silica, so that often nothing of the original granular structure of the quartzite is distinguishable. The unoxidized ore shows, besides quartz, only a little finely divided pyrite, very little microscopic chalcopyrite and some telluride in spots. The interesting feature of the mine is the variation in the tenor of its ore, whose values are mainly in gold, the bullion being only 300 fine. In a broad general way it may be said that the values increased downwards to the 700-foot level from \$20 to \$40 and often to \$70, to the ton, small lots running very much higher. From there downwards the values have decreased to about \$6 or \$8 at the tenth level, and to only \$1 to \$3 dollars at the fifteenth and sixteenth levels. It is evidently a case of enrichment by gradual leaching down of the precious metals, but as the country is so dry that there is never any moisture in the mine, it must be assumed that this leaching took place in an earlier geologic period, when there was greater precipitation; presumably during the Bonneville period.

The Horn silver mine, in southwest Utah, occurs in a region of very much more complicated geological structure. The Grampian Hills at the south end of the San Francisco Mountains consist of more or less crystalline Paleozoic limestone into which a monzonite mass (locally called syenite) has been intruded in stock-like form. A broad contact zone between limestone and monzonite (locally called andesite) is made up of a dark brown

rock, consisting mainly of garnet with many other contact minerals, notably, a white, fibrous tremolite (locally called needle spar).

Opposite the mining hamlet of Frisco, an east and west fault has cut through limestone and monzonite, raising the latter so that it abuts against the former. Along the east base of the hills is a later fault plane, running magnetic north and south, along which more recent andesitic breccias form the hanging-wall, and limestone or monzonite, as the case may be, the foot-wall, the fault plane having a steep dip to the eastward. It is this fault plane that constitutes the Hornsilver vein. The fault fissure or zone varies in width from a maximum of 90 feet down to one or two feet, and has been opened to a depth of 1,600 feet. It is by no means all ore, but consists in great measure of crushed wall-rock, limestone or andesite, as the case may be, but so much altered that its original character is difficult to determine. The ore bodies which have been of great size were largely replacements of this material. It is well known that in its early history, about 1880 to 1885, the mine produced enormous masses of rich silver-lead ores and paid some four millions in dividends in spite of high costs of production, due to its situation in the midst of the desert.

The interesting feature to which the speaker called attention is that whereas neither copper nor zinc was recognized as a constituent of the ore in the upper levels, the main values of late years have been found in a very rich body of copper ore, largely copper glance, extending from 650 down to 750 feet. Moreover, at 500 feet, zinc minerals began to show in small amount, and now in the lower levels the largest ore masses carry 40 to 50 per cent. of zinc, with 6 or 8 per cent. of silver, it being estimated that they have 300,000 tons of this ore in sight. In the deeper part of the mine, while the fault zone holds its width in the main chimney, the ore values have shrunk below the workable point. This is evidently another instance of the leaching down and concentration into the middle levels of the mine of the more soluble salts of copper and zinc, and their reprecipitation in more or less segregated bodies.

*The Asphalt and Bituminous Rock Deposits of the United States*: GEO. H. ELDRIDGE.

The asphalts, by this meaning the several varieties of purer hydrocarbon compounds, such as uintaite, grahamite, etc., occur in vein form in rocks of Ordovician, Carboniferous and Tertiary ages. They are found in West Virginia, Indian Territory, Colorado, Utah and California. The most remarkable veins are in Utah near the Colorado line, where a maximum width of 18 feet and an uninterrupted length of 10 miles for a single vein have been observed. In California they occur in proximity to the developed oil fields, and the material is here of softer nature than that found in the veins of Utah and elsewhere. Where the veins occur in shales they are irregular and interrupted.

The bituminous rocks embrace both sandstones and limestones. The limestones as yet known are confined to Indian Territory, Texas and Utah; in Texas, in the upper part of the Ordovician, and in Utah, in the Green River Tertiary formation. Those of Indian Territory are conspicuous for their thickness and extent. At one point a bed of 350 feet, impregnated from bottom to top, was observed, having a lineal extent of something over two miles, with considerable variation in the thickness of the bed. Bituminous sandstones are the most generally distributed in the United States, occurring of especial richness in Kentucky, Indian Territory, and in the Coast ranges of southern California. The percentage of bitumen contained in these rocks varies up to a maximum of 14 in the limestones and 20 in the sandstones.

F. L. RANSOME,  
DAVID WHITE,  
Secretaries.

BIOLOGICAL SOCIETY OF WASHINGTON.

THE 355th meeting was held on Saturday evening, February 23rd.

Under the head of notes, B. W. Evermann spoke of the aquatic vegetation observed during the winter at Lake Maxinkuckee, Ill., saying that it remained green and flourishing at a late date. The manner in which the reproductive buds were formed on the species of *Potamogeton* and *Valisneria* was described, and it

was stated that it was these buds of the wild celery that were sought after by the coots and ducks.

W. H. Ashmead stated that the examination of the Hymenoptera collected by Trevor Kincaid of the Harriman Alaskan Expedition had raised the number of species known to occur in Alaska from 28 to 318, 195 of which were new. Four European species were noted for the first time as occurring in Alaska, while 30 of the genera had never before been reported in North America.

E. L. Morris exhibited photographs of four new species of *Plantago* stating that these pictures, which were remarkable for their distinctness of outline and detail, were for the purpose of supplying the U. S. National Museum with accurate figures of types which belong to other collections.

[F. A. Lucas described 'A Fossil, Flightless Auk' obtained at Los Angeles, Cal., from beds stated by Mr. Dall to be of Upper Miocene, or Lower Pliocene age. The bird was represented by only the proximal part of the humerus, but this showed it to have been somewhat less in size than the Great Auk and more highly specialized, the humerus being shorter, more flattened and more curved, with sharper muscular ridges than the corresponding bone in that species. The name *Mancalla californiensis* was proposed for the fossil auk, and its nearest living relative stated to be the California Murre. The specimen will be described in detail in the Proceedings of the U. S. National Museum.]

W. P. Hay presented a paper 'On the Distribution and Classification of the North American Crayfishes' giving first a brief review of the classification of the Astacoidea in which four families were recognized—Eryonidae, Homaridae, Parastacidae and Astacidae. In the Astacidae the three genera *Astacus*, *Cambaroides* and *Cambarus* were described and their distribution commented on.

The American species of *Astacus* and *Cambarus* were then taken up and a few points on the life history of these animals were given. It was stated that the five groups of Faxon are natural and well marked and are worthy of subgeneric rank at least. Contrary to Dr.

Faxon's belief, the author contended that the fifth group of crayfish, including southern United States and Mexican species, is the most generalized and resembles *Cambaroides* most closely. This would seem to indicate that the theories of Huxley and Faxon to explain the distribution of the Astacidae will not hold good and that the original home of the Astacine progenitors was in southern seas and invaded the continents from that direction. It was further stated that the specialization of *Cambarus* is probably much more ancient than the specialization of *Cambaroides*, and that the resemblance between *Cambaroides* and *Cambarus* is accidental and does not indicate a close relationship.

M. B. Waite spoke of the 'Influence of Vegetation on the Sand Formations of the Michigan Lake Shores,' his remarks being illustrated by lantern slides. He showed how dunes may originate by the sand being at first held in check by grass, which grows upward and outward as the sand accumulates, and illustrated the gradual progress inland of dunes and the manner in which the sand moved slowly forward in great waves to overwhelm the adjacent country.

F. A. LUCAS.

#### PHILOSOPHICAL SOCIETY OF WASHINGTON.

THE 530th meeting of the Society was held February 16, 1901. Mr. R. H. Strother called attention to the fact there are now three processes of making phonographic records that promise to be permanent, so that the early idea of making records of speech for posterity now seems feasible.

Mr. R. A. Harris read a paper entitled, 'A Few Questions in Hydrodynamics.' This reviewed briefly the kinds of problems in liquid wave motion which have been considered in articles and treatises on hydrodynamics. But its chief object was to point out the lack of attention given to oscillations in bodies of water having incomplete boundaries, although a somewhat analogous subject, viz., that of the open organ pipe, had received much attention. The behavior of water in straits is also a neglected subject. The case treated by Airy really applies only to motions in straits not extremely short, and where the bodies connected are com-

paratively deep. These and other hydrodynamical questions, it was contended, must be investigated before satisfactory progress can be made in the theory of tides.

Mr. J. F. Hayford presented the 'Recent Progress in Geodesy,' referring to the triangulation in progress on the 98th meridian; the connection of the principal United States and European stations by pendulum observations; the connection recently made between several independent systems of precise levels, so that the elevations of some 4,000 places have now been published; and the results of the calculations of the axes of the terrestrial spheroid based on the United States observations. [This paper appeared in SCIENCE for March 8th.] A spirited discussion followed regarding the accuracy of the new and rapid base-line measurements, and the leveling between the Gulf of Mexico and the Atlantic Ocean.

CHARLES K. WEAD,  
Secretary.

#### AMERICAN MATHEMATICAL SOCIETY.

A REGULAR meeting of the American Mathematical Society was held at Columbia University, New York City, on Saturday, February 23, 1901. About thirty persons attended the two sessions. The President of the Society, Professor Eliakim Hastings Moore, occupied the chair. The following persons were elected to membership: Professor John F. Downey, University of Minnesota; Professor F. C. Ferry, Williams College; Mr. H. T. Gerrans, M.A., Oxford University; Mr. Edwin Haviland, Jr., New York City; Professor A. E. H. Love, Oxford University; Mr. V. R. Thyagarajaiyar, Bangalore, India. Two applications for membership were received.

The following papers were presented at this meeting:

- (1) Dr. H. E. HAWKES: 'Note on Hamilton's determination of irrational numbers.'
- (2) Professor E. B. VAN VLECK: 'On the convergence of continued fractions with complex elements.'
- (3) Dr. M. B. PORTER: 'On linear homogeneous finite difference equations, with applications to certain theorems of Sturm.'

(4) Professor L. E. DICKSON: 'Concerning real and complex continuous groups.'

(5) Professor E. O. LOVETT: 'An application of continuous groups to non-euclidean geometry.'

(6) Professor E. O. LOVETT: 'Contact transformations which change asymptotic lines into lines of curvature.'

(7) Professor H. B. NEWSON: 'Indirect circular transformations and mixed groups.'

(8) Mr. W. B. FITE: 'On metabelian groups that cannot be groups of cogredient isomorphisms' (preliminary communication).

(9) Dr. EDWARD KASNER: 'On algebraic potential curves.'

(10) Professor MAXIME BÔCHER: 'Green's functions in space of one dimension.'

(11) Dr. H. E. HAWKES: 'Estimate of Benjamin Peirce's linear associative algebra.'

(12) Dr. G. A. MILLER: 'On holomorphisms and primitive roots.'

(13) Dr. EDWARD KASNER: 'Theorems on collinear lines in space.'

(14) Mr. C. W. M. BLACK: 'Decomposition of a form in  $n$  variables in an arbitrary domain with respect to a prime ideal modulus.'

(15) Professor MAXIME BÔCHER: 'An elementary proof of a theorem of Sturm.'

(16) Dr. L. P. EISENHART: 'Surfaces whose first and second fundamental forms are the second and first respectively of another surface.'

(17) Dr. L. P. EISENHART: 'Possible triply asymptotic systems of surfaces.'

(18) Dr. H. F. STECKER: 'On the determination of surfaces capable of conformal representation upon the plane in such a manner that geodesic lines are represented by algebraic curves.'

(19) Professor MAXIME BÔCHER: 'Non-oscillatory linear differential equations of the second order.'

The next regular meeting of the Society will be held on Saturday, April 27th. The Chicago section will meet at the University of Chicago, on Saturday, April 6th.

F. N. COLE,  
*Secretary.*

THE ACADEMY OF SCIENCE OF ST. LOUIS.

At the meeting of the Academy of Science of February 18th, 1901, 23 persons present, Pro-

fessor J. L. VanOrnum read an address of general interest, summarizing the progress made in engineering during the nineteenth century.

A paper entitled 'Florida lichens,' by Professor P. H. Rolfs, was presented by title.

Professor F. E. Nipher showed two photographic negatives, developed by an ordinary pyro developer. One plate had been exposed in a printing frame for 1,000 seconds at a distance of a meter from a 300-candle lamp. It was then treated for ten minutes in a chromic acid bath having ten drops of an eight-per-cent. solution of chromic acid to three ounces of water. This treatment was in the dark-room. The plate was then developed in the dark-room.

The exposure of the other plate had been equivalent to a tenth of a second at the same distance from the lamp, and was exposed under the same plate. This plate developed normally in a pyro developer, having six drops of bromide and six drops of potassium ferro cyanide, both in ten-per-cent. solutions. The over-exposed plate showed more of detail, but the contrasts were less strong than in the plate with normal exposure. It looked like a slightly under-exposed plate.

When a plate with this exposure is treated with the chromic acid bath while in the light, and is then developed in the light, a positive picture results. The chromic acid bath may be replaced by ten drops of saturated potassium bichromate solution, and four drops of common C. P. nitric acid, to three ounces (90 cc.) of water. There is reason to believe that any camera exposure which was intended to be correct may be developed as a positive in the light by such methods. It is certain that it may be hauled as a negative in the dark-room.

Professor Nipher stated that if either a negative or a positive had been started and had resulted in a failure, due to improper treatment, the picture with the fog on the plate might be chemically destroyed by chromic acid, and the picture might be redeveloped in either case either as a negative in the dark-room or as a positive in the light.

It was also stated that one plate had been developed as a superb negative at a distance of a meter from a 300-candle lamp. This case was

very remarkable, because, on account of an accident in the treatment, a failure or a poor positive had been expected. Several repetitions of this treatment had failed to yield this result again.

It is frequently observed that with a strong pyrocatechin developer the picture will start as a negative in the light, and will reach a fair degree of excellence, and then reverse. This is in the nature of an oscillation such as is known in electric discharges. The phenomenon is not observed in a weaker or in a more slowly acting bath. The anomalous case before referred to could hardly be accounted for in this way, because the picture developed very slowly in a normal hydrochinon bath, and grew steadily better until it was sharply defined on the back of the film. This case is still being examined.

A short biographic sketch of the late Charles Pierre Chouteau, a charter member of the Academy, who in its early years, as the western representative of the American Fur Company, contributed many important collections to its Museum, was presented by a committee appointed for that purpose.

Two persons were elected to active membership.

WILLIAM TRELEASE,  
Recording Secretary.

#### DISCUSSION AND CORRESPONDENCE.

##### A FIELD FOR MOSQUITO THEORISTS.

##### CLIMATIC CONDITIONS ON THE UPPER CONGO.

TO THE EDITOR OF SCIENCE:—The following extracts from letters of Father Grison, a Missionary at Stanley Falls, and Mg'r Roelens, Vicaire Apostolique of the Upper Congo, addressed to the Société Antiesclavagiste of Belgium, may be of interest.

WASHINGTON, D. C.,

G. R. S.

February 12th.

At Stanley Falls the climate is very agreeable, but is formidable, as the victims of fever are too numerous. Europeans have very inaccurate ideas of tropical temperatures. I have passed eight years at the equator on the Pacific Coast, and have never seen the mercury above 29° C.

Here the maximum is 32° C. and the nights are deliciously cool. This is our climate all the year.

There is, however, a reverse to this picture. We

have frequent tempests of indescribable violence; I have counted in one minute during a diluvial rain and continuous thunder, sixty-six flashes of lightning; and have seen in two hours within a radius of a few hundred meters, ten *coup de foudres*.

Mg'r Roelens at M. Pala, writes:

The work of the Mission allows me little leisure for anything else than an occasional attack of fever.

The fever, however, does not ask if you have the leisure, but imposes it at will, and unhappily, a little too frequently.

Dame fever reigns as mistress of the country.

In the rainy season, from November to May, her tyranny is most severely felt; no one escapes attack; the newly-arrived are most susceptible, but the old residents are not completely immune.

Those who have been resident more than a year are the chosen victims of the terrible hæmaturic fever (Malarial hæmaturic, or 'Swamp fever.') In five years' residence I have had the fever fourteen times! For the last two years, fortunately, it has left me in peace.

Brother Stanislas, who has resided here since 1893, is now sick with it for the twenty-fifth time.

It is an old saying here that the third attack is always mortal.

We, however, have passed the period when our lives are despaired of; this result is due to the treatment we have followed here.

Since 1892 the missionaries of the Upper Congo have applied this treatment to seventy-five cases of this fever, of which five only have been fatal.

Beside this there are no other grave climatic dangers for Europeans. The dysentery, which elsewhere is a serious menace, does not occur here.

I suspect that the English at the south of us find this malady more frequently in their boxes of conserves, and in *la dive bouteille*.

At this moment an epidemic of smallpox is invading the country. It is said here that this recurs every seven years, and attacks all who escaped the previous invasion.

We cannot depend upon the vaccine of Europe, because of the long voyage and the great heat.

I have given it many trials without result.

#### SHORTER ARTICLES.

##### ARE THE AUSTRALIAN MARSUPIALIA OF OPOSUM DERIVATION.

At the last meeting of the American Association for the Advancement of Science, in June, 1900, the writer presented some reasons in

favor of the view that the Australian Marsupials have been derived from opossum-like ancestors. Since then the opportunity has been afforded of examining the case in greater detail, and it may accordingly be of interest to notice certain of the results obtained.

As nearly every writer who has dealt with the group has observed, the Australian Marsupials exhibit extensive resemblances to Placentals in respect to certain features of their outer organization, notably the adaptive modifications of the teeth and feet. By means of a very reliable, though roundabout method, this fact may be made effective use of in determining the character of the Marsupial ancestors. Thus, by reference to the paleontological history of Placentals, it is possible to recognize the sequence of events in the development of their structural modifications, and from this to infer a similar sequence in the similar modifications of Marsupials. Then, by carefully excluding those forms which show obvious signs of degeneration, it is possible to select from the others those modifications which are primitive or original from those which are secondary or derived.

Such an analysis is easily effected because the Australian Marsupials, notwithstanding their great diversity of form, constitute an extremely simple and homogeneous group. They show no indications of having been derived from more than one ancestral type.

The stem-form is found to have possessed the following characters, or more primitive ones: Dental formula

$$i. \frac{5}{3} \quad c. \frac{1}{1} \quad p. \frac{3}{3} \quad m. \frac{4}{4};$$

upper molar teeth triangular, each with three main cusps and an outer row of incipient styles; lower molar teeth each with an anterior triangle of three main cusps, an antero-external shelf, and a posterior heel with three terminal cusps. Foot with the great toe opposable, but with the other digits normal.

These characters are not found together in any one of the Australian forms, but, with one minor exception,\* are exactly reproduced in the American opossums.

\*The opossums have four lower incisor teeth.

In addition, it appears entirely probable that other structural modifications of the Marsupial organization are also departures from an opossum type. The anteriorly opening pouch of the kangaroos, wallabies, and phalangers, and the posteriorly opening pouch of the bandicoots appear to be modifications of a type like that met with in the opossums, where the opening of the pouch is directed vertically downwards. This condition has been preserved in the Australian dasyures. Again, it is probable that a scaly prehensile tail, like that of the opossums, has to be ascribed to the Marsupial stem-form, since various grades of an apparently disappearing prehensilism are to be met with in the phalangers.

There is also the significant fact that during the Oligocene period opossums were widely distributed throughout the northern hemisphere and that at a slightly later period opossum-like forms (*Microbiotheriidae*) existed in South America. To this may now be added the probability that it was at about the middle of the Tertiary that the Marsupial radiation began. Of the latter there is the following evidence: The most advanced modifications of the teeth and feet in Marsupials (kangaroos) are decidedly primitive as compared with the most advanced modifications of the same structures in Placentals (Ungulates, especially the horses). Furthermore, although the Marsupials possess the representative characters of Placental orders, it is barely possible to separate them, in some cases, into families. Both of these facts indicate that the Marsupial radiation has been of much shorter duration than that of the Placentals, and therefore, if the Placental radiation began in the Cretaceous or early Eocene, the Marsupial radiation, as indicated above, could not have begun before the middle of the Tertiary.

If these indications are reliable, it would appear that the entire Marsupial fauna of Australia has been derived by a comparatively recent adaptive radiation from a single ancestral type, of which the American opossums are the existing representatives.

Naturally the greatest objection to such a view is the fact that there are no opossums in Australia at the present time. This difficulty is, however, quite a superficial one. If we



imagine the opossums to have originally gained access to the region, is it not preeminently fitting that, in establishing the foundation of an extremely comprehensive adaptive radiation, and under the favorable conditions of an absolute freedom from competition, they should have thrown aside their original didelphyid characters? And especially is this conceivable when we realize that the differences of structure separating the opossums from the most primitive of the Australian forms (dasyures) are extremely slight.

However unprogressive the opossums may at first sight appear to be, they are still plastic types. That they are at the present time attempting to radiate in South America is apparent from the numerous subgeneric divisions which it has been found necessary to establish,\* and more especially from the fact that one form (*Chironectes*) has already become completely adapted to an aquatic life.†

The above conception approximates closely the general opinion, expressed by Lydekker,‡ in 1896, that the opossums and dasyures are the descendants of a common ancestral stock, but differs in assuming that these ancestors were opossums, and that they were formerly present in Australia. If we assign to the ancestors of the dasyures characters which would allow them to constitute the Marsupial prototype, they would no longer be Dasyures, but opossums. Ameghino has suggested the South American *Microbiotheriidae* as ancestral to the dasyures, and Bernard (*Éléments de paléontologie*) regards the border as opossums.

B. ARTHUR BENSLEY.

COLUMBIA UNIVERSITY,  
November 5, 1900.

WORK AT THE MARINE BIOLOGICAL LABORATORY OF WOOD'S HOLL, 1900.

THE course in physiology should be classified as a kind of research. The same is true in large measure of the course in embryology. In both

\* Cf. Thomas, O., 'British Museum Catalogue of Marsupialia and Monotremata,' London, 1888, pp. 317-322.

† Cf. Gadou, H., 'On the systematic position of *Notoryctes typhlops*, P. Z. S.,' London, 1892, p. 370.

‡ Lydekker, R., 'A Geographic History Mammals,' Cambridge, 1896, p. 55.

of these courses, for instance, Dr. Loeb's experiments on artificial parthenogenesis were successfully repeated. Both of these courses are attracting students from medical colleges who feel the need of getting away from the strictly conventional physiology and embryology, into touch with the new lines opening up—in physiology, with the comparative study of biokinetics and in embryology with the new lines of thought introduced by experimental work and by the studies in cell-lineage. Both of these courses, as given here, are largely the outcome of the results of research of preceding years by members of the laboratory, who are themselves concerned in giving the instruction. They therefore represent the spirit of the laboratory along these two lines of investigation.

As regards investigation proper:—In PHYSIOLOGY, Dr. Loeb has continued his experiments on artificial parthenogenesis and has succeeded in inducing the development of unfertilized eggs of Annelids (see a recent number of SCIENCE). Other lines of work in physiology concern the chemical stimulation of nerves, the physiological effects of inorganic salts on the rhythmical activity of living tissues, similar studies on ciliary motion; and work on regeneration by several investigators.

In CYTOLOGY: work on *spermatogenesis* has been carried on by Dr. Montgomery, Mr. Downing and Miss Wallace; on *ovogenesis* by Mr. Arthur E. Hunt, Dr. H. E. Crampton and Dr. C. M. Clapp; on *fertilization* by Dr. Conklin, Miss Katharine Foot, Miss Strobell, Dr. F. R. Lillie, Mr. Martin Smallwood. Dr. E. B. Wilson has brought here his experimental work on fertilization and cleavage in the sea urchin eggs.

In EMBRYOLOGY work has been carried on in various lines: *Annelids* by Dr. A. C. Treadwell and Mr. R. S. Lillie, *parasitic copepods* by Mr. Edward Rynearson, *Cirripedia* by Mr. M. A. Bigelow, *fishes* by Dr. Cornelia M. Clapp, Miss Robinson, Dr. Neal and Miss A. C. Smith, *Monotremata* by Mr. B. A. Bensley, *Histogenesis of gastric glands of Amphibia* by Dr. R. R. Bensley, *Planaria* by Mr. W. C. Curtis, *Nucula* by G. A. Drew, *Parasitic Isopods* by J. R. Murlin.

The work in NEUROLOGY included the following: V. E. McCaskill on nervous system and metamerism of *Hirudo*, Mr. Fling

on *Lumbricus*, Mrs. M. A. Bigelow on Olfactory nerves of Vertebrates, Dr. Neal on origin of motor nerves in Selachians, Dr. A. D. Morrill on histology of nervous system in planarians, Mr. Yerkes on physiology of pineal eye in lizards, Miss Marion Hubbard on the nervous system of *Dero*.

In ZOOLOGY: A monograph on *Arenicola cristata* is under way: The nephridia are being studied from the points of view of anatomy and embryology by Mr. R. S. Lillie, the spermatogenesis by Mr. E. R. Downing, Oögenesis by Mr. Arthur E. Hunt, Organs of circulation by Miss Emma Keith. The first part of this monograph, the embryology, by Dr. C. M. Child, is already published and other parts, including the ones mentioned, are well under way. The zoological studies not already mentioned include work on Coelenterata by Dr. Murbach, on *Hemiptera* by Mr. W. M. Chester, on *Pycnogonida* by Mr. L. J. Cole, on *Nemertea* by Miss C. B. Thompson, on *Pectinatella* by Miss A. W. Wilcox, on *Acmæa* by Miss M. A. Willcox, on *Amphipoda* by Dr. S. J. Holmes, on *Limulus* by Dr. Wm. Patten, on Lamelli-branch gill by Dr. E. L. Rice, on *Annelids* by Dr. A. L. Treadwell.

In variation statistics and allied subjects, Miss M. M. Eutemann on *Polistes*, Dr. E. C. Edwards on *Synapta*, Dr. H. E. Crampton on Lepidoptera, Miss A. C. Dimon on snails.

In BOTANY: Cytological work has been carried on by Dr. B. M. Davis, Miss C. M. Derick, Dr. Walter Swingle.

Physiological work has been carried on by Dr. R. H. True and Mr. Roberts. Dr. George T. Moore and Dr. Erwin Smith have also been working in this department.

#### NOTES ON INORGANIC CHEMISTRY.

FROM the current chemical journals the following notes are taken:

PROFESSOR FITTICA still persists in his claims of being able to change phosphorus into arsenic and antimony and gives  $PN_2O$  as the true formula of arsenic, and  $P_2N_2O_2$  as that of antimony. Christomanos, preparing arsenic, according to Fittica's directions, from commercial phosphorus, tests it without success for the presence of phosphorus and nitrogen, but Fittica replies

that this should not occasion surprise, since methods used for testing in one class of compounds often fail when applied to those in which the nitrogen is more firmly united.

THE cause of the much discussed poisonous qualities of arsenical wall papers has been shown by Biginelli to be due to the evolution of a gas, diethyl arsin, formed under the influence of the mold *Penicillium brevicaulis*, which thrives on arsenic, and develops on arsenical papers.

SOME time since reference was made in these columns to the work of H. J. Möller on the protective value of different colored glasses for chemical and drug bottles. His former method was photo-chemical, but he now finds the use of the spectroscope equally satisfactory, and much simpler, a pocket spectroscope answering every purpose. Glasses have a protective value in proportion as they absorb the blue and violet light from the line F to the line H. Dark red glass is the best but most expensive; the dark olive-green of cheap bottles is very satisfactory; dark brown-yellow bottles are effective, but lighter shades of brown, green or blue have little value.

THE claims of Desgrez and Balthazard for sodium peroxid as a regenerator of the air in submarine navigation have caused Jaubert to claim priority, as having been at work on the problem for more than three years. According to the latter, however, sodium peroxid has many disadvantages, but he expects in the near future to publish results attained with other substances which are more effective, and cheaper than even compressed oxygen.

IT has been noticed at various times during the past four years that the water of the river Rhone exhibits certain reactions characteristic of aldehydes. This is found by Causse to be due to the presence of ferrous oxy-thio-carbonate  $FeCO_2S$ , which is formed by the combination of carbon dioxide with ferrous sulfid. The latter results from the reduction of sulfates by organic matter. The compound is broken up by distillation, or on standing, with the formation of an ocherous deposit.

THE reduction of sulfates in water to hydrogen sulfid has been supposed to be due to the action of Beijerinck's *Spirillum desulfuricans*,

but this is questioned by Saltet, who finds that different micro-organisms are concerned in the process, and that the reduction proceeds in stages, as is the case with the reduction of nitrates to ammonia. Saltet has isolated a new micro-organism, *Bacillus desulfuricans*, which reduces sulfates to sulfites, but produces no hydrogen sulfid.

It has been found by Matignon that metallic magnesium liberates from their oxids not only thorium, cerium and lanthanum, but also praseodymium, neodymium and samarium. Nitrogen, but not argon, is rapidly absorbed by all of these metals. When the last three are obtained from their oxids in the presence of hydrogen, they unite with it to form hydrids, which are dissociated when strongly heated. Moissan finds that the carbid of samarium,  $\text{SmC}_2$ , can be formed in the electric furnace in minute, transparent, yellow, hexagonal crystals. It is decomposed by water, the chief gaseous product being acetylene, though considerable hydrogen and members of the paraffin series are also formed. In this action it closely resembles the carbid of yttrium.

THE fact that Dewar has found hydrogen to be a constituent of the atmosphere gives much interest to the discovery of Gantier, that hydrogen is formed by the action of water on granitic rocks at temperatures considerably below a red heat. In one experiment a granite rock was heated with phosphoric acid and gave 1,400 cc. of gas per kilo, 916 cc. of which was hydrogen. With water, the quantity liberated is somewhat less. Ammonia is formed at the same time, and Gantier concludes that both these gases are derived from the action of water on nitrids, chiefly iron nitrid, though possibly some of the hydrogen may come from carbides. Matteucci found during a recent eruption of Vesuvius, pieces of rock, coated with ammonium chlorid and iron nitrid, which would seem to show a close relation between these substances.

IN a short paper in the *Berichte*, Giesel confirms the observation of Walkhoff as to the effect of radio-active substances on the skin, similar to that of the Röntgen rays. He placed a celloid capsule containing a quarter of a gram of radium, under his arm, and in two

hours a slight reddening was apparent. In the course of two or three weeks considerable inflammation was present, with darkening, and finally loss of the skin. A similar action was found to take place on the leaves of living plants, and salts, glass and paper were also affected.

J. L. H.

#### ZOOLOGICAL NOTES.

DR. ANTONIO PORTA, of the Institute of Zoology and Comparative Anatomy at the University of Parma, has lately published in the Proceedings of the Royal Institute of Science and letters of Lombardy his researches on *Aphrophora spumaria* and, in a footnote, he says, "I had already finished the present paper when I received a pamphlet by Professor Morse in which he discusses the formation of the froth in the *Aphrophora spumaria*. It was with genuine satisfaction that I found there a confirmation of observations that I had made. Moreover, I repeated one of his excellent experiments, which leaves no doubt whatever of the fact that the insect emits a liquid only. Placing a larva on a piece of absorbent paper in order to dry it and then upon a glass, if we allow a drop of our saliva to fall upon it, it begins to fill this liquid with air-bubbles."

It is a curious fact that Mr. Morse gave an account of the manner in which the so-called spit-insect makes the froth on grass in his 'First Book of Zoology' twenty-five years ago. German editions appeared in Stuttgart and Berlin, an English edition was also published, and finally the book was translated into Japanese, and yet every general work on entomology has repeated the erroneous ideas regarding the habits of this creature. Even the last volume of the Cambridge Natural History series continues the error. In May of last year Mr. Morse published in the *Popular Science Monthly* an extended account with illustrations explaining more in detail the habits of the larva, and its method of forming the froth and it is to this paper that the Italian naturalist refers.

#### NOVA PERSEI.

PROFESSOR EDWIN B. FROST writes to the *Astronomical Journal* from Dartmouth College,

under the date of February 25th, in regard to the new star as follows: "This brilliant object attracted my attention at eleven o'clock on the evening of February 22d, before the receipt of the announcement of its discovery by Dr. Anderson. It was at that time to my eye brighter than a standard first magnitude star, and showed a distinct yellowish color, recalling to my mind the shade of *Nova Aurigæ*. It was cloudy here on the 23d, and the spectrum was first examined, between clouds, on the 24th, from 6<sup>h</sup> 30<sup>m</sup> to 10<sup>h</sup> 30<sup>m</sup> E.S.T. The observations were made with a McClean direct-vision star spectroscope attached to the nine-inch refractor of the Dartmouth Observatory. The general appearance of the visual spectrum was quite similar to that of *Nova Aurigæ*, with the bright components of the doubled lines on the less refrangible side (toward red). The dark components appeared relatively more intense, however, than in case of *Nova Aurigæ*, probably in great part a result of the superior brightness of the present star. The dark band on the more refrangible side of *C* was especially broad, much more so than in Campbell's drawing of the visual spectrum of *Nova Aurigæ*. Although the spectroscope employed does not permit micrometer settings to be made, the identification would seem to be sufficiently exact of the hydrogen lines *H $\alpha$*  and *H $\beta$* , the sodium lines at *D*, the magnesium group *b* (in whole or part), and probably the strong line at  $\lambda$  5016—all these being represented by dark and bright components. Numerous other lines were seen which can not yet be identified. Singularly enough, the helium line *D<sub>3</sub>* was very faint or absent (the identification of the sodium lines being assumed). This was also the case with *Nova Aurigæ*."

THE ASSOCIATION OF AMERICAN UNIVERSITIES.\*

I HAVE the honor to report upon the second annual meeting of the Association of American Universities, which I attended by your designation as the representative of Columbia University.

The meeting was held at Chicago, February

\* Report of Professor Nicholas Murray Butler, delegate from Columbia University to President Low.

26-28, 1901. The opening session was held at Chicago University, and the subsequent sessions at the Fine Arts Building on Michigan Avenue. Each of the fourteen institutions represented in the Association was represented by one or more delegates. Each session was well attended by the delegates, and the discussions were practical and earnest. Newspaper reporters and the general public were excluded from the sessions, which, therefore, took on the very helpful form of a conference or a committee meeting. At the close of each session the Secretary gave out to the press such information as he thought proper.

The three topics chiefly discussed were: (1) inter-university migration of graduate students; (2) fellowship; and, (3) the examination for the degree of doctor of philosophy.

Upon each of these topics a short report was presented by a delegate designated in advance for the purpose. Each discussion brought out the details of the practice of the several institutions in regard to each of the matters considered, and while the Association refrained from passing resolutions, certain conclusions were arrived at by what was substantially unanimous consent.

It was held in regard to the first topic that it is wise to promote by all possible means the inter-university migration of graduate students, to the end that they may come under the guidance of teachers of varying points of view, and so may receive the broadest possible introduction to their chosen field of study. The only limitation suggested upon this migration was that circumstances being what they are, it might be unprofitable to the student for it to continue after he had made some progress upon his dissertation.

As regards the question of fellowships, it was held by a majority of those who spoke, that the provision for university fellows in this country is already too large, and that there is danger of stimulating unduly a number of men to go forward to investigation and research who have not the highest and best qualifications for such work. The opinion was expressed that it would be advisable to make some of the fellowships distinctly research fellowships, to be awarded only to students who had already

taken the degree of doctor of philosophy, and who had, therefore, received their academic equipment for their life work.

In discussing the best type of examination for the doctor's degree, it was held very emphatically that the practice which is growing up in our universities, especially in some of the departments dealing with natural science subjects, of permitting the candidate to pass his examination course by course, as is usual in undergraduate instruction, is a pernicious one, and one which stands in the way of the attainment of the best and broadest scholarship. It was held that the examination for the doctor's degree should, in all cases, be upon subjects and not upon courses of instruction; the underlying principle being that the courses of instruction which a graduate student attends are but a small part of the work which he is supposed to do in order to prepare himself for his examination.

It was developed that there was some difference of practice between the universities as to the formal examination for the degree of doctor of philosophy. On the whole, I think it may be said that it was the opinion of most of those who expressed themselves, that great stress should be laid upon the oral examination at the time when the candidate finally presents himself for his degree, and that if any subordinate examinations are held previous to this time, either upon courses or upon subjects, they should be given very little weight in estimating the capacity of the candidate.

It was voted unanimously to approve the suggestion of the committee appointed by the Council of the American Association for the Advancement of Science, that there be set aside a week to be known as Convocation Week, in order that the various learned societies of the country may arrange to hold their meetings at that time.

It was also voted to print in pamphlet form an abstract of the proceedings of the first and second annual meetings of the Association, and to assess the cost thereof upon the fourteen institutions equally.

The place and date of the meeting of 1902 were referred to the incoming executive committee with power.

The officers chosen for the year were: *President*, Columbia University; *Vice-President*, University of Michigan; *Secretary*, University of Chicago; additional *Members of the Executive Committee*, Harvard University, University of California.

#### THE NAVAL OBSERVATORY.

SENATOR CHANDLER'S amendment to the Naval Appropriation Bill, providing a Board of Visitors to the Naval Observatory and requiring the Superintendent to be a line officer of the Navy not below the rank of Captain, was, after stout and repeated resistance by the House conferees, at last accepted, with, however, an amendment, consisting of the words 'until further legislation by Congress,' the concluding clause reading: "The Superintendent of the Naval Observatory shall be, until further legislation by Congress, a line officer of the Navy of a rank not below that of Captain." This, of course, indicates that in the opinion of the House conferees further legislation should follow. The bill was finally passed by both Houses without debate on these provisions.

It appears from the following extract from the *Washington Evening Star* of the 8th inst., that the affairs of the Observatory are likely to be kept before the public:

Charges have been preferred to the Navy Department by Capt. Charles H. Davis, U. S. N., superintendent of the United States naval observatory, against Professor Stimson J. Brown, director of the Nautical Almanac, head of the mathematical branch of the observatory, who is an officer of the navy with the rank of captain. Both officers are well known in naval and scientific circles. The Secretary of the Navy has had copies of the charges laid before Professor Brown, preliminary to the usual procedure of a court of inquiry, which will determine whether the charges are of a character to warrant a court-martial.

It was at first understood that Professor Brown had been placed under arrest by Captain Davis, but it is said in some official quarters that there has been no arrest, and in others it is stated that, at most, the arrest is technical, following the preferring of charges, and in no way involving any restraint.

The papers were first transmitted to Admiral Bradford, chief of the bureau of equipment, who has supervision of the Observatory, and by him they were laid before Secretary Long. The papers are not made public in such cases and, owing to the personal nature

of the controversy, the officials have surrounded the matter with the greatest secrecy.

It can be stated, however, that the charges come under four main heads, viz., that the accused resorted to intriguing methods to bring about the administration of affairs which he desired; that he made statements as coming from Captain Davis which that officer controverts; that he threatened the superintendent with attacks upon the floor of Congress, and neglect of duty.

For the present the action of the Navy Department awaits the course that Professor Brown may adopt on the copy of the charges which has been laid before him.

#### SCIENTIFIC NOTES AND NEWS.

WE record with much regret the death of Dr. George Mercer Dawson, director of the Geological Survey of Canada, which occurred on March 2d, after an illness of only two days.

DR. SAMUEL W. STRATTON has been appointed by President McKinley director of the newly established National Bureau of Standards. Dr. Stratton is professor of physics in the University of Chicago, but has, for the past year, had leave of absence to take charge of the Office of Standard Weights and Measures.

THE President has also appointed a Board of Visitors to the U. S. Naval Observatory, in accordance with the provisions of recent legislation, as follows: St. Clair McKelway, of Brooklyn, N. Y.; Asaph Hall, Jr., of Ann Arbor, Mich.; William R. Harper, of Chicago; Edward C. Pickering, of Cambridge, Mass.; Charles A. Young, of Princeton, N. J.; Ormond Stone, of Charlottesville, Va.

DR. ROBERT BELL, one of the assistant directors of the Geological Survey of Canada, has been appointed director in succession to the late Dr. George M. Dawson.

MR. J. E. SPURR, of the U. S. Geological Survey, has accepted an invitation of the Turkish Government to make an investigation of the mineral resources of the country.

DR. W. B. SCOTT, professor of geology in Princeton University, expects to leave in May for South America in the interests of the work carried on in Patagonia by several Princeton expeditions.

MR. W. H. FISK, of Durham, N. C., has

been appointed assistant State entomologist of Georgia.

SIGNOR MARCONI was one of the passengers on the *Majestic* which left Liverpool for New York on March 6th.

AT the annual meeting of the Hunterian Society, London, on February 13th, Dr. J. Dundas Grant was elected president of the Society. The annual address was given by Mr. John Poland, who gave a retrospect of surgery during the last century.

ON account of ill-health Dr. Frank Russell has been compelled to omit some of his courses in anthropology at Harvard University, and to relinquish others to another instructor. Having been ordered to a more healthful climate he will occupy the year of exile in carrying on archeological investigations in the Southwest.

PROFESSOR GEORGE S. WILKINS, C.E., professor of engineering at the University of Alabama, has been made Chevalier of the Legion of Honor by the French Government for services on the International Jury of Awards of the Paris exposition. Professor Wilkins was expert of the department of civil engineering and transportation for the commissioner general of the United States at this exposition. He was also the official United States delegate to the following International congresses: Tramways, Applied Mechanics, Technical and Industrial Education and Acetylene Gas.

IN memory of the late Dr. Walter Myers, whose life was sacrificed in the study of yellow fever, a chair of tropical medicine has been endowed in the Liverpool School of Tropical Medicine, to be called the Walter Myers' chair. A gravestone will be erected where Dr. Myers is buried in Brazil, and a memorial plate will be placed in the Birmingham Hospital.

DR. JOHN MINOT RICE died at his home in Northboro', Mass., on March 2d, at the age of 68 years. He was a graduate of the Lawrence Scientific School, Harvard University, and was appointed professor of mathematics at the Naval Academy at Annapolis in 1870.

THERE will be a civil service examination for the position of topographic draughtsman in the office of the surveyor general at San Francisco.

The salary is \$1,200, and the examination is on geographic projections, mathematics, and topographic drawing and lettering.

MR. ANDREW CARNEGIE has offered the following sums for library buildings, on condition that the cities mentioned shall provide the cities and ten per cent. of the cost of the buildings annually for maintenance: Richmond, Va., \$100,000; Montgomery, Ala., \$50,000; St. Joseph, Mo., \$25,000; Johnstown, N. Y., \$20,000; Ashtabula, Ohio, \$15,000.

MR. HENRY H. ROGERS, of New York, has presented to the Millicent Library of Fairhaven, Mass., the water-works of that town, yielding an annual income of about \$8,000. The Millicent Library was given to the town of Fairhaven in January, 1893, by the children of Mr. Rogers, in memory of their sister Millicent G. Rogers.

By the will of Dr. Abbott Hodgman, his library is given to the New York Academy of Medicine.

THE Milwaukee Public Museum has just acquired the Rud. J. Nunnemacher collection, containing a large series of Buddhist, Confucian, Taoist and other divinities from China, Japan, India, Burma, Siam and Northern Tibet, in terra cotta, wood, bronze and brass.

We learn from the *Astronomical Journal* that Mr. A. F. Lindemann, of Sidmouth, England, has placed means at the disposition of the *Astronomische Gesellschaft* to be administered by a committee consisting of H. Seeliger, E. Weiss, G. Müller and H. Kreutz for the purpose of accelerating the work of calculation of comet-material from ancient times to the middle of the nineteenth century. The conditions are briefly as follows: An average amount of 100 Marks (about \$24) will be paid for definitive calculation of the orbit of one of these comets, the award being lower for those requiring a relatively small amount of time and higher for those presenting especial difficulty. The award will be made to the first calculation which sufficed the requirements of a definitive computation, but may be divided in case of simultaneous determinations. The committee will decide in each case whether the requirements are met and the amount of payment. A list of these

comets, some seventy in number, may be obtained from Dr. Kreutz, who should be communicated with, in order that duplicate calculations may be avoided.

THE officers of Section D—Mechanical Science and Engineering—American Association for the Advancement of Science, Professor Henry S. Jacoby and Mr. William Harry Jacks, have issued a circular in regard to the Denver meeting. It reads in part.

The subjects which are appropriate for the Section relate more especially to the application of science and of scientific methods to the various engineering problems.

It has been suggested that short papers be presented, giving information regarding the following questions: Have you any experimental data which either confirm or throw doubt upon formulas or constants hitherto generally received? Have you any data upon subjects hitherto considered doubtful, as for example, the strength of unstayed surfaces? What subjects should engineering laboratories undertake to investigate with a view to obtaining data which will be of general importance, and how would you propose to make such tests (including a description of the apparatus)?

It is hoped that many brief résumés of investigations or experiments relating to different subjects of interest to the Section may be offered for this meeting, and that the support of the Section will be shown by the offer of a larger number of appropriate papers than usual, especially by the Western members who have long urged a meeting in the far West.

THE fifth annual meeting of the New York State Audubon Society was held in the American Museum of Natural History on the afternoon of March 8th. Addresses were announced by Dr. Frank M. Chapman of the Museum, Dr. T. S. Palmer, assistant-chief of the U. S. Biological Survey and Mr. Charles R. Skinner, State Superintendent of Public Instruction.

IN order to aid in the extension and further equipment of the Scientific Department, of Manhattan College, New York City, Dr. J. M. Ferrer and a committee of the alumni society have organized a course of five evening lectures to be given in Carnegie Lyceum during the month of April. They have secured the cooperation of men eminent in their respective departments, as will be seen from the following syllabus:

April 10—'Meteors and Meteorites,' by Professor M. F. O'Reilly, D.Sc., London.

April 16—'Development of Artillery in the Nineteenth Century,' by Captain Edward L. Zalinski, U. S. A.

April 22—'Submarine Boats,' by Mr. John P. Holland.

April 25—'The Steam Engine and its Rivals,' by Professor R. H. Thurston, of Cornell.

April 30—'Electric Wave Transmission,' by Professor Michael I. Pupin, of Columbia.

The lectures will be illustrated with stereopticon views. Professor Pupin will further illustrate his lecture by experiments with apparatus used by him in the researches which have led to his recently announced discoveries in connection with the transmission of speech over long distance telephones and submarine cables.

At the International Congress on Tuberculosis to be held in London in July, addresses will be delivered by Professor Robert Koch, Professor Brouardel, dean of the medical faculty of the University of Paris, and by Professor McFadyean, principal of the Royal Veterinary College, London.

#### UNIVERSITY AND EDUCATIONAL NEWS.

MR. HIRAM SIBLEY, JR., has given Cornell University \$85,000, for an addition to the Sibley College of Engineering. It will connect the two present buildings, and give them a frontage on the campus nearly 400 feet in length.

MR. JOHN D. ROCKEFELLER has given \$110,000 to Vassar College for the erection of a residence hall similar to the residence hall now being built on the college grounds.

MRS. L. M. PALMER, widow of Dr. A. B. Palmer, for many years professor in the medical department in the University of Michigan, has by the terms of her will left \$85,000 to the University, mostly, it is understood, for the benefit of the hospital.

THE District Court at Denver has sustained the will of the late George W. Clayton, who bequeathed most of his estate, valued at more than \$2,000,000, to the city of Denver for a college for orphan boys, similar to Girard College, Philadelphia.

THE following statement has been issued in regard to the consolidation of the Chicago Institute with the University of Chicago: "The Chicago Institute is to become a professional school of the University of Chicago, and will include a school of pedagogy and an elementary school and kindergarten. Associated with it will be a secondary or high school, for the present under the leadership of Dr. John Dewey of the university, ultimately, however, to become a part of the Chicago Institute. Colonel Parker is to be the head of the institute, and his successors are to be appointed by the university trustees upon the nomination of the Chicago Institute trustees. With the institute the university receives \$1,000,000. Part of this is to be used in furnishing a home and equipment for the institute, and the rest is to be devoted, chiefly as an endowment fund, to the maintenance of the institute. The university expects to expend from its own funds between \$10,000 and \$20,000 a year for the support of the work."

IT is expected that the Hall of Fame of New York University will be formally inaugurated on May 30th.

OWING to the increase in the number of Assembly districts in the State of New York, Cornell University will hereafter provide 150 free scholarships each year in the place of 128. To educate the 600 students holding these scholarships costs, as President Shurman has pointed out, \$180,000, whereas the University received in return a land grant from which the annual income is but \$35,000.

DR. W. T. JORDAN, of the University of Tennessee, has been offered the presidency of the University of Alabama.

AT Columbia University the following promotions have been made: M. I. Pupin, professor of electro-mechanics; Marston Taylor Bogert, adjunct professor of organic chemistry; Edmund H. Miller, adjunct professor of analytical chemistry and assaying; S. L. R. Morgan, adjunct professor of physical chemistry; Livingston Farrand, adjunct professor of psychology, and Edward Thorndike, adjunct professor of genetic psychology.



# SCIENCE

A WEEKLY JOURNAL DEVOTED TO THE ADVANCEMENT OF SCIENCE, PUBLISHING THE OFFICIAL NOTICES AND PROCEEDINGS OF THE AMERICAN ASSOCIATION FOR THE ADVANCEMENT OF SCIENCE.

EDITORIAL COMMITTEE: S. NEWCOMB, Mathematics; R. S. WOODWARD, Mechanics; E. C. PICKERING, Astronomy; T. C. MENDENHALL, Physics; R. H. THURSTON, Engineering; IRA REMSEN, Chemistry; JOSEPH LE CONTE, Geology; W. M. DAVIS, Physiography; HENRY F. OSBORN, Paleontology; W. K. BROOKS, C. HART MERRIAM, Zoology; S. H. SCUDDER, Entomology; C. E. BESSEY, N. L. BRITTON, Botany; C. S. MINOT, Embryology, Histology; H. P. BOWDITCH, Physiology; J. S. BILLINGS, Hygiene; WILLIAM H. WELCH, Pathology; J. MCKEEN CATTELL, Psychology; J. W. POWELL, Anthropology.

FRIDAY, MARCH 22, 1901.

THE CONDITION, PROSPECTS AND FUTURE EDUCATIONAL DEMANDS OF THE CHEMICAL INDUSTRIES.\*

## CONTENTS:

<i>The Condition, Prospects and Future Educational Demands of the Chemical Industries:</i> DR. WM. MCMURTRIE .....	441
<i>Man's Place in Nature:</i> W J MCGEE.....	453
<i>Thomas Benton Brooks:</i> BAILEY WILLIS.....	460
<b>Scientific Books:—</b>	
<i>The Appreciation of Non-Euclidian Geometry:</i> PROFESSOR GEORGE BRUCE HALSTED. <i>Allen's Commercial Organic Analysis:</i> DR. G. S. FRAPS. <i>Hickson on Alcyonium:</i> J. P. MCM.....	462
<b>Scientific Journals and Articles.....</b>	466
<b>Societies and Academies:—</b>	
<i>New York Academy of Sciences, Section of Biology:</i> DR. HENRY E. CRAMPTON. <i>Section of Anthropology and Psychology:</i> PROFESSOR CHAS. H. JUDD. <i>Section of Astronomy, Physics and Chemistry:</i> DR. WILLIAM S. DAY. <i>The Las Vegas Science Club:</i> T. D. A. C. <i>Ottawa Field Naturalists' Club:</i> DR. H. M. AMI.....	467
<b>Shorter Articles:—</b>	
<i>Arsenic Tests:</i> G. E. BARTON. <i>Preliminary Note on the Embryogeny of Nelumbo:</i> HAROLD L. LYON.....	470
<b>Current Notes on Physiography:—</b>	
<i>Physiography of New Brunswick; Drainage Changes in Norway; The Assam Earthquake of 1897:</i> PROFESSOR W. M. DAVIS.....	471
<b>Botanical Notes:—</b>	
<i>Trees of the Northern Plains; Shrubs of the Northern Plains; New Edition of the Phytogeography of Nebraska; Botany and Agriculture; Field Ecology in the Rocky Mountains:</i> PROFESSOR CHARLES E. BESSEY.....	472
<i>The National Bureau of Standards.....</i>	474
<i>Scientific Notes and News.....</i>	475
<i>University and Educational News.....</i>	480

It has been well said that chemistry is an offspring of the nineteenth century. The closing years of the eighteenth century had some glimpses of the wonders the new science had in store, but it remained for the workers of the first decade of the nineteenth to collaborate the results obtained by their immediate predecessors and develop the new truths which finally established the foundation of the glorious structure, which has now grown so great. During this period human necessities were in every way augmented, and particularly in France, claimed to be the fatherland of our science, human ingenuity was sorely taxed to meet these needs.

The struggle to find ways and means stimulated the energies and increased the zeal of the searchers after truth, and the utilitarian quest, as is always inevitable, brought forth results of interest and value above and beyond the actual needs, furnished data upon which are based the most important and fundamental laws of the science and firmly established many of the most important of our industries. The labors of the chemists of the last decade of the closing century had cleared away the

MSS. intended for publication and books, etc., intended for review should be sent to the responsible editor, Professor J. McKeen Cattell Garrison-on-Hudson, N. Y.

\* Address of the President before the American Chemical Society, Chicago, 1900.

haze which surrounded and covered the truths already developed and opened the way for further promotion of the newly-born science. Lavoisier had led, by the introduction of systematic and accurate observation and record, to the crystallization of what had so far concentrated, and his associates, imbued with his spirit and inspired by his genius, were ready and willing to carry forward what he had so nobly begun.

And so the science was launched. How it has progressed during the century now closing has been told in many ways by many men, and the history seems ever new. New laws and new truths found applications in the industries and increased the material wealth, and the industries in turn furnished the material, the data, the incentive, for much of the additional investigation necessary to the development of the further laws.

The activity of the last decade of the last century has its counterpart in that of the century just closing. If the former century established the foundations, the closing century has furnished a superstructure worthy of the great minds who began the work. And whether we consider the later achievements from the side of abstract science, or from that of the applications of the great laws to the material needs, the glory is equally manifest and the wonder no less profound. Whether we consider argon, and helium, neon, krypton and xenon, and the beautiful researches which led to their discovery, polonium and radium, and their remarkable properties, the Röntgen reactions or the liquefied gases, and the attainment of the almost lowest limit of low temperatures; or the wonderful advances in illumination, the production of high temperatures in the electric furnace, the development of new compounds and forms of matter through the aid of these temperatures, the applications of high electric tensions to the production of new reactions,

even those most familiar with them must feel the influence of the mighty strides and look into the future with enthusiastic hope.

The interest manifested in the new science in the old world was quickly extended to the new, and it found most active lodgment here. Students and associates of Black in Scotland, Fothergill in England and of the French chemists of the last quarter of the century in Paris started the work, and the names of Rush, Hutchinson, Woodhouse, McLean, Franklin, Rumford, Priestley, Silliman, Hare, Seybert, Norton, Dana and others, will ever find affectionate memories in the minds of the chemists of America. What these men started has been actively developed by those who followed them, until to-day the science and its applications find more actual workers in our country than are to be found in any other country within the bounds of civilization.

The first half of the century had comparatively few men in the United States who could be classed as working chemists. Chemistry had, it is true, been taught in a way in many of the colleges. But systematic work, as we know it to-day in many of the institutions of learning, was practically unknown. Those who felt the special need of, and had a desire for, such instruction were constrained to seek the facilities in other lands, until generous and at the same time practical men, such as Lawrence, Sheffield, Packer, Pardee and Harrison, with enterprising eyes and prophetic vision, saw the advantages to be derived from the further development of the sciences and provided the means whereby well-furnished laboratories could be opened up, and facilities for the profound study of the science could be made possible. But the industrial needs of the country for more exact knowledge of the natural laws extended beyond private munificence, and the national legislatures early recognized

the importance of the better education of those who must manage the rapidly growing industries. The successful efforts of the late Senator Justin S. Morrill and his associates, in securing the enactment of the law which provided for the establishment in each State of an institution for study of agriculture and the mechanic arts, is well known and will always be gratefully remembered. No less important were the efforts of the late Mr. Hatch of Missouri, who labored so earnestly and eventually so successfully for the establishment of the State agricultural experiment stations. There can be no question that nothing has done more for the promotion of the science of chemistry and its applications than the acts of these great captains of industry and legislation. We shall not forget further the wonderful benefactions of Johns Hopkins, Clark, Case, Rose, Rockefeller, Stanford, Schermerhorn, Havemeyer, Fay-erweather, Carnegie and others, who have furnished through splendid munificence the magnificent facilities not only for instruction in the science but for abstract research as well.

The science received splendid impulse and inspiration in the meeting at the grave of Priestley in 1874. It brought the chemists of the country, then comparatively few in number, together and established the bond of good fellowship and scientific sympathy, always so necessary to true progress. The most important outcome of this most important gathering was the organization of our own society. In his address delivered at that meeting Professor Benjamin Silliman named eighty-five chemists who had contributed to the advancement of the science in the United States at that time.

In 1876, the American Chemical Society was organized and during the year enrolled 230 members, of which 190 were professional chemists. The impulse given in Northumberland was effective, the example

of a few devoted and public spirited men was followed, and though a period of almost fifteen years was requisite to the ultimate firm establishment of the work of the organization and the integrity of the Society itself, the great aims of its founders to secure the harmonious and thorough organization of all the chemists of the country finally prevailed. The Society has continued to increase in membership and influence, until at the present time thirteen local sections have been established in the various parts of the country, all actively working, and at least six of them holding monthly meetings, during all but the summer months, for such scientific intercourse and discussion as cannot fail to be fruitful in the promotion of the science. The roll of membership now contains about 1,750 names, and while this represents but a small proportion of the working chemists of the country, its growth henceforward must be rapid and the hope of the founders fairly realized.

The *Journal* covers annually nearly one thousand pages of matter fairly representative of the work of American chemists, and it has become necessary, because of increased demands for it, to publish an edition of three thousand copies. Its pages are open to communications on all subjects relating to chemistry and its applications, and it is the hope and expectation that the valuable *Review of American Chemical Research* may be accompanied in the near future by abstracts of papers published in the foreign journals, thus furnishing to all our members information regarding the world's works in chemical science and practise.

The progress made in the applications of chemistry in our country can properly and fully be told only in the results of the census now in progress and in hands which promise results of higher value than have ever before been obtained in such work in

this country. We may congratulate ourselves that it has been entrusted to our past president, Dr. C. E. Munroe, whose tastes and training have so admirably fitted him for the delicate and difficult task submitted to him. But we have in the figures prepared by the Bureau of Statistics of the United States Treasury most significant data regarding the progress made during this closing decade of the closing century. From this source we learn that of products classified as chemicals, drugs and medicines, we imported during the year ending June 30, 1890, to the value of \$41,601,978, while for the year ending June 30, 1900, this value had become \$52,931,055. Most of the materials represented in these figures entered into consumption in industries, based wholly or in part upon the applications of chemistry. We cannot enter into the details of these statistics, but we may consider with interest and profit a few figures relating to some well known industries, and which are instructive in this connection as showing the variations which have occurred during the decade.

Chemicals imported in 1890 and 1900 respectively :

	1890.	1900.
Caustic soda.....	\$1,470,335	\$158,793
Soda ash.....	3,493,288	665,104
Potash, Chlorate of.....	238,840	102,337
Soda, " ".....		93,076
Lime, Chloride of.....	1,385,080	1,461,858
Glycerine.....	928,935	2,138,670
Alizarine colors.....	358,882	771,336
Coal tar colors and dyes.....	1,787,553	4,792,103
Other coal tar prod.....		397,780
Milk, Sugar of.....	46,510	399
Glass.....	7,411,343	4,038,753

The figures indicate enormous growth of the alkali industry in the United States during the decade and show that in this branch of industry we are entirely independent, as regards supplies, of foreign producers. The figures for glycerine show the possibilities of expansion of another industry, while the almost astounding growth of the importations of alizarine and coal tar products and dyes indicates the necessity for the further development and utilization of our own sources of crude materials of like character and the extension of that already begun. The rapid growth of the establishment of the by-product coke ovens reveals great possibilities in this direction, and it must be disappointing if the characteristic enterprise fails to take advantage of these possibilities.

If the importations of chemical products are interesting and indicate great activity and growth in the industry, the figures for the exportation of similar products are even more significant. We submit figures for the years ending June 30, 1890, and June 30, 1900, respectively, including in the table some data for 1876, the year of the organization of our Society. To have predicted these results in the beginning of the quarter-century would have invited incredulity, but so also would predictions regarding the advances to be made in other lines of human industry. The figures are worthy of careful study.

Values of exports of domestic products of the chemical industries for the years ending June 30, 1876, June 30, 1890, and June 30, 1900, respectively :

	1876.	1890.	1900.
Bark and extracts for tanning.....	\$223,276	\$263,754	\$376,742
Beeswax.....		17,927	91,913
Blacking.....	81,401	238,391	880,049
Candles.....	229,311	143,073	191,687
Celluloid.....		39,004	174,261
Acids.....	50,300	98,084	146,722
Ashes, pot and pearl.....	75,597	26,211	49,566
Copper, Sulphate of.....			2,120,745

	1876.	1890.	1900.
Dyes and dyestuffs.....		717,128	498,056
Lime, Acetate of.....			776,413
Other chemicals not separately enumerated.....	2,471,195	2,840,931	5,536,716
Cider.....		193,283	64,283
Coke.....		53,586	1,233,921
Coffee and cocoa, ground and prepared, and chocolate		93,735	228,241
Earthen, stone and china ware.....		175,477	575,823
Fertilizers.....	922,221	1,618,681	7,218,224
Glass and glass ware.....	646,954	882,677	1,933,201
Glucose or grape sugar.....		855,176	3,600,139
Glue.....	5,798	88,484	225,844
Grease, grease scraps and soap stock.....		1,506,819	2,944,322
Gunpowder and other explosives.....	67,887	868,728	1,888,741
India rubber, gutta percha and manufactures of.....	88,816	1,090,367	2,364,157
Ink, printers' and others.....		147,057	259,776
Leather.....		11,175,141	15,363,584
Lime.....		134,994	85,854
Cement.....			163,162
Malt.....		60,412	215,198
Malt liquors.....	42,664	654,408	2,137,527
Matches.....	153,680	62,284	95,316
Naval stores.....	9,799,923	7,444,446	12,474,194
Oil cake and oil cake meal.....		7,999,926	16,757,519
Oils, animal.....	1,975,972	1,686,643	718,997
Oils, mineral, crude.....	2,220,268	6,744,235	7,364,162
Oils, mineral, refined or manufactured.....	30,502,312	51,403,089	68,246,949
Oils, vegetable, Corn.....			1,351,867
"    Cotton seed.....	146,135	5,291,178	14,127,538
"    Linseed.....	23,770	55,036	54,148
"    volatile or essential.....	248,270	223,435	256,597
"    all other.....		102,792	554,295
Paints, pigments and colors.....	179,882	578,103	1,902,058
Paper and manufactures of.....	795,176	1,226,686	6,215,559
Paraffin and paraffin wax.....		2,408,709	8,602,723
Perfumery and cosmetics.....	375,011	430,151	358,589
Photographic materials.....		3,891	1,164,465 (1899)
Plaster.....		5,153	35,017 (1889)
Lard.....	22,429,485	33,455,520	41,939,157
Lard compound and substitutes.....			1,474,464
Oleo and oleomargarine.....		6,773,522	10,920,400
Butter.....	1,109,496	4,187,489	3,142,378
Cheese.....	12,270,083	8,591,042	4,939,255
Milk.....		303,325	1,133,296
Salt.....	18,378	29,073	55,833
Soap.....	684,739	1,109,017	1,773,921
Spermaceti.....	35,915	116,757	67,125
Spirits, wood.....			320,306
Spirits, grain (neutral and cologne).....		178,257	59,277
"    brandy.....			83,698
"    rum.....		663,039	903,808
"    whiskey, bourbon.....		498,250	764,860
"    "    rye.....		137,029	121,241
"    all other.....		165,535	24,921
Starch.....	524,596	378,115	2,604,362
Sugar and molasses.....	6,745,771	3,029,413	3,697,366
Tallow.....	6,734,378	5,242,158	4,398,204
Varnish.....	54,906	206,483	620,059
Vinegar.....	6,133	10,520	12,583
Wine.....	33,483	270,930	62,592
Wood pulp.....		2,245	458,463
Yeast.....			36,061
	\$102,054,750	\$174,803,105	\$264,501,771

The figures show grand totals as follows :

For the year 1876.....	102,054,750
“ “ “ 1890.....	174,803,105
“ “ “ 1900.....	264,501,771

In the decennial period just closing the increase in the value of the exports of products of domestic manufacture was therefore about the same as during the preceding fourteen years, and during the quarter-century the growth has been 260 per cent. The growth has been persistent and steady, and indicates what may be expected in the immediate future as well as what is now the condition of development of our chemical industries. This latter condition becomes more manifest when we consider that the products exported constitute but a small proportion of the production, and we may in some degree at least anticipate the results which must be obtained in the pending census investigation.

As a further illustration of the growth of the chemical industries, we may call attention to the condition of the coke industry in the United States in 1880 and 1898 respectively, as illustrated in the following table :

	1880.	1898.
Establishments.....	186	342
Ovens } built.....	12,372	48,447
} building.....	1,159	1,048
Coal used, net tons.....	5,237,471	25,249,570
Coke produced, net tons.....	3,333,300	16,047,299
Total value of coke at ovens.....	\$6,631,267	\$25,526,699
Value of coke at ovens, per net ton.....	\$1.99	\$1.594
Yield of coal in coke, per cent.....	63.0	63.6

If we consider that in the recovery ovens, which are fast taking the place of the older and less rational types, this coal should yield 3.38 per cent. of tar, .34 per cent. its weight of ammonia and 8.17 per cent. of gas liquor, all of them bases of most important chemical industries, the figures are significant.

Equally interesting must be the informa-

tion to be furnished regarding the capital represented in the chemical industries in this country. At the present time, we are able to judge of this to a minor extent from the reported capitalizations of the recently organized companies constituting combinations of preexisting companies. It is true that in these cases the capital represents in a very considerable measure what is known as good will, franchises, etc., but it nevertheless represents earning power and the the average market value corresponds very closely with par value. Taking only those organizations devoted to the chemical manufactures exclusive of the gas and metallurgical and explosive industries, we find that the capitalization as reported in the stock lists amounts to the enormous value of about \$1,500,000,000, and this takes no account of many of the incorporated industries not specially reported, nor the industries not incorporated and yet active. It does not include the recently developed electrolytic industries, in which the cash capital actually invested, as we learn from competent authority, amounts to more than \$1,500,000. The newly-established by-product coke industry is so rapidly developing and is absorbing capital with wonderful rapidity, while the comparatively new beet root sugar industry has already developed to such an extent as to involve capitalization of nearly \$100,000,000 and to develop the establishment of manufacturing plants of magnitude beyond the imagination of foreign manufacturers in the same line a few years ago. Yet this is a general characteristic of the modern chemical industries of the United States, and it is interesting to note that much of the development has been effected empirically and by men comparatively little versed in the principles and laws of the science upon which they are based. The industries have had the aid of but few educated chemists. Happily this condition is rapidly changing. Rational

work is coming to be recognized and the demand for well-trained chemists is increasing. We cannot yet boast with the Germans that single works employ more than one hundred thoroughly educated chemists, yet inquiry shows that many of the important works have corps of chemists numbering from ten to fifty, while very many more have smaller numbers. The same inquiry affords some clue to the number of chemists actually at work in this country. If we compare the list of members of the American Chemical Society, we find that more than two-thirds are engaged in technical work. Furthermore, of the few chemists reported in the inquiry just referred to, scarcely one-third are members of the Society. A fair estimate based upon such data leads to the conclusion that more than five thousand chemists are actually at work in the United States and that eighty per cent. of these are connected with the industries. A study of the lists of the graduates of the educational institutions leads to similar conclusions. Fischer reported as the result of special inquiry made three years ago that in Germany four thousand graduate chemists were employed in the industries and about two hundred in teaching and special investigations.

So then we find that the chemical industries of the United States are growing with enormous rapidity; that they are being concentrated into fewer but larger works; that operations and reactions are being carried out with a magnitude which the earlier chemists would never have predicted; that new methods are being followed; new principles applied, greater accuracy of results demanded both as to quality and yield of the products; that the products now issue from the works in lots of tons at a time of a higher degree of purity and with a greater economy than were possible but a few years ago with lots of a few hundred pounds. For instance, the great sugar refineries each

yield from one to two million pounds daily of a product, the purity of which may be considered absolute. The modern beet sugar works have in some cases capacity for treatment of from 1,000 to 3,000 tons of roots daily, and consequently the purification of almost an equal quantity of juice.

And if so great advance has been made during the closing quarter-century and even decade, what shall we say of the possibilities of the future? What is to be the magnitude of the chemical industries of the United States? What shall be the character of the products issuing from them? What will they require of the men who must direct and control them? That is to say, what will be the educational requirements of the American chemical industries of the almost immediate future? These questions are not new to our own country, and their importance has forced itself with powerful intensity upon those engaged in the chemical industries in the old world: it has been the subject of most earnest discussion, particularly in Germany and England, during the past five years at least. Nor has it been in all respects satisfactorily answered. Even within this closing month of the closing century the cable has flashed news of the complaint on the part of the leading statesmen of England that the training of technologists in that country is inadequate to the development necessary to meet foreign competition, and at almost the same time brings news of the inauguration of new institutions for technical education. And in Germany also, the home and starting point of many of the great industries, the demands upon the educational institutions for the better training of technologists are being pressed from every side. It is natural to believe that the time is not far distant when we too shall be called upon to make and meet similar demands. It may be pardonable therefore to discuss briefly what these requirements are likely to be.

First of all, experience shows that those who financially control the great industries fully appreciate the need of improvement in both processes and products are particularly apt in propounding hard questions in connection therewith, and always expect that these questions shall be answered quickly and with the utmost accuracy. Young men who early come to a realization of this fact and prepare themselves by broad and thorough education to meet it are those who will succeed in the industries and ultimately have a controlling influence in their management. And what is to be said here on this subject is directed as much to the students as to those who instruct, for it is not difficult to understand the restrictions placed upon teachers by the students themselves in the struggle to arrange work leading to the training, which many realize to be absolutely essential to meet the requirements of the near future.

For it is beyond question that the most thoroughly educated man is sure to best meet these requirements and become the leader in the industrial struggle of the near future. Dr. Duisberg, the director of the great color works at Elberfeld, Germany, rightly fixed the standard when he said that 'above all a general comprehensive education is required. We must have in the industries persevering, energetic men with broad views.' And Dr. Chittenden was right when he said "give a young man a broad knowledge and a thorough conception of the principal laws of physics, mechanics, hydraulics, etc., and he will soon adjust himself to the environment of professional work and eventually rise to a plane far beyond that of the man whose training has been purely technical," and concluding his paper he says, "the rapid development of the sciences and their manifold industrial applications have opened up avenues for new ventures of great magnitude, and there is an increasing demand for young men of

broad scientific knowledge and training. He who wishes for the fullest possible measure of success must prepare himself thoroughly for his life work and he can do this in no better way than by acquiring a broad and liberal education."

This important requisite to success could not be better described. Careful general training is conducive to the best thought and the best expression of the results of inquiry. And it is too frequently true that technical men are especially lacking in this particular. Too early specialization must tend to narrowness of view and therefore to limited influence. The general culture work of the preparatory schools, or of the colleges, will always be profitable, whether as preparatory to a specialty or an auxiliary to its prosecution. These principles will apply to all technologists, whether they are chemists or not.

But what shall be the character of the special training of the technical chemist? First of all, we must admit, that this must cover thoroughly and profoundly a study of the science of *chemistry*. Dr. Fittig declares: "Our problem is to study the science as such; to lead the student into the methods of strictly scientific investigation, to put him into position to solve pure scientific problems entirely independent of the question, whether he shall devote his powers to the services of the science itself or apply it to practical questions." He claims that many students take up the study without the scientific instinct. And Erlenmeyer says "a true scientific training should produce ability and susceptibility for all and every use. With a knowledge of the principles and laws of the science, their use becomes easy, they proceed independently." Foerster, discussing the needs of the electrochemists, says "but above all be particular to secure fundamental training in the entire field of chemistry, thus utilizing the principle insisted upon by Liebig, that the best



training for any specialty rests upon the broadest foundation in the whole of scientific chemistry." Dr. Duisberg says further: "in technical chemistry the sharp eye of the scientifically trained man is wanted in order to recognize the individual developments of the reactions in progress, which can be seen only through the accompanying indications." And Richard Meyer truthfully declared: "if our technologists did not properly appreciate the service rendered by men trained in the spirit of Liebig, chemical investigation would miss the stately crowd of auxiliary powers, without which the heights, from which we may now look proudly backward and hopefully forward, could never have been attained." And W. H. Perkin says that "technical education will be of small value unless it is carried out on a very broad and scientific basis."

These views of the leaders in the science of chemistry must find an echo in the mind of every man who has had experience in the industries. In no department of human activity is a thorough knowledge of the fundamental laws so needful, nor can the knowledge of any law be safely neglected if successful work is to prevail. For all the laws apply all the time and few cases will arise in which the more important can be avoided. To suppose that the industries can be carried on in the face of severe competition without such knowledge is to invite failure in every case. Empiricism may succeed in times of plenty, but adversity breeds rationalism and fosters the support it can bring. So then we may make no distinction between inorganic and organic chemistry, analytic and physical chemistry, for each one has its place in the world's work and no one can predict when any one of these branches will be called upon to render material aid.

But whatever may be the department of chemical study, the relation of the science to physics will be keenly felt and the de-

pendence of each upon mathematics as the true foundation will become manifest. For this latter science is just as powerful an aid in the determination of the motions of the atom and molecule in matter as of those of the worlds and constellations in space. And if it cannot be neglected in astronomy, no more can it in chemistry and physics. Indeed, it illustrates the unity of all the sciences, even as it does the correlation of all the forces. Dr. Lorenz set forth the need of all chemists in this particular when he said: "Modern electro chemistry is an exact science and its principles and a knowledge of it rests upon a foundation of mathematics. It is in every way desirable that every electrochemist shall be trained in the higher mathematics and be thoroughly able to utilize both differential and integral calculus." He particularly recommends as a preparation therefore the 'Introduction to the Mathematical Treatment of the Sciences of Nernst and Schonflies' and says: "if the student have an intensive rather than extensive training in mathematics, he may be thrown into the sea of natural science and left to swim." So also Foerster discussing the character of the instruction in electrochemistry in the technical high school, while insisting upon 'thorough fundamental work in organic and inorganic chemistry, physics and physical chemistry' does not fail to include in his plan of work 'the principles of higher mathematics.' Dr. Koerner, discussing the 'Importance of Physical Chemistry to the Industries,' says: "It is most characteristic of it (physical chemistry) that it utilizes the most powerful of all natural aids to scientific investigation, the higher mathematics." And in the curricula of the technical high-schools in Germany we find almost without exception that in the course of chemistry, as well as in engineering, the higher mathematics is taken up and completed before the end of the first part of the year, if not

before the end of the first semester. It thus becomes the ground work of, and preparatory to, all the important work which in those great institutions must follow it.

And finally, the technical chemist of the near future must be trained in the principles and practises of engineering, trained to make and operate the mechanical means for carrying out effectively the chemical reactions of the industries in a large way. For, after all, these reactions differ only in degree from those of the research and preparation laboratories, and if in the latter the students must be trained in making and assembling the forms of apparatus for use in the various operations of pulverizing, separating, roasting and incineration, solution, precipitation, separation of solids and liquids, washing, drying, and care of precipitates and crystals, the production and control of heat, the transfer of solids and liquids, the production and application of vacuum, evaporation and distillation, the conditions of crystallization, etc., in the small way in the laboratories, he must be taught to apply all these and more, in the large way in the works. Indeed, the only difference between the two may be comprised in the terms micro-chemistry and macro-chemistry; chemistry and the operations belonging to chemistry, carried on in a small way with limited or small quantities or volumes; handling solids and liquids in quantities of a few grams or a few cubic centimeters, or liters, on the one hand, or of tons of solids and thousands of gallons of liquid on the other. How, for instance, would the chemist untrained in the principles of engineering proceed in handling materials in quantities involving several tons of solid matters and 30,000 to 50,000 gallons of liquid in a single charge?—a requirement not uncommon in the modern industries and sure to be more common in the future industry. In his day, perhaps, the great Liebig was right and Wöhler was

right, and Fittig not far wrong, when they maintained that with a thorough knowledge of the principles and laws of chemistry, all else in the industry involving their application would be easy. It is possible that the genius of the young operator would come to his aid and enable him ultimately to devise means to meet his ends, but time and labor must be saved by training in the methods, whereby such means may be established and a knowledge of means already at hand acquired. The authoress of a late popular work of fiction was right when she said, 'untrained genius is a terrible waste of power,' and though it may not be as applicable here as in an earlier paragraph, she was also right when she said in the same connection, "So many persons think that if they have a spark of genius, they can do without culture; while really it is because they have a spark of genius that they ought to be and are worthy to be cultivated to the highest point." And this applies to the chemists who must operate in a large way and with large masses of matter, either solid or liquid.

In a discussion of this subject in England, where perhaps more than elsewhere in the world the need of engineering capacity on the part of chemists has been most keenly felt, and where, on the other hand, engineering capacity, embodied in such men as Moud, Bell, Muspratt, Weldon, Perkin and Chance, has brought forth such splendid results. Ivan Levinstein, himself a leader in the industry, said: "It must also be palpable that a chemist intended for industrial work, who, along with sound training in chemistry, has also acquired a fair knowledge of chemical engineering, must be better fitted for his work than the man who is only practically acquainted with the handling of china basins, phials or a Liebig's condenser." And in the same discussion Watson Smith endorsed "what had been said as to the importance of teaching

the scientific principles involved in the special construction of apparatus and plant for chemical processes on a large scale."

Dr. Ost, whose connection with both the industries and teaching has been so intimate, says: "Liebig, who had for long years taught technical chemistry in Giessen and, as none other, had promoted the applications of chemistry, could say in 1840 'I know many (those trained in pure science only) who now stand at the head of soda, sulphuric acid, sugar and cyanide works, dyeing and other industries, and without ever having had previously to do with them, were completely entrusted with works processes within the first half-hour, and in the next brought forth a number of most important improvements.' Sixty years ago, this judgment characteristic of the time, this enthusiastic declaration of Liebig, would constitute a dogma, but it is no longer tenable. The chemist graduated from the technical high school is no longer in position to begin his factory experience with introduction of improvements." This, Ost says, is because of the better and more perfect organization of modern works. And Dr. Lorenz of the Zurich Polytechnicum says: "The electrochemist should not be graduated until he has been taught how to use modern methods in very large apparatus. We find in electrochemistry wide difference between the theory and the facts. In the laboratory current yield and greatest economy of electrical energy are often the principal consideration, but in technology corrosion of electrodes or diaphragms is much more expensive than any variation of energy." What an important illustration of a special study of materials of engineering in the preparation for the chemical industry. And what a sensation of sympathy this must arouse in all those who have had to do with the handling of corrosive materials in the very large quantities and volumes, which modern methods involve.

How often it happens that success of an important operation is delayed and even made impracticable because of want of knowledge of suitable resistant material for construction of containing vessels or apparatus.

Probably the most important contribution to this subject is that of Mr. Beilby. In his address he says: "I have rarely seen the chemistry of a process lagging behind the engineering; most frequently it is the other way. The chemical reactions involved in the ammonia soda process are simple and easily understood, but it required the genius and practical skill of men like Solvay and Mond to devise apparatus which could establish the manufacture on its present secure basis. What are the elements of which the skill is made up? The scientific basis must be a thorough knowledge of the principles of chemistry, physics, dynamics and mechanics, and added to this there must be a practical acquaintance with the materials of construction and the methods by which they are worked into structures. The designing and construction of apparatus for chemical works is a distinct branch of applied science. It is in this that special skill is required, for works operations are not simply laboratory operations.

"The ideal chemical engineer should be in thorough sympathy with the modes of thought and with the methods of working of both the chemist and the engineer. Just as the professor of engineering teaches how to apply the law of statics, dynamics and kinematics to the design of structures or machines, so should the professor of chemical engineering trace the applications of the laws of chemistry and physics and dynamics in the problems which occur in designing chemical apparatus for works. I am quite satisfied that in the present state of popular opinion the position and work of the technical chemist will not be properly recognized, unless he can associate himself, by his training and practice, with the engineering

side of his calling." Professor Meldola says: "The sooner a chemist is made to realize the enormous practical difference between a laboratory and a factory process, the better it will be for him."

Professor J. A. Reynolds, Director of the Municipal Technical Schools of Manchester, England, says: "English chemists are not engineers and English engineers are not chemists, and hence the enormous difficulty which arises in the endeavor to bring to successful commercial results the fruits of laboratory research." While Mr. David Howard considers that the "influence of mass action, the question of so many pounds of coal per horse power hour and other like things, cannot be dealt with on a small scale, but are all important on a larger scale. We want chemical engineers who can make new roads in chemistry as mechanical engineers do in railways."

It is also important to consider the course of study proposed by Mr. Beilby in his paper for prospective industrial chemists. His large experience in the chemical industry gives him power to speak with authority, and young men who look forward to a successful career in the industry will do well to give it most careful consideration. And even more important, perhaps, are the courses of instruction carried out in the West of Scotland Technical College and in the Municipal Technical School in Manchester, England, and published in the *Journal of the Society of Chemical Industry* during 1899. Students who have had the advantage of these courses must be better fitted than those who have not been similarly favored. Yet we must believe that the courses laid out in the technical high-schools of Germany, and, we are proud to say, in some of the schools of technology in our own country, are in some respects better. A combination of the two classes of course might be made with profit to both the classes of institutions. It is im-

portant that the works chemist should be trained in the construction of the special forms of apparatus he needs to use, but they should be accompanied or preceded by the principles and practise of mechanical engineering. The most practical courses, perhaps, are those laid down in many of our own educational institutions for instruction in mining engineering and metallurgy, in which chemistry of the operations is considered in connection with the mechanical details of its applications, and we have advised students desiring to prepare for the chemical industries to pursue these courses in the best institutions first, and to follow them with a year or more of exclusive study of chemistry both pure and applied. If it were possible to add to the courses of chemistry as much of engineering, civil, mechanical and architectural, as is found in some of the metallurgical courses, the ideal would be nearly met. But we can fully sympathize with those teachers who find the time available too limited for such a combination, and appreciate the fact that either the student must come to the professional school with better preliminary training in the preparatory subjects, or the course must be extended beyond the usually provided four years' work. In any case, if the course of engineering could be carried side by side and simultaneously with the course of chemistry, the needs of the prospective technical chemist would be most fully met and the requirements of the future chemical industry most nearly fulfilled. In some of our institutions in which all studies are practically optional, such a course might be arranged and profitably followed, and notwithstanding the longer time which might be involved in its completion, the graduate from it would issue with brighter and better prospects of success in his profession than one less broadly trained. And in the selection of the subjects for such a course, the

plans of study laid down in the technical high-schools of Germany, in the technical schools of England and of our own country, may be profitably followed.

In 1897, we expressed the view which seems thoroughly applicable now and which will perhaps bear repetition here. We said: "It seems, therefore, that the demand of the present time and of the immediate future can be met only by broadly educated men: by men who have been trained, not only in chemistry itself, but in the great principles of physics as well. A good technical chemist must be first of all a thoroughly educated chemist. After that, to attain the highest success in this country, he must be educated in the principles of engineering; the production and applications of heat; the production and applications of electricity; the transmission of power, the movement of liquids; in general, the means whereby the reactions of chemistry may be carried out in a large way. We need, therefore, chemical engineers, and these in the nature of the requirements must be broadly and thoroughly educated men. While they must be trained in the work of the research laboratories, which are being organized in connection with many of the great industries, they must likewise be prepared to put into practical operation in a large way the results of the researches they have been called upon to make."

These truths have not changed and if these conditions of education and training are fully met, the progress of our chemical industries must be greatly augmented, the science must, by reaction, be actively advanced and following the experience of our German confrères in the words of Meyer, we may look hopefully forward, and in the near future proudly backward, to accomplishments greater than the world has ever known.

WM. MCMURTRIE.

NEW YORK.

#### MAN'S PLACE IN NATURE.\*

IN the opening paragraphs of his most memorable contribution to knowledge ('Man's Place in Nature,' 1863), Huxley made mention of certain similarities between the activities of anthropoids and those of men; and, while the burden of the work was devoted to structural homologies, the initial keynote was retouched here and there throughout the discussion. Huxley's classic contribution to anthropology needs no encomium; it was a pioneer's mile-mark of progress, erected under difficulties; and it suffices that all later travelers have found it in the direct way of experiential truth. Yet it is worth while, now and then, to take stock of advances subsequent to, and largely consequent on, the Huxleian declaration.

Since Huxley's pioneer work, a host of investigators have carried forward the study of structural homologies connecting the genus *Homo* with lower genera and orders; and to-day the physical similarities are among the commonplaces of knowledge, whatsoever the background of philosophical opinion concerning cause and sequence. During the last decade or two the investigators themselves, with scarce an exception, have gone one step further, and now include sequence of development from lower to higher forms as among the commonplaces of opinion, whatsoever the background of metaphysical notion as to cause. There the strictly biologic aspect of the question as to man's place in nature may safely be considered to rest; there has been little advance in opinion beyond that of the pioneer in 1863; but the data have been multiplied, and the knowledge and opinion have been diffused widely.

Since Huxley's epoch-marking memoir

\*Address of the retiring President of the Anthropological Society of Washington, delivered before the Washington Academy of Sciences and Affiliated Societies, February 26, 1901.

was first published, occasional contributions have been made to knowledge of the activities displayed by various sub-human animals, and during the last quarter of the nineteenth century a science (which has been called the New Ethnology) has been organized to deal with the activities of mankind; yet singularly little has been done in the way of tracing activital homologies between the genus *Homo* and lower genera. It is indeed conventional for sociologists, and customary for comprehensive writers on anthropology, to instance the social habits of mammals and birds, and even of insects and infusoria, as analogous to human society; one naturalist has gone so far as to study various mammals and birds in their activital aspects, thereby opening a most attractive field in science as well as in literature; but investigators have not turned seriously toward the habitual activities displayed by the anthropoids—still less have comparative studies been made of the activities normal to both the higher quadrumana and the lower races of mankind, albeit this is perhaps the most inviting field now open to research. Thus far this line of inquiry grovels in the stage of travelers' tales: the gorilla-hunter tells how the family sire sleeps at the foot of a tree in which mother and young are nested; the naturalist in Liberia incidentally describes the use by monkeys of stick and stone implements, while the Bornean tourist tells of the simian servant who prefers the society of human masters to that of his kin and discriminates among the garments he is permitted to wear; but there is a woeful dearth of critical observation and a lamentable lack of judicious generalization pertaining to this promising meeting-ground of zoology and anthropology. So this aspect, too, of the great question concerning man's place in nature remains nearly as it was left by Huxley; the data are more abundant, and opinion has been both clari-

fied and diffused; yet definite homologies remain practically unfound, if not unsought, and the scattered facts have thrown little light on cause, less on sequence.

Since Huxley's prime, the New Ethnology has arisen; and it has opened a vista of facts and relations which apparently escaped the keen vision of the pioneer in 1863—the vista embracing thought, with all the other psychic factors pertaining to the activities, sub-human as well as human. This vista is perhaps the broadest and most attractive ever opened by science: When Galileo descried the harmonious paths of the planets in a sun-centered system, he raised the minds of men to a new plane; when Newton grasped the idea of gravitation, he gave human thought a new hold on nature; when Darwin discerned the lines of specific development, he wrought a revolution in the world of intellect; but when students still living scanned the lines of activital development and realized that thought itself is bred by the very activities over which it comes later to hold dominion, they opened a new intellectual world—a world at once so novel and so commanding that some of the students themselves are fain to sit at the gate and view the prospect as fleeting phantasm rather than veritable reality. Nor is their hesitation either unprecedented or unpardonable: When the biologists of only one long generation ago unrolled the scroll picturing the origin and perpetuation of species through natural interactions, their interpretation seemed too simple to be true; when the anthropologists of the present generation unrolled a similar scroll picturing the origin of activities (arts, industries, laws, languages, doctrines) through natural interactions and self-developed interrelations—and in this way alone,—their interpretation in turn seemed too simple to be true; and when the anthropologists of the old century's end (and

of this Society) unroll a scroll picturing the origin and development of thought itself through the long chain of interactions between the thinking organism and external nature—and in this way alone,—they foresee that their interpretation must seem too simple to be true—though they find comfort in the teachings of experience that in the long run simple explanations are preferred, that simple doctrines at last prevail, indeed that the progress of knowledge is best measured by its own simplification. But even after full allowance for hesitation and doubt, it must still be said that the opening of the post-Huxleian vista has had much effect; it has widened the view of nature to include the psychical as well as the physical aspects of organisms; it has correspondingly narrowed the range of extra-natural explanations of phenomena; and, specifically, it has revealed a new class of homologies among the races of men and between these and sub-human organisms. So the homologies recognized to-day as defining man's place in nature are of three classes: (1) structural, as wrought out by Huxley; (2) activital, as suggested by Huxley and wrought out by Powell; and (3) mental, or psychic. Expressed otherwise, man's place in nature is now defined, first by what mankind and their kindred *are*, second by what they *do*, and third by what they *think*. And the chief progress of the post-Huxleian epoch, albeit practically confined to *Homo sapiens* in various grades of development, has followed the lines of psychic homologies.

It is just to say that the foundation for modern knowledge of psychic homologies was laid by Tylor in his 'Primitive Culture' (1871), and especially in the seven notable chapters on animism elaborated in successive editions; for he showed that a certain type of philosophy is of world-wide extent, and is, or has been, shared by every race, every known people, whatsoever their

diversities of color or condition. This foundation was gradually raised into a definite platform partly by Tylor in later publications, partly by Powell in brief memoirs on 'The Mythology of the North American Indians' (1879) and 'Activital Similarities' (1881), in which it was shown that the interactions between distinct peoples and similar environments frequently produce similar activities, howsoever diverse the peoples themselves; and important additions to the platform were made by Brinton in various contributions summarized in his 'Religions of Primitive Peoples' (1897), in which he showed that the human mind, even in its more complex operations, reflects environment with striking fidelity. True (as recently shown by Boas\*), the products of interaction between peoples and environment are in some measure inconsistent and may even at first sight seem contradictory; but, as pointed out on a previous occasion,† the incongruities shrink or disappear when the comparisons are confined to peoples in corresponding degrees of cultural development.

The modern platform for the study of psychic homologies may be defined briefly in terms of a few generalizations, which seem to be consistent with the sum of knowledge concerning the psychic attributes of both human and sub-human organisms, viz.: (1) the mentality of animals is instinctive rather (or more) than ratiocinative, and for each species responds practically alike to like stimuli; (2) the savage mind is shaped largely by instinct, and responds nearly alike to like stimuli; (3) all barbaric minds are measurably similar in their responses to environmental stimuli; (4) civilized minds rise well above instinct, and

\* 'The Mind of Primitive Man,' SCIENCE, Vol. XIII., 1901, pp. 281-289.

† 'Cardinal Principles of Science,' *Proceedings of the Washington Academy of Science*, Vol. II., 1900, p. 11.

work in fairly similar ways under like stimuli; and (5) enlightened minds are essentially ratiocinative, largely independent of instinct, and less uniform in their responses to external stimuli than those of lower culture. The several generalizations are mutually and significantly harmonious; they combine to outline a course of development beginning in the animal realm with organisms adapted to environment through physiologic processes, and ending in that realm of enlightened humanity in which mind molds environment through nature-conquest;\* and they measure the gradual emergence of bestial instinct in the brightening intellect of progressive humanity. To, or at least toward, this platform those working anthropologists concerned with the broader aspects of the science have been pressed by accumulating observations and generalizations; yet the platform owes much of its character and most of its strength to the concurrent development of a scientific psychology at the hands of a notable group of experimentalists in psychic phenomena. The several generalizations embodied in the platform have already been summarized as the latest and most comprehensive among the principles of science, *i. e.*, the responsivity of mind; † and by aid of this principle, psychic homologies may be traced between higher culture-grades and lower, and from people to people and tribe to tribe, down to the plane of lowest savagery—where the lines cease for lack of data, leaving the lowly mind in a state even

\* Cf. 'The Seri Indians,' *Seventeenth Annual Report, Bureau of American Ethnology*, 1898, p. 269.

† "The cardinal principles of science may be reckoned as five: the indestructibility of matter, the contribution chiefly of Chemistry; the persistence of motion, the gift mainly of physics; the development of species, the offering of the biotic sciences; the uniformity of nature, the guerdon of geology and the older sciences; and the responsivity of mind, the joint gift of several sciences, though put in final form by anthropology." *Proceedings of the Washington Academy of Sciences*, Vol. II., 1900, pp. 11-12.

more suggestively akin to that of the sub-human organism than is the lowest human skeleton to that of the highest anthropoids.

Especially within the last decade of the old century, anthropologists have come to recognize a course of development of the esthetic arts—a sort of natural history of esthetics, arising in symbolism, running through conventionism, and maturing in a degree of refined realism found satisfying by civilized and enlightened peoples. Now a significant feature of this development is found in the fact that the initial symbolism is zoic or animistic, putatively if not patently. The esthetic hunger of primitive artists is sated by the carving of totems on reefs or rocks, by the molding of animal effigies, perhaps by the delineation and painting of zoic pictographs; as the artists rise in the scale of culture the zoic designs are partly conventionized (eventually passing into arbitrary alphabets), partly perpetuated in more realistic forms still conceived as fraught with mystical meaning, like the asp of Egyptian sculpture, the dragon of oriental painting, the curiously vestigial unicorn of a modern nation's coat-of-arms, and even the eagles of other national insignia. So, also, when primal man first yields to the charm of music, his songs and accompaniments mimic the rhythmic foot-falls of feared or venerated animals, the rustling sounds of animal movements, the inchoate melody of animal voices; when he enters the demesne of drama, his characters are beasts or uncanny monsters tricked out in zoic trappings; and it is only after long stages of development that anthropomorphic motives are introduced, and that the music and drama rise to the plane of realistic representation. In some cases, if not commonly, the germ of esthetic development quickens in painting of face or body, to grow into tattooing; in simplest form the painted devices may serve as



beacon-marks for the identification of kindred (like the face-marks of various animals), as among Seri matrons,\* or may symbolize fearsome animals, as among Sioux warriors; but in every well-known case the motive is symbolic expression of zoic attributes. From these germinal efforts of esthetic faculty to that modern stage of art in which the noblest realism and the highest idealism are wedded, the way is long; but every step is marked by the dropping of zoic motives and the substitution of motives springing from human attributes and aspirations.

Within a few years working anthropologists have come to recognize more or less clearly a natural history of industries, comparable with that of arts—a course of development also arising in symbolism, running through instinct-guided conventionalism, and maturing in that sublimest product of mentality, invention. It has long been known that barbaric artisans seek omens among birds, borrow lore from beasts, and run to zoic motives in decoration;† it has long been known, too, that savage hunters not only imitate the movements of feral animals in the chase and seek to incite their weapons and strengthen their arms by zoic trophies, but even mimic the carnivores' blood-craze in berserker rage at times of battle; and more recently it has been noted that the most primitive implements are of tooth, claw, shell and bone, selected and used as emblems of zoic power. In a typical tribe—the Seri, most primitive of known Amerinds—the pristine implement is a sea-lion tooth, differentiated into arrow, harpoon and fire-stick; the teeth themselves are classed as stones, and natural pebbles

are used for tools emblematic of the zoic organs, while the methods of chase and warfare still mimic the habits of local beasts. The lines of human progress from primal savagery to enlightenment may be traced in terms of development of each or all of the great groups of activities; and while all the tracings conform so closely as to inspire confidence in each, no outline is more definite than that represented by the stages of industrial progress—stages best defined in terms of the mind-led activities of which artifacts are normal products. These stages (beginning with that typified by the Seri) are: (1) Zoömimic, in which bestial organs are used as arrows and other implements, to which magical powers are imputed by dominating zootheistic faith; (2) Protolithic, in which naturally formed stones are used for cleavers and other implements, under the sway of mystical faith modified by experience of mechanical chance; (3) Technolithic, in which design-shaped stones are used for knives and other implements in ways revealing the germ of invention; and (4) Metallurgic, in which ores are smelted and used for tools under the influence of invention.\* Whether the progress be traced through these stages or otherwise, the way from the simple industries of the prime to the elaborate devices of modernity is long, very long; yet a full half of the steps are marked by the dropping of zoic motives and the substitution of motives expressing man's growing consciousness of power in nature-conquest.

Since Tylor traced primitive culture, and especially since Morgan wrote on 'Ancient Society' (1877), it has been recognized that all known primitive peoples are banded in consanguineal groups, while advanced peoples are bound in larger groups by laws defining proprietary and personal rights;

\*The somatic and telic functions of face-painting are discussed in 'The Seri Indians,' op. cit., pp. 167 et seq.

† Even the faith-guided anti-zoic motive of arabesque decoration attests the force of the zoic tendency and the effect required to divert it.

\*The stages and transitional sub-stages are set forth in greater detail in 'The Seri Indians,' op. cit., pp. 249-254.

and during the last decade or two working anthropologists have come to recognize the course of development of social organization in its several stages, *i. e.*, the natural history of law. Now it is significant that the most primitive social bond (found alike in America, Africa, Australia and parts of Asia) is that fixed by the ocular blood kinship of maternity, and that the next great stage is defined by paternal relationship; for in both stages the lines seem to be homologous with the instinctive habits of sub-human species, while the earlier the more closely approaches the low plane of brute knowledge—so far as this can be inferred from brute conduct. The researches among the aborigines of America have thrown strong light on the lowly laws of primitive peoples; for it has been ascertained that both savage clans and barbaric gentes are bound not merely by community of blood, but welded into homogeneous units by community of faith in zoic tutelaries—faith so profound, so blent with fear and hope, so impressed by recurrent ceremony from birth to maturity and thence to old age and death, as to dominate every thought and regulate every action. The Amerind tribesmen are grouped by totems (or tutelaries) of Wolf, Badger, Bear, Fox, Deer, Coyote, Eagle, Bluejay, etc.; they call themselves wolves, or badgers, or Bears, or Eagles, and glory in the strength and magical prestige believed to be brought them by their genii; most of them recite traditions of descent from the tutelary animals, or else from fantastic monsters invested with their attributes; and every adequately studied tribe has been found to possess a traditional genesis or sacred cosmogony in which the tutelaries, and perhaps other beasts, are glorified if not deified. The exoteric bond of clan or gens is blood-kinship; but the union is reinforced by an incomparably stronger esoteric bond of animistic belief. The way from beast-clanship to free citizenship is long—so long as to

afford the most striking measure of human progress; yet every step of the way is marked by the elimination of zoic concepts and by the substitution of those concepts of higher humanity forced on the genus *Homo* through the ceaseless strife for nature-conquest.

During some decades past, students of aboriginal tongues have been impressed by the failure of primitive folk to discriminate clearly between men and animals in their every-day speech; and this lowly habit forms one of the phenomena which have served (as recently shown by Powell\*) as a guide to the natural history of languages. Many Amerind tribes denote themselves by a term connecting animals, either in general or of a particular class, and when pressed to specify are compelled to employ an affix or adjective to distinguish the human kind (often considered inferior) from the rest; some, like the Papago, trace human genealogy through only a few generations, forward or backward, and conceive the lines as beginning and ending in an undifferentiated magma of zoic life designated by a single term; while some groups have progressed so far in the way of human superiority as to dignify themselves by the expressions 'Real Men,' 'True Men,' etc., in contradistinction from alien tribes and other contemptible creatures. The scroll picturing the development of language is expanded about midlength by the addition of the scriptorial branch, representing the growth of graphic expression: and it is quite in accord with the growth-lines of oral expression to find that the earliest essays in ideography are pictures of zoic objects, or objects to which zoic attributes were manifestly imputed. Most of the primal features of modern alphabets have been conventionalized beyond recognition, but the hieroglyphs

\* 'Philology, or the Science of Activities designed for Expression,' *The American Anthropologist*, Vol. II., 1900, pp. 603-637.

of Mexico and Egypt and the ideographs of China are among the clearer vestiges of primitive standards, while the fancy-wrought constellations of the celestial sphere—birth-mates of pre-Cadmean characters remaining unchanged by reason of remoteness from practical affairs—still conserve the graphic zoolatry in which writing began. The way from lowly language linking men and beasts in word and sign to a discrete graphic vocabulary is long; yet the earlier steps were unquestionably marked by the dropping of instincts shared by brutes and the substitution of humanitarian concepts impressed by ever-widening human associations.

Since Tyler taught the world-wide range of animism in 1871, anthropologists have grouped the myths and faiths of mankind in a series of stages outlining a course of development—a natural history of doctrine—coming up through a slavish and despairing hylozoism, and ascending thence through higher zootheism and broadening worship of nature-powers on successive planes each brighter and more humane than the last. The zoic factors in primitive arts, industries, laws and languages were manifestly made potent in the olden time, as they are to-day among lowly folk, alike by overweening faith, and ever-present custom; they were, and still are, kept alive not only by recurrent ceremony and daily taboo and hourly precept, but by tireless study of animal contemporaries whose habits huntsmen must know under pain of hunger; so that much (perhaps most) of the sentient feeling of primal man must have been—as it is to-day among his survivors—of animal contemporaries. In savage life men and their animal associates are compelled to consecrate their best efforts to a study of each other; in affairs of feeling and faith as in matters of immediate utility, the association engenders habits of body maturing in instincts even-

tually ripening into action-shaping habits of mind; and the strongest mentality is naturally the more deeply influenced—until continued experience of superior faculty awakens consciousness of superior power, stirs the sleeping giant of self-confidence and rends the shackles of zoophobia forever.

Lo, the poor Indian! whose untutored mind  
Sees *Beasts* in clouds, or hears *them* in the wind:

so a modern Pope would write of the American natives; and so, too, he might write of any and all other aborigines made known through the researches of the last half-century. The upward way from primal beast-faith through concurrent fetichism and shamanism, and thence through mysticism and all manner of occultism, is long and need not now be traced; it suffices that all of the earlier and many of the later steps were marked by the dropping of zoic motives or vestiges, and the substitution of ever nobler motives and imageries.

When the scrolls picturing actual development are brought together—when the natural history of doctrines is outlined over those of languages, laws, industries and arts—the leading lines are found consistent in every essential feature; and all are seen to rise from a mentality both reflecting and approaching that of lower animals (though just how closely may not be measured until the sub-human mind is better understood) toward the higher human plane revealed in science and statecraft. The savage Seri—lowest of American tribesmen—is loathed by Caucasian neighbors as an uncanny beast, and it is a revelation to find that he reciprocates the loathing and glories in the contumely, feeling that it allies him the more closely with venerated consociates like puma and shark, and divides him the more widely from the hated white creatures of unnatural ways; and the sentiment of the Seri is measurably common to all

aborigines of strong individuality. The impressive fact, learned alike through observation of a typical tribe and through analysis of the mental operations of primitive peoples in general, is that the savage stands strikingly close to sub-human species in every aspect of mentality as well as in bodily habits and bodily structures.

Since Huxley's prime the chief advances in anthropology have related to what men *do* and what men *think*; and the progress has been such as to indicate with fairly satisfactory clearness the natural history of human thinking as well as that of human doing. Thereby man's place in nature may be defined more trenchantly than was possible in 1871: (1) As shown by Huxley, the structure of *Homo sapiens* is homologous with that of lower orders, while the morphologic differences between highest anthropoids and lowest men are less than those separating lowest men from highest men; (2) As suggested by Huxley and established by later researches, the activities of *Homo sapiens* are homologous with those of the anthropoids, while the activital range between club-using gorilla and tooth-using savage is far narrower than that separating the zoomimic savage from the engine-using inventor; (3) As shown by the latest researches, the mental workings of *Homo sapiens* are homologous with those of lower animals, while the range from the instinct and budding reason of higher animals to the thinking of lowest man would seem far less than that separating the beast-fearing savage from the scientist or statesman. The resemblances and differences in doing and thinking may not yet be measured in definite units, as are cranial capacities and facial angles (though the recent progress in experimental psychology gives promise of quantitative determinations of general sort at no distant day); yet the relations are hardly less clear and tangible than those

customarily measured in inches and ounces and degrees.

So, in the light of the latest researches, man must be placed wholly within the domain of nature, yet above all other organisms at heights varying widely with that highest product and expression of nature, mental power.

W J MCGEE.

---

THOMAS BENTON BROOKS.

THOMAS BENTON BROOKS was born June 15, 1836, at Monroe, N. Y. He died November 22, 1900, at his home near Newburg, only a few miles from his birthplace, but during the sixty-four years of his life he had gone far, not only to distant countries but also to fields of experience and thought remote from his early environment. Born to the associations and inheritance of a small farm in a country district, he made his way to a prominent position in engineering and geology by his energy, ability and originality.

His early training and also his later education embodied more practise than theory. The district school, two years (1856-58) at the School of Engineering, Union College and a single course of lectures on geology under Lesley at the University of Pennsylvania (1858-59) cover his formal education, but he seized with eager purpose opportunities to learn in the school of practise. By observation of field methods he fitted himself to pass from axeman to rodman, levelman, transit man and topographer, first on surveys for the Erie Railroad and later on the newly initiated topographical and geological surveys of New Jersey in 1853. In this latter connection he served as axeman to an Austrian who employed a then little-known instrument, a plane table, and Brooks by watching him became so proficient in its use that he succeeded his chief. He was then seventeen. Subsequently, while a student at Union College, he made

extensive surveys in the forested mountainous region west of the Hudson, the Highlands. To this experience he added that of service during one winter with a Coast Survey party in the Gulf of Mexico.

The outbreak of the Civil War found him, at the age of twenty-five, established as a trusted leader among his associates. Enlisting as a private, he was followed by a number of those who had known him as a surveyor, and he was mustered into service as 1st Lieutenant, Company A, New York Volunteer Engineers, September, 1861. He served until the fall of 1864, when he resigned at the request of his parents after the death of his brother, Lieut. J. H. Brooks, in the trenches before Petersburg.

Major Brooks, as he was generally called, although he reached the rank of Brevet Colonel, won conspicuous recognition as a military engineer at the sieges of Fort Pulaski and Fort Wagner. His industry was indefatigable, his engineering talent manifest, his courage, devotion and self-sacrifice unflinching.

After a year with the New Jersey Geological Survey, in August, 1865, Major Brooks accepted a position as vice-president and general manager of the Iron Cliff Mine near Negaunee, in the Marquette iron district, Lake Superior. Therewith his more important work in geologic research may be said to have begun. The geology of the Lake Superior Basin had previously been scanned by Foster, Whitney, Houghton, Logan, Agassiz and others, and the Laurentian, Huronian and Silurian systems had been vaguely distinguished; but the pressing problems of the geology of the iron ores and related formations remained untouched. The difficulties of investigation in that district are even now very great. Forest, windfall and underbrush make the physical labor of exploration severe; drift mantles wide areas, and the relations of the folded, refolded,

squeezed and metamorphosed formations are extraordinarily intricate. Settlement of the wilderness, extensive prospecting and mining operations and the development of modern petrographical methods have made a solution of these relations possible, but when Brooks faced them the difficulties were unequalled, the means and methods sadly inadequate. Nevertheless, he attacked them with characteristic energy and originality. He invented methods, he provided means, he spent himself, and he achieved the greatest measure of success then possible. In general geology he contributed important data and conclusions on the great geologic systems and the unconformities which separate them. In theoretical geology he first suggested that secondary deposition might be the genetic condition of the iron ore bodies. But it was in applied geology that he made his chief contribution, one in which he found most satisfaction, and one for which not only Michigan is his debtor, but also the people of the United States. Our country's iron and steel industry, our machine shops, our railway systems, and all the wonderful material conquest of the continent have been greatly promoted by exploitation of Lake Superior iron ores. Brooks took hold of that exploitation in its beginning, and he had a leading part in its development. Simple methods were needed of surveying in the unbroken forest amid widely varying magnetic attractions. Brooks devised the dial compass and taught men to pace distances in the most tangled underbrush. Magnetic surveys were necessary as a means of prospecting. Brooks adapted the dip needle to the capacity and purposes of the prospector. Men wanted practical advice based on scientific principles. Brooks harnessed his practise and his science together, and thus became the most reliable mining engineer, as well as the most useful geologist, in the region.

As the chief authority on the iron-bearing formations of the Upper Peninsula, Brooks was asked in 1869 to take charge of the Economic State Geological Survey of that district, and he accepted on condition that he should be allowed to secure all the private aid possible. The necessity for this provision is apparent when it is understood that during four years the State paid toward the work but \$9,000, while he spent \$2,000 of his own means and received no pay himself. The results of his work are embodied in Volumes II. and III. of the Michigan State Geological Survey. His reports are direct in style, simple in treatment and extremely practical in substance. They are models of excellence as economic geologic reports. The most original chapters, and those which still possess most practical value, relate to the principles of mine management and of magnetic observations in prospecting for iron ores. For many years the chapters on geology were standards of reference, and they have been replaced only by most elaborate studies, based largely on Brooks' work and carried out with the most refined methods of modern geology. Says Van Hise, Brooks' successor: "Notwithstanding the immense advantage which it has been to have Brooks' work as a foundation, it has taken many years of labor fairly to complete the structural story to which Brooks contributed important chapters. Only those who have labored in the Lake Superior region and who understand its peculiar difficulties can give Brooks credit for the remarkable work he did. His geological work is my ideal of what should be done in a new region of complex geology."

In 1873 Major Brooks' health gave out under the stress of overwork to which he drove himself. He sought relief abroad, and resided in London and Dresden while completing his State reports. He became a Fellow of the Geological Society of Lon-

don and Corresponding member of the Geological Society of Edinburgh. Returned to this country in 1876, he resided at Monroe and at Newburg, N. Y., and after 1883, during the winters, at Bainbridge, Ga., living the life of a country gentleman and farmer. His interest in science and engineering practice never abated, and he was always ready with wise counsel, even though strength failed him for action.

Major Brooks was characterized by intense energy, which exhausted his physique before he reached middle age; by originality, which combined with common sense made him a most efficient man of affairs; by keen powers of observation and deduction, which he applied untiringly to scientific research; by geniality and affection, generosity, truthfulness and loyalty to principle, which made him beloved and stamped him as a man whose memory will be honored and revered.

BAILEY WILLIS.

U. S. GEOLOGICAL SURVEY.

SCIENTIFIC BOOKS.

THE APPRECIATION OF NON-EUCLIDEAN  
GEOMETRY.

*Histoire des Mathématiques.* Par JACQUES BOYER. Paris, Carré et Naud. 1900. 8vo. Pp. xi + 260. Price, 5 francs.

*Geometry: Ancient and Modern.* By Professor EDWIN S. CRAWLEY. *Popular Science Monthly* (January). 1901. Pp. 257-266.

*Non-Euclidean Geometry.* By Professor HENRY PARKER MANNING. Boston, Ginn and Company. 1901. 8vo. Pp. vi + 95.

The last section of Boyer's attractive book is headed 'Géométrie Euclidienne et Géométries non-Euclidiennes.' He says, p. 240, "The last quarter of the nineteenth century witnessed the building up of interesting theories." The next page continues: "But beyond contradiction the most original researches of this period pertain to the non-Euclidean geometries, and it is by them that we will terminate this incomplete exposition of contemporary science." The brief account which follows (less than five

pages) is certainly stimulating, and is adorned by a full-page portrait of Lobachevski, taken from that given in the Kazan edition of his collected works.

But there is extant another picture of Lobachevski far more impressive, showing him in the plenitude of his powers, which I first saw at Kazan, a daguerreotype from the life, a copy from which you may see as the frontispiece of Engel's monumental 'Nikolaj Iwanowitsch Lobatschewskij.'

As for Boyer's account of what he rates so high, it begins as follows: "From long ago it has been sought to demonstrate the famous axiom laid down twenty centuries ago by Euclid, to wit: through a point only one parallel to a given straight can be drawn."

This of course is not Euclid's postulatam, but rather a paraphrase of what is called (even by Cajori) Playfair's axiom, though Playfair explicitly credits it to Ludlam, namely: "That two straight lines which cut one another can not be both parallel to the same straight line." Boyer continues: "These attempts remained unfruitful. However, at the end of the eighteenth century, an Italian Jesuit, Saccheri, wished to found a geometry resting on a principle different from the celebrated postulate." It was certainly not *the end* of the eighteenth century, for Saccheri died in 1733. Nor did he wish to set up any geometry different from Euclid, since the very title of his book was 'Euclid vindicated from every fleck.'

"Finally," continues Boyer, "at the opening of the nineteenth century, a Russian, Lobachevski, and a Hungarian, John Bolyai, perceived at about the same time the impossibility of this demonstration." In the index, citing to this page, Boyer gives as the dates of the birth and death of John Bolyai 1775-1856, the dates for his father Wolfgang Bolyai (Bolyai Farkas). Lombroso makes this same confusion and identification of father and son, and from it draws testimony for his thesis that great wits to madness are allied.

John Bolyai (Bolyai János) was born December 15, 1802, and died January 27, 1860. At the celebration of his centenary next year in Hungary I hope to be present. Boyer continues: "Their works published independ-

ently of each other had without doubt been inspired by the doctrines of the philosopher Kant who, in a passage of his *Critique of the pure reason*, indicated a new consideration of space. For this latter, space existed *a priori*, precedent to all experience, as completely subjective form of our intuition."

In regard to this bold attribution of influence, I may be allowed to say that not a particle of evidence has appeared to show that John Bolyai ever heard of even the existence of Kant. I examined Bolyai's papers, his correspondence, his 'Nachlass', at Maros-Vásárhely, and never found even the name of Kant. As for Lobachevski, he might have had his attention called to Kant by Bronner the professor of physics at Kasan, at one time an admirer of the 'Kritik der reinen Vernunft,' but that Kant influenced him is mere conjecture, and unnecessary, since we sufficiently know the path of his mental on-going. Of Lobachevski's doctrine, Boyer says, p. 242, "He declares at the beginning the following axiom: through a point can be drawn *many parallels* to a given straight."

What Lobachevski does assume is that through a given point can be drawn innumerable distinct straight lines in a plane which will never meet a given straight in that same plane; but of these, only those two are parallel to the given straight which approach it asymptotically.

Continuing, Boyer says of Lobachevski, p. 245, "When he died in 1856 he occupied the position of Rector of the University which he had entered as simple student."

Unfortunately Lobachevski had been deprived of his position of Rector for ten years before he died.

Passing on to Riemann's geometry, Boyer says: "To construct this Geometry, its inventor or rejects the postulatam and the first axiom of Euclid: two points determine a straight."

But the postulatam is: "And if a straight cutting two straights makes with them interior angles lying on the same side, which together are less than two right angles, then the two straights intersect if continually produced on the side upon which these angles lie."

In the 'spherical' or Riemannian geometry

here referred to, so far from this being rejected, it actually remains true. In the 'elliptic' or Clifford-Klein geometry its last clause becomes unmeaning, because the straight line does not divide the elliptic plane into two separated regions. Here we cannot distinguish two sides of a straight. Without crossing a given straight we can pass from any one point of the plane to any other point. In this elliptic geometry, the other assumption mentioned by Boyer, that two straight lines cannot meet at more than one point, is retained. Riemann's epoch-making contribution was that the universe while unbounded still may very well be finite.

This gives us the assumption that a straight line has no point at infinity, that is, that every straight line is actually cut by every other straight line coplanar with it.

Now dropping Euclid's implicit, not explicit, assumption that the straight line is infinite, but retaining all his postulates and axioms, especially Postulate 1 (Simon's Euclid, 1901, p. 30), "Let it be granted that one and only one sect can be drawn from any one point to any other point," we have the elliptic geometry.

On p. 245, line 23, is a misprint, 'joints' for 'points.'

Peirce (C. S.), p. 247, is identified with his father in the index, his name being given as Benjamin and his dates as 1809-1880.

Mr. C. S. Peirce is still alive, having an article in the January, 1901, number of the *Popular Science Monthly*, which contains the charming résumé by Professor Crawley entitled, 'Geometry: Ancient and Modern.' Perhaps it could be wished that this article had more definitely emphasized Euclid.

The advertisement of Boyer's 'Histoire' calls mathematics the science of Euclid and Newton.

In writing of 'The Wonderful Century,' Alfred Russel Wallace says of all time before the seventeenth century: "Theu, going backward, we can find nothing of the first rank except Euclid's wonderful system of geometry, perhaps the most remarkable mental product of the earliest civilizations."

The new departure, the non-Euclidean geometry, is absolutely epoch-making, but fortunately it has intensified admiration for that

imperishable model, already in dim antiquity a classic, the immortal *Elements* of Euclid.

Professor Crawley's exposition of the non-Euclidean geometry is exceedingly interesting. But as soon as it gets beyond two dimensions it becomes obscure.

He says, p. 265, "If we proceed beyond the domain of two dimensional geometry we merge the ideas of non-Euclidean and hyper-space."

If we do, we are very apt to blunder. Thus Professor Crawley says, p. 266, "Professor Newcomb has deduced the actual dimensions of the visible universe in terms of the measurement of curvature in the fourth dimension."

This mistake of supposing that a non-Euclidean space requires or needs a space of higher dimensionality has often been publicly corrected.

On page 293 of his 'Nicht-Euklidische Geometrie, I.' Felix Klein puts in pillory the unfortunate title of Newcomb's contribution as follows: "Elementary theorems relating to the geometry of a space of three dimensions and of uniform positive curvature in the fourth dimension. (Die letzten Worte des Titels sind sehr merkwürdig und deuten auf ein Missverständnis.)"

After 'we merge the ideas,' Professor Crawley's very next sentence is: "The ordinary triply-extended space of our experience is purely Euclidean." This naïve assertion not only Professor Crawley does not know and cannot prove, but, strangely enough, no one can ever know, no one can ever prove. For Euclidean space the angle-sum of a rectilinear triangle must be exactly two right angles. Such absolutely exact metric results experience can never give.

In connecting a geometry with experience there is involved a process which we find in the theoretical handling of any empirical data, and which therefore should be familiarly intelligible to any scientist. The results of any observations hold good, are valid, always only within definite limits of exactitude and under particular conditions. When we set up the axioms, we put in place of these results statements of absolute precision and generality. In this idealization of the empirical data our addition is at first only restricted in its arbitrariness in



so much as it must seem to approximate, must apparently fit, the supposed facts of experience, and, on the other hand, must introduce no logical contradiction. Thus to-day the ordinary triply-extended space of our experience may be purely Bolyaian, or purely Euclidean, or purely Cliffordian, or purely Riemannian.

In Manning's 'Non-Euclidean Geometry' America has taken a step in advance of all the world in thus putting forth an intended, available class-book for elementary instruction in this fascinating subject.

The book is very gratifying to me, in that the method of treatment that has been taken as the basis of the first chapter is Saccheri's, drawn from my translation, the first ever made, which appeared in the *American Mathematical Monthly*, beginning in June, 1894. My copy of Saccheri is still, so far as I am aware, the only copy on the Western Continent.

It is also matter for congratulation that so many of the further proofs have been taken unchanged from Lobachevski and Bolyai. We rejoice that the world will be rich now in pupils of those who in life had never a disciple.

It perhaps should be noted that though the book says (p. 93), "The Elliptic Geometry was left to be discovered by Riemann," it gives only the simple elliptic, or single elliptic, or Clifford-Klein geometry. It never even mentions the double elliptic or spherical or Riemannian geometry, which Killing maintains was the only form which ever came before Riemann's mind.

GEORGE BRUCE HALSTED.

AUSTIN, TEXAS.

*Commercial Organic Analysis.* By ALFRED H. ALLEN, F.I.C., F.C.S. Volume II., Part II.; Hydrocarbons, Petroleum, and Coal Tar Products, Asphalt, Phenols, and Creosotes. Third Edition, with revisions and additions by the Author and HENRY LEFFMANN, M.A., M.D. Philadelphia, P. Blakiston's Son and Co. 1900. Pp. viii+322. Price, \$3.50.

In the revision of this volume, most of the notes of the second edition have been incorporated in the text, the text condensed to a certain extent, by minor changes, and by omissions, and many valuable additions made. Much matter has been added in regard to the testing of lubricating oils and phenols, and the

technology of acetylene. The section on asphalt has been largely increased. The claim of the preface that the nomenclature of the Geneva convention has been applied does not seem justified. Some of the analytical operations are not described in sufficient detail, notably the method for the assay of calcium carbide (page 32). The determination of sulphur in petroleum does not receive the attention it deserves, the most important method—combustion in a current of oxygen or air, and collection of the sulphur dioxide in standard alkali—receiving only passing mention in the section on asphalt. The method for the detection of  $\beta$ -naphthol 'suggested' by the American Association of Official Agricultural Chemists was indeed described by the referee in his report, but has not yet been adopted officially by that body. It should be credited rather to Dr. W. D. Bigelow, the referee. It was considered necessary to call attention to these points, but in considering them, the general excellence of the revision should not be lost sight of.

G. S. FRAPS.

*L. M. B. C. Memoirs on Typical British Marine-Plants and Animals.* Edited by W. A. HERDMAN, D.Sc., F.R.S. V. *Alcyonium* by SYDNEY J. HICKSON, M.A., D.Sc., F.R.S. London, Williams & Norgate. 1901.

A student or amateur zoologist visiting the sea-shore is apt to find the ordinary text-books of zoology somewhat too general to be of much service to him in unraveling the structural details of many of the forms which attract his attention, and the number of forms described in the more special laboratory manuals being necessarily limited, he may find no mention in these of the special organism which interests him. To meet this difficulty the Liverpool Marine Biology Committee has undertaken the publication of a series of memoirs giving detailed descriptions of a number of common animals and plants occurring in the district under investigation by the Committee. The fifth of these memoirs, on *Alcyonium* by Professor Sydney J. Hickson, has just appeared, its predecessor being memoirs on *Ascidia* by Professor Herdman, on *Cardium* by Mr. J. Johnstone, on *Echinus* by Mr. H. C. Chadwick and on *Codium*

by Mr. R. J. H. Gibson and Miss Helen Auld. The editor announces twenty-five other memoirs in course of preparation.

The present little volume, which may be taken as a sample of the series, opens with a brief introduction containing a definition of the order Alcyonaria, and then follow sections on the general appearance of a colony of *Alcyonium digitatum*, its reproduction, the anatomy of the colony, the anatomy of the polyps, the development of the colony and finally its physiology. Three plates containing twenty-four figures complete the little volume, which consists of but twenty-two octavo pages and is sold for the modest sum of eightpence.

It is almost needless to say that a description of *Alcyonium* by Professor Hickson is well done, and if the remaining volumes prove as satisfactory as the present one, the editor is to be congratulated upon the initiation of so admirable and useful a series. It would seem that the zoologists of this country might profitably undertake a similar series of memoirs and the idea may be commended to the attention of the officers of the Marine Biological Laboratory.

J. P. McM.

#### SCIENTIFIC JOURNALS AND ARTICLES.

IN the January-February number of the *Journal of Geology*, Frank Dawson Adams gives an account of 'The Excursion to the Pyrenees in Connection with the Eighteenth International Geological Congress.' The interest centers largely around certain rocks supposed by Lecroix and some other eminent French geologists to illustrate the transformation of limestone into diorite and of shales into gneiss and granite by emanation accompanying granitic intrusions. Professor Adams does not regard the case as proved and suggests, among other things, chemical analysis as a means of testing the hypothesis. O. C. Farrington contributes a discussion of 'The Structure of Meteorites.' They are treated under three classes, iron, iron-stone and stone meteorites. Structures of the monogenic meteorites are discussed crystallographically those of the polygenic according to their mode of aggregation. In a paper entitled 'The Problem of the Monticuliporoidea,' F. W.

Sardeson discusses these much neglected although important organisms of the Paleozoic faunas. Unlike many of the recent writers, he has considered them as corals rather than as bryozoans, and several of the commoner forms are described in such detail as to greatly assist students beginning the investigation of these fossils. 'Valleys of Solution in Northern Arkansas' are discussed by A. H. Purdue. They are described as steep and bilaterally symmetrical, with remarkable straightness, due, no doubt, to their connection with jointing planes.

The *Botanical Gazette* for February contains the first of two papers by Dr. H. C. Cowles upon 'The Physiographic Ecology of Chicago and Vicinity; a study of the origin, development and classification of the plant societies.' Dr. Cowles gives his views on the classification of plant societies, and proposes a method based on the laws of physiography. The general principles outlined in full have been noted already in *SCIENCE* (Vol. XII., p. 708, Nov. 9, 1900), and are here worked out in connection with the Chicago area. The plant societies are grouped in five genetic series, the first of which, that on rivers, is presented in the first instalment. The paper is illustrated by half-tone reproductions which show the various stages in the development of river-plant societies, from the ravine with its mesophytic slopes, through the xerophytic bluffs stages, and culminating in the mesophytic forest of the flood plain which is regarded as the climax phase of regional development. Mr. John Donnell Smith, publishes his 22nd paper on 'Undescribed Plants from Guatemala and other Central American Republics,' describing about thirty new species from this exceedingly prolific region. Miss Mary H. Smith, of Cornell University, publishes an account of some experiments which would indicate that nitrates are a source of nitrogen for saprophytic fungi. Carlton E. Preston, of Harvard University, publishes a second note on non-sexual propagation in *Opuntia*. Various book reviews, minor notices, notes for students, and news items complete the number.

*Torrey* is the title of a new monthly journal of botanical notes and news edited for the Torrey Botanical Club by Dr. Marshall A. Howe. A half-tone medallion of Dr. John Torrey, in whose honor the periodical is named, adorns the cover. The object of the journal is to provide a medium for short and semi-popular articles and for reviews, news items, etc., the *Bulletin* of the Club being thus reserved for the longer and more technical papers. It is expected that considerable prominence will be given to notes relative to the teaching of botanical science. The first number of *Torrey* (January) includes the following articles: 'Notes on *Rudbeckia hirta*,' by Dr. N. L. Britton; 'Seedlings of *Ariseema*,' by Dr. D. T. MacDougal; 'Notes on the Genus *Lycopodium*,' by Professor F. E. Lloyd; 'The Summit Flora of King's Mountain and Crowder's Mountain, North Carolina,' by Dr. J. K. Small; 'A simple Dynamometer,' by Dr. H. M. Richards; 'The rare Mosses of Bashbish Falls,' by Mrs. N. L. Britton; and 'Economy in Nature,' by Dr. P. A. Rydberg. The February number contains: 'The Value of Forestry in a Course of Nature Study,' by Miss Elizabeth Carss; 'A new Hygrometer suitable for testing the Action of Stomata,' by Dr. D. T. MacDougal; 'The *Lygodium* at Home,' by Frederick H. Blodgett; 'A new *Senecio* from Pennsylvania,' by Dr. N. L. Britton; and '*Rosellinia ovalis*,' by William A. Riley.

MR. HARRY F. WITHERBY, who has lately made an expedition to the White Nile in search of birds, will commence, in the next issue of *Knowledge*, a series of illustrated articles descriptive of the country, its people, its wild animals and its birds. In the first instalment the author deals with his journey by river and the Desert Railway from Cairo to Khartoum, and gives his impressions of Khartoum and Omdurman.

#### SOCIETIES AND ACADEMIES.

##### SECTION OF BIOLOGY OF THE NEW YORK ACADEMY OF SCIENCES.

THE regular monthly meeting for February was held on the 11th, Professor C. L. Bristol

presiding. The following program was offered:

D. T. MacDougal: 'The Critical Points in the Relation of Light to Plants.'

A. G. Mayer: 'The Variations of a Newly-arisen Race of *Medusa*.'

Dr. MacDougal stated that an examination of all the data at hand shows no correspondence among the maxima, minima and optima of intensities of light with regard to the various influences exerted upon the plant by light, and that the current conception of *phototonus* is not based upon well-defined generalizations. Etiolative phenomena of plants are irritable reactions, consisting chiefly in the elongation of organs which would carry the chlorophyll screens and reproductive bodies up into the light. Light is not necessary to the motility of protoplasm, nor for the activity of the motor mechanisms of such plants as *Mimosa*. The condition known as *darkness-rigor* does not exist. Appearances commonly supposed to be due to rigor of darkness are pathological phenomena occasioned by the disintegration of chlorophyll and other substances. Light may exert a direct chemical (disintegrative) effect upon the constructive material of the cell, but it does not retard growth; on the contrary, it accelerates growth in algae. Evidence that light exercises a paratonic influence upon plants is not at hand, and no observations could be found by the speaker supporting the conclusion that a similar retarding influence of light upon growth occurs among animals. In discussion of Dr. MacDougal's paper, Mr. M. A. Bigelow called attention to some experiments made by him, under the direction of Professor C. B. Davenport, to determine the influence of light upon embryonic development and post-embryonic growth in Amphibia. Light does not retard, but rather accelerates developmental processes, the effective rays being red in embryonic and blue during post-embryonic stages.

Dr. Mayer stated that in 1898 he had discovered a pentamerous *Hydromedusa* at the Tortugas, Florida, and had named it *Pseudoclytia pentata*. In this form there are five radial canals, five lips, and five gonads 72° apart, instead of four of these various organs at intervals

of 90°, as in other Hydromedusæ. In its anatomy it is related to the genus *Epenthesis*, being indeed very close to *E. folleata*, which also occurs at the Tortugas. It is probably the descendant of some *Epenthesis*, and seems to be a newly-arisen species. No studies have as yet been made by zoologists upon the variations of such forms. The medusa is highly variable. Out of 1,000 individuals 703 are normal radially symmetrical medusæ, with five radial canals and five lips at intervals of 72°, while 297 are abnormal in some respect, having 4, 3, 2, or 6, 7, 8 canals or lips. It is remarkable that fully 50 per cent. of the abnormal individuals are radially-symmetrical. The greater the departure from the normal form the smaller is the ratio of radially-symmetrical individuals. Thus only 11.2 per cent. of the medusæ having five canals are irregular, while 30 to 33 per cent. of those with four or six canals are irregular; in medusæ with seven or three canals 50 per cent. are irregular, while 100 per cent. of those with two or eight canals are so. The lips show a decided tendency to revert to the ancestral number of four, at intervals of 90°, but the canals, on the contrary, incline toward the higher numbers. We have here a medusa which is continually producing radially-symmetrical sports, and is initiating, so to speak, what might become new species were conditions favorable. On comparing the variations of *P. pentata* with those of *E. folleata* or *Eucope*, one is struck with many remarkable family likenesses. This is especially true in the former comparison. The similarity of the variations, the likeness of their abnormalities in these closely-related forms, indicate apparently a race kinship. The abnormal young of *P. pentata* appear to survive fully as well as normal individuals, and abnormal medusæ mature their gonads quite as commonly as the normal forms. The former are not weeded out by natural selection, yet they have not succeeded in establishing new types of medusæ.

In discussion of Dr. Mayer's paper, Dr. MacDougal spoke of a sport of *Populus tremuloides*, discovered by Dr. Britton, in which the irritability to gravity of the leaves had been reversed so that they now pointed downwards. The reversal appeared in the buds. New plants prop-

agated by grafting retained the positive geotropism of the leaves. It was also stated that the 'weeping' varieties of certain trees were usually produced in this way.

HENRY E. CRAMPTON,  
Secretary.

SECTION OF ANTHROPOLOGY AND PSYCHOLOGY  
OF THE NEW YORK ACADEMY  
OF SCIENCES.

A REGULAR meeting of the Section was held on February 15th. Dr. D. R. Major reported the results of physical and mental tests on school children of high and of low class standing, the aim of these tests being to discover what relation, if any, exists between class standing and the ability shown in the particular tests used. The tests were as follows: Visual and auditory memory for figures and words, striking out of A's, naming 100 words, copying of figures, weight discrimination, perception of size, sensation-area test as used in the Columbia laboratory, eyesight, age and talkativeness. The tests were made on 150 New York City school children, 68 having high class standing, 82 low. The results of the tests tend to show that the class standing bears a close relation to the ability to pronounce words, to carefulness or accuracy in striking out A's, to memory for words, to eyesight, to age (the average age of the good pupils being less than the average age of the class), and to talkativeness (the good pupils being as a rule talkative). There is apparently little, if any, relation between class standing and the ability shown in the other tests mentioned. The study, however, is not completed and the opinions expressed here are subject to change. In addition to the use made of the standard psychological tests, an attempt is being made to devise tests to determine the presence, nature, and quality or worth of perceptive activities.

The second paper by Mr. E. A. Spitzka described with special reference to their similarities, the brains of two distinguished physicians, Dr. Edouard Seguin, and his son, Dr. Edward C. Seguin. The most striking similarity discoverable in these brains is the unusual development in the left Insula. This similarity was attributed by the author to heredity, and was

held to be the physical basis for the high type of ability shown by both the Seguins in the use of language.

CHARLES H. JUDD,  
Secretary.

SECTION OF ASTRONOMY, PHYSICS AND CHEMISTRY OF THE NEW YORK ACADEMY OF SCIENCES

A REGULAR meeting of the Section was held on March 4, 1901. The annual election of officers of the Section was held, Professor William Hallowell being elected Chairman and Dr. F. L. Tufts, of Columbia University, Secretary for the ensuing year.

The first paper was by Professor R. S. Woodward and Mr. J. W. Miller, Jr., on 'The Elastic Properties of Helical Springs.' This was part of an investigation now in progress and the details will be published later when the investigation is completed.

Dr. F. L. Tufts then read a paper on 'A Photographic Study of the Air Movements near the Mouth of an Organ Pipe.' In this paper the author described experiments in which he applied the 'method of striæ,' similar to that used by Toepler, C. V. Boys, R. W. Wood and others, to the study of the vibrations within an organ pipe. The pipe used had sides made of plane parallel glass plates. The tongue of air at the mouth of the pipe was made visible by using air mixed with alcohol vapor which changed its optical density. The vibrations and air currents within the pipe were made visible by the introduction into the pipe of small jets of illuminating gas. The intermittent illumination used was the spark between magnesium ribbons from an induction coil. It was found quite easy to adjust the rate of interruption of the coil so as to produce a stroboscopic effect, and thus the movements of the tongue of air in the mouth of the pipe and the vibrations and air currents in the pipe could be readily followed.

The same method was also applied by the author to study the behavior of unignited jets of illuminating gas when acted on by sound waves. The paper was illustrated by a number of photographs of the phenomena observed.

WILLIAM S. DAY,  
Secretary.

THE LAS VEGAS SCIENCE CLUB.

THE third meeting of the Science Club was held February 12th. Mrs. Cora W. Hewett exhibited shells of *Pyramidula strigosa* varieties *depressa*, *Cooperi* and *major*, which she had collected between Mora and Peñasco, N. M. It was remarked that, though occurring together, the *depressa* and *Cooperi* forms did not appear to intergrade. Miss Mary Cooper exhibited numerous species of New Mexico Mollusca, including *Ashmunella thomsoniana portereæ* from Mauzanares Valley, a new locality. Mr. T. D. A. Cockerell exhibited and discussed a number of shells from a pleistocene deposit at the Arroyo Pecos, Las Vegas. The shells appeared to be all of living species, but he had found in the deposit part of the jaw and a tooth of a species of *Microtus* which, judging from the enamel pattern, was clearly distinct from any species now recognized as living in America. Mr. Cockerell also exhibited specimens of a wax-scale, *Ceroplastes sinensis*, Del Guercio, received from the Agricultural School at Portici, Italy, with the information that it was infesting lemon trees at Chiavari, Italy. It was supposed that the insect reached Italy from China, but it was very close indeed to *C. mexicanus*, Ckll., a species not uncommon in Mexico.

T. D. A. C.

OTTAWA FIELD NATURALISTS' CLUB.

AT the last meeting of the Club held at Ottawa, January 29th, the following papers of special interest to geologists were presented: *Observations on the Crows' Nest Pass*. By MR. JAMES MCEVRY, of the Geological Survey of Canada.

Mr. McEvry spoke of the geological structure and economic resources of the Pass and illustrated his paper by means of lantern slides prepared by Mr. J. Keele.

*Explorations in Baffin Land*. By DR. ROBERT BELL.

This paper gave a graphic résumé of the researches carried on by Dr. Bell and his party along the North Shore of Hudson Straits and in the interior of Baffin Land. Numerous lantern slides illustrating the geological struc-

ture and orographic features of the regions traversed accompanied Dr. Bell's paper.

The 'Report of the Geological Section, for 1900-1901,' was then presented by Mr. H. M. Ami, in which were pointed out the nine important discoveries in the Chazy, Trenton, Utica and Lorraine formations in the Paleozoic about Ottawa as well as those in the Pleistocene and marine clays, sands and gravels, etc., of the same district.

H. M. AMI.

#### SHORTER ARTICLES.

##### ARSENIC TESTS.

THE note concerning arsenic tests on page 313 of the current volume of SCIENCE brings to my mind some experiments made while testing for arsenic in glycerol, an account of which is found in the *Journal American Chemical Society* for Nov., 1895. I found the destruction of the organic matter (before applying the Marsh test) by a mixture of sulphuric acid and nitric acid (30 to 1) caused a loss of arsenic in some samples but not in others. In one sample treated with this mixture it was found impossible to detect even added arsenic. My conclusion at the time was "that some at least of the samples contain, or are decomposed into, something capable of holding back arsenic. This leads to the query: What is the effect of the combined glycerol present in the toxicological examination for arsenic? May not the trouble with the glycerol be due to a decomposition product which could also be formed in the supposed case?" I have never had time to investigate this point myself, and as far as I know it has never been discussed in print. May not the trouble with the Marsh test as applied to beer be due to the same cause? I was able to detect arsenic in the above-mentioned case by adding the sample diluted with water directly to the reduction flask.

A very simple, convenient and delicate method for detecting arsenic in glycerol is mentioned by several writers. I am not certain who first applied it, but think it was Ritsert. The glycerol is diluted with an equal volume of water, HCl and zinc added, and a yellow coloration obtained, if arsenic is present by exposing filter paper, moistened with either silver

nitrate solution (1 to 1) or saturated mercuric chloride solution to the evolved gas. A twenty-five cc. measuring glass is convenient for carrying out the test, the filter paper moistened with the solution being placed over the mouth. This test carried out with mercuric chloride is not as delicate as the Marsh test, but when silver nitrate is employed it is about five times as delicate. E. Ritsert (*Pharm. Ztg.*, 1888, 715 and 1889, 104, 360 and 625) finds this test to show 0.001 mg. of arsenic in 1 cc. of solution where the Marsh test only shows 0.01 mg. in 1 cc.

G. E. BARTON.

MILLVILLE, NEW JERSEY,  
Feb. 25, 1901.

#### PRELIMINARY NOTE ON THE EMBRYOGENY OF NELUMBO.

For two years the writer has had *Nelumbo lutea* under observation and has demonstrated among other points those enumerated below. The discoveries, and the conclusions arising from them, are of such importance that publication in advance of the complete memoir seems advisable. They are as follows:

1. The membrane surrounding the plumule has been shown to be, as conjectured by Wigand, a true endosperm arising within the embryo sac.

2. The embryo is genuinely monocotyledonous in development and the conclusions of Mirbel are erroneous. The plumule arises laterally and at first there is but one cotyledon. Later this bifurcates to form the two fleshy bodies which since Mirbel's researches have been generally regarded as separate cotyledons. For the views of Barthélemy, Richard, Clos and others who have altogether denied the cotyledonary nature of the fleshy bodies, there is no foundation in fact.

3. There is no primary root. The first roots are adventitious and spring from the epicotyl.

*Nelumbo*, both in its anatomy and embryogeny, conforms to the type of the *Monocotyledons* and, probably with the other *Nymphaeaceae*, should be classified in the general vicinity of the *Alismaceae*.

HAROLD L. LYON.

THE UNIVERSITY OF MINNESOTA,  
March 14, 1901.

## CURRENT NOTES ON PHYSIOGRAPHY.

## PHYSIOGRAPHY OF NEW BRUNSWICK.

GÄNONG continues his 'Notes on the Natural History and Physiography of New Brunswick' (*Bull. Hist. Soc. New Brunswick*, xix, 1901, 313-340), presenting accounts of the development of several rivers and lakes. The Nepisiguit, for example, is explained as the result of successive captures of portions of three other systems by what is now the lower part of this river. The Negoot lakes, of picturesque outline in a district of primeval forest, are described as resulting from the obstruction of a series of nearly parallel valleys by masses of glacial drift. In the discussion of these problems it is implied that the shores of the Silurian sea are indicated by the present margin of the Silurian strata, that certain existing river courses were determined in pre-Silurian times and that even the valleys of certain rivers and lakes are pre-Silurian; but it is difficult to accept these conclusions on the evidence that is presented. A slight misapprehension as to the meaning of 'monadnock' is indicated in the statement that a hill which rises over the eastern penepine of Carboniferous strata east of Grand lake is 'not a real monadnock,' for 'it is composed of a ridge of volcanic rocks, and hence remains, not because it is left behind in the general erosion, but because it resists erosion better than the surrounding rock.' It is for such resistant residual mountains and hills that the term monadnock is coming to be generally used.

## DRAINAGE CHANGES IN NORWAY.

'The Sundal Drainage System in central Norway,' by R. L. Barrett (*Bull. Amer. Geogr. Soc.*, xxxii, 1900, 199-219), is an account of a curious series of changes in drainage lines, whereby the upper valleys of the Opdal system that once discharged northeastward into Trondhjem fiord are now discharged northwestward to Sundal fiord. The Opdal system consisted of numerous broadly open valleys with convergent courses and continuously sloping floors. The Sundal, a canyon-like valley, trenches the highlands in which the upper Opdal branches are

opened, and receives the waters of several narrow gorges that are eroded in the mature Opdal floors. As a result the lateral stream courses to-day no longer converge towards their trunk, but enter it in a backhanded or barbed fashion;



Sundal system, solid black. Opdal system, outline.

and while the heads of the Opdal system were well enclosed by the highlands, the head of the Sundal system is separated from the head of what remains of the Opdal system only by a flat divide on the mature valley floor. As the gorges and canyons of the Sundal system deepen dowstream through the rising valley floors of the dismembered Opdal system, the main Sundal canyon comes to be 1,000 meters deeper than the highest head valleys that it dissects. In explanation of these curious changes, Barrett concludes that normal headward erosion by the Sundal system is of uncertain and probably small value; westward overflow from ice-dammed lakes that occupied the upper Opdal valleys while the trunk was filled by advancing or retreating glaciers is given more importance; and a still greater share of work is attributed to glacial overflows, when great ice-sheets overwhelmed the region and disregarded the divides that had controlled preglacial river drainage. It is pointed out that the Romsdal, next southwest of the Sundal, exhibits a similar barbed relation between its branch and trunk streams, thus suggesting an interesting field of study for a summer month in Norway.

## THE ASSAM EARTHQUAKE OF 1897.

A THOROUGH 'Report on the Great [Assam] Earthquake of 12th of June, 1897,' has been made by R. D. Oldham (*Mem. Geol. Surv., India*, XXIX., 1899. Pp. xxx + 379 + xviii., 41 pl., 3 maps). This earthquake is said not to have

been surpassed for violence and extent by any of which there is historic record. An area of 150,000 square miles was laid in ruins, all means of communication interrupted, the hills rent and cast down in landslips, and the plains fissured and riddled with vents from which sand and water poured out in most astounding quantities, causing floods in rivers, while a surrounding area of 1,750,000 square miles felt an unusual shock. The earthquake wave is estimated to have traveled at the rate of 120 miles a minute. The amplitude of wave motion near the epicenter was probably 14 inches, and the velocity of wave motion was probably 14 feet a second. It is suggested that the shock may have been caused by a slight movement on a thrust plane, thus accounting for the compression indicated by kinks in railways, and by a slight diminution of north-south distances indicated by a revision of former triangulation. Two hill stations seem to have been lifted by about 20 feet over their former altitude. A number of surface faults are described and figured, one of which had a throw of 25 feet and a length of 12 miles, and another a throw of 10 feet and a length of two and one-half miles. The greater fault produced a waterfall in the Chedrang, and obstructed the Krishnai so as to form a lake several miles in extent, flooding a village and killing a forest of not less than 50,000 *sal* trees. At a certain point in the Himalayan foothills, the steep slopes have been stripped bare by landslides from crest to base, the valley bottoms being piled up with débris and broken trees, producing a scene of indescribable desolation. At this point the landslides usually left a sharp and bare ridge-line, but the crest of one ridge retained a narrow strip of its old forest, although the trees were all broken down by the violent oscillations that they suffered. Many streams, that once consisted of a succession of deep pools and rocky rapids, have been so charged with sand from landslides that their valleys are aggraded and they now flow in broad, shallow, sandy channels. A narrative account of the earthquake has been published by H. Luttmann-Johnson (*Jour. Soc. Arts.* xli, 1898, 473-493).

W. M. DAVIS.

#### BOTANICAL NOTES.

##### TREES OF THE NORTHERN PLAINS.

A RECENT preliminary list of the seed-bearing plants of North Dakota, by Professor Bolley and L. R. Waldron, throws some light on the woody vegetation of the northern portion of the Great Plains. An examination of this interesting list confirms the supposition hitherto entertained that the species of trees are fewer in number as we go north from the central region, there being but twenty-eight, or possibly twenty-nine, different species in the region covered by it. A closer study of the list shows that of these twenty-nine species of trees less than twenty attain to such dimensions as to make them important timber trees, viz.: basswood, sugar maple (a doubtful native species), red maple (more probably silver maple), box elder, red ash, green ash, white elm, red elm, hackberry, western red birch, ironwood, bur oak, black willow, almond willow, American aspen, large-toothed aspen, balsam poplar, cottonwood and red cedar. The other trees are wild red plum, Canada plum, wild red cherry, choke cherry, buffalo berry, two hawthorns, speckled alder, low bur oak and sandbar willow. Of the timber trees, constituting the first list, box elder, red ash, green ash, white elm, hackberry, cottonwood and probably black willow and almond willow occur throughout the State; basswood, both maples, red elm, ironwood, both aspens and balsam poplar are found only in the eastern counties; bur oak in the eastern half of the State; western red birch in the Turtle Mountains (along the Canadian border), and red cedar in the foothills of the southwestern portion of the State. The absence of locusts, sycamores, hickories, walnuts, white oaks, red oaks and pines is a notable feature of the arboreal vegetation of this portion of the plains.

##### SHRUBS OF THE NORTHERN PLAINS.

THE preliminary list referred to above shows that there are in North Dakota forty-four species of shrubs, a small number when compared with areas of approximately equal extent elsewhere in the United States or Canada. Thus in Nebraska, which is but very little greater in area, there are eighty-six species of shrubby plants.



In examining the list of North Dakota shrubs one is struck by the fact that but live are distinctly western, viz.: skunk bush (*Rhus trilobata*), Western sand cherry (*Prunus besseyi*), Western wild cherry (*Prunus demissa*), Western Juneberry (*Amelanchier alnifolia*), and the silver berry (*Elaeagnus argentea*). These western species may be supposed to have moved from the western mountains out upon the plains, or to have originated here. All the other shrubs are more or less common eastern species which may be assumed to have pushed out from the body of eastern vegetation as has been observed elsewhere on the plains. Among these familiar eastern shrubs are prickly ash, bittersweet, wild grape (*Vitis vulpina* L.), Virginia creeper, smooth sumach, sweet sumach, poison ivy, red raspberry, wild roses (four species), wild gooseberries (four species), cornels (three species), wild honeysuckles (three species), hazels (two species), willows (three species), and junipers (two species). The meadow sweet (*Spiraea salicifolia*), and choke berry, common shrubs of the Eastern States, appear to have entered these northern plains from Minnesota, the Canada buffalo berry from the northeast, and the shrubby cinquefoil from the Rocky Mountains:

NEW EDITION OF THE PHYTOGEOGRAPHY OF  
NEBRASKA.

The greater portion of the first edition of the 'Phytogeography of Nebraska,' by Pond and Clements, having been destroyed in the fire which occurred in the publisher's establishment, the Regents of the University of Nebraska authorized a new edition, which has now appeared as a volume of the publications of the Botanical Survey. As the edition is small the distribution of copies is necessarily limited. One hundred copies only have been placed on sale, and when these are sold the edition will be exhausted. The disbursing agent is the University Publishing Company, Lincoln, Nebr. A review of this new edition will appear in a future number of SCIENCE.

BOTANY AND AGRICULTURE.

The 'Proceedings of the Twenty-first Annual Meeting of the Society for the Promotion of Agricultural Science,' just at hand, is a neatly-printed pamphlet of nearly two hundred pages.

An examination of its contents shows that botany as one of several sciences (chemistry, zoology, entomology, meteorology, physics), having relation to agriculture, occupied an unusually large place in the discussions in the New York meeting last June. There were twenty-four papers presented, and exactly one half of these were botanical. Four of the papers had a distinctly horticultural bearing, two were in the domain of plant pathology, two dealt with the chemical aspects of certain plant problems, one discussed weeds, one was in the field of agricultural engineering, and two were devoted to botanical pedagogics. These papers all appear to be more than ordinarily valuable, but those which interest us most are Dr. Trelease's discussion of 'The Botanic Garden as an Aid to Agriculture,' and Mr. Galloway's 'Twenty Years' Progress in Plant Pathology.' It is not within our province to make note of the non-botanical papers, among which are a number of promising titles. The volume is well worth the perusal of every scientific man who is interested in the applications of science to the problems in agriculture.

FIELD ECOLOGY IN THE ROCKY MOUNTAINS.

THE Department of Botany, of the University of Nebraska, offers a course in Field Ecology, to be given in the Rocky Mountains about Pike's Peak during the coming summer. The headquarters of the party will be at Minnehaha, at an altitude of 8,300 feet, from which the plains, foothill, sub-alpine and alpine regions are easily accessible. The work will be under the charge of Dr. Frederic E. Clements, and will begin the first of July and close the first of September. It will consist of a study of the floristics of the various regions, as an introduction to the investigation of the plant formations with respect to their structure and distribution. The special object of the course, however, will be to interpret individual and vegetational adaptations in the light of a thorough examination of the physical factors present, and to determine by experiment in the field the efficient factors in alpine vegetation. A microscopical laboratory with the usual accessories will be fitted up at Spruce Ridge Cottage. There are no fees in connection with the course,

except a registration fee of two dollars for those desiring university credit. The probable expense for the two months, excluding railway fare, will be about fifty dollars.

CHARLES E. BESSEY.

THE UNIVERSITY OF NEBRASKA.

#### THE NATIONAL BUREAU OF STANDARDS.

THE bill establishing a National Bureau of Standards which, as we have already noted, was passed by Congress at the end of the session is as follows :

*Be it enacted, etc.,* That the Office of Standard Weights and Measures shall hereafter be known as the National Bureau of Standards.

SECTION 2. That the functions of the bureau shall consist in the custody of the standards; the comparison of the standards used in scientific investigations, engineering, manufacturing, commerce, and educational institutions with the standards adopted or recognized by the government; the construction, when necessary, of standards, their multiples and subdivisions; the testing and calibration of standard-measuring apparatus; the solution of problems which arise in connection with standards; the determination of physical constants and the properties of materials, when such data are of great importance to scientific or manufacturing interests and are not to be obtained of sufficient accuracy elsewhere.

SEC. 3. That the bureau shall exercise its functions for the Government of the United States; for any State or municipal government within the United States; or for any scientific society, educational institution, firm, corporation, or individual within the United States engaged in manufacturing or other pursuits requiring the use of standards or standard measuring instruments. All requests for the services of the bureau shall be made in accordance with the rules and regulations herein established.

SEC. 4. That the officers and employees of the bureau shall consist of a director, at an annual salary of \$5,000; 1 physicist, at an annual salary of \$3,500; 1 chemist, at an annual salary of \$3,500; 2 assistant physicists or chemists, each at an annual salary of \$3,200; 1 laboratory assistant, at an annual salary of \$1,400; 1 laboratory assistant, at an annual salary of \$1,200; 1 secretary, at an annual salary of \$2,000; 1 clerk, at an annual salary of \$1,200; 1 messenger, at an annual salary of \$720; 1 engineer, at an annual salary of \$1,500; 1 mechanic, at an annual salary of \$1,400; 1 watchman, at an annual salary of \$720; and 1 laborer, at an annual salary of \$600.

SEC. 5. That the director shall be appointed by the

President, by and with the advice and consent of the Senate. He shall have the general supervision of the bureau, its equipment, and the exercise of its functions. He shall make an annual report to the Secretary of the Treasury, including an abstract of the work done during the year and a financial statement. He may issue, when necessary, bulletins for public distribution, containing such information as may be of value to the public or facilitate the bureau in the exercise of its functions.

SEC. 6. That the officers and employees provided for by this Act, except the director, shall be appointed by the Secretary of the Treasury, at such time as the respective services may become necessary.

SEC. 7. That the following sums of money are hereby appropriated: For the payment of salaries provided for by this act, the sum of \$27,140, or so much thereof as may be necessary; toward the erection of a suitable laboratory, of fireproof construction, for the use and occupation of said bureau, including all permanent fixtures, such as plumbing, piping, wiring, heating, lighting and ventilation, the entire cost of which shall not exceed the sum of \$250,000, \$100,000; for equipment of said laboratory, the sum of \$10,000; for a site for said laboratory, to be approved by the visiting committee hereinafter provided for and purchased by the Secretary of the Treasury, the sum of \$25,000, or so much thereof as may be necessary; for the payment of the general expenses of said bureau, including books and periodicals, furniture, office expenses, stationery and printing, heating and lighting, expenses of the visiting committee, and contingencies of all kinds, the sum of \$5,000, or so much thereof as may be necessary, to be expended under the supervision of the Secretary of the Treasury.

SEC. 8. That for all comparisons, calibrations, tests, or investigations, except those performed for the Government of the United States or State governments within the United States, a reasonable fee shall be charged, according to a schedule submitted by the director and approved by the Secretary of the Treasury.

SEC. 9. That the Secretary of the Treasury shall, from time to time, make regulations regarding the payment of fees, the limits of tolerance to be attained in standards submitted for verification, the sealing of standards, the disbursement and receipt of moneys, and such other matters as he may deem necessary for carrying this act into effect.

SEC. 10. That there shall be a visiting committee of five members, to be appointed by the Secretary of the Treasury, to consist of men prominent in the various interests involved, and not in the employ of the Government. This committee shall visit the bureau at least once a year, and report to the Secre-

tary of the Treasury upon the efficiency of its scientific work and the condition of its equipment. The members of this committee shall serve without compensation, but shall be paid the actual expenses incurred in attending its meetings. The period of service of the members of the original committee shall be so arranged that one member shall retire each year, and the appointments thereafter to be for a period of five years. Appointments made to fill vacancies occurring other than in the regular manner are to be made for the remainder of the period in which the vacancy exists.

#### SCIENTIFIC NOTES AND NEWS.

MR. J. J. H. TEALL, F.R.S., has been appointed director general of the Geological Survey of Great Britain and Ireland, in succession to Sir Archibald Geikie, who retired on February 28th. Sir Archibald has been in the service of the Survey for forty-six years and has reached the age limit.

At a meeting of the Canadian Mining Institute held at Montreal on March 6th, it was unanimously decided to recommend the appointment of Professor Frauk D. Adams, as director of the Geological Survey of Canada in succession to the late Dr. Geo. M. Dawson.

A COMMITTEE has been formed to erect at Heidelberg a monument in memory of three of its great scientific men, Bunsen, Kirchhoff and von Helmholtz.

PROFESSOR J. J. THOMSON, Cavendish professor of physics at Cambridge University, has been elected a member of the Athenæum Club under the provision which empowers the annual election of nine persons of distinguished eminence.

DR. M. I. PUPIN, professor of electro-mechanics, at Columbia University, and Dr. R. Mark Wenley, professor of philosophy at the University of Michigan, will represent their universities at the Ninth Jubilee of the University of Glasgow, which takes place in June.

MR. PERCY WILSON, of the New York Botanical Garden, is accompanying Professor Todd's expedition to the Dutch East Indies to observe the total solar eclipse. He will make collections for the Garden.

MR. JARED G. SMITH, of the U. S. Department of Agriculture, left Washington on March

15th for Honolulu, to assume the directorship of the Agricultural Experiment Station.

THE Division of Forestry of the U. S. Department of Agriculture has selected from its working force two trained lumbermen with some knowledge of forestry to be sent to the Philippine Islands in compliance with a cable request of the Taft Philippine Commission. The persons selected for this work are Mr. Grant Bruce, formerly a State forester in New York, and Mr. Edward Hamilton. Both these men are expert lumbermen with some training in forestry, and have been selected in view of their special fitness for the Philippine work. A bureau of forestry was established in the Philippines in April, 1900, with Capt. George P. Ahern, Ninth United States Infantry, in charge.

At a meeting of the American Academy of Arts and Sciences on March 13th, the following fellows were elected:

#### *Resident Fellows:*

- ALEXANDER WILMER DUFF, of Worcester, Physics.
- THEODORE LYMAN, of Brookline, Physics.
- LEWIS JEROME JOHNSON, of Cambridge, Technology and Engineering.
- HENRY LLOYD SMYTH, of Cambridge, Technology and Engineering.
- FRANK SHIPLEY COLLINS, of Malden, Botany.
- EPHRAIM EMERTON, of Cambridge, Political Economy and History.
- FRANK WILLIAM TAUSSIG, of Cambridge, Political Economy and History.

#### *Associate Fellows:*

- ELIAKIM HASTINGS MOORE, of Chicago, Mathematics and Astronomy.
- GEORGE ELLERY HALE, of Williams Bay, Physics.
- EDWARD LEAMINGTON NICHOLS, of Ithaca, physics, in place of the late William Augustus Rogers.
- CYRUS GUERNSEY PRINGLE, of Charlotte, Vermont, Botany, in place of the late George Clinton Swallow.
- FRANKLIN PAINE MALL, of Baltimore, Zoology and Physiology, in place of the late Alfred Stillé.
- HENRY FAIRFIELD OSBORN, of New York, Zoology and Physiology, in the place of the late Othniel Charles Marsh.
- CHARLES OTIS WHITMAN, of Chicago, Zoology and Physics.
- WILLIAM STEWART HALSTED, of Baltimore, Medicine and Surgery, in place of the late William Alexander Hammond.

WILLIAM WILLIAMS KEEN, of Philadelphia, Medicine and Surgery, in the place of the late Jacob Mandes Da Costa.

*Foreign Honorary Members :*

JULES HENRI POINCARÉ, of Paris, Mathematics and Astronomy, in the place of the late Francesco Brioschi.

HENRICH MÜLLER-BRESLAU, of Berlin, Technology and Engineering.

HUGO KRONECKER, of Bern, Zoology and Physiology, in place of the late Willy Kühne.

ROBERT KOCH, of Berlin, Medicine and Surgery, in place of the late Louis Pasteur.

SIR THOMAS LAUDER BRUNTON, of London, Medicine and Surgery, in place of the late Sir James Paget, Bart.

ALBERT VENN DICEY, of Oxford, Philosophy and Jurisprudence.

WILLIAM EDWARD HEARN, of Melbourne, Philosophy and Jurisprudence, in place of the late Charles Russell, Baron Russell of Killowen.

HENRY JACKSON, of Cambridge, Philosophy and Archaeology, in place of the late Henry Sidgwick.

EDMONDO DE AMICIS, of Florence, Literature and the Fine Arts, in place of the late John Ruskin.

PROFESSOR SIMON NEWCOMB gave the fourth address of the series on the Progress and Tendency of Science during the Nineteenth Century before the Washington Academy of Sciences on March 19th, his subject being 'The Progress and Tendency of Astronomy.'

PROFESSOR JACQUES LOEB, of the University of Chicago, read a paper on 'Artificial Parthenogenesis' before the American Philosophical Society at Philadelphia on March 15th.

DR. SIMON FLEXNER, of the University of Pennsylvania, who went to San Francisco to investigate, on behalf of the U. S. Government, the alleged existence of the bubonic plague in that city, lectured before the Academy of Sciences on 'Defense against Disease.'

GEORGE FRANCIS FITZGERALD, since 1881 Erasmus Smith professor of natural and experimental philosophy at Dublin, died on February 21st, at the age of forty-nine years. The Faculty of Science of the newly-constituted University of London has passed the following resolution in his memory :

That this meeting of the Faculty of Science of the University of London, having heard with profound sorrow of the premature death of the late Professor

George Francis Fitzgerald, desires to place on record its high appreciation of his brilliant qualities as a man, as a teacher, as an investigator, and as a leader of scientific thought, and to express to his family its mournful sympathy under the calamity which has befallen science and his many friends.

PROFESSOR CHARLES McDONALD, for more than thirty years professor of mathematics in Dalhousie College, died in Halifax, N. S., on March 10th.

THE death is announced of Mr. R. G. Halliburton, of Canada, known for his political and scientific writings. He was sixty-nine years of age.

MR. ANDREW CARNEGIE, as all our readers are doubtless aware, has offered to give \$5,200,000 to New York City for the construction of buildings for sixty-five branch libraries. The city must provide land and maintenance. The offer has been made in conference with Dr. John S. Billings, director of the New York Public Library, and it is understood that the branch libraries would be administered in connection with the public library. The acceptance of Mr. Carnegie's offer would probably require special legislation, but the city officers have expressed themselves strongly in favor of the plan. Mr. Carnegie has also offered to give \$1,000,000 for a library at St. Louis. Mr. Carnegie's gifts and offers awaiting acceptance amount to over \$20,000,000, largely for library buildings.

THE American Museum of Natural History has recently received a gift of \$1,500 from Mr. John L. Cadwalader, of New York, for the purpose of mounting groups of birds illustrating seasonal changes of plumage and other adaptive features of bird life. The fund is to be expended under the direction of Mr. Frank M. Chapman, associate curator.

MR. HUGH LEONARD has given £100 and Sir William J. Farrer £50 to the Royal Institution of London for experimental research at low temperatures.

MR. FORDHAM MORRIS, of New York City, has presented to the American Museum of Natural History a painting representing Audubon with his gun, dog and horses made by his sons, John and Victor, in the late forties a few years before his death. The painting is

now on exhibition in the library reading-room.

THE University College of South Wales and Monmouthshire has received £800 towards the £1,000 required for the Museum of Anatomy proposed as a memorial to Professor A. W. Hughes.

AT a recent meeting of the Canadian Mining Institute a committee was appointed to urge upon the Government an increase of the salaries of those engaged in the Geological Survey, and the need of providing a suitable building at Ottawa for the geological collections.

THE Peary Arctic Club has reelected President Morris K. Jesup, Treasurer Henry W. Cannon and Secretary Herbert L. Bridgman. It likely that a steamer, the fifth, will be chartered and dispatched to find the *Windward*, from which, since the departure from Godhaven, North Greenland, August 20, 1900, with Mrs. Peary and Miss Peary, nothing has been heard.

LIEUTENANT R. F. SCOTT, R.N., the leader of the British Antarctic Expedition, has made to a representative of Reuter's Agency a statement in the course of which he says that the preparations for the British Antarctic Expedition are now practically complete. The *Discovery*, the expedition's ship, will be launched on the 23rd inst., and, after she has been handed over by the contractors, will come round to London, where her equipment and provisions will be put aboard. The *Discovery* has been built on whaler lines, only with greatly increased strength to withstand ice pressure. She is 171 ft. long and 34½ ft. beam, and has 1,500 tons displacement. She will have auxiliary steam, and is fitted with engines of the latest type. In her construction the lines of the *Fram*, though carefully studied, have not been adopted, as Nansen's ship would have been ill-adapted for the heavy seas the *Discovery* will have to encounter. The expedition will leave London in July or August, and will proceed to Melbourne, reaching there in November. The actual work of the expedition will then begin. The naval staff, in addition to Lieutenant Scott, consists of Lieutenant A. R. Armitage (second in command),

Lieutenant Charles Royds, and two other officers yet to be appointed. The civilian staff will consist of Professor Gregory, of Melbourne University (director of the civilian scientific staff), Mr. Hodgson (biologist), and Mr. Shackleton (physicist). The medical staff will consist of Dr. Koettlitz and Mr. Wilson.

THE department committee appointed by the British Board of Agriculture to inquire into the conditions under which agricultural seeds are at present sold has completed its report. The committee has come to the conclusion that the seed trade in England is on the whole well conducted and has of late years improved with the advance of science. Nevertheless the majority of the committee recommends that one central station should be provided in the United Kingdom for the purpose of testing the purity and germinating power of seeds sent to it for official examination.

THE British Museum (Natural History) has purchased for £350, an elephant's tusk, which is said to be the largest ever known. The following are its weight and dimensions: Weight, 226½ lbs. Length—outside curve, 10 ft. 2½ in.; inside curve, 9 ft.; base to point in straight line, 8 ft. 2 in. Circumference—at hollow end, 24 in.; at solid 24½ in. Diameter—at hollow end, 8½ in.; at solid, 7½ in.

THE following bill was recommended for passage by the committee on coinage, weights and measures, Mr. Southern, chairman, in the closing days of the last Congress.

*A Bill, To adopt the weights and measures of the metric system as the standard weights and measures in the United States.*

Be it enacted by the Senate and House of Representatives of the United States of America in Congress Assembled: That on and after the first day of January, nineteen hundred and three, all the Departments of the Government of the United States, in the transaction of all business requiring the use of weight and measurement, except in completing the survey of public lands, shall employ and use only the weights and measures of the metric system; and on and after the first day of January, nineteen hundred and three, the weights and measures of the metric system shall be the legal standard weights and measures of and in the United States.

GOVERNOR ODELL, of New York, has signed

the bill abolishing the Forest, Fish and Game Commission and the Forestry Preserve Board as now constituted—consolidating their departments and placing them under the charge of a State Forest, Fish and Game Commissioner.

THE following bill regulating the practice of medicine has been favorably reported in the New York Assembly by the Committee on Public Health :

Any person shall be regarded as practicing medicine who shall for remuneration, charge, fee, gift, bonus or reward, directly or indirectly profess to heal, or who shall give treatment to any other person by the use of any means or method whatever, whether with or without the use of any medicine, drug, instrument, or other appliance, for the relief or cure of any wound, fracture, or bodily injury, infirmity, physical or mental, or other defects or diseases.

This article is not to apply to any person giving treatment to another under the direction or upon the prescription of a physician, duly licensed by the laws of this State. Neither is it to prohibit the manufacture, sale, or use of patent medicines where no diagnosis is made by the maker or seller; or of the giving temporary relief in an emergency by a registered pharmacist or any person, or the domestic administration of family remedies; or any person in charge of or employed in any gymnasium from giving suggestions or advice as to form or methods of exercise, or any optician engaged in adapting glasses to the sight, or any rights of chiropractors under existing laws, or the manufacture or construction of optical instruments.

THE subjects of the Walker prizes in Natural History awarded by the Boston Society of Natural History are as follows: For 1901: 'Monograph on any problem connected with, or any group belonging to, the North American fauna or flora'; for 1902: (1) 'Nuclear fusions in plants'; (2) 'The fate of specific areas of the germ of chordates, as determined by local destruction'; (3) 'The reactions of organisms to solutions, considered from the standpoint of the chemical theory of dissociation.' Further particulars may be obtained from Mr. C. L. Batchelder, secretary of the Society.

PROFESSOR WILLIAM TRELEASE, director of the Missouri Botanical Garden, has sent out an announcement calling attention to the opportunities offered by the Garden for original research. It calls attention to the fact that in

establishing and endowing the Garden, its founder, Henry Shaw, desired not only to afford the general public pleasure and information concerning decorative plants and their best use, and to provide for beginners the means of obtaining good training in botany and horticulture, but also to provide facilities for advanced research in botany and cognate sciences. Persons who wish to make use of these are invited to correspond with the director, outlining with as much detail as possible the work they desire to do at the Garden, and giving timely notice so that provision may be made for the study of special subjects.

DR. B. E. FERNOW, director of the New York State College of Forestry, announces that the spring courses for the junior and senior year students in the College Forest, at Axton, will begin on April 16th and continue until June 13th. In addition to the practical forestry work in silviculture, forest mensuration, surveying, exploitation and forest regulation under the direction of Professors Roth and Gifford, the practical instruction in timber estimating, given last year by Mr. Cyrus P. Whitney, will be repeated. A course of daily lectures on Fish Culture and Game Preservation, beginning April 29th, and lasting two weeks, with laboratory work and field excursions, will be given by Professor Barton W. Evermann, ichthyologist of the U. S. Fish Commission. This course will be open to visitors, as far as accommodations may be found by them in Axton or in the neighborhood.

WE have received the announcement of the twelfth season of the Biological Laboratory of the Brooklyn Institute of Arts and Sciences at Coldspring Harbor, L. I. The laboratory will be open for regular work from July 1st to August 24th, but investigators may make arrangements for a longer residence. A complete series of courses is offered by the Board of Instruction which is as follows:

Professor C. E. Davenport, Ph.D., The University of Chicago, Director of the Laboratory; D. S. Johnson, Ph.D., Johns Hopkins University, in charge of Cryptogamic Botany; Professor Henry S. Pratt, Ph. D., Haverford College, in charge of Comparative Anatomy; Professor Nelson F. Davis, Sc.M., Bucknell University, in charge of Bacteriology; Mrs. Ger-

trade C. Davenport, S.B., Past Instructor Kansas University, in charge of Microscopic Methods; Henry A. Kelly, Ph.D., Ethical Culture Schools, New York, in charge of Nature Study; Lawrence E. Griffin, Ph.D., Western Reserve University, in charge of Embryology; H. N. Whitford, S.B., The University of Chicago, in charge of Phanerogamic Botany; A. G. Mayer, Ph.D., Brooklyn Institute of Arts and Sciences, Lecturer in Entomology; Professor Stephen R. Williams, Ph.D., Miami University, Instructor in Zoology; Professor W. L. Tower, Antioch College, assisting in Microscopic Methods and in Entomology; Louise B. Dunn, Barnard College, assisting in Ecology; A. F. Blakeslee, A.M., Harvard University, assisting in Botany.

THE Summer Laboratory of Biology of Tufts College was established at South Harpswell, Maine, in 1898, and will hold a second session this year. The announcement states that the regular courses of instruction begin on July 8th and continue for six weeks. The laboratory will be established in a small wooden building directly on the shore and will have accommodations for fifteen or twenty students. South Harpswell is situated on the shores of Casco Bay, sixteen miles from Portland. The bay has a rich fauna and flora and is well adapted for a marine laboratory. South Harpswell itself is well situated, as from it one can readily reach the numerous islands of the bay as well as the outer fishing grounds rich in invertebrates. The laboratory is near the extremity of a narrow peninsula (ten miles in length) and being thus almost entirely surrounded by water is free from mosquitoes while hot weather is unknown. Courses will be given by Professor Kingsley and Dr. Lambert on invertebrate zoology, vertebrate zoology, botany and embryology, and facilities are offered to a certain number of students who are able to carry on their researches without assistance.

APROPÓS of the movement for an archeological survey of Michigan and legislation to that effect which is now pending, it is of interest to know that Wisconsin students are about to organize a State archeological association, the objects of which are to encourage to a greater extent than is now possible the study and preservation of Wisconsin antiquities and to establish a closer working relationship between collectors and students in different parts of the State.

THE *London Times* states that a further collection of some 400 photographs of objects and customs of antiquarian and historical interest within the British Islands has been made by the National Photographic Record Association and is now at the offices of the Royal Photographic Society, before being deposited in the British Museum. Sir Benjamin Stone's contribution to the present collection is devoted to the county of Warwick. There are two interiors of Trinity Church, Stafford-on-Avon, one showing the chancel with its carved oak screen and fine perpendicular windows, and the other a more general view, taken from the extreme west end, in order to give prominence to the unusually placed organ—over the chancel arch. From the same church are illustrations of the fine Elizabethan monument, of the Clopton family, the mayor's pew, and the ancient sanctuary knocker, the seizing of which by a refugee was sufficient to confer upon him the privilege of sanctuary. Outside the church, too, are the shot marks of a military execution. A considerable number of recumbent effigies are taken from the churches of Meriden, Merevale, and Astley. Shakespeare's tomb at Stafford-on-Avon is shown when covered with flowers on the occasion of the festival in April last, and various views of the festival procession are also preserved; while the 'Mop' and the roasting of the ox at Stratford are also recorded. Another series illustrates the entire process of haymaking by hand, from the sharpening of the scythe to the stacking—an interesting series of an unusual type, showing a complete industry. Mr. Calcott gives some views of Bristol, St. Peter's Hospital being a particularly fine specimen of carved timber work with the projecting stories supported by animal grotesques. Miss Mary Cotton has contributed some records from the Ardmore, County Waterford, of the Round Tower and ruined cathedral there, and of the ornamental stones known as the Ogham Stones, inscribed only with horizontal lines of various lengths. Of even greater archeological value are Mr. A. R. Hogg's unique photographs from near the Boyne, of the entrance to the Dowth Mound, and the interior of the Tumulus of New Grange, showing the foundation of the stone roof.

Wales is represented by a series of the famous Celtic crosses at Llantwit Major, near Cardiff. A remarkably fine collection of Norman arches, fonts and crosses is sent from Shropshire by Mr. F. R. Armitage. The largest contribution to the collection has been made by Mr. G. Scamell, who has sent over a hundred photographs, principally taken in and around London, of houses once occupied by well known men, houses which are likely to be pulled down soon and, most important, many of the Old Bailey Courts.

#### UNIVERSITY AND EDUCATIONAL NEWS.

By recent action of the Legislature of North Carolina the annual appropriation to the State University was increased by \$12,500; \$60,000 was appropriated for the Normal and Industrial School at Greensboro, N. C.; and \$40,000 for the Agricultural and Mechanical College, located at Raleigh, N. C., for payment of debts and buildings.

HENRY STAFFORD LITTLE, of Trenton, has offered \$100,000 to Princeton University for the erection of a new dormitory, adjacent to Stafford Little Hall, of which he was the donor.

HARVARD UNIVERSITY has received \$5,000 by the will of the late Jacob Wendell for a scholarship 'to be awarded to a student of excellent standing, exclusive of financial needs.'

WORK has been commenced on the new physical laboratory to be erected by the University of Pennsylvania at a cost of \$300,000.

The Registrar has just issued the lists of candidates for degrees in Sibley College and other departments of Cornell University. The former numbers about 130; of whom over thirty are in M.E. in electrical engineering, and the remainder mainly in the regular course for M.E., including those in marine and in railway engineering. There will be about twenty candidates for the master's degree, M.M.E. The latter, like M.E., includes marine and railway as well as electrical engineers. The registration of Sibley College is now between 650 and 700, including students engaged in graduate-work and candidates for the second degree. Contracts have just been

awarded for the erection of the west central 'dome' of Sibley College, to connect the existing two wings, making a front of about 400 feet, facing the campus from the north. It is to be completed early in the next academic year. It is another step toward the completion of the plans of the founder, by his son, Mr. Hiram W. Sibley. The new building will include new space for the museums and collections and a fine auditorium. This, with accessory extensions of old structures, will add about 20,000 square feet of floor-space to the College buildings. The plans, as prepared for the founder before his death, include further additions of about 40,000 square feet, to give accommodations to a thousand students in mechanical engineering and its subdivisions.

PRESIDENT PATTON brought forward some suggestions of much importance at a meeting of the trustees of Princeton University on March 15th, and these were referred to a special committee. They include: (1) Additions to the faculty that will enable the University to offer courses in human anatomy and physiology and in common law, so that students may take in their senior year the equivalent of the first year in professional schools of medicine and law; (2) making it possible for students doing additional work to secure the bachelor's degree in three years; (3) offering additional lectures in the sophomore year.

It appears that the disturbances in the Russian universities are continuing, it being reported that 700 students have been arrested at Moscow.

AT Yale University the following instructors have been promoted to assistant professorships: E. W. Scripture in psychology; A. W. Evans in botany, and H. E. Gregory in physical geography.

AT Princeton University, Dr. W. M. Rankin has been promoted to a full professorship of invertebrate morphology, and Dr. C. F. W. McClure to a full professorship of comparative anatomy.

DR. PETER GUTHRIE TAIT, since 1860 professor of natural philosophy at Edinburgh University, has resigned his chair on account of ill health.



# SCIENCE

A WEEKLY JOURNAL DEVOTED TO THE ADVANCEMENT OF SCIENCE, PUBLISHING THE OFFICIAL NOTICES AND PROCEEDINGS OF THE AMERICAN ASSOCIATION FOR THE ADVANCEMENT OF SCIENCE.

EDITORIAL COMMITTEE: S. NEWCOMB, Mathematics; R. S. WOODWARD, Mechanics; E. C. PICKERING, Astronomy; T. C. MENDENHALL, Physics; R. H. THURSTON, Engineering; IRA REMSEN, Chemistry; JOSEPH LE CONTE, Geology; W. M. DAVIS, Physiography; HENRY F. OSBORN, Paleontology; W. K. BROOKS, C. HART MERRIAM, Zoology; S. H. SCUDDER, Entomology; C. E. BESSEY, N. L. BRITTON, Botany; C. S. MINOT, Embryology, Histology; H. P. BOWDITCH, Physiology; J. S. BILLINGS, Hygiene; WILLIAM H. WELCH, Pathology; J. MCKEEN CATTELL, Psychology; J. W. POWELL, Anthropology.

FRIDAY, MARCH 29, 1901.

THE EMBRYOLOGICAL BASIS OF  
PATHOLOGY.\*

## CONTENTS:

<i>The Embryological Basis of Pathology</i> : PROFESSOR CHARLES SEDGWICK MINOT.....	481
<i>The Determination of the Type in Composite Genera of Animals and Plants</i> : PRESIDENT DAVID STARR JORDAN .....	498
<i>Note on the Number of Particles in the Saturated Phosphorus Emanation</i> .....	501
<i>Scientific Books</i> :— <i>Report of the U. S. Commissioner of Patents</i> : PROFESSOR R. H. THURSTON. <i>Lummer's Photographic Optics</i> , <i>Herman's Geometrical Optics</i> : R. W. <i>Dr. Gray's Familiar Talks on Science</i> : PROFESSOR F. B. CROCKER. <i>Books Received</i> ... 503	
<i>Societies and Academies</i> :— <i>Biological Society of Washington</i> : F. A. LUCAS. <i>Chemical Society of Washington</i> : L. S. MUNSON. <i>Philosophical Society of Washington</i> : CHARLES K. WEAD. <i>Geological Society of Washington</i> : DR. F. L. RANSOME and DAVID WHITE. <i>Section of Geology and Mineralogy of the New York Academy of Sciences</i> : DR. THEODORE G. WHITE. <i>Minnesota Academy of Natural Sciences</i> : F. G. WARVELLE.....	506
<i>Shorter Articles</i> :— <i>Chiasmodon in the Indian Ocean</i> : DR. H. M. SMITH. <i>The San José Scale Problem as compared with the Orange Scale Problem</i> : DR. F. M. WEBSTER.....	510
<i>Current Notes on Meteorology</i> :— <i>Climate of Argentina</i> ; <i>Monthly Weather Review</i> ; <i>Notes</i> : PROFESSOR R. DEC. WARD.....	512
<i>Yellow Fever</i> .....	513
<i>The New Star in Perseus</i> : PROFESSOR GEORGE E. HALE.....	514
<i>Scientific Notes and News</i> .....	515
<i>University and Educational News</i> .....	519

EMBRYOLOGY is the basis upon which pathological science must be erected. Pathology is even more a superstructure upon embryology than is anatomy. Anatomy, in its descriptive form, may stand by itself and have usefulness. Pathology cannot be built up as a merely descriptive science. It fails of its true purpose unless it discovers the causes of diseases. Now since function is dependent on structure, the aim of the pathologist must be first to discover the causes of morbid structure. In brief, pathology at the present time deals chiefly with problems of the development of anatomical forms. Pathology and embryology might almost be united in a single comprehensive study—morphogeny. Let us then try, for this evening at least, to free ourselves from the conception of an essential difference between normal and abnormal structure, a conception which, I believe, domineers too largely over our daily thoughts. This belief of mine I hope to justify to-night.

Simple description is indispensable, it furnishes the virgin facts; but facts do not develop by parthenogenesis into science; they must be saturated with the stimulus of study, with the stimulus of knowledge of their history, their antecedents, their causation, then we may see them evolving

MSS. intended for publication and books, etc., intended or review should be sent to the responsible editor, Professor J. McKeen Cattell Garrison-on-Hudson, N. Y.

\*The Middleton Goldsmith lecture delivered before the New York Pathological Society, March 26, 1901.

themselves into new orders, which we call natural laws. As little as a description of the people of the United States with no information as to their history could satisfy a serious thinker, so little can descriptions of fully developed structures satisfy an earnest pathologist. An innate, intense mental impulse is continually driving us forward in the search for causes, and obedience to this impulse is one of the main factors in scientific progress. All this is familiar, trite even, but may serve to fix our starting thought, namely, that we are to study causes.

Our attention is to be directed to the consideration of what embryology can teach us in regard to the causation of organization, and then to the application of those teachings to pathology.

This plan will exclude from our discussion many of the aspects of embryology which appeal most strongly to pathologists. We must omit from our study at least three groups of interesting phenomena, to wit: *First*, the arrests of development; *second*, the teratological formations, monstrosities and mis-developments, which will, however, have to be included ultimately even in the precise field we are about to study; *third*, the so-called teratoma, or to use a more recent term, embryoma. I may say in passing that I find it very difficult to accept the hypothesis that these remarkable structures arise by a parthenogenetic development of ova, retained in the parent body. Professor Bonnet's hypothesis is more legitimate, but towards that also my attitude is one of sceptical agnosis. Bonnet suggests that one of the early segmentation cells (blastomeres) may become isolated and retarded in its development, remaining as an inclusion in the foetal tissues, and afterwards develop and produce a variety of tissues, as isolated blastomeres have been shown by experiments on the lower animals to be capable of doing.

Teratological formations fall, it seems to me, naturally into three fairly definite divisions: (1) those due to necrosis of the tissues, which apparently rarely if ever takes place uniformly throughout the embryo; (2) those due to gross mechanical disturbances of the development, consequent upon failure of the proper correlation of the growth of parts; monstrosities of this division are probably the most common; (3) errors in the differentiation of the tissue or pathological histogenesis. It is only phenomena of the first and second divisions of teratology which we can safely drop from view, while those of the third division—errors in differentiation—we must bear uninterruptedly in mind.

One more preliminary explanation is necessary. The range of pathological changes is not so great as to reach equality with embryological developments. In the normal embryo we deal with the evolution of complete organs together with all their accompanying varied and complex modifications of tissue. In pathology, on the contrary, we deal not with organs, but with modifications of tissues, with histogenesis. The statement will not seem too absolute if it is recalled that we have excluded arrests of development and monstrosities from our discussion.

Histogenesis is the common territory in which the pathologist and embryologist have—to borrow a legal phrase—an undivided interest. It is unfortunate that our tendency has so long been to attempt an unnatural and impossible partition of the territory, which has resulted only in a division of our forces into two camps, between which has reigned little interest and less sympathy. I venture to regard your invitation to address you to-night as a wish, which I fully share, to secure fuller cooperation between the two camps of workers, who are both striving to lay bare the laws which govern the differentiation of cells.

After these preliminary explanations it is possible to define the evening's task with precision. It is twofold. First, to present some of the more important conceptions derived from embryological study in regard to the processes of cell differentiation. Second, to suggest some of the bearings of these conceptions on the problems of pathology.

#### PART I. NORMAL DIFFERENTIATION.

Under this head I propose to discuss three fundamental ideas:

*First*, of the undifferentiated cell.

*Second*, of the progress of differentiation.

*Third*, of the changes which may succeed differentiation.

The fertilized ovum is an undifferentiated being, although it has a very complex organization, and contains besides the protoplasm a store of nutritive material, the so-called yolk or deutoplasm. As there is only one nucleus, there can be no variety of nuclei; the term undifferentiated, therefore, applies to the protoplasm, which seems to have a uniform essential structure throughout, although the masses and strands of protoplasm may exhibit characteristic peculiarities, especially in relation to the distribution of the yolk. In the adult, on the contrary, the protoplasm of the cells of different tissues offers many varieties of essential structure, which can often be readily distinguished under the microscope. It is a legitimate conclusion that the absence of visible peculiarities of the intimate structure of egg protoplasm, by which one part may be distinguished from another, corresponds to uniformity of structure throughout the egg, excepting, of course, certain special characteristic arrangements, as, for example, the centering about the centrosome, which may occur in any cell.

We have also direct experimental proof that the egg is uniform throughout, or to

use a better phrase, that the egg is isotropic. Pflüger, in 1884, proved that the side of the frog's egg, which normally develops into the ventral surface of the embryo, can be made to develop into a perfectly typical dorsal surface. The frog's egg has a small white area, which normally lies underneath, the larger darkly pigmented area of the egg alone showing from above. Out of the dark area the back with the nervous system and other parts takes its origin. If the eggs, freshly fertilized, are fastened with the white side up, then the white side produces an absolutely normal back and nervous system, normal as to form and function, though lacking the typical pigmentation. These observations were confirmed by Born, who further discovered that the segmentation nucleus always rises towards the upper side of the egg, and that the position of the nucleus determines which part of the ovum shall become the dorsal side of the embryo. Another set of experiments by Oskar Schultze demonstrated that both the unpigmented and the pigmented sides of the same egg could be made to produce dorsal structures.

Another class of experiments, which were first made by Hans Driesch, have demonstrated that the earliest cells (segmentation spheres, blastomeres or cleavage cells, as they are variously called) produced by the ovum preserve the undifferentiated qualities of the parent egg, and may develop in one way or another according to circumstances. The egg of a sea urchin divides into two cells, each of which multiplies and normally gives rise to half\* of the body of the animal. By somewhat violent shaking the two cells may be artificially separated; each cell may then develop into a complete larval sea-urchin, but of half the normal size only. Similar experiments have since been made by several investigators, who have obtained like results with

\* It would be safer to say supposedly about half.

other animals, vertebrate as well as invertebrate. Even more remarkable larvæ have been raised from blastomeres of the four cell and eight cell stages of segmentation, producing larvæ of one-fourth and one-eighth the normal size. Zoja claims to have repeated the experiment successfully on the eggs of *Olytia* and to have obtained one-sixteenth larvæ.

The facts offered suffice to illustrate the two aspects of our conception of the undifferentiated condition of living matter. The first aspect is morphological and presents to us the apparent uniformity of the visibly minute structure of protoplasm. While we readily admit that the uniformity may be only apparent in the sense that we fail to observe fine differences, yet we none the less maintain that the uniformity is real, because there is an absence of variations of structure comparable to the variations which we can observe in the cells of adult tissues. The second aspect is physiological and offers to our view the wide range of possibilities in the future developmental history and growth of the protoplasm. The fate of the protoplasm of any given part of the ovum is not fixed, but if its conditions of development are changed its fate is changed. A few years ago the mosaic hypothesis was advanced by W. Roux and has been vigorously defended by him. According to the mosaic theory, the egg is a mosaic pattern, each member of which has its predestined history. It is fortunate for our comprehension of pathological process that we are already able to say that Roux's hypothesis is erroneous.

We must start then with the right conception of the ovum, every part of the protoplasm of which is to be regarded as potentially capable of producing any or all the tissues of the adult.

We turn next to the consideration of the progress of differentiation in order to establish a second fundamental idea, namely,

that it acts as a progressive restriction of the further development. Each successive stage of differentiation puts a narrower limitation upon the possibilities of further advance. Applied to pathology, this law means that the range of possible pathological changes is determined not merely by the nature or kind, but also by the stage or degree, of the previous differentiation of the tissue.

The eggs of all animals\* pass through two well-marked phases of development.

During the earlier and much shorter phase, the nuclei are multiplying rapidly, while the cytoplasm is growing but little, if at all. This period includes the time of segmentation, as commonly described, and somewhat longer. During this period the total bulk of the nuclei in proportion to the protoplasm is fundamentally changed. The ovum arises from a cell, the ovocyte, which, as its last act, grows rapidly; this enlarged cell, by the process of maturation gives rise to the female sexual element, which has a single nucleus. After the fertilization we have an ovum with much protoplasm and deutoplasm, but again with only the single segmentation nucleus. The development of each individual begins, therefore, with a cell in which the extreme disproportion between the size of the nucleus and of the whole cell-body occurs. The first effort of development is to correct this disproportion by the enormously rapid increase of the nuclei, which continues until cells of the embryonic type are produced, that is to say, cells each with a minimal amount of protoplasm around the nucleus. With the production of cells of the embryonic type, the first phase of development is completed. The limits of this phase are very indefinite for we observe often that the production of cells of the type defined may be far advanced in one part of the germ, while it is

\*The protozoa are obviously excluded from the present discussion.

still in early progress in another. In fact the phase has no exact boundary in time.

During the second, later and much longer period or phase of development, the multiplication of nuclei lags behind the growth of the protoplasm; the increase is gradual and often shows itself through successive generations of cells, sometimes, however, in a single cell, which no longer multiplies. Of the first method of protoplasmic growth embryonic blood-cells offer a good illustration, of the second the neuroblasts or young nerve cells afford a striking example. Now cells of the embryonic type show little if any capacity for differentiation, and the increase of the protoplasm in the single cell is, so far as we can judge, a necessary preliminary step to cell differentiation. The embryonic cells have yet another characteristic of basal significance; they are capable of rapid multiplication. Hence we conclude that the growth of the cytoplasm impedes the multiplication of cells, and, therefore, ultimately retards the growth of the body, as a whole, while on the other hand it favors differentiation. Accordingly the growth of cells and their differentiation are essentially antagonistic processes, which are necessarily more or less mutually exclusive. This conclusion which I published in 1890, has since been amply confirmed by further observation. It is probably applicable alike to animals and plants, alike to normal and abnormal tissues. It is one of the many conclusions of embryology which are sure to throw a revealing light upon some of the dark problems of pathology.

During the first phase of development, as just defined, we encounter preparatory changes which we may characterize summarily as the manufacture of embryonic cells. During the second phase, though the production of embryonic cells is doubtless continued in certain regions, there supervenes the process of differentiation, the true histogenesis.

After segmentation there follows the formation of the germ layers, a gradual arrangement of the cells in three distinct primary strata—at least in all vertebrates there are always three strata, never more\* nor less. The outer and inner layers, ectoderm and entoderm, very early become distinctly epithelial. The middle layers become partly epithelial, partly of a special character, that is mesenchymal. At first one is inclined to think of the difference between epithelium and mesenchyma as a fundamental one, an early and unalterable separation of cells into classes. This view finds support in the fact that the mesenchyma, and it only, produces in the course of further development the connective tissue and supporting tissues of the adult. More attentive study of the germ layers in early stages reveals, however, that the mesenchymal cells arise from the epithelium, single epithelial cells migrating from the parent territory, while on the other hand groups of mesenchymal cells rearrange themselves so as to form an epithelial covering of some surface, as for example, in synovial cavities, arachnoid spaces, the inner surface of the cornea, lymph vessels, etc. Such observations teach us that we must not assume that either the form or the arrangement of cells is necessarily and always a sign of true differentiation, but that instead we are to conceive of differentiation as a change in the intimate and essential structure of the individual cell, more specifically of its protoplasm, and perhaps of its nucleus. The rôle of nuclei in histogenesis is a topic which unfortunately is still awaiting serious investigation. To resume: it seems to me probable that the cells of the germ layers are at first quite

\* Hertwig and some other German embryologists divide the mesoderm into two layers; the division is contrary to the actual development, and is made, in my opinion, quite arbitrarily to satisfy the needs of an erroneous theory.

indifferent, so that if it were possible to graft a young mesodermal cell on to the ectoderm or entoderm, it would become a true ectodermal or entodermal cell, as the case might be.

But although we may, so far as we now see, regard the cells in the germ layers as originally wholly indifferent as individual cells, nevertheless, we must not forget that as members of a germ layer their potential fate is already restricted by the conditions of their very layership—if I may coin a word for the occasion. Each layer produces its own group of tissues and never any other. There are indeed apparent exceptions to the rule, as, for example, the stratified horny epithelium of the œsophagus, which is strikingly similar to the epidermis, although in one case the tissue is ectodermal, in the other entodermal. We have, however, to do only with a resemblance, and the development in the two cases is quite unlike—the œsophageal epithelium in the mammalian embryo being ciliated at one stage and exhibiting then little resemblance to any stage of the epidermis.

Each germ layer has its specific function, its exclusive share in the work of differentiation. The work of one layer is not done by another nor shared by another. It is true that attempts are made from time to time to upset the validity of this fundamental doctrine, but they have hitherto failed to find support or recognition from any leading embryologist, and I deem these attempts unworthy of serious consideration. We are able now to assign almost every cell of the normal adult human body to its proper germ layer. Our only great uncertainty is where two layers meet, as do the ectoderm and entoderm in the pharynx, or as do the mesoderm and entoderm, where the ureter opens into the bladder. With these and perhaps a very few other small exceptions everything in adult anatomy

can be correctly stated in terms of germ layers. The layership of every organ is known, save that in the cases of the thymus gland, the tonsils and the adrenals authorities are not yet agreed.

A remarkable attempt to upset the doctrine of the germ layers deserves a brief consideration. It was first maintained by Goronovitch that the cells forming at least a part of the skeleton arose from the ectoderm. The same opinion was expressed also on the basis of their own investigations by H. Klaatsch and by Miss Platt. Confirmation of these views has not followed, but on the contrary, C. Rabl, one of the most trustworthy of living observers, maintains that essential parts of Goronovitch's and Klaatsch's evidence are simply errors of observation. Klaatsch's views were based partly on the study of the developing teleost fins. R. G. Harrison has shown that here the German worker is in error. Miss Platt's observations were made in the head region of embryo *Necturus*. An examination of a number of series and stages has not enabled me to find the slightest evidence in favor of Miss Platt's conclusions. H. K. Corning has pointed out that the processes alleged by Miss Platt to occur in *Necturus* do not take place in the frog, *Rana temporaria*. We may, therefore, I think, safely regard this attempt to overthrow the morphological value of the germ layers as unsuccessful. I know of no other attempt of sufficient importance to be even mentioned.

The importance to pathologists of a thorough knowledge of the genesis of the tissues from their germ layers can hardly be emphasized too strongly, for it is more than probable that all pathological tissues are as strictly governed by the law of the specific value of germ-layers as are the normal tissues. Are there not many pathologists whose knowledge of embryology is wholly insufficient to meet the practical needs of

their professional study even in this one direction?

The accompanying table presents the principal tissues classified according to their layership. There have been classifications of organs on the layership basis published before, but inasmuch as organs usually contain cells from two layers, we get a more correct presentation of the actual genetic relationships by restricting our tabulation to the tissues. Leucocytes do not appear in the table for the reason that

erto been clearly recognized or defined. For both types the starting point is the same, the undifferentiated embryonic cell. In one type we find that as the cells proliferate, a portion of them only undergoes differentiation, and another portion remains more or less undifferentiated and retains more or less fully the power of continued proliferation. The epidermis is a good representative of this type. Its basal layer consists of embryonic cells, which multiply; some of these cells move into the upper layers,

## CLASSIFICATION OF THE TISSUES.

## A. ECTODERMAL.

1. *Epidermis*.
  - a. Epidermal appendages.
  - b. Lens of eye.
2. *Epithelium* of
  - a. cornea.
  - b. olfactory chamber.
  - c. auditory organ.
  - d. mouth
    - (oral glands),
    - (enamel organ),
    - (hypophysis).
  - e. anus.
  - f. chorion,
    - Fœtal placenta.
  - g. amnion.
3. *Nervous system*.
  - a. Brain,
    - optic nerve,
    - retina.
  - b. Spinal cord.
  - c. Ganglia.
  - d. Neuraxons.

## B. MESODERMAL.

1. *Mesothelium*.
  - a. Epithelium of
    - peritonæum,
    - pericardium,
    - pleura,
    - urogenital organs.
  - b. Striated muscles.
2. *Mesenchyma*.
  - a. Connective tissue,
  - Smooth muscle,
  - Pseudo-endothelium,
  - Fat-cells,
  - Pigment cells.
  - b. Blood.
  - c. Blood vessels.
  - d. Lymphatics.
  - e. Spleen.
  - f. Supporting tissues,
    - cartilage,
    - bone.
  - g. Marrow.

## C. ENTODERMAL.

1. *Notochord*.
2. *Epithelium* of
  - a. Digestive tract,
    - œsophagus,
    - stomach,
    - liver,
    - pancreas,
    - small intestine,
    - yolk-sack,
    - large intestine,
    - œcum,
    - vermix,
    - rectum,
    - Allantois (bladder).
  - b. Pharynx,
    - Eustachian tube,
    - Tonsils,
    - Thymus,
    - Parathyroids,
    - Thyroid.
  - c. Respiratory tract,
    - Larynx,
    - Trachea,
    - Lungs.

their first origin is uncertain. Blood cells arise very early, before the clear separation of mesoderm and entoderm has occurred—it is possible that they are entodermal. With these two limitations, the table presents our present knowledge.

We will now turn to the analysis of the differential process in each germ layer. We have to deal with changes in cells.

There are two distinct types of cell differentiation, which I think have not hith-

erto been clearly recognized or defined. For both types the starting point is the same, the undifferentiated embryonic cell. In one type we find that as the cells proliferate, a portion of them only undergoes differentiation, and another portion remains more or less undifferentiated and retains more or less fully the power of continued proliferation. The epidermis is a good representative of this type. Its basal layer consists of embryonic cells, which multiply; some of these cells move into the upper layers,

culminating and most perfect illustration in the central nervous system, where comparatively early in embryonic life all the cells become specialized, and with the acquisition of specialization they forfeit their power of multiplication, the neuroglia cells partly, the nerve cells wholly. The growth of the brain after early stages depends not on proliferation of cells, but chiefly upon the increase in size of the individual cell. The correctness of this statement is not affected, in my belief, by the fact that epithelial portions of the medullary tube in comparatively late stages may be added to the nervous portion, the cells multiplying rapidly, as we see at the growing edge of the young cerebellum. The brain here grows by the addition of cells in the indifferent stage, but as soon as these cells are differentiated they conform to the general law and divide no more (neurones) or slowly (glia cells).

The two types of differentiation produce essentially unlike conditions. The pathologist may not overlook such unlikeness with impunity. The two types pass into one another with many intergrades. Hence when we consider the possibilities of pathological alteration we must in each case seek to determine how far the condition of the tissue involved permits cell multiplication, as well as differentiation.

Just as the segmenting ovum divides itself into parts, which we name germ layers, each of which has its special and exclusive share in developing the adult tissues, so does each of the three germ layers divide into parts, each part having its special and exclusive roll, and these parts again subdivide until, after the final partition, the adult variety is produced. During all these changes there is no exchange of rôles. It will be profitable to let the phenomena pass before us in rapid review.

First, then, the ectoderm. This layer early separates into two parts; one to form

the central nervous system, the second the epidermis; the nervous part thereafter never forms epidermal structures, the epidermal part never forms a nervous system. The central nervous system retains in part a simple epithelial character, but most of its walls become nervous tissue; its cells pass from the indifferent stage and become neuroglia cells or young nerve cells (neuroblasts). Neuroglia cells never become anything else, and the nerve cells are always nerve cells to the end. The primitive epidermis forms a series of special sensory areas and the permanent epidermis. The sensory areas, which belong to the olfactory, auditory and gustatory organs, soon become well defined and never produce any cell arrangements like those of the epidermis. This last, on the contrary, remains as before stated, rich in undifferentiated cells, and gradually produces a great variety of structures. Most of these, namely, the hairs and glands, are small and very numerous, while a few like the nails, enamel organs and epithelium of the lips are larger. No one of these special structures, however, converts itself into another. The basal layer of the general epidermis may perhaps preserve a true embryonic quality and have wide differential possibilities.

Next, as to the entoderm, which undergoes less differentiation than either of the other two germ layers, since over a large part of its extent it remains throughout life a simple epithelium with many cells very slightly modified in structure. Wherever in it specialization takes place, as in the tonsil, thymus, thyroid, œsophagus, liver or pancreas, each territory of cells keeps its characteristics and never assumes those of another territory.

Finally as to the mesoderm, in which layer variety of differentiation attains its maximum. To follow the genesis of this variety is most instructive. The mesoderm



is found very early to include in vertebrate embryos, four kinds of cells, of which the most numerous are undifferentiated cells; the other three kinds being (1) endothelial cells of blood vessels; (2) blood cells; (3) sexual cells; all these are precociously specialized; they are few in number, yet they are probably the parents of all the cells which are produced of their kind throughout life. Our present knowledge does not permit us to speak with entire certainty, but the evidence is strongly in favor of the following three conceptions:

*First.* That all the endothelium of the blood vessels of the adult is descended directly, from the endothelium of the first blood vessels differentiated in the extra-embryonic portion of the germinal area.

*Second.* That all the red blood corpuscles are descendants from the red-blood-cells of the blood-islands of the area vasculosa. According to this view the blood forming organs, as they are called, merely provide sites, where the red cells can multiply, as for instance in the mammalian embryonic liver or in the adult marrow.

*Third.* That the primitive sexual cells by their multiplication produce all the cells from which the genoblasts, or sexual elements proper, male and female, are evolved.

The future will decide the validity of these conceptions. They are very significant, because they assume that there are cells which form exclusive classes, and are characterized by a special combination of qualities, so that while they retain so much of the embryonic character as to have still the power of rapid multiplication, they yet are so specialized that they can only produce their like. If the three conceptions are established, we shall regard these three sorts of cells as almost the first to be fully differentiated. We shall also have to regard the vascular endothelium as distinct not only from the epithelial lining of the body cavity, but also from that of the

lymphatic system. The immense importance of such a discovery as bearing upon pathological researches and interpretations is obvious.

The next important change in the mesoderm is the development of the main body-cavity, which the embryologist designates comprehensively as the *cœlom*. The cells, which lie next the body-cavity and border it, assume an epithelial arrangement; this epithelial layer around the *cœlom* is properly named '*mesothelium*,' and the loose cells about it constitute the '*mesenchyma*.' We do not have, however, at first a true differentiation of mesothelial and mesenchymal cells; all are undifferentiated, and we can readily demonstrate that the cells are interchangeable, differing during early stages by their positions in relation to one another and to the body cavity, but not differing in their essential structures or qualities. Thus we find that the mesothelium constantly gives off cells which join the mesenchyma, and we find later that mesenchymal cells may take on an epithelial arrangement around any of the cavities—and there are many such—which arise within the mesenchyma itself in the course of further development.

But, although difference of arrangement does not necessarily indicate differentiation of the cells, it does affect the character of the differentiation which ensues. As every text-book states, the mesothelium gives rise to the striated muscles and to the epithelial portions of the entire genito-urinary tract, and is permanently retained, with slighter modifications, as the epithelium of the pericardium, pleuræ and peritoneum. The mesenchyma produces an even greater variety since it is the parent of not only all the connective and supporting tissue, but also of the lymphatic system.

I venture to turn aside for a moment to urge upon you the adoption of the term *mesothelium* as the correct designation for the

epithelial lining for the cavities of the thorax and abdomen. It is literally the same epithelium in the four cavities, for they were originally one, with a single continuous epithelium. It is well also in our nomenclature to recognize the important fact that the epithelium is radically, because genetically, distinct from the endothelium of the blood vessels and lymphatics, and the application of the term 'endothelium' to the covering of, for instance, the peritoneum, leads and can lead only to confused bad thinking. If mesothelium be employed as suggested, clearness will be gained.

Coming back now to the subject of the mesoderm, let us note that when a striated muscle fiber is produced a striated muscle fiber it always remains, and it never becomes anything else; the ovary never changes. In short, with the mesoderm as with the ectoderm and entoderm, we see the fate of the cells once fixed to be thereafter unchangeable as to the kind of differentiation.

Our hasty review is worse than imperfect, yet is sufficient to impress upon us the great law that differentiation in any direction terminates the possibility of differentiation in any other direction. In accordance with this law we encounter no instances, either in normal or in pathological development, of the transformation of a cell of one kind of tissue into a cell of another kind of tissue, and further we encounter no instance of a differentiated cell being transformed back into an undifferentiated cell of the embryonic type with varied potentialities.

Thus far I have expressed myself somewhat as if there were two sharply defined conditions, the differentiated and the undifferentiated. To give such an impression would be to create error, since differentiation is a slowly progressive and wholly gradual change in the cell. We must look

upon each step in the process of differentiation as establishing narrower limits for future changes. Thus, when in the spinal cord neuroblasts diverge from the glia cells, they are not specialized into different classes of neuroblasts; such specialization comes later. So in the mesenchyma after the embryonic cells have changed and large numbers of them have become connective tissue cells, these last still are capable of various further differentiations, and may, therefore, be said to have been arrested in their development at a stage of partial differentiation. This quality of the connective tissue cells is, from the pathological standpoint, one of the most important facts known to us concerning the structure of the body.

Having now elaborated, as far as time permits, our conception of the nature of differentiation, let us turn to our third fundamental idea, which concerns the changes which succeed differentiation. These changes are very unlike the constructive changes which precede them, for they are destructive. They fall into three main groups:

1. Changes of direct cell death.
2. Necrobiosis,\* or indirect cell death preceded by changes in cell structure.
3. Hypertrophic degeneration or indirect cell death preceded by growth and structural change of the cell.

Of direct cell death no discussion is here necessary, for the fundamental idea, which I wish to emphasize, is that necrobiosis and hypertrophic degeneration are normal processes, which invariably occur in the normal body and play in many cases important rôles in the life history of the individual. Without necrobiosis and degeneration on a large scale, the normal round of human life would be impossible. It is singular that in treatises on normal anatomy and

\* It is a matter for regret that so awkward a term as 'necrobiosis' should have become current.

histology these two subjects are generally neglected or at most appear only as matters of incidental reference. The force of tradition makes us apply these terms as if they correspond exclusively to pathological conditions. This tradition might still prescribe our mental attitude, were it not that the studies of the last dozen years have made us familiar with the enormous extent, variety and rapidity of the destructive degenerations which go on in the pregnant uterus of placental mammals, a degeneration which takes place without affording a trace or a suggestion of any pathological modification whatsoever of the organ. To our inherited prejudices the uterine phenomena alluded to are startling, but their evidence before the tribunal of biology has settled the case in favor of the plea that hypertrophic degeneration is a normal factor in typical healthy development.

The normal and pathological changes associated with the death of cells, and consequently also of the tissues which are formed by cells, are so nearly identical that they may be combined in a single discussion. For the more convenient presentation of the subject the following table has been prepared. Concerning the table little explanation is necessary.

A few special points need mention. The distinction made between necrobiosis and degeneration corresponds to recognizable differences, but our present knowledge is insufficient to provide clear definitions for the two closely related types of indirect cell death. I feel much doubt as to the propriety of including *atrophy* in the table at all, since it seems to me that we ought, perhaps, not to regard atrophy as a phenomenon of a distinct class, but merely as a result of necrobiotic or degenerative alterations in cells and organs. Under the heading 'degeneration' the division into 'cytoplasmic' and 'paraplasmic' takes us beyond our present knowledge, while the

division 'nuclear' is added rather to satisfy a biological conscience than to represent a part of our knowledge.

#### Death of Cells.

##### First—Causes of death.

- a. External to the organism.
  1. Physical (mechanical, chemical, thermal, etc.).
  2. Parasites.
- b. Changes in intercellular substances (probably primarily due to cells).
  1. Hypertrophy.
  2. Induration.
  3. Calcification.
  4. Amyloid degeneration.
- c. Changes inherent in cells.

##### Second—Morphological changes of dying cells.

- a. Direct death of cells.
  1. Atrophy.
  2. Disintegration and resorption.
- b. Indirect death of cells.
  1. Necrobiosis (structural change precedes final death).
  2. Hypertrophic degeneration (growth and structural change often with nuclear proliferation precede final death).

##### Third—Removal of cells.

- a. By mechanical means (sloughing or shedding).
- b. By chemical means (solution).
- c. By phagocytes.

The preceding table represents the only attempt of the kind known to me, and like other first attempts is undoubtedly very imperfect. It embodies obviously no new facts. But, because it is frequently a scientific gain to systematize our information, I hope the table may be useful, and it will certainly serve its immediate purpose, namely, to guide our discussion of the normal changes which follow after cellular differentiation.

As the time at our command is brief let us pass by the consideration of the causes of cell death. I will remark only that I think amyloid degeneration may be found to occur in the placental decidua of the human pregnant uterus and perhaps in other normal structures. No positive information

on this point is known to me. For the reasons stated a few minutes ago atrophy may also be omitted here. We pass by also the direct forms of cell death, to reach at once the consideration of the indirect forms.

The accompanying table offers an analysis of some of the principal varieties of structural change, which occur during indirect cell death.

#### Indirect Death of Cells.

##### A. *Necrobiosis*.

1. Cytoplasmic changes.
  - a. granulation.
  - b. hyaline transformation.
  - c. imbibition.
  - d. desiccation.
  - e. clasmatosis.
2. Nuclear changes.
  - a. karyorhexis.
  - h. karyolysis.

##### B. *Hypertrophic degeneration*.

1. Cytoplasmic.\*
  - a. granular.
  - b. cornifying.
  - c. hyaline.
2. Paraplasmic.\*
  - a. fatty.
  - b. pigmentary.
  - c. mucoid.
  - d. colloid, etc.
3. Nuclear (? increase of chromatin).

We begin, therefore, with necrobiosis. We may appropriately mention first those organs of which the existence is limited in time, such as the thymus and the foetal kidney (mesonephros or Wolffian body). These organs attain first their full differentiation; their elements during the next phase die off, and finally are resorbed, most of the organ disappearing. In the same category of change belong the histories of the senile ovary and testis. Another familiar illustration is offered by the notochord, which in the mammals totally disappears during the foetal period. The notochord cells undergo peculiar characteristic modifications, hence it is difficult to

\* I cannot venture to assert that these two divisions are valid, and not arbitrary.

say whether or not there is degeneration in the strict sense. Cell-death on a large scale is a common phenomenon of the tissues. It occurs in cartilage both when the cartilage is permanent and even more conspicuously when cartilage gives way to bone, the disintegration of the cartilage cells preceding the irruption of the bone forming tissues. It occurs among the bone cells after they are imbedded in their calcified matrix. It occurs in the ovary, where we designate its result as atresia of the follicles. It occurs in the sebaceous glands as an accompaniment of the process of their secretion. It occurs among the glands of the intestine as discovered by Stöhr, and occurs normally, though not constantly, in the appendix, as recorded by Ribbert. It occurs in the epithelium of the human pregnant uterus and in all the tissues of the human decidua reflexa. Other examples could be enumerated, but we may content ourselves with citing the constant destruction of blood corpuscles, both red and white.

Degeneration, in the stricter sense of an ante-mortem hypertrophic change of cell structure, is also of widespread occurrence in the healthy body. No case of so-called granular degeneration under strictly normal conditions is known to me, though it seems quite credible that such cases should occur. On the other hand, the cornifying degeneration is very important and does occur in all three germ-layers, for we observe it in the ectoderm of the skin, the entoderm of the oesophagus and the mesoderm of the vagina. Hyaline degeneration of so striking a character as to have been termed pseudo-pathological takes place regularly in the ectoderm (outer epithelium) of the placental chorion. In the rabbit it occurs in the uterine glands, during pregnancy, causing most rapid histolysis, and it seems to me probable that some of the changes, which can be observed in the decidua of the pregnant human uterus

ought also to be regarded as cases of hyaline degeneration. That fatty degeneration takes place normally has long been taught. There seems no reason for regarding the development of ordinary or mesenchymal fat-cells otherwise than as instances of normal degeneration. In old age a more or less marked fatty degeneration may be wide spread and occur in many different kinds of cells. The same is true of the deposit of pigment, as we see it in the liver cells and motor nerve cells of adults. Finally, mucoid and colloid degeneration are so obviously normal, that we commonly think of their pathological occurrence as merely an exaggeration of a normal state.

The various kinds of changes in dying cells, with which the pathologist is most familiar, recur in healthy tissues. In the preceding table seven forms of change are enumerated under the heading '*necrobiosis*.' Every one of these seven occurs normally. Granulation of the bodies of the cartilage cells and of the notochord cells may be observed to precede their resorption. Hyaline transformation is conspicuous in the decidua reflexa. Imbibition or cellular oedema occurs in the epidermis of the lips, in the cells of the uterine glands during pregnancy after they have detached themselves from the gland walls, and in the endothelium of placental blood vessels of the rabbit. Desiccation is the usual accompaniment of cornification. Clasmatosis has given its name to the clasmatocytes of Ranvier, and we may well apply the same term to the cells of the secreting milk gland, and also, as an unpublished research indicates, to the cells of the secreting glands of the cervix uteri. Karyolysis is, according to present probabilities, the method by which nucleated red blood cells are converted into non-nucleated blood-corpuscles. Karyorhexis, or the fragmentation of the nucleus, occurs in the cells of the disappearing follicles of the ovary.

Lastly as to the removal of cells. The sloughing off of cells is one of the most familiar phenomena, since it occurs incessantly over the epidermis and with the hairs; its part in menstruation and its colossal rôle in the afterbirth are known to all, and every practitioner is accustomed to look for shed cells in urinary sediment. Large numbers of cells are lost by the intestinal epithelium. Cells without access to the external world must be got rid of by resorption, which seems to take place either with or without the cooperation of leucocytes. In the latter case we must for lack of a better hypothesis attribute the resorption to chemical means. Of resorption with the aid of leucocytes the necrosed human decidua reflexa offers a perfect illustration. Of resorption without leucocytes the masses of degenerated epithelium in the placenta, periplacenta and obplacenta of the rabbit afford by far the most impressive demonstration I have ever seen. At nine days after conception the epithelium is profoundly changed, being very much thickened, and where thickened transformed into a syncytium without cell boundaries, but with an enormously increased number of nuclei. In the obplacenta (or portion of the uterine wall opposite the placenta proper) portions of the epithelium from the fundus of the glands remain, but the upper stratum has not only undergone syncytial degeneration, but has become vacuolated and partly resorbed without being directly attacked by either leucocytes or epithelium or any other kind of cells. At eleven days the resorption has progressed still farther, so that the degenerated part is almost gone, but meanwhile the isolated patches of epithelium have spread until they have united and so reformed a continuous epithelium. At thirteen days the epithelium has reconstituted new glands or follicles, very unlike, however, those of the resting uterus. To ex-

plain the extraordinarily rapid disappearance of the degenerated material in the obplacenta the only available hypothesis seems to be that of a chemical change by which the material becomes soluble or is dissolved, for we see the disappearance of the substance taking place in the very heart of the layer, and not merely at the surface. Sloughing is impossible and there are no phagocytes, leaving the chemical explanation as the only one I have been able to conceive. The contemplation of the described phenomena of the rabbit's obplacenta inevitably raises the question—do we not tend in our explanations of the removal of necrosed and degenerated tissues to attribute too much to phagocytes and too little to direct chemical action? May it not be that the body produces histolytic toxins, which can destroy tissues somewhat as do snake-poisons?

The cycle of changes through which cells pass is obviously longer than the period of development and the differentiation, yet its phases all belong together as members of a single series. We lack a word to designate the entire series of changes, and for the lack of such a word often fail to appreciate the essential unity of progressive and regressive modification of cell-structure. Accordingly, I wish to propose the new term *cytomorphosis* to designate comprehensively all the structural alterations which cells, or successive generations of cells, may undergo from the earliest undifferentiated stage to their final destruction.

#### PART II. PATHOLOGICAL DIFFERENTIATION.

We have now completed our brief reviews of the four fundamental successive stages of cytomorphosis. These stages are:

*First*. Undifferentiated.

*Second*. Progressive differentiation, which itself often comprises many successive stages.

*Third*. Regression (necrobiosis or degeneration).

*Fourth*. Removal of the dead material.

Let us now apply some of the conceptions won to the interpretation of pathological differentiation, remembering all the time that the interpretation of disease is a distinct and different problem. Although presumably pathological differentiation is the sole and exclusive cause of disease and no disease arises from any other immediate cause, yet the disease must be regarded as the result and, owing to the physiological correlation of the organs, this result may include many secondary effects, some of which are often of the greatest diagnostic value, and therefore likely to divert attention from the primary structural cause.

Our review of normal conditions furnishes us with three general conceptions, which are valuable for their pathological applications,—namely:

*First*. That each germ layer has a specific and exclusive share in the production of tissues.

*Second*. That undifferentiated cells, characterized by having only a small amount of unspecialized protoplasm, exist not only in the embryo, but also throughout life in certain parts of all three germ-layers.

*Third*. That differentiated cells characterized by having a larger amount of specialized protoplasm, form most of the organs of the adult and are incapable of undergoing any new unlike differentiation, though they are still capable of completing their cytomorphosis, by necrobiosis or degeneration.

We must apply these conceptions, according to my belief, as rigidly to pathological as to normal development. Thus, as to the germ-layers, it ought to be possible even with our present knowledge, to show their pathogenetic values, so that every elementary student as a matter of course can be taught to classify accurately most pathological differentiations, and to accept such

a classification as the basis of all his further study of the science. How much this reform is needed is indicated by the many writers who put glioma under the head of connective tissue tumors, although gliomata arise from the ectoderm, and connective tissue arises from the mesoderm. Such a classification is on a par with the ancient system which put the whales among the fish, for it is not going too far to say that it is impossible that connective tissue should produce a glioma, because the two things belong in different classes. Another noteworthy violation of embryological law is offered by the classification of all muscle-tumors under one head, '*myoma*,' although smooth and striated muscle fibers are genetically and structurally distinct, with no intermediate or connecting forms of tissue, and with only a slight physiological resemblance. As regards epitheliomata; they should be studied in relation to their layership, and it is reasonable, in my judgment, to expect that they will be found to have very distinctive characteristics according to the germ-layer from which they take origin, for the layership of a tissue governs the normal differentiation and therefore probably also the abnormal. I believe that the first competent investigation in this field will mark a new epoch of pathological science. When the epoch comes our morphological sense will no longer be shocked, as for instance by the application of the name adenoma to an epithelioma of an organ like the kidney, which is in no sense a gland.

I should like to urge especially the study of the layership of the various cancers. Can we safely assume that there is only one kind of cancer? May it not well be that ectodermal, mesothelial and entodermal cancers are separate kinds?

Next as to undifferentiated cells. The cells of this sort have the power of multiplication in a high degree, and they have

the possibilities of increasing their size and of undergoing further differentiation, and their occurrence in the adult is of the utmost pathological significance. Such cells exist in four important parts, (1) in the basal layer of the epidermis and in corresponding portions of the epidermal appendages; (2) in the adult mesenchyma or connective tissue; (3) in many parts of the adult mesothelium, especially of the epithelia of the genito-urinary tracts; (4) in the entodermal epithelium of the gastro-intestinal tract. It is significant that it is precisely from these parts that the development of many rapidly growing tumors takes place, and it is further significant that the least differentiated or specialized of all, namely, the mesenchymal cells, are the ones which produce the greatest variety of tumors—as the following list recalls: myxoma, myoma (but not rhabdomyoma), fibroma, lipoma, chondroma, osteoma and sarcoma. Angioma presumably belongs in a different category. The mesenchyma still exhibits, by the formation of its characteristic tumors in the adult, its embryonic capacity to transform itself in varied ways.

Further insight into pathological development may be gained from the tissues or cells which have undergone differentiation, but do not attain a high grade of specialization. The endothelium of blood-vessels, the endothelium of lymph-vessels, the red-blood cells, the leucocytes and the neuroglia are examples of this class. All the cells of the kind just enumerated have advanced in organization beyond the embryonic state, but have retained the power of cell multiplication. When they multiply they produce cells like themselves, so that we might describe them as so many histological species each capable of reproducing its own kind. In accordance with this conception, derived from the normal development, is the pathological fact that each of these

species of cells produces tumors of its own kind. This is a familiar conclusion as regards the endothelium, both of the blood-vessels and of the lymph-vessels, and also as regards the neuroglia. It seems to me that the excessive multiplication of leucocytes may properly be classed in the same category as the growths resulting in angioma and glioma. I do not know whether or not an excessive and abnormally rapid production of red blood cells may occur so as to occasion a special and distinct disease. Increased production of red blood cells (erythrocytes) is, of course, well known to occur, but I understand that a distinct disease of this origin is, as yet at least, not recognized. It is not improbable, however, that such a disease exists—we should, I suppose, name it *erythrocytosis* or *haematoma*.

We can now distinguish two main groups of new formations; first, those with marked cytomorphosis, or changes in cell structure, as, for example, myoma, lipoma, chondroma, etc.; second, those without marked cytomorphosis, the cells of the new growth resembling those of the parent tissue as, for example, angioma and glioma.

Members of the first group have been termed *heteroplastic*.

Members of the second group have been termed *homoplastic*.

Accepting these terms, we may say tumors are either *heteroplastic* or *homoplastic*. From the standpoint of the embryologist these terms are much more than convenient adjectives; on the contrary, they denote differences of a fundamental character, upon which we must base a large part of our notions about pathological differentiation.

Finally, as to the differentiated cells. We have just considered cells which have reached a low degree of differentiation, and therefore will now give our attention only to the most highly differentiated. Of these the nerve cells, or as they are now termed, the neurones, stand highest and are char-

acterized not only by the great specialization of their organization, but also by the complete loss of their ability to multiply by cell-division. The neurones are then extremely unlike the embryonic cells and they represent the extreme end of that scale of which the undifferentiated cell is the beginning. It is, therefore, very significant that neurones do not form tumors. Neuronoma, as such a tumor would be called, does not occur, so far as hitherto recorded—and if, as is possible, a neuronoma should be found, we should have to explain it not as a tumor-growth of neurones, but as the result of proliferation of indifferent cells, which subsequently became differentiated into neurones. The so-called neuromata of pathologists do not here come into consideration because they are merely accumulations of growing axis-cylinders.

Liver cells and striated muscles also represent a very high differentiation. It is possible that with more exact knowledge we shall be able to state that these elements also cannot produce tumors, although there may be tumors of the liver and of striated muscle-fibers. Possible, because Cohnheim's famous theory of tumor origin from persistent embryonic tissue may be, though not generally applicable, available in these two instances. The adoption of this view would furnish an explanation of several familiar facts; of the fact that we do not find tumors formed by differentiated liver cells; of the fact that cancer of the liver arises usually from the bile-ducts, which have a simple and little differentiated epithelium; of the fact that myoma of the cardiac and of the developed skeletal muscles is exceedingly rare; of the fact that rhabdomyomas so occur that their origin may be attributed to inclusions of portions of embryonic muscle plates. As regards primary epithelioma of the liver, it is claimed that it arises usually from the bile-



ducts, but the liver-cells are also involved, but how it comes about that the liver-cells participate is, so far as I have been able to learn, by no means clear. From analogy with other tissues, we infer that it is improbable that the large and specialized liver-cells ever resume an embryonic character. In short, I deem our understanding of the pathological differentiation of hepatic cells and of striated muscle fibers too imperfect to support a judgment. We can only say that the rarity of such differentiation concords with the degree of normal specialization of the cells and fibers in question.

Our very brief discussion of pathological differentiation seems to justify the following conclusions: *First*, the process in its essential features is identical with the process of normal differentiation; *second*, the character of a tumor depends primarily upon the layership of the cells producing it; *third*, normal differentiation impedes and limits the formation of tumors, precisely as it does of further normal structures; so that tumors arise most readily from undifferentiated tissues and may then be heteroplastic; and arise readily from differentiated tissues and are then always homoplastic; and arise unready or not at all from the most highly specialized tissues.

Each of these three conclusions might be advanced as a law of normal development, if we substitute the term 'differentiated tissue' for 'tumor.'

We now pass on to the final stage of cytomorphosis, necrobiosis and hypertrophic degeneration in their pathological manifestations. The consideration of the direct or simple death of cells need not detain us, nor need we pause long over the indirect forms of cell death. In fact, the analysis made earlier this evening of normal necrobiosis and degeneration forced us to recognize that all, or nearly all, the modes of indirect cell death which the pathologist encounters in morbid tissue recur under

healthy normal conditions. To put the conclusion in its correct form, we need only to reverse it, saying:

Most, and probably all, pathological necrobiosis and degenerations of cells are essentially identical with normal processes, and are pathological, owing to the abnormality of their occurrence in time and site.

Death of a cell may, of course, occur at any moment as a consequence of conditions external to itself. To a given cell, as such, it is of no moment whether the term 'physiological' or 'pathological' be applied by us to the conditions which cause its death. The cell has its own inherent qualities, and its own cytomorphic possibilities. All that the environment of the cell can do, so far as we can at present understand, is to evoke, and perhaps to a minor degree modify, one of the possible structural changes of the cell. Hence we find actually that the processes of cellular necrobiosis appear to us identical in normal and pathological cases. This affirmation does not imply that a given cell has only one kind of possible necrobiosis before it. Quite otherwise, it being reasonable to believe that any one of several forms of necrobiosis, according to the circumstances, may ensue.

All that has just been said might be repeated in reference to hypertrophic degeneration. One of the investigations which is most needed at the present time, and which promises results of extreme interest and importance, is the investigation of necrobiotic and degenerative cytomorphosis, carried out as a research upon cell structure. At present we cannot discuss the subject except in terms of the very vagueness of which is a mortifying confession of ignorance.

Time forbids the prolongation of the discussion. But, although a more detailed study is thus for the present excluded, we

have, nevertheless, dealt with the subject with sufficient fullness, I hope, to convince you, if you were not already convinced, that the fundamental problems of pathology and embryology are alike, not only in being problems of cell life, but also in being similar and even identical problems of cell life. Widely as the two sciences differ, they rest on a common foundation.

To complete our subject it would be necessary to summarize our present knowledge as to the causes of cell differentiation. Physiological morphology is a new science; we have barely crossed its threshold, and are not yet at home in it. To the physician this new science promises to far surpass in practical importance even the bacteriology of our time, since it is not presumptuous to hope that when we understand the physiological factors, thermal, chemical stimulant, mechanical and other, which bring about structure, which cause cytomorphosis, we can acquire control over cellular differentiation, and ultimately be able to prevent some of the most formidable diseases, over which we now have little or no power. The diseases which we may attack in the future in this way are diseases which may be designated as morphogenetic, because they are due to errors of morphological differentiation. At this vast topic it is impossible now to more than hint.

Here we may stop, not because all the great host of relations between embryology and pathology have been marshaled before us, but because enough of these relations have passed us in review to present a conclusive body of arguments. As we follow their march, we find ourselves led to the attack upon the problem of the causes of the specialization of cells, of histogenesis. To conquer this problem our only hope lies in the junction of all our forces.

Before closing, a personal word: first, of sincere thanks for the honor you have con-

ferred upon me both by your invitation and by your attention, and then a word to express the great diffidence with which I have undertaken to deal with pathological phenomena. A man of science ranks according to the number of details which he has mastered, and his ability to drill them into coherent battalions. By no such system of ranking can I hope to be included among pathologists. I offer, therefore, only the thoughts of an outsider, derived from the long pursuit of a cognate science. Such external suggestions, being independent to some degree of pathological tradition, may contribute to vivify the conception of the unity of the biological phenomena and, therefore, of all forms of biological investigation. It will be a service rendered if my words recall the great truth that biology is not a congeries of sciences, but a single science, which we artificially divide and subdivide until the parts are commensurate with our mental capacity. In the truest sense we are fellow-workers. Let us, therefore, work together.

CHARLES SEDGWICK MINOT.

*THE DETERMINATION OF THE TYPE IN  
COMPOSITE GENERA OF ANIMALS  
AND PLANTS.*

To the older naturalists a genus was a subdivision of an order containing a number of species, each standing in like relations to the genus. The genus was a pigeon-hole into which species of similar characters were thrust.

In the modern conception a genus is a group of related species, associated about a single one which is the type of the genus. In theory this type should be the central species or the most primitive one. In the exigencies of nomenclature, it is the one which was in point of fact first associated with the generic name. Modern writers recognize this grouping of species about the generic type, and to each new genus of

most recent writers a type is definitely assigned by the author of the genus. In modern rules of nomenclature the definition of a genus may be altered or even reversed, but the generic name must adhere to the original type.

The most serious difficulty in connection with the matter of nomenclature lies in the reduction of the ancient conception of the genus to the terms of the modern one. It lies in the assignment of a type species to a group in which the original author had no conception of the need of such a species.

In the subdivision and fixation of the ancient genera, various methods have been followed, with varying results. In other words, these methods have lacked the one important element of inevitableness. A rule of nomenclature has little value unless it lies in the nature of things. If it is artificial, it will be discarded.

In general, three methods have been followed in fixing the types of the early composite genera :

1. To follow the arrangement of the author who first subdivides the genus subsequent to the work of the original author.

In this many difficulties have been found in practise. The first restriction is often in obscure publications. It is often obscurely done. In other words, a genus is often subdivided in such a way as to leave no clear idea as to what the author would leave in the original group. Sometimes he leaves nothing at all, as in the case of the Linnæan genus, *Sparus*, for which no place was left after its subdivision. As a matter of fact, this system leaves the proper application of many generic names in doubt, and necessitates a profitless investigation of the opinions of early authors who wished to improve Linnæan nomenclature, but who worked on too small a scale to accomplish much.

A second system derived from this is the method of elimination. The genus of the

eighteenth century corresponds roughly to the family of the nineteenth. The family may contain several genera. These may be withdrawn from the original genus in chronological order, and the old name left with the final residue. But this residue will generally consist of foreign species or species unidentified or unidentifiable. To meet this difficulty the method of elimination in birds has been applied to European species only, that generic names based primarily on European forms may not be forced out of the European fauna. To make the system workable a variety of other minor rules must be invented, as a little change in the point of view as to some obscure author will make an entire change in the final result. The final result is the only matter of interest. .

The ornithologists have found this scheme workable and it is incorporated in the rules of the American Ornithologists' Union. But even here it has not yielded stability of nomenclature, as several generic names (as of owls, loons) have been more than once altered in obedience to its dictates. But in American ornithology any rule has the great advantage of the imposition of authority. The ornithologists of America agree to stand by their committees, and any decision these may make is final for them and their associates, that is for most ornithological work in America for the present generation.

Other branches of science have no such authority behind their verdicts, and without it the determination of generic types by elimination is a failure. Often two men working independently cannot reach by the same rules an identical result. It is not always easy for the same man to reach the same result twice.

Let us take a concrete problem. The genus *Chupanodon* of Lacépède (1802) containing those herrings which have no teeth includes several modern genera.

It was based originally on six species, *thrissa*, *nasica*, *pilchardus*, *sinensis*, *africanus*, *jussieu*.

In 1810, Rafinesque proposed to substitute *Thrissa* for *Clupanodon*, presumably because the latter name is badly formed. Presumably again, *thrissa* would be the type of this genus of Rafinesque, who again presumably took it, as the first species mentioned, as the type of *Clupanodon*.

In 1820, Rafinesque founded the American genus, *Dorosoma* (Chatoëssus), and to this genus *nasicus*, and afterwards *thrissa* were referred; *pilchardus* was long left in *Clupea*, which is older than *Clupanodon*, but in 1860 a related species (*pseudohispanicus*) became the type of the genus *Sardinia* of Poey. *Africanus* has teeth and does not conform to the definition of *Clupanodon*. It was made, in 1839, the type of a genus *Platygaster*, Swainson, but this name is preoccupied. Afterwards *Ilisha* (Gray, 1846) and *Pellona* (Valenciennes, 1847) were based on a species of the same type, the former without definition. *Sinensis* and *jussieu* were placed, in 1847, in a genus *Clupeonia*, by Valenciennes. Finally in 1900, Jordan and Snyder established the genus *Konosirus* on a Japanese species (*punctatus*) which proves identical with *thrissa*, and to which group *nasicus* also belongs.

In their first consideration of this generic name, Jordan and Gilbert succeeded in convincing themselves that *Clupanodon* should take the place of *Clupeonia*. Eliminating *Pellona*, and the earlier names *Dorosoma* and *Clupea*, *Clupanodon* was left for the remaining species, *sinensis* and *jussieu*.

But in 1896, Jordan and Evermann recognized that if *Sardinia* were a distinct genus, the rule of elimination required them to transfer to it the name *Clupanodon*, as *Sardinia* is of later date than *Clupeonia*.

In 1900, Jordan and Snyder showed that *Dorosoma punctatus* was the type of a distinct genus, which they called *Konosirus*. Later

it became evident that *thrissa* was identical with *punctatus* and by the law of elimination the name *Clupanodon* must supersede *Konosirus* as *thrissa* was the last of its species to be removed to a genus of its own. By this system the old generic name can never come to rest, but must be held in readiness to replace any new genus which may be formed from species included in its original content.

It was possible to defend in turn the use of *Clupanodon* in place of *Clupeonia*, *Sardinia*, and *Konosirus*. Should *nasica* ever receive a distinct generic name, *Clupanodon* must again move forward to replace it. On the other hand, writers called 'conservative' will reunite *Konosirus* with *Dorosoma* and *Sardinia* and *Clupeonia* with *Clupea*. In such case *Clupeonia* must fall back on *Ilisha*, a group originally included in *Clupanodon* by error. It is evident, that in this case no fixity is possible by the method of elimination, unless imposed by the temporary authority of some ichthyological union or mutual agreement among writers.

In default of such the present writer will use *Clupanodon* in place of his own genus, *Konosirus*, not on account of the results of elimination, but because the type of *Konosirus* is the first species named by Lacépède under his account of *Clupanodon*. If he should grow more 'conservative' he might reunite *Clupanodon* with *Dorosoma*. In such case he would call the whole genus, *Clupanodon*, because the name is prior to *Dorosoma*.

The third method of determination of generic type is through-consideration of the work of the author of the genus in question, without regard to the views or work of any subsequent matter.

This we do in accepting as the type of a genus the species indicated as such by the author. Such a statement cannot be reversed by any later author. In recent days, the type of a genus usually is indicated once for all in so many words. With earlier

writers who did not take this method we may be allowed to read between the lines. A leading ornithologist (Alfred Newton, if I am not mistaken), suggests that in the case of Linnæus we be allowed to ask the author what type he would have chosen if the modern problem were to be presented to him. As to this we should not be often left in doubt. If we are in doubt however, there is a very simple rule followed widely by naturalists, notably by Bleeker, the most voluminous writer on fishes. This is the selection, as type, of the first species named under the genus by its author, when other indications fail. This rule gives fixity, the sole essential thing. It gives justice. It saves a profitless overhauling of bibliography, and it is a clear way out of confusion. It is the only possible clear way.

I suggest for consideration the following provisional rules for the application of this method:

1. The type of a genus is the species designated as such by its author.

2. If no type is designated by the author, either explicitly or by clear implication, then the first species referred to the genus or the species standing first on the page, shall be considered as its type. A generic name should have no standing, if resting on definition alone, nor until associated with some definite species.

3. To this rule the following provisional exceptions may be made. The type of each genus of Linnæus as stated by him is 'the best known European or officinal species' it contains. In case of doubt in the application of this rule, the species standing first may have the benefit of the doubt. Unlike most subsequent authors, Linnæus usually placed his type species near the middle in the list of species. Cuvier made it his 'chef de file.'

4. In case of genera based on old specific names (*Belone*, *Achirus*, *Trachurus*) the species thus furnishing the name, if actu-

ally mentioned by the author of the genus, may be regarded as its type.

5. Possibly, to avoid confusion, it may be well to retain old generic names, restricted by common consent to a species not the first mentioned by the author, provided that such restriction antedates any modern names for the same genus. Thus it may be well to retain *Centropomus* for *Oxylabrax*, instead of *Lucioperca*, *Cheilodipterus* for *Paramia*, instead of *Pomatomus*, *Pomacanthus*, for *Pomacanthodes*, instead of *Zanclus*. But I doubt the wisdom of this exception, and I shall not be surprised to see future writers following Bleeker in the use of *Oxylabrax* and *Paramia*, leaving the generic names of Lacépède and of all writers since Linnæus, to the first species named by their author.

DAVID STARR JORDAN.

NOTE ON THE NUMBER OF PARTICLES IN  
THE SATURATED PHOSPHORUS  
EMANATION.\*

In a series of experiments made by passing air ionized to saturation by phosphorus through a slender tubular condenser (60 cm. long, radii of air space, .30 cm. and .16 cm.), I showed that the electrical current radially through the condenser for a given potential difference, and the volume per minute of the ionized air sent longitudinally through it, were rigorously proportional quantities. At the same time the color of the steam tube observed on passing the air from the condenser into it, was invariable no matter whether the condenser was charged or not, *cat. par.* Hence only an insignificant part of the particles producing condensation takes part in the electric current even with radial fields of 2,100 volts per cm., the highest safely admissible. I have estimated that less than 5 per cent. of

\* Preceding experiments in SCIENCE, Feb. 9, 1900, the above note being a sequel. I there gave relative values for the absorption velocities, absolute values being given in the *Am. Journ. of Science*, March, 1900.

the ions could have been destroyed by the electric transfer; otherwise the steam tube would have shown perceptible variation of color.

In connection with this result I have questioned whether the importance of the mutual destruction or decay of the ions has not been overestimated; whether the phenomenon of leakage in a plate condenser may not be very fully explained\* by taking account of the ions which wander *laterally* out of the field of force. Let  $A$  be the area of the condenser of air space  $x$ , and let  $ax$  be the circumferential area terminating in the edges of the condenser (mantel of the cylinder of air). If one of the plates is a phosphorus grid (thin pellets of phosphorus secured between appressed discs of wire gauze), let  $n$  be the number of particles per cubic centimeter at a normal distance  $x$  from the grid. Let  $k$  be the (absorption) velocity of the ions in the absence of an electrical field when passing from a saturated region either into free air or normally to an absorbing surface, and  $k'n^2$  the number decaying per cubic centimeter per second.

Remembering that in such a condenser there is lateral loss of ions escaping from between the plates, as well as the loss upon the plates whether the (phosphorus) condenser be charged electrically or not, the differential equation meeting the case is  $-dn/dx = n(a/A + nk'/k)$ . This is integrable in finite form, and if  $n_0$  be the number of ions per cubic centimeter at the phosphorus plate (saturation), the equation becomes  $n/n_0 = (a/A) / ((a/A + n_0k'/k)e^{(a/A)x} - n_0k'/k)$ . If  $k' = 0$ , decay within the ionized space is ignored and  $n = n_0/e^{ax/A}$ . Thus  $n$  is independent of the absorption velocity  $k$ , depending for a given initial saturation  $n_0$  only upon the mantel ( $ax$ ) and the base ( $A$ ) areas of the condenser air space.

Now let the condenser be charged, re-

\* See my paper in the *Physical Review*, X., p. 257, 1900, whence the data of this paper are taken.

membering that the additional loss from this cause alone is insignificant. Let  $V$  be the potential difference at the time  $t$ ,  $C$  the effective capacity,  $U$  the relative or mutual velocity of the ions,  $e$  the charge of each. Then  $-dV/dt = AUVne/Cx$ , or from the value of  $n$ ,  $-dV/dt = (AUVn_0e/C)/x e^{ax/A}$ .

In my data given in the *Physical Review* (l. c., Table III.) I put, as usual for leakages,  $V = V_0 10^{-ct}$ , whence  $c$  was computed. Substituting this in the preceding equation, it reduces to  $c = (AU_n_0e/Cln10)(1/x e^{ax/A})$ .

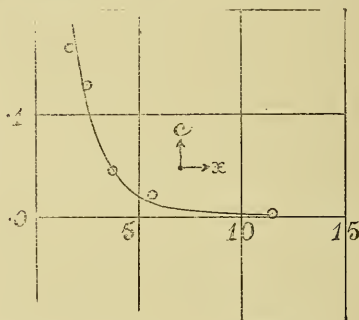

In the annexed diagram I have drawn this curve and distributed the observations with reference to it by so determining the constant  $AUn_0e/Cln10$ , that the first observations coincide ( $c = .200$ ,  $x = 1.7$ ). The agreement of the theoretical curve and the observations is so striking as to give great probability to the hypothesis that decay\* is here relatively insignificant.

It is even possible to make an approach toward computing the constant, which since  $c$  in my observations is taken rela-

\* How much importance is to be attached to this decay ( $k'$ ) I shall show in experiments with spherical condensers in which the ions can not escape. These results, while giving no evidence of decay, show that dilution (since saturation must fall off at increasing distances from a central phosphorus emanator) is accompanied by additional ionization; i. e., there is relatively too much current, *vel. par.*, when the spherical condenser is larger.

tive to minutes instead of seconds, now becomes  $K = 26AUn_0e/C$ . For if the velocity of the ions produced by phosphorus is like that of other gaseous ions,  $U$  is of the order (say) of 1 cm./sec (Rutherford, Townsend, Chattock) and  $e$  of the order of  $7 \times 10^{-10}$  electrostatic units or  $2.4 \times 10^{-10}$  coulombs. The ratio of areas in my condenser was .35, the area  $A = 132 \text{ cm}^2$ , the capacity  $C$  about 90 cm. or  $10^{-10}$  farads. Finally the observed value of  $K$  as used in computing the above curve was  $K = .63\pm$ . Thus the initial saturation  $n_0 = .634 \times 10^{-10}/26 \times 132 \times 1 \times 2.4 \times 10^{-10} = 8 \times 10^4$  nearly. Hence if all the ions which reach and are absorbed by the condenser plates actually convey electric charge, less than  $n_0 = 10$  ions per cubic centimeter occur in the saturated emanation contiguous to the surface of the phosphorus grid.

If now, instead of  $U = 1$  cm./sec. for the field of a volt per centimeter, the absorption velocity  $k = .3$  cm./sec. found in the absence of an electric field (*Am. Journ.*, March), were taken, the number  $n_0$  would be about 3 times larger; in such a case a special mechanism of electrolysis, as I endeavored to sketch it elsewhere, is in question. What I wish chiefly to point out, however, is that the order of the velocities  $U$  and  $k$ , obtained from such widely different experiments, is about the same. Indeed if one supposes that but 1/3 of all the ions travel in a given cardinal direction,  $3k$  will replace  $k$  in the above estimates, and the close proximity of  $3k$  and  $U$  is even more striking.

C. BARUS.

BROWN UNIVERSITY, Providence, R. I.

#### SCIENTIFIC BOOKS.

*Report of the U. S. Commissioner of Patents to Congress for the year ending December 31, 1900.* Washington, Government Printing Office. 8vo. 1901. Pp. 19.

Among the many causes which have conspired to give the United States its present leading

position in the industrial world, it may be doubted whether any single influence has been more potent than that liberal system of patent law which was established in the days of Washington and Hamilton, and which has been constantly under revision, usually and until lately with improvement, throughout the century. That defect which permits the inventor to secure a patent upon the simple presentation of a written claim, with a drawing or a diagram, and without any real work in successful reduction of the scheme to practise, and that which allows the inventor to secure indefinite retention of his legal claim—by the equally simple expedient of so wording his claims that the examiner will be sure to object, taking two years to frame another objectionable claim, repeating this process, until the time is ripe for gathering in a profit—will be remedied whenever the committees of Congress choose. The few defects in the existing system are capable of instant remedy and its excellent features far outweigh its faults. That the Congress, the Commissioner, the public and especially the patent attorneys permit defects to remain is unfortunate; but it remains nevertheless the fact that we have the best system of patent-law yet produced and that it has done much and is still doing much to stimulate invention, to promote the efficiency of manufactures and to give prosperity to the country and to its average citizen. No more important duty lies with the legislative branch of the Government than that of sustaining and perfecting this code.

The Commissioner reports annually to the Congress. In the report before us he states the total receipts for the year 1900 at \$1,350,828.53, the expenditures \$1,260,019.62 and the profits for the year as the balance, \$90,808.91.

The Patent Office has always made a profit on its business with the usually poor inventor, and this extortion of money from the greatest benefactor which this country knows in industrial fields has permitted the accumulation of an enormous sum, now reported by the Commissioner as \$5,177,458.55 in the United States Treasury, standing at that figure on the books of the Treasurer to-day. In other words, the poor inventor has contributed not only thousands of millions to the wealth of the nation,

and placed the United States in the forefront of nations; but he has been compelled to spend practically all that he has received, in the average case, in the introduction of his invention—for the average inventor lives and dies poor, spending every dollar he can earn or borrow in promotion of his ideas and inventions—and he has, meantime, contributed over five millions of dollars to the treasury of the wealthiest nation on earth while giving that nation's inconceivable advantage and position.\*

It would seem that the inventor may well claim that he is treated with unconscionable inequity and ingratitude; but the depth of that inequity and ingratitude is not yet sounded. He has deposited in the United States Treasury, out of a painfully-earned pittance, in the course of a century, in the small contributions made by thousands of patentees, \$5,000,000; which sum is definitely pledged by the nation to the purposes of the Patent Office and of the inventor for whose benefit it is in part established. Meantime, the Patent Office has been for years painfully crowded, its work seriously impeded and its employees have suffered, as well as the inventor and the industries of the country, through lack of proper provision for its work and of suitable space for its collections, papers and models, and its library, all of which are in constant danger from fire. Other divisions of the Department of the Interior have been for years past squatting in its territory and occupying valuable and needed space, belonging to the Patent Office and in its own building, while five millions of dollars belonging to it and the inventor are hoarded in the United States Treasury with its hundreds of millions surplus, and its use withheld either for constructing a new and suitable fire proof building—the proper course—or for relieving the existing embarrassment in other ways. Truly 'Republics are ungrateful'!

During the year 1900, over forty thousand patents were applied for and nearly six thousand

\* This reminds one of the action of a Legislature of the State of New York which compelled Ezra Cornell to pay \$25,000 for the privilege of endowing the Land-Grant College of that State with \$500,000 and 200 acres of land to be succeeded later by millions of dollars from Cornell, Sage, Sibley, White and others.

and caveats, trade-marks and designs. Twenty-six thousand patents were issued and twenty-one thousand expired. New York heads the list with 3,788 patents and Pennsylvania and Illinois follow with 2,564 and 2,439; but Connecticut leads in inventiveness; securing one patent to every 1,203 inhabitants; although the District of Columbia is reported to have one to each 1,110. The latter is of course not precisely comparable with the States; the patents being often taken out by immigrants, coming to the capital for the purpose, or by residents uniting with the inventor in application for the patent. About one in 1,500 New Englanders takes out a patent each year. The average for the country is about one patent in the year for each four thousand inhabitants. The 'Yankee' is about twenty times as inventive as the South Carolinian. Women have about one patent in each 1,000. The number of patents issued has of late years been nearly stationary at about 22,000; growth having apparently practically ceased about fifteen years ago.

Inventors complain that the law and the administration, and especially the courts, have recently often been inclined to bear hardly upon the man who provides the people with their main instrument of prosperity. Certain States are well known among patentees as dangerous, through their adverse court-decisions, and the United States District Courts and even the Supreme Court of the United States are sometimes thought too indifferent to the rights of the inventor and of the people in this direction. It is, however, hardly possible for a court to invariably exhibit the knowledge or the judgment of the expert in the field of mechanics, and the famous decision of the latter court, when it was decided in the great Sickels-Corliss case that a latch is not a catch and that a dash-pot and another dash-pot are not equivalent, must be expected to be occasionally paralleled. Something should be done, however, to restore to the inventor that consideration which was formerly his and which has of late been in some degree lost to him, in part perhaps, through familiarity with his work and through the very extent and universality of his beneficence.

As to the standing wrong—refusal to prevent



the use of his own funds for the construction of a suitable government building for his benefit, in which fire-proof construction shall insure the safety of invaluable records and where ample space and every convenience shall insure prompt attention to his business—the senior senator from Virginia has recently admirably stated the case :

“Other nations have surpassed us in literature and the fine arts, but in inventive and useful arts the United States is far transcendent. The Patent Office, established by Thomas Jefferson and protecting for a brief period the only constitutional monopoly, the right to the exclusive enjoyment of one’s original ideas, is the crown of American intellectual supremacy over the material world, even as the Constitution of the United States is the crown of political architecture and the Union itself the crowning glory of our people.

“As Francis Bacon says, ‘The sciences dwell sociably together,’ and we should put our Capitol Hill, facing the Senate Hall, as a companion piece to the exquisite Library building now facing the Hall of Representatives, another building of like architecture. And the American capitol of letters should have by its side the American capitol of inventive art, both facing the Capitol of the people, where their sovereignty has its highest exemplification. In that hall should be displayed the evolutions of inventions, with every invention indicated by its model, inclusive of the last improvement. It would be the greatest college of applied science that the world has ever seen; a monument to and a stimulus to invention, and leading by gradations to those truths of science which hover over the threshold of the age, ‘waiting to be caught.’”

R. H. THURSTON.

*Photographic Optics.* By OTTO LUMMER, Professor, Assistant in the Reichsanstalt, Berlin; translated by Professor S. P. THOMPSON, London, Macmillan & Co.

A very complete and concise treatment of the theory of the modern photographic objective, with a full exposition of von Seidel’s theory of aberration. The subject as a whole is rather deep for the general reader, though portions of

the book cannot but help interest any who desire to know more about the various modern objectives; though they may not be able to penetrate the mysteries of the five different kinds of spherical aberration, and two chromatic aberrations which are taken into account in the computation of the complicated optical systems in use at the present time, they will find much of interest. A perusal of the book will at least give the photographer a respect for, and appreciation of his instrument far greater than can be had by the inspection of a few negatives and a glance at the optician’s bill. A photographer should at least know as much about his lenses as an engineer knows about his engine, and yet how few can tell why the stop is placed in front of the lens-system in some cases and between the lenses in others, and to how many is a Zeiss ‘Planar’ anything more than a lot of pieces of glass stuck together and mounted in a brass tube. To the optician the book will be invaluable, it being practically the only work on the subject extant. R. W.

*Geometrical Optics.* By R. A. HERMAN, Fellow of Trinity College, Cambridge. Published at Cambridge by the University Press.

This book covers about the same ground as Heath’s well-known work, which it resembles in some respects. The author has adopted a geometrical method instead of the usual analytical method in his treatment of refraction by coaxial surfaces and aberration, and makes use of the reduced path rather than the characteristic function in discussing Maxwell’s theorems.

R. W.

DR. GRAY’S FAMILIAR TALKS ON SCIENCE.

A SERIES of little books, entitled ‘Nature’s Miracles or Familiar Talks on Science’ (Fords, Howard and Hurlbut), has been published by Dr. Elisha Gray, and the third volume on ‘Electricity and Magnetism’ appeared shortly before his death, which occurred in January of the present year. Dr. Gray was unquestionably one of the prominent inventors who contributed his share to the very remarkable progress of electrical science and its application during the past thirty years. The claim often made for him that he was the inventor of the telephone is not justified by the

decisions of the courts. His work in connection with the harmonic telegraph, a very interesting invention which belongs to him, led him to an understanding of the principles underlying the telephone, and the caveat which he filed in the patent office showed that he was very close to the realization of his ideas in this direction. Nevertheless, the fact that Mr. Bell had shown and described an apparatus capable of actually transmitting speech and one which survives to-day as the receiving instrument, gave him a more positive claim which, in connection with other technical and legal facts, resulted in a final decision in his favor. The telautograph, like the harmonic telegraph, has not yet become of great practical value, although both are ingenious and beautiful devices. It would seem that Dr. Gray had been most unfortunate with his inventions in spite of his natural genius. It was not due, however, to lack of mental clearness or grasp, but more likely resulted from insufficient business ability. The books which he has recently written reflect very faithfully the mind of the man. To him science was not abstruse or formal, but a familiar, matter-of-fact and attractive subject. In a clear and picturesque style, he treats the principles and applications of electricity as well as other branches of science. These books could be understood sufficiently to be interesting even by the least technical of readers. On the other hand those well acquainted with the subjects would find at least a new point of view. It is notoriously difficult to write a really satisfactory scientific book of an elementary character. This inherent difficulty is magnified by the fact that most persons who undertake it are not masters of their subject. No such criticism can be made of Dr. Gray, and the lucidity of his ideas and his language are adapted to the task. The writer was well acquainted with Dr. Gray personally and knew his great enthusiasm for science, which is another quality necessary in the writer of an elementary work, in order to inspire his readers who are beginners or those who have comparatively little taste for such matters. For these reasons the series of books that Dr. Gray has written are to be recommended as interesting and instructive to the general or even casual

reader, but they are too conversational for use as text-books, except perhaps to supplement other more formal works.

F. B. CROCKER.

COLUMBIA UNIVERSITY.

March 6, 1901.

BOOKS RECEIVED.

- Hygiene and Public Health.* LOUIS PARKES and HENRY KENWOOD. Philadelphia, P. Blakiston's Son & Co.; London, H. K. Lewis. 1901. Pp. xix + 732.
- The Agricultural Experiment Stations in the United States.* A. C. TRUE and V. A. CLARK. Washington Government Printing Office. 1900. Pp. 636.
- Experimental Psychology, a Manual of Laboratory Practice.* EDWARD BRADFORD TITCHENER. New York and London, The Macmillan Company. 1901. Pp. xviii + 214.
- The Human Nature Club.* EDWARD THORNDIKE. New York, London and Bombay, Longmans, Green & Co. 1901. Pp. vii + 235.
- Practical Organic Chemistry.* JULIUS B. COHEN. New York and London, The Macmillan Company. 1899. Pp. xiii + 200.
- Practical Gas-Fitting.* PAUL N. HASLUCK. London, Paris, New York and Melbourne, Cassell & Company, Limited. 1900. Pp. 160.
- A Manual of Elementary Science.* R. A. GREGORY and A. T. SIMMONS. New York and London, The Macmillan Company. 1901. Pp. viii + 429.
- The Industrial Revolution.* CHARLES BEARD. New York, The Macmillan Company. 1901. Pp. x + 105. 40 cts.

SOCIETIES AND ACADEMIES.

BIOLOGICAL SOCIETY OF WASHINGTON.

THE 336th regular meeting was held on Saturday evening, March 9th.

C. W. Stiles presented a note on a recent visit to Texas, whither he had been called to investigate a disease of cattle ascribed to the presence of a parasite in the lungs. He had discovered that the disease was really due to a parasite of the genus *Strongylus* which infested the fourth stomach of the animals infected.

Barton W. Evermann read a paper on 'The Feeding Habits of the Coot and other Water Birds,' based upon observations made at Lake Maxinkuckee, Indiana, by Dr. Evermann and Mr. H. Walton Clark. In 1899 the observations

covered the period from July 1st to October 18th, and in 1900 they began July 1st and have been continued up to date.

Many very interesting observations were made regarding the feeding and other habits of the coot and numerous species of ducks. The paper was devoted chiefly to the coot, the habits of which, at this lake, were found to differ widely from most of the published records of its life history.

It was found that the coot is quite as aquatic in its habits as are most ducks; it swims freely and easily in all parts of the lake. It dives regularly and gracefully when feeding, and in water as deep as twenty-five feet, though its usual feeding grounds were in water four to eighteen feet deep. The longest time any individual was observed to remain under water was sixteen seconds in water ten to twelve feet deep. In deeper water the time was doubtless longer, but could not be definitely determined.

The choice food in September and October was the modified stolons or winter buds of the wild celery (*Vallisneria spiralis*), but later other parts of this plant, and other plants (among them *Myriophyllum verticillatum*, *Potamogeton pectinatus* and other *Potamogetons*) were utilized. When feeding, which it does at all hours of the day and night, it is not taciturn, as stated by Nuttall, but very sociable and loquacious, constantly talking to its associates day and night; as an article of food the coot is superior to many species of ducks.

Mr. Clark is continuing his observations at Lake Maxinkuckee during the winter and spring, and doubtless other interesting facts will be discovered.

Under the title, 'More about the Cocconut,' O. F. Cook continued the argument brought forward in a previous paper that the cocconut palm is an American and not an Asiatic or Malayan species, and that its original habitat is not to be sought on the sea-coast, but in the mountains of Colombia, where it has been reported far inland. It is apparently unable to establish or maintain itself in competition with the usual floras of tropical coasts, and its general dissemination and present range are believed to be the result of human agency. The prehistoric distribu-

tion, the Malayo-Polynesian names, and the uses attaching to the cocconut, the sweet potato and other economic plants of American origin, suggest the probability of a very early westward migration of a primitive culture-race.

A. H. Howell gave some 'Notes on the Distribution and Nomenclature of North American Skunks,' recognizing seventeen species and subspecies and showing specimens illustrating their color variations. Several important changes in nomenclature were referred to, the details of which will be given in a revision of the group about to be published by the Biological Survey of the Department of Agriculture.

F. A. LUCAS.

#### CHEMICAL SOCIETY OF WASHINGTON.

THE 124th regular meeting was held on February 14th. Dr. H. Carrington Bolton, the retiring president, addressed the Society on the subject 'Physics and Faith.' (SCIENCE, XIII., 320.)

The following papers were then presented: 'The Solubility of Gypsum in Aqueous Solution of Sodium Chlorid,' by F. K. Cameron. This paper was a description of the continuation of investigations along this line previously reported by the author. It was found that the solubility curve presented a maximum point even when calculated on the basis of a given mass of solvent instead of a given volume of solution. A discussion together with the results of experiments was given on the nature of the hydrate of calcium sulfate in the solid phase in contact with certain solutions. A theoretical discussion of the results was presented, and some practical applications pointed out.

'Equilibrium between Carbonates and Bicarbonates in Aqueous Solution,' by F. K. Cameron and L. J. Briggs. The curves showing the distribution of the base between the two salts for solutions in equilibrium with ordinary air were shown. For solutions of the salts of sodium, potassium, or magnesium, as infinite dilution is approached, the bases are all combined as hydrogen carbonates. As the total concentration increases, the percentage of base combined as normal carbonate increases rapidly to a certain point, then asymptotically

and as the solutions approach high concentration, there is again a falling off showing the existence of maximum points on the curves. Solutions of calcium salt contain so little normal carbonate when in equilibrium with air, that practically they may be considered as containing only the hydrogen carbonate. With rise of temperature in all cases, there is an increase in the proportion of normal carbonate in the solution, and at 100° C. all the base is combined as normal carbonate for practically all concentrations. A theoretical discussion accompanied the paper, and practical applications of the results were pointed out.

L. S. MUNSON,  
*Secretary.*

#### PHILOSOPHICAL SOCIETY OF WASHINGTON.

THE 531st meeting was held March 2, 1901. Under the head of informal communications Mr. Farquhar stated that eye observations on the Nova and Perseus showed considerable fluctuations in brilliancy from night to night. Mr. Bauer stated that the Toronto magnetic observations at the time of the Solar eclipse showed a slight disturbance coincident with the passage of the sun's shadow. Analysis shows that this is due to causes outside the earth's crust, and probably due to changes in the upper atmosphere caused by the passage of the shadow.

The first regular paper was a report by Father Hagen on 'Progress in Astronomical Photometry.' It grouped the facts into four classes:

1. *Photometric Catalogues* with regard to brightness and color of stars. Special mention was made of the Harvard Photometry and of Osthoff's catalogue of star colors.

2. *Original Observations of Variable Stars* were mentioned, in particular those published lately by Peck, Knott and Pickering.

3. The *Physical Explanation* of the light variations is advanced by the discovery of coincidence between the light curves and velocity curves in the three variable stars:  $\delta$  Cephei,  $\eta$  Aquilae and  $\zeta$  Geminorum.

4. Various *Charts for Variable Stars*, distributed or published for the convenience of observers, were mentioned, with special reference

to Pogson's charts. This part of the report was illustrated by lantern slides.

The next paper was a report by Mr. Radelfinger, on 'Progress in Pure Mathematics in 1900.' This dealt first with important books, referring to the great Mathematical Encyclopedia now in course of publication, and to Forsyth's 'Differential Equations' in two volumes. A brief historical account of the treatment of the ordinary differential equation from the time of Briot and Bouquet introduced an outline of Painlevé's very recent and successful attack on the equation of the second order: he had discovered three new uniform functions, and completely solved the problem of determining all equations of the second order whose integrals are uniform functions. Painlevé's method promises important results from its application to equations of higher orders.

Professor See's report on the 'Progress of Astronomy in 1900' dealt very briefly with the publication of the results of the observations on the Transit of Venus; the observations on Eros, in which about 50 observatories are engaged; the discovery of several hundred double stars, and the publication of double-star catalogues; The observations at the Naval Observatory of planetary diameters with a color-screen; and Rees's new determination of the constant of observation, which he finds to be 20".464.

CHARLES K. WEAD,  
*Secretary.*

#### GEOLOGICAL SOCIETY OF WASHINGTON.

AT the 111th meeting, held on February 27, 1901, at the Cosmos Club, the following papers were presented:

*Memorial of Thomas Benton Brooks*: MR. BAILEY WILLIS. (Published in SCIENCE March 22.)

*Morphogeny of Southern Alaska*: MR. G. K. GILBERT.

*Mountain Structure in the Trans-Pecos Province of Texas*: MR. ROBERT T. HILL.

The last two papers were illustrated by lantern slides.

F. L. RANSOME,  
DAVID WHITE,  
*Secretaries.*

SECTION OF GEOLOGY AND MINERALOGY OF  
THE NEW YORK ACADEMY OF SCIENCES.

At the meeting of the Section on February 18, 1901, the following program was presented:

'The Granite of Barre, Vermont,' by George I. Finlay. The speaker described the occurrence of the granite as a single intrusion through the country rock, which is a biotite schist, in the southeastern portion of Barre township. Many inclusions of the schist are found in the granite, and this rock has almost surrounded other masses of the schist which remain in place, with their original strike and dip unchanged. The speaker employed a series of original lantern views to illustrate the character of the jointing, the 'onion structure,' and the zones of shearing, together with certain large systems of joints, standing at right angles to each other, resulting from pressure. Microscopic examination shows that the granite consists of microcline and orthoclase, plagioclase, in very small amounts, quartz, biotite and muscovite, with occasional crystals of apatite and magnetite and rarely pyrite. Variations in the shade of the marketable granite, from very light to very dark gray, are due to the relative amounts of biotite which it contains. The rock is of medium grain and its constituent minerals are but slightly weathered. Pegmatitic offshoots, traceable directly to the granite mass were recorded by Mr. Finlay, and their dynamic effects on the enclosing schists were illustrated. The contact metamorphism of the schist is inconsiderable. It is chiefly shown in the greater abundance of biotite and quartz in the immediate vicinity of the granite. Two dikes of augite-camptotonite were found; one in the granite, the other in the country-rock. They are notable for the manner in which they have weathered. At times sixteen successive shells may be counted which are ready to break away from the main mass of the dike. Mention was also made, in discussing the glacial geology of the region, of sand plains and of two well developed eskers.

The paper was discussed by Professors Kemp and Dodge and Drs. Julien and White.

'Note on a Sand Fulgurite from Poland,' by

A. A. Julien. Dr. Julien exhibited a specimen of Fulgurite formed from sand, in Poland, with a series of micro-photographs which he had made from the same. Some new features in fulgurites were pointed out in this specimen: pustules of glass on the inner lumen, glass-fibers on the exterior, and adhering sand-grains, two-thirds of which consist of orthoclase. In the thin cross-section, examination of the minute gas-cavities showed the absence of condensed water-vapor, and this indicated a dilatation of both lumen and cavities by air, more than by steam. The radial arrangement of layer cavities, the hornlike projections on the exterior of the tube, and the pustules along the lumen were all shown to be connected with relief of intense pressure outwardly during the electric discharge, or inwardly during the reaction after its passage. This fulgurite is of further interest in presenting the first instance yet observed of devitrification, the glass being generally filled with delicate crystallites, apparently of feldspar. All the bubbles, however, are enclosed in pellicles of homogeneous glass, and some of the larger within a coating of suddenly chilled glass, which is free from crystallites. The relation of these facts was discussed in reference to Lagorio's view as to the difficult saturation of a magma by the constituents of feldspar.

Other occurrences of fulgurites were discussed by Drs. Kemp, Levison and White.

THEODORE G. WHITE,  
*Secretary.*

THE MINNESOTA ACADEMY OF NATURAL  
SCIENCES.

THE February meeting of the Academy was addressed by Professor N. H. Winchell and Mr. Warren Upham on the following topics, respectively: 'The Retreat of the Ice Margin Across Minnesota' and 'Giants' Kettles in the Interstate Park, Taylor's Falls.'

Professor Winchell called attention to the general topography by means of a map of the State divided into three areas, viz.: Those areas above 1,400 feet, those between 1,400 and 1,300 feet, and those below 1,300 feet, remarking that, as the ice must have slowly encroached, in the form of glaciers, in the low-

lands, so it must have left the State last in the lowlands. That necessitated the two great ice-lobes, one from the north and northwest and one from the northeast. The former occupied the basin of the Red river of the North and the Minnesota valley, and the latter the valley of Lake Superior with its western tributaries. These at length united in one general ice sheet, but when they retired they assumed again their lobate forms outlined by moraines, and finally allowed an uncovered interlobate area of the high lands about the region of the Upper Mississippi. By the growth of this uncovered area the ice lobes shrank to smaller dimensions and disappeared entirely, the latest to finally leave the State being the northeastern lobe.

The belt along which these ice lobes collided in the central part of the State can be traced by the overlapping and confusion in the characters of the drift, the northwestern drift being normally gray and the northeastern red. This belt be marked out in general as continuing from Rice county to St. Paul, thence north-westwardly to the region of Itasca lake where it turns eastward, passes along the range known as Giant's range, and leaves the State not far from the extremity of Pigeon point. Wherever these ice-lobes uncovered land that slopes northerly, or toward the ice itself, the discharged waters formed lakes whose outlets, beaches and areas are sometimes well known, the chief of which is Lake Agassiz, described by Mr. Warren Upham. Twenty-five other such lakes were defined by Professor Winchell within Minnesota, varying in elevation from 890 feet to 1,700 feet above sea level.

Mr. Upham, in his lecture on 'The Giants' Kettles in the Interstate Park,' stated in substance that within an area of two or three acres in the northern part of the Interstate Park are found about seventy rock potholes, or giants' kettles, as they may be called in agreement with their common designation in the languages of Germany, Sweden and Norway. This area of their abundant occurrence is unsurpassed in respect to their numbers, depth and difficulty of explanation, by any other locality in the world, although many places, as in Maine, nearly all the other New England States, the vicinity of Christiania, Norway, and

the Glacier Garden in Lucerne, have very remarkable giants' kettles.

At Taylor's Falls they range in diameter from a foot or less to 25 feet, and in depth from one foot or a few feet to 65 feet and 84 feet, these being the depths to which two potholes 25 feet apart have been excavated and sounded, but without yet reaching to their bottoms. In many cases the ratio of diameter to depth is as 1 to 5 or 1 to 7 with nearly cylindrical, but occasionally somewhat spiral or rifle-like, form. The rock is the very hard Keweenaw diabase, scarcely exceeded in hardness by any known rock. From many features of these giants' kettles, as notably their abrupt rims and the generally unworn adjoining rock surface, Mr. Upham attributed their erosion to torrent-falling through moulins, vertical shafts of the ice sheet which covered this region in the Glacial period. Some of these kettles were filled and covered by drift, but the greater number are empty, excepting scanty gravel at the bottom, with a few water-rounded boulders. The adequacy of moulin torrents to erode the smaller as well as the larger kettles is shown by small potholes of such origin, in some instances only about a foot or two in diameter and depth, on the high ridges and tops of hills and mountains in Maine, New Hampshire and Vermont.

The above is but a brief summary of these two very instructive lectures which were delivered to a large audience in the Academy Assembly Hall.

F. G. WARVELLE.

#### SHORTER ARTICLES.

##### CHIASMODON IN THE INDIAN OCEAN.

THE Indian government survey steamer *Investigator*, Captain T. H. Henning, R. N., commanding, which has recently been engaged in beam-trawling off Cuddalore and Point Calimere on the southeast coast of India, has obtained a small specimen of the rare deep-sea fish, *Chiasmodon niger* Johnson, from a depth of 1,100 fathoms.

This species has hitherto been known only from four localities in the Atlantic. It was first reported from the Madeira Islands in 1850,

but not fully described until 1863, when Johnson obtained another specimen in that locality. Two other specimens have since been found at the surface (near the island of Dominica and on the Lehave Bank). The *Challenger* took another with the trawl at a depth of 1,500 fathoms in the mid-Atlantic.

*Chiasmodon* is remarkable for its large mouth and distensible stomach, enabling it to swallow fishes larger than itself. For most of the foregoing specimens, naturalists are indebted to the inability of the fish to digest what it swallows, resulting in its death and appearance at the surface.

H. M. SMITH.

U. S. FISH COMMISSION, WASHINGTON, D. C.

#### THE SAN JOSÉ SCALE PROBLEM AS COMPARED WITH THE ORANGE SCALE PROBLEM.

I was much interested in the communication of Professor Kellogg in the issue of *SCIENCE* for March 8, 1901. Of course the practical value of Mr. Kuwana's investigations is in the increased probability of our being able to import from Japan the natural enemies of the San José scale, and thus control the pest here, as was done in case of the *Icerya*. It is, therefore, of interest to see where we now stand in the matter of information, on which to base a second experiment in importing into this country parasitic enemies of scale insects. I copy the following lines from Professor Kellogg's communication:

\*\*\* "It the [San José scale] is attacked by several enemies, Mr. Kuwana personally finding one chalcid, three lady-bird beetles and one moth, the larva of which feeds on the scale. Of these enemies the chalcid fly and one of the lady-bird beetles are everywhere common, and are effective checks to the increase of the scale. It is probable that the comparatively little injury produced by the scale in Japan, widespread as it is, is due to the presence of these natural enemies." \*\*\*

By the side of this information may be placed the following, extracted from the Adelaide, South Australia 'Garden and Field' of November, 1887, by the late Mr. Frazer S. Crawford, who, from first to last, gave such efficient aid in bringing about the introduction of the *Vedalia* lady beetle that suppressed the Orange scale in California.

\*\*\* "We have a few species of Coccinellidae

about Adelaide, but they are not very plentiful, and although one or more species attacks the *Icerya*, yet they are not very effective in keeping them under, as the following experiment proves. Three months ago I put in a glass bottle a small branch of a gooseberry tree, on which some forty or fifty adult *Iceryas* were clustered. On examining them subsequently I discovered two lady-bird larvæ, which have lived to the present time feasting on the *Icerya*, evidently contented with their quarters; but at the present time there are likewise a great number of young larvæ, lately hatched, running about, thus showing that the work of destruction has been very slow, and that even under such favorable circumstances the coccinellid larvæ cannot cope with the productive power of the *Icerya*. Strange to say, a similar twig, covered with about the same number of adult females, was about the same date placed in a lemon tree, and a fortnight back every vestige of *Icerya* had disappeared. This clearance was gradual, but what has caused it I am at a loss to say." \*\*\*

It must be remembered that this was written one year prior to Mr. Keohes starting for Australia on his first trip. It will thus be seen that Mr. Kuwana has thrown a flood of light upon this problem which I can only look upon as very similar to the one in which *Icerya* was involved, and afterwards so effectually solved. As I read of the conditions of the San José scale in Japan, as relating to numbers and effect, it seemed to coincide exactly with the mental picture that I could not banish from me when I went over some infested nursery stock two or three years ago, just received direct from Japan. While I had practically nothing to do with the introduction of the *Vedalia*, I did examine many orange groves about Adelaide, South Australia, for the *Icerya* and found a similar condition—only here and there a solitary individual, at most two or three together.

We can make a *defensive* fight against the San José scale with whale oil soap, petroleum, the axe and fire, in fact we must do so, in order to save our orchards from ruin; but we shall never be able by these measures to do more than check the pest. If we ever expect to do more than this we must make an *offensive* fight and with natural enemies brought from the country where they are found doing their work and holding this pest perpetually below the danger line in point of numbers.

F. M. WEBSTER.

WOOSTER, OHIO, March 12, 1901.

NOTE.—Since the above was written, Dr. Howard informs me that Mr. C. L. Marlatt sailed for Japan on March 5th, his mission being to collect and forward such natural enemies of the San José scale as he may find in that country.

F. M. W.

#### CURRENT NOTES ON METEOROLOGY.

##### CLIMATE OF ARGENTINA.

ONE of the most important publications on climatology issued in recent years is buried in the second census of the Argentine Republic (Buenos Aires, 1898. Tomo I. Cuarta Parte. *El Clima de la República Argentina*, por Gualterio G. Davis. Pp. 259-381). This monograph is printed with a mass of other material in the volumes of the Argentine Census. No reprints of it have been struck off and it has so far practically escaped notice. Mr. Walter G. Davis, who is well known as the Director of the Argentine Meteorological Office, has in this report given an admirable presentation of the chief climatic features of Argentina, and has included a series of isothermal, isobaric and isohyetal charts which are of unusual interest. The interest of Argentina from a climatological standpoint is chiefly due to the great extent of that country from north to south. On the north it extends just beyond the Tropic of Capricorn; on the south it reaches latitude 55°. The differences in the temperature and rainfall conditions over this extended territory are naturally very striking, and profoundly affect the natural products of the Republic and the occupations of its inhabitants. All the important climatologic elements are tabulated and discussed, and many excellent graphic representations are given, showing the correlations between the various elements at certain selected stations. But the most important matter in the report is the series of charts showing the distribution of temperature, pressure and rainfall. The data used are the latest, the most complete and the best obtainable. There are isothermal charts for spring, summer, autumn, winter and for the year (reduced to sea-level and without reduction to sea-level); isobaric and wind charts for the seasons and for the year, and a mean annual rainfall chart. These charts show, for

the first time, the distribution of these various elements over the southern portion of South America, in detail, and on the basis of reliable data. The extraordinary decrease of pressure to the southward is perhaps the most striking feature shown on these charts. In each season, as well as for the year, the isobars in the southern part of the Argentine run closely parallel, almost due east and west. Mr. Davis's report is altogether an extremely valuable piece of work, which should certainly be reprinted and made generally available for the use of students of climatology.

##### MONTHLY WEATHER REVIEW.

THE November number of the *Monthly Weather Review* is particularly strong in papers dealing with climatological subjects. W. H. Alexander, Observer of the Weather Bureau on the island of St. Kitts, contributes an article on the 'Rainfall of the Island of St. Kitts, W. I,' in which the effects of topography upon the amount of precipitation are clearly brought out. 'The Climate of Spokane, Wash.,' is discussed by Charles Stewart on the basis of eight years' records. A. G. McAdie contributes another paper on 'Fog Studies on Mount Tamalpais' (Cal.), which is illustrated by four excellent half-tones, the original photographs having been taken from the U. S. Weather Bureau Observatory on Mt. Tamalpais. The Section Directors of Colorado, Idaho, Montana, New Mexico, Utah and Wyoming discuss the question of 'The Water Supply for the Season of 1900 as Depending on Snowfall.'

##### NOTES.

THE *Monthly Review of the Iowa Weather and Crop Service* for December contains a paper on 'Climatology of Iowa,' by J. R. Sage, read before the State Horticultural Society, Dec. 13, 1900, and a discussion of the 'Losses by Hailstorms in 1900.' A table prepared by the officials of the Farmers' Mutual Hail Insurance Association shows that an aggregate of 2,202 farms, in 64 counties, suffered damage to the amount of over \$140,000.

THE *Metecorologische Zeitschrift* for December contains an excellent brief summary, by Exner, of recent contributions to the study of atmos-



pheric electricity. A bibliography accompanies the article (Ueber neuere Untersuchungen auf dem Gebiete der atmosphärischen Elektrizität).  
R. DEC. WARD.

#### YELLOW FEVER.\*

1. Sufficient search reveals the presence of a fine small bacillus in the organs of all fatal cases of yellow fever. We have found it in each of the fourteen cadavers examined for the purpose. In diameter the bacillus somewhat recalls that of the influenza bacillus; seen in the tissues; it is about  $4\mu$  in length.

2. This bacillus has been found in kidney, in spleen, in mesenteric portal and axillary † lymphatic glands, etc., taken from yellow fever cadavers directly after death. In the contents of the lower intestine apparently the same bacillus is found often in extraordinary preponderance over other micro-organisms. Preparations of the pieces of 'mucus,' which are usually, if not always, present in yellow fever stools, at times may almost present the appearance of 'pure culture.'

3. Preparations of the organs usually fail to show the presence of any other bacteria, whose absence is confirmed by the usual sterility of cultivation experiments.

4. It is probable that this same bacillus has been met with, but not recognized by three other observers. Dr. Sternberg ‡ has mentioned it; and he has also recorded the finding of similar organisms in material derived from Drs. Domingos Freire and Carmona y Valle; but he did not recognize its presence frequently, probably on account of the employment of insufficiently stringent staining technique.

5. It is probable that recognition has not been previously accorded to this bacillus by reason of the difficulty with which it takes up stains (especially methylene-blue), and by reason of the difficulty of establishing growths on artificial media.

\* Abstract of interim report by Herbert E. Durham and (the late) Walter Myers to the Liverpool School of Tropical Medicine.

† We find these constantly enlarged and much injected, though whether this is specific we are not able to say.

‡ Report on *Etiology and Prevention of Yellow Fever*, 1890.

6. The most successful staining reagent is carbolio fuchsin solution (Ziehl), diluted with 5-per-cent. phenol solution (to prevent accidental contamination during the long staining period) immersion for several hours, followed by differentiation in weak acetic acid. Two hours staining period may fail to reveal bacilli, which appear after 12 to 18 hours. The bacilli in the stools are often of greater length than those in the tissues, and they may stain rather more easily; naturally the same is true of cultures.

7. Since the bacilli are small and comparatively few in numbers they are difficult to find. To facilitate matters at our last two necropsies (14th and 15th) a method of sedimentation has been adopted. A considerable quantity of organ juice is emulsified with antiseptic solutions, minute precautions against contamination and for control being taken; the emulsion is shaken from time to time and allowed to settle. The method is successful and may form a ready means of preserving bacteria-containing material for future study. The best fluid for the purpose has yet to be worked out; hitherto normal saline with about one-fifth per cent. sublimate has been employed.

8. Pure growths of these bacilli are not obtained in ordinary aerobic and anaerobic culture tubes.

9. Some pure cultures have been obtained by placing whole mesenteric glands (cut out by means of the thermo-cautery) into broth under strict hydrogen atmosphere. Investigations into the necessary constitution of culture media for successful cultivation are in progress.

10. Much search was made for parasites of the nature of protozoa. We conclude that yellow fever is not due to this class of parasite. Our examinations were made on very fresh organ juices, blood, etc., taken at various stages of the disease, with and without centrifugation,\* and on specimens fixed and stained in appropriate ways. We may add that we have sometimes examined the organs in a fresh state under the microscope within half an hour after death.

11. The endeavor to prove a man-to-man

\* We have found this sometimes useful in examining the blood of ague patients.

transference of yellow fever by means of a particular kind of gnat by the recent American Commission is hardly intelligible for bacillary disease. Moreover, it does not seem to be borne out by their experiments, nor does it appear to satisfy certain endemological conditions. It is proposed to deal more fully with the endemology and epidemiology of the disease on a later occasion.

12. We think that the evidence in favor of the etiological importance of the fine small bacillus is stronger than any that has yet been adduced for any other pretended 'yellow fever germ.' At the same time there is much further work to be done ere its final establishment can be claimed. The acquisition of a new intestinal bacterium would explain the immunity of the 'acclimatised.'\*

#### THE NEW STAR IN PERSEUS. †

THE first news of Anderson's discovery of a new star in *Perseus* was received at this Observatory on February 24th. An examination of the region near the star, made that evening with the 40-inch telescope, failed to show any evidence of nebulosity, but the bright moonlight would have rendered a faint nebula invisible. At that time the magnitude of the star appeared to be about 0.5. Its color was yellow, with a decided reddish cast, very similar to that of *α Orionis*. Very little time was spent in examining the spectrum visually, as it was felt that photographs would be more valuable than drawings based on micrometer measures. We had fortunately just received a fresh supply of Erythro plates through the kindness of the International Color Photo Company of Chicago, and it was therefore possible to photograph the entire spectrum from *H<sub>α</sub>* to *H<sub>γ</sub>*. Beyond this point in the ultra-violet the absorption of the 40-inch objective greatly enfeebles the spectrum, which is still further weakened by the lack of perfect achromatism in this region.

\*The completion of the interim report, of which this is an abstract, was interrupted by the onset of attacks of yellow fever in both of us. The loss of my much-lamented colleague renders it advisable to submit the shortened report only for the time being.—H. E. D.

† From Bulletin No. 16 from the Yerkes Observatory of the University of Chicago.

Photographs of the spectrum were obtained by Mr. Ellerman on February 24, 25, 26, 27 and 28, March 4, 6 and 11. The comparison spectra which appear on these plates are those of titanium, hydrogen and sodium.

On February 24th and 25th Mr. Ritchey photographed the region of the *Nova* with the 40-inch telescope and color screen. In order to obtain a sufficient number of comparison stars the plates were given an exposure of one hour. The light of the *Nova* was intercepted by a small movable occulting disk, with which four (for the second plate, five) very brief exposures were given at intervals of about fifteen minutes. The total exposure for the *Nova* was probably about half a second. In the resulting photographs, the images of the *Nova* and the neighboring stars (of which more than forty appear in a region 12' square) are small and appear to be well adapted for measurement. Through the kindness of Director Rees, these plates will be measured at the Columbia College Observatory. The position of the *Nova* was measured micrometrically by Professor Burnham on March 3d.

The wedge photometer used with the 40-inch telescope in the determination of standards of faint stellar magnitude has been employed by Mr. Parkhurst in measuring the brightness of the *Nova*. Hitherto objectives of one and two inches aperture have sufficed, but as the *Nova* decreases in brilliancy it will be followed with the 12-inch and 40-inch telescopes. A preliminary reduction gives the following magnitudes:

Date.	Mag.
1901, Feb. 25	1.0
" " 26	1.1
" " 27	2.0
" " 28	1.9
" Mar. 3	2.7
" " 4	2.8
" " 5	2.7
" " 6	3.1

A photograph of the spectrum (G 440) taken with the one prism spectrograph on February 28th has been measured by the writer. The resulting wave-lengths of the lines and bands, computed by the aid of Cornu-Hartmann formulae, furnished data for attaching a scale to an enlargement of the photograph reproduced in the Bulletin.

Inspection of the photograph will show that the spectrum is very similar to the earlier spectrum of *Nova Aurigæ*. The hydrogen lines, notably C and F, are bright and very broad. The dark lines superposed upon them are probably reversals caused by the absorption of an outer layer of cooler gas at lower pressure.

On the more refrangible side the hydrogen lines are accompanied by dark lines, just as was the case with *Nova Aurigæ*. As Wilsing has shown, this is doubtless due to the great pressure under which the radiation occurs. The bright sodium line has broadened into a band, on which appear the two dark D lines. These appear on the photographs, and are clearly visible in visual observations with a three-prism spectroscope. As the titanium poles were moistened with a weak solution of sodium chloride, the comparison spectrum contains the bright sodium lines. Thus the motion of the star in the line of sight can be measured. Some preliminary determinations indicate that the *Nova* is moving away from the earth at a low velocity.

The helium line  $D_3$  seems to be present as a dark line, lying close to the bright sodium band on the more refrangible side. The bright calcium lines H and K are notable for their great breadth and for the narrow lines of reversal which traverse them. The chief nebular line seems to be present ( $\lambda 5002-5041$ ), and a fainter line or band ( $\lambda 4911-4988$ ) covers the region of the second nebular line. The  $b$  group of magnesium is doubtless represented by the very bright band  $\lambda 5154-5204$ . The green coronal line ( $\lambda 5303$ ) would fall near the more refrangible edge of a bright band in the spectrum of the *Nova*.

Further results, based upon measurements of photographs taken with the three-prism spectrograph, will be given in a subsequent paper.\*

MARCH 12, 1901.

GEORGE E. HALE.

#### SCIENTIFIC NOTES AND NEWS.

PROFESSOR S. W. STRATTON has, in view of his appointment as director of the Bureau of Standards, resigned his professorship in the

\* Note added March 18th. A comparison of photographs taken on March 4th and March 15th, shows

University of Chicago. He will go abroad soon to study similar institutions in foreign countries.

PROFESSOR GEORGE FREDERICK WRIGHT, of Oberlin College, arrived in New York on March 22d, after his geological expedition round the world.

DR. LEON VAILLANT, professor of zoology at the Paris Museum of Natural History, has been elected a member of the Zoological Society of London in the room of the late Alphonse Milne-Edwards.

At the banquet offered to M. Marey, the eminent French physiologist, by the Paris Club Scientia, to which we have already called attention, it was decided to present him with a medal, and a committee for this purpose has been appointed. Subscriptions may be sent to M. Masson, treasurer, 120 Boulevard Saint-Germain, Paris.

THE University of Glasgow will confer, on April 23d, its LL.D. on Dr. A. W. Rücker, secretary of the Royal Society.

DR. G. A. HANSEN, the discoverer of the lepra bacillus, will celebrate his 60th birthday on July 29th, and the occasion will be celebrated by the erection of a marble bust in the Lungegaard Hospital, Bergen, where he discovered the bacillus.

THE Society of Italian Agriculturists has awarded a special honor to Professor Grassi for his services to agriculture by his investigations on malaria.

DR. G. TORELLI, professor of mathematics at Palermo, has been awarded the mathematical prize of the Naples Academy of Sciences.

SECRETARY LONG has called a meeting of the Board of Visitors to the Naval Observatory in Washington on April 9th. The board, it will be remembered, consists of Mr. St. Clair McKelway, of the Brooklyn *Eagle*, President William R. Harper, of the University of Chicago, Professor Edward C. Pickering, of the Harvard College Observatory, Professor Asaph that the dark lines on the more refrangible edge of the bright hydrogen lines continue to increase in sharpness. At first single and rather diffuse, they have become sharply defined double lines. The  $b$  line of magnesium is apparently decreasing in intensity, and the calcium line K is much fainter than before.

Hall, Jr., of the University of Michigan, Professor Charles A. Young, of Princeton University, and Professor Ormond Stone, of the University of Virginia.

CAPTAIN BERNIER was at Ottawa last week with a view to obtaining a grant from the Government for his polar expedition. He has also opened subscriptions in the principal Canadian cities. He estimates the cost of the expedition at \$130,000.

THE amount of new blood on the recently elected Council of the Geological Society of London is not great, being confined to Professor Theodore T. Groom and the Right Reverend J. Mitchinson, D.D. We see that Dr. Mitchinson was elected a Fellow only last year, but he was bishop of Barbados and is now master of Pembroke College, Oxford.

Dr. J. G. ADAMI, professor of pathology at McGill University, will attend the International Congress of Tuberculosis, to be held at London in July. He has been appointed vice-president of the section of pathology and bacteriology.

PROFESSORS ANDREW F. WEST and J. Mark Baldwin, of Princeton University, have been appointed delegates to the Ninth Jubilee of the University of Glasgow.

DR. EDWIN A. BARBER has been appointed secretary of the Pennsylvania Museum and School of Industrial Art and curator of the museum.

DR. ASAPH HALL has resigned from the Board of Managers of the Observatory of Yale University.

IT is reported that the Secretary of the Navy has decided not to order the trial by court-martial of Professor Stinson J. Brown against whom charges were filed by Capt. Charles H. Davis, Superintendent of the Naval Observatory, but has detached Professor Brown from duty at the Observatory and placed him on waiting orders. He will be detailed for duty elsewhere as soon as an assignment can be found. It is also reported that Captain Davis will probably be assigned to the command of a ship in the course of the summer.

MR. FRED J. ALLEN, of Auburn, N. Y., has been nominated by President McKinley as

Commissioner of Patents in the place of Mr. C. H. Duell, who has resigned in order to resume private practice.

KING EDWARD VII. has signified to the President and Council of the Marine Biological Association his pleasure in becoming the patron of the Association.

M. ANTON CARLÉS is making progress with the model for the monument of Pasteur which is to be erected in his native town. In addition to the statue of Pasteur, which is said to be very effective, there is a model personifying science who holds a wreath of laurel towards Pasteur, and another figure of a woman holding two young children who are supposed to have been saved from death by Pasteur's discoveries.

DR. GEORGE PRATT STARKWEATHER, assistant professor of applied mechanics in the Sheffield Scientific School of Yale University, died at New Haven on March 21st. Dr. Starkweather graduated from the Sheffield Scientific School in 1891 and was last year promoted from an instructorship to an assistant professorship. He was only twenty-eight years of age.

DR. GEORGE T. FAIRCHILD, from 1879 to 1897 president of the Kansas State Agricultural College, died on March 16th, in his sixty-second year. He was at the time of his death professor of English Literature at Berea College.

DR. JOHN W. GRIFFITH, for several years senior physician to the Finsbury Dispensary and medical officer of health to Clerkenwell, died recently at Camberwell in his 82d year. He was best known to naturalists as part author of Griffith & Henfrey's 'Micrographic Dictionary.'

THE death is also announced of Mr. W. J. Williams, for many years clerical assistant to the secretary of the Zoological Society of London.

ALEXANDER MACFARLANE, M.A., D.Sc., LL.D., will deliver a course of six lectures entitled 'British Mathematicians of the Nineteenth Century,' at Lehigh University, beginning April 12, 1901. The life and work of the following will be presented in the order named: George Peacock (1791-1858); Augustus DeMorgan

(1806-1871); Sir William Rowan Hamilton (1805-1865); George Boole (1815-1864); Arthur Cayley (1821-1895); William Kingdon Clifford (1845-1879). Those interested are invited to attend. Tickets of admission can be secured by addressing Professor C. L. Thornburg at the University.

THE Newberry Research Fund from the income of funds raised by the Scientific Alliance, New York, has been increased by an addition of \$50 by a gift of a friend of the Alliance. The award this year will amount to \$100 by action of the Council of the Academy and will be made in geology or paleontology. Application should be sent immediately to Professor Henry F. Osborn, Columbia University, New York City.

THE following gentlemen have undertaken to be responsible for the indexing of the literature of Great Britain and Ireland for the International Catalogue of Scientific Literature in the subjects named: *Anatomy*—Professor G. D. Thane, University College, London; *General Biology*—Professor E. A. Minchin, University College, London; *Physiology* (including *Pharmacology*)—Dr. W. A. Osborne, Physiological Laboratory, University College, London, or to Professor W. D. Halliburton, King's College, London; *Experimental Pathology*—Dr. T. G. Brodie, Examination Hall, Victoria Embankment, London, W. C.; *Bacteriology*—Mr. S. G. Shattock, St. Thomas's Hospital Medical School, London, S. E.; *Experimental Psychology*—Dr. W. H. R. Rivers, St. John's College, Cambridge.

THE International Association of Academies will hold a meeting in Paris on April 16th.

THE fifth Triennial International Congress of Physiologists will be held at Turin from September 17th to 23rd in Professor Mosso's laboratory. There will be an exhibition of apparatus from September 14th to 23rd. Americans proposing to attend the Congress can address Professor F. S. Lee, Columbia University, New York City.

THE triennial convention of weather bureau officials will be held at Milwaukee, Wis., on August 27th to 29th.

A CIVIL SERVICE examination will be held on April 23d and 24th for the positions of geologist

and assistant geologist in the Geological Survey for occasional service at a salary from \$3 to \$5 per diem.

ONE of the amendments to the Sundry Civil Appropriation Bill, passed by the fifty-sixth Congress, appropriated \$35,000 for the erection of a laboratory for the investigation of infectious and contagious diseases and matters pertaining to the public health, under the direction of the surgeon-general. Five acres of land, on which is situated the Naval Museum of Hygiene, have been set apart for the building.

THE California Legislature has appropriated \$100,000 for the State Board of Health to be used for the suppression of the plague. The Legislature has also passed a most extraordinary bill making it a felony to publish, by writing or printing, that Asiatic cholera or bubonic plague exists within the State unless the fact has been determined by the State Board of Health and entered upon its minutes. The San Francisco papers have apparently been only too ready to suppress information in regard to the plague in that City, and the passage of a bill of this character at the present time seems almost incredible. It has for a long time been known in medical circles that there have been cases of plague in the Chinese quarters in San Francisco, but the State authorities have denied their existence and have attempted to suppress any information in regard to the epidemic. It appears that Secretary Gage appointed some time since, in spite of the protest of the Governor of California, a commission to investigate the matter. This commission, consisting of Professor F. G. Novy, of the University of Michigan, Professor Simon Flexner, of the University of Pennsylvania and Professor L. F. Barker, of the University of Chicago, has made a thorough investigation and has presented a report which for the present has not been made public. In the meanwhile the Governor of California has sent a commission to Washington to protest against Federal interference, and has recommended a local investigation. It appears that the epidemic in San Francisco is but slight, but it will naturally be exaggerated by attempts to deny its existence for commercial reasons.

GOVERNOR VORHEES, of New Jersey, has

signed the Palisades Park bill and the Appropriation bill which carries an item of \$50,000 to aid in the purpose of preserving the Palisades and in establishing an inter-State park along the top of the bluff on the high rocks.

SECRETARY WILSON has authorized Professor Willis L. Moore, chief of the Weather Bureau, to create three new forecasting divisions, under the general authority of the last appropriation act. These divisions have been selected as follows: New England, headquarters at Boston; Western Gulf States, headquarters at Galveston; and Central Rocky Mountain plateau, headquarters at Denver. This will make a total of seven forecasting divisions in the weather service.

THE steamship *Discovery*, built for the British Antarctic Expedition, was launched on March 21st, from the yards of the Dundee Shipbuilders' Company. We gave last week some account of the ship and the scientific staff of the expedition.

THE following item is from the New York *Evening Post* of March 20th: "Peculiar circumstances surround the case of William Wallace, ex-Superintendent of Buildings at the Museum of Natural History, who resigned by request on January 10th. A lawsuit is under way before Judge Marean in the Kings County Supreme Court, special term, to-day, in which Mr. Wallace is alleged to have borrowed money as an agent of the Museum and appropriated it to his own uses. This money, it is further alleged, was borrowed from the contractors who are at work on the new buildings of the Museum. Work has been stopped because Mr. Wallace is alleged to have made contracts which he had no power to make. In reply to those who associate the facts that Mr. Wallace had borrowed money of the contractors and had then arranged contracts with them, Comptroller Coler, William E. Dodge, and others who are acquainted with the affairs of the Museum maintain a serious silence. The matter has been put in the hands of Edward M. Shepard, and to him each person referred inquirers. Mr. Shepard explained to-day that an investigation into Mr. Wallace's affairs was being made by the Museum authorities. "What you want to know,

I suppose, is Mr. Wallace's exact offence," said Mr. Shepard. "On that subject I cannot talk. The investigation, which will probably take three weeks, will establish that question. If Mr. Wallace has had any wrong doing with the contractors, it is so far a matter between themselves. This I will say, however, that if any contractor has lent money to Mr. Wallace, and then received contracts from Mr. Wallace's hands without the approval of the trustees, I do not think the contractor is in an enviable position, and I do not believe the contract would be legally valid."

WE learn from *Nature* that a small zoological expedition has started for the Malay Peninsula. It consists of Mr. N. Annandale, who was a member of the 'Skeat' expedition to the Siamese Malay States in 1899, and Mr. H. C. Robinson, hon. research assistant in the Zoological Department of University College, Liverpool. They intend to settle for a year in the native State of Jalor, near the east coast of Lower Siam, and to explore the neighborhood of Patani and Biseret. Collections will be made in all branches of natural history, while one of the special objects of the expedition is the study of the pre-Malayan tribes of Negrito stock who inhabit the center of the peninsula. A thorough investigation will also be made of the fauna—both living and extinct—of certain very large limestone caves which are found in the district, and are said to extend for great distances underground. The birds of the district will also be studied, and observations made on mimicry and allied phenomena. The ethnographical work ought to be interesting, since Jalor is on the borderland in which the Siamese and Malay races meet. Mr. Robinson is supplied with dredges and townets for the investigation of the marine fauna, and he proposes, by the method of pumping sea-water through fine silk nets, to make a collection of the surface plankton of the Red Sea and Indian Ocean on the voyage out.

ACCORDING to the New York *Evening Post*, Dr. W. A. Kuflewski, chairman of the Special Committee appointed by the Chicago Public Library Board to consider the advisability of sterilizing the books in the library for the purpose of preventing the spread of disease, re-

ported to the trustees at their meeting on February 18th, recommending that some system be adopted for freeing the pages of the volumes from bacilli. Dr. Kuflewski exhibited several glass tubes filled with germs taken from the pages of library books. The bacilli represented a hundred different poisons and germs of disease. He said that all the fifty books examined by him during the investigation were found to be more or less infected. He said there was no doubt that disease was spread by the books. He advised that a system of sterilizing the volumes by the dry process be adopted immediately.

THE *New York Evening Post* reports that the Hon. John Dryden, Ontario Minister of Agriculture, recently announced in the Legislature that a complete change of policy had been decided upon in regard to the efforts to stamp out the San José scale. It had been found that cutting down infested orchards would prove far too costly to be continued. To continue it would have meant an expenditure of nearly \$500,000 as a partial compensation to fruit growers. The new policy is to educate fruit-growers to destroy the pest without cutting down the trees. Experiments indicated that by systematic work this could be accomplished.

THE collection of mounted birds at the University of Michigan, including nearly fifteen hundred specimens, has been rearranged. The birds that are native of Michigan are in three cases on the east side of the bird room. Those in the case farthest north are birds to be found north of Ann Arbor, those in the middle case birds in the neighborhood, and those in the third case birds living to the south of Ann Arbor. The west side of the bird room is occupied with cases containing specimens from many different parts of the world. These are scientifically arranged. Besides the specimens in the cases, thirty-six bird groups have been arranged. These are mounted in their natural surroundings, often with nest, eggs and young. Each group is a picture of bird life. In addition to the mounted specimens in the bird room of the museum, the University possesses nearly four thousand skius for use in scientific study in the class room.

#### UNIVERSITY AND EDUCATIONAL NEWS.

SIR WILLIAM McDONALD has made another large gift to McGill University, namely \$150,000, for endowments for the chair of chemistry, now held by Professor Harrington, and for the chair of botany, now held by Professor Penhallow, and for an addition to the endowment of the chair of physics now held by Professor Cox.

TEACHERS College, Columbia University, has received an anonymous gift of \$100,000 for a building for its experimental school. The building will provide for 50 children in the kindergarten and 240 in the elementary grades, with special classes in sewing, cooking, manual training and music. There will also be a gymnasium, baths, library, reading rooms and accommodations for evening classes, club meetings and social gatherings for the people of the community. This experimental school of the Teachers College is, of course, in addition to the Horace Mann school for which a new building is in course of construction.

THE present Legislature of the State of California has passed measures of importance for the two great universities of the State, and these have been signed by the Governor. The sum of \$200,000 was appropriated for the support of the University of California, and a further contingent appropriation of \$50,000 was made. Stanford University was, as we have already noted, given additional power to accept and hold funds, and its property was in part exempted from taxation.

THE last session of the State Legislature voted to place the North Dakota Agricultural College upon a permanent and fixed income in place of the heretofore uncertain bi-annual appropriation. One-fifth mill is assessed upon all taxable property in the State for the support of the College. An appropriation of \$50,000 was made for needed buildings and improvements, and \$18,000 to meet current expenses until the mill tax becomes available. A new chemical laboratory is to be built during the present season.

It is reported that German-American citizens of Baltimore will collect \$100,000 toward the endowment of the Johns Hopkins University, and that \$600,000 of the million dollar fund have been secured.

THE Chicago *Tribune* reports that the Armour Institute of Technology will be amalgamated with the University of Chicago. The property of the Institute is valued at about \$3,000,000, and there are about 1,000 students in attendance.

AN anonymous gift of \$60,000 has been made to Allegheny College, at Meadville, Pa., on condition that \$140,000 in addition be collected.

THE late Charles A. Converse, of Norwich, has bequeathed about \$200,000 for public purposes, including \$80,000 to the Norwich Free Academy for an art collection.

MRS. CHARLOTTE T. GASSETTE has given \$10,000 to Albion College, at Albion, Mich., for a library building.

THE Manufacturers' Association in New York has appropriated \$2,000 for a scholarship. Information concerning the terms on which it will be awarded can be obtained by addressing Mr. James T. Hoile, secretary of the association, 196 Montague street, Brooklyn.

THE medical building and the south building of the Iowa State University have been destroyed by fire. The loss is estimated at \$250,000, and is only in part covered by insurance.

IN regard to the troubles at the Royal Engineering College at Coopers Hill, Lord George Hamilton has now consented to let the Board of Visitors meet the dismissed professors. He has also added to the Board of Visitors representatives of the Universities of Oxford, Cambridge and London, who are to be members of a committee that will report upon the working, discipline and constitution of the College, and the relations of the visitors, president and teaching staff.

DURING the latter part of June Professor Geo. F. Atkinson will deliver a series of lectures on 'Nature Study' at the summer school of the University of North Carolina. The lectures will deal with topics on 'Plant Life' and will be given before teachers. Professor Atkinson will return to Ithaca, N. Y., in time to take charge of the hotanical work in the summer school of Cornell University.

PROFESSOR FRANK A. FETTER has resigned his position at Stanford University to accept a

professorship of political science at Cornell University.

DR. DAVID EUGENE SMITH, principal of the State Normal College, at Brockport, N. Y., has been appointed professor of mathematics in Teachers College, Columbia University. Dr. Smith was graduated from Syracuse University in 1881, and is well known for his series of mathematical text-books and writings on the teaching and history of mathematics.

CAPTAIN WILLIAM CROZIER, of the Ordnance Department, has declined the appointment as professor of natural and experimental philosophy at the U. S. Military Academy at West Point, N. Y.

PRESIDENT JEROME H. RAYMOND has resigned the presidency of the University of West Virginia at Morgantown. There have been troubles in the faculty, and, as we have already noticed, two of the members who were dismissed have brought suit against President Raymond. The regents of the university have, however, in accepting the resignation, paid a high tribute to the services of Dr. Raymond. Dr. Raymond is now going abroad and on his return will accept a chair in the University of Chicago.

THE statement that Dr. W. T. Jordan, of the University of Tennessee, has been offered the presidency of the University of Alabama is not correct as the trustees will not elect a president until their meeting in June. Dr. Jordan's name has, however, been prominently mentioned in connection with the position.

THE following lecturers have been appointed at Yale University: Dr. Henry F. Davies, lecturer on esthetics and patristic philosophy; George R. Montgomery, lecturer in philosophy; Dr. Stuart Rowe, lecturer in pedagogy; Dr. William M. Hess, lecturer in philosophy.

MR HERBERT F. ROBERTS, instructor in botany in Washington University, St. Louis, has been elected to the chair of botany in the Kansas State Agricultural College.

PROFESSOR ANTON. FREIHERR VON EISELBERG, of Königsberg, has been chosen to succeed the late Professor Eduard Albert in the chair of surgery at Vienna.



# SCIENCE

A WEEKLY JOURNAL DEVOTED TO THE ADVANCEMENT OF SCIENCE, PUBLISHING THE OFFICIAL NOTICES AND PROCEEDINGS OF THE AMERICAN ASSOCIATION FOR THE ADVANCEMENT OF SCIENCE.

EDITORIAL COMMITTEE: S. NEWCOMB, Mathematics; R. S. WOODWARD, Mechanics; E. C. PICKERING, Astronomy; T. C. MENDENHALL, Physics; R. H. THURSTON, Engineering; IRA REMSEN, Chemistry; JOSEPH LE CONTE, Geology; W. M. DAVIS, Physiography; HENRY F. OSBOEN, Paleontology; W. K. BROOKS, C. HART MERRIAM, Zoology; S. H. SCUDDER, Entomology; C. E. BESSEY, N. L. BRITTON, Botany; C. S. MINOT, Embryology, Histology; H. P. BOWDITCH, Physiology; J. S. BILLINGS, Hygiene; WILLIAM H. WELCH, Pathology; J. MCKEEN CATTELL, Psychology; J. W. POWELL, Anthropology.

FRIDAY, APRIL 5, 1901.

## CONTENTS:

<i>Observation and Experiment:</i> PROFESSOR R. S. WOODWARD .....	521
<i>On the Homologies and Probable Origin of the Embryo-sac:</i> PROFESSOR GEO. F. ATKINSON.....	530
<i>Natural History Work at the Marine Biological Laboratory, Wood's Hole:</i> PROFESSOR C. O. WHITMAN .....	538
<i>Christian Frederik Lütken:</i> F. A. B.....	540
<i>Scientific Books:—</i>	
<i>Progress of Forest Management in the Adirondacks:</i> PROFESSOR V. M. SPALDING. <i>Willey's Zoological Results:</i> PROFESSOR G. H. PARKER. <i>Taylor on the Austin Dam:</i> PROFESSOR FREDERIC W. SIMONDS.....	542
<i>Scientific Journals and Articles.....</i>	545
<i>Societies and Academies:—</i>	
<i>Anthropological Society of Washington:</i> DR. WALTER HOUGH. <i>Science Club of Upper Iowa University. Science Club of the University of Wisconsin:</i> PROFESSOR LOUIS KAHLBERG. <i>Elisha Mitchell Scientific Society:</i> PROFESSOR CHAS. BASKERVILLE.....	547
<i>Discussion and Correspondence:—</i>	
<i>The Date of Rafinesque's Death:</i> DR. R. ELLSWORTH CALL. <i>Lunar Halo:</i> C. M. BROOMALL	548
<i>Shorter Articles:—</i>	
<i>The Largest Known Dinosaur:</i> DR. ELMER S. RIGGS. <i>A Recent Fault-Slip, Ogden Canyon, Utah:</i> PROFESSOR J. E. TALMAGE.....	549
<i>Quotations:—</i>	
<i>The U. S. Naval Observatory. Politics and State Universities .....</i>	550
<i>Current Notes on Physiography:—</i>	
<i>Snake River Canyon; Alpine Morphology; New Zealand:</i> PROFESSOR W. M. DAVIS.....	551
<i>Contemporary Thermodynamic Efficiencies:</i> PROFESSOR R. H. THURSTON.....	552
<i>The U. S. Geological Survey.....</i>	554
<i>Scientific Notes and News.....</i>	555
<i>University and Educational News.....</i>	560

## OBSERVATION AND EXPERIMENT.\*

THE near coincidence of this anniversary meeting of the Academy with the end of the nineteenth and with the beginning of the twentieth century imposes peculiar and quite unexpected restrictions in the way of freedom of choice of a fitting subject for an address. Naturally one would like to pass in review some of the brilliant achievements of science in the past century, and perhaps forecast the still more brilliant advances that may be expected to mature in the present century. Especially might one feel tempted to present a semi-popular inventory of the more striking or recondite scientific events with which he is particularly familiar. But all this and more, strange as it may seem, has been done, or is being done, by the public press. Specialists in almost every branch of science have been employed to expound and to summarize the discoveries, the theories, and the useful applications which have rendered science, by common consent, the most important factor in the civilization of the nineteenth century. Statesmen, philosophers and divines are likewise sounding the praises of science and the scientific method with a warmth of recognition and with a stamp of approval which tend to make one who is

\*Address of the President of the New York Academy of Sciences, read before the Academy on February 25, 1901.

MSS. intended for publication and books, etc., intended for review should be sent to the responsible editor, Professor J. McKeen Cattell, Garrison-on-Hudson, N. Y.

old enough to have lived in the pre-scientific, as well as in the present epoch, feel as if a millennium were close at hand. Indeed, such a wealth of good scientific literature is just now thrust before us and such a wealth of praise is just now bestowed on scientific achievement that the modest man of science must hesitate before adding a word to that literature or a qualification to that praise.

The requirements of official position are remorseless, however, and one must speak his thought, although silence with respect to science may appear to be the most urgent need of the hour. In view of these circumstances, it seems best to avoid topics of current interest and to invite your attention to a brief consideration of the elements which lie at the basis of scientific investigation and scientific progress. A recurrence to the slow and painful beginnings of knowledge and the first principles evolved therefrom is always instructive; and it is especially fitting at a time, like the present, when the ardor of research is somewhat in danger of the sedative influences which spring from the popular glorification of triumphant successes.

The fundamental data from which all scientific knowledge grows are furnished by observation and experiment. After these come the higher steps of comparison, hypothesis, and finally the correlation and unification of phenomena under theory. Even pure mathematics, though long held apart from the other sciences, must be founded, I think, in the last analysis, on observation and experiment.

Of the infinite variety of phenomena which appeal to our senses, some, like those of sidereal astronomy, are subject, in the main, to observation only; while others, like those of terrestrial physics, chemistry and biology, are subject to both observation and experiment. All phenomena are

more or less entangled. They point backward and forward in time; any one of them appears and disappears only in connection with others; and the record any one of them leaves is known only by its interaction with others. Out of this plexus of relations and interrelations it is the business of science to discover the conditions of occurrence and the laws of continuity. Happily for man, although the ultimate complexity of phenomena is everywhere very great, it is frequently possible to discern those conditions and occasionally possible to trace out those laws. But the results we reach are essentially first approximations, depending, in general, on the extent to which we may ignore other phenomena than those specially considered. In fact, a first step towards the solution of a problem in science consists in determining how much of the universe may be safely left out of account. Thus the method of approximating to a knowledge of the laws, of nature is somewhat like the method of infinite series so much used by mathematicians in numerical calculations; and as it is a condition of success in the use of such series that they be convergent rather than divergent, so is it an essential of scientific sanity that the mind be restricted by observed facts rather than diverted by pleasing fancies.

The prime characteristic of the kind of knowledge that leads up to science is its dependence on facts which are permanent, and hence verifiable. In the course of the progress of our race there have been certain luminous epochs during which observers and experimentalists have revealed more or less of such knowledge. These epochs have been followed, generally, by others of comparative dullness, or positive darkness, during which fact has been replaced by fancy and what is permanent and verifiable has been eclipsed by what is ephemeral and illusory. It is my purpose

to-night to recall some of the principal events of these epochs, and to enforce, as well as I may, the great lesson they seem to teach us, namely, that science can be maintained only, and can be advanced only, by a constant appeal to observation and experiment.

As we look out on the universe about us the most striking phenomena visible are those which belong to what Galileo and his successors have fitly called 'the system of the world.' The rising and setting of the sun and moon; the majestic procession of the seasons; the splendid array of the stars in the heavens; the ebb and flow of the sea, and the never-ending variety from wind and weather, need only to be mentioned to enable us to understand why astronomy is at once the oldest and one of the most highly developed of the sciences. No classes of phenomena are so obvious, so omnipresent and so enduring. They have furnished the symbols of continuity and permanence for all languages in all historic times. The 'fixed stars,' for example, are in fact, as well as in fiction, our standards of reference in the reckoning of time and space; for are not 'Sirius and Orion and the Pleiades,' as Carlyle has remarked, 'still shining young and clear in their course as when the shepherds first noted them on the plains of Shinar?'

But before astronomy there were mythology and astrology, and we may well marvel how it has been possible, even after the lapse of twenty odd centuries, to educe the orderly precision of science out of the complicated miscellany of fiction, fact, religion, and politics bequeathed to our era by the fertile imaginations of our distinguished ancestors. What, for example, could be more confusing than the paleontological jungle called the stellar constellations, with its gods and goddesses; with its dogs, lions, bears and fish, great and small,

northern and southern; with its horse, whale and goat; and with the slimy forms of serpents intertwining them all?

Although it is impossible to set any date for the emergence of astronomy out of mythology and astrology, the epoch of Hipparchus undoubtedly is the earliest one of conspicuous advances known to us. This epoch, which may be called also the epoch of the Alexandrian school of science, extends from about 300 B.C. to about 150 A.D. It is distinguished by the remarkably perfect work in pure geometry of Euclid and Apollonius, and by the still more noteworthy work of Archimedes in laying the foundations of statics and hydrostatics; it comprises the measurements according to correct principles of the obliquity of the ecliptic and the dimensions of the earth by Eratosthenes; it includes the observations of the sun, moon, stars and planets collected by Aristyllus and Timocharis and later turned to so good account by Hipparchus; it embraces the work of Aristarchus, who maintained the heliocentric theory of the solar system and who was the first to attempt a measure of the dimensions of that system by means of the fine fact of observation that the earth, sun and moon form a right triangle, with the right angle at the moon when the latter is in dichotomy—or when its face is just half illuminated; and finally it includes the work of Ptolemy, a worthy disciple of Hipparchus, whose *Almagest* has come down to our own time.

From the observational point of view we must rank the principles with respect to fluids at rest discovered by Archimedes as amongst the capital contributions to the science of all times; for while his successors, of the last two centuries especially, have added to hydromechanics the large and vastly more difficult branch of hydrokinetics, they have found no change essential in his laws of hydrostatics.

Equally important, also, in its far reaching connections was the work of Eratosthenes in determining the size of the earth. This work required an hypothesis as to the shape of the earth and appropriate observations. Supposing the earth to be spherical, an assumption which Eratosthenes knew well how to justify, he saw that to determine its size it is only necessary to apply the rule of three to the measured length of an arc of a meridian and to the measured difference of the latitudes of the ends of such arc. He observed that at the city of Syene, which is about 500 miles south of Alexandria, the sun shone vertically downwards into deep wells at noon on the day of the summer solstice, showing thus that at that place and time the sun was in the zenith. On the same day at Alexandria he observed, by means of the gnomon, that the sun at noon was south of the zenith by one-fiftieth of a circle, or  $7^{\circ}.2$ . The distance between the two points was found by the royal road masters of the country to be 5,000 stadia, thus giving for the complete circumference of the earth 250,000 stadia. Although the measurements thus made by Eratosthenes were very crude and undoubtedly subject to large errors, we see in them the beginnings of some of the most refined geodetic operations of the present day. Unfortunately for us, also, the measurement of the distance is expressed in a unit whose relation to modern units is only roughly known.\*

But commendable as was the work of his predecessors and contemporaries, the work

\* As illustrating the slow growth of ideas with respect to precision, it may be related that when the Arabians in the ninth century undertook, for the same purpose, the measurement of a meridional arc on the plain of Singiar, in Mesopotamia, they were not more successful in preserving for posterity the standard of length used by them. This standard is said to have been the 'black cubit, which consists of 27 inches, each inch being the thickness of six grains of barley.'

of Hipparchus rises to a still higher plane. He was an observer and a theorist of the highest type, being able at once to collect facts and to interpret their relations, and he deserves to be ranked among the great astronomers of all times. He was the first to clearly appreciate the value of a catalogue of the fixed stars and constructed one giving the relative positions of 1,080 stars. He observed with surprising precision the interval of the tropical year; he made the first tables of the sun and moon; he discovered the remarkable fact of the precession of the equinoxes, and he thus early led the way to the great advances of modern times.

The peculiar merit of the work of Hipparchus lies not alone in the fact that he saw how the apparent motions of the heavenly bodies may be determined by observations, but also in the fact that he saw how these motions may be determined by a very small number of appropriate observations. Thus, for example, the interval from the vernal equinox to the summer solstice and the interval from the latter to the autumnal equinox sufficed to give him a close approximation to the apparent motion of the sun; while the records of a few eclipses of the moon enabled him to deduce a closely correct value of the precession of the equinoxes, that shifting of the line of intersection of the equator and the ecliptic which goes on so slowly that an interval of nearly 26,000 years is required for a complete circuit.

Hipparchus may be called the founder of the geocentric theory, since he demonstrated the accordance of the phenomena known to him with that theory. The fact that this theory is false detracts little from his merits; for the sole requisites of a good theory are simplicity of statement and conformity with observation. We now know, indeed, that mechanical phenomena are, in general, susceptible of multiple interpretations, and that

observation must decide which of them is to be preferred.

The method which Hipparchus used to measure the sun's apparent motion among the fixed stars is very noteworthy, especially when we consider the utter lack of effective instruments in his time. If the sun moves regularly about the earth, as first supposed by Hipparchus, it ought to return at any epoch, as that of an equinox, to the same position among the fixed stars. Imagine a line drawn at the time of the vernal equinox, say, from the center of the earth to the center of the sun. This line prolonged will pierce the celestial sphere in two points, and, if either point can be located, the position of the sun with reference to the stars becomes known. Hipparchus fixed this position by noting the location among the stars of the center of the shadow cast by the earth at the times of eclipses of the moon. By a comparison of his own observations of such eclipses with those made by his predecessors he was able to determine the apparent motion of the sun with reference to the stars, or what we now know to be the motion of the equinoxes with reference to stars. To establish this fact of precession from such meager observations was a great step; and it seems not a little singular that a phenomenon so striking should not have led to speedy investigations for its source. But about eighteen centuries elapsed before Newton clearly visualized the mechanical interpretation of this phenomenon, and it was only after an additional half-century that the interpretation was fully worked out by d'Alembert.

How rapidly the spirit of science dies out when its devotees cease to observe and experiment is shown by the failure of the 'Divine School of Alexandria' to maintain the high standard set by Hipparchus. His immediate successors became at best only commentators. They wrote much but observed little; and it does not appear that

any of them attempted even to verify the remarkable discoveries of Hipparchus during the two hundred and fifty years which elapsed between the period of his activity and the advent of his worthy disciple and expounder Ptolemy.

It is to the work of Ptolemy chiefly that we owe our knowledge of the discoveries and theories of the Hipparchian epoch. His treatise on the 'Great Construction,' the *Megiste Syntaxis*, or the *Al Magisti* and hence *Almagest* of the Arabians, is the earliest of the great systematic treatises on astronomy. It is in this work that the theory of eccentrics and epicycles of Hipparchus is explained and elaborated, and it is this work which has given the name of Ptolemy, rather than that of his acknowledged master, to a system of the world which dominated scientific thought for nearly fifteen hundred years.

The period during which the observations and researches of Ptolemy were carried on is commonly referred to in history as extending from the reign of the Emperor Hadrian to that of Marcus Aurelius. Thus, while Ptolemy was an Egyptian by birth, the fact that he was permitted to pursue his astronomical studies under the empire helps to some extent to relieve the Romans of the charge that they were, as regards science, the most ignorant people of antiquity. But the gravity of that charge is only palliated by the work of Ptolemy, for he left no successors. Roman astronomy did not rise above the level of astrology; the spirit of scientific enquiry gave way to speculation and declamation; and the long night which followed was not broken until the dawn of the epoch of Galileo—the modern epoch, whose advances have been founded on observation and experiment.

If astronomy is preeminent among the sciences for its dependence on observation, chemistry and physics are equally preemi-

ment for their dependence on experiment. This difference in methods of investigation between the former and the two latter sciences is a difference imposed by the circumstances that astronomy deals chiefly with objects at long range while chemistry and physics are concerned with objects near at hand. It seems not a little singular, however, at first thought, that progress in the development of knowledge concerning the behavior of distant bodies should have been almost as rapid up to the present time as the development of knowledge concerning bodies much more familiar and accessible to us.

Chemistry and physics, like astronomy, had their forerunners in mythological follies and extravagances. Semi-civilized and civilized man required a long time after he had learned how to talk and to write well, after he had founded states and constructed systems of philosophy and religion, before he could reason rationally and successfully with respect to the commonest material things about him. Thus, chemistry was long obscured by merely verbal speculations on the 'four elements, earth, air, fire and water' or on the 'three elements, salt, sulphur and mercury'; while the beginnings of physics were perhaps even more clouded by the fantastic unrealities of fertile but unchecked imaginations.

But man early learned to measure the value of chemistry by the 'gold standard.' It is hinted, in fact, though without adequate evidence, that the Golden Fleece of the Argonautic expedition was a manuscript containing valuable secrets of the chemist's art; and Suidas, of the eleventh century, to whom the word chemistry is attributed, relates that Diocletian, fearing that the Egyptians, by reason of their knowledge, might become rich and restive, ordered, in true Roman fashion, that their books on chemistry should be burned. The thirst for gold assisted also in the development of

alchemy, which flourished from the eleventh to the fifteenth century especially, and has had not a few adherents, it would seem, during all the centuries down to and including the one just past. The philosopher's stone was almost universally believed to be a real agent in medieval times; and this strange fiction also has its survivals in the 'mad stones,' 'moon stones,' 'lucky stones,' and other 'charms' whose use even at the present time is not uncommonly justified by the wise saying that 'there may be something in them.'

The difficulty in getting the human mind started with the elements of physical science is well illustrated, likewise, by the superstitious rubbish that encumbered the early progress of knowledge concerning magnets. They were endowed with imaginary qualities far more wonderful than subsequent observation and experiment have disclosed. It was believed, for example, that they would cause some diseases and cure others; that they were effective as love philters; that they would lose their properties when rubbed with garlic (which seems not so unlikely), but that a bath in goat's blood would readily counteract this destructive effect. And in this case, also, as with alchemy and the philosopher's stone, it is to be noted that such crude notions of the phenomena of matter find their survivals at the present day in a wide acceptance of the unverified efficacy of 'magnetic healers' and 'electric belts,' and in the ease with which capitalists can be persuaded to invest in a 'Keely motor' or in anything that promises the marvelous.

With the decline of alchemy the field for chemistry shifted somewhat. Not unnaturally, since most chemists were also physicians in those days, a knowledge of the chemical properties of substances came to occupy a prominent place in the physician's art. Thus Paracelsus in the sixteenth century, cutting loose from the

teachings of Aristotle and Galen, boldly asserted that the true use of chemistry is not to make gold, but to prepare medicine; and he and his follower Van Helmont, in addition to attaining fame for skill in compounding remedies, were amongst the first to appreciate the true import of the processes of analysis and synthesis which came to be called in their day the spagyric art. Then followed the doctrine of the mutually neutralizing substances, acid and alkali; the fruitful hypothesis of elective attractions, or affinities; the ingenious, if erroneous, theory of phlogiston, and the more permanent theory of oxygen. All these led up through more and more searching experimentation to the first great epoch in the history of chemistry—the epoch of Lavoisier.

Among the early workers in the century preceding the epoch of Lavoisier the names of Becher and his disciple Stahl deserve especial mention, not only by reason of their introduction of the theory of phlogiston, but also by reason of their enthusiastic and steadfast devotion to science without hope of pecuniary reward. In his remarkable treatise entitled '*Physica Subterraneæ*,' published in 1681, Becher defends the scientific pursuit of chemistry as not less worthy of attention than philosophical and theological studies. He insists especially on the need of careful observations and on the necessity of constantly verifying theory by experiment. With true scientific enthusiasm he describes the chemist as one willing to work amid the flames and fumes, and, if need be, the poisons and poverty of the laboratory. He has no patience with the charlatans, of which it appears there were still many in his day, who are looking chiefly for ways and means of extracting the precious from the baser metals. As for himself, he says: "My kingdom is not of this world. I trust that I have got hold of my pitcher by the right handle—the true

method of treating this study; for the pseudo-chemists seek gold, but the true philosophers, science, which is more precious than any gold."

It is a peculiarly noteworthy fact that while much attention was given to chemistry during ancient and medieval times, comparatively little attention was given to the other branches of physical science. Our knowledge of heat, light, electricity and magnetism is almost wholly a development of modern times. The Greeks were acquainted with a few of the more elementary phenomena of electricity and light; and Ptolemy and Alhazen came near discovering the law of optical refraction; but there was no contribution made to either of those physical sciences comparable with the discoveries of Hipparchus in astronomy until the epoch of Galileo. What a marvelous increase in the rate of scientific progress began with this epoch is shown on nearly every page of the subsequent history of science. Galileo and his contemporaries may be said to have established the methods of observation and experiment. Their systematic application has borne fruit in every science. Almost every step forward has led to additional advances, until now each of the physical sciences has its wide array of determinate facts correlated under a great theory. In the domain of light, for example, the only solid contribution of the ancients is the obvious fact of radiation in straight lines. After nearly sixteen hundred years of our era had elapsed, there came Galileo's invention of the telescope, and about the same time Snell's discovery of the law of refraction. To the telescope was soon added the microscope and the camera obscura. Then followed Newton with explanations of the rainbow, dispersion and kindred phenomena; Hooke with his discovery of the colors of thin plates; Dolland with the

combination of two lenses to produce achromatism, and Huygens with his discoveries and explanations of double refraction and polarization; while in the meantime Roemer had measured the velocity of light. All these accessions crowded one another so closely that the emission theory of Newton and the undulatory theory of Huygens followed almost as a matter of necessity. The battle royal of these two rival theories, as you know, lasted for nearly a century, until the emission theory, by the sheer force of critical observations and experiments, was displaced by the undulatory theory through the brilliant researches of Young and Fresnel.

When we turn from the physical to the geological and biological sciences, the same lessons of the necessity and the efficiency of observation and experiment are still more strikingly apparent. For although geology and biology are the youngest of the grand divisions of science, they have accomplished more than all others toward giving man a proper orientation with respect to the rest of the universe. Geology as we now understand the term is but little more than a hundred years old, and biology, in the sense now attached to the word, is less than fifty years old. Nevertheless, these sciences have been the chief contributors to the doctrine of evolution, which, in view of the wide range of its applicability, must be regarded as the most important generalization of science.

It is a singular circumstance, however, considering the early advances made in the interpretation of the phenomena of astronomy, that the equally ubiquitous and far more accessible phenomena of geology and biology should have been so tardily investigated. The cause of this delay seems to lie in the fact, not without examples in the present day, that our remote ancestors had the habit of constructing their theories first

and making their observations, if at all, afterwards; and in the cases of geology and biology they were so well satisfied with their theories that the trouble of making observations was for a long time dispensed with.

We of the present day have no right, perhaps—and I for one would not be disposed to use such a right if conceded—to blame our predecessors for the narrow, and in some instances crooked, views they held with regard to these subjects. But on the other hand, we shall fail, I think, to make proper use of our opportunities if we do not learn speedily to conduct scientific investigations in the future so as to avoid such colossal blunders as mar the history of geology and biology from its beginnings down almost to our own time.

As an illustration of the blunders referred to I may cite the profound reluctance, even of eminent men of science, to accept the plainest teachings of observation with respect to geological time up to the middle of the century just passed. Not until Lyell, the great champion of uniformitarianism as opposed to catastrophism, had published his 'Principles' (1830) did scientific opinion show a tendency to accept the fact of the hoary age of the earth, everywhere attested by the rocks in her crust.

And what a storm of opposition and condemnation, amounting almost in some cases to social ostracism, was visited by the very 'salt of the earth' against those who ventured during the sixties and the seventies of the last century to consider favorably the arguments of the 'Origin of Species'! All this has about it the freshness, and possibly the pain and the humor, of personal recollection for those of us who are old enough to have lived in two epochs. That a mistake of this sort could have been made thirty or forty years ago seems strange enough in these peaceful times of



ours. But while we may properly let the recollection of the storm and stress of this earlier period fade away, the moral of the conflict should be held up as a permanent warning to scientific as well as unscientific men; for no episode in the previous experience of the race demonstrates so clearly the sources of knowledge and the methods of attaining it.

As a final illustration of the validity of my thesis I would invite your attention to one of the most instructive and beneficent of the many brilliant biological researches of recent times. No one who has suffered from repeated attacks of intermittent fever, and has survived the ravages of the *materia medica*, can fail to take a lively interest in the wonderful progress made during the last twenty years towards a definite knowledge of the natural history of that disease. Nor can any one interested in the general aspects of science fail to see in the investigations leading up to this progress some of the finest examples of the scientific method.

It would appear that malarial fever has been one of the commonest disorders, in certain localities, with which man in his struggle for existence has had to cope; and before the discovery of the properties of Peruvian bark it must have been a very serious affliction by reason of its secondary if not by reason of its primary effects. The symptoms, course and distinguishing characteristics of the disease, as well as the remedies therefor, were long known, however, before it was suspected that the mosquito had anything to do with its dissemination. Bad water, foul air, and sudden or extreme changes of temperature were supposed to be promoting causes. The dampness of marshes, swamps and other areas holding stagnant water was held to be an especially common attendant, if not inducing, condition. There was, indeed, no lack

of acute and painstaking observations and no lack of ingenious and well-supported hypotheses with regard to this widely prevalent but obscure disorder. The details of its diagnosis, prognosis, nature and causation, as laid down in the medical manuals of a few decades ago, are particularly interesting and instructive reading now in view of recent developments. For example, Hartshorne in his 'Essentials of the Principles and Practice of Medicine,' published in 1871, gives the following explanations:

"No disease has ordinarily so regular a succession of definite stages as intermittent fever, namely, the cold, the hot, and the sweating stage." \* \* \* "Upon the origin of malarial fevers," he adds, "the following facts seem to be established: 1. They are reasonably designated as autumnal fevers, because very much the largest number of cases occur in the fall of the year. Spring has the next greatest number of cases. 2. They are always strictly localized in prevalence. 3. They never prevail in the thickly built portions of cities. 4. An average summer heat of at least 60° F. for two months is necessary for their development. Their violence and mortality are greatest, however, in tropical and subtropical climates. 5. They prevail least where the surface of the earth is rocky; and most near marshes, shallow lakes and slow streams. The vicinity of the sea is free from them, unless marshes lie near it. 6. The draining of dams or ponds, and the first culture of new soil, often originates them. 7. Their local prevalence in the autumn is always checked by a decided frost."

Here we have the facts with regard to the symptoms and cause of the disease stated with a clearness and a conciseness that could hardly be surpassed. But the real cause of the malady eluded the insight of the discriminating observers who collected those facts. A quite different class of facts required consideration. It was essential

to concentrate attention on the pathological aspects of the enquiry. As to the nature of the disease, Hartshorne writes, with commendable caution, "It is only possible to speculate at present. It is most probable that ague is a toxemic neurosis. The importance of the blood change attending it is shown by the disintegration of the blood corpuscles, and deposit of pigment in various organs." This destruction of the blood corpuscles was the critical point on which the investigation turned. About 1880, Laveran, a French army surgeon, discovered the destructive agency in a minute parasite, one of the protozoa, which takes up its residence in, and then, ungratefully enough, destroys, our red blood corpuscles. What a splendid problem was presented by the facts thus brought to light! The exquisite refinement of the researches which followed may be inferred when we reflect on the minuteness of an organism which can work out a part of its life history within blood corpuscles so small that four to six millions of them find plenty of room in a cubic millimeter. But stranger still is the fact, established within the past year or two, that the mosquito plays the rôle of an intermediary host and transmits the parasites to us while feasting upon our blood. The details of this remarkable discovery need only be alluded to here, for they have been so recently explained by the experts participating in them that their essential features are a part of popular information. Suffice it to remark that they show how we may secure almost complete immunity from malarial fevers at no distant day.

Thus, in whatever direction we look for the sources of scientific progress, the same elementary methods of advancement are found to be effective. Whether we consider the dimensions of the solar system or the distances between the molecules of a gas; whether we seek the history of a star as revealed by its light or the history of the

earth as recorded in its crust; whether we would learn the evolution of man or the development of a protozoon; whether we would study the physical and chemical properties of the sun or the corresponding properties of a grain of sand; in short, whether we turn to the macrocosm or to the microcosm for definite, verifiable, knowledge, it is found to originate in and to advance with observation and experiment.

R. S. WOODWARD.

*ON THE HOMOLOGIES AND PROBABLE ORIGIN OF THE EMBRYO-SAC.\**

THE problems connected with the origin and interpretation of the embryo-sac have been of great interest to the student of plant morphology, from the time that they began to inquire into the relation of the ovule to the formation of the embryo plant. It is now a matter only of historical interest that Morland (1702), Geoffrey (1714) and others contended so seriously that the embryo-sac of the angiosperms was a sort of incubator where the embryo, brought in by the pollen tube, was hatched out into the young plantlet. While great advances have been made in our knowledge of the development and function of the embryo-sac, there are still unsettled problems of its origin and homology upon which we speculate, perhaps with no nearer approach to the truth than were the speculations by the founders of the science of plant morphology.

The first important contribution to the morphology of the embryo-sac was made by Hofmeister during the middle of the present (19th) century, extending over a period from 1849 (*Die Entstehung des Embryo der Phanerogamen*) to 1861 (*Neue Beiträge zur Kenntniss der Phanerogamen*). In the

\* Paper presented before the joint session of Section G, American Association for the Advancement of Science, and the Botanical Society of America, at its sixth annual meeting, New York City, June 28, 1900.

embryo-sac when ready for fertilization he recognized two groups of nuclei lying respectively at the poles, which we now regard as the egg apparatus and the antipodals. At the micropylar end of the embryo-sac Hofmeister found usually two nuclei which he called 'germinal vesicles,' or 'embryonal vesicles,' one of which developed the embryo after the entrance of the pollen tube. In the opposite end he found a variable number of antipodal cells. The embryo-sac was by him considered homologous with the macrospore of the higher Pteridophytes. The germinal vesicles corresponded to the corpuscula (archegonia) and the accompanying rosette of cells (neck) in the gymnosperms.

Schacht (*Jahrb. f. wiss. Bot.*, 1857-8) believed that one of the germinal vesicles received the pollen tube and conveyed it later to the other, or that in some cases a third was present when two germinal vesicles seemed to convey the pollen tube to it. The germinal vesicles were sometimes marked on their surface by parallel folds, or in other cases there were parallel striæ in their contents. These striæ or folds formed his 'filiform apparatus,' which came later to be recognized by Strasburger, Pringsheim and others as homologous with the ventral canal cell of the pteridophytes. This gave rise to a further conception of the embryo-sac which was held by some down to a late period, and even appeared in some of the earlier editions of Sach's *Lehrbuch der Botanik*. In addition to the embryo-sac being a macrospore, it represented a prothallium in which the germinal vesicles formed the archegonia, while the antipodals formed the sterile remnant of the prothallium which was homologous with the endosperm of the gymnosperms.

In 1877-78 there appeared three works, by Strasburger, Warming and Vesque, which mark another important epoch in our knowledge of the embryo-sac. These

were concerned with the development of the embryo-sac, and led to new and quite divergent views that have been presented from time to time since that period.

Strasburger (*Ueber Befruchtung und Zelltheilung*, 1877) gave the more complete account of the development of the embryo-sac and the origin of the endosperm, while Warming (*De L'Ovule*, *Ann. d. Sci. Nat. Bot.*, 6 ser., 5) and Vesque (*Développement du sac embryonnaire des phanérogames angiospermes*, *Ibid.*, 6 series, bot. 6, 1878) were more concerned with determining the origin of the embryo-sac in relation to its homologies with the pollen mother cells. It is not my intention to outline the history of the studies of the embryo-sac further, since it becomes very complex and would be filled with tedious detail. It is my purpose, however, to call attention to the principal theories that have been put forward in the interpretation of the homologies of the embryo-sac.

It should be borne in mind that in reviewing some of these theories of the embryo-sac which have been proposed from time to time, it is done in no spirit of criticism, nor for the purpose of 'holding up to view,' at the present time, interpretative of morphological structures which the authors themselves may not now hold. Undoubtedly they were proposed by the authors as working hypotheses upon which to build further investigations, and it is certain that they all have been very useful in stimulating renewed and more profound researches, with improved methods of technique, and out of it all shall come in the future a clearer insight into the true meaning of these obscure plant structures. It is the history of all progressive science, that theories are proposed as working hypotheses, upon which to build further investigations into the nature of truth. When these have fallen new ones are formulated, for without some formulated idea in the mind, as a working

basis, not as something which we are striving to prove at all hazards, progress in investigation is impossible.

1. The first theory as we have seen was that proposed by Hofmeister who regarded the synergids and eggs as 'embryonal vesicles' or 'germinal vesicles,' and therefore the equivalent of eggs. The supposed variable number of antipodals when they were present represented the prothallium. It is interesting to note that at the present time a number of botanists are coming to recognize the synergids as potential eggs, thus confirming Hofmeister's interpretation of the egg apparatus.

2. The proposal by Schacht (1857-8) of a 'filiform apparatus' suggested by certain folds or striæ on the synergids, which were supposed to act as a conductor of the pollen tube to the egg, led Strasburger (Bef., p. 73, 1877), Pringsheim and others to recognize in this the ventral canal cell. The egg apparatus thus came to be recognized as the archegonium, with the synergids as neck cells, while the antipodals represented the prothallium. This was the prevailing view at that time, and was adopted by Sachs in the earlier editions of his text-book. A very similar view of the embryo-sac has recently been stated by Tretjakow.

3. The third view of the homology of the embryo-sac was the outgrowth of the studies of Warming and Vesque, in which the eight nuclei of the embryo-sac were interpreted as spores, the egg apparatus representing one tetrad, and the antipodals a second tetrad of spores, each spore homologous with the pollen grain. This had its origin in the endeavor of Warming to homologize the processes of cell division in the ovule with those in the anther, both of which were looked upon as sporangia. The larger cell which gives rise to the so-called axile row in the nucellus, and which is either the subepidermal cell, or a derivative of it when a 'tapetum' is present, he called the

primordial mother cell of the embryo-sac, and it is so termed by some at the present day. This cell Warming recognized as the young archesporium, comparable with the tetrahedral cell in the young fern sporangium. This primordial mother cell, as is well known, divides into an axile row of several cells, 2, 3, 4, etc. This axile row Warming considered the mature archesporium, each cell being homologous with a pollen mother cell, and he termed them special mother cells. The lower one only developed into the embryo-sac, forming two tetrads, one at either pole, while the other special mother cells disappeared. The egg nucleus is then called the privileged spore. His conclusions here do not appear quite consistent with his hypothesis, since he derives two tetrads (8 spores) from a single special mother cell.

4. Vesque (1879), however, accepting in the main Warming's views, attempts to show that the two tetrads are derived from two special mother cells. The cells of the axile row he regards as the mature cells of the archesporium, that is, special mother cells, and numbers them 1, 2, 3, 4, 5, etc., according to the number present in different species, beginning with the uppermost cell (the one at the micropylar end). No. 1, then, the uppermost cell, divides to form a tetrad, the egg apparatus; while No. 2 forms one or several antipodals, and makes up the larger portion of the embryo-sac. The wall between 1 and 2 dissolves and disappears, so that the embryo-sac is supposed to form by the fusion of these two cells. It is not necessary to dwell further upon Vesque's view, since he gives such an imperfect account of the processes of development which take place here, and since subsequent studies show that in a very large majority of cases it is the lower cell of the axile row which gives rise to the embryo-sac. But it is of interest to note his attempt to harmonize Warming's view

of the relation of the special mother cells to the subsequent tetrads in the embryo-sac, the figure of the tetrad suggesting that each nucleus corresponds to a spore or pollen grain.

5. A fifth view, and one which was also influenced to some extent by Warming, was proposed by Marshall-Ward (*Jour. Micr. Soc.*, 20, 1880; also, *Jour. Linn. Soc.*, 7, 1880). According to this view the embryo-sac consists of two prothallia, derived from two spores, the egg apparatus representing one, and the antipodals representing the second. The upper one consists of one vegetative cell (the upper polar nucleus) and the rudimentary archegonium, the two synergids being suggested as neck cells. The origin of the embryo-sac according to this view, was as follows: The primary mother cell of the embryo-sac, either a subepidermal cell, or the lower derivative of this, when a tapetum is formed, divides once and forms two cells. The lower one divides again, thus forming three cells in the axile row, separated by cell walls. These three cells correspond to the special mother cells which Warming believed to be homologous with the pollen mother cells. The lower cell now develops the embryo-sac. Its nucleus divides in the same direction as the division walls arising in the formation of the three cells of the axile row. These two nuclei at opposite poles of the young embryo-sac he believed represent cells in the axile row, thus making four cells in all. The two lower cells are not separated by cell walls, due, he believes, to the extraordinary rapidity of growth from this time onward. Each of these two lower cells, represented by the two-nucleated stage of the embryo-sac, he interpreted as a spore, one to give rise to the upper prothallium, and the other to the lower prothallium of the embryo-sac. It is possible to draw the inference that he regards the primary mother cell of the em-

bryo-sac as a mother cell of four spores, since the axile row, as he interprets it, consists of four cells. The two lower ones he distinctly interprets as spores. The primary mother cell could not, however, be a cell homologous with the mother cell of spores according to this interpretation, since three successive divisions occur before these two spores are developed which are to form the embryo-sac; while the tetrad of real spores is developed by two successive divisions.

6. A sixth theory of the homology of the embryo-sac was proposed by Mann. (The embryo-sac of *Myosurus minimus* L., *Trans. & Proc. Bot. Soc.*, Edinburgh, 29, 35; 1892. The embryo-sac of angiosperms is a sporocyte and not a macrospore, *Ann. Rep. B. A. A. S.*, 782, 1892.) He made an attempt to draw a direct homology between the embryo-sac and the pollen mother cell in origin, and also in the number of nuclei developed as a result of the division of the mother cell or sporocyte. For him each cell of the axile row is a sporocyte, and homologous with the pollen mother cell. Since from the pollen mother cell the four spores (pollen grains) are formed, and each pollen grain at maturity contains two nuclei, making eight in all, he traced a direct and parallel homology in the origin of the eight nuclei of the embryo-sac. The four-celled stage of the embryo-sac represents the four spores which are homologous with the four pollen grains. Each nucleus now divides again into a vegetative nucleus and a sexual nucleus, which correspond to the vegetative nucleus and generative nucleus of each pollen grain. In thus tracing the homology of the eight nuclei of the embryo-sac with the eight nuclei in the four pollen grains, Mann overlooks the fact that prior to fertilization, when the embryo-sac is still in the eight-nucleated stage, the generative cell in the pollen tube has divided again, or in some cases it divides by the time the pollen is

ripe, forming twelve nuclei for each pollen mother cell, instead of eight; and thus the homology falls.

7. Another view is that the embryo-sac, at the eight-nucleated stage, is homologous with the endosperm of the gymnosperms or, in other words, that the eight free cells are homologous with the endosperm of the gymnosperms. This was proposed by Strasburger as early as 1879. One of the cells of the endosperm forms the archegonium which here is very much more reduced than in the gymnosperms, being reduced to a single cell. A suggestion of such a reduced archegonium is found in *Welwitschia*, etc., where a single endosperm cell without division elongates to form the simple archegonium. Guinard ('81, *Ann. d. Sci. Nat. Bot.*) upholds this view.

8. Very closely allied to this view is the one which interprets all the cells at the eight-nuclear stage of the embryo-sac as potential eggs. Dodel ('91) found in *Iris siberica* that the synergids were sometimes fertilized, and developed embryos. He suggests that the synergids are potential eggs. Chamberlain, '95, suggests that one of the antipodals has all the appearance of an egg ready for fertilization. Strasburger (*Ang. und Gyn.*, '79) states that while in *Santalum* the normal number of eggs is two, there are sometimes three, and one of these may be the upper polar nucleus, when the endosperm is developed from the lower polar nucleus. Overton ('92) records a case of fertilization of one of the synergids of *Lilium martagon*; Guinard ('81) the development of embryos from two synergids in *Mimosa denhartii*, and Tretjakow ('95, *Ber. deut. Bot. Ges.*), the development of embryos from the antipodals of *Allium odorum*. Tretjakow interprets this as a case of apogamy, since he regards the antipodal cells as representing the vegetative portion of the prothallium.

In view of all the facts, Strasburger's hy-

pothesis that the eight cells of the embryo-sac are homologous with the endosperm of the gymnosperms, seems the more reasonable one. If the synergids, then, can be fertilized and produce embryos, they too represent archegonia reduced to a single cell each. This would confirm the view first proposed by Hofmeister that the synergids and egg are 'germinal,' or 'embryonal vesicles.' Tretjakow holds that the antipodals represent the vegetative part of the prothallium, while the synergids and egg represent archegonia, which is very like the earlier views held by Strasburger, Pringsheim and others.

But if the eight cells of the embryo-sac are homologous with the endosperm of the gymnosperms, and the egg is an archegonium reduced to a single cell, it would seem that all the cells of the embryo-sac are potential eggs or potential archegonia.

It is probable that all the peripheral cells of the endosperm in the Abietineæ, for example, at a certain stage of development, a short time prior to fertilization, are potential archegonia. While the archegonia are usually developed from superficial cells at the micropylar end of the endosperm, they are frequently formed from superficial cells down on the side some distance from the end, giving to the endosperm in longitudinal section the appearance of a comb. Archegonia are in some cases developed at the opposite end of the endosperm which would correspond in position to the antipodals of then agiosperm-embryo-sac. Furthermore, archegonia are rarely developed from internal cells of the endosperm. This would indicate that prior to the time for fertilization all the cells of the endosperm are potential archegonia.

And this too seems reasonable since up to this time the course of development in all parts of the gymnosperm embryo-sac have been the same, all parts bear the same nutritive relation to the surrounding nucel-

lus. No part functions particularly as the vegetative part, or protonema, as is the case with most of the pteridophytes. The true vegetative function of the endosperm appears later. The fact that the archegonia do usually arise at the micropylar end of the endosperm is probably acquired or hereditary, since archegonia there are more certain to be fertilized.

If, therefore, the eight-celled stage of the angiosperm embryo-sac is homologous with the endosperm of the gymnosperms, then all the cells are potential eggs. The functional egg is at the micropylar end of the embryo-sac, because the chances for its being fertilized here are greater. This is true of the synergids also when they become functional eggs. The antipodals probably appear in this rôle very rarely. Nevertheless, potentially they are eggs, or greatly reduced archegonia. If this be so, then an embryo developing from an unfertilized antipodal cell would fall in the category of parthenogenesis, instead of apogamy.

This, however, may be drawing the line very fine, and I am not so much concerned with that fine distinction as I am with the *probable origin* of the embryo-sac. Since the embryo-sac has been recognized as the female prothallium of angiosperms, it is natural that there should be an effort to interpret it as a derivative from a macrospore. It is derived, according to the different interpretations of its homologies, from a different number of macrospores.

According to the Vesque theory, it consists of eight macrospores derived from two cells of the axile row, a fusion of two-spore mother cells. According to the theory proposed by Mann it consists of four macrospores and is derived from a single cell of the axile row, regarded as a spore mother cell (sporocyte). According to the theory suggested by Marshall Ward, it consists of two macrospores, each representing a prothallium of four nuclei, the two spores de-

rived from the third cell in the axile row by a division in which no cross wall is formed. This cell of the axile row then would represent a *one-half spore mother cell*, or if the *number of divisions from the primary mother cell be taken into account it would represent a single spore*.

The theory that it consisted of eight spores was shown long ago by Guinard ('81) to be untenable. It necessitated the fusion of two spore mother cells. Vesque had little in support of his theory, since he considered the embryo-sac to be formed by a fusion of the two upper cells of the axile row, while as a matter of fact the embryo-sac arises from the lower cell in all except a very few cases. Although Marshall Ward found no evidence of a cell wall separating the two nuclei in the first division of the embryo-sac mother cell, he regarded these as representing two cells of the axile row.

There have been recent attempts to show that the embryo-sac in some cases is derived by a fusion of two cells of the axile row, where a weak or temporary cell wall is formed after the division of the nucleus (Wiegand, '98, in *Convallaria*). This, however, is more properly to be classed with the phenomenon so often exhibited in free-cell formation, where a temporary cell plate is laid down to be soon dissolved, and as often occurs in the first division of the pollen mother cell of different plants. Guinard ('81), in addition to citing this phenomenon as evidence that the embryo-sac is not formed by a fusion of two cells, adduces other strong evidence against it. In *Agraphis patula* (Mellink, '80) the axile row consists of two cells and the upper cell forms the embryo-sac, as Campbell ('99) has recently shown to be the case in *Peperomia pellucida*, while in *Caltha*, according to Mottier ('95), with a three-celled axile row, the upper one sometimes forms the embryo-sac. In *Narcissus tazetta* (Mellink, '80) there are two cells in the axile row.

The nucleus of the upper one undergoes repeated division without, however, forming the embryo-sac, which develops from the lower cell. Fischer ('80) reports a similar case in *Melica nutans* with an axile row of three cells; the two upper ones each contain two nuclei, and yet the embryo-sac is developed from the lower. Similar cases Guinard ('80) found in *Cereis*, *Phaseolus*, *Erythrina*, Miss McKenney ('98) in *Scilla*, and Wiegand in *Convallaria* (1900). The cells of the axile row with several nuclei, Guinard points out, are undeveloped embryo-sacs. Their nuclei divide several times in adjacent cells, but the intervening walls do not dissolve and permit the fusion of the two cells of the axile row to form the embryo-sac, which is always developed from a single cell. Other examples are known, like that shown by Strasburger in *Rosa livida*, Benson in *Fagus* and *Carpinus*, where several embryo-sacs side by side, or one above the other, begin to develop and attain considerable size, but do not fuse.

The weight of evidence then goes to show that the embryo-sac is developed from a single cell of the axile row, though this row may consist of but a single subepidermal cell, as in *Lilium*, *Tulipa*, etc., or of two, three, or four cells, as in other types.

If this single cell, the mother cell of the embryo-sac, or macrospore, is the homologue of a spore in a strict morphological sense it would be necessary to show that it is derived by the same, or similar, processes of development. In those plants where the axile row consists of four cells, the cells might be regarded as tetrads, or spores, one of which develops the embryo-sac, while the others degenerate. But their axile arrangement, so constant in all spermaphytes, is against that supposition, and indicates that the course of development of these cells is more in keeping with the development of adjacent nucellar tissue. The axile arrangement itself, however, would not

constitute a bar to their homology as spores. But in plants where the axile row consists of but two cells, or one cell, not even such a slight suggestion of their homology with spores is presented.

So far as investigation has been made, there is evidence that the development of spores in the bryophytes and pteridophytes, and in the development of the pollen in the spermaphytes, from a mother cell, is accompanied by nuclear phenomena known under the head of reduction of the chromosomes. It has been suggested that the reduction of the chromosomes in the formation of the embryo-sac might be employed as a criterion to determine what constitutes the spores. The facts, however, which have been obtained in the few cases investigated do not offer any more hopeful evidence as to the identity of the spores. In *Lilium*, and other observed cases, where the single cell develops directly into the embryo-sac, the reduction takes place in the first division. In other cases where an axile row of two, three or four cells is formed, the reduction of the chromosomes, so far as I know, always takes place in the primary mother cell of these, several cell divisions removed from the beginning of the embryo-sac. This is what we should expect, since this cell undergoes a maturation period prior to the formation of the axile row. So, whatever criterion we employ to determine the identity of the spores, we are led to irreconcilable confusion; either that the embryo-sac just prior to fertilization consists of 1, 2, 4 or 8 spores, or that it is developed in some plants from a spore representing one-fourth of a mother cell or sporocyte; in other plants from one-half of a mother cell, and in still others from the entire mother cell.

It is clear then that there do not exist here spores in the sense in which they are represented in the pteridophytes, or in the microspores of the spermaphytes; neither in actual form, nor according to processes



of development. How then does the embryo-sac of angiosperms arise? It arises directly from the nucellar (sporangial) tissues or from the archesporium, without the intervention of spores. In the pteridophytes such phenomena are classed under the head of *apospory*. The origin of the embryo-sac directly from sporangial tissue, considered only from the standpoint of the absence of spores, would also fall under the general category of *apospory*. But *apospory* merely does not indicate the real morphological significance of its derivation. It is to be interpreted as an adaptation of the plant in developmental processes under the influence of the changed and peculiar environment of the gametophyte, which has become so general in the angiosperms, and probably in the gymnosperms also.

There is no longer any need of spores, as such, in the development of the female prothallium of angiosperms. Where spores exist, as such, they exist for the purpose of distribution of the plants, as in the bryophytes and pteridophytes; in the spermatophytes for the distribution of the male prothallia, so that they may be lodged in a position where the sperm cells may reach the egg. There is a law in the evolution of organisms and organs, that when an organ or structure is no longer needed as such, it tends to disappear. Spores are not needed in the development of the embryo-sac. They are therefore cut out of the cycle of development, and the embryo-sac, or gametophyte arises directly from the tissue of the sporophyte.

In suggesting that the origin of the embryo-sac is a kind of *apospory*, we do not mean that it is phylogenetically connected with cases of *apospory* in earlier forms, nor that it is derived from them, nor that *apospory* as a phenomenon is continuous through groups. We simply mean that there has been a shortening in the process of development here, before the formation of the spores,

just as there has been a shortening after the beginning of the gametophyte, and it has gone so far that the spore, *as such, i. e.*, a spore which is formed by the accompaniment of the same phenomena which we know to prevail universally where we can recognize a definite spore, is *wanting*.

There is no need that such a spore or cell should be formed, because the necessity for it has disappeared. A cell, however, is formed which is not the morphological equivalent of a spore, but is the physiological equivalent, and develops the embryo-sac. The process is shortened so that the spore is cut out, and perhaps the mother cell forms the embryo-sac directly, a new development of a prothallium, or body functioning as such, directly from sporogenous tissue.

If Vines' suggestion (Student's Text-Book of Botany) that in *Asclepias* each cell of the pollinium is a mother cell, is correct, we should have a similar shortening process in the development of the male gametophyte. But this suggestion may not, possibly, be supported by the facts when we know the course of development of the pollinium and sperm cells in *Asclepias*. But we can conceive of a hypothetical case where a mechanism might arise for transporting the archesporium from an anther to the pistil bodily, and that the reduction in the anther had consequently gone so far that the tetrad divisions of the mother cell to form spores had ceased, now that there is no need for the individual and separate spore. The cell of the archesporium might form the pollen tube or male prothallium *directly*, cutting out the spore. This would be *apospory* so far as the loss of the spore is concerned. Its significance, however, would be greater. It would represent a new attainment in the evolution of the male gametophyte, quite independent of any phylogenetic relation to processes of development in earlier gametophytes.

The condition of things, however, in the ovule is very different from what it is in the anther, because early in the evolution of the spermatophytes the necessity for a definite spore for distribution disappeared, as the ovule retained the gametophyte within its nucellar tissue. The time has been long enough for the complete elimination of the spore. But in the case of the anther or microsporangium, the process has perhaps only begun; or perhaps it would be better to say that the conditions are being ushered in, in some cases where pollinia are formed, which in time may result in the elimination of the microspore from some of these forms.

In the elimination of the spore from the macrosporangium of the spermatophytes, they have arrived at a new morphological attainment, the development of the embryo-sac or gametophyte, directly from the archesporium or nucellus. The gametophyte of the angiosperms is very simple and rudimentary compared with that even of the gymnosperms, a few free cells, perhaps all of them potential eggs. Being free and few of them, they are in intimate relation with each other and are more subject to the secondary influences of fertilization than the endosperm cells of gymnosperms are.

Perhaps, for this reason, the angiosperms have arrived at a second and more remarkable morphological attainment, in the development of the second endosperm subsequent to fertilization. The interpretation of this may lie partly in the results of 'double fertilization,' and related phenomena, when the second sperm sometimes unites with one of the potential eggs, or with the 'endosperm nucleus' to form the second endosperm, or may possibly itself sometimes form a separate endosperm. It is well known that in the pteridophytes and gymnosperms often several eggs are fertilized in one prothallium, and several embryos begin to develop. Finally one of them usually outstrips the others, which

then atrophy. In the angiosperm embryo-sac the potential eggs are all free and so situated that they are immediately and profoundly influenced by fertilization of the 'privileged' egg.

The endosperm nucleus, or one of the other potential eggs, being fertilized by the second sperm, may be so immediately influenced that, instead of developing into an embryo which in a short time would be outgrown and destroyed, it is directed into a new channel of development, which has resulted in the evolution of a new plant generation to be utilized as a nutrition body by the privileged embryo. If the secondary influences of fertilization in angiosperms have acted somewhat in this way, it might account not only for the retarded development of the so-called 'endosperm' in the angiosperms, but also for some of the phenomena known under the expression *Xenia*.

GEO. F. ATKINSON.

---

NATURAL HISTORY WORK AT THE MARINE BIOLOGICAL LABORATORY, WOOD'S HOLL.

NATURAL history has been a growing element in the work of the Biological Laboratory at Wood's Holl. All departments represented at the Laboratory have made contributions in this field. Life histories have been studied principally in connection with embryological research, as, for example, in Conklin's work on 'Crepidula,' Lillie's on 'Unio,' Mead's on 'Annelids,' Foot's on 'Allolobophora,' Clapp's on the 'Toad-fish,' Patten's on 'Limulus,' Wheeler's on 'Insects,' Watasé's on the 'Fireflies,' etc. Within the last few years natural history studies have acquired wider and more independent interests with us. Animal behavior has engaged the attention of a number of investigators, led by Loeb, Wheeler, Thorndike and others. The demand for instruction followed the development of various lines of research, and the courses in general physiology and animal psy-

chology were, so to speak, spontaneous inevitables. The course in nature study, introduced for the first time last summer, furnished a typical illustration of the convergence of interests now cooperating at the Laboratory. Although the class only numbered fifteen members, over thirty investigators contributed to the instruction given, and a large share of the lectures, laboratory work and field studies were of the nature of research. Indeed, problems and demonstrations drawn from original work actually in progress, and presented by the investigators themselves, characterized the course throughout.

In the further development of this course in natural history, we are looking forward to hoped-for facilities far beyond our present realizations. The creation of a Natural History Farm at Wood's Holl may be somewhat remote still, nevertheless the project is entertained, and a small step has already been taken in anticipation. The columbarium now under cultivation is, I venture to hope, the first instalment of such a farm. This collection of pigeons, already the largest of the kind in existence, and rapidly increasing by accessions from all parts of the world, was undertaken with several ends in view. The pigeon group, containing between four and five hundred wild species, and not less than one hundred and fifty domestic species or varieties, offers one of the most favorable fields for the comparative study of variation and for experimentation in dealing with the problems of heredity and evolution. While the principal aim in making the collection was the investigation of problems, the farm project has been kept steadily in view. The columbarium would form one section of the farm, and exemplify its uses and unique advantages for every side of natural history.

Ever since the second birth of natural history in Darwin's 'Origin of Species,'

the need of experimental work on *living* animals has been clearly seen. The two elements of success in such work are *control* and *continuity*. Both elements would be secured in an institution that combined efficiently organized laboratories and a farm stocked, manned and equipped for experimental research.

The idea of such an institution was elaborated a long time ago in the 'New Atlantis,' in which is described a model college and farm instituted for the experimental study and interpretation of nature. This model was esteemed too vast and high for imitation, and the great and marvelous things it promised only served to emphasize its dreamland picturesqueness. It was only after the doctrine of Natural Selection had taken a deep hold of the scientific world, that Lord Bacon's dream found an echo in the schemes proposed independently by Romanes and Varigny.

The question of the transmutation of species stood foremost in the minds of these naturalists, and it seemed as if the world would never be quite convinced without experimental tests of a crucial kind. For such tests it was obvious that plants and animals must be studied as living things; that the conditions of life and propagation must be such as could be precisely defined and made to vary in ways admitting of control; and that the work must be carried continuously forward from year to year. Out of these requirements arose the idea of an experimental farm.

General biology, or modern natural history, is now seen to stand in pressing need of something like the model college of Bacon's *Nova Atlantis*, embracing not only an experimental farm, but also laboratories and a strong body of investigators with a competent staff of assistants. Naturalists everywhere appear to be fully awake to this important need, and Professor Meldola (*Nature*, Feb. 13, 1896) did not ex-

press too strongly the general conviction when he declared—"The one great desideratum of modern biology is an experiment station where protracted observations can be carried on year after year on living animals."

The ideal plan would certainly make the farm an integral part of a natural history institute, according to the idea of the Baconian model; and herein may be seen the propriety of the name, 'Baconian Institute of Experimental Evolution,' proposed for such a foundation by Professor Osborn.\*

An institute organized to meet the common needs of naturalists, and supported as a biological center—conditions approximated at Woods Holl—would obviously supply a strong combination of forces, and so ensure to a natural history farm its higher utilities as a source of scientific discovery and of unparalleled facilities for instruction.

C. O. WHITMAN.

CHRISTIAN FREDERIK LÜTKEN.†

THE death of Professor Lütken of Copenhagen removes one of the last of that band of eminent zoologists whose long and active lives cast such luster on the Scandinavian countries throughout the last century.

Christian Frederik Lütken was born in Sor on October 4, 1827, the son of Professor Johannes Christian Lütken, Reader in Philosophy at the Academy there. It was during his last year's study at the Academy, which he entered in 1844, that young Lütken was induced by the lectures of Hauch and Steenstrup to turn seriously to zoology; and this he pursued when he passed to the University of Copenhagen in 1846. There he came in contact with Liebmann, Forchhammer, Ibsen, Eschirecht,

\* 'From the Greeks to Darwin,' p. 93.

† Much of the personal matter in this notice is gleaned from an article by H. F. E. Jungersen in *Illustreret Tidende* (Copenhagen) for February 17th. The article is accompanied by an excellent portrait.

H. C. Oersted, and 'again Steenstrup, who was in the same year appointed professor of zoology at the University. Lütken's zoological studies were, however, interrupted by the troubles of 1849-50 (first Schleswig-Holstein war), when he served as a volunteer and took part in the battles of Ullerup and Isted. He was accorded permission to complete and publish his first scientific work during the winter 1849-50, and in 1852 finally left the army to fill a place as assistant in the Zoological Museum of the University, taking the degree of Magister in the following year. The position at the small University Museum was neither assured nor well paid, but it was improved some ten years later, when the Royal Museum was joined with that of the University to form the existing Museum of Natural History, in the second division of which (dealing with fish and lower animals, except Arthropoda) Lütken served as assistant to Steenstrup. It was not till the death of J. Reinhart in 1882 that he obtained an independent appointment as Inspector of the First Division, which was now made to include all vertebrates. After Steenstrup's retirement, on January 28, 1885, Lütken was appointed professor of zoology at the University and thus became chairman of the Museum Board, while he continued to direct the Division of Vertebrata. In 1885 he married his cousin Mathea Elizabeth Müller, who died in 1890, leaving no children. Some five years later Lütken's own energies began to yield to attacks of illness; in the summer of 1898 he had a paralytic stroke from which he never recovered; he therefore retired from his official posts at the beginning of 1899, and after a long struggle finally succumbed on the 6th of February at the age of 73.

Lütken's labors fall under the heads of museum work, education and descriptive zoology.

The Zoological Museum of Copenhagen,

with which he was connected for 47 years, is greatly indebted to his organizing power, and was constantly benefited by the friendly relations that he maintained with his colleagues in other lands. This was the branch of his work for which he was peculiarly fitted by his patience and accuracy, and to which he was most attracted. Among the gifts which, from very slender means, he contrived to make to the museum may be mentioned a valuable collection of fossil mammals.

For a teacher, and particularly a lecturer, Lütken was less qualified. His manner was reserved and unsympathetic, his style too literary. These defects were scarcely counterbalanced by the thoroughness with which he prepared his lectures. His great text-book, 'Dyre-riget,' published in 1855, was stuffed full of facts, laboriously collected and verified, but lacked the simplicity required in an educational work. This fault was remedied in the briefer manuals familiar throughout Danish schools as 'Lütkens, Nos. 2 and 3.' Indeed, as a writer for the public, Lütken could be clear enough. In addition to many popular sketches of animal life, he, together with C. Fogh and Chr. Vaupell, edited the 'Tidskrift for populære Fremstillinger af Naturvidenskaben,' which had a remarkably long life for a magazine of that nature, namely from 1854 to 1883. This literary interest took him away from the open-air studies of marine zoology that he had begun in his student days, while his museum duties led him still more to the 'dry bones' of his subject. Recognizing his own deficiencies, he succeeded in obtaining an annual grant for the founding of a Biological Station, where, under the guidance of younger men, his students could take a biological course. As a member of the Fishery Board also he successfully urged on the Government the need for a detailed study of the natural conditions of Danish

waters before any legislation could be effective.

As a museum assistant Lütken's technical zoological writings were inevitably confined to the description and classification of the material in his charge. Corals, jellyfish, crustaceans, isopods, annelids, ascidians, blindworms, all came beneath his survey, but his chief work lay among echinoderms and fishes. In the former group his doctoral thesis 'On the Echinodermata of Greenland, and the geographical and bathymetric distribution of that class in northern seas' (1857) holds a foremost place. He wrote also on starfish, sea-urchins and West Indian crinoids, but his chief systematic work was done on the ophiurids. In this department he has of late found an able fellow-worker in Dr. Th. Mortensen. In ichthyology his earliest work of importance was on the classification of the Ganoids, the complete memoir appearing in 'Palæontographica' (1873-75). While describing and classifying the numerous fish that came to him from all parts, but chiefly from northern seas, he was by no means unmindful of wider questions, as was proved by his most important work 'Spolia Atlantica,' of which the first part, published in 1880, discussed the changes of form in fish during their growth and development. The second part, issued in 1892, dealt with the distribution of the phosphorescent patches in certain deep-sea fishes, and is thus alluded to by Goode and Bean in 'Oceanic Ichthyology': "Dr. Lütken's masterly and exhaustive paper on the Scopelids of the Zoological Museum of the University of Copenhagen \* \* \* has rendered it necessary to completely revise our opinions upon the relations of the species."

All Lütken's work, like that of so many of his Scandinavian contemporaries, was marked by thoroughness, accuracy and a wide knowledge of previous writings. Al-

though well acquainted with foreign languages and a writer of good English (as proved by his contributions to the *Zoological Record* from 1872 to 1878, and by his admirable article on Steenstrup in *Natural Science* for September (1897), he preferred, as a rule, to publish in his native language. This, while a benefit to the Danish school, has not prevented foreign zoologists from recognizing the value of Lütken's work; abstracts have appeared in many English and other journals, and honors have been showered on the author. His death causes a vacancy in such societies as the Royal, Linnean and Zoological Societies of London, the Imperial Academy of Sciences of St. Petersburg, the Imperial and Royal Zoological and Botanical Society of Vienna, the Boston Society of Natural History and a vast number for whose names we have no space.

Lütken was a tall and handsome man of the fair Danish type, with a keen blue eye. His upright and somewhat stiff demeanor might be a reminiscence of his military service. But his reserve did not prevent one from seeing the thorough worth and single-mindedness of his life and thought, nor did it check his really kind disposition, as experienced not only by his family and closer friends, but by every foreign visitor to him in his Museum at Copenhagen, and every correspondent who sought his aid.

F. A. B.

#### SCIENTIFIC BOOKS.

##### PROGRESS OF FOREST MANAGEMENT IN THE ADIRONDACKS.\*

THE recent report of the Director of the New York State College of Forestry and the College Forest in the Adirondacks is a document of more than ordinary interest, dealing as it does with questions that are now engaging the attention of the legislatures of several States and

\* Third Annual Report of the Director of the New York State College of Forestry, Ithaca, N. Y., March, 1901.

to which much thought is being given by citizens who are interested in the public welfare.

As shown by the report, the number of students has increased from four, the number three years ago, to twenty-five and, in addition to these regular students, there are registered twenty-nine from the Colleges of Architecture, Civil Engineering and Agriculture. The five students who went out from the school last year have found satisfactory employment, three with the Forestry Division of the United States Department of Agriculture, one with a lumberman's firm and one with the Forest, Fish and Game Commission of the State of New York.

In addition to the work of the three professors of forestry, many of the professors and instructors in other Colleges of Cornell University have aided in giving instruction, and lectures on fish culture have been given by Dr. B. W. Evermann, of the United States Fish Commission, and a short course in practical timber-estimating was given at Axton by Mr. C. P. Whitney, a well-known estimator, while courses on marketing the forest crop, as well as special courses in law and engineering, have been arranged for.

The plan of requiring practical work of the junior and senior classes in the College Forest has proved satisfactory and has become a permanent arrangement. The work embraces inspection of logging operations, timber estimating and measuring, surveying and locating roads, nursery work and planting, marking trees for cutting, practical work in the sugar orchard, and excursions to fishing grounds and hatchery.

Aside from this, the distinctively educational work of the College, the problem of the management, development and satisfactory utilization of the forest property—thirty thousand acres in the Adirondacks—with which the College is entrusted has been fairly met. It involves securing a market for the wood, much of it already past maturity and rapidly deteriorating, and the perpetual renewal of the forest by planting or natural regeneration, so as to provide both for future cutting and improvement of the property. The widely different conditions under which European forestry is prac-

ticed make it an impossible guide in the present case, except as to principles, while the manner of their application has taken perforce the form of original experimental study of a most difficult problem.

The director ably defends the policy of harvesting the crop as carried out at the College Forest, a policy made possible by special legislation, which has permitted the entering into contracts for the disposal of the old and decrepit hardwoods forming the bulk of the culled forest. Such contract has been made with the Brooklyn Cooperage Company, under which a stave and heading factory and a wood alcohol plant are being erected at Tupper Lake and connected by rail with the College forest. The prices obtained are fair market rates, better than private owners of similar property in the Adirondacks have been able to get the present year, and the experiment, in spite of an unusually unfavorable winter, promises to be self-supporting. It is expected that about 50 per cent. of the area cut over during the time covered by the report will have to be planted. White pine and Norway spruce will be employed, using both plants and seeds, and adding elm and ash, with a few other species.

Various important questions have arisen in connection with the actual and possible yield of Adirondack hardwoods, and these, together with the ideals and practical limitations of American forestry, are carefully discussed. It is shown that the American market is the essential factor which makes the practice of forestry as a business different in the United States from that of Germany, and that this, again, is due to the difference in density and distribution of population. Accordingly, the German wood market is mostly local, steady and continuous. A sustained annual yield is the best business policy, and a thorough utilization down to the small brush is possible through local consumption by the dense poor population. The American wood market, on the other hand, is essentially continental; the harvest is transported to centers of consumption, and cheap transportation over long distances is the keynote of marketing it profitably. This requirement in many districts rules out a thorough utilization of the product, and inferior parts of the har-

vest must be left unused. Hence a realization of the theoretically 'normal forest' with a so-called 'sustained yield' is at present impracticable in America from a business point of view. And, moreover, unfair systems of taxation discourage the attempts at such management that otherwise might be made. The working plan of the College, therefore—carrying out the aim of the management to attain the best that is attainable under existing conditions—is simply to remove the old crop as fast as the market and practical considerations permit, and replace it by a crop of better composition and promise; *that is, to practice silviculture.*

The basis of an American system of forestry is summed up in three primary essentials:

1. Better protection of forest property, including rational methods of taxation—a subject of legislation.
2. More thorough utilization of the forest crop—a subject of wood technology and development of means of transportation and harvesting.
3. Silvicultural methods of harvesting, so as to produce a desirable new crop, or else artificial reforestation—the main concern of forestry.

Planting operations on burnt areas have been continued and there are now ninety-five acres planted, chiefly with white pine, Douglas spruce and Norway spruce, the last named having thus far proved most satisfactory as to cheapness, rapidity of growth and endurance of drought and frost. Two nurseries have been established in which already about a million seedlings of various conifers have been raised for use in planting and for experiments in acclimatization. An experienced forester, whose professional education was had in Switzerland, is in charge of all the technical work, such as supervision of felling, planting and nursery work, conducting of experiments, collecting of data and statistics, and making reports, while the purely business arrangements, such as hiring of labor, purchase and sale of materials, care of property, and the book-keeping and sealing are in charge of a superintendent familiar with such duties. A logging foreman of experience is in charge of the crew and camp, supervising the labor. The College is now in a position to dispose annually of upwards of 15,000 cords of wood for fuel and

the retort, and from 2,000,000 to 4,000,000 feet of logs. The fullest possible utilization of the entire product down to the brushwood, two inches in diameter, has been accomplished, and even the brushwood has been employed to some extent in the production of wood alcohol and in other ways.

That so extensive a series of operations should have been embodied in an actual system of forestry, for which there are no existing models, that a market should have been created and the experiment conducted with good prospect of being self-supporting from the start; that in a country thus far without schools of forestry that could be drawn upon for trained men, and with the practical difficulties attending the importation of foreign specialists, it has been possible to equip and conduct such a school and forest, is sufficient testimony to the ability of the director, who, in the face of extraordinary difficulties, has successfully conducted an undertaking never before attempted, and one of immense importance and promise.

Aside from its value to the State of New York, which has liberally maintained it, the establishment of the school and the College Forest is a matter of great moment to such other States as are immediately concerned with forestry problems and are contemplating necessary legislation.

V. M. SPALDING.

*Zoological Results based on Material from New Britain, New Guinea, Loyalty Islands and elsewhere*, collected during the years 1895, 1896 and 1897, by Arthur Willey. Cambridge, Eng., the University Press. 4to. Part IV. 1900. Pp. viii + 174; pls. 20.

The fourth part of Dr. Willey's 'Zoological Results' contains ten contributions covering a wide range of topics. The first is by J. S. Gardiner and deals with a supposed new species of coral, *Cœnopsammia willeyi*. A very full description of the anatomy of this animal is given and some interesting conclusions concerning its germ layers are drawn. The actinozoa are usually described as covered externally with ectoderm, which at the mouth is reflected inward so as to line the gullet. From the inner end of the gullet the ectoderm is continued as mesenteric filaments over the free edges of the

mesenteries. The walls of the gastrovascular cavity are usually said to be lined with entoderm. Gardiner points out that digestion does not take place in the gastrovascular cavity of these animals, but in the so-called gullet whose deep end is imperfectly closed by the mesenteric filaments. The cell lining of the gastrovascular spaces, instead of being concerned with digestion is made up of epithelial muscle cells and of genital cells. These conditions have led Gardiner to redefine the limits of the germ layers in the anthozoa. The layer covering the exterior of the animal is the ectoderm. At the mouth the ectoderm is continuous with the layer lining the gullet and giving rise to the mesenteric filaments. As these are the parts chiefly concerned in digestion, this layer is the entoderm. The lining of the gastrovascular cavity, muscular and reproductive in character, is the mesoderm. Thus the actinozoan is not a diplo-blastic, but a truly triplo-blastic animal.

The paper is well illustrated and the two text figures which show the relations of the calcareous skeleton to the soft parts in *Cœnopsammia* will be welcomed by teachers in general as well as by students of the corals.

The second contribution is a report on the insects of New Britain, by D. Sharp. It consists of notes on some fifteen species of beetles, and on several bees, wasps, and flies. One of the wasps collected, probably *Polistes colonicus*, had the strange habit of laying several eggs in a cell, though in the end only one mature insect emerged from each cell. How the supernumerary larvæ were disposed of and whether this habit was an individual peculiarity or a characteristic of the species were not determined.

Borradaile's account of the crustaceans shows that eighty-two species of stomatopods and macrurans were collected and that twenty of these were new to science.

The slugs were studied by W. E. Collinge, from whose work it appears that six species were found, two of which were new. One of these, *Veronicella willeyi*, is made the basis of a full anatomical study.

According to E. G. Philipps sixty-three species of Polyzoa were collected, of which nine were new. L. R. Thornely notes thirteen species of



hydroids, ten of which have never before been described.

J. J. Lister presents an extended report on a peculiar hard white organism found growing on dead coral in thirty-five fathoms of water. It was made up of a continuous skeleton of solid polyhedral elements penetrated by a system of anastomosing canals; these were lined with soft tissue and were open to the exterior. The soft tissue contained here and there what seemed to be large unsegmented eggs and other masses which had the appearance of parenchymular larvæ. Taking all these peculiarities into account, the author believed the organism to be a sponge, but of so unusual a structure as to justify the erection of a new family for its reception. The species is called *Astrosclera willejana*, and the family *Astroscleridæ*.

A series of embryo mound birds and one hatched nestling are reported on by W. P. Pycraft. The feather tracts of the embryo and the nestling plumage are described in detail. The birds are able to fly almost upon hatching, and this has led to the idea that they were at once provided with adult plumage. Pycraft points out that their plumage is not adult, though it is also not true nestling down.

S. J. Hickson and I. L. Hiles report on certain of the octocorallia, two species of *Stolonifera* and twenty species of *Alcyonaria*, three of which are new. The *Xeniidæ* are described by J. H. Ashworth. Of the sixteen known species of soft corals belonging to this genus, Dr. Willey's collection contained representatives of four, as well as material upon which the description of a new species is based.

G. H. PARKER.

*The Austin [Texas] Dam.* BY THOMAS U. TAYLOR. Water-Supply and Irrigation papers of the United States Geological Survey, No. 40. Washington, Government Printing Office. 1900. Pp. 52, pl. xvi.

In this publication Professor Taylor, of the Engineering Department of the University of Texas, gives an account of the inception, building, and failure of the 'Austin Dam,' a municipal undertaking for the purpose of controlling the water supply of the Colorado River.

The first foundation stone was laid May 5,

1891, and the disaster, due to an unprecedented flood, occurred April 7, 1900.

As remarked by Mr. F. H. Newell, in his letter of transmittal, "There are many useful lessons to be drawn from the history of such an enterprise, for it often happens that failure is more instructive than success. Throughout the United States many communities are now discussing the utilization of water power for irrigation and other industrial purposes, and they may be saved from mistakes or be led to adopt precautionary measures by a clear understanding of the causes of the disasters which have occurred through the neglect of certain precautions."

The scope of the paper may be seen from the following general headings: Introduction, Preliminary Projects, Construction of Dam, Leak under Head Gate, Flow of Colorado River, Economic Aspect, Silting of Lake McDonald (the body of water back of the dam), Failure of the Dam. The illustrations are both numerous and excellent, some being from photographs taken immediately after the accident.

Among the errors pointed out are the following: That the minimum flow of the river had been greatly overestimated, hence the power developed upon the completion of the dam fell far short of that hoped for; that evaporation as a factor had almost been lost sight of, that the engineers in charge of the work of construction (the dam cost \$611,345.29) had been hampered and interfered with in the prosecution of their labors; and that the geologic conditions prevailing at the site had been ignored. To these errors are attributed the failure of the enterprise to meet the expectations of the public and its failure as an engineering feat.

While Professor Taylor's paper is of the greatest interest to the engineering profession, there is much of value in other lines, as, for instance, the carefully conducted investigation of the silting up of Lake McDonald.

FREDERIC W. SIMONDS.

February 19, 1901.

#### SCIENTIFIC JOURNALS AND ARTICLES.

*The American Geologist* for January contains an article by S. E. Bishop on 'Brevity of Tuff

Cone Eruptions.' The discussion is devoted principally to the formation of the cone Leahi, or Diamond Head, in Honolulu, which the author claims, and attempts to prove, was formed by an extremely rapid projection aloft of its material for a few hours, ceasing suddenly and finally. The article is accompanied by a plate. 'Possible new Coal-Plants, etc., in Coal,' Part III., by W. S. Grisley, Erie, Pa. The writer describes and figures about fifty fossils which he thinks may be coal plants hitherto undescribed. Most of the forms described come from a coal bed in Iowa. Mr. John Dresser discussed the 'Petrography of Mount Oxford,' a large igneous mass in the Green Mountains of Vermont. The main part of the mountain consists of graywacke, serpentine, opicalcite and sandstone. A paper follows 'On Some Newly Discovered Areas of Nepheline Syenite in Central Canada,' by Willet G. Miller. In a very interesting paper on 'Peneplains of the Ozark Highlands,' Oscar H. Hershey discusses the life histories of certain parts of the Ozark region. The changes may be briefly put as follows: (1) The entire region was reduced to base level forming cretaceous peneplain. (2) A great dome-shaped uplift occurred in the southern two-thirds of the region, and it was base-leveled again during the Tertiary. (3) A general uplift throughout the Ozarks, which was again eroded and base-leveled in some places during the Pliocene. (4) Another general uplift, greatest in southern Missouri. (5) A local uplift of the Boston Mountains during the modern epoch. Following are the 'Reviews of Recent Geological Literature' and 'Personal and Scientific News.'

In *Popular Astronomy* for April Herbert A. Howe continues his discussion of astronomical books for the use of students, taking up general popular works, descriptive text-books and handbooks. Professor Harold Jacoby, of the Astronomical Observatory of Columbia University, writes under the title of 'The Astronomer's Pole,' of the work to be done at the new Helsingfors Observatory. Illustrations of the instruments and building accompany the article. Anderson's 'New Star in Perseus' is the subject of several articles, and notes. Circular No. 56, from the Harvard Observatory, by E.

C. Pickering, with reference to the Nova is printed in full; the first chart and catalogue for observing it is given by J. G. Hagen, S. J., of the Georgetown College Observatory, Washington, and Dr. H. C. Wilson, of Goodsell Observatory, adds much to the general information of the Nova, and includes a chart of its light curve. Shorter articles are by R. W. McFarland, on 'Ancient Eclipses and Chronology'; by Dr. George Bruce Halsted on 'Astral Geometry,' and by A. E. Douglass, on 'Photographs of the Zodiacal Light'; the latter is accompanied by an excellent plate. Eclipse cyclones are discussed, and there is a translation of H. Arctowski's article on 'Northern and Southern Lights illuminating the Heavens at the Same Time,' which recently appeared in *Ciel et Terre*. Planet, spectroscopic, comet and asteroid notes occupy the usual space. Among the 'General Notes' are the following: Board of Visitors at the Naval Observatory, Trouble at the Naval Observatory, Naval Observatory Legislation, Observations of Nova Persei at Seagrave Observatory, At Yerkes Observatory, At Ladd Observatory, At Vassar College Observatory, At Pomona College, Notation of New Variables, Nomenclature of Variable Stars, Crocker Eclipse Expedition to Sumatra, Spectrum of  $\zeta$  Puppis, Evanescent Star Photographs.

In Italy has just appeared a new mathematical journal, issued at Città di Castello, by the publisher, S. Lapi, to whom the annual subscription, 12 francs, should be sent. It is a monthly magazine, called *Le Matematiche*, under the direction of Professor C. Alasia, with a board of collaborators, among whom the English language is represented by G. B. Halsted, of Austin, Texas, to whom communications may be sent, which will appear in Italian. On the editorial board may also be noted the Russian, Vasiliev, and the greatest of living mathematicians, Poincaré. The first number, February, 1901, contains the last thing written for publication by the illustrious Hermite, dated January, 1901, on the 14th of which month he died. The magazine has a suggestive new department, headed 'Subjects for Research.'

WE have received with pleasure the first number of *School Science*, a monthly journal

devoted to the teaching of science in secondary schools, edited by C. E. Linebarger and published at Chicago, Ill. There are twelve associate editors, all teachers in secondary schools, and the contributions given in the first number and promised are chiefly from teachers in secondary schools, though the present number contains contributions from Professor Palmer, of the University of Colorado, and Professor Nichols, of Cornell University. The journal is evidently edited with care, and will exert an excellent influence.

#### SOCIETIES AND ACADEMIES.

##### ANTHROPOLOGICAL SOCIETY OF WASHINGTON.

THE 314th meeting of the Anthropological Society was held on March 12th.

Dr. J. Walter Fewkes presented some historical documents, consisting of a fac-simile of the map of Padre Menchero (1747) of the territory now embraced in Arizona and New Mexico; a fac-simile of the map of Juan de la Cosa (1500), showing the famous demarcation line of Pope Alexander II. and the discoveries in the New World at that period, and an unpublished manuscript of Antonio Alzate, describing the ruins of Xochicalco, Mexico. The Menchero map, which is rare and little known, gives the locations of the missions in the Southwest, and valuable ethnological data. It was issued at Berlin. The Cosa map was copied during the Columbian Historical Exposition at Madrid in 1892-3 from the original lent by the Vatican. Dr. Fewkes pointed out that Alzate was the first to call attention to the need for preserving the ruins in Mexico.

President W. H. Holmes presented instruments of execution and torture, exhibiting an iron cage found some years ago by workmen engaged in road building in King George County, Virginia. This cage is constructed roughly on the outlines of a human body, and on discovery contained a human skeleton, most of which is still preserved. Mr. Holmes said that no documentary evidence has yet been found of 'hanging in chains' in the United States. He called attention to a similar gibbet found in Jamaica and stated that this form of post-mortem exposure of the bodies of criminals

is English, and was practised as long ago as the twelfth century. The last gibbet was constructed and used in England in 1832. There is no very reliable record of the hanging of living persons in these cages, although tradition has it that such was the practise. At the close of his remarks Mr. Holmes exhibited a large collection of instruments of torture brought to this country from Hanover, Germany, by Anton Heitmuller, of Washington.

The first paper of the evening was entitled 'Ethnology in the Jesuit Relations,' by Mr. Joseph D. McGuire. Mr. McGuire has carefully gone over the collection of Relations, recently published under the editorship of Reuben Goldthwaites, extracting all ethnologic and archeologic data. This paper is the first of a series having in view the rehabilitation of the American Indian at the period of first contact with the white man, as far as can be done by examination of the literature. Mr. McGuire's paper was listened to with much interest.

Mr. W J McGee's paper on the 'Cocopa Indians' occupied the remainder of the session. Mr. McGee went into considerable detail as to the arts and customs of the Cocopas, whom he visited last summer. The custom of burning the house of the deceased, and the communistic division of the property among the friends, exclusive of the relations, in the event of a death, coupled with the periodical removals from the flood-plain of the Colorado to higher ground, and *vice versa*, have exerted a profound repressive influence on the Cocopas. These Indians were found to be at a low ebb numerically and physically, and are without doubt rapidly tending to extinction.

WALTER HOUGH.

##### THE SCIENCE CLUB OF UPPER IOWA UNIVERSITY.

THE last regular meeting of the Club was held February 27th. Arthur E. Bennett described his researches among the prehistoric remains of New Mexico, including skeletons, utensils, pursuits, pottery, decorations, worship, etc. He stated that the plain, mesa and cliff dwellers were really one people. At the next meeting he proposed to discuss the prob-

able cause of extermination of these people. He has spent four summers on the ground.

A second paper, read by Bruce Fink, was an ecologic study of the swamp vegetation of northern Minnesota. *Marchantia*, *Sphagnum*, the conifers, the heaths and the orchids were especially considered. No less than thirteen species of orchids collected in these swamps were exhibited, and it was incidentally stated that fourteen species have been collected within ten miles of the University at Fayette, Iowa.

SCIENCE CLUB OF THE UNIVERSITY OF  
WISCONSIN.

THE regular monthly meeting of the club was held on March 1st, at 7:30 P. M., President E. A. Birge presiding. The program of the evening consisted of an address by Professor Ira Remsen, of Johns Hopkins University, on the subject, 'The Outlook in Chemistry.' The speaker emphasized the importance of the researches of such men as Cavendish, Scheele, Priestley, Lavoisier, Berzelius, Liebig and Wöhler. He characterized the work of Lavoisier as revolutionary, and stated that since his time such revolutions have not marked the progress of chemistry. The advance of chemistry, and of other sciences as well, was spoken of as taking place in waves. After the important, fundamental work at the close of the eighteenth and the beginning of the nineteenth century came the activity in organic chemistry, while at present a large amount of energy is directed to physical chemistry in particular. After mentioning some of the triumphs of synthetic work in organic chemistry, Professor Remsen expressed the opinion that a long time would still have to elapse before all the various products of organic beings could be prepared in the laboratory. An audience of about five hundred persons listened to the lecture, which abounded in food for thought interspersed with appropriate anecdotes and witticisms.

LOUIS KAHLBERG.

THE ELISHA MITCHELL SCIENTIFIC SOCIETY.

At the 133d meeting of the Society, on March 12th, in the Chemical Lecture Room of the

University of North Carolina, the following papers were read:

'A Marsupial Track in the Triassic,' Professor Collier Cobb (by title).

'A New and True Antidote for Carbolic Acid,' Professor E. V. Howell.

'Yellow Fever and Mosquitoes,' Professor R. H. Whitehead.

'The World's Production of Iron and Steel,' Professor Chas. Baskerville.

CHAS. BASKERVILLE,  
Secretary.

DISCUSSION AND CORRESPONDENCE.

THE DATE OF RAFINESQUE'S DEATH.

EDITOR OF SCIENCE: In looking over some back numbers of SCIENCE quite a year old, I have happened upon the interesting letters between Rafinesque and Professor Wagner as given by Mr. T. L. Montgomery in SCIENCE for March 23, 1900. I do not know how I came to miss this item of so long ago, else this note would have been sent you in earlier reply.

The date of Rafinesque's death is correctly given by me in my 'Life and Writings of Rafinesque' as September 18, 1840. I am aware and at the time was aware of the date September 18, 1842, as cited by Mr. Montgomery. I also am aware that all the dates he cites from the various authorities he names are incorrect and all started from the same original error. Evidently an overlooked typographical error in the original publication was the cause.

If Mr. Montgomery had looked carefully at the certified copy of Rafinesque's will, which forms the end of my volume, he would have noted that on November 16, 1840, the signature was attested as being that of Rafinesque by two persons, James Henry Horn and Sam Hood; that on November 28, 1840, James Mease, as executor, was duly sworn for that office and each of the above facts dated in November, 1840. Of course it is hardly necessary to say that wills are not probated two years before a man dies.

The date 1842 is often found in biographical notices of Rafinesque, but all seem to originate in the error of the first notice. I have always imagined that date to be a typographical error. My authority for 1840, as the year, is the will

of Rafinesque probated in November of that year.

R. ELLSWORTH CALL.

BROOKLYN, N. Y., March 14, 1901.

#### LUNAR HALO.

TO THE EDITOR OF SCIENCE: On February 25, 1901, there was visible in this locality a lunar halo of rather peculiar form. After vain attempts to find an explanation of it the writer asks the privilege of an appeal to the readers of SCIENCE. This phenomenon consisted of an elliptical ring around the moon with axes apparently about six degrees and nine degrees respectively. The principal axis of the ellipse was vertical while the terminator of light on the moon's surface made an angle of about 45 degrees with the horizon. The moon was about half way down in the southwest and half full. A southeast breeze was blowing and very thin fleecy clouds could be seen passing over the face of the moon. The ring persisted for fifteen minutes or more.

The peculiar orientation of the terminator and major axis is the difficult part to explain. One might expect an elliptical though perhaps ill-defined ring from an elongated source of light, but why should the major axis be inclined to the terminator?

C. M. BROOMALL.

MEDIA, PA., March 23, 1901.

#### SHORTER ARTICLES.

##### THE LARGEST KNOWN DINOSAUR.

THE Field Columbian Museum paleontological expedition of the past summer was fortunate in securing a number of Dinosaur bones belonging to an animal unique both in size and in proportions. These bones consist of a femur, a humerus, a coracoid, the sacrum, an ilium, a series of seven presacral vertebrae, two caudal vertebrae, and a number of ribs. Part of this collection has been placed on exhibition and the remainder will follow from time to time as the work of preparation proceeds.

The most striking characteristic of this animal, so far developed, is the relative length of the front and hind legs. While the humerus of *Brontosaurus excelsus* Marsh is a little more

than two-thirds as long as the femur, the humerus of the individual in question is decidedly the longer bone of the two.

The femur is a stout bone with expanded condyles and a head not constricted from the shaft. The specimen is somewhat crushed anteriorly, but otherwise in a fine state of preservation. Its greatest length parallel to the axis of the shaft is 80 inches (2,003 m.), which is six inches longer than the femur of Marsh's *Atlantosaurus*. The humerus is broad at the proximal end, but unusually slender in the shaft. It has suffered somewhat from weathering, so that the entire surface of the distal end has flaked away, leaving a firm chalcidony core. In this condition its length is equal to that of the femur; with the articular end complete it would probably exceed it by two or more inches. Its present length is greater by 23 inches than the longest humerus hitherto known to science.

The coracoid is broad and straight at the scapular articulation, but less massive than that of *Brontosaurus*. The sacrum is made up of four coossified vertebrae, having small lateral cavities in the centra. A complete rib, presumably from about the sixth presacral vertebra, measures more than nine feet in length. Some of the thoracic ribs have a secondary tubercle, and also a foramen leading to a cavity in the shaft. However, these may not prove to be constant characteristics.

The similarity of the femur to that of *Atlantosaurus*, together with the presence of but four vertebrae in the sacrum, suggests that this animal may belong to that group. The writer does not feel justified in creating a new genus until the material still have been sufficiently worked out to make an accurate determination possible. However, the evidence at hand is sufficient to show that we have here to do with an animal which differs radically from any well-known Dinosaur. The extraordinary length of the humerus, together with the size of the coracoid, suggests an animal whose shoulders would rise high above the pelvic region, giving the body something of a giraffe-like proportion. The relatively smaller size of the anterior caudal vertebrae indicates a lesser development of the tail than is common among the sauropod

Dinosaurs. Along with these proportions we may well expect to find a correspondingly shorter neck and perhaps an animal fitted for arboreal food habits. Such a short-necked type was long since suggested by Marsh in his *Apatosaurus laticollis*.\*

In a future publication of the Field Columbian Museum a complete description of this most interesting Dinosaur will be given.

ELMER S. RIGGS.

FIELD COLUMBIAN MUSEUM,  
March 16, 1901.

#### A RECENT FAULT-SLIP, OGDEN CANYON, UTAH.

It is generally known that the western face of the Wasatch range, Utah, is determined by a profound fault, and that numerous minor faults are observable at the base of the range. At the mouth of Ogden canyon these secondary faults are particularly plain. Recently there occurred at the locality named a very slight slip along one of the minor fault planes. The movement opened a crack in a mass of gneiss through which a tunnel has been cut as a part of the conduit pertaining to the Ogden Power and Light Company's generating plant. The tunnel walls were fractured, a crack averaging one and a half inches appearing on the inside. The escaping water found outlets on the mountain side at depths of from fifty to a hundred and fifty feet below the tunnel floor, and in its course it carried down many tons of boulders and debris. A steel bridge over the Ogden river was completely destroyed. The disturbance was strictly local, and apparently was due to the escape of water from the tunnel down the plane of faulting, thus constituting a column which by hydrostatic pressure further shifted the block. As to expansion through freezing being the probable cause, there is none but negative evidence. Repairs are in progress. These consist in the removal of the upper part of the shifted block, and in carrying a wooden pipe line through the tunnel.

It appears that the water was first seen issuing from the side of the mountain below the tunnel within a few days after the occurrence of a slight earth-tremor in the vicinity. In the loose alluvial deposits along the mountain front

\* *Amer. Jour. Sci.*, Vol. XVII., p. 87.

on the north of the canyon mouth, cracks and subsequent settlements have appeared.

J. E. TALMAGE.

#### QUOTATIONS.

##### THE U. S. NAVAL OBSERVATORY.

THE Secretary of the Navy has temporarily ended the Naval Observatory troubles, without the aid of a court of inquiry or court-martial, by detaching Professor Stimson J. Brown from the institution. \* \* \* It would seem from this that Secretary Long shares with Capt. Davis, the superintendent of the Observatory, the belief that Professor Brown transgressed the naval regulations in his efforts to have Congress pass the legislation needed to make the institution a great national one, and not a mere adjunct to the navy. As Capt. Davis's tour of shore duty expires before long, a new superintendent may be looked for within six months, and peace in the Observatory may be expected until the new superintendent and new director of astronomy come to a parting of the ways. Meanwhile, scientists all over the country are being urged to come to the rescue of the Observatory by bringing pressure to bear upon Congress. A bill which met the approval of SCIENCE was introduced in the Senate in the last session by Senator Morgan. It provided for the nationalization of the Observatory and for the appointment as director of an eminent astronomer, 'to be selected from the astronomers of the National Academy of Sciences, unless in the judgment of the President one of higher scientific and executive qualifications be found.' Friends of the institution should see to it that a similar bill is introduced at the opening of the next Congress and vigorously pushed to passage.—The N. Y. *Evening Post*.

##### POLITICS AND STATE UNIVERSITIES.

To form a just conception of the working of the State university, we should go to the older States of the Central West, where State universities have long been in existence, and where they have had time to shape, in a measure at least, public opinion on university education. In this part of the country the four most conspicuous and liberally supported State universities are those of Michigan, Illinois, Wisconsin

and Minnesota. In these States the tenure of the university president compares very favorably with that of any other class of educational institutions in any part of the country. Among the conspicuous college presidents of the United States, President Angell stands next in seniority to President Eliot, of Harvard. The presidents of these four State universities have served terms varying from seven to thirty years, and averaging over fifteen years. The significance of this long tenure of office is apparent, if we recall the uncertain and fluctuating fortunes of the two great political parties in these Northwestern States during the last ten years.

A particularly striking instance of the development of public opinion against political interference may be found in Illinois. In the year 1894 the State University was subject to the management of a Board of Trustees, consisting of nine elective and three *ex officio* members. Of the nine elective members of the Board, six were Democrats, as were also at least two of the three *ex-officio* members. One of these two, a member in fact as well as in name, was Governor John P. Altgeld, the vigor of whose partisanship no one will question. In spite of this decisive Democratic majority in the Board of Trustees, that body elected as the new president of the University a gentleman who was well known as a member of the opposite political party, and who had held, a few years before, a conspicuous and responsible position in the party councils of another State. \* \* \*

The freedom of university teaching will probably always stand in need of jealous defenders. No human institution can secure itself absolutely against all influences in restraint of truth, some of which are none the less serious because they are not of a kind to attract public attention. Yet, all things considered, the State universities of the Central West may fairly claim to have made a good stand for non-partisan treatment of university teaching.—*The Independent*, N. Y.

#### CURRENT NOTES ON PHYSIOGRAPHY.

##### SNAKE RIVER CANYON.

SOME brief account of the great canyon of Snake river is presented by W. Lindgren (The

gold and silver veins of Silver city, de Lamar and other mining districts in Idaho, '20th Annual Report, U. S. Geological Survey,' 1900, pt. 3, 65-256, numerous plates and figures), supplementing the description given a few years ago by Russell (U. S. Geological Survey, Water-Supply and Irrigation Paper, No. 4, 1897). Where the river forms the western boundary of Idaho, the lava plateau has an elevation of from 6,000 to 7,000 feet; its successive flows, revealed in the dark brown canyon walls, are from 20 to 150 feet thick. Hereabouts, the river has cut down into the pre-lava mountains, the contact revealing a buried surface of strong relief. The canyon walls for a depth of 2,500 feet are benched on the horizontal lava beds; a remaining depth of the same amount is steeply buttressed with porphyries and diorites. "The bottom of the old valleys clearly lie far below the deep cut of Snake river, how far is not known. \* \* \* It may be confidently advanced as a working hypothesis that this whole district \* \* \* far from having been elevated since the Tertiary era \* \* \* represents an area of depression, standing now at lower levels than during the Miocene period" (93).

#### ALPINE MORPHOLOGY.

A MONOGRAPH of unusual interest and value is found in E. Richter's 'Geomorphologische Untersuchungen in den Hochalpen' (*Pet. Mitt., Erg'heft 132, 1900, 103 p., 6 pl., 14 fig.*).

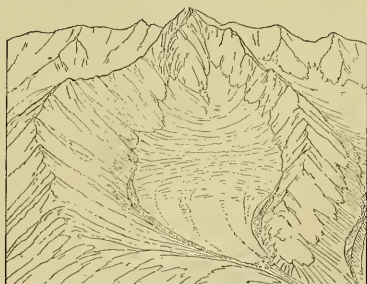

FIG. 1.—A corry beneath a sharp peak with serrate spurs.

It is concerned particularly with the origin of Kahre (cirques, corries, botner), which consti-

tute so characteristic a feature of the high Alps: arm-chair-like recesses in the mountain slope, frequently arranged in groups all backing towards a central peak or an axial ridge and separated by sharply serrate spurs. Valley troughs are also considered, and these as well as the Kahre are referred to glacial erosion under conditions that are critically specified. Among many important conclusions are the following: The high Alps, rising above the snow-line of the glacial period, owe their form largely to the destructive processes of that time. Whole ranges, 100 kilometers long, exhibit sharp high-mountain forms, with corries and serrate spurs, although they bear no glaciers at present. If it had not been for the glacial period, these ranges would to-day have the rounded forms appropriate to mountains of middle height. During the most extensive glaciation, the Swiss ice-fields stood so high—even over the forelands towards the Jura—that they were above the level of the snow-line; the slope of the snowy surface was gentle and the movement of the ice-streams in the larger valleys must have been slow. The trough form that obtains in all the strongly glaciated valleys—with over-deepened floors and over-steepened walls—is due to erosion by glaciers of medium size, whose surface did not rise above the trough walls, but whose movement must have been relatively rapid because their surface slope was strong. Ice-scouring during maximum glaciation reached far up the mountain slopes above the trough walls, but was without great influence on form. A level of extensive erosion is seen in the high Alps, coincident with the snow line of the glacial period; the peaks that rose above this level were actively consumed by weathering, while the surrounding valleys were smothered in heavy but slow-moving ice.

#### NEW ZEALAND.

THE ninth volume of the *Bibliothek der Länderkunde*, entitled 'Neuseeland' by R. von Lendenfeld (Berlin, Schall, 1900, 186 p., 24 pl. and fig., map), is a very attractive volume from which one may gain a clear impression of the country dealt with. Limiting this note to sections of a physiographic nature, mention may

be made of Banks peninsula, a dissected volcanic group, standing in front of the Canterbury plains, with which it is connected by long tangential sand reefs. A tunnel cut through one of the volcanic slopes has disclosed 174 different layers; lava, loose or compact, conglomerate, and weathered soil. The Canterbury plains, composed of recent fluvialite deposits brought from the mountainous background, have a gentle slope seawards; the flooded rivers build up their surface with coarser deposits near the mountains and finer deposits near the shore; as their channels become clogged, the water deserts them for new courses, thus the whole surface is slowly aggrading. The account of the fiords of the southwest coast mentions their numerous waterfalls, but one must read between the lines to see that the falls leap forward from hanging valleys, such as now appear to be characteristic of strongly glaciated mountains. A striking example of such a valley seems to be shown in the plate of Mitre peak, Milford sound (fiord). The volume has a good index, but the pages are headed only with their numbers, in German fashion. The frontispiece of Mount Tasman and the Hochstetter glacier is remarkably fine.

W. M. DAVIS.

#### CONTEMPORARY THERMODYNAMIC EFFICIENCIES.

THIS is the day of remarkable things in the field of heat-engine construction. The *Inch-dune*, and a sister ship on the 'Inch Line' of a well-known British steamship company, has produced the horse-power-hour on 0.96 pound of coal and, for the time, holds the world's record in steam-engine efficiency. This gives an efficiency, between the coal-pile and the point of transformation into power of the potential energy of the fuel, of almost precisely twenty per cent.

The steam-turbine is produced in such perfection of design and construction as to compete with the best of reciprocating engines of similar power and the report now appears in the German engineers' *Zeitschrift* that Jacobson, at Potschmühle, has tested a Laval Turbine which, rated at 300 horse-power, demands



but 7 kilograms per horse-power-hour at its rating, a trifle more at 342 delivered horse-power, and, a most remarkable achievement, at one-tenth its rated power only increases the consumption of steam to 9.74 kgs. This is better than any record yet reported for the reciprocating engine in maintenance of efficiency with diminishing delivery. The steam-pressure was about 8.5 atmospheres. Superheating gave about ten per cent. gain. The speed of the machine was about 10,000 revolutions a minute. A condenser was employed.

The Engineer-in-Chief of the U. S. Navy, Admiral Melville, reports in his annual message to the Department a remarkable set of data from the trial of the water-tube boilers of the U. S. S. *Cincinnati*. Steam was raised from cold water to a pressure of 215 pounds in 12 minutes, 40 seconds and without injury. The old shell-boiler would have needed several hours for getting up steam and, if forced, would have been expected to develop leaky tubes in all directions. After steam was up, the series of trials reported on was made, with forced draught, fuel being burned at rates ranging between 20 pounds, as a minimum, to above 50 pounds, per square foot of grate area, and with resulting evaporation of water of from nine pounds per pound of fuel, at the minimum, to 8.6 at the maximum rate of combustion. This is the equivalent of from 12.19 to 11.43, 'from and at' 212° F., per pound of combustible portion of the fuel, an efficiency of boiler of from 85 to 90 per cent. The coal used was of the Pocahontas variety, which contains ordinarily but two or three per cent. of ash. Here the ash and refuse in unburned coal and clinker amounted to about ten per cent. This is the most remarkable performance of which we have record. The evaporation is excellent at the lowest rate of combustion and wonderfully well sustained through the higher ranges. It probably constitutes a world's record to date.

Gas and oil and petroleum-vapor engines are also coming to the fore in a remarkable way and the beginning of the twentieth century already commences to show the quality of the new era in these directions. Mr. H. A. Marshall has recently presented a paper to the British

Institution of Mechanical Engineers, now just published, in which he gives the outcome of investigations of the efficiencies of the gas-engines employing 'power-gas' of the Mond variety, differing from the well-known Dowson gas in the fact that it is made from bituminous 'slack,' instead of from anthracite. It requires the use of enormous quantities of steam—250 per cent. of the weight of the fuel—and makes a very lean gas; but it employs so cheap a grade of fuel as to furnish the unit of heat at an unprecedentedly low cost. It makes 150,000 cubic feet of gas per ton and this yields 2,000 horse-power-hours in large gas-engines of good construction. A by-product, ammonium sulphate, more than recoups the original cost of the fuel, with the English coals used. The outcome of this improvement and of the adoption of the gas-engine in large sizes for extensive work is that, whereas the cost of fuel for the ideal steam-engine of modern practice should not exceed about a half-cent, the real engine demands, as a minimum, one cent, and the average engine of the large British stations one and a half-cent, or more; while the gas-engine has come down to a considerably lower cost than the minimum just given. The figures for heat-units demanded are reported as about 25,000 B. T. U. per horse-power-hour for the best steam-engine and but 11,500 for the gas-engine, under best conditions and continuously working. The real comparison is necessarily that of costs of production of the unit of power and it is this relation which will ultimately determine the supremacy of one of the competing heat-engines.

Gas-engines are now built in large powers—1,500 H. P., and larger powers can be readily supplied if called for—and are found to involve less practical difficulty on the large than on the small scale. They are now durable, regulate well and are economical in use of exceedingly cheap fuels. The results obtained at Wilmington, as reported by Marshall, are, in fact, not only better, thermodynamically, than those given by any existing steam-engine, but are even better than even the ideals of the case brought into the comparison; all of which are engines in use in English power and lighting

stations. The actual weight of fuel used at Winnington is one pound per h.-p.-h. This is substantially the same as the figure for the record-breaking steam-engine in marine practice already referred to; but the latter uses the most costly, the gas-engine the least expensive, fuel, and this is the vital matter. The gas-engine now has attained a mechanical efficiency of about 85 per cent. and a thermal efficiency exceeding 25 per cent.; both figures representing the practical limit in steam-engine practice also, although the former is sometimes exceeded. In both engines the efficiency, on the basis of the brake horse-power, is about twenty per cent., occasionally one or two units higher.

The Mond gas, with a thermal content of 150 *B. T. U.* per cubic foot, sells for twopence per thousand; this can be compared with our own illuminating and natural gases, storing 600 and 1,000 *B. T. U.*; of which, respectively, 16 and 9 cubic feet are used in good gas-engines, per horse-power-hour, while of the Mond gas at least 75 cubic feet are demanded.

Summing up the case: It may be said that the best work of the large gas-engine gives a thermal efficiency substantially the same as that of the very best steam-engine while it employs a fuel which is considerably cheaper than is employed where this comparison is, as here, made on the basis of fuel consumed. Its 'cost of plant,' on a large scale, is now quite as low.

The balance sheet of the best single gas-engine reported stands thus:

	Heat transformed, <i>B. T. U.</i> .....	33.65
Heat received	Heat lost	
from	Cylinder-jacket.....	19.28
the fuel	Piston.....	4.94
<i>B. T. U.</i>	Exhaust valve.....	3.34
100.	Total in cooling water...	27.00
	Heat waste in exhaust, etc.	38.79
		100.00

This is superior to any steam-engine performance yet reported.

During the discussion, Mr. Donkin reported in tabular form the best results of tests of gas-engines made in the United States with natural gas, the richest gas-fuel, either natural or artificial, available for large engines. The best figures in the table are those obtained in a

Sibley College test of a Westinghouse gas-engine and reported by Messrs. Millar and Gladden in the *Sibley Journal* of June, 1900. The power developed was, net, 606 *H. P.*, the mechanical efficiency of the machine 90 per cent., the heating value of the gas about 1,000 *B. T. U.* per cubic foot, the consumption ranging from 10 cubic feet per *B. H. P.* to 8.8 for the indicated power. This gives a thermal efficiency of 25.5 per cent. The same figure is obtained, according to Mr. Donkin's tables, in Mr. Humphrey's test of an engine of a similar power of English make using Mond gas.

The twentieth century opens with the gas-engine for the first time in its century of evolution seriously competing with the steam-engine in important commercial work on a large scale.

R. H. THURSTON.

#### THE U. S. GEOLOGICAL SURVEY.

FOR the support of the U. S. Geological Survey for the fiscal year ending June 30, 1902, Congress appropriated at the session just closed about \$1,018,000, an increase of \$52,000 or more over the present year's appropriation. Indeed, there was a strong disposition in Congress to make a material increase, notably for the extension of hydrographic investigations.

Of the several sums appropriated \$250,000 is for the topographic surveys, including a report on the topography and geology of the territory adjacent to the 49th Parallel, west of the 110th Meridian. For the survey of the forest reserves there is \$130,000, the same as the present year. For geologic surveys the amount is \$150,000—no increase—and for the continuation of the investigation of the mineral resources of Alaska, \$60,000. For paleontologic researches there is \$10,000. For chemical and physical researches relating to the geology of the United States there is granted \$20,000, being \$10,000 more than the sum appropriated for the present year. The increase will enable the Director to carry on needful and long neglected physical researches in connection with the chemical work of the Survey. For want of funds the Survey has had no physical laboratory for some years.

For the collection of data and the preparation of a report on the mineral resources of the

United States there will be \$50,000, the same as for the present year, but an increase as compared with former years.

The appropriation for gauging streams and determining the water supply of the United States, including the investigation of underground currents in arid and semi-arid sections is likewise the same as this year—\$100,000.

With a view to meeting as far as possible a very strong demand from the people for an extension of the hydrographic work of the Survey, there was practical unanimity in Congress in favor of a large increase in the allowance for this work. The increase was provided for in the form of an amendment to the River and Harbor Bill, and hence, like many other items covering meritorious objects, it went down to defeat in the last hour of the session with that now famous measure.

Other items under the appropriation are for engraving and printing, preparation of illustrations, rent of quarters, etc. There is \$12,000 for furniture for a new addition to the Survey building in Washington.

Congress also granted upwards of \$15,000 to cover deficiencies for the current year.

#### SCIENTIFIC NOTES AND NEWS.

DR. CHARLES F. CHANDLER, professor of chemistry in Columbia University, has been appointed by the President a member of the Board of Visitors of the U. S. Naval Observatory, in the place of Mr. Clair McKelway, of Brooklyn, who did not accept the position.

THREE expert geologists from the U. S. Geological Survey have been detailed to make a geologic and mineral reconaissance of the Island of Cuba. They are Dr. C. Willard Hayes, Mr. T. Wayland Vaughan and Mr. A. C. Spencer. Mr. Spencer has not yet started from Washington, but Messrs. Hayes and Vaughan have already reached the island and taken up their work, after conference with the military governor. It is expected that these geologists will accomplish results of distinct economic value to the island. The assignment of these United States geologists to work in Cuba is made at the request of Major-General Wood, the military governor, and of Secretary

of War Root, and is with the approval of Secretary of the Interior Hitchcock. The expenses will be met by the Cuban Government.

PROFESSOR S. M. BABCOCK of the University of Wisconsin, inventor of the Babcock milk test, was, on March 27th, presented with a medal, voted him by the State for giving his inventions free to the world. Exercises were held in the Assembly Chamber of the Capitol in the presence of both Houses of the Legislature, the university faculty, Supreme Court, university regents and many prominent citizens of the State. Governor Lafollette presided and addresses were made by him, by ex-Governor W. D. Hoard and others.

AN influential committee has been formed in Italy to celebrate the fortieth anniversary of Professor Paul Mantegazza's entrance on his career as a teacher. This event will be celebrated at Florence on April 30th, and at the same time the thirtieth anniversary of the Italian Society of Anthropology. It is proposed to collect a sum of money to be used for the endowment of the new laboratory of anthropometry which Professor Mantegazza has established at Florence.

THE University of Aberdeen is about to confer the honorary degree of LL.D. on Professor Virchow, of Berlin, and on Major Alfred W. Alcock, superintendent of the Indian Museum, Calcutta, and professor of zoology in the Medical College of that city.

PROFESSOR C. LLOYD MORGAN gave the Croonian Lecture before the Royal Society on March 21st, the subject being 'Studies in Visual Sensation.'

DR. RICHARD R. WETSTEIN VON WETTERSHEIM, professor of botany at the University of Vienna, has been elected president of the Zoological and Botanical Society of Vienna.

M. HUMBERT has been elected a member of the section of geometry of the Paris Academy of Sciences to fill the vacancy caused by the death of M. Hermite, and M. Normand has been elected a correspondent in the section of geography and navigation in the room of the late General de Tillo.

THE Medical Club of Philadelphia gave a re-

ception on March 29th, at the Bellevue Hotel, in honor of Dr. Charles L. Dana.

THE freedom of the Leathersellers' Company was conferred, on March 15th, on Sir William MacCormac, in recognition of his distinguished services to medical science.

WILLIAM HARPER, who for some years has been the chief of the statistical bureau of the Philadelphia Commercial Museums, has resigned to undertake similar work in London.

WE regret to learn that Dr. Horatio C. Wood, professor of therapeutics in the University of Pennsylvania, and eminent for his contributions to therapeutical and botanical subjects, has been compelled by ill health to give up temporarily his lectures and other work.

THE decoration of the Mérite Agricole has been conferred by the French Government upon the following officers of the Department of Agriculture for services in connection with the Paris Exposition: Dr. H. W. Wiley, chief chemist; Major H. E. Alvord, chief of the dairy division; Col. G. B. Brackett, pomologist; W. A. Taylor, assistant pomologist; M. A. Carleton, cerealist; and John I. Schulte, one of the associate editors of the *Experiment Station Record*. The decoration also has been conferred upon James L. Farmer, assistant director of agriculture for the Paris Exposition.

THE Smith's prizes of Cambridge University have been adjudged to Godfrey Harold Hardy, B.A., 4th Wrangler, 1898, scholar of Trinity College, for his essay on 'Definite Integrals of Discontinuous Functions,' and to James Hopwood Jeans, B.A., scholar of Trinity College, bracketed 2d Wrangler, 1898, for his essay on 'The Distribution of Molecular Energy.'

A MARBLE tablet in memory of the eminent French chemist, J. B. Dumas, who died in 1884, has been placed in the house in the rue St. Dominique, Paris, where he formerly lived.

A MEMORIAL marble bust of Robert Brown, the eminent botanist, formerly a student at the University of Aberdeen, presented to the University by Miss Hope Paton, has been unveiled in the picture gallery of Marischal College.

THE death is announced of M. Montard, an eminent French mathematician and engineer;

of Baron Keiské Ito, professor of botany at the University of Tokyo, who died on January 21st, at the age of ninety-nine years, and of Dr. Peter M. Pokrowski, professor of mathematics at Kiev, on March 3d, at the age of forty-four years.

THE second Latin-American Scientific Congress opened its two weeks session at Montevideo on March 20th, with over 200 delegates in attendance. Dr. Robert Wernicke, professor of pathology in the University of Buenos Aires, Argentine Republic, was elected president of the Congress.

WE learn from the *British Medical Journal* that Professor Robert Koch is staying at Rovigno, on the Adriatic, where he is inspecting the Marine Zoological German Institute, to which he hopes to affiliate a malaria institute for the Istrian district. Koch's latest stay in New Guinea has been fruitful in good results, the fight against malaria having been continued energetically on the lines laid down by him. Unfortunately the disease is very prevalent in the German colonies of East Africa. A medical officer with assistants and the necessary scientific apparatus is to be sent out there by the German Government, for which purpose 30,000 Marks have been voted by the Reichstag.

THE Coast and Geodetic Survey steamships *Pathfinder* and *McArthur*, at San Francisco, and the *Patterson* and *Gedney*, at Seattle, are now fitting up under orders to proceed to Alaska to survey important passages among the islands along the Alaskan coast. The existing charts are based on old Russian ones, corrected from time to time by reconnaissance surveys.

THE Convocation of Oxford University has rejected by a vote of 126 to 125 a resolution to build a house in the Parks adjacent to the observatory as a residence for the professor of astronomy.

SECRETARY WILSON has arranged to carry into effect, on July 1st, the reorganization of certain of the divisions of the Department of Agriculture, as provided by the last Congress. It will be remembered that, in addition to the Weather Bureau and the Bureau of Animal Industry, four new bureaus were created—of Plant Industry, of Forestry, of Chemistry and of Soils.

NEWS has been received from the eclipse expedition sent out by the Massachusetts Institute of Technology to observe the total eclipse of the sun at Sumatra. Professor Burton and his assistants took the Dutch steamship *Konigin Regentes* at Genoa on March 12, and found on this steamer an official expedition sent out by the Netherlands Government. All the instruments were safely placed on board the steamer, which goes directly to Padang.

THE ground occupied by the building of the U. S. Fish Commission, at Washington, has been granted to the Baltimore and Potomac Railroad, and the building will be removed to another part of the Mall, west of its present position. The railway company must pay \$40,000 towards the cost of rebuilding.

It has been announced that Mr. J. P. Morgan was the donor not only of the Tiffany collection of gems and pearls, but also of the Bement collection of minerals and meteorites to the American Museum of Natural History.

THE Department of Zoology and Entomology of the Ohio State University has secured a very interesting and valuable collection of Ohio birds through the generosity of Mr. W. L. Hayden, of Columbus. It includes representatives of a large number of native birds and is noteworthy from the fact that the different species are shown with their natural surroundings, nests, eggs and often young, as well as old, birds of both sexes. Some particularly striking effects are produced with the nests of owls and woodpeckers included in sections of the trees in which they were constructed. The collection is arranged in forty-two handsome cases, finished in oak, and is stated to have cost over one thousand dollars in its preparation, not counting the time, ingenuity and skill which Mr. Hayden has lavished upon it.

THE father and uncle of Dr. Walter Myers, whose life was sacrificed in the study of yellow fever, have given £1,500 to the Liverpool School of Tropical Medicine for the prosecution of its investigations.

PROFESSOR WILLIAM OSLER of Johns Hopkins University, has been invited by the management of the Congress of Tuberculosis, to be held in London at the end of July, to arrange for

American representation. Among those who have already signified their intention to be present are Professor Truudeau, of Massachusetts, Professor Solly, of Colorado, Dr. Herman Biggs, of New York, Dr. J. G. Adami, of Montreal, and Professor McEachran, of Quebec.

THE American Academy of Political and Social Science will hold its fifth annual meeting at Philadelphia on April 12th and 13th. Professor Samuel McCune Lindsay has been elected president of the Association by the directors in succession to Professor E. J. James, of the University of Chicago, who was the founder of the Academy and its first president, from the date of organization in 1889, until January 1, 1901.

A CIVIL service examination for the position of aid in the U. S. Coast and Geodetic Survey, with a salary of \$725, will be held on April 23d. The subjects are mathematics, astronomy, physics, surveying, geography and modern languages.

MR. MARCONI has won the suit brought against him for \$100,000 damages and to restrain him from further use of wireless telegraphy by the assignee of Professor A. E. Dolbear.

SENATOR SLATER has introduced a bill, at Albany, appropriating \$400,000 for the use of the Palisade Commission in purchasing the Palisades. The first section of the bill is as follows :

The sum of \$400,000, or so much thereof as may be necessary, is hereby appropriated, out of any moneys in the Treasury not otherwise appropriated, for the use of the Commissioners of the Palisades Inter-State Park, to be expended in acquiring land lying between the top of the steep edge of the Palisades of the Hudson River and the high-water line of said river, and lands lying under water and riparian right adjacent thereto between Fort Lee and Piermont Creek, in such name or names and under such conditions as the commission may deem necessary or wise, and for such other purposes as the commission may deem necessary and proper in carrying out the purposes and intent of Chapter 170 of the Laws of 1900.

THE Ways and Means Committee of the Assembly of New York State has reported the bill of Assemblyman Snyder, appropriating \$250,000 for the purchase of forest lands for the State preserves. Of the sum appropriated \$200,000 is to be expended in the purchase of

land for the Adirondack preserve and \$50,000 for the Catskill Mountains preserve.

THE Legislature of New Hampshire has rejected two bills for the preservation of the State forests. One bill provided for the restriction of lumber cutting to trees of a prescribed size. The other bill authorized a loan of \$1,000,000 for the purchase of forest lands and the establishment of a forest reserve in the State.

AT the last monthly meeting of the Zoological Society of London, it was stated that there had been 118 additions to the Society's menagerie during the month of February, amongst which special attention was directed to an August amazon (*Chrysotis augusta*) from Dominica. Upon one previous occasion only had a specimen of this fine bird been received at the Society's gardens—namely, on May 12, 1865. The additions also included a Guinea fowl (*Numida meleagris*?) from Rabat, Morocco, presented to the Society by Mr. G. E. Neroutsos, British Vice-Consul at that port. The Council announced to the meeting that the King had been pleased to become patron of the Society in succession to the late Queen Victoria.

IN order to further laboratory instruction of large classes of students in physiology, Professor W. T. Porter, director of the physiological department in the Harvard Medical School, will undertake to provide reliable physiological apparatus constructed under his personal supervision. It is expected that the improvements suggested by the daily experience of the Harvard Laboratory will thus be made directly available to others; and it is hoped that by this arrangement the quality of physiological apparatus for general use will be improved and the price sensibly diminished. All communications should be addressed to Professor W. T. Porter, 688 Boylston Street, Boston, Mass.

THE following details are given in *The Forester* regarding the Act passed by the Pennsylvania Legislature which raises the Division of Forestry of the State's Department of Agriculture to the position of a Department of Forestry. In addition to the new importance which is thus given to the forest service of the State, the efficiency and strength of its organ-

ization is much increased by the Act. The department is to consist of a Commissioner of Forestry, and four others. These shall also constitute the State Forestry Reservation Commission. The commissioner is to hold office for four years and so are his fellow members of the Reservation Commission; they are not all to be appointed at the same time, however, and their terms of office so overlap that the Board will always have two members of two years' experience. The Reservation Commission is empowered to buy lands for the forest reserve, to manage them, to sell timber and to make contracts for the mining of any valuable minerals which may be found in them. The Act further specifies that the Commissioner of Forestry shall be the president and executive officer of the Forestry Reservation Commission, and also superintendent of the State Forestry Reservation, and shall have immediate control, under the direction of the Commission, of all forest lands belonging to the Commonwealth. He is empowered to execute all rules adopted by the Commission for the enforcement of laws designed to protect the forest from fire and depredation, and is also empowered to employ detective service and to make arrests. It is also provided in this Act that the kindling of fire on a forest reservation, except in accordance with the rules and regulations of the Commission, shall be a misdemeanor, for which the penalty is a fine of not less than one hundred dollars, or more than five hundred. Governor Stone has appointed, as we have already noted, Dr. J. T. Rothrock as Commissioner.

AT the annual general meeting of the Institution of Mechanical Engineers, London, Mr. W. H. Man was elected president, Mr. A. Keen, Mr. T. Hurry Riches and Mr. Bryan Donkin, vice-presidents and Sir J. Wolfe-Barry, Mr. W. Dean, Mr. H. G. Harris, Mr. A. Tannett-Walker and Sir W. T. Lewis, new members of the council. The annual report, as we learn from the *Times*, stated that at the end of 1900 the number in all classes on the roll of the institution was 3,165, a net gain of 243 members as compared with the number on the roll at the end of the previous year. The total revenue for 1900 was £9,005

8s. 1d., while the expenditure was £8,595 11s. 1d., leaving a balance of revenue over expenditure of £409 17s. The total investments and other assets at the end of the year amounted to £70,117 1s. 5d., and, deducting therefrom the £25,000 of debentures and the total remaining liabilities, £4,211 15s. 6d., the capital of the institution amounted to £40,905 5s. 11d. Of this sum £5,000 was set aside in 1897 and 1898 for the redemption of the debentures. The sum of £6,850 4s. 8d. still remained invested in railway debenture stocks and Consols, registered in the name of the institution. A total of £60,270 2s. 10d. had now been expended upon the institution-house. The award of the Willans Premium had been for the first time in the gift of the council, and, from the papers read before the institution since the foundation of the fund in January, 1895, they had selected that read in April, 1895, by Captain H. Riall Saukey, on 'Governing of Steam-engines by Throttling and by Variable Expansion,' as the most suitable for the award. With a view to the formation of a historical museum, relating to mechanical engineering progress, several gifts of value had been promised. The numerous letters which had been received from the United States evinced a thorough appreciation of the reception accorded to the members of the American Society of Mechanical Engineers by the institution at its summer meeting. The work of the graduates has been carried on with considerable success, and a number of visits were made by the graduates to works in the neighborhood of London. The council had awarded prizes to Mr. W. B. Cleverly and Mr. Brees van Homan for their papers on 'Works Management, Methods of Quick Production of Repetition Work' and 'Steel Skeleton Construction, as applied to Buildings on the American System' respectively. In consequence of a desire expressed by several members of the institution, the council communicated with the War Office in February, asking if it would be of any advantage to the Government to have the assistance in South Africa of the engineering experience of members of the institution; the reply indicated the high appreciation of the Secretary of State for War, and stated that, although arrangements had already been made,

the offer would certainly be borne in mind in case circumstances should alter. The council, after consultation with officers of other institutions, had consented to take charge of the mechanical section of the Glasgow International Engineering Congress, the meetings of which would be held during the first week of September of this year. These arrangements would not interfere with the ordinary summer meeting of the institution, which would be held during the last week of July at Barrow-in-Furness.

THE home department of the Government of India has made a report of deaths from wild animals and snakes which are summarized in the *London Times*. During 1899 the number of deaths among human beings attributed to wild animals was 2,966. Fortunately, however, the number is below the average of the last four years and much lower than the number (4,233) reported in 1897. In 1899 tigers caused the death of 899, wolves of 338, and leopards of 327 human beings, while bears, elephants, hyenas, jackals and crocodiles were accountable for a large proportion of the remainder. The tiger is most destructive in Bengal, about half of the whole number of the victims of this animal being reported from that province. Man-eaters have especially troubled certain districts, and liberal rewards have been offered for their destruction. In the Bhamo district of Upper Burma a single man-eating tiger killed about 20 people. A special reward of 100 rupees was paid for its destruction. More than half of the deaths from leopards occurred in Bengal, while more than three-fourths of those from wolves occurred in the Northwestern Provinces and Oudh. Special measures were taken to hunt down a particularly destructive pack near Cawnpur. High rewards were offered, and hunting parties organized, but without much success. The loss of human life from snakes reached the high total of 24,621 a greater mortality than in any of the four preceding years. Nearly half the deaths occurred in Bengal, while the Northwestern Provinces and Oudh came next with nearly one-fourth of the total. In Bengal the relatively high mortality is attributed to floods, which drove the snakes to the highlands on which village homesteads are built. As will be observed, snakes are more

destructive of human life than are wild animals, but the reverse is true of the destruction of cattle. In 1899 no fewer than 89,238 cattle were destroyed by wild animals, and 9,449 by snakes. Of the former 37,986 fell victims to leopards, and 34,321 to tigers. The leopard is even more destructive to cattle than the tiger in Bengal. This province is the greatest sufferer from the ravages of wild animals and snakes, its loss being 30,539 cattle. Assam lost 17,010, Madras 15,592, Burma 11,016, and the Central Provinces 11,689. The number of wild animals destroyed was 18,887 and the amount paid for their destruction was 107,476 rupees. The number of snakes killed was 94,548, and the rewards paid for service amounted to 4,151 rupees.

#### UNIVERSITY AND EDUCATIONAL NEWS.

THE Washington State Legislature has adjourned after having made liberal appropriations for the support of education. The State University gets \$270,000, the State Agricultural College \$94,800, the three normal schools \$93,800, \$45,000 and \$40,000, respectively.

THE Indiana Legislature has appropriated \$100,000 for a science building for Indiana University.

THE Ontario Government, in addition to the aid contained in the Toronto University Bill now before the Legislature, which involves the payment of about \$20,000 a year for the science department, salaries and maintenance, has decided to erect a new building for the science department on the site of the old Wycliffe College, at a cost of about \$200,000.

By the will of the late George T. Bliss, of New York City, who died on March 24th, Yale University receives \$50,000.

MR. JOHN D. ROCKEFELLER has offered to give Richmond College, a Baptist institution of Virginia, \$75,000, on the condition that the College shall collect \$25,000.

THE sum of \$12,000 per annum has been subscribed for the conduct of the experimental school of Teachers College, Columbia University. It will be remembered that a building is about to be erected for this school with a gift of \$100,000.

THE Lord Mayor of London presided at a meeting on March 21st, when the Earl of Roseberry delivered an address on commercial education. The object of the meeting was to call attention to the importance of higher commercial education in relation to the present position and prospects of British trade, and to take the preliminary steps to raise a fund for the establishment of additional higher commercial teaching in connection with the new London University. Toward this fund, Messrs. N. M. Rothschild & Sons have contributed £5,000.

AN influential committee has issued an appeal with the object of raising £150,000 in celebration of the jubilee of Owens College, Manchester. Fifty thousand pounds are needed to discharge debts that have been contracted and £100,000 for additional endowment. Among the objects the promoters have in view are the extinction of the debt of £22,000 on the building of the medical school; special endowments for existing chairs, including French, chemistry, education, anatomy and philosophy; the establishment of new chairs of English literature, Hebrew and architecture; the establishment of an institution for bacteriological investigation and for the study of hygiene, and of research fellowships; and the creation of a pension fund for members of the teaching staff.

FOLLOWING the action recently taken by the University of Michigan, the Faculty of the College of Science, Literature and the Arts in the University of Minnesota has voted to recommend to the Board of Regents that only one degree, that of bachelor of arts, be given hereafter. Under the present arrangement three courses are offered in the college, leading to the degrees of bachelor of arts, bachelor of literature and bachelor of science.

FOR the remainder of the college year, Mr. S. M. Coulter takes the position of instructor in botany in Washington University, vacated by the appointment of H. F. Roberts as professor of botany in the Kansas Agricultural College.

DR. V. L. LEIGHTON, instructor in organic chemistry at Tufts College, has been called to an associate professorship of chemistry at the College of Agricultural and Mechanic Arts, at Kingston, R. I.







George W. Dawson  
— — — — —

# SCIENCE

A WEEKLY JOURNAL DEVOTED TO THE ADVANCEMENT OF SCIENCE, PUBLISHING THE  
OFFICIAL NOTICES AND PROCEEDINGS OF THE AMERICAN ASSOCIATION  
FOR THE ADVANCEMENT OF SCIENCE.

EDITORIAL COMMITTEE: S. NEWCOMB, Mathematics; R. S. WOODWARD, Mechanics; E. C. PICKERING, Astronomy; T. C. MENDENHALL, Physics; R. H. THURSTON, Engineering; IRA REMSEN, Chemistry; JOSEPH LE CONTE, Geology; W. M. DAVIS, Physiography; HENRY F. OSBOEN, Paleontology; W. K. BROOKS, C. HART MERRIAM, Zoology; S. H. SCUDDER, Entomology; C. E. BESSEY, N. L. BRITTON, Botany; C. S. MINOR, Embryology, Histology; H. P. BOWDITCH, Physiology; J. S. BILLINGS, Hygiene; WILLIAM H. WELCH, Pathology; J. McKEEN CATTELL, Psychology; J. W. POWELL, Anthropology.

FRIDAY, APRIL 12, 1901.

GEORGE M. DAWSON.

## CONTENTS:

<i>George M. Dawson (with plate):</i> PROFESSOR FRANK D. ADAMS.....	561
<i>State Natural History Surveys:</i> PROFESSOR E. A. BERGE, PROFESSOR H. F. NACHTRIEB, PROFESSOR FRANK SMITH.....	563
<i>The Training of an Electrochemist:</i> PROFESSOR HARRY C. JONES.....	569
<i>Appropriations for the U. S. Department of Agriculture:</i> DR. E. W. ALLEN.....	572
<i>The Reduction to Absurdity of the Ordinary Treatment of the Syllogism:</i> CHRISTINE LADD FRANKLIN.....	574
<i>American Chemical Society</i> .....	576
<i>Scientific Books:—</i>	
<i>Recueil sur quelques microorganismes des combustibles fossiles:</i> PROFESSOR LESTER F. WARD.	
<i>Ball's Elements of Astronomy:</i> DR. F. W. VERY.	
<i>General Books Received</i> .....	577
<i>Scientific Journals and Articles</i> .....	582
<i>Societies and Academies:—</i>	
<i>The Academy of Science of St. Louis:</i> PROFESSOR WILLIAM TRELEASE. <i>Geological Society of Washington:</i> DR. F. L. RANSOME AND DAVID WHITE. <i>Biological Society of Washington:</i> F. A. LUCAS. <i>Torrey Botanical Club:</i> PROFESSOR EDWARD E. BURGESS. <i>Science Club of Northwestern University:</i> DR. HORACE M. SNYDER.	584
<i>Discussion and Correspondence:—</i>	
<i>The Application of Precedence of Place in Nomenclature:</i> PROFESSOR N. L. BRITTON. <i>Clayton's Eclipse Cyclone and the Diurnal Cyclones:</i> DR. FRANK H. BIGELOW. <i>The Reversal of the Photographic Image by Continued Action of Light.</i> ROMYN HITCHCOCK.....	588
<i>Shorter Articles:—</i>	
<i>A New Occurrence of Cassiterite in Alaska:</i> ALFRED H. BROOKS. <i>Notes on Parasites:</i> DR. CH. WARDELL STILES.....	593
<i>Analecturism and Mental Inertia in Public Service:</i> PROFESSOR R. H. THURSTON.....	594
<i>Museum Methods Abroad:</i> F. A. L.....	595
<i>The Scientific Alliance of New York</i> .....	596
<i>Membership in the National Academy of Sciences</i> .....	597
<i>Scientific Notes and News</i> .....	598
<i>University and Educational News</i> .....	600

By the death of Dr. G. M. Dawson, the Dominion of Canada loses one of her ablest and most distinguished men of science and one whose loss will be felt for many years to come. George Mercer Dawson was the eldest son of the late Sir William Dawson and was born at Pictou, Nova Scotia, on August 1, 1849. In 1855, his father, having received the appointment as Principal of McGill College, left Nova Scotia and came to live in Montreal. The wide college grounds, lying then on the outskirts of the town and backed by Mount Royal, at that time covered with its original forest growth, formed an environment full of interest and delight to the boy, whose mind turned to the study of nature from the first, a study which was made doubly fascinating in his case by his father, who was always ready to encourage him in his work, explain his difficulties and talk with him as a friend.

At the age of ten he entered the High School at Montreal, where he took a high place among the boys of his class. There were, however, at that time, near what is now the center of the city of Montreal, a number of ponds in which the boys from the High School used to go rafting at lunch hour. On one of these occasions he received a drenching and remained in his damp clothes through the afternoon; a chill was induced, which led to spinal trouble,

resulting in years of suffering and final deformity. He consequently left school, and his education, until he was old enough to enter college, was carried on chiefly by private tutors. While not neglecting the ordinary subjects of a school curriculum, he was allowed to follow out lines of study in which he found a particular interest and in this way learned many things which were later of the greatest value to him. Surrounded by books, chemical apparatus, paints and pencils, the days were never too long, and photography, bookbinding, painting magic lantern slides, pyrotechny and even cheese-making were among his many occupations. He seemed to absorb knowledge rather than to study, and was always cheerful, amusing and popular, other boys flocking round him and invariably submitting to his unconscious leadership. At times he suffered much pain and was deprived of many things dear to boys, but was never heard to complain. When quite a lad he often accompanied his father on his geological excursions with the students of McGill College on Saturdays, and even on longer expeditions to Murray Bay, Gaspé and the Joggins, and was always a helpful and bright companion.

At nineteen he had recovered his health and entered McGill College, where he studied for a year, and in the following year entered the Royal School of Mines in London. He went to England in a sailing ship, for the benefit of the longer voyage, and on the way overamused himself by studying navigation under the captain. Years later when he chartered a schooner, in order to make an examination of the Queen Charlotte Islands, the captain of the latter, proving to be drunken and unsatisfactory, was dismissed, and Dawson navigated the schooner himself during the remainder of the trip, and this on a deeply indented and dangerous coast, of which at that time no chart existed.

At the Royal School of Mines he took the regular course, extending over three years, taking the Duke of Cornwall's Scholarship, and the Forbes medal and prize in paleontology and natural history. While at the Royal School of Mines he paid especial attention to the study of geology and paleontology under Ramsay, Huxley and Etheridge, and also devoted much time to the study of chemistry and metallurgy in the laboratories of Frankland and Percy.

Returning to Canada, he was engaged for a year in mine surveys in Nova Scotia and in lecturing at Morrin College, Quebec, and in 1873 was appointed Geologist and Botanist to Her Majesty's North American Boundary Commission, which was to fix the boundary line from the Lake of the Woods to the Rocky Mountains, and which had been at work for over a year. There are but few corners of the earth which now appear so far off as the great Northwest did at that time—a veritable *terra incognita*. Fort Garry, now the city of Winnipeg, was the last point of civilization and the 49th parallel had to be traversed on horseback or on foot, the provisions and materials being taken along in Red River carts. The difficulties now experienced in traversing that district were then increased by its remoteness from civilization and the fact that it was unexplored. In summer there was not only the scorching heat of the Plains, but the prairie fires, the difficulty of procuring and carrying firewood, the scarcity of water, and, in the late autumn, the cold with all its accompanying inconveniences. Notwithstanding these difficulties, however, during the two years in which he was a member of the Boundary Commission, he accumulated materials for an elaborate and very valuable 'Report of the Geology and Resources of the Country in the Vicinity of the 49th Parallel,' accompanied with maps and many illustrations, which was published in Montreal in 1875. In connection with

this work he also prepared a report on the Tertiary Lignite Formation, a memoir on the 'Superficial Deposits of the Central Region of North America,' and papers on the 'Locust Visitations,' on the 'Fresh Water Sponges of Canada' and on the 'Fluctuations of the American Lakes.'

When the work of the Boundary Survey was brought to a close, he was appointed, in 1875, to the Staff of the Geological Survey of Canada, and, in 1883, on the retirement of Dr. Selwyn, he succeeded him as Director of the Survey, which position he held at the time of his decease. His field work, while connected with the Geological Survey, was carried on chiefly in British Columbia and the Northwest Territories, and the excellent character of this work contributed largely to the great development of the mining industry in these parts of the Dominion in recent years.

Dr. Dawson also rendered important public service in connection with the Behring Sea arbitration. As one of the British Commissioners he spent the summer of 1892 in the Behring Sea region, for the purpose of inquiring into the facts and conditions of seal life. The report of the Commission constituted the case of Her Majesty's Government, and I remember hearing at the time a high tribute paid to Dr. Dawson's ability by one of the gentlemen connected with the United States side of the case, in the statement that had it not been for Dr. Dawson's evidence and arguments, a finding much more favorable to the United States would probably have been secured. In connection with his services on this arbitration he was made a Companion of the Order of St. Michael and St. George (C. M. G.).

He usually enjoyed excellent health and had great capacity for hard work, but he succumbed very suddenly, on the 2d of March last, to an attack of acute bronchitis after an illness of but two days.

Dr. Dawson was a prolific writer. In addition to his numerous and voluminous official reports, he contributed many papers on geological, geographical and ethnological subjects to the scientific magazines and to the Transactions of various learned societies, both on this continent and in England.

He received the degree of D.Sc. from Princeton, and the degree of LL.D. from Queen's University in 1890 and from McGill University in 1891. In the same year he received the Bigsby gold medal from the Geological Society of London for his services to the science of geology, and was elected a Fellow of the Royal Society. In 1893 he was elected President of the Royal Society of Canada. In 1896 he was President of the Geological Section of the British Association for the Advancement of Science at its Toronto meeting, and was last year President of the Geological Society of America. His presidential address, delivered on retiring from the latter position, appeared in a recent number of *SCIENCE*. In 1897 he was awarded the gold medal of the Royal Geographical Society. He also received many other distinctions which cannot here be mentioned.

Dr. Dawson was a man of more versatile gifts than his father, but like him possessed of an unusual combination of scientific insight, literary ability and administrative capacity. He was a man of broad views, clear and judicial frame of mind, modest and retiring, but withal an excellent conversationalist. He won the esteem of all who knew him, and his loss will be keenly felt by his very large circle of friends.

FRANK D. ADAMS.

McGILL UNIVERSITY, MONTREAL.

*STATE NATURAL HISTORY SURVEYS.\**

A GEOLOGICAL survey of Wisconsin, very complete and careful for the time, was com-

\* Abstracts of addresses made before the Naturalists, meeting in Chicago, December, 1900.

pleted in the year 1878. During the following twenty years no investigations of this character were carried on in the State. In 1897, however, the Legislature organized the present Geological and Natural History Survey and gave to it for the first two years an appropriation of \$5,000 annually, which was doubled during the second biennial period. The government of the Survey is in a Board of Commissioners, consisting of the governor of the State, the president of the State University, the State superintendent of Public Instruction, the president of the Commission of Fisheries, and the president of the Wisconsin Academy of Sciences, Arts and Letters. The director of the survey from the first has been E. A. Birge, professor of zoology in the University of Wisconsin. The work of the Survey has been done along three lines: economic, scientific and educational.

The first piece of work of economic importance was the investigation of the building stones of the State, to which two years were devoted by Dr. E. R. Buckley, who is in charge of this department, and, as a result, a full report on the building stones was published as a bulletin of the Survey in 1899. After the completion of this work, Dr. Buckley turned his attention to the clays and the clay industries, on which he is still engaged. A general report on this subject will appear during the present winter, and the work will be continued probably for at least a year or two in the future. The geological structure of the Keweenawau, or copper-bearing rocks, of Douglas and adjacent counties of northern Wisconsin has been worked out by Professor U. S. Grant, and a preliminary report has been published.

Of the several scientific investigations, the most important is the geology of the crystalline rocks in the central part of the State—a region which was almost entirely uninhabited at the time of the earlier survey. Its investigation has been assigned to

Dr. S. Weidman, who has been carrying on field work since the organization of the Survey and who will prepare a complete report of the geology of the region when he has completed the task of working out, in the field, the difficult and intricate relations of the rocks.

Another line of work has been on the lakes which are so abundant in Wisconsin. A hydrographic survey has been made of more than 60 of the more important lakes in the southeastern part of the State, and maps of these lakes have been published. The investigation of the biology of the waters has been fairly begun. The physical geography of the lake region of southern and eastern Wisconsin is now being studied by Mr. N. M. Fenneman.

The first educational bulletin has recently been published by Professor R. D. Salisbury, on the physical geography of the region about Devil's Lake. This is intended to set forth the geography and the surface geology of the region in such a way as to bring out the principles of physical geography involved, so that the book will be primarily of value to the teachers and students of the subject, but it is also a contribution to our knowledge of that region.

This brief notice touches only the most important directions in which the Survey has been working, leaving unmentioned many subjects to which less attention has been given.

So far as the experience of the Wisconsin Survey goes, it appears that the State is quite willing that a considerable amount of money should be devoted to investigations whose value is scientific in the fullest sense of the word, and it also expects a considerable amount of attention to be given to subjects of economic value and of immediate practical importance. This seems to me to be entirely right. The State has a right to expect an economic return for money expended in a State survey, especially as there are

subjects of economic value which demand immediate investigation and whose study is the duty of a survey. On the other hand, the Survey ought not to allow its attention to be directed to subjects of immediate economic interest only, since, as we all know, the pure science of the present becomes the applied science of the future, and it is eminently the task of the Survey to work for the future as well as for the present. The Wisconsin Survey has endeavored to fulfill both these requirements, so far as the means at its disposal would permit, and its efforts have been fully endorsed by the State.

E. A. BIRGE.

UNIVERSITY OF WISCONSIN.

THE Natural History Survey of Minnesota is being carried on in pursuance of an act approved in 1872, and entitled "An act to provide for a geological and natural history survey of the State and to entrust the same to the University of Minnesota." In accordance with this law the Board of Regents of the University at once appointed Professor N. H. Winchell geologist of the Survey and placed the work under his supervision. The funds for carrying on the work have been almost wholly derived from the sale of so-called 'State salt lands' set aside for the Survey. After about 20 years of good work by the geologist, the geological work has been ordered to be brought to a close and the natural history has been taken up, with the professors of botany and zoology in charge of the botany and zoology respectively.

The law creating this Survey is so broad in its scope that so-called purely scientific investigations are as incumbent upon those in charge of the work as the so-called economical. Accordingly we do not at present divide this work into scientific and economical problems, but try to do scientifically everything we undertake to do, whether it has an immediate practical bearing or not.

Economical and practical questions are by no means neglected, and the plans at present being followed contemplate reports that will be of educational and scientific value, as well as a handy source of information to the citizens of the State.

On the zoological side the vertebrates are at present receiving the most attention. So far as possible complete accounts of certain more or less typical species, and species that for one reason or another are of special interest and importance, are being prepared in connection with the more general reports. These individual biographies, as they might be called, are intended to serve as guides and reference texts in the schools of the State. The invertebrates are not being neglected, though with the exception of one or two groups they are not receiving special attention at present. Plankton work can not be said to have received any serious consideration, and probably will not as long as more promising and less 'killing' fields are as plentiful as they are.

In reply to questions and suggestions, it was stated that both the botanist and zoologist made it a point to send their reports, not only to all the schools of the State, but so far as possible also to all the newspaper offices in the State.

An examination of Minnesota Plant Life, issued by the botanist of the survey, will convince the most skeptical that State reports can be issued in the best typographical style. This matter, however, demands special attention and experience.

In consequence of the close connection between the University and the Natural History Survey, the biological departments of the University have become the bureau of information on natural history questions for the entire State, and the professors of botany and zoology annually answer hundreds of letters—yes, in some years, thousands.

The matter of cooperation between the

surveys of the different States has come up frequently, but I am not sure that we are ready for any definite plans. It would seem that cooperation along some lines at least would lead to most valuable results, but how to adjust these so differently organized surveys is much more difficult than picking out the problems. I am inclined to believe that we shall have to go over our fields independently at first and look toward cooperation later on. In the meantime suggestions and discussions and reflection should not be set aside altogether.

H. F. NACHTRIEB.

UNIVERSITY OF MINNESOTA.

It is to be regretted that Professor Forbes is necessarily absent from this meeting, since he only can adequately discuss matters connected with the Natural History Survey of the State of Illinois. It is to his energy and foresight that the Illinois State Laboratory of Natural History, which is charged with its accomplishment, owes its origin, some twenty-five years ago, and it is to his oversight and direction that its success is due.

The conditions affecting the biological survey of Illinois differ materially in several particulars from those existing in Minnesota and Wisconsin. Illinois has no State geologist nor State geological survey, so that from its beginning the biological survey has been free from some of the difficulties experienced in a few of the neighboring States.

In 1877 the Legislature established what is known as the Illinois State Historical Library and Natural History Museum, at Springfield, and the Illinois State Laboratory of Natural History, at Normal, Illinois, with Professor S. A. Forbes as its director. The State Laboratory was established with several functions to perform. The law provided that by it the museum at Springfield should be supplied with mate-

rial illustrating the fauna of the State; that educational institutions and high schools should be supplied with material for instructional purposes; and besides these educational activities, a State survey of the animals and cryptogamic plants was to be carried on; and, finally, certain studies of an economic character were to be made with reference to the food of fishes and of birds. In 1883 the director was made State Entomologist, and for a number of years subsequently there was no sharp division between those operations of the State Laboratory carried on in connection with economic entomology and those for which the institution was originally established. In 1885 the State Laboratory was moved to Urbana in consequence of the appointment of its director to the chair of zoology in the University of Illinois. From 1883 to 1893 the Natural History Survey work was somewhat intermittent in character, but with the establishment of the Biological Station on the Illinois river, the work has been carried on continuously along the lines originally intended. The appropriations have in most cases been reasonably liberal, and have gradually increased from \$3,000 per annum to nearly \$10,000, aside from the appropriations for economic entomology. At no time has the State Laboratory had the backing of any scientific society or of any other association in any way helpful in securing legislative appropriations. It has at all times stood strictly on its merits and the value of the work accomplished, and its continual growth is due to the confidence which members of the Legislature have felt in the integrity of the director as a man, and in his energy and ability as a scientist.

The laws under which the State Laboratory was founded and has been supported seem to emphasize the educational part of its duties rather than the scientific and economic features. Professor Forbes's working definition of 'survey' involves more than a



mere census of animals and plants or a publication of lists showing local and geographical distribution. It is broad enough to include matters of an ecological character, and this view has largely determined the general plan of operations. It would have taken less time to send the material of the various collections to specialists at Washington, or elsewhere, and have identifications made by them, than to collect the necessary literature and allow the time and expense involved in the training of a group of specialists on the staff of the State Laboratory; but the former plan would have resulted simply in the accumulation of named material as a basis for lists of plants and animals with reference to local and geographical distribution, while the latter course is essential to a natural history survey in a wider sense. The director regards as one of the most important objects to be attained by the State Laboratory investigations, the presentation of the knowledge obtained in a form accessible to all interested intelligent citizens of the State. Much remains to be done before this work will be completed. Most of the literature thus far published by the State Laboratory has been more or less technical and written with reference to the specialist, but such material is to be considered as a sort of by-product incidental to the prosecution of the more essential duties.

Two important lines of work are now in progress. One of these, the ichthyological survey, has received much attention during the past two years and will result in the publication of a comprehensive report on all the fishes occurring within the borders of the State, in which as full an account as practicable of life histories, habits and conditions of environment will be given in addition to the ordinary descriptive matter. Each species is to be illustrated by colored plates made from living specimens. I have brought, for the inspection of those

interested, a few of the drawings already prepared, which reflect great credit on the State Laboratory artist, Miss Lydia M. Hart, by whom they were made.

Another line of work which is being vigorously prosecuted is the study by Dr. Kofoid of the plankton material collected from the Illinois river at frequent intervals during a period of nearly five years. The work of counting has been completed, and the data are being got into proper form as rapidly as possible. As a result of this work much interesting and important knowledge is being gained concerning the life histories, seasonal distribution, relative numbers and sequence of succession of many of the minute organisms composing the river plankton. As most of the counting work has been done since Dr. Kofoid made a preliminary report in this place a year ago, I may mention that some interesting facts stated by him in a tentative way have been confirmed. For example: (1) the marked constancy in the seasonal recurrence of many species, with their maximum and minimum numbers appearing annually within narrow time limits—perhaps an adaptation to definite temperature conditions; (2) the constancy of a spring and fall maximum for many species, the latter secondary—these maxima indicating perhaps an adaptation to the mean temperature of the year; (3) the evidence of the extreme variability of some of the limnetic forms and the probable genetic connection within the season of a number of supposed species—as in the case of *Brachionus bakeri* and its related forms and of *Dinobryon*, composite colonies of the latter being often found, different portions of which are made up of very different types of individuals, types which more frequently will be found in small colonies of homogeneous character and which have received various specific names; (4) the presence of a minute plankton flora occurring within about the same seasonal limits

as the foliage of the trees and disappearing as abruptly. For the greater part these forms are so minute that they ordinarily escape the silk net, and it is only in collections made by some filter method that an adequate idea of their importance can be gained. Detailed examination of the filter-paper catches tends to confirm the criticisms of Dr. Kofoid with reference to the dependence on collections made by the silk net alone. The loss by leakage or escape is often volumetrically as well as numerically very large. Other interesting facts might be referred to, but there is scarcely sufficient excuse for it in this connection.

A paper of systematic character on the leeches of the State Laboratory collection, by Mr. J. Percy Moore, is now in press, and an article on the Odonata, by Professor Needham and Mr. Hart, is nearly ready for the printer. Aside from numerous publications of an economic entomological character there have been published two quarto volumes on the birds of the State, and five volumes of the *Bulletin of the Illinois State Laboratory of Natural History*.

As to future work, it is probable that a comprehensive entomological survey entirely distinct from economic investigations will be undertaken in the near future, and work is now in progress on the first one of a special series of bulletins of what may be termed an educational nature, in which the object will be to treat various groups of animals in such a way as best to meet the needs especially of teachers and students of zoology in high schools and colleges. These bulletins, while giving descriptions and synoptic keys, are at the same time to include such physiological and ecological matter as will make them useful. It is intended that they shall be scientific, but written for others than specialists.

While cooperation in the work of the various State surveys would theoretically have several advantages, it practically

seems well-nigh unattainable because of the great difference in the conditions governing the action of each. Efforts have been made within the past few years to bring about such cooperation, but without result. If it were possible to have the energies of different surveys directed in part along similar lines of work synchronously, so that one specialist might work up a given group of animals for several States, there would be evident economy in time and money; or such special educational publications as those previously referred to might, with comparatively small additional outlay of time and money, be adapted to use in several States instead of but one. It might be greatly to the advantage of the surveys in different States if competent men in charge of the biological departments of some of the educational institutions of the State should become interested and responsible for the working up of special groups; and as far as Illinois is concerned, Professor Forbes would be greatly pleased if such cooperation between the State Laboratory and some of the working biologists in the State might be accomplished. He would willingly procure necessary literature and aid in the matter of collections, and although not ready to make unconditional promises of compensation, would, I am sure, feel warranted in cooperation of a financial, as well as of a scientific, sort. Here we meet with one of the great difficulties in the economical prosecution of such survey work. The instruction in our leading institutions is so exclusively along morphological and physiological lines that the men coming from such institutions are not prepared for the kind of work required in surveys, and much time and expense is involved before they can accomplish results. A vacancy on the State Laboratory staff is often a serious matter, because of the impossibility of finding men already prepared to prosecute such work. FRANK SMITH.

UNIVERSITY OF ILLINOIS.

*THE TRAINING OF AN ELECTROCHEMIST.*

At the meeting of the German Electrochemical Society in Zürich, last August, Professor Richard Lorenz,\* at the request of the Society, read a paper on the kind of training which is desirable for an electrochemist. The paper contains much which is suggestive in reference to the training of chemists in general, and calls attention to certain defects in the present method, especially as applied in many of the German universities.

Lorenz first raises the question as to whether electrochemists are entitled to recognition as representing a separate and distinct branch of science, and, notwithstanding the fact that they have not yet received such recognition in all the schools, answers the question, of course, in the affirmative. The battle in reference to the existence and recognition of electrochemistry is, in most places, at an end. Its chief enemy is the one-sided manner in which chemists, until recently, have been trained; and this one-sided method of training still obtains in some universities. We know, to-day 'that a chemical doctor well trained in all directions' is often nothing but a special organic chemist. Even if in some cases the candidate has learned a little analytical chemistry in order to be able to pass certain examinations outside of the university, he knows absolutely nothing of that fundamental branch of science—physical chemistry—and his knowledge of inorganic chemistry is so fragmentary that it cannot be called scientific—of the science of inorganic chemistry he knows essentially nothing.

It is quite different at certain polytechnic institutions where inorganic chemistry is constantly introduced in connection with technical chemistry and metallurgy.

Since electrochemistry, as is well known, is one of the best developed branches of

physical chemistry, the electrochemist should be trained in physics and in chemistry. Organic chemists should also know much more physics than is usually required of them.

Electrochemistry is also very closely connected with inorganic chemistry, and the rise of physical chemistry and electrochemistry in Germany has reawakened an interest in inorganic chemistry, which had almost entirely disappeared. Modern electrochemistry is an exact science, and rests on a mathematical basis. Every electrochemist must, therefore, be trained in the elements of the higher mathematics, and be able to use the differential and integral calculus. Later he must apply thermodynamics and chemodynamics to the problems as they arise. It is not until mathematics is applied to special problems that its significance is appreciated by the investigator of nature.

It is difficult to lay too much stress on the importance for an electrochemist of a general training in physics. He should be trained first of all in mechanics, then in sound that he may become familiar with the conception of wave-motion, also in heat, light, electricity and magnetism.

The physicist, in training a skilful electrochemist, should not ask "What use can he make of my knowledge?" and he should not adapt his teaching to special needs. The electrochemist, as well as the practical chemist, can use all physics. They may have to do with the magnetic properties of the atoms, or with heat phenomena, or with photometric relations, or with the kind and nature of the vibrations in an ozonator, or with fusion, evaporation and specific heats in the electric furnace. If the physicist were to consider simply the 'needs of the electrochemist,' he would teach him simply the chapters which pertain to electrical measurements. This would be a serious error and would retard the development of electrochemistry along broad

\* *Ztschr. elect. Chem.*, 7, 201.

and general lines. The need of the electrochemist is for the broadest possible development in the science of physics.

Analytical chemistry is of fundamental importance for the electrochemist. He should be able to make more or less complex analysis not only accurately, but rapidly. Speed in carrying out an analysis is often a necessity.

Inorganic chemistry is still taught but little at the German universities, and this is, of course, fundamental for the electrochemist. Some little inorganic chemistry is taught under the head of 'general chemistry.' In other places some lecture experiments are shown, and equations written, showing the transformations of substances. In other places inorganic chemistry is dealt with from the standpoint of the modern theory of ions. But in the last decade inorganic chemistry has developed as rapidly and made as great strides as theoretical chemistry. Thus, the vast amount of knowledge which we have in reference to the formation and decomposition of double salts, the beautiful experiments in the field of complex compounds, the extension of our science to the rare gases and rare earths, the reactions of substances at high temperatures as studied by the French school, the transformation temperatures and, finally, the fundamental relations of all phenomena to the Periodic System, are seldom dealt with. We need a place in which these matters can be *really systematically discussed* and brought to their attention. We should teach the students fewer formulas and more about the *real knowledge of the properties of all the elements and compounds*.

We know from the lectures of Van't Hoff on 'The Increasing Importance of Inorganic Chemistry,' and of Hittorf on 'The Necessity of Establishing Special Chairs for Inorganic Chemistry in the German Universities,' that the chairs of inorganic chemistry have been occupied almost ex-

clusively by organic chemists, whose interest and indeed whose knowledge were not in this field. As co-editor with Küster of the *Zeitschrift für anorganische Chemie*, I have had the very best opportunity to observe how great has been the growth in this field. If any one should think that the reason for desiring new chairs of inorganic chemistry to be established is in any way connected with the desire that certain individuals should have full professorships in inorganic chemistry, he has not obtained his information from the proper source.

In reference to the training of the electrochemist in organic chemistry, that is already amply provided for, and nothing further need be said concerning it. The electrochemist should also study as subordinate subjects mineralogy, crystallography, geology, etc.

Lorenz then takes up the question as to how far the electrochemist should be familiar with mechanics, a knowledge of machines, mechanical drawing, etc. He recognizes the force of Ostwald's warning, that the student should not have too many subjects, but under present conditions electrochemists, in out-of-the-way places, may have to fill so many rôles that a knowledge of these mechanical matters is often a necessity.

In reference to the special electrochemical training; instruction should be given, as Knorre has already pointed out, in general and technical electrochemistry, in general physical chemistry, as well as in thermochemistry, chemical dynamics, organic electrochemistry, chemical thermodynamics, etc. The student should be so trained in mathematics that these subjects can be dealt with mathematically. The best means to train and develop an electrochemist, in general, is the carrying out of a scientific investigation, as Ostwald has already maintained.

Lorenz then takes up the discussion of

the work which should be done by the electrochemist in the laboratory, and finally describes the training which the students in the Polytechnic Institute in Zürich receive. The point which is of chief interest here is that *mathematics is required for every chemist*, and physics is introduced in the broadest way into the course of every chemist.

The scientific importance of this address is much greater than would be implied by its title. The question arises whether much that was said by Lorenz does not apply to other branches of science or, perhaps, to all, although it is true that some of the natural sciences, chiefly on account of the relative complexity of the phenomena dealt with, are not yet sufficiently advanced to enable the mathematical methods to be extensively applied to them, yet they are all rapidly approaching that stage which we may describe as the mathematical.

Take as an example the science of chemistry. Physics, the furthest developed of all the natural sciences, has long since become an exact or mathematical science. It has been only a short time since a student could get on fairly well in most branches of chemistry without any knowledge of the higher mathematics. But how different to-day? A chemist now who is not familiar with the calculus can have no adequate conception of the theoretical side of his science, as Van't Hoff and others have repeatedly pointed out. In inorganic chemistry, at least in its latest developments, the calculus is absolutely essential, since inorganic chemistry is touched at all points by physical chemistry, and who can know anything of physical chemistry without the calculus. Take on the other hand organic chemistry. There are certain very important phases of this subject into which the higher mathematics has not yet entered; but in the study of the velocity of organic reactions, of the chemical dynamics and

statics of such reactions, not only the calculus is required, but also a fair knowledge of thermodynamics. In physical chemistry a knowledge of the higher mathematics and of physics is just as essential as a knowledge of chemistry itself, and thus it goes through the whole field of chemistry.

A student who starts out to-day to become a chemist without a good knowledge of physics and mathematics is hopelessly handicapped at the outset, no matter to what division of chemistry he may turn his attention.

In other branches of science we already see the dawn of the exact or mathematical period. Take physiology, one of the most complex of the biological sciences. Certain phenomena of life have already lent themselves to mathematical treatment, as is shown by the work of Loeb and others. The application of physical chemistry to physiology seems to mark the introduction of the mathematical method in dealing with the physics and chemistry of life.

Take morphology—the work of Davenport shows that even structure can be treated by the exact method, and makes it probable that the morphologist in the future will have to look to his higher mathematics.

Other branches of science might be cited, but these suffice to show how rapidly the mathematical method is coming to be applied to all scientific knowledge. *Perhaps the most distinguishing feature of scientific study at the beginning of the twentieth century is the introduction of the mathematical method into all those branches of knowledge which are sufficiently developed.*

One of the most important features, therefore, in scientific training to-day is a thorough course in the elements of the higher mathematics, and this should be followed in every case by an equally thorough course in physics. The student who is not thus equipped can never hope to pass

beyond empiricism, nor obtain any insight into the real meaning and relations of natural phenomena.

HARRY C. JONES.

*APPROPRIATIONS FOR THE U. S. DEPARTMENT OF AGRICULTURE.\**

THE passage of the agricultural appropriation act for the year 1901-1902 marks an epoch in the history of the development of the national Department of Agriculture. Not only does it carry the largest appropriation ever made for the Department and provide for future extension of its work in various lines, but it inaugurates a scheme for the partial reorganization of the scientific branches of its work. Three of the present divisions are raised to the grade of bureaus, and a number of other divisions are associated in one large Bureau of Plant Industry, corresponding in a general way to the present Bureau of Animal Industry.

Starting first as an appendix to the Patent Office for the distribution of seeds, the Department of Agriculture was formally organized in 1862 as an independent department in charge of a commissioner, and in 1889 was raised to the dignity of an executive department. The passage of the Hatch Act providing for agricultural experiment stations about that time increased its responsibilities and extended its field of usefulness.

The growth of the Department has been steady and uninterrupted. The importance of its work has been recognized by steadily increasing appropriations, and the relations maintained with the experiment stations furnish a means of carrying its investigations into every section of the country, in cooperation with these institutions, and serve to broaden its influence. As an institution for agricultural investigation it is

\* From proofs of the 'Experiment Station Record,' Vol. XII., No. 9.

now without a counterpart in any country, and there are few, if any, scientific institutions which include so large an aggregation of scientists and experts devoting their attention to investigations and research. The Department is coming to be generally recognized as one of the great scientific institutions, not alone in this country, but of the whole world. The formation of bureaus is a fitting step at this juncture, for it is a recognition of the growth which has been made and the need for a more compact form of organization. The creation of these four new bureaus, in addition to the Weather Bureau and the Bureau of Animal Industry, is a following out of the general divisions into which the subject of agriculture seems logically to fall, associating such lines of work as relate closely to each other and providing for the closest cooperation practicable among them.

The new Bureau of Plant Industry embraces the divisions of Botany, Vegetable Physiology and Pathology, Agrostology, Pomology, and Gardens and Grounds, and is under the directorship of B. T. Galloway. To this bureau has also been assigned the Section of Seed and Plant Introduction, together with the general supervision of the experiments in tea culture. A horticulturist will be added to the list of specialists, with the intention of developing the work of investigation along that line. From the standpoint of administration the arrangement will be an economy of time and will give greater opportunities for investigation to the chiefs of the divisions.

In recognition of the plan for a systematic survey of agricultural soils and for extension of the work in forestry, the divisions of Soils and Forestry receive bureau organizations and are raised to that designation. The fourth bureau provided for is the Bureau of Chemistry, to which additional scope will be given.

The appropriation act makes frequent mention of cooperation between the different divisions of the Department and also with the agricultural experiment stations. The establishment of the Bureau of Plant Industry will favor the extension of the cooperation and will assist in adjusting the lines of work and preventing any tendency to duplication.

Of the new bureaus the Bureau of Plant Industry receives the largest appropriation, namely, \$231,680. The amounts appropriated for the different lines of investigation in charge of this bureau, aside from certain salaries, are \$60,000 for investigations in vegetable pathology and physiology, \$20,000 for pomological investigations, \$45,000 for botanical investigations and experiments, \$20,000 for grass and forage plant investigations, \$20,000 for seed and plant introduction, \$7,000 for tea-culture experiments (an increase of \$2,000), and \$20,000 for gardens and grounds. The total appropriation for the Bureau of Plant Industry represents an increase of \$61,900 over the combined appropriations for the previous year of the divisions associated in it. A new feature of the botanical investigations is the study of useful plants of the tropical territory of the United States, together with plants likely to be of value for introduction into those sections. Furthermore, investigations are to be made on 'the varieties of wheat and other cereals grown in the United States and suitable for introduction, in order to standardize the naming of varieties as a basis for experimental work of the State experiment stations and as an assistance in commercial grading'; and in cooperation with the Bureau of Chemistry, the cause of deterioration of export grain, particularly in oceanic transit, is to be investigated, together with means of preventing such loss. Special mention is made in the appropriations for this bureau of the employment of scientific

aids, a class of employees drawn from the agricultural colleges, which has previously been arranged for in the Department.

The Bureau of Forestry receives \$185,440, an increase of \$105,440 over the previous year. The appropriation for the Bureau of Soils is \$109,140, which is an increase of \$77,840. This is to enable an extension of the tobacco investigations, which remain in charge of this bureau, and the investigation and mapping of soils in the United States. The Bureau of Chemistry receives \$35,800, and in addition to its other duties is charged with the investigation of food preservatives and coloring matters 'to determine their relation to digestion and to health and to establish the principles which should guide their use.'

The Weather Bureau receives increased appropriation for general maintenance, and \$46,000 for the erection and equipment of buildings in six different places, and for laying a cable between the mainland and Tatoosh Island, Washington, making the total appropriation \$1,148,320. The maintenance fund of the Bureau of Animal Industry is increased \$50,000, and the inspection work is extended to include dairy products intended for exportation to foreign countries. Such products, the same as meats, may be marked, stamped or labeled, so as to secure their identity and indicate their purity and grade. This is an entirely new provision, which it is hoped will tend to place American products on a better footing in foreign markets. An appropriation of \$25,000 is made, in addition to one of \$50,000 last year, for animal quarantine stations, giving a total for the bureau of \$1,154,030.

The appropriations for agricultural experiment stations have reached the sum of \$789,000, including \$33,000 for the Office of Experiment Stations, as heretofore, and \$12,000 each for stations in Alaska, Hawaii and Porto Rico. The Hawaii station

will be located near Honolulu on a government reservation originally set apart by the provisional government for the use of an experiment station. It is intended to make the work there supplementary to that of the experiment station which has been maintained by the Hawaiian sugar planters, and attention will be given to other field crops and the development of animal industry and horticulture. Jared G. Smith, recently in charge of the Section of Seed and Plant Introduction of this department, has been placed in charge of the Hawaii station, and will take up the work there about the middle of April. Fifty thousand dollars was appropriated to continue the irrigation investigations, and \$20,000 for nutrition investigations, the latter being an increase of \$2,500.

The Division of Statistics receives \$156,160, the same as last year, the Division of Entomology \$36,200, and the Division of Biological Survey \$32,800. The fund for publications is increased by \$50,000 for farmers' bulletins and a small amount for distribution, making the total for the Division of Publications \$198,020 aside from the general printing fund, \$110,000. Other appropriations are as follows: seeds, \$250,000, exclusive of the \$20,000 mentioned for seed and plant introduction, an increase of \$100,000; library, \$16,000; public-road inquiries, \$20,000, an increase of \$6,000; investigating the production of domestic sugar, \$5,000; Arlington farm, \$10,000; office of the Secretary, \$71,670; Division of Accounts, \$18,900; Museum, \$2,260, and contingent expenses, \$37,000. The grand total, including the regular appropriations for the experiment stations, is \$4,582,420, an increase of \$558,920 over last year.

An important item of the appropriation act is the authorization of the Secretary of Agriculture to submit plans and recommendations for a fireproof agricultural building,

to be erected on the grounds of the Department, and appropriating \$5,000 for the preparation of such plans. The Department long since outgrew its original accommodations, and for years has been badly cramped for room. The present main building has been condemned as unsafe, and from the nature of its construction the risk of fire has always to be met. Besides erecting a number of small buildings, which are mere temporary makeshifts, it has been necessary to rent several residences in the neighborhood and adapt them to laboratory and office purposes. Laboratory buildings for the Division of Chemistry and the Bureau of Animal Industry have been specially erected by private parties and rented to the Department. The amount now paid for rental for these buildings, together with the additional expense required for watchmen, aggregates about \$10,000 annually. The position to which the Department has now attained, the demands of its work, and the safety of its library records and collections, make a modern agricultural building a practical necessity if not an imperative need.

E. W. ALLEN.

THE REDUCTION TO ABSURDITY OF THE  
ORDINARY TREATMENT OF THE  
SYLLOGISM.

THE traditional treatment of the syllogism errs both by redundancy and by insufficiency—that is to say, the validity of the syllogism can be tested by a far simpler method of procedure, and, on the other hand, the ordinary method fails of application to a vast number of pairs of propositions which are nevertheless the premises of a valid syllogism. In the first and second moods of the first figure the syllogism is in what may be called its primitive form—it is doubtless the only form in which it is used by children and savages; but there is another form, in which negative modes of expression are given free play, which is far



superior to it in facility of manipulation. This superiority has its source in the fact that of the eight (not four, to which the ordinary logic has reduced the forms of speech) propositions necessary to a complete description of the universe,—

- |                          |                              |
|--------------------------|------------------------------|
| a. all $a$ is $b$ ,      | ā. not all $a$ is $b$ ,      |
| ā. none but $a$ is $b$ , | u. some besides $a$ is $b$ , |
| ī. no $a$ is $b$ ,       | i. some $a$ is $b$ ,         |
| o. all but $a$ is $b$ ,  | ō. not all but $a$ is $b$ ,  |

it is the last four that possess the great advantage of being symmetrical (that is, of having subject and predicate amenable to the same rules of manipulation), and of these it is 'no  $a$  is  $b$ ' and 'some  $a$  is  $b$ ' that possess the other advantage of naturalness. These last should therefore be regarded as the canonical form of the proposition; and correspondingly, the ideal form of the syllogism is that in which it appears as a statement of the impossibility of concurrence of the premises and the denial of the conclusion of the ordinary syllogism. The canonical form of the syllogism is therefore this:

- |                      |
|----------------------|
| no $a$ is $b$ ,      |
| no $c$ is non- $b$ , |
| some $a$ is $c$      |

and

are inconsistent (or cannot all three be true together). This may be called the Inconsistency, or the Incompatibility, or, perhaps, the Antilogism. But in this all three propositions play an exactly similar rôle—there is no distinction between premises and conclusion, and it is therefore the one single form to which every syllogism may be at once reduced, provided we (1) express every universal proposition in the negative form, no  $p$  is  $q$ , (2) express every particular proposition in the affirmative form, some  $r$  is  $s$ , and also (3) deny the conclusion. When thus reduced to the form of an inconsistency, the rule for validity is this: of the three propositions, two are universal and one is particular; each two propositions have one and only one term in

common; the term common to unlike propositions appears with like signs and the term common to like propositions appears with unlike signs. (Thus in the above typical form,  $b$  and non- $b$  are common to the two universal propositions, but  $a$ , or  $c$ , of like quality, are common, respectively, to the particular and either universal.)

Any given statement of fact may be expressed in terms of any one of the four different copulas given above, or again, with the aid of the special terms *the non-existent* and *the existent* ( $0$  and  $\infty$  in Symbolic Logic), it may be expressed in four different ways with one and the same copula; thus

- |                              |                                  |
|------------------------------|----------------------------------|
| all $a$ is $b$ ,             | nothing is $a$ and $\bar{b}$ ,   |
| all $\bar{b}$ is $\bar{a}$ , | everything is $\bar{a}$ or $b$ , |

are four different forms of one and the same statement of fact (expressed in the four possible combinations of two terms and their negatives); but in the two symmetrical copulas (no  $a$  is non- $b$ , all but non- $a$  is  $b$ )\* the four forms all become practically identical. There are therefore ten ( $4 + 4 + 1 + 1$ ) essentially different ways of saying one and the same thing. As each proposition of the Inconsistency can be expressed in any one of these different ways, and again as each Inconsistency can appear in the form of the universal or of the particular syllogism, the total number of possible syllogisms (when full latitude is given to mode of expression) is two thousand ( $10 \times 10 \times 10 \times 2$ ). An example of one of these outlying forms is this: none are athletic and unhealthy, none are healthy and unhappy, hence all are either

\* It is, to a certain extent, matter of taste whether  
 no  $a$  is  $b$ ,            nothing is both  $a$  and  $b$ ,  
 no  $b$  is  $a$ ,             $a$  which is  $b$  is non-existent,

be regarded as different forms or not,—and so 'all but  $a$  is  $b$ ,' etc. If it be preferred to consider them as different, then the entire number of propositional forms is 16 instead of 10 and the number of different syllogisms is  $16 \times 16 \times 16 \times 2 = 8192$ .

happy or non-athletic. Any one of these two thousand forms can be at once tested as regards its validity by the above 'Rule for the Inconsistency.'

CHRISTINE LADD FRANKLIN.

AMERICAN CHEMICAL SOCIETY.

THE American Chemical Society will celebrate the 25th anniversary of its foundation in the city of New York, on Friday and Saturday, April 12th and 13th. Prominent chemists from every portion of the United States are expected to participate in the festivities which include a presentation of the history and achievements of the Society, its present scope of work and influence and a general review of the progress of chemical science in this country during the past twenty-five years. The present condition of the science of chemistry will also be shown, and the extent of its applications to the various industries.

The American Chemical Society is an outgrowth of a meeting of American chemists held in Northumberland, Penn., August 1, 1874, to celebrate the centennial of the discovery of oxygen by Sir Joseph Priestley. The large body of eminent chemists there assembled believed that the time had come for the formation of a permanent society, which should be representative of American chemists and their work, as the foreign chemical societies are of the chemists of their respective countries.

It was not until the year 1876, however, that this idea took definite form in the establishment of the American Chemical Society. In the early part of that year the Society was organized, and in 1877 it was incorporated under the laws of the State of New York.

The first president was that distinguished chemist and physiologist, Dr. John W. Draper, of the City of New York, whose researches in spectrum analysis and pioneer work in the production of the daguerreotype and photograph will never be forgotten.

From the beginning the Society has published regularly a journal of its proceedings, including papers and discussions. Many of the leading chemists of this country have been enrolled in its membership; prominent chemical manufacturers have been among its associates; and not a few of the names of foreign chemists of distinction have been upon its roll, either as active or as honorary members.

About ten years ago very radical changes were effected in the methods and operations of the Society, and the results that have followed have proved the wisdom of the steps thus taken. The important features of the present plan of organization and operation are as follows:

1. Local sections are established in different parts of the country, and the presiding officers of these sections constitute the vice-presidents of the Society.

The following is a list of these local sections up to date: Rhode Island, Cincinnati, New York, Washington, Lehigh Valley, Chicago, Nebraska, North Carolina, Columbus, North Eastern (headquarters in Boston), Philadelphia, Michigan and Kansas City.

2. The general management of the Society is entrusted to a broadly representative council which includes all the past presidents of the Society, one or more representatives from each local section and twelve councilors elected by the membership at large.

3. Two general meetings of the Society are held each year in different localities with a view of increasing interest in the Society and stimulating activity among the chemists in various sections of the country by bringing them into closer acquaintance with one another and into a knowledge of the various interests with which they are connected. The summer meeting is held with that of the American Association for the Advancement of Science, and the win-

ter meeting, which is the annual meeting of the Society, is held at some convenient point during the last week in December. The winter meeting of 1900 was held in Chicago last December. The Society will hold its next summer meeting in Denver, Colorado, August 26 and 27, 1901.

4. The *Journal* of the Society appears on the first of each month during the year. It has been greatly enlarged during the past decade, and every effort is put forth to make it worthy of the Society which it represents. It contains papers read before the various sections of the Society and in its general meetings, together with such abstracts relating to the progress of chemical science and industry, as seem desirable. The estimate in which the *Journal* is held in other countries is shown by the number of articles published in the *Journal* which are fully abstracted or copied entire by foreign periodicals.

The present officers of the Society are: *President*, F. W. Clarke, chief chemist, U. S. Geological Survey, Washington, D. C.; *Vice-Presidents*, the presiding officers of the various sections; *Secretary*, Albert G. Hale, Brooklyn, N. Y.; *Treasurer*, Albert P. Hallock, New York; *Editor*, Edward Hart, Easton, Pa.; *Librarian*, Edward G. Love, New York. The officers of the New York local section are: *Chairman*, Professor C. A. Doremus, College of the City of New York; *Vice-Chairman*, Professor M. T. Bogert, Columbia University; *Secretary* and *Treasurer*, Dr. Durand Woodman.

The total membership of the Society is about 1800, distributed mainly throughout the United States and other portions of the American continent. Some of its members are to be found in Cuba and other islands of the West Indies, others in various European countries, South America and Australia; in fact nearly every nation of the world is represented in its membership.

It is believed that this celebration, with

its record of the history and achievements of the Society, and its representation of the character and strength of the organization of American chemists whom it represents, will not only mark an epoch in the progress of the Society itself, but will point the way to higher attainments and greater triumphs in all departments of chemical science and its applications in the New World.

#### SCIENTIFIC BOOKS.

*Sur quelques microorganismes des combustibles fossiles.* Par B. RENAULT. One vol., roy. 8vo, pp. 460, with 66 text figs.; atlas, folio, 30 plates with explanation sheets. Extrait du Bulletin de la Société de l'Industrie Minérale. Troisième série, tome XIII., 4<sup>e</sup> livraison, 1899. Tome XIV., 1<sup>re</sup> livraison, 1900. Saint-Etienne, 1900.

This is a superb work on a very difficult, but at the same time very important subject both for the geologist and the biologist. It has been many years in process of elaboration, and more than a dozen preliminary papers, dating back as far as 1892, announcing important results as fast as they were reached, have appeared by the same indefatigable investigator, mostly unaided, but also occasionally in association with MM. Bertrand and Roche, who are working somewhat along the same lines.

It is fashionable in our day to extol the wonders of the microscope, especially so since the modern bacteriological investigations began with their momentous practical consequences. The medieval philosophers had not probably any adequate conception of the real meaning of their fine alliterative phrase: *Deus magnus in magnis, maximus in minimis*. Spencer's 'soul of truth in things erroneous' also finds exemplification here, for the 'devils' of which men were once believed to be 'possessed,' in disease, epilepsy, insanity, etc., and which it was sought to 'cast out' by exorcism and prayer, have been shown by the microscope to be real living things—malignant spirits—the invisible germs of disease.

But while it has become clear that these modern revelations have not brought anything new to light, and that these devils were as numer-

ous, as rampant, and as malignant in biblical times as they are to-day, it is only quite recently that the world has gained any conception of their enormous antiquity, and if any one ever supposed that their chief mission was to punish man for his sins, the fact, now made clear by this and kindred investigations, that they existed in equal numbers and in all parts of the world in Tertiary, Secondary, and even Primary time, *i. e.*, ten to fifty millions of years before man made his appearance on the globe is calculated to shake that belief. The microscope, which has so wonderfully illuminated the hidden mysteries of the present and the invisible world in which we live, has now been leveled at the past and brought to bear upon that vast and hoary antiquity of which we could scarcely form a conception even if we were able to express it in terms of our chronology.

In this work M. Renault treats the microorganisms of past ages under eight different heads, chiefly in the descending order of their occurrence in geologic time, viz., 1st, those found in peat beds of recent origin; 2d, those found in lignite beds, chiefly of Tertiary age; 3d, those found in certain modern bituminous schists; 4th, those found in the so-called boghead formations; 5th, those found in cannel coal; 6th, those found in true coal of the Carboniferous formation; 7th, those found in certain ancient bituminous schists; 8th, those found preserved in flint or silica, chiefly of Carboniferous age.

Peat may be called coal in the making, and consists almost entirely of vegetable matter that has accumulated, often to considerable thickness, where this matter has undergone prolonged maceration. The bulk of it is formed of the remains of the plants that grew on the spot, and which, either from the weight of this constantly increasing superincumbent mass, or from other causes, slowly sink and become buried by successive renewals of the same materials. It takes place in marshes or swamps kept perpetually wet or submerged, under which conditions certain plants long retain their vegetable substance. Many of them, especially dicotyledonous leaves and certain mosses, are thus often preserved permanently,

and from their remains much may be learned of the flora of the period at which the peat was formed. Certain seeds are also well adapted to permanent preservation in peat, and it is only recently that extensive investigations of the peat beds of northern Europe have been undertaken by this method. Mr. Leo Lesqueux published in 1844 the results of extensive researches made by him on the peat bogs of the Jura Mountains and Central Europe, and Axel Blytt, Nathorst, Andersson, Sernander, Munthe and others have thoroughly studied those of Scandinavia and other northern regions, while Mr. Clement Reid has in this way successfully worked out the problem of the origin of the British flora. Besides impressions of mosses, and of leaves and stems, and the numerous seeds of spermatophytes found in these beds, the siliceous spicules of many genera and species of diatoms have been detected and systematically treated.

But M. Renault has availed himself of the higher powers of the microscope and has made known to us a large number of other forms of microscopic life. The Bacteriaceæ are found abundantly in the peat of Fragny and Louradon in France, and he has illustrated species of *Bacillus*, *Micrococcus*, *Streptococcus*, *Cladotryx*, etc. The mycelium of numerous fungi also occur.

The principal lignites studied for this monograph have been those of Héroult in the Department of Ain, of Saint-Martin-du-Mont (Ain), of Célas, and Durfort (Gard), and of Sainte-Colombe (Yonne). The first of these, which are Eocene in age, yielded both animal and vegetable forms; Infusoria of the genera *Aspidisca*, *Cinetoconia*, *Ploesconia*, *Vorticellina*, etc., the conidia of fungi referable to the genera *Helminthosporium* and *Macrosporium*, and the mycelium of species of *Morosporium*. Diatoms also occur (*Frustulia*) and Micrococci. The other lignites from localities in France were less fruitful but contained some of the same forms. Besides these, however, M. Renault examined material from Vicenza in Italy and from Coronel in Chili. The latter especially was found to be rich in conidia of the genus *Helminthosporium* and in amœboid forms of the radiate type (*Orbulinella*, *Hedriocystis*, *Clathrulina*).

As an appendix to the treatment of the lignites the author has introduced the results of his investigation of a certain curious fossil combustible from the Lower Carboniferous (Culm) of Tovarkowo and Malevka in Russia, Government of Toula. It consists chiefly of the bark or cuticle of the ancient lepidophyte called *Bothrodendron*, which M. Renault considers distinct from *Lepidodendron*. M. Zeiller has carefully studied this form from the same localities, but the interesting point brought out by Renault is the presence over the whole surface of these paper-coal cuticles of bacteria (*Bacillus*, *Micrococcus*), of which a number of species are figured and described.

The bituminous schists studied for this monograph also proved rich in the remains of extinct microscopic life. Those of Menat, of Oligocene or Aquitanian age, and carrying dicotyledonous leaves of the genera *Planera*, *Liquidambar*, *Cinnamomum*, *Persea*, etc., yielded microscopic fungi (*Helminthosporium*), diatoms (*Amphora*), etc. Those of the Bois d'Asson in the basin of Mauosque, of Tongrian age, revealed the presence of Amœboids (*Dactylodiscus*), fungi (*Helminthosporium*, *Macrosporium*, *Sirodesmium*) and diatoms (*Fragilaria*). Some much older schists (Upper Lias) from Anina in Hungary were found to contain fossil algae resembling the Permian genus *Pila*, also species of fungi of the genera *Mucedites* and *Moro-sporium*.

The bogheads have formed the object of M. Renault's studies for many years. He has made the beds of Autun, his native city, celebrated by earlier researches. In the present work he has greatly extended his investigations and dealt with similar material from various parts of the world. The bogheads result from the accumulation at the bottom of chiefly Permian lakes of an enormous quantity of microscopic algae, which were probably gelatinous. In the process of deposition, maceration, and entombment their composition was greatly modified by various influences, among which bacteria played a part. The most important of the algae forming the bogheads of Autun was the *Pila bibractensis*, named by Bertrand and Renault in 1892. In the present paper the evidence of the agency of

bacteria in causing the fermentation of the algaoid mass is fully presented and the Micrococci are shown in varied forms.

In specimens of a similar character from the Permian of New South Wales found overlying the coal beds, and probably of Lower Permian age, there occurs another genus of algae which has been named *Reinschia* for Paul F. Reusch, a German investigator and pioneer in this branch of research. This same genus recurs in the bogheads of the Transvaal at Ermels. The Torbanite of Torbane Hill, Fifeshire, Scotland, which was the subject of a celebrated lawsuit over the question whether it could be classed as coal, and in which it was at last legally so classed, is treated by M. Renault as virtually a boghead, and yields a species of *Pila* (*P. scotica*). Crushed macrospores of this alga occur along with the globular thalli, and bacteria, although more difficult to find than in other bogheads, have been discovered, consisting of masses of Micrococci. The bogheads of Armadale in Linlithgowshire, Scotland, are formed of various gelatinous algae, among which another new genus (*Thylax*) is represented.

Among the numerous samples of American cannel coal which I was instrumental in having sent to M. Renault many years ago, and which he has carefully studied, there are some that he classes with the bogheads, especially those from Beaver Dam, Ohio County, Kentucky. These consist chiefly of the remains of a species of *Pila* (*P. kentuckyana*), whose isolated globular thalli form groups of eight or ten and are not disposed in bands. Bacteria are visible in the interior of the thalli.

The coal-bogheads of Alexandrewski, Kourakino and Murajewuja, in Russia, coal basin of Moscow, have a lignitoid appearance, and contain, besides a new species of *Pila* (*P. Karpinskyi*), a new genus, *Cladiscothallus*, with a much branched, discoid thallus. Adhering to the walls and penetrating the interior pulpy mass of *C. Keppeni* is a peculiar *Micrococcus*, which M. Renault has named *M. petrolei*.

The passage from bogheads to cannel coals is a short step, although these last usually belong to the Carboniferous period. They contain, however, to a considerable extent, the same flora

and fauna. In the so-called Bryant canal of England, M. Renault finds the *Pila scotica*, of Torbane Hill, with macrospores and affected with bacteria. Here occur filaments of a fungus which he calls *Anthracomycetes*. The mycelia invade the covering of the spores of the algæ. They are very fine but distinct under a high power (1000/1), and susceptible of clear illustration. Other canals of the Old World present substantially the same features.

M. Renault has carefully studied the specimens of canal coal sent him from America and the results are interesting. The specimens represented many localities in West Virginia and Kentucky, and the names he gives are: Cannelton and Davis Creek in West Virginia, and Beaver Dam (mentioned above), Little Laurel Creek, Natz Creek, Hunnewell, Georges Branch, Caney Creek, Blackwater Creek, Mercer Station, Magoffin County and Buena Vista in Kentucky. Those of Beaver Dam and Little Laurel Creek he classes as bogheads, the rest he regards as true canals. The Cannelton specimens are filled with spores of ferns and lycopods, the walls of which have Micrococci disseminated through them. Algæ are rare in most of the American material except that of the boghead type, but in that from Davis Creek, classed as canal, they occur, and belong to the above-mentioned genus *Cladisocthallus*. The species, however, is not the same as that of the Russian bogheads, and M. Renault has done me the honor to name it *C. Wardi*. It is discoid and spread out in a single plane with numerous dichotomous branches. It does not seem to be affected with bacteria. The specimens from Buena Vista, Kentucky, are wholly destitute of algæ.

In the coal basin of Commentry, in central France, which has yielded such a magnificent flora and great numbers of insects, and which I had the pleasure of visiting in September last, there is at the Puits Forêt a combustible mineral substance substantially representing canal coal. It has yielded to M. Renault's microscope a considerable number of organized bodies, consisting of spores of ferns and Equisetaceæ but no algæ. He also finds the macrospore of *Sphenophyllum* and pollen grains of gymnosperms, wood of *Cutamadendron*, and trans-

verse sections of leaves, probably of *Cordaites*. Throughout the mass are everywhere distributed numerous Micrococci, on the surface of the membranes of the spores, and pollen grains, in the fragments of indeterminable vegetable matter and in the general matrix. Similar conditions obtain in certain barren measures at Rivede Gier in the basin of Saint-Étienne, Upper Loire.

M. Renault treated many specimens of carbonized wood from the coal measures of Zsily, Hungary, Boule near Saint-Éloi (Puy-de-Dôme) and Decazeville in France, and found them more or less permeated with bacteria (*Micrococcus Carbo*, *Bacillus collectus*, *Cladothryx Martyi*). He also found filaments of saprophytic fungi.

The coprolites and certain fish bones and scales of the bituminous schists of Autun, Igornay and Lally proved a rich field for the microscope, large numbers of Micrococci, bacilli and fungi (*Mucedites*, *Anthracomycetes*) from these sources being illustrated in this work.

A still richer source of fossil microorganisms is the various Paleozoic flints that occur in certain coal basins and other deposits. It was from such that Brongniart described so many remarkable seeds and fruits of Carboniferous plants, chiefly from the basin of Saint-Étienne. They contain all manner of vegetable tissues, and M. Renault finds these permeated with bacteria and fungi. The silica has preserved everything with great exactness and the illustrations of microscopic organisms in this matrix are much clearer than those from the fossil combustibles. Some of these are older than the coal measures and are found in the Culm and even in the Devonian, as those of the Cypridine schists of Saalsfeld, in which silicified remains of *Cordiaoxylon* are affected by a *Micrococcus* (*M. devonicus*). At Estuost, near Autun, the roots of a species of *Lepidodendron* (*L. estnostense*) have buried in their parenchymatous tissue the eggs of an insect or arthropod, which has been named *Arthroon Rochei*.

Further details cannot be given here, but this notice should not be concluded without calling attention to the geological and even economic value of the work. It goes far toward furnishing the solution of many of the

most difficult problems that the study of the origin of coal and other fossil combustibles presents. It should be carefully studied from that point of view.

Neither should the fact be left unstated that in these difficult and recondite researches M. Renault has advanced theories that are not accepted by all, but the criticism and, if need be, the disproof of which belongs to those who are engaged in the same line of investigation and are equipped for such a task.

LESTER F. WARD.

*The Elements of Astronomy.* By Sir ROBERT BALL. New York, The Macmillan Company. 1900. 183 pages, 23 figs., and 11 full-page plates. Price, 80 cents.

This little book contains a clearly written account of astronomical subjects, adapted to the needs of beginners. After a brief historical introduction and an explanation of the apparent diurnal motion of the celestial sphere, the Sun, as the heavenly body most important to us and most interesting to the novice, is rightly placed first. If any change were to be suggested here, it would be that this topic should receive fuller treatment and more complete illustration. The author's admirable *Story of the Sun*, which is both accurate and interesting, fits him to present this subject advantageously.

It is to be regretted that the eclipse photographs, which are supposed to show solar prominences and the corona, are so badly reproduced as to be almost worthless; and while the introduction of photographic illustrations directly from nature is very desirable, the public has a right to demand that such pictures in a work of more than ephemeral value shall have that degree of precision which modern art processes are able to give. In case the publishers have not at their command facilities for reproducing pictures with delicate details, a well-executed engraving, correctly interpreting such details, is to be preferred to a poor photograph. Good illustrations are given of the Full Moon, Saturn, Jupiter, the Dumb-bell Nebula, and clusters in Hercules and in Perseus.

Since one of the objects of scientific study is

to inculcate conceptions of precision, the indiscriminate grouping of stars of several orders of magnitude from Sirius ( $-1.5$  mag.) to Capella (0 mag.) under the title 'first magnitude' stars (p. 7-8) is to be deprecated.

In an edition prepared for American readers it might be well, if a common name is to be used, to substitute The Dipper for The Plough in designating a part of Ursa Major which 'in this country' is familiarly known by the former title.

A similar remark applies to the statement on p. 57 that midsummer twilight in 'our' latitudes lasts all through the night, which lacks generality and is inappropriate in a science whose chief merit as a discipline for young readers is that it tends to broaden our conceptions by wiping out local distinctions.

The author's familiarity with mathematical processes gives him a firm grasp on everything of a geometrical nature, but also a beautiful simplicity and directness in his demonstrations, which does not always follow from individual comprehension. The chapter on the diurnal motion is simplified by the omission of some details which would have to be considered in a more extended treatise; but one cannot omit to note that quite apart from this, the method and language of the demonstration are uncommonly clear and convincing.

It is natural that we should expect the same clearness in those subjects which Sir Robert Ball has made peculiarly his own—such as precession and the tides—and the reader will not be disappointed here. The history of the Earth-Moon system and the chapter on gravitation will be found especially interesting.

It is permissible, even in an elementary treatise, that an author should develop somewhat those parts of the subject on which he is an authority and where he can speak better than any one else; and since a selection has to be made in a small work like this, it is just as well that the illustrations chosen should be those most familiar to the author; but there are other inequalities which cannot be commended.

A considerable space is devoted to an argument as to the exceedingly high surface-temperature of Jupiter, which is purely speculative,

and by no means as probable as the author maintains. The oceans of boiling water remind one of the cataclysmal hypotheses in vogue in earlier geological speculation, and raise the question whether here also there may not be a less sensational interpretation of facts.

The lunar temperature, on the other hand, in regard to which we have some knowledge derived from quantitative measurements, is not so much as mentioned in the book.

Barnard's fifth satellite of Jupiter is given a whole page, which, while commendable as an account of recent astronomical progress, seems to show a lack of perspective, since only an equal space is devoted to the other four moons with their wonderful harmony. Moreover, in spite of the prominence given to this excessively minute body, the moon, which continues to be called by an anachronism by the Roman numeral I, is alluded to as 'the innermost.'

The 'invisible rays' of the solar spectrum are treated as if they were synonymous with the ultra-violet rays. Over a page is given to this topic, but there is no mention anywhere of the much more extensive infra-red part of the spectrum which comprises rays of greater intensity and of more importance to the earth.

The statement on page 39 that 'we find each one of the multitude of lines in the artificial iron spectrum agreeing to the last degree of precision with the corresponding line in the solar spectrum,' is not in accordance with facts. Along with many wonderful coincidences, there are some notable differences which are of very great importance as furnishing a possible key to further solar mysteries.

The description of the solar corona and of sun-spots in Chapter II. is inadequate, and something more than a bare mention of the fact that there are different classes of stellar spectra is desirable; but the list of shortcomings is not long, and the book is to be commended for its attainment of an exceptional standard of excellence.

F. W. VERY.

#### GENERAL.

ANNOUNCEMENT has been made by a committee of American anthropologists, of which Mr. F. W. Hodge, managing editor of the

*American Anthropologist*, is secretary, of the proposed publication of a series of more than thirty folk-tales recorded and translated by the late Frank Hamilton Cushing during his long and intimate association with the Zuñi Indian tribe of New Mexico. The price of the work will be \$3.50. Information and subscription blanks can be supplied by the Secretary, whose address is Washington, D. C.

THE late Professor A. W. Hughes, left in an advanced state of preparation a new volume on practical anatomy. Professor Keith, of the London Hospital College, has undertaken to complete Professor Hughes's work, which will be published by Churchill.

#### BOOKS RECEIVED.

- Experimental Psychology.* E. B. TITCHENER. New York and London, The Macmillan Company. 1901. Volume I. Part 2. Pp. xxxiii + 456. \$2.50.
- Human Placentation.* J. CLARENCE WEBSTER. Chicago, W. T. Keen & Co. 1901. Pp. 126 and 30 plates.
- Studien über die Narkose.* E. OVERTON. Jena, Fischer. 1901. Pp. x + 195. \$4.50.
- Morphology of Spermatophytes.* JOHN M. COULTER and CHARLES J. CHAMBERLAIN. New York, D. Appleton and Company. 1901. Pp. x + 188.
- Les problèmes de la vie.* ERMANNO GIGLIO-TOS. Turin, Chez l'Auteur. 1900. First Part. Pp. viii + 286. 10 fr.
- Clays of New York, their Properties and Uses.* HEINRICH RIES. Albany, University of the State of New York. 1900. Pp. 593-944.
- The Manual of Laboratory Physics.* H. M. TORRY, and F. H. PRITCHER. New York, John Wiley and Sons. London, Chapman and Hall, 1901. Pp. ix + 238.
- A Select Bibliography of Chemistry. 1492-1897. Section VIII. Academic Dissertations.* H. CARINGTON BOLTON. Washington, D. C., Smithsonian Institution. 1901. Pp. iv + 531.

#### SCIENTIFIC JOURNALS AND ARTICLES.

*The Journal of the Boston Society of Medical Sciences* for December 18, 1900, delayed on account of the plates, has recently been issued. It forms a volume of 180 pages and 16 plates after photomicrographs, devoted to 'A Study of the Bacteriology and Pathology of Diph-



theria,' by W. T. Councilman, F. B. Mallory and R. M. Pearce. The material was derived from 220 fatal cases of diphtheria, and the various regions of the body are treated in detail. An extensive bibliography of recent literature on the subject is appended, the whole forming a most important contribution to our knowledge of diphtheria.

IN *The American Naturalist* for March, W. M. Wheeler and W. H. Long describe 'The Males of some Texan Ectoparasites' and incidentally tell much of the habits of these ants and of the raids made by them on other species. W. H. Dall discusses 'The Morphology of the Hinge Teeth of Bivalves,' calling attention to the work of Bernard and Steinmann and giving preference to the formula devised by the latter for indicating the arrangement of the teeth and sockets. Harris H. Wilder describes 'The Pharyngo-Esophageal Lung of *Desmognathus*,' showing that this species, and inferentially other lungless salamanders, breathes mainly by means of a definitely localized portion of the anterior part of the alimentary canal. J. Arthur Harris presents some 'Notes on the Habits of *Cambarus Immunitis* Hagen,' showing that this species, like others of the genus, burrows, and implying that by this means the animals are preserved through the dry months of summer. Albert M. Reese tells of the 'Artificial Incubation of Alligator Eggs' by keeping the eggs in damp *humus* in an incubator at a temperature of 37° C. 'The Colors of Northern Apetalous Flowers' are considered by John H. Lowell, giving a table showing that the great majority are white or dull-colored, and concluding that they are of primitive character and not degraded entomophilous forms. 'The Prehistoric Workshops at Mt. Kinco, Maine,' are treated by C. C. Willoughby, who states that it is evident the products were mainly intended for transportation and to be finished at a distance.

IN the *Plant World* for February William Palmer tells of 'Deforested Cuba' and the manner in which the trees have been destroyed and the soil injured by the continued burning over of the land. Pauline Kaufman describes the 'Orchids in Central Park,' E. M. Williams

'The Masked *Tricholoma*' and Stewart H. Burnham 'A February Outing in California,' while 'The Discovery of a Plumose Variety of the Ebony *Splenwort*' is noted by Francis B. Horton. In the Supplement, 'The Families of Flowering Plants,' Charles Louis Pollard treats of various families of the order Ranales.

THE February number of the *American Geologist* contains an article by S. P. Jones on 'The Geology of the Tallulah Gorge.' The Tallulah River is a tributary of the Chattooga and finally reaches the Savannah in South Carolina. The Grand Chasm of which the paper treats is situated in the crystalline area of Georgia and surrounded by granites, gneisses and schists, supposed to be pre-Cambrian. The principal constituent of the rock is quartz, but small quantities of feldspar and mica are present. The falls are found to have been produced entirely by the river and atmospheric agencies, and it is further found that both falls and gorge are of recent age. It has been shown by certain geologists, with whom the author concurs, that this stream is an example of piracy, having been captured by the Tugaloo from the Chattahoochee river and diverted into the Savannah. In 'Paleontological Speculations,' Mr. L. P. Gratacap gives a few notions derived from an extensive study of collections among which are mentioned those of the American Museum of Natural History. These are studied for the purpose of determining the variations whose accumulated force ushers in new forms in the life series and by whose influence on the organism as a whole a kinetic impulse is established in a new direction. The deductions of Dr. Succo, Professor H. S. Williams, Professor Alpheus Hyatt and others, concerning change of environment of air, water and deep sea, are discussed. The fauna of the different ages and their phylogeny, and their development through following ages, are also discussed in an interesting manner. 'The Plan of the Earth and Its Causes,' by J. W. Gregory, follows, and is an interesting discussion of the prevalent theories of the earth's formation, and its growth to its present relations of land, water and air. The discussion is to be continued. Then follows the usual 'Recent Geological Literature,' 'Cata-

logue of Geological Literature' and 'Personal and Scientific News.'

Three new ornithological journals have appeared this year. *American Ornithology*, edited by Mr. C. A. Reed, at Worcester, Mass.; *The Petrel*, edited by Mr. J. W. Martin, at Palestine, Ore., and *The Bittern*, edited by Mr. G. M. Hathorn, at Cedar Rapids, Ia. On the other hand *The Western Ornithologist* has suspended publication.

#### SOCIETIES AND ACADEMIES.

##### THE ACADEMY OF SCIENCE OF ST. LOUIS.

At the meeting of the Academy of Science of St. Louis, of March 4, 1901, the following subjects were presented:

The Corresponding Secretary read a communication from Dr. Amos Sawyer, entitled 'Ethnographic life lines left by a prehistoric race,' the paper being illustrated by sketches, fragmentary human remains and stones, etc., derived from a prehistoric grave examined some ten miles southwest of Hillsboro, Illinois, on the west side of Shoal Creek. In one instance it was stated that a grave consisting of six slabs of limestone contained six skeletons, their thighs flexed upon the abdomen, the legs upon the thighs, their arms placed by their sides, and their heads at either end of the enclosing box and facing east and west. From the limited capacity of the slab-enclosed graves, the writer inferred that the remains had been placed in them after skeletonization, as there was not sufficient room for the number of bodies found unless the muscles had been removed, and it was argued from this that the remains were those of prominent men in the nation.

The Corresponding Secretary read a further communication from Dr. Sawyer, referring to a piece of wood found at a depth of 400 feet below the surface in sinking a shaft for a coal mine. The specimen was said to have occurred in a ten-foot layer of loam filled with the débris of a forest, and the specimen submitted, like others, had been flattened by pressure.

In the discussion which followed the reading of these communications, Mr. Colton Russell said that west of St. Louis, in a number of so-called Indian graves which he had examined,

the encasing with rough limestone slabs, mentioned by Dr. Sawyer, had been observed; and Dr. Trelease called attention to the fact that the specimen of wood exhibited, which did not seem to be petrified, belonged to post-glacial times and was perhaps comparable with certain pieces of wood, supposed to be cedar, but not yet carefully studied, which Mr. Hermann, the Sewer Commissioner of St. Louis, had found in company with bones of the early bison in the glacial detritus through which a storm sewer is being excavated at Tower Grove, St. Louis.

A paper by Dr. T. Kodis, 'On the action of the constant current upon animal tissue,' was read by title.

Professor F. E. Nipher stated that he wished to take this occasion to correct some misapprehensions concerning the development of photographic positives. He stated that the effect of development in the light was to make the normal exposure for positives shorter than when they are developed in the dark-room. When for a given illumination of the developing room the exposure has been properly made, the ordinary developer used for negatives may also be used for positives without any restrainer. The restrainer is only needed when the plate to be developed as a positive has been underexposed, or the plate to be developed as a negative has been overexposed. In both cases it is an approach to the zero condition which calls for the restrainer.

Professor Nipher stated that Mr. Cockayne, of the Heliotype Company, of Boston, had suggested to him the use of potassium ferrocyanide in place of potassium bromide in developing positives, and he had found it to give great brilliancy to the pictures. A Cramer 'Crown' plate exposed in a printing-frame for a couple of minutes at a south window, just out of the direct rays of the sun, under a thin negative or positive, may be developed at the same place. A few drops of a ten-per-cent. solution of the ferro-cyanide may be added, and even as much as one part in twelve of developer has yielded excellent results. The bath has in some cases been wholly made up of the ferro-cyanide solution, the other chemicals being added in dry form. The action of the ferro-cyanide is quite different from that of

bromide in equal strength, although it may be largely a matter of degree.

The bath should not be quite so strongly alkaline as for negatives, in order to get the best results. The best results when pictures are developed in daylight are as fine as can be obtained in the dark room, in the ordinary developing of negatives. Various developers have been tried, but none of them have yielded as good results as hydrochinon.

Mr. G. Pauls laid before the Academy a branch of a small hackberry (*Celtis*) which had become completely covered with the small nodular galls frequently borne in smaller quantities by the hackberry, and called attention to the fact that in this particular case the natural enemies of the gall-forming creatures seemed to have been absent, allowing of their unusual multiplication.

One person was elected to active membership.

WILLIAM TRELEASE,  
*Recording Secretary.*

#### GEOLOGICAL SOCIETY OF WASHINGTON.

THE 112th meeting was held March 13, 1901, at the Cosmos Club. The following formal communications were presented:

'The Soil Survey of Cecil County, Maryland,' by Mr. C. W. Dorsey. This example of recent soil-mapping, by the Department of Agriculture, was illustrated by a colored map showing the areal distribution of ten classes of soil.

'Discussion of Geologic Units—Formation, Stage and Age,' by Messrs. Bailey Willis, H. S. Williams and others.

Mr. Willis, in introducing the discussion, briefly reviewed past attempts to consistently divide assemblages of stratigraphic rocks into units. He pointed out that a clear distinction exists between division on lithological grounds, and division on paleontological grounds, and that this distinction should not be lost sight of. He believed that the cartographic unit, the formation, should be defined purely on the basis of lithological character. In regard to the terms used for the units of the lithological, faunal and chronological scales in geology, it is highly important that there should be unanimity in usage. Shall we attempt to reconcile and fix the usage of such English substantives as series, forma-

tion, system, stage, period, etc., or shall we adopt entirely new terms from some foreign, preferably dead, language, and so avoid tying up well known English words to definite restricted meanings? Several terms from the Sanscrit were given in illustration of this suggestion. Professor H. S. Williams called attention to the fact that a formation, as defined on purely lithological grounds, lacks true unity. Two scales must be used to scientifically describe the formations and faunas which the geologist studies—a structure scale and a time scale. The latter must express definite time values. Such values are presented by (1) the persistence of equilibrium of a particular fauna, (2) the persistence of a particular species, (3) the persistence of a genus, etc. Major J. W. Powell gave his experiences in devising a scientific nomenclature in psychology. He at first endeavored to redefine old words. Readers forgot his definitions and unconsciously used their own in reading his work. He strongly favored the adoption of new terms devoid of all confusing connotations. Mr. Whitman Cross illustrated the difficulties arising when a formation, once defined, is found to thicken and expand into several members in another portion of the field. He was emphatically of the opinion that the evidence of fossils should be freely used in addition to lithological distinctions, whenever such a course will lead to a fuller expression of the structural and historical facts in the geology of a given region.

F. L. RANSOME,  
DAVID WHITE,  
*Secretaries.*

#### BIOLOGICAL SOCIETY OF WASHINGTON.

THE 337th regular meeting was held on Saturday evening, March 23d.

Sylvester D. Judd presented a paper on 'Bird Food Problems,' stating that in studying the food of birds as indicated by their stomach contents, one was confronted with the problem of identifying the articles eaten from very small particles. He showed, illustrating his remarks with lantern slides, how the presence of grasshoppers, cut worms, the larvæ of may beetles, earthworms and various plants might be recognized under the microscope from minute

but characteristic portions of these animals or, in the case of the plants, by portions of the seeds or even the form of the starch grains.

F. A. Lucas spoke of 'Some Restorations of Dinosaurs' saying that while a short time ago the Dinosaurs were very imperfectly known, now, through the exploration of our western territory and the systematic methods employed in collecting, we had a very thorough knowledge of these animals and are even able to present restorations of their external appearance. The American Museum of Natural History, of New York, he said, led in this work, and the speaker explained the methods of collecting, showing views of some of the famous quarries and of the specimens as they appeared when prepared and mounted. The matter of restoration was discussed, and the deductions made from the skeletons described and various restorations shown made by Mr. Knight under the direction of Professor Osborn.

F. A. LUCAS.

#### WASHINGTON PHILOSOPHICAL SOCIETY.

THE 532d meeting was held March 16, 1901. The first paper was by Professor Updegraff, of the Naval Observatory, on the 'Errors due to Imperfections on the Pivots of a Theodolite.' After a reference to the well-known theory of elliptical pivots in a V-bearing whose sides are at right angles, the speaker considered the case of an elliptical pivot resting on two cylindrical lugs or ridges; the result of the investigations is that the center of the pivot when rotated does not change its elevation, but has a small movement in azimuth. In the long discussion that followed, Mr. E. G. Fischer, mechanician of the Coast and Geodetic Survey, pointed out that in actual practice the unequal wear of different parts of a pivot, due to unavoidable inequalities in the steel and to use of only a small arc, introduced much greater errors than any due to the original imperfections of manufacture.

Mr. Hussey then gave (by invitation) 'An Informal Account of Recent Work at the Lick Observatory,' showing superb lantern slides of stellar spectra and nebula. The interesting facts which he presented have been made accessible to the public in other ways and need not be repeated here.

C. K. WEAD,  
Secretary.

#### TORREY BOTANICAL CLUB.

THE meeting of January 30, 1901, was held at the Botanical Academy, Bronx Park, New York City.

A paper was presented by E. S. Burgess on the history of *Aster Claytoni*, soon to appear in print. A series of specimens was exhibited showing type and variations, and a range from the Hudson River to Virginia. The first specimen known was collected in the mountains of Virginia by John Clayton, apparently in or before 1754, during his botanical expedition along the James or that to the sources of the Rappahannock. It is No. 767 of the Gronovian herbarium preserved by the British Museum. Comparisons, kindly made by Mr. Edmund G. Baker, of the British Museum, show its identity with plants observed first on Manhattan Island at Inwood by E. S. Burgess in 1896, and kept under observation since for study of development. The description of No. 767, written by Clayton and Gronovius, and published in the 'Flora Virginica,' Part III, in 1762, without a specific name, long remained without reference to any of our known native species, Forster's reference in 1771 to *Aster macrophyllus* proving untenable. In reestablishing the species in the 'Illustrated Flora,' in 1898, under the name *Aster Claytoni*, it was intended to pay this tardy tribute to the memory of its discoverer, John Clayton, rightly styled by Collinson as at that period, 1764, 'the greatest botanist of America.' The species seems particularly frequent in the lower Hudson region, where it had, however, been hitherto confused with its smoother and more forking ally, *Aster divaricatus*.

At the meeting of February 13, 1901, at the College of Pharmacy, in New York City, Dr. J. K. Small presented a paper entitled, 'Notes on Some Species of *Rudbeckia*,' exhibiting a series of specimens of *Rudbeckia*, illustrating groups typified by *R. hirta*, *R. triloba*, *R. laciniata*, etc. Numerous critical characters depending on style-tips, form, serration or lobation of leaves, etc., were discussed. About 25 species occur east of the Rockies, 3 native to our own vicinity. All evidence shows *Rudbeckia hirta* to be an introduced plant in the northeastern states, perhaps from Maryland northward. Dr. Underwood remarked that *R. hirta* seemed to be first

introduced into Central New York about 1864. Dr. Rusby referred to its rarity within his memory in the vicinity of New York City, and to the recently discovered medical value of the related genus *Echinacea*. Dr. Britton called attention to the supposed variants of *R. hirta* with parti-colored rays, as suggested by plants from near Philadelphia and from Staten Island.

Dr. Britton presented the subject of the relationship of our woodland species of *Circæa*, *C. Lutetiana* being the representative near New York City, and extending widely around the world. The characteristic bristles of the fruit fail to appear in a remarkable specimen from Ohio which was exhibited. *C. intermedia* of Central Europe was also discussed in its relations to the foregoing.

The third paper, also by Dr. Britton, was upon *Antennaria*. Dr. Britton exhibited a series of specimens of *Antennaria neodioica* Greene, a species which seems to be easily distinguished from the others of eastern North America by its spatulate basal leaves, distinctly mucronate, tapering rather abruptly from well above the middle into a long narrow base, which, however, can scarcely be called a petiole. He showed specimens of the plant collected in company with Professor Greene at Bushkill, Penn., on the Club's Field Meeting, May 30, 1897, at which time Professor Greene first insisted on its specific difference from *A. plantaginifolia* with which it grew. The series included authentic specimens of *Antennaria rupicola* Fernald, which differs only from the typical specimens in the yellowish involucre, and slightly less abruptly tapering leaves, collected by Mr. Fernald at Island Falls, Aroostook Co., Maine, a character which can hardly be maintained for specific distinctness; also specimens of *A. neodioica attenuata* Fernald, which differs from the type in its slightly more acuminate inner involucre bracts and relatively broader leaves, and is identical with *A. alsinoides* Greene, original specimens of which were also included in the exhibit; also of *A. neodioica grandis* Fernald, which differs from the latter only in size. He concluded that the series represented only one species, *A. neodioica*.

Dr. Rusby referred to the similar variability of Andean species of *Gnaphalium* as seen by himself and other botanists in Bolivia.

Dr. Howe discussed the relationship of *Riccia Beyrichiana*, the hepatic which he had considered to be probably identical with one discovered by Mr. R. Harper near Athens, Georgia, last summer. The loan of the type-specimen from Vienna now shows that the two are wholly distinct, Mr. Harper's plant representing a new species, soon to be described in the *Bulletin*. *Riccia Beyrichiana* seems, therefore, to be still known only from the original collection of 1833.

EDWARD S. BURGESS,  
Secretary.

#### SCIENCE CLUB OF NORTHWESTERN UNIVERSITY.

THE last meeting of the Science Club of Northwestern University was held on March 1st. Professor A. R. Cook addressed the Club on 'Minerals of the Chicago Area.' The region, though containing no stores of precious metals, or gems, and though not mentioned in lists of mineral localities, has minerals enough; first, to represent five out of the eight classes into which the mineral kingdom may be divided; second, to illustrate the chemical, crystallographic, optical and other physical properties of minerals, and third, to show the chief methods of investigation.

Thus far forty-eight minerals have been found and studied. One fourth of them occur in the underlying Niagara limestone. They are of such character as the geological history of the region would lead us to expect.

Those occurring in the Niagara are most important since they most properly represent this region. They are sulfur, galena, sphalerite, pyrite, marcasite, quartz, limonite, calcite, dolomite, siderite, melanterite, petroleum, gas, asphalt.

The sulfur occurs in crumbling rounded masses in the center of the decomposing marcasite. Galena and sphalerite are in crystalline masses with occasional crystal planes developed, showing characteristic cleavage, and contained both in limestone and in quartz.

Pyrite is most common when the containing limestone most nearly approaches the purity of calcite. The surprising condition is the great abundance of the orthorhombic form of the iron sulfid. Pyrite is rare but marcasite occurs in

extensive beds where it has been sorted out by hydraulic action as in the Des Plaines valley or on the lake shore. A bed several feet wide extended along the water's edge for two hundred feet where the lake was encroaching upon the shore. The marcasite soon disappears upon exposure; it is of such occurrence in the region as to contribute to our knowledge of the species.

Quartz occurs in abundance in both phanero-crystalline and crypto-crystalline varieties. Good scalenohedrons of calcite are found at Stony Island imbedded in asphalt.

The asphalt and maltha which are usually disseminated through the Niagara limestone of the region occur quite pure in cavities formed by the dissolution of fossil coelenterates, echinoderms and mollusks in the strata at Stony Island.

The average of four analyses showed 15% mineral matter, 82% organic matter soluble in  $CS_2$ , and 2% of organic non-bituminous matter.

The asphalt contains 25% petrolene and 75% asphaltine.

HORACE M. SNYDER,  
*Secretary.*

#### DISCUSSION AND CORRESPONDENCE.

##### THE APPLICATION OF PRECEDENCE OF PLACE IN NOMENCLATURE.

It has occasionally happened in descriptive botany and zoology that two or more different names have been published by an author for the same species in the same work, even on the same printed page; in most such cases this has occurred by reason of the author regarding differing forms of the same organism as specifically different, which by subsequent observation has proved to be erroneous. The principle of now using the first in position of these two or more names as the true one, has obtained wide recognition, and is a simple and convenient method to reach this result.

There are also a few cases where the same thing has occurred with generic names, that is to say, by different generic names being published in the same work for groups of species which subsequent study has indicated to be more satisfactorily regarded as within the natural limitations of a single genus, and here precedence of place has also been invoked to

determine which appellation the combined genera should bear. Here, as in the case of species, it is only a question of determining which of one or more names for the same things is the one to be employed.

The principle has been referred to as 'priority of place,' and perhaps not improperly, but it is quite a different matter from priority in time of publication, though in its application operating in the same manner to determine which of two or more rival names is to be used. It finds its most explicit presentation in the rules for nomenclature adopted by the botanists of the American Association for the Advancement of Science, at the Madison meeting in 1893, where it is thus stated:

In determining the name of a genus or species to which two or more names have been given by an author in the same volume or on the same page of a volume, precedence shall decide.

More recently it has been proposed by some botanists, as had previously been done by some zoologists, to fix the type species of every genus originally published with more than one species, by selecting for this the species which stands first on the page at the place of publication, and it has been contended that this is a logical outcome of the principle, thus giving it a widely different application from that contemplated in the rule cited above, by making it apply not to the determination of equivalent names for the same thing but to non-equivalent names for different things, a wholly different proposition. Inasmuch as a great many genera have at their first publication been made to include more than one species, and in a large number of instances some of these, often the first in position, have been used by subsequent authors as the types of additional genera, this latter-day proposition affects an enormously greater number of cases than those which fall properly under the operation of the rule.

It is, therefore, clear that there is nothing logical in the proposed extension of the principle. This would, of course, operate as an artificial short-cut in determining generic types, except in the cases where the first species named is not definitely understood, but in many instances it would lose the historic type

altogether, and in others it would render useless for nomenclatural purposes much original investigation through which genera have been definitely established. Unless rigidly restricted in such a way as to avoid these defects it would be impracticable and undesirable.

N. L. BRITTON.

CLAYTON'S ECLIPSE CYCLONE AND THE DIURNAL CYCLONES.

MR. H. H. CLAYTON, of the Blue Hill Meteorological Observatory, Mass., has published an account of his discussion of certain meteorological observations made during the eclipse of May 28, 1900, in the *Proceedings of the American Academy of Arts and Sciences*, Vol. XXXVI., No. 16, January, 1901; and the full report in Vol. XLIII., Part 1, of the *Ann. Har. Coll. Obs'y*, 1901. Mr. R. DeC. Ward reviews these papers in *SCIENCE* of March 1, 1901, and says, "Clayton has gone far ahead of all previous investigations of the phenomena of eclipse meteorology. The low temperature, the circulation of winds and the form of the pressure curve all proclaim the development by the eclipse of a *cold-air* cyclone, as described by Ferrel; \* \* \* The fall of temperature due to the occurrence of night must also produce, or tend to produce, a cold-air cyclone. Since the heat of day produces, or tends to produce, a warm-air cyclone; \* \* \* These causes must, in the opinion of the author, produce entirely, or in part, the well-known double diurnal period in air pressure; \* \* \* His explanation of the diurnal variation of the barometer seems to have in it many evidences of being the best yet offered to account for this puzzling phenomenon."

I suspect that Mr. Clayton and Mr. Ward have an incorrect conception of Ferrel's cold-center cyclone, or else they could hardly have written about it the remarks contained in these papers. The subject is rather complex, but I hope, very briefly, to indicate the leading discrepancies for the benefit of others who think that the problem of the diurnal variation of the barometer can be solved along these lines.

1. *Some Minor Errors.*—Clayton's Formula, page 8,  $\tan \theta = \frac{\sum (\sin \alpha) v}{\sum (\cos \alpha) v}$  should be written

$\tan \theta = \frac{\sum v \cdot \sin \alpha}{\sum v \cdot \cos \alpha}$ , where  $\alpha$  is the azimuth of the observed wind, and  $\theta$  that of the mean or prevailing wind; but this function between  $\theta$  and  $\alpha$  is incomplete and it often gives an incorrect result. In the diagram the wrong diagonal is drawn, and this introduces confusion into the exposition of the formulæ for determining  $C$ , used in  $\theta^1 = \theta \pm 180 \pm C$ , where  $\theta^1$  is the azimuth of the eclipse wind which is required. As the eclipse wind for Washington, Ga., Wadesboro, N. C., and Blue Hill were computed by these formulæ, the results must be imperfect. The observations were themselves not very satisfactory, as is inferred from the account of them.

2. *The Cold-Center Cyclone.*—Ferrel's account of the cold-center cyclone is found in the Report of the U. S. Coast Survey, 1877, Appendix No. 20, page 187; in the Report of the Chief Signal Officer, 1885, Appendix 71, page 257; and in other places. Also there are some general remarks on the subject in the International Cloud Report, 1898-99, page 615. The accompanying diagrams show the circulation in the warm-center and cold-center cyclones, respectively, and the distributions of pressure characteristic of them; these must serve for further explanations in this place. In order that there may be no doubt about Ferrel's idea of the cold-center cyclone, I quote from the Report of the Chief Signal Officer, page 257, "The gyrations at the earth's surface must be in the same direction as in the case of ordinary cyclones; \* \* \* The interchanging motion is from the center below and toward it above." Report of Coast Survey, page 188, "The maximum barometric pressure is where the gyrations are reversed; \* \* \* The pressure is a minimum at the center and a maximum at the edge" of the cold-center cyclone, at all altitudes, meaning by edge the locus where the gyrations reverse direction.

Ferrel illustrates the cold-center cyclone in these two reports, also in his popular treatise on the winds, pages 246-247, 337-342, by comparing it with the general circulation over a hemisphere of the earth, where the poles are cold and the tropics warm, and states that the circulation is the same in each. That is, the air descends at the pole, flows south and east

(not west) to latitude  $30^\circ$ , thence south and *west* (not east) to the equator, in which region it as-

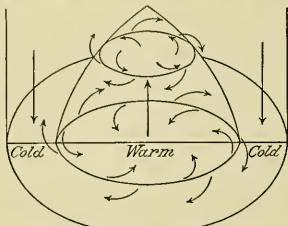

*Circulation in warm Center Cyclone*

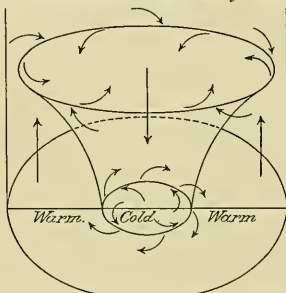

*Circulation in cold Center Cyclone*

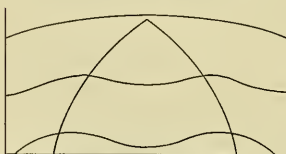

*Isobars in warm Center Cyclone*



*Isobars in cold Center Cyclone.*

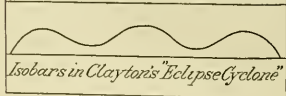

*Isobars in Clayton's "Eclipse Cyclone"*

cends, etc. Thus, page 337, "This vertical circulation, as in the case of the ordinary cyclone, gives rise to a cyclonic motion in the interior (that is, to the place where the gyration reverses from  $+v$  to  $-v$ ) and an anti-cyclonic in the exterior part." Cyclonic rotation is against the hands of a watch, looking down upon it, and anticyclonic is with the hands, so that in warm and in cold-center cyclones the rotation is cyclonic near the center, and anticyclonic beyond a certain circle of reversal. In the warm-center cyclone the motion is ascending and inward near the surface in the interior and descending in the exterior; in the cold-center cyclone these motions are reversed, but the *direction of rotation about the pole is not changed*. Ferrel's formulæ, diagrams, and discussions agree in this throughout his works; indeed, there could be no other interpretation of them on mechanical principles. He says, C. S. O., page 203, "Such areas of high barometer (referring to the high pressure area produced by the overlapping of two adjacent cyclones) are usually called anticyclones, and the air does in some manner move around them in a direction contrary to that of a cyclone, but this does not arise from a central area of greater cold, for it has been shown that such a condition would give rise to a cyclone and not to an anticyclone, and that the latter would be entirely at variance with fundamental and well established principles of mechanics."

When the temperature gradients are very steep and there is much friction on the surface, a small secondary maximum pressure may develop in the center of the cold-center cyclone. In the case of the eclipse the temperature gradients were feeble, and the wind velocity  $v$  small, upon which the friction-force  $= k.v$  depends, so that it could not happen under the circumstances of the eclipse phenomenon.

Now by comparing Clayton's diagram, Fig. 5, Plate II., for the wind direction, we find a *true anticyclonic* configuration at the center, and this rotates in the opposite direction to that required in the cold-center cyclone; if wind stream lines were to be drawn from the center outward at *right angles* to those contained in the Clayton diagram, we should then obtain a cold-center cyclonic circulation,



but this is just the opposite of the result of the eclipse observations. Furthermore, Plate III., 'Pressure in Eclipses,' shows us the variations in pressure as observed, and these are reproduced in the lowest section of the adjacent diagram. It is seen that the pressure in the eclipse is *reversed throughout its length to that required in the cold-center cyclone*. The Weather Bureau observations at sixty-five stations confirm the Clayton distribution of pressure, but the conclusion is also unavoidable that we are not dealing with a cold-center cyclonic circulation. My further remarks on this subject will be found in the forthcoming report by the Weather Bureau.

3. *The Semidiurnal Cyclones*.—Even if the analogue between the eclipse circulation and that assumed to exist in the nocturnal circulation were not hopelessly in error, there are yet other difficulties to be considered, even supposing the cooled hemisphere of the atmosphere were to produce something like a cold-center cyclone and the heated hemisphere a warm-center cyclone. (a) The vertical circulation in the cold-center and in the warm-center cyclones are in *opposite directions* to one another at the belt of highest pressure, so that they would tend to destroy each other, rather than build up any high pressure belt such as the diurnal pressures require. (b) If there is a cyclonic circulation of any kind, the conditions demand that the pressure be distributed quite symmetrically on all sides of the center in order to maintain a true gyratory motion; but in the diurnal barometric pressure there are found to be simply two peculiar waves extending from pole to pole, which do not in the least form such a symmetrically distributed pressure about a center. Compare Int'l Cloud Report, Chart 44. (c) According to Clayton, Plate IV., the high pressures at the surface shift about 90° in the higher strata. But so far as I know, the only data bearing upon this point are contained in the Blue Hill hourly cloud observations, and these show that the *same diurnal circulation* exists in the atmosphere from the surface to the cirrus level. However, this may be a doubtful point and I will not press its accuracy. Compare Int'l Cloud Report, Chart 45.

I have generally found myself in accord with

Mr. Clayton's published results, and I am sorry to be obliged to dissent from his interpretation of the eclipse observations in this case. The variations of pressure in the eclipse are not larger than 0.01 inch of mercury, and the velocity of the eclipse wind is only 2 or 3 miles; but it would seem hardly credible in the face of these facts that this small atmospheric disturbance should set up any true cyclonic circulation over an area 5,000 miles in extent, as is claimed in the report under consideration.

FRANK H. BIGELOW.

WASHINGTON, D. C., March 20, 1901.

#### THE REVERSAL OF THE PHOTOGRAPHIC IMAGE BY CONTINUED ACTION OF LIGHT.

THE remarkable results described by Professor Francis E. Nipher, in developing photographic plates in daylight, bring to mind some of the earlier experiments upon the reversal of the photographic image. It has long been known that under particular conditions of over-exposure in the camera a positive, instead of a negative, is produced by ordinary development. This result has been repeatedly observed by amateurs, much to their astonishment and mystification.

The present writer has several times attempted to bring about the effect by prolonged exposure in the camera, but without success. The necessary conditions not being known, the result is accidental and uncertain. The idea of giving a supplementary exposure of the plate in broad daylight did not suggest itself; indeed, it is not one that would spontaneously commend itself to a photographer. All his previous training and experience is opposed to it on general principles.

Nevertheless, it is not entirely new. Herschell, in the year 1839 or 1840, did very much the same thing. He observed reversals of photographic action, and so did Draper on strips of sensitized paper with which he was studying the chemical action of the sun's light in Virginia, and photographing the spectrum in ephemeral colors. This subject was referred to quite recently in an article by the present writer, entitled, 'Titbionic Rays and Early

Photographs in Color,' published in the *International Annual of Anthony's Photographic Bulletin*, XIII. (1901), 107. At that time and also many years later, the effects observed were attributed to an antagonistic action between light radiations from different parts of the solar spectrum.

Many years ago, when collodion wet plates were mostly in vogue, there was considerable discussion among photographers of the effect of exposing sensitized plates to diffused daylight, either before, during or after the usual exposure in the camera. Some claimed that such a supplementary exposure made the plates more sensitive, so that the camera time was materially shortened. The admission of a little diffused light through a hole in the camera was claimed to be advantageous in the same way. Others questioned the utility of the practice and the question was finally dropped and forgotten.

There may have been a basis of truth in the contention of those who advocated the supplementary exposure, but it was not satisfactorily established at the time. There is less reason for skepticism now than there was in those days. Although not exactly in line with Professor Nipher's work, the subject bears a close relation to it.

More directly connected with the recent observations is the work of M. J. Jansen, at Meudon, in the year 1880, when he was engaged in studying the solar radiations. In his original communication to the French Academy, published in *Comptes Rendus* of that year, he used the following language descriptive of his work: "I have the honor to inform the Academy of the discovery of a fact to which I have been led by my studies in the analysis of the light of the sun and of its photographic images.

"This fact consists in this, that the photographic images may be reversed, and pass from negative to positive by the prolonged action of the light which has produced them."

Ordinarily the exposures for negatives were about one-thousandth of a second, or when bromide plates were used, one ten-thousandth. But when the exposures were prolonged to half a second or a full second—increased 10,000 or

20,000 times—he obtained a positive picture instead of a negative.

The investigations were continued and in a second communication to the Academy, also published in *Comptes Rendus* (Vol. XCI.), he made known some remarkable results.

By varying the times of exposure he found an intermediate condition of the plate at which neither a positive nor a negative could be developed. His conclusions may be briefly summarized here. With exposures of increasing duration he discovered six different successive conditions of the sensitive plate. These developed in order as follows:

1. A negative. The ordinary negative.
2. A first neutral condition which blackened uniformly in the developer.
3. A positive.
4. A second neutral condition, opposed to the first, which became uniformly lighter in the developer.
5. A second negative, similar to the first but differing by the enormous amount of light required to produce it.
6. A third neutral condition, in which the negative of the second order had disappeared and was replaced by a sombre, uniform tint.

These facts were established with different kinds of plates—tannin plates, gelatin-bromide and others.

It is scarcely necessary to indicate the bearing of these observations on the results of Professor Nipher's experiments. Does not the fourth condition suggest that if a plate in that stage were developed in a lighted room it would show a negative picture?

About the time of these observations of Jansen, considerable attention was being directed to the subject of reversals of the photographic image; but most of the literature deals with theories in explanation of the facts. Although the discussion was sufficiently instructive and interesting, it does not seem to me that we are sufficiently acquainted with the chemical effects of light in photography to warrant much chemical theorizing in this particular field.

ROMYN HITCHCOCK.

NEW YORK, March 18, 1901.

## SHORTER ARTICLES.

A NEW OCCURRENCE OF CASSITERITE IN  
ALASKA.\*

DURING the past season while making a hasty reconnaissance of the York gold field of Alaska, my attention was called to some auriferous gravels which carry a large percentage of stream tin. This stream tin is found in considerable quantities on Buhner Creek, which enters the Anakovik River from the west about three miles from Behring Sea. The occurrence is perhaps best located by stating that it lies some ten miles east of Cape Prince of Wales and hence very near the northwestern extremity of the continent. On Buhner Creek some two to three feet of gravel overlies the bed rock which consists of arenaceous schists which are often graphitic, together with some graphitic slates. The bed rock is much jointed, the schists being broken up into pencil-shaped fragments. They strike nearly at right angles to the course of the stream and offer natural riffles for the concentration of heavier material. A hasty reconnaissance of the drainage basin of this stream, which includes not more than a square mile of area, showed the same series of rocks throughout its extent. At a few localities some deeply weathered dark green intrusives were found, which, on examination by the microscope, were found to consist almost entirely of secondary minerals. In some cases, however, a little plagioclase was still unaltered and a suggestion of ophitic structure remained, so that these are probably of a diabase character. The slates and schists are everywhere penetrated by small veins consisting usually of quartz with some calcite and frequently carrying pyrite and sometimes gold. These veins are very irregular, often widening out to form blebs and again contracting so as not to be easily traceable.

The stream tin is concentrated on the bed rock with other heavy minerals and was found by the miners in the sluice boxes. A sample of the concentrate in one of the sluice boxes was examined by Mr. Arthur J. Collier and yielded the following minerals: cassiterite, magnetite, ilmenite, limonite, pyrite, fluorite, garnets and

\* Published by permission of the Director of the U. S. Geological Survey.

gold. The determination of percentage by weight was as follows: ninety-five per cent. tin-stone, five per cent. magnetite; other minerals five per cent. The cassiterite occurs in grains and pebbles, from those microscopic in size to those half an inch in diameter; they have sub-rounded and rounded forms. In some cases there is a suggestion of pyramidal and prismatic crystal forms. The cassiterite varies from a light brown color to a lustrous black.

A local locality of this mineral was found on the Anakovik River half a mile below the mouth of Buhner Creek. Here the cassiterite is also found with the concentrates from the sluice boxes of miners. I observed one specimen from this locality which was some two inches in diameter.

During the hasty reconnaissance no acid intrusives nor pegmatite veins were found in the drainage basin. The nearest known granitic rocks are in the biotite granite mass which forms the promontory of the Cape Prince of Wales. It is hoped during the coming season that more detailed work in this region will throw further light on these interesting deposits.

ALFRED H. BROOKS.

NOTES ON PARASITES—56: ECHINOSTOMUM  
BURSICOLA LOOSS AND E. CLOACINUM  
BRAUN, FROM A NOMENCLATURE  
STANDPOINT.

PROFESSOR MAX BRAUN\* has recently proposed the name *Echinostomum cloacinum* as a substitute for *Distomum bursicola* Creplin, upon placing this species in the genus *Echinostoma*. Braun's reason for changing the specific name is that there is already an *Echinostomum bursicola* Looss, 1899, and he assumes that this invalidates the specific name *bursicola* Creplin, 1837.

In this decision, Braun has fallen into error. It is not *bursicola* 1899 which invalidates *bursicola* 1837, but the latter invalidates the former. Hence *E. cloacinum* Braun, 1901, must fall as a

\* 1901.—Ueber einige Trematoden der Creplinschen Helminthensammlung. Cent. f. Bakt. Paras. u. Infek., XXIX., 1 Abt., No. 6, Feb. 25, 258-260.

synonym of *Echinostoma bursicola* (Creplin, 1837) nec Looss, 1899.

In order to straighten out the synonymy immediately, I here propose the name *Echinostoma africanum*, nomen novum, as substitute for *E. bursicola* Looss, 1899, nec (Creplin, 1837) Stiles, 1901.

CH. WARDELL STILES.

BUREAU OF ANIMAL INDUSTRY.

AMATEURISM AND MENTAL INERTIA IN  
PUBLIC SERVICE.

IN a striking presentation of the results of 'Official Obstruction of Electric Progress' in Great Britain, by Professor J. A. Fleming, in *The Nineteenth Century* for February, that distinguished writer and scientific authority describes the outcome of the existing system of public service in Great Britain in the departments of telegraphy and telephony and the relative retrogression of that nation in all departments of electrical engineering. "In reviewing the nationality of those who have thus helped to make the electric current the humble servant of mankind, it is impossible not to be struck with the fact that British names do not preponderate."

In pure scientific research, Great Britain has held her own; in detailed improvements and minor advances she has not been backward; but has made no fundamental invention or discovery, except, perhaps, those 'of Lord Kelvin in submarine telegraphy, of Mr. Swan in electric lighting and of Professor Hughes in telephony'; practically all first-rate novelties have originated in other countries, for a generation past. The reason is attributed largely to the fact that in 1870, just at the dawn of the period of electrical activity, the Government set itself up in business as an electrician and proceeded to create a gigantic Government monopoly in one large department of electrical invention which has exercised a most undoubted control over the supply and demand for invention in a wide area of electrical work. It invested £10,000,000 in telegraph purchases, made the business a monopoly, and thus smothered invention through that monopoly and an always characteristic governmental inertia, an inertia, misnamed conservatism, always to be

observed where, as in such cases, the alertness in effecting improvement and in competition which characterizes private business for private profit is absent. This 'conservatism' is seen in all departments of the public service and is liable to produce serious retrogression in every national enterprise and in all countries. It was also illustrated, according to Professor Fleming, in the case of the telephone. No sooner was this extraordinary invention made practicable than the British Government, even without explicit authority of law, compelled its proprietors and promoters in that country to pay tribute to the Postal Department, and to-day, while the postal service and the telephone are conducted at a loss, the telephone is made to contribute, without substantial return to its proprietors, the amount of £130,000 to the profit side of the postal service ledger; while the official service of the telegraph, too largely amateur, brings in a loss of over £220,000. The National Telephone Co. has paid into the treasury of the postal service over a million of pounds, since its capitulation to that service, as a 'tax on a new industry barely twenty years old.' The higher tribunals have never confirmed this act of piracy, as it is considered by the members of the company.

As this writer states: "The whole behavior of the post-office towards private enterprise in telephony in the last twenty years has been marked by inconsistency, inaptitude and want of prevision." The business which it itself conducts is a source of enormous loss; that which it simply taxes and burdens pays a sufficient profit to bear this invidious taxation, to which other industries are not subjected. It is a fair presumption that, were the telephone managed directly by the Government, it would exhibit a lack of thrift and efficiency similar to that characterizing the postal and the telegraph business. Meanwhile, also, the postal service deliberately impedes the telephone management in its endeavors to secure rights of way, and compels it to charge the public a much higher tariff than would be fair and practicable were it not discriminated against in taxation, and thus its range is restricted as well as its value to those who are able to secure its service. In all ways the hope of reward which is the

great stimulus of the inventor and of the promoter of new improvements is repressed. The conclusion of the writer of the paper referred to is: "The most effective method of afflicting any department of applied science with creeping paralysis is to constitute it a government monopoly."

While the State electricians would probably declare that they are 'ever on the outlook for new things,' the record is shown to invalidate that claim, at least to the extent of showing that the new things have come vastly more certainly and promptly to the private management. Inventions have been extensively exploited by private means and private companies far in advance of any governmental action, and the inventor proverbially dreads the necessity of going with his plans to a governmental department in all countries and whatever his field of work. Even the inventor of the apparatus of war has his bitter experiences with the official, and the history of the work of Maxim and of Broadwell still earlier, among our own great inventors, may be added to the examples quoted by Fleming, of Morse, of Trowbridge, of Marconi and others. Government officials do not always cordially and sincerely strike hands with the inventor, even where competent to appreciate his work, and it is too often the fact that they prefer to hold him at arm's length until one of their own caste or a partner in invention can find ways of evading his claims and of reaping the harvest he has sown.

"The State officials guard a monopoly. It is in their power to take or reject improvements. They set the pace in one large department of electrical invention and it cannot be forced." As Mr. Edison said to Professor Fleming when the latter explained the nature of these governmental impediments of progress in electrical development: 'Why! They've throttled it!'

In electric traction the same difficulties are interposed, in appropriate ways, by the official brakemen. Great Britain has to-day about 400 miles of track; the United States has 12,000 or more. In that country any local government may take away the property of any tramway within its limits, at the appraised value of its real property, after twenty years of service. This provision of law has crippled the enter-

prise. 'To tell an investor in tramway stocks that, after passing through a long non dividend-paying period, he has then the prospect of having his property taken from him at a breaking-up price, and perhaps half his property confiscated,' is to warn him not to invest. Thus the business languishes and the builder of even the comparatively promising railways about London must come to the United States for all his material and machinery.

Scientific education is looked upon as one element of the needed radical reform. But "What is required is not abundant mediocrity, but a fully sufficient opportunity of training those who will be 'captains of industry. The persons who need technical education are the masters much more than the men.'"

Throughout the whole article, of which we have here presented so extended an abstract, the evidence is strong that the dangers of that amateurism and of that officialism which are now beginning to awaken intelligent men, and especially men of science and men of applied science in the United States, to serious apprehension relative to all public services involving scientific work or development, have secured a firm and dangerous hold in Great Britain and constitute undoubtedly one of the elements of that apparent relative retrogression in the industries which has of late attracted so much attention and awakened such earnest discussion in the scientific and technical journals, and even to some degree in the columns of the 'Thunderer' itself. The republication, by the Harpers,\* of letters to *The Times* from a British engineer visiting the United States, furnishes and preserves an interesting and instructive commentary upon these facts.

R. H. THURSTON.

#### MUSEUM METHODS ABROAD.

THE appearance of the eleventh annual report of the Museums Association, of Great Britain, reminds one that it is as nearly as possible eleven years ago that the Association of American Naturalists decided that so far as museums were concerned nothing remained for \* 'American Engineering Competition.' New York and London, Harper and Brothers. 1901. 8vo. Pp. 139.

it to do. The present report consists of xxiv + 157 pages, a trifle larger than the average of the reports, and besides the matter pertaining solely to the workings of the Association, comprises the address of the president, Dr. Henry Woodward, twelve papers, general notes, museum reports and a list of museum publications. Dr. Woodward's address is practically a brief review of the relations of the British Museum to the public and what it has done in the way of the arrangement and display of specimens to interest and instruct visitors, particular attention naturally being given to the display of paleontological material. Dr. Woodward has come to the same conclusion as that expressed by the writer some years ago in SCIENCE, that the complete mixture of recent and fossil animals in the exhibition series is inadvisable and the best results are to be obtained by introducing a few carefully selected and typical examples of living animals into the series of fossils, and rounding out the display of recent animals by the introduction into the exhibition series of a few fossils. "This limited introduction of existing forms, aided by diagrams, drawings and separate parts, does not break up the arrangement of the collection (of fossils) as a whole, but vastly enhances its usefulness to the student."

The aims and arrangement of various museums are described in more or less detail in several papers, including the Hastings Museum, Worcester, by W. Edwards; the Horniman Museum, London, by Richard Quick, and the Norwich Castle Museum, by Henry Woodward.

W. M. Flinders Petrie discusses the question of a 'National Repository for Science and Art,' advocating the acquisition of about a square mile of land within an hour of Loudon (the scheme naturally applies to all large collections) on which should be built a series of one-storied galleries lighted from above; these galleries to be 54 feet wide and about 400 feet apart. The object to be attained by this method is to provide ample room, at a moderate cost, for the housing of material which would be at once preserved and available for study, museums in large cities whose cost of maintenance is high being largely devoted to exhibition.

F. A. Bather described a series of 'Exhibition

Labels for Blastoidea,' specially intended for the student who goes to a museum with a definite purpose of acquiring information regarding fossil crinoids. Incidentally we are given a suggestion for a dichotomous arrangement of a museum. The text of the 44 labels is given and they practically amount to a condensed text-hook with the specimens serving as illustrations. No one will deny the value of such a system to the student, but would an entire museum thus planned and labeled appeal to the general public, for which, after all, the exhibition portion of a museum is intended?

The 'Reproduction of Art Objects' is treated by Robert F. Martin, who notes that Venetian glass, old majolica, bookbindings, bronzes and even tapestries are now successfully duplicated, so that art museums may by the use of these reproductions fill gaps in historical series for a comparatively small price, where originals would either cost large sums, or be quite unobtainable.

J. W. Carr explained the use of 'Photography in Museum Work' for illustrating features which could not be adequately represented by specimens alone. Among such he instanced various geological phenomena; the habits and habitat of animals; forest trees and the general features of the landscape caused by differences in the flora.

At the business meeting of the association the question of publishing a monthly journal devoted to museum matters was the subject of a 'Report from the Council,' and while the project was not then definitely settled, it has since been decided to publish such a periodical. The details have not as yet been made public.

F. A. L.

#### THE SCIENTIFIC ALLIANCE OF NEW YORK.

RENEWED efforts are being made to secure an adequate building for the societies composing the Scientific Alliance of New York. Mr. J. Pierpont Morgan has made a conditional subscription of \$25,000, and several smaller amounts have been subscribed. A Committee of Cooperation with the Council of the Alliance has been formed consisting of Andrew H. Green, *Chairman*, 214 Broadway, Edward D. Adams, Abram S. Hewitt, W. E. Dodge, John S. Kennedy, Andrew Carnegie, F. W. Defoe, J. Hamp-

den Robb, D. Willis James, Sam'l Sloan and John J. McCook. This committee has issued the following appeal :

The Council of the Scientific Alliance of New York, composed of delegates from the New York Academy of Sciences, the Torrey Botanical Club, the New York Microscopical Society, the Linnæan Society of New York, the New York Mineralogical Club, the New York Section of the American Chemical Society and the New York Entomological Society, is endeavoring to obtain by subscription a fund for the erection of a building for the use of these societies and others joining the Alliance.

The building is needed as a common meeting-place for the societies, which now occupy rooms in various parts of the city, for the housing of their libraries, which are now widely scattered, for a large lecture hall, for laboratories and other rooms for scientific research, and as a central point of influence upon the community.

The scientific societies are about the only agencies of modern culture for which permanent homes have not been provided in the Metropolis. In this respect New York is strangely behind many smaller cities in the United States, and suffers still more in comparison with the great cities of Europe, most of which have creditable buildings devoted to the use of such organizations. As much original scientific research is carried on in the city of New York as in any other city of the United States, and only public encouragement and support of its already very efficient societies are needed to make New York the scientific center of the country.

The Council of the Scientific Alliance has been incorporated by a special act of Legislature, with power to acquire real estate and to receive bequests. It holds as a nucleus for the present undertaking the sum of \$10,000, contributed by Mrs. Esther Herrman, and a number of smaller subscriptions. It is estimated that land can be purchased and a suitable building erected and equipped for the sum of \$500,000, which it is the aim of the Alliance to raise.

The undersigned Committee of Cooperation with the Council commend the undertaking and urge all public-spirited citizens to unite with them in the endeavor to bring it to a speedy realization. Subscriptions will be received by the chairman of the Committee or by any member of the Council.

#### MEMBERSHIP IN THE NATIONAL ACADEMY OF SCIENCES.

IN view of the fact that the National Academy of Sciences is about to hold its annual

meeting at which new members are elected, it may be of interest to give the members of the Academy who have died and who have been elected during the past ten years.

<i>Deaths.</i>	<i>Elections.</i>
	1891.
Julius E. Hilgard, John Le Conte, Joseph Leidy, Miers F. Longstreth.	None.
	1892.
T. Sterry Hunt, Joseph Lovering, J. S. Newberry, Lewis M. Rutherford, William P. Trowbridge, Serenio Watson.	Carl Barus, S. F. Emmons, M. Carey Lea.
	1893.
W. H. C. Bartlett, F. A. Genth.	None.
	1894.
Charles E. Brown-Sequard, Josiah P. Cooke.	None.
	1895.
James D. Dana, John Newton, James E. Oliver.	W. L. Elkin, C. S. Sargent, W. H. Welch, C. O. Whitman.
	1896.
Thomas L. Casey, G. Brown Goode, Benjamin A. Gould, H. A. Newton.	C. D. Walcott, R. S. Woodward.
	1897.
E. D. Cope, M. Carey Lea, A. M. Mayer, J. H. Trumbull, F. A. Walker, Theodore Lyman.	W. H. Dall, F. A. Gooch, C. S. Minot, E. W. Morley,
	1898.
James Hall, William A. Rogers.	None.
	1899.
O. C. Marsh.	Charles E. Beecher, Geo. C. Comstock, Theodore W. Richards, Edgar F. Smith, Edmund B. Wilson.
	1900.
James E. Keeler, Fairman Rogers.	Franz Boas, James E. Keeler, H. F. Osborn, Samuel L. Penfield.

## SCIENTIFIC NOTES AND NEWS.

THE National Academy of Sciences will hold its stated annual meeting at Washington on April 16th, 17th and 18th.

THE spring meeting of the Council of the American Association for the Advancement of Science will be held in the Assembly Hall of the Cosmos Club, Washington, on Wednesday, April 17th, at 4.30 p. m.

DR. GEORGE DAVIDSON, professor of geography in the University of California, has been elected a correspondent of the Paris Academy of Sciences.

PROFESSOR F. G. HESSE, who holds the chair of mechanical engineering in the University of California, was offered a banquet at San Francisco on March 29th to celebrate his twenty-five years of service in the University of California. About 150 of his friends and former students were present and speeches were made by Professor Joseph Le Conte and others.

A PORTRAIT of Dr. W. W. Keen, professor of surgery in the Jefferson Medical College, Philadelphia, has been presented to the institution by his colleagues and students. Dr. Keen, as we have already noticed, has been granted a long leave of absence for travel abroad.

THE fiftieth anniversary of Dr. Abraham Jacobi's doctorate was celebrated at the New York Academy of Medicine on April 3d. Dr. Jacobi was introduced by Dr. R. F. Weir, the president of the Academy, and read a paper on 'German Medical Text-books of Half a Century Ago.'

PROFESSOR J. MARK BALDWIN, of Princeton University, has sailed for Europe to supervise the publication of the second volume of the 'Dictionary of Philosophy and Psychology,' which is printed by the Oxford press, and to arrange for the translation of the work into foreign languages. It is expected that the first volume will be published in a week or two.

DR. J. A. BERGSTRÖM, associate professor of psychology and pedagogy in the University of Indiana, has been given leave of absence in order that he may study the school systems in Germany and Sweden.

PROFESSOR GEORGE FREDERICK WRIGHT was

given a reception on April 4th, by the students of Oberlin College, on the occasion of his return from his geological trip round the world.

E. R. CUMINGS, of the department of geology of the University of Indiana, has been given leave of absence in order to carry on his studies at the Johns Hopkins University.

MR. CHARLES P. STEINMETZ has been nominated by the Council of the American Institute of Electrical Engineers for president. In the ballot of members Mr. Steinmetz received seventy-six votes, Mr. L. B. Stillwell sixty five and Professor M. I. Papiu forty-four. The Institute will hold a conversazione at Columbia University on April 12th.

M. FAYE has been appointed president of the Council of the Paris Observatory for the present year.

M. SABATIER, of Toulouse, has been elected a correspondent in the section of chemistry at the Paris Academy of Sciences.

THE Midland Railway Company, of Great Britain, is sending two engineers, Messrs. Seeley and Woollinscroft, to the United States to study American railway methods, including the use of electricity.

MR. VAUGHAN CORNISH has returned, as we learn from the *London Times*, from an expedition in search of snow waves in Quebec, Manitoba, the Northwest Territories and British Columbia. These waves were found to be well developed on frozen rivers and lakes and on the open prairie, where photographs and measurements were taken. They are produced without the intervention of any obstruction, and sometimes occur in groups or trains of waves comprising 100 succeeding ridges. Their movement is sufficiently rapid to be readily visible. In certain conditions of the snow true ripples are also formed, which are similar to the ripples produced by wind in loose, dry sand. In both ripples and waves the steeper face is on the lee side. In moist or coherent snow, such as usually falls in England, the wind carves the surface into ridges, which have their steep face on the windward side.

MR. WILLIAM KENT, of New York City, author of 'Kent's Mechanical Engineers' Note



Book' and of 'Steam Boiler Practice,' also associate editor of the *Engineering News*, is to deliver a series of six lectures before the senior students in engineering of Purdue University, Lafayette, Ind. The lectures of Mr. Kent will extend through the week beginning April 15th and will close a long series of lectures delivered at Purdue by outside engineers.

THE death is announced of Audubon Wheelock Ridgway, assistant in the Department of Ornithology of the Field Columbian Museum, Chicago. He was born in Washington in 1877, and was the only son of the eminent ornithologist, Dr. Robert Ridgway.

THE death is also announced, at Berlin, of Dr. Schlichter, the African traveler and geographer.

DR. C. R. ALLEN, vice-president of the Torrey Botanical Club, has presented the New York Botanical Gardens with his valuable collection of stoneworts.

THE *Astronomical Journal* states that the following grants from the Gould Fund have recently been made: to Mr. John A. Parkhurst, \$30; to Dr. Herman S. Davis, \$500; to Mr. Paul S. Yendell, \$225; to Professor Simon Newcomb, \$25. A considerable additional amount of income has accrued, for the distribution of which applications are awaited. These applications may be made by letter to any of the directors, stating the amount desired, the nature of the proposed investigation, and the manner in which the money is to be expended. The directors, desiring to stimulate the participation of American astronomers in the attempt to bring up the arrears of cometary research, offer to them the sum of \$500 for computation of the 'definitive' orbits of comets; this sum to be distributed at the average rate of \$100 for each computation—the amount to vary according to the relative difficulty of the computation, and to be determined by the directors of the Gould Fund. Computers should promptly notify the directors of their participation or desire to participate, and manuscripts should be submitted not later than July 1, 1902.

It is stated in *Popular Astronomy* that Dr. Lewis Swift has disposed of his astronomical equipment to the Pasadena and Mount Lowe

Railway. The instruments are to remain on Echo Mountain, and Professor E. L. Larkin is now director of the observatory.

DR. PATRICK GEDDES, who was responsible for the formation of the International Association for the Advancement of Science, Arts and Education, and the holding of an International Assembly at the Paris Exposition last year, proposes a similar assembly, in connection with the exposition and congresses to be held at Glasgow this year.

THE Zoological Society of London has arranged the following lectures to be held after the general meetings on Thursdays, April 18th, May 16th, June 20th and July 18th:

'On the Protection and Nourishment of young Fishes': Professor C. STEWART, LL.D., F.R.S.

'Biological Stations at Home and Abroad.' With lantern illustrations: Professor W. A. HERDMAN, F.R.S.

'Mimicry.' With lantern illustrations: Professor E. B. POULTON, F.R.S., F.Z.S.

'Rhinoceroses, Recent and Extinct.' Mr. F. E. BEDDARD, F.R.S., F.Z.S.

THE laboratory of the U. S. Fish Commission for the study of marine biology, at Beaufort, N. C., will re-open for work on the first of May, and will remain open through September. The laboratory is open to those wishing to carry on botanical or physiological work, as well as to those engaged in zoological investigations. The usual histological apparatus and reagents are provided, and the collecting outfit includes a steam launch with dredge and trawl. The more commonly used journals will be kept on file. There is no charge for tables. Applicants for tables should address Hon. Geo. M. Bowers, U. S. Commissioner of Fish and Fisheries, Washington, or Professor H. V. Wilson, University of North Carolina, Chapel Hill, N. C. Inquiries as to climate, accommodations, etc., should be addressed to the latter.

THE ship built for the use of the German Arctic Expedition was launched at Kiel on April 1st, in the presence of a distinguished company. The vessel has been named *Gauss* in honor of the great mathematician.

THE census of France was taken on March 24th. The results are looked forward to with

special interest, owing to the small increase in the population in recent years. In the census taken five years ago the population of France was 38,517,975.

THE Navy Department for some time has been giving attention to the subject of wireless telegraphy, with a view of ascertaining how far it can be practically applied to the naval service, and Secretary Long has appointed a special board of officers to make a thorough inquiry on the subject. The board consists of Captain Chadwick, Lieutenant Powellson and Lieutenant Commander Hodgson. The meeting of these officers will take place at Newport, and it is expected that their conclusions will determine to what extent the wireless system can be utilized for the Navy.

IN order to make the free distribution of seeds by the U. S. Department of Agriculture as useful as possible, Secretary Wilson has secured authority to send out young trees as well as seeds.

THE Senate of Minnesota has passed Senator Chilton's bill prohibiting the marriage of insane, epileptic and idiotic persons, and requiring a medical certificate of all applicants for marriage licenses.

THE American Social Science Association will hold its general annual meeting at Washington, beginning on Monday evening, April 15th, and continuing four days.

#### UNIVERSITY AND EDUCATIONAL NEWS.

It is said that the litigation over the Lamson estate, bequeathed several years ago to Yale University, has ceased and the University will at once receive about \$450,000. Of this sum \$150,000 is to be used for an auditorium and the balance for the endowment of professorships in Greek, Latin and English.

It has been announced that the donor of the \$200,000 to the University of Pennsylvania for a new physical laboratory is Mr. Randolph Morgan, of Philadelphia, one of the trustees. The laboratory will be known as the Morgan Laboratory of Physics.

THE senate of Cambridge University has ac-

cepted a tender for the erection of the new botany schools at a cost of over \$100,000.

THE trustees of Harvard University have purchased about 400 acres of land near Centre Harbor, on Squam Lake, in New Hampshire, to be used as a camp where surveying will be taught during the summer months.

A ROYAL commission is to be appointed to enquire into the question of university education in Ireland.

THE Committee of Fifteen, appointed by the National Council of Education in 1898, to consider and report upon the question of a national university at Washington, will hold a meeting to formulate its final report, at Columbian University, Washington, on Thursday, May 23d, and following days. It will be remembered that the preliminary report of the Committee was adverse to the establishment of a national university, in the usual use in which the word 'university' is used; but it has in contemplation the development of a plan to make systematic use of the resources of the Government at Washington for research and investigation by university students.

THE courses in medicine for women, in connection with the University of St. Petersburg, have been closed indefinitely, owing to the recent riots in that city.

DR. G. A. MILLER, instructor in mathematics in Cornell University during the past four years, has just accepted an assistant professorship in the Leland Stanford, Jr., University, and will leave for his new field of work soon after the close of the Cornell Summer School in which he takes part. Readers of SCIENCE will recall that only a few months ago, Dr. Miller was awarded the prize offered by the Royal Academy of Sciences of Cracow for the solution of a question in groups, this competition being open to the world.

DR. C. N. McALLISTER, assistant in the Yale psychological laboratory, has been appointed lecturer in experimental pedagogy at Yale University.

THE Trustees of Ohio State University have elected John A. Bownocker professor of inorganic geology and Charles S. Prosser professor of geology and head of the department.

# SCIENCE

A WEEKLY JOURNAL DEVOTED TO THE ADVANCEMENT OF SCIENCE, PUBLISHING THE OFFICIAL NOTICES AND PROCEEDINGS OF THE AMERICAN ASSOCIATION FOR THE ADVANCEMENT OF SCIENCE.

EDITORIAL COMMITTEE: S. NEWCOMB, Mathematics; R. S. WOODWARD, Mechanics; E. C. PICKERING, Astronomy; T. C. MENDENHALL, Physics; R. H. THURSTON, Engineering; IRA REMSEN, Chemistry; JOSEPH LE CONTE, Geology; W. M. DAVIS, Physiography; HENRY F. OSBORN, Paleontology; W. K. BROOKS, C. HART MERRIAM, Zoology; S. H. SCUDDER, Entomology; C. E. BESSEY, N. L. BRITTON, Botany; C. S. MINOT, Embryology, Histology; H. P. BOWDITCH, Physiology; J. S. BILLINGS, Hygiene; WILLIAM H. WELCH, Pathology; J. MCKEEN CATTELL, Psychology; J. W. POWELL, Anthropology.

FRIDAY, APRIL 19, 1901.

THE MORPHOLOGICAL MUSEUM AS AN EDUCATIONAL FACTOR IN THE UNIVERSITY SYSTEM.\*

## CONTENTS:

<i>The Morphological Museum as an Educational Factor in the University System:</i> PROFESSOR GEO. S. HUNTINGTON.....	601
<i>Suggestions for an Attempt to Secure a Standard College Entrance Option in Botany:</i> PROFESSOR W. F. GANONG.....	611
<i>The Michigan Academy of Science:</i> DR. H. S. JENNINGS.....	616
<i>Scientific Books:—</i>	
<i>André's Traité d'Astronomie stellaire:</i> PROFESSOR EDWIN B. FROST. <i>Barracteugh on the Steam-engine Problem:</i> PROFESSOR R. H. THURSTON. <i>Gregory's Catalogue of Fossil Bryozoa:</i> J. M. N. THORNDIKE's <i>Human Nature Club:</i> J. J. Books Received.....	618
<i>Scientific Journals and Articles.....</i>	622
<i>Societies and Academies:—</i>	
<i>New York Academy of Sciences, Section of Biology:</i> DR. HENRY E. CRAMPTON. <i>Section of Astronomy, Physics and Chemistry:</i> DR. F. L. TUFTS. <i>Onondaga Academy of Sciences:</i> PHILIP F. SCHNEIDER. <i>The Academy of Science of St. Louis:</i> PROFESSOR WILLIAM TRELEASE	623
<i>Discussion and Correspondence:—</i>	
<i>Resignations from the School of Pedagogy of New York University:</i> PROFESSORS SAMUEL WEIR, EDWARD F. BUCHNER, CHARLES H. JUDD. <i>The Proper Name of the Alpine Chough:</i> DR. P. S. SCLATER.....	626
<i>Notes on Inorganic Chemistry:—</i>	
<i>Atomic Weight Standard; Action of Alcohol upon Metals:</i> J. L. H.....	627
<i>Current Notes on Physiography:—</i>	
<i>The Illinois Glacial Lobe; The Albany Mountains; Reversion in River Development:</i> PROFESSOR W. M. DAVIS.....	628
<i>Current Notes on Meteorology:—</i>	
<i>Quarterly Journal of the Royal Meteorological Society; The Old Yuma Trail; Hann's Lehrbuch der Meteorologie; Notes:</i> R. DEC. WARD.....	629
<i>Science and Industrial Competition:</i> PROFESSOR R. H. THURSTON.....	631
<i>The Malaria Expedition to Nigeria.....</i>	632
<i>Conciliium Bibliographicum.....</i>	633
<i>Scientific Notes and News.....</i>	634
<i>University and Educational News.....</i>	640

THE educational value of the modern morphological museum has of late years received such general recognition that we may well regard its position as established in the university system. Not only do the departments of undergraduate instruction draw more and more extensively upon this portion of the university equipment for the illustration of courses and demonstrations, but the museum itself has assumed its proper relation to independent scientific research and to the investigation of biological problems. It has seemed to me desirable to present to this association—whose members are so largely both teachers of anatomy and investigators of the science—some account of the progress made during the last decade in museum work in the department of vertebrate morphology. More especially does it appear proper at this time to note the present stage of development of the modern anatomical museum, because we have, I think, reached a period at which we can look back over a series of busy years and gauge correctly the value of the results obtained, as well as forecast the probable future development of this work. Ten or fifteen years ago the morphological

\* Address of the President before the Association of American Anatomists at the Fourteenth Session, held at Baltimore, Md., Dec. 27–28, 1900.

museum—established on lines of modern thought and research—existed in an embryonic form in only a few of our institutions of learning. From this period date a number of excellent monographs—in which the authors outline the plans of a proposed anatomical museum designed to meet the requirements demanded by the advance of the biological sciences—from the standpoint both of the teacher and the investigator. Prominent among these interesting publications are the following :

‘Outlines for a Museum of Anatomy. Prepared for the Bureau of Education,’ by R. W. Shufeldt. 1885.

‘Die Aufgaben der anatomischen Institute,’ by Professor A. Koellicker, 1884. An address delivered at the opening of the new anatomical institute in Würzburg on November 3, 1883.

‘The Educational Museums of Vertebrates,’ an address before the Section of Biology of the American Association for the Advancement of Science, at Ann Arbor, August, 1885, by Professor B. G. Wilder.

‘The Synthetic Museum of Comparative Anatomy as the Basis for a Comprehensive System of Research,’ by John A. Ryder, Professor of Comparative Embryology at the University of Pennsylvania, Philadelphia. 1893.

As I look over the list of these and other contributions to the literature of the anatomical museum I am tempted to characterize the period between 1885 and 1895 as the prophetic era, foreshadowing the establishment and recognition of the most essential and valuable aid to scientific anatomical instruction and research which our universities to-day possess. When we analyze the great and radical changes which our methods of morphological teaching have experienced since that time, we shall, I believe, agree that the demonstrative and objective instruction which has replaced so largely the old didactic

lecture is intimately and organically connected with the evolution of the modern anatomical museum. It will perhaps best serve the purpose of my communication if in the following I confine myself to the facts as they are most familiar to me in the case of my own university, which, I believe, may fairly be taken as a concrete example of the general progress which has marked the period in question in the scientific institutes throughout our country.

The establishment of a museum of vertebrate comparative anatomy, on lines designed to illustrate and demonstrate to the fullest extent possible the morphological truths embodied in the doctrines of evolution, heredity and descent is an undertaking requiring years of careful and successful work before even a satisfactory beginning is made. The foundation of the museum at Columbia University was laid in 1889, and, while in many directions our progress has been rapid and the results gratifying, yet we feel that to-day but the outlines exist along which future growth is to take place.

#### I. PLAN AND SCOPE OF THE MUSEUM AND ITS RELATION TO ANATOMICAL INSTRUCTION.

I may in the first place call your attention to the general plan and purpose of the museum, in accordance with which the objects have been collected and prepared, and to the relation existing between the museum and the undergraduate instruction in anatomy.

The following considerations present themselves :

1. The fundamental plan of the museum includes in the first place a general exposition of the vertebrate classes, whose purpose is to present the cardinal points in the anatomical structure of the great vertebrate classes and subclasses.

Each vertebrate class, subclass and order

is represented by one or more typical forms in preparations illustrating as fully as possible the skeletal and locomotory apparatus, the circulatory and nervous systems, and the alimentary, respiratory and uro-genital tracts.

This display forms the guiding thread to the study of the individual forms—in respect to typical structures, *i. e.*, the fundamental anatomical characters of the mammal, bird, reptile, amphibian and fish are grouped together to afford a comprehensive view of the entire organism, from which starting point the detailed investigation of characteristic structures in their various modifications is to be followed through the series of species belonging to the *same class*.

To illustrate: the typical structure of the avian pectoral girdle is represented in the collection by the girdle of *Palamedea cornuta*, the horned screamer. It is here shown to contain three elements, the scapula, coracoid and furcula.

Turning to the corresponding series demonstrating the successive modifications of this structure, we find it as a link in the group devoted to the development of the vertebrate shoulder girdle. The various modifications in shape, extent and sternal attachment of the complete furcula are first illustrated, together with preparations of the membranous and ligamentous structures, which have a bearing on the general morphology of the episternal apparatus.

In the next place the avian girdle is found to pass from the type represented by *Palamedea*, in which all three skeletal elements are fully developed, to the intermediate condition seen in the toucan, where the furcula is developed as a bilateral structure, the two segments not fusing over the sternum, until we come to the brevipennate group of birds, of which *Dromæus* still has rudimentary anterior collar bones, whereas in *Struthio*, *Rhea* and *Casuaris* these

have lost their identity by becoming fused with the scapula.

In the second place this division of the museum affords the basis for broad comparison between the organizations of the different vertebrate classes. For example, the comparison of the entire anatomical system of a typical reptile, bird and mammal will show why reptiles and birds, although differing widely in structural detail, yet have sufficient general morphological characters in common, as against the mammal, to entitle them to be grouped under the single broad head of the Sauropsida.

Then again, this portion of the museum is designed to elucidate the important problems of derivation of vertebrate sub-classes.

2. The second main division of the museum deals with the development, evolution and comparative structure of single organs and systems. The homologies in the different classes, and the modifications of the typical structures in each class, are here demonstrated as completely as possible. In many respects this portion of the work is educationally the most important. We draw most extensively upon it for our anatomical undergraduate instruction in the elucidation of problems in human morphology. I cannot take time in even superficially outlining the detailed development of this division of the anatomical museum. The enumeration of a few of the principal series must suffice.

I may instance the series dealing with the morphology of the alimentary tract, and especially the group devoted to the structure of the ileo-colic junction, cæcum, vermiform appendix and the allied segments of the large intestine. This series, including at present over 600 preparations, and beginning with type forms illustrating this portion of the alimentary canal in fishes, amphibia, reptiles and birds, passes to a complete demonstration of the structures in mammals, terminating with several speci-

mens of the four anthropoid apes and leading up to the detailed study of the human cæcum and appendix, the numerous variations of which are all represented by one or more type specimens. In the same way the various forms of the stomach and the modifications of small and large intestine constitute a series of great morphological interest.

Other series deal with the vertebrate respiratory apparatus, especial stress being laid on the clear demonstration of the development, evolution and structure of the mammalian lung. Closely connected with this group is the serial exhibit dealing with the heart and circulatory system. Other series include the nervous system, the genito-urinary tract, the pelvic and pectoral girdles, the mammalian temporal, periotic and tympanic bone, etc.

Special attention is given in this department of the museum to the demonstration of human anatomy. Eventually it is hoped that every portion of man's structure will be fully and exhaustively illustrated by perfect preparations. The museum should afford the medical student the opportunity of directly verifying his text-book information and should be a most valuable guide and aid to the practical anatomical study of the individual in the dissecting room. Moreover, many structures, as we all realize, are never fully examined or completely demonstrable to the student in the dissecting room. Aside from the individual differences in the cadaver in respect to development and state of preservation, and in the element of alteration of structure by diseased conditions, certain parts require special methods of preparation, such as the auditory apparatus; others necessitate for their exposition the sacrifice of surrounding structures to a degree not warranted by the practical requirement of getting the greatest amount of detail from the dissection of a single cadaver. More-

over, even the structures, which are ordinarily fully examined and demonstrated in the dissecting room on the fresh subject, can be shown with great profit in the museum in various preparations by different methods. For example, the museum contains hardened situs preparations, organs hardened, distended and fenestrated, injection and corrosion preparations, etc., to illustrate fully the anatomical structure of each part and to enable the student to extend and amplify his observations on the cadaver.

Again, in connection with this department of the museum, I find it of distinct advantage to establish small comparative series designed to illustrate the development and normal anatomy, as well as the more important variations, of certain adult human conditions. These groups are accompanied by tablets, describing as fully as necessary the purpose of the exhibit, and drawings which emphasize the points at issue.

Thus, for example, under the heading of the cardinal sinus of the adult human heart—as part of the series exhibiting cardiac anatomy—the following group is placed with full explanatory text:

1. Heart and vascular system of *Raja ocellata*—various preparations to show embryonic type of mammalian heart before septal division, ducts of Cuvier and symmetrical cardinal veins.

2. Heart of *Python molurus*—hardened and distended, with sections showing: (a) sinus venosus of right auricle; (b) valves of sinus venosus and their relation to the Eustachian and Thebesian valves of the mammalian heart; (c) pulmonary veins; (d) persistent left precava.

3. Heart of *Struthio africanus*—injected, showing persistent avian left precava—with its relations to pericardium and coronary vein.

4. Ruminant heart (*Antelope cervicapra*)—mammalian type of normal persistence of left precava.

5. Series of normal human hearts—showing, in various preparations, coronary sinus, Thebesian and Eustachian valves—both fetal and adult.

6. Series of well-developed folds of Marshall in fetal and adult hearts.

7. As soon as obtained the final member of this group will be added as a preparation showing the normal persistence of the left precava in the adult human subject.

Instances in which a similar limited and selected group of preparations may be with advantage established for the elucidation of special details in human anatomy could be almost indefinitely multiplied.

I have noted at random :

1. Development of axis and atlas.
2. Ligaments and tendons of shoulder joint.
3. Greater and lesser sciatic ligaments and relation to hamstring muscles and coccygeus.
4. Postcava and variations.
5. Carpus and tarsus.
6. Sacrum and vertebral variations.
7. Aortic arch and variations of primary branches.
8. Various myological problems.
9. The peritoneum.

The question as to the practical application of this educational material to the requirements of undergraduate instruction in anatomy deserves careful consideration from several points of view :

1. Primarily the museum should afford a consecutive and logical serial exhibition, arranged and administered in such a manner that for both undergraduates and advanced students the preparations should be readily accessible and capable of being examined with only such restrictions as the safety of the object demands. The museum should be the reference library of the student in the widest sense, where the undergraduate can review and extend

his anatomical knowledge on the hand of the actual object of his study, and where the advanced worker will find the necessary material in directing and supplementing his research in any given problem under investigation.

2. In the demonstrative teaching of the anatomical course the material of the museum in our experience can best be utilized in two ways :

*a.* It is our custom, in approaching any one of the large subdivisions of the course—such as the respiratory and circulatory system, the alimentary canal or genito-urinary tract—to devote a portion of the available time to a preliminary general consideration of the development, peculiarities of morphological structure and the physiological significance of the parts involved. For this purpose a judicious selection of a limited number of the museum preparations is made, and the objects are arranged in the form of a series, each number of which distinctly and forcibly illustrates a developmental stage or a significant and important structure or functional fact. It is necessary to limit the preparations thus selected in number to avoid confusion and superfluous expenditure of time, but it is surprising how clearly and convincingly the main broad lines of vertebrate development and evolution and the relation between structure and function can be brought out in a comparatively short series of selected preparations. Every teacher knows and appreciates the difference in the quality of instruction and its results between a demonstration of models and drawings, schematic or otherwise, and one referring directly to the natural object. The most important function of the museum, as an integral part of the educational system of the university, is exerted in supplying the material necessary for this kind of demonstrative teaching. Practically I find in the schematic blackboard sketch or the more carefully

prepared colored chart a most valuable adjunct. The drawing should, however, be made directly from the actual preparation demonstrated and the student should have the opportunity of directly comparing both. In this way salient points can be accentuated and the attention properly and immediately directed to the important facts which the preparation is designed to illustrate.

*b.* In connection with the class-room demonstration it is at times desirable to deal with general problems of vertebrate morphology from the higher standpoint which, on the hand of a more extensive series, affords a wider view of the structures concerned. I find that this can best be accomplished by a photographic lantern slide demonstration, in which a very considerable number of forms can be exhibited to the class in a comparatively short time. It has been our practice to photograph the preparations when finished, but before they are permanently mounted or included in the museum series. As a practical matter the best results are obtained by vertical exposure, the object being placed in suitable trays and covered by clear fluid—water or alcohol. In this way the disadvantage, resulting from the distortion and reflection of the jar containing the specimen when finally mounted, is obviated.

The resulting photograph forms part of the museum record and is useful in many ways. Properly labeled, it forms an excellent guide to the study of the preparation and it can be used directly for reproduction in publications or be made the basis of the drawing. Finally, as the completion of the series warrants it, the negatives yield a set of lantern slides which can be used in the teaching of the department as well as in extending the use of the museum material in other institutions.

3. The special courses in comparative anatomy and embryology, which are offered as optionals, electives, or for the higher uni-

versity degrees, make demands which the museum should meet as fully as possible. In the first place, I find that the forms which can readily be obtained in numbers, and supplied to the students for their actual personal use in the laboratory courses, require in many cases comparison with allied types which, by reason of their rarity and value, can only be represented in the permanent collection of the museum. The courses can thus be extended and made infinitely more valuable and instructive. Again, every practical laboratory teacher will know the value of placing before the student a carefully and clearly executed preparation and reviewing the structures which he is to expose and determine for himself by the dissection of the fresh material on hand. This use of the museum is entirely apart from the valuable and instructive deductions which a series of significant variations of normal structures will enable the student to make.

Moreover, in many respects the museum fulfills one of its most important practical functions in enabling the teacher to direct the student's attention, at the proper points in any laboratory course, to the corresponding structures and their modifications in selected preparations ranging throughout the entire vertebrate series. The broad and general application of the knowledge gained by the detailed study of any individual form can only by these means be impressed on the student, and it is thus that the anatomical museum accomplishes one of the main purposes of morphological study.

## II. RELATION OF THE MUSEUM TO ORIGINAL RESEARCH AND ADVANCED STUDY.

Of equal importance with the value of the museum for undergraduate instruction is its influence in promoting original investigation and advanced morphological study. Its very existence carries this with it. It constantly opens up, in creating the



nucleus around which the institution is to grow, lines of investigation and research which ultimately return their products to the museum as permanent records of the work accomplished, and thus prove sources of continual and valuable additions.

The museum in itself forms the basis for a progressive extension of morphological investigation. It accomplishes this in several directions. In the first place, the generalization of the structures presented by different types, which marks the central purpose of the institution, forms a circle from whose circumference at any point the line of a new and more extended investigation can be drawn. In fact, if the museum is to grow and develop according to its original intent, it is requisite that such enlargement should take place.

As the museum grows the vital questions of derivation and ancestry of forms must be investigated on the hand of constantly increasing material, which will open up points of view heretofore unattained. With each new accession to any group the capacity of the museum for extension of original thought and investigation increases. Any research opens at some point in its course side lines which may be of the utmost value. It is here that the immediate possibility of serial comparisons on a large scale afforded by the museum becomes of the greatest importance. The museum represents in its complete condition a morphological reference depository. It functions in connection with the morphological library, but it possesses the inestimable advantage of presenting the actual objects instead of plates and descriptions, often at variance with each other, incorrect and incomplete in detail and failing to elucidate just the question which it is desired to solve.

In this sense the museum fulfills its highest functions, stimulating and directly promoting investigation and rendering

such investigation fruitful and effective by contributing the series necessary for comparison and reference.

It may hardly be necessary to touch on the effect of this work on those who are engaged in it. It attracts men whom the university is glad to number among its students and graduates, and who in other institutions—as teachers and investigators—will reflect credit on their training. If from among the growing numbers of our medical students even a few are made to develop into scientific workers, I should yet hold those few—in their prospective value to the university and to science—as balancing the long list of medical graduates whom we annually send out at our commencement.

### III. RELATION OF THE MUSEUM TO OTHER DEPARTMENTS OF THE UNIVERSITY.

There is scarcely a department of biological or medical instruction and investigation which is not in intimate relation with some portion of morphology, and which will not benefit by a connection with the museum and by access to its collections.

In physiology, the science dealing with the function of the machine which itself is the object of the study in morphology, the connection is obvious. But the tremendous advantage which will accrue to each of these sciences by closer mutual association, through the link of the comparative anatomical museum, can scarcely be estimated. Morphology offers in the series of modifications which different forms present in their structure, a field of nearly unlimited choice for the interpretation of the physiologist. The physiological study of an organ in a certain form—as the dog—may lead the investigator to certain results which apply in the first plan to the species examined. If now the morphology of the organ is accessible to the physiological investigator not only in a complete series of

the dog's own order, the Carnivora, but through the entire mammalian class, and beyond this limit, so as to include the homologous structures, in other vertebrate classes, the result of the investigation becomes potentially amplified to a corresponding degree. The investigator can not only reason from analogy as to the results of similar experiments extended as far as deemed advisable through the vertebrate classes and orders, but he can also, guided by the morphology of the structure under consideration, select types which, from their anatomical configuration, promise unequivocal confirmation and extension of the results yielded by the first experiment. How frequently the success of an investigation depends on details of anatomical structure every physiologist will attest. It is often the question of the length of an arterial vessel without branches, or the arrangement of a duct, or the combination of several peripheral nerves. The museum of comparative morphology converts a haphazard search for a suitable form into one which will select the most desirable type with certainty.

In turn the generalized view of organized structure obtained in the comprehensive system of the museum will afford to the morphologist the aid which is to be found in the broad physiological interpretation of the modifications exhibited. Thus these two fundamental departments will be brought into closer contact with each other, a contact which cannot fail to redound equally to the benefit of both. I believe that a closer association of anatomy and physiology, such as is afforded by the link of the museum, is of very distinct advantage in undergraduate instruction. The modern development of science inevitably leads to a high degree of specialization, which naturally becomes apparent in the teaching of any department. The general advantage of this is obvious, provided touch is not lost

with cognate branches. The morphological museum preserves this vital connection between anatomy and physiology more than any other single factor in the university equipment. Moreover, the museum has important relations to the practical departments of medical teaching and to pathology. Nearly all important advances, especially in departments such as diseases of the eye and ear, the diseases of women, surgery in general and in its specialized branches, depend primarily on some morphological question for their inception, rendering this or that proposed operative interference proper and advantageous, or interdicting it.

A museum which offers to the medical specialist not only the normal and variant human structures which constitute his field of work, but which enables him at the same time to examine the homologous parts of other vertebrates for the purpose of gaining clearer insight into obscure morphological conditions and the origin of aberrant formations, will certainly be an aid to practical advance which can be obtained by no other means. It is needless to point out further connections of a similar character, or to more than touch upon the line along which pathology and embryology meet, a line which is sufficiently extensive, but obscure because the assistance which vertebrate embryology can afford to the pathologist is only rarely attainable in the form which the museum proposes to offer, viz., complete sets of serial preparations. As the museum develops it is proposed to take successively certain portions of the subject, such as eye, ear, larynx, brain, genito-urinary tract, etc., and to develop these as fully as possible, demonstrating the results in the form of an exhibition to a selected number of scientific men who are directly interested in the matter as expert specialists. The importance of this feature of the museum work will thus be brought more

particularly to the attention of those best able to judge of its value and to profit by the same. I have no doubt that from this class of men valuable work in investigation will be secured.

IV. UTILIZATION FOR THE PURPOSES OF THE MUSEUM OF THE MATERIAL OBTAINED FROM THE DISSECTING ROOM, AND REFERENCE COLLECTION IN OSTEOLOGY.

The question has at times been discussed whether the morphological museum should take its place in the university system as part of the departments of general biology and zoology, or as an integral division of the department of anatomy in the medical school. I am unhesitatingly of the latter opinion. Aside from the obvious relation to undergraduate medical instruction which I have attempted to outline above, the mere fact that man, the highest vertebrate of the series, forms the object of study in the medical curriculum, assigns to the morphological museum its logical place in the university system. The human material necessary for the completion of the museum series is to be obtained from the supply of the medical school. The typical preparations are, of course, from specially selected subjects set apart for the purpose. Besides this, however, one of the important functions of the museum is to supervise the records of the dissecting room, to collect and arrange the statistical information afforded by the constantly repeated examination of the human body, to acquire for its own purposes the preparations which either illustrate normal structures unusually well or demonstrate important and significant variations. Part of this material is capable of direct incorporation in the museum series after removal from the cadaver and proper preparation. For other objects the method of plastic reproduction by means of casts is invaluable. This applies especially to the

great group of myological variations. Not only are the objects bulky and not well adapted for preservation as moist specimens, but casts actually better serve the purposes of the museum in exhibition and instruction. In the comparative myological series, with which human muscular variations are necessarily brought into intimate relation, the method of plastic reproduction is an essential. The full utilization of rare and valuable animals requires this method because superficial structures must be removed before the deeper parts can be reached. As the superficial muscles are exposed casts of the different regions are taken in various positions. In the same way, by casting the deeper layers as they are successively reached, permanent records of the greatest value for myological study and reference are attained. The casts, together with the notes and drawings of the dissection, form a complete and readily accessible record far exceeding in value and accuracy any other method of illustration. Again, for example, in dealing with the development and modifications of the extremities in the vertebrate classes, each group is accompanied by casts of the entire hand and foot, forming, together with the preparations of the soft parts, muscles and ligaments and the skeleton of the extremities, a complete series. For purposes of instruction this method has proved itself very valuable. Thus a carefully prepared and hardened liver showing the natural surfaces and impressions, which are ordinarily lost in the organ removed from the body before hardening, and which are hence not ordinarily recognized, has been cast and reproductions prepared in sufficient numbers to allow one to each student for personal examination during the demonstration of the organ to the class. This plan, when extended as purposed by the museum, will vastly add to the effect and value of our demonstrative teaching.

The development of the facilities for plastic reproduction of morphological objects enables the museum to enter into connection with other institutions for purposes of exchange and scientific intercourse.

In connection with the utilization of the human material for the museum I desire to mention briefly the Reference Collection in Osteology, as part of the plan of offering opportunities for extensive morphological and anthropological research. This collection includes:

1. The disarticulated skeletons of vertebrate animals.

These are kept in boxes, arranged like the books of a library, accurately catalogued and indexed, so that any desired skeleton can be immediately found and used. The collection is placed in the osteological laboratory. It is proposed to make the collection thoroughly representative, and to include sufficient individual specimens of each form to avoid erroneous deductions possibly based on unusual variations.

2. The department includes, in the second place, a reference collection of human bones, on a scale which renders possible a thorough comparative study in reference to racial character, variations, reversions, age and sex differentiations, etc. The collection is now approaching the limit which we originally designed for it, viz., 5,000 specimens of each of the bones of the human body, but will be extended beyond this point. I am gratified that this material has afforded one of our members, Dr. A. Hrdlicka, opportunity for some very interesting researches, some of which have already been presented to this association, while his more recent results are to come before us at this meeting. The value of the collection is greatly increased by our system of record-keeping, which makes the material available for anthropological study in the widest sense. We ob-

tain now, from the hospital records, the necessary data as to parentage, age, birth-place, etc., of each subject delivered at the college. These data are entered upon the record under a running number, which follows each bone on a lead tag through all stages of maceration and preparation until it is turned into the reference collection as finished. Consequently this collection does not represent merely a catacomb of human bones indiscriminately packed together, but each bone, with its origin and history clearly indicated, becomes a member of a series available for scientific comparative work.

The same system is applied to all variations of the soft parts obtained from the dissecting room, and the variation collection of the general museum becomes in a like manner the means of promoting scientific inquiry into the causes and conditions at present operative in human evolution.

#### V. DEPARTMENTAL LIBRARY.

I may merely mention that a good working morphological library, containing the standard works and the more important current periodicals, forms part of the accessory equipment of the museum.

#### VI. LABELING AND CATALOGUE.

In conclusion I may briefly refer to the method of labeling and cataloguing the collection which we have found most useful.

The catalogue is divided into the *general* and *accession catalogue*. Each specimen as received is given an *accession number*. On the card slip, corresponding to the number in the accession catalogue, are entered all the data concerning the animal, as source of supply, date of receipt, weight of body and of individual parts, presumable age, sex, method of preparation, individual peculiarities, etc., and finally a complete list of the finished preparations derived from the

animal as they are incorporated in the museum.

The general catalogue carries on each card the running number of the preparation and beneath the same the accession number of the animal from which the specimen is taken. It is thus possible, while avoiding needless repetition, to ascertain at once the details concerning any preparation by reference to the accession catalogue. The cards of the general catalogue are arranged in accordance with the serial exhibition of the museum. The running number of the general museum and the accession number appear on the label of each preparation. In addition the individual preparations carry two small disks of a bright color with a number. These are the complementary numbers of the preparation, referring it to some other group with which it is related, as well as indicating its position in its proper series. For example, the shoulder-girdle of the armadillo assumes its proper place in the series demonstrating the structure of this portion of the vertebrate skeleton, and is numbered accordingly on a green disk, so that its own place in the series is preserved, green being the color of that division of the museum which deals with the development of the pectoral and pelvic arches. If the armadillo's number in the series is 17, and an additional preparation enters the series next to it, it receives green number 17a, etc.

In addition to the green number a small red disk on the armadillo preparation carries a number which refers the preparation to its proper place in the series illustrating the general anatomy of the Edentates, red being the serial color of that division. So if it is desired to put together at once for comparison all the material contained in the museum for illustration of the Edentate type, every preparation carrying a red disk is taken out of its own series

and the resulting group, when arranged in the sequence of the red numbers, forms the logical series treating of Edentate anatomy.

This plan makes every portion of the museum easily and at once accessible, and arranges the series in such a manner that each shall prove complementary to all the others.

By varying the shape of the colored labels and the character of the numerals sufficient range is obtained to meet all requirements.

In addition—as the series develop—more extensive typewritten tablets are introduced, giving the general features of the group and indicating the purpose for which it was assembled.

Photographs and drawings of the preparations, carefully labeled, are used for indicating points of special importance, in such a manner that they can be readily identified in the actual preparation. These accessories prove of aid in the use of the museum for individual study and during informal demonstrations and conferences.

I have attempted to outline for your consideration the present status of the morphological museum and its relation to the system of the university. I am convinced that the practical value of the institution will continue to make itself more and more felt, and its general adoption and development will be one of the prominent features marking our educational and scientific progress during the next decade.

GEO. S. HUNTINGTON.

COLUMBIA UNIVERSITY.

*SUGGESTIONS FOR AN ATTEMPT TO SECURE  
A STANDARD COLLEGE ENTRANCE  
OPTION IN BOTANY.\**

THE rapid advancement of any science depends not only directly upon the re-

\* Read before the Society for Plant Morphology and Physiology at the Baltimore Meeting, December 28, 1900.

searches of specialists, but also indirectly upon a favorable public opinion. Something may be done towards forming this opinion through a wide dissemination of information as to the true aims of science, but a more efficient method consists in the proper education of the coming public while it is still in school and college. From the single point of view of the advancement of his science, therefore, and apart altogether from the question of his responsibilities towards general education, it is the duty of every scientific man to contribute according to his ability towards elementary scientific education. Particularly is it the duty of every one of us connected with educational institutions to inform ourselves upon the present status and problems of this subject, and vigorously to set forth our resultant opinions upon all fitting occasions. It follows, further, that the problems of elementary scientific education are a proper subject for the consideration of any scientific society.

In these days the sciences are making great advances in education, and they are approaching, though for the most part they are still far below, the educational level of the older subjects. Amongst the sciences botany holds at present a less prominent place than it deserves; but, under the vitalizing influence of the dynamical and realistic spirit so recently infused into the subject among us, it is advancing to a greater prominence for the near future. Just at present, in botany as in many other subjects, educational discussion hinges chiefly about the contact of school and college, that is, about college entrance requirements. From this discussion three distinct educational advances are resulting: First, wider options in entrance subjects generally; second, a greater emphasis upon the sciences; and third, a determined movement to secure greater uniformity in the requirements made by different colleges in the

same subject. With the first of these advances we are not here concerned except to express our approval. In the second we have a more direct interest, though it is not in discussion in the present paper. I take it for granted we are all agreed that science should form an integral part of the education of every individual from the kindergarten to, into and in the college, and that botany should hold among the sciences the place to which its nature entitles it. Apart, however, from the abstract merits of the case, it is a fact that some of the leading colleges of the country do now either require a science for entrance, or else will admit the sciences as options, sometimes even to the amount of one-third of their total entrance requirement. Some schools are already teaching sciences well, and under the stimulus of a wider acceptance of their results by the colleges, such teaching will unquestionably both further improve and widely spread. We cannot doubt, therefore, that the present movement is towards the general acceptance by the colleges of the sciences, with botany among them, as options, if not as a requirement, for entrance. If, in the colleges with which we are connected, the sciences, including botany, are not accepted for entrance, it should at least not be through default of vigorous championship upon our part.

It is, however, with the third advance mentioned above, namely, with the effort to secure uniformity in requirements in the same subject, that we are now immediately concerned. It is well known that the varied demands made by different colleges in the same subjects impose a most serious burden upon those preparatory schools which prepare students for several colleges, requiring multiplication of classes, division of resources, waste of energy, and, worst of all, a too great subordination of true education to preparation for the passing of examinations. This mal-adjustment of preparatory schools

as a whole to colleges as a whole constitutes one of the most serious educational problems of the present time. So serious is it that not only has the National Educational Association given its best energies for some years past to the endeavor to formulate standard national courses, but associations of colleges and preparatory schools, with large and influential membership, have been formed chiefly to grapple with it. All these efforts, be it noted, are not at all toward a uniform total requirement for all colleges, but simply toward a uniform general mode of treatment of each particular subject, and the colleges are left as free as before to make any desired permutations and combinations of subjects. The most important and practical step of all in this direction has recently been taken in the formation of the College Entrance Examination Board of the Middle States and Maryland, which is to have charge not only of the specifications of requirements in the individual subjects, but also of the uniform administration of those requirements through its own examinations. Steps have been taken, also, looking to the formation of a similar board for the New England States. Requirements have already been formulated by the former board in several subjects, but not yet in botany. Now, a question of immediate interest to us is this, what is to be the requirement adopted by these boards in botany? One would naturally expect that the course outlined by the Botanical Committee of the National Educational Association would be adopted; but this course, although embodying many good features, is not adapted, nor was it intended, for immediate practical use. If the formulation of new courses is left to the advisers of the board for the Middle States and Maryland, and to the New England Board, and to similar boards elsewhere, it is unlikely that uniformity will be secured; for such

boards, like individual colleges, will not only probably be shy of accepting one another's requirements *in toto*, but also each board will be swayed by the particular views of the most prominent teacher consulted. On the other hand, a course carefully and comprehensively formulated by some central and representative scientific association, based upon the best of the previous work done in this direction, and elaborated with the cooperation of the leading teachers and of other botanical organizations throughout the country, will stand a chance of wide acceptance, and perhaps, too, is likely to be a better course than a more limited body could develop. Such a course must obviously be widely accepted in order to be of real use; but, once firmly established, it will not only permit schools to concentrate their energies upon a single and excellent method of preparation which will allow any student to enter any college and give a good education to those who do not, but also at the same time it will constitute a sort of standard of comparison and measure of value, a definite ideal towards which ambitious schools may work, and a stimulus to other colleges to adopt botany among their entrance subjects. It is the object of this paper to propose that this society undertake the formulation of such a standard or uniform entrance option in botany, and take steps to secure its adoption.

It remains now to note briefly what we have to build upon in such a formulation, what conditions must be taken account of, and what practical steps may best be taken.

The idea of a standard entrance option in botany is far from being new. It was implied in the well-known report of the Committee on Secondary School Studies of the National Educational Association (commonly known as the Committee of Ten). The recommendations of the botanical section of that committee had without doubt a powerful influence upon botanical teach-

ing in this country, and that they were not more widely adopted was due partly to the then transitional state of botanical teaching, and partly to difference of opinion as to the wisdom of some of its recommendations. The discussions of the same Association led in subsequent years to the exposition of the idea of standard entrance options, and these are set forth with the greatest clearness in the report of the committee on college entrance requirements of that Association published in July, 1899. Now, if the course in botany recommended in that report were adapted to immediate use, and if it had the approval of the majority of teachers, there would be nothing left to be done except to urge its adoption. In fact, however, whatever we may think of the merits or demerits of the course, we must all agree that it is impracticable at present for the great majority of schools. That course, with its great emphasis upon ecology, represents an extreme reaction from the old formal systematic studies, and, as is usual in such cases, the truth will doubtless ultimately be found to lie between the extremes. I had myself the honor to be consulted in the preparation of that report and gave my adherence to it as to an ideal scheme to be worked towards rather than as one to be brought into immediate practical operation. What is needed at present, however, is a course which, while setting a high and stimulating standard of intellectual work, can be brought practically and profitably into operation in the immediate future.

It will help us to understand the situation if we glance at the status of botany as an entrance subject in a few of the leading colleges. Those which follow are selected partly at random and partly because their announcements happen to be at present accessible to me, but doubtless they are fairly representative. *Bryn Mawr* requires a science, which may be botany, from all stu-

dents, but the amount is small; apparently no sciences are accepted as options. *Chicago* accepts botany, a year's preparation, as a free option, counting 1 out of 15 points, and will accept 4 out of 15 points in sciences. *Columbia* accepts sciences as options up to 3 points out of 15, of which botany may count 1 point. *Cornell* accepts a science, which may be botany, as an alternative for the otherwise required mathematics. *Harvard* requires a science, which cannot be botany, counting 2 out of 26 points for entrance to the college, and will accept 7 or 8 points of sciences as options; botany, however, is accepted to count 1 point out of 21 for entrance to the Lawrence Scientific School, for which 5 points in the sciences out of 21 will be accepted as options. *Johns Hopkins* requires a science, which may be botany, but the amount required is small. *Leland Stanford* accepts 5 points out of 15 in sciences, of which botany may be one, counting 1 point. *Michigan* requires a year of physics absolutely of all students, and in addition accepts three years of science, of which botany may occupy either a year or, in combination with zoology, a half year. *Minnesota* appears to accept  $5\frac{1}{2}$  points out of 15 in sciences as options, of which botany may count as  $\frac{1}{2}$  or 1 point. *Nebraska* accepts 7 points in sciences out of 28 as options in one college; of which botany may count 2 points; and requires 3 points in the sciences, of which botany may be 1 point in the other college, and in the latter apparently 7 points in addition may be taken as options. *Smith* will accept the equivalent of 5 points out of 15 in the sciences as options, of which botany may count either as 1 point for a year of preparation or as 2 for two years, preparation. Of other colleges, some do not accept any sciences at all, while a few others which accept some of the sciences do not include botany among them. It appears, also, as would be expected, that the



liberal acceptance of the sciences is more common in the Central and Western than in the Eastern States.

The limits of my time will not permit even a summary of the preparation called for by the above-mentioned colleges, and it must suffice to say that this ranges from requirements little more than nominal up to some which are satisfactory in plan and scope. One characteristic which most of them show is a great liberality in the details of preparation, amounting in some cases practically to the acceptance of any good course. All this indicates a very undifferentiated condition of botanical teaching among us, a fact which, along with its many drawbacks, has at least this advantage from our present point of view, that it will be much easier to secure the adoption of a standard course than would be the case if the teaching were more differentiated. Although the preparation required appears at first sight to be very different for the different colleges, closer study shows that there are many common features, and these will form the natural and excellent foundation for the new course.

The ideal position for botany in the entrance curriculum, indeed the position towards which it seems in the most progressive institutions to be tending, is this: any college which requires any number of particular subjects should require a science; every college should accept as options enough of the sciences to allow a student thus to utilize four years of thorough high-school work in the sciences; botany should be included among these sciences; the preparation should be of such a character that it will yield a training fully equal to that afforded by any other subject studied for the same length of time, and will admit the student to second courses in college.

It will be agreed, I think, that the formulation and successful working of a standard entrance option is a matter of

much importance to us. But no such course can be formulated, much less brought into use, unless all teachers approach it in a friendly and cooperative spirit, each willing to yield some of his own individual views for the sake of the common good. It must be in the nature of a compromise, though it is by no means necessary that it shall represent a composite of all existent views. It must of course be elastic enough to allow full play to individual methods and the use of any good text-books, and must be standard in its framework rather than in its details. It will of course be binding upon no one, and must make its way, if at all, by its merits; and it will be liable to minor changes in the future, based upon trial and scientific advances. Colleges would naturally first adopt it as an alternative to their own systems. Especially it should face squarely the issue of providing a course equal in training value to the other subjects, for by this test botany, and the other sciences, must be judged, and stand or fall in the educational system.

With full faith in the possibility of preparing such a course, I would ask the Society:

1. Does a standard or uniform college entrance option in botany seem desirable?
2. Does it seem possible of attainment?

If the answer to these questions is in the affirmative, I would propose:

*a.* That a committee of three be appointed by the president before the close of this meeting, with power to open communication in the name of the Society with colleges, examination boards and individual teachers upon this subject, and to take such steps as their judgment approves towards formulating and securing the adoption of such an entrance option.

*b.* That the committee make the attempt to secure an option nationally acceptable, but if this be found impracticable, then it

shall be attempted only for the region covered by the work of the College Entrance Examination Board of the Middle States and Maryland, and of the corresponding New England board if formed.

c. That the committee be authorized to draw upon the secretary-treasurer for its expenses of printing, etc., up to a limit of \$20.00.

The Society voted to approve this plan with the proviso that the Committee should submit to the members by mail a preliminary printed report, and should be guided by any opinion submitted by a majority of the members. The president appointed Messrs. Ganong, Lloyd and Atkinson such a committee. The preliminary report of the committee is now ready, and will be sent to members of the Society and to others known to be interested. Others wishing to see the report may obtain copies by application to the writer. The appearance of the final report will be announced through SCIENCE.

W. F. GANONG.

SMITH COLLEGE, NORTHAMPTON, MASS.

#### THE MICHIGAN ACADEMY OF SCIENCE.

THE seventh annual meeting of the Michigan Academy of Science was held at the University of Michigan, Ann Arbor, March 28th, 29th, and 30th, under the presidency of Professor Chas. E. Barr, of Albion College.

The general session of Thursday afternoon, March 28th, was devoted to the geological and archeological surveys of the State. The Secretary read a paper by Mr. Harlan Smith, of the American Museum of Natural History, on 'An Archeological Survey of Michigan,' and Mr. Geo. W. Bates, president of the Detroit Archeological Society, presented a second paper by Mr. Smith, on 'The Antiquities of Michigan, Their Value and Impending Loss.' This paper described many of the archeological remains of Michigan, and urged that steps should be taken to preserve them. (At a later meeting the Academy endorsed a bill now before the Legislature, providing for an archeological survey of the State.)

Dr. A. C. Lane presented a paper (read by the Secretary) on 'Recent Work of the State Geological Survey,' and Mr. Frank Leverett, of the U. S. Geological Survey, gave an account of 'Glacial Investigations in Michigan.' These papers showed that the Government and State Surveys are cooperating, and supplementing each other's work in many respects. The State Survey is devoting itself chiefly, in the lower peninsula, to the study of marl, and to a correlation of the various coal seams; in the upper peninsula to a correlation and study of the copper-bearing lodes. Mr. Leverett's paper presented certain economic and scientific results of the U. S. Geological Survey, particularly in the mapping and interpretation of topographic features, and in variations in the structure of glacial deposits. The successive positions of the margin of the glacial ice were shown to be marked by moraines or massive belts of rolling country which are found to sweep around the basins of Lake Michigan, Saginaw Bay and Huron-Erie. These carry on their outer borders more or less extensive plains of gravel and sand, which were formed by the outflowing waters of the melting ice-sheet. The distribution of these moraines and bordering gravel plains indicates that the first counties of Michigan to be uncovered by the melting back of the ice are Branch, St. Joseph, Kalamazoo and Calhoun, and the water from the ice then flowed to the Kankakee River, past South Bend, Ind. The ice margin melted back from these counties toward the lake basins to the west and north and east, and after a time it shrunk within the present limits of the Great Lakes. The lake history connected with the present system of Great Lakes is very complicated and as yet but partially worked out.

The Academy then divided into sections of botany, zoology, sanitary science and agriculture, and sectional meetings were

held on Thursday afternoon and Friday forenoon, under the chairmanship of the sectional vice-presidents.

In the Botanical Section, Professor C. F. Wheeler, chairman, the following papers were read :

- 'The Perception Zone of Roots': DR. FREDERICK C. NEWCOMBE, Ann Arbor.
- 'Transition from Stem to Root in *Echinocystis lobata* Torr. & Gray': DR. JAMES B. POLLOCK, Ann Arbor.
- 'Zygomorphy of *Styldium adnatum* R. Br.': GEORGE P. BURNS, Ann Arbor.
- 'Adaptation of *Solanum Dulcamara* L. to Aquatic Conditions': THERESA G. WILLIAMSON, Ann Arbor.
- 'Ecological Study of a Glacial Lake near Ann Arbor': HOWARD S. REED, Ann Arbor.
- 'Aerotropism of Roots': MAY ELLA BENNETT, Ann Arbor.
- 'A Disease of the White Birch': JOHN LARSEN, Ann Arbor.
- 'Conditions influencing the Vitality of Seeds': JOSEPH W. T. DUVEL, Ann Arbor.
- 'Interfoliar Scales of Monocotyledonous Aquatics': MINNA C. DENTON, Ann Arbor.
- 'Something concerning the Forests of Northern Michigan.' With lantern views: DR. W. J. BEAL, Agricultural College.
- 'Notes on the Flora of Eaton County': PROFESSOR HUBERT LYMAN CLARK, Olivet.
- 'The Dwarf Mistletoe in Northern Michigan': PROFESSOR CHARLES F. WHEELER, Agricultural College.
- 'The Relation of Algae to Marl': PROFESSOR CHARLES A. DAVIS, Alma.
- 'A Noteworthy Occurrence of *Wolffia*': PROFESSOR CHARLES A. DAVIS, Alma.
- 'Notes on *Utricularia cornuta* Michx.': PROFESSOR CHARLES A. DAVIS, Alma.
- 'Notes on Michigan Saprophytic Fungi': B. O. LONGYEAR, Agricultural College.
- 'New Species of Michigan Fungi': B. O. LONGYEAR, Agricultural College.
- 'A Sclerotium Disease of the Huckleberry': B. O. LONGYEAR, Agricultural College.
- 'Causes inducing Asparagus to take its Form of Growth': L. LENORE CONOVER, Detroit.

In the Zoological Section, under the chairmanship of Mr. Bryant Walker, of Detroit, papers were given as follows :

- 'Phototaxis in Amphipods': DR. S. J. HOLMES, Ann Arbor.

'Preliminary Report on the Molluscan Fauna of the Region about Ann Arbor': MR. H. E. SARGENT, Detroit.

'Suggestions for a Method of Studying the Migrations of Birds': MR. L. J. COLE, Ann Arbor.

'The Occurrence of *Ammocetes*, the Larval Form of *Lampetra wilderi*, near Ann Arbor': MR. D. C. SCHAFFNER.

'Some Aspects of the Electrotactic Reaction of Lower Organisms': MR. RAYMOND PEARL.

'A Curious Habit of the Slug, *Agriolimax*': MR. RAYMOND PEARL.

'The Effect of very Intense Light on Organisms': MR. RAYMOND PEARL and Mr. L. J. COLE.

'Certain Reactions of the Common Slug, *Agriolimax campestris*': MR. RAYMOND PEARL and MISS MAUDE M. DEWITT.

'Some Further Notes on the Breeding Habits of *Amia*': PROFESSOR JACOB REIGHARD.

'On the Anterior Head Cavity of the Elasmobranchs': PROFESSOR JACOB REIGHARD.

'On the Early History of the Auditory and Lateral Line Organs of *Amia*': CORA J. BECKWITH. Read by Jacob Reighard.

'The Classification of Birds': PROFESSOR HUBERT L. CLARK, Olivet.

'The Breeding Habits of Holothurians': PROFESSOR HUBERT L. CLARK, Olivet.

'Death from the Bite of the Water Moccasin, *Aghkistrodon piscivorus*': PROFESSOR WALTER B. BARROWS, Agricultural College.

'Birds of the Carolinian or Upper Sonoran Zone in Michigan': PROFESSOR WALTER B. BARROWS, Agricultural College. Read by title.

In the Section of Sanitary Science, Hon. Frank Wells of Lansing, chairman, the following papers were read :

- 'A Bacteriological Study of an Epidemic among Guinea Pigs': LOUIS M. GELSTON, Ann Arbor.
- 'Frenkel's Pneumococcus found in a Case of Tonsillitis': W. G. CARHART, Ann Arbor.
- 'The Detection of Boric Acid in Milk': W. H. VEENBOER, Ann Arbor.
- 'The Detection of Formaldehyde in Milk': A. J. HOOD, Ann Arbor.
- 'The Toxin of the Colon Bacillus': DR. V. C. VAUGHAN, Ann Arbor.
- 'Some Results of Public Health Work': HON. FRANK WELLS, Lansing.
- 'Biological Problems in the Prevention of Certain Diseases': DR. HENRY B. BAKER, Lansing.

In the Section of Agriculture, J. A. Jeffrey, chairman, Dr. W. J. Beal gave a

paper on 'Some Relations of Botany to Agriculture,' and Mr. Kenyon Butterfield gave a talk on 'Some New Phases of Agricultural Education.'

On Friday afternoon a joint session of the Academy and the Biological Section of the Michigan Schoolmasters' Club was held in the University Museum. This session was largely devoted to the pedagogical aspects of the biological sciences. The papers given were as follows:

'Nature Study.' Presidential Address: PROFESSOR CHARLES E. BARR, Albion.

'How Shall a Young Person Study Botany?' DR. W. J. BEAL, Agricultural College.

'Outline for a Year's Work in Botany': L. LENORE CONOVER, Central High School, Detroit.

'Suggestion for a Year in Zoology': MISS ANDRÉ, Central High School, Detroit.

'Value of Supplementary Experiments': DR. LEWIS MURBACH, Central High School, Detroit.

'Science in the High School': MISS PALMER, High School, Lapeer.

'Recent Work and Theories on Fertilization of Animals': DR. S. J. HOLMES, Ann Arbor.

'Recent Work and Theories on Fertilization of Higher Plants.' Illustrated by Lantern Slides: DR. J. B. POLLOCK, Ann Arbor.

'The Proposed Topographic Maps of Michigan': DR. ISRAEL C. RUSSELL, Ann Arbor.

Two evening lectures were given before the Academy. On Thursday evening, Professor H. S. Carhart of the University of Michigan lectured on 'The Place of Physics in a Liberal Education,' and on Friday evening, Professor F. H. Herrick of Western Reserve University gave an illustrated lecture on 'The Haunts and Habits of Wild Birds.'

At the business meeting Saturday morning a committee was appointed to confer with corresponding committees from other scientific societies of the State, with a view to the affiliation of the other scientific bodies of the State with the Academy. The Academy voted also to endorse the bill now before the Legislature for an archeological survey of Michigan. The following officers were elected for the coming year:—

*President*, Professor Victor C. Vaughan, University of Michigan; *Vice-President*, for Botany, Professor C. F. Wheeler, of the Michigan Agricultural College; for Zoology, Professor Hubert Clark, of Olivet College; for Sanitary Science, Hon. Frank Wells, Lansing; for Agriculture, Professor J. A. Jeffery, of the Michigan Agricultural College; *Treasurer*, Professor Wm. H. Munson, Hillsale College; *Secretary*, Dr. James B. Pollock, University of Michigan.

A considerable number of new members were elected at this meeting; the sessions were well attended, and great interest was manifested in the work of the Academy. Altogether the meeting was the most successful and interesting in the history of the Academy.

H. S. JENNINGS.

#### SCIENTIFIC BOOKS.

*Traité d'astronomie stellaire.* Par CH. ANDRÉ. Directeur de l'observatoire de Lyon. *Première partie: Étoiles simples.* 1899. Pp. xvi + 344. *Deuxième partie: Étoiles doubles et multiples. Amas stellaires.* Paris, Gauthier-Villars. 1900. Pp. xxiv + 429.

This excellent work seems to have attracted less attention than it deserves. It has the distinction of filling a gap in the literature of the subject. It covers ground which is common to both astrophysics and astronomy of position, as treatises are now more and more compelled to do; for in spite of the increase of specialization, the distinction in results obtained by astrophysical and astronomical methods is becoming slight. What, for instance, is an essential difference between the two components of the actual linear motion of a star, although the one is determined purely by the processes of astronomy of position, while the other is measured by the spectroscope?

The opening chapter of Professor André's first volume deals with objectives and mirrors, a topic upon which he is especially well fitted to speak. The sections treat of the theory of optical images, of the effect of diffraction screens or diaphragms over the objective, and of images

of the sun and planets. Chapter II. gives a general description of the constellations and a discussion of the various star catalogues and charts since the time of Hipparchus. The next two chapters deal with stellar magnitudes, referring particularly to determinations of brightness made without instrumental means. The number and distribution of the stars, and a study of the Milky Way occupy two chapters.

The proper motion of the sun and the various methods of determining the apex of the sun's way are next considered, and this is naturally followed by the proper motions of the stars. An especially interesting table is that giving a comparison of the radial velocities with the proper motions on a great circle for fifty of the brightest stars. Chapter IX. treats of stellar parallaxes, giving the results obtained by many investigators. The volume closes with a chapter of 50 pages on variable stars.

The orbits of binary systems and the various methods of their calculation (Herschel, Kowalsky and Glasenapp, Zwiers) are discussed at considerable length, together with their number and dimensions, in the opening chapters of the second volume. A table is given containing the elements of sixty-six known orbits. The effect of the introduction of a linear element, the radial velocity, is treated in one of the sections, and M. André has calculated for the sixty-six well-established binaries the epochs at which a maximum radial velocity may be expected, and the value of that maximum on the assumption of a stellar parallax of  $0''.2$ . 'Astronomy of the Invisible' is the title of a chapter of 37 pages, dealing chiefly with the orbits of *Sirius*, *Procyon*,  $\zeta$  *Canceri*, and 70 *Ophiuchi*.

The methods of Rambaut and Lehmann-Filhès for computing the orbits of spectroscopic binaries are given in sufficient detail in a separate chapter. About one hundred and thirty pages are next devoted to 'photometric binaries.' This includes a full historical account of *Algol* and its investigation by Pickering, Harting, Vogel, Chandler and Tisserand, together with all available data as to seventeen other variables, of the *Algol* type. Dunér's beautiful work on the orbit of *Y Cygni*, pub-

lished last spring in the *Astrophysical Journal*, was unfortunately too late to be included.

Subsequent chapters treat of the clusters and nebulae, in particular of the *Pleiades*, *Præsepe*, and the region of  $\eta$  *Carinæ*; of the distribution of these objects, and of their distance. Globular clusters have a chapter of their own, which includes Bailey's recent remarkable variables. A short chapter is also given to colored stars.

The two volumes contain over one hundred cuts, and three excellent plates, and are printed in the usual excellent manner of Gauthier-Villars. A rather large list of errata is given, and probably more will be found. The book abounds in examples of the characteristic French disregard of the correct spelling and initials of foreign proper names.

This somewhat detailed account of the scope and contents of the work has been given to justify the remark that it fills a gap in the literature of the subject. The book would seem to be very well adapted for a basis of an elective course for seniors in our colleges, and the subjects treated are surely of greater freshness and interest, and of no less value in mental discipline, than the customary courses on the orbits of comets and planets.

A third volume is promised to complete the work—on the methods and instruments of modern research, and on the formation and evolution of the universe.

EDWIN B. FROST.

*The Steam-engine Problem.* By S. H. BARRACLEUGH, B.E. (Sydney), M.M.E. (Cornell). Russell School of Engineering, University of Sydney, N. S. W. Sydney, Kealy and Phillip. 8vo. 1900. Pp. 47. Figs. 13.

In this little book of less than fifty pages, Professor Barraclough admirably outlines the problem of the steam-engine as it is now coming to be enunciated by scientific engineers and by thermodynamists who recognize the fact that the thermodynamics of the ideal may not constitute all, and that the real engine offers a complex problem which involves the most abstruse studies in physics, mechanics and energetics. This outline originally appeared in substance in the *Australian Technical Journal*. It was

written for students having an elementary knowledge of the subject.

The plan of the book includes a statement of the problem, its financial aspect, its mechanics, the scientific side and the practical side as well. The scope of the problem, choice of site, character of installation, type of engine and boiler, and their design, construction, erection and operation, are excellently stated, including the finance of the case. Finance is taken as the controlling factor, and the costs of steam-power are indicated and illustrated. Rankine's method of apportioning the engine to its work, as a financial proposition, is described, its fatal defect shown, and the later and corrected system of use of true 'curves of efficiency' is described. In designing, the method of Professor Barr of ascertaining the results of general experience in determining the factor of safety is described and its results given.

A brief and well-arranged statement of the fundamental principles of thermodynamics is presented and an excellent outline of the scientific side of the problem is laid down. The great defect of the real engine, its internal waste of heat and steam, is well described, as are the results of later investigations to determine its amount and its laws of variation.

R. H. THURSTON.

*Catalogue of the Fossil Bryozoa in the Department of Geology, British Museum (Natural History).* By J. W. GREGORY. The Cretaceous Bryozoa, Volume I. London, Longmans & Co. 8vo. Pp. 457. 17 pl.

The long list of British Museum (Natural History) catalogues has received another welcome addition in the Catalogue of the Cretaceous Bryozoa, Volume I., by Dr. J. W. Gregory.

This catalogue is devoted entirely to descriptions and figures of the Cretaceous bryozoa, the groundwork, terminology, classification, etc., having been laid by the author in an earlier work of the same series: The Catalogue of the Jurassic Bryozoa in the British Museum (Natural History), published in 1896. In a second volume, to appear later, the author hopes to give a general introduction to the Cretaceous bryozoa, a list of localities with their horizons, and a bibliography. The catalogue is intended

to be complete, to include every recorded species, though the large number of inadequate descriptions by early writers and their unrecognizable figures will leave much in doubt. It is a question whether science would not be a gainer if much of this early work could be authoritatively set aside. The desire to conform too strictly to the law of priority or to do justice to early workers sometimes results in even greater injustice to later workers.

The present volume treats only of the Cyclostomata. This division Dr. Gregory raises to ordinal value and divides into the suborders: Tubulata, with the families Diastoporidæ, Idmonidæ, Entalophoridæ, Eleidæ; Cancellata, with families Horneridæ, Petaloporidæ; Dactylethrata, with families Clausidæ, Terebellariidæ, Reticuliporidæ.

The large size of the present volume is itself evidence of the fine collection which the British Museum has accumulated. The author notes the large additions recently made to the collection and laments that an American collection was received too late to be included in this volume. Doubtless the second volume will supply the deficiency. No work of importance has been done on bryozoa from secondary and tertiary formations of America since the work of Gabb and Horn in 1860-62. The interesting bryozoan fauna of the Cretaceous marls of New Jersey has begun, however, to attract the attention of workers in this country as well as abroad.

The greatest of the many merits of the volume under consideration is the great care taken in collecting full synonymy and in giving careful, accurate descriptions with measurements. The rather complicated mode of relative measurements which the author employed in the volume on the Jurassic bryozoa he has abandoned for the simpler and more easily comprehended plan of absolute measurements. We believe the author adopts the correct position when he says that dimensions, while important, seem to him of far less value than is attached to them by some continental writers, who make them the chief specific distinctions. It is no doubt true that, in some groups, each species is very constant in its dimensions, while in other groups species are very variable in this respect. But the same is true of other charac-

ters; a character which is constant and therefore reliable for purposes of differentiation and classification in one suborder or family, in another may be highly variable. This fact must be recognized in framing classifications.

The author retains with a few minor changes the classification proposed in the catalogue of the Jurassic bryozoa. In the present state of knowledge some scheme of classification is a necessity and yet but a temporary expedient. Our knowledge of the derivation, purpose, function and relative importance of the various structures found in fossil bryozoa is still too imperfect to enable an abiding classification to be framed. After all, the main purpose of a classification is to provide a scheme for maintaining an easy grasp upon relationships.

At the present time the best work that can be done is just the kind which our author does in this work, the giving of careful, close, accurate description with some account of the variations exhibited by a 'species,' with figures from which the form can be certainly recognized, and the careful, accurate, critical examination of the literature to weed out the synonyms. The author describes a considerable number of new species, showing that even in this direction there remains a great deal to be done. To the student of the bryozoa in general and the Cretaceous bryozoa in particular, the present volume must prove an indispensable working requisite.

J. M. N.

*The Human Nature Club; An Introduction to the Study of Mental Life.* By EDWARD THORNDIKE, Ph.D. Longmans, Green & Co. 1901. 8vo. Pp. 235.

This is an attempt to present the main facts of psychology in the form of a story, or at least of dialogue. Of this aspect of the essay the author says: 'Dramatically it is an atrocity.' Such frank disclaimer makes any further comment ungracious. And yet it would certainly have added much to the success of the undertaking not to have so entirely ignored the artistic factor in the presentation. It must, however, be viewed merely as a pedagogic aid to the popularization of the study of psychology, and particularly as a means of arousing interest

in the significance of the every-day mental life among every day people. As such it is an eminently sound and helpful presentation. It is also more than this, as it presents a perspective of the importance of some of the factors of mental assimilation, which bear the mark of close and original thinking. This is particularly true of the discussion of the formation of habits, with reference to the effect of special upon general training. In the main it is an appropriately eclectic treatment of the primary elements of our mental nature. The Human Nature Club is a very artificial assemblage of persons, who discuss, with rare singleness of purpose, 'what the brain does,' and the 'things we do without learning' and 'the different ways of learning'; consider the senses and memory and attention and trains of thought and mental imagery and suggestion and imitation and our emotions and our actions and character, and some other yet more complex and deeper questions. Socrates would certainly be shocked at the modern speed with which conclusions are drawn from a few sporadic, and yet significant, illustrations, with but little allowance for analysis or dialectic. But this is inevitable, if the book is to cover its ground; and after all, the characters of the dialogue do not really draw these conclusions, but only restate them from such worthy authorities as James and others. The psychological matter is well grounded, suggestive, discriminatingly used and clearly set forth. The query will arise with reference to the proof of the pudding, which according to modern notions is not in the eating, but in the digestion thereof. That the book may prove palatable to certain palates, it is easy to believe; but whether persons with sufficient maturity of mind to consider psychological questions at all should not be at once placed on more strenuous diet, is a question upon which teachers of psychology are likely to hold diverse opinions. Yet with whatever training they may desire their pupils to approach the study of mental phenomena, it would be mere perversity to fail to recognize that there is in this country a large class of persons who do 'study' psychology, are genuinely interested, and are likely to be approachable only by ap-

propriate popularizations. For these this volume has the promise of proving serviceable, and to others and more serious students it may not be without suggestive value. It is fortunate, at all events, that the psychology thus presented draws its inspiration from worthy and scholarly sources, and is presented in a way calculated to make the student think and observe, not merely read and repeat. We may question whether good wine should be so much diluted; but however thin, it retains a flavor which wine of lesser quality never bears.

J. J.

#### BOOKS RECEIVED.

*Report of the Seventieth Meeting of the British Association for the Advancement of Science, held at Bradford, in September, 1900.* London, John Murray. 1900. Pp. exvi + 975 + 111.

*Report of the U. S. National Museum. Part II. A Memorial of George Brown Goode together with a selection of his Papers on Museums and on the History of Science in America.* Washington, Government Printing Office. 1901. Pp. xii + 515.

*The Elementary Principles of Chemistry, accompanied by Suggestions to Teachers.* A. W. E. YOUNG. New York, D. Appleton & Company. 1901. Pp. xiv + 106 + 48.

*Gano's Natural Philosophy.* Translated by E. ATKINSON and revised by A. W. REINOLD. Longmans, Green & Co. 1900. Pp. xii + 752.

*Lepeophtheirus and Leinæa.* No. VI. of the Liverpool Marine Biological Committee Memoirs. ANDREW SCOTT. London, Williams & Norgate. 1901. Pp. viii + 54 and 5 plates. 2 s.

*Second Report of the United States Board on Geographic Names, 1890-1899.* Washington, Government Printing Office. 1901. Pp. 150.

#### SCIENTIFIC JOURNALS AND ARTICLES.

NUMBER LI. of the *Journal of American Folk-lore*, which is late in appearing, and concludes the year 1900, contains as the first article a Hawaiian legend entitled 'Laiëikawai,' from the memoranda of Dr. John Rae, by whom the story was taken down and translated, probably about 1860. Of this narrative a variant appears in the book of King Kalakaua, published in 1888. Both versions are abstracts, but the account of Rae, which is only a fragment, is so far as it goes much fuller, and gives a much

better idea of the literary character of Hawaiian myth than any other accessible source of information. The story seems to have been a prose epic narration of great length, ornamented with occasional pieces of verse and provided with a very complicated plot. The state of society, and the conceptions as well as modes of expression, frequently remind the reader of the Homeric poems. The heroine from whom the tale is named was worshipped by certain Hawaiian gentes under the title of the Lady of the Twilight, and the sun-hero became her husband. The story of Rae recites the manner in which the girl, as born before the coming of a brother, is sentenced to be put to death, her concealment by her grandmother, education in a cave below a waterfall, growth to maturity, and great beauty, the fame of which got abroad, and caused a quest after her place of hiding, which was indicated by the presence of a rainbow, attendant on the maiden as of divine race. The narration is full of information concerning Hawaiian cult and superstition, and makes a valuable addition to the existing stock of knowledge. It is to be hoped that the publication may lead to a determined attempt to preserve Hawaiian legendary lore, and to procure full and correct texts in the original language. Miss A. C. Fletcher describes a Pawnee ceremony of thanksgiving, at which she had the good fortune to be present. In this rite a buffalo skull was worshipped as representative of an ancient divine buffalo established by the supreme deity Tirawa as mediator and teacher of men. Dr. A. F. Chamberlain contributes a discussion on 'Algonkian Terms connected with Religion and Mythology.' Among the items of belief may be noted evidence that sacrifices were made to the war-god by the suspension to trees of human victims; one is reminded of the similar Norse offerings to Odin. Rev. W. M. Beauchamp supplies an Onondaga tale of the Pleiades, in which these stars are represented as merry children who have danced themselves into the sky. The excellent record of 'American Folk-Lore' is continued by Dr. A. F. Chamberlain (Clark University, Worcester, Mass.). With the present year Dr. Chamberlain will assume the general management of the journal, Mr. W. W. Newell, who has hitherto



fulfilled that function, remaining as associate editor.

In a reprint of articles on early American ballads, contained in Nos. 47 and 49 of the same *Journal*, Mr. W. W. Newell traces the history of certain ballads produced in Massachusetts. One of these, called 'Isaac Orcutt,' and belonging to the end of the eighteenth century, recited the manner in which that youth met his death from a falling tree; the piece was sung as a dirge at the funeral, being chanted by six young women dressed in white. Similar was the origin of 'Springfield Mountain,' produced in 1761, in memory of the son of a Lieutenant Merrick, of Wilbraham. The ballad attained extraordinary popularity in the United States, being sung with numerous variations; it abdicated its local character, took on a love situation, and survives as a comic song. These examples are the more curious inasmuch as the custom of chanting dirges over the dead seems not to be recorded in English folk-lore.

*The Popular Science Monthly* for April opens with a sketch of the work of 'Malpighi, Swammerdam, and Leeuwenhoek,' by William A. Lacy. Paul H. Hanus discusses 'Two Contemporary Problems in Education,' 'What shall we do about the elective system of studies and how shall we bridge the gap between the high school and the lower grade?' Incidentally Professor Hanus advocates studying some modern language for two or three years before commencing Latin. Havelock Ellis continues 'A Study of British Genius,' this instalment being devoted to heredity and parentage, and the favorite topic of 'Suicide and the Weather,' is treated in some detail by Edwin G. Dexter. Charles H. Cochrane gives a résumé of 'Recent Progress in Aërial Navigation,' and 'The Foreign Trade of the United States,' is treated at some length by Frederic Emory, who, while noting its recent great increase, calls attention to the fact that in the near future we may be obliged to struggle to retain it. Finally Solon I. Bailey tells of 'The Planet Eros,' which for various reasons, among them its importance for determining the solar parallax, is for the moment of more interest to the astronomical world than the greatest planet. The var-

ious departments contain articles of interest and the number contains the index for Vol. LVIII.

#### SOCIETIES AND ACADEMIES.

##### SECTION OF BIOLOGY OF THE NEW YORK ACADEMY OF SCIENCES.

At a regular meeting of the section held on March 11, 1901, the following program was offered:

H. F. Osborn: 'Systematic Revision of the American Eocene Primates and of the Rodent Family *Mixodectidae*.'

O. P. Hay: 'The Composition of the Shell of Turtles.'

M. A. Bigelow: 'Some Comparisons of the Germ-Layers in Entomostraca Crustacea.'

Professor Osborn stated that the only fossil primates at present known are those in the Eocene. The supposed Oligocene genera described by Marsh and Cope have proved to belong to the Artiodactyla. Associated throughout with the discovery and literature of the primates is the family *Mixodectidae*, including *Mixodectes* of the basal Eocene or Torrejon beds; Mathews has suggested that this animal is a rodent. Careful comparison of this type with the supposed primates *Cynodontomys* of the middle Eocene and *Microcyops* of the upper Eocene proves that these animals also belong probably with the rodentia; they represent a primitive stock with strong affinities to the Tillodontia, which are thus brought nearer to the ancestral rodents. This conclusion removes all these animals from the primates where they have hitherto been placed. This leaves three families of monkeys, as follows: *Hypsodontidae*, including *Hypsodus* and *Sarcotlemur*, animals of medium size, retaining the typical series of 44 teeth; a second family, the *Notharctidae*, including *Pelycodus* and *Notharctus*, animals of larger size, with teeth reduced to 40 by the loss of 4 incisors, and like the foregoing comprising long-jawed types; and a third family, the famous *Anaptomorphidae* of Cope, short-jawed, very progressive types, with 36 to 32 teeth, the pre-molar series being reduced. The identification of these families with the Eocene *Adapidis* or with *Necrotlemur* of Europe is not sustained. The *Hypsodontidae* and *Notharctidae* are well

distinguished by sextituberculate superior molars.

Dr. Hay called attention to the fact that for a long time there has been much discussion regarding the origin of the elements entering into the shell of turtles. As to the bones known as costal plates, the great majority of anatomists have held that they have resulted from the union of dermal bones with underlying ribs: the neural plates from the union of dermal bones with the neural arches. Recently Goette has studied the development of the costals and neurals in the young of *Chelone squamata*. He finds that the whole costal plate develops continuously from bone which appears beneath the perichondrium of the cartilaginous ribs. No part of either the costal or neural plates arises in the skin. While accepting Goette's results as established, the speaker did not accept his conclusion. Neither did he accept the other view that the costals and neurals are composed of dermal bones united with those of the internal skeleton. The speaker held that there were originally three strata of bones on the dorsal surface of turtles. One of these was in the skin, and is represented by the mosaic found in the skin of *Dermochelys*. Another layer was sub-dermal, and this united with elements of the third stratum, namely the ribs and neural arches. This union has become so complete that the bones arise from the same centers. These three strata of bones on the dorsal surface correspond to those which are found in the ventral wall of the caiman, viz: true ribs, 'abdominal ribs,' and bony dermal scutes.

Mr. Bigelow compared the germ-layers of various Crustacea with special reference to the Cirriped *Lepas*. It was pointed out that in the cleavage leading to the segregation of the germ-layers there are very many resemblances between *Lepas* and other Entomostraca. *Lepas* resembles most other Crustacea in respect to the position of the blastopore, and the extension of the entoblast and mesoblast from that region as a starting point. In *Lepas* also the mesoblast and entoblast originate from cells which, speaking in general terms, lie at first in the blastoderm and later migrate into the cleavage cavity. But among these immigra-

ting mesentoblastic cells one can distinguish the individual cells of entoblast and two varieties of mesoblast, entomesoblast and ectomesoblast. There are observations indicating that similar conditions exist in other Crustacea.

HENRY E. CRAMPTON,  
Secretary.

SECTION OF ASTRONOMY, PHYSICS AND CHEMISTRY OF THE NEW YORK ACADEMY OF SCIENCES.

A REGULAR meeting of the section was held on April 1, 1901. The first paper was by Mr. H. C. Parker, on some 'Experiments on Standards of High Electrical Resistances.' The author briefly described the usual methods employed in the measurement of high resistances and then gave an outline of Professor Rood's electrometer method (*American Journal of Sciences*, Vol. X., October, 1900, pp. 285-294). By this method it seems possible to measure resistances as great as 1,000,000,000 megohms, while by the direct deflection method the practical limit was stated to be about 100,000 megohms.

The author gave the results of a series of measurements made on a new form of standard high resistance, devised by Professor Rood. This form of standard consists of oxide of manganese on cobalt glass. It gives a convenient means for obtaining resistances of from one to ten thousand megohms. Most of the measurements were for the purpose of determining the best protective insulating material with which to coat the above resistances. The author stated that the work was still in progress.

Professor J. K. Rees then presented a paper on 'Temporary Stars, with Especial Reference to the New Star in Perseus.' Professor Rees explained the present classification of variable stars and gave illustrations of each of the six classes. A history of the discovery of the new star in Perseus was given and photographs of its spectrum were exhibited. Brief mention was made of the various collision theories proposed to account for the evidence of two light sources which appear involved. The light curve of the new star was referred to, showing how rapidly the star increased to the 0 magnitude,

from which it has slowly decreased to, at present (April 1st), the 5th magnitude.

The paper was discussed by Professors Hallock and Herring, Dr. Day, Mr. C. A. Post and others.

Professor Rees then gave 'An Exhibition of some of the Photographs of Nebulæ taken with the Crossley Reflector of the Lick Observatory,' by the late director, J. E. Keeler. Professor Rees remarked that Columbia University had lately received a series of beautiful photographs of nebulae from the director of the Lick Observatory. After a brief description of the Crossley reflector, and of the remarkably successful work of Dr. J. E. Keeler in the photographic study of nebulae, the illustrations named below were thrown upon the screen.

Orion nebula, taken November 16, 1898; exposure, forty minutes.

51, M. Canum Venaticorum, taken May 10, 1899.

Dumbbell nebula in Vulpecula, taken July 31st, 1899; exposure, 3 hours.

Trifid nebula in Sagittarius; exposure, 3 hours.

The Pleiades, showing nebulosity.

Ring nebula in the Lyra.

Crab nebula in Taurus.

Small nebula in Andromeda.

Spiral nebula M. 74, in Pisces.

Spiral nebula in Pegasus.

Spiral nebula in Triangulum.

Spiral nebula in Ursa Major.

Net work nebula in Cygnus.

M. 13, in Hercules, star cluster.

Reference was made to Keeler's determination of radial velocities of nebulae and to the distances of these masses. In conclusion an enthusiastic tribute was paid to the late Director Keeler.

F. L. TUFTS,  
Secretary.

#### THE ONONDAGA ACADEMY OF SCIENCE.

At the regular monthly meeting held at the Medical College, Syracuse, N. Y., on February 15th, Dr. L. M. Underwood, of Columbia University, New York, addressed the Academy on the subject of 'Botanical Gardens.' His paper was a history of the great Botanical

Gardens at Kew, Java, Berlin, etc., together with a description of the Gardens planned for New York in connection with the University. The address was very fully illustrated with a fine collection of slides.

The following officers were chosen for the ensuing year: *President*, Dr. W. M. Beauchamp; *Vice-President*, Dr. C. W. Hargitt; *Corresponding Secretary*, Philip F. Schneider; *Recording Secretary*, Horace W. Britcher; *Treasurer*, Miss L. W. Roberts; *Librarian*, Mrs. L. L. Goodrich.

On March 15th, the meeting was held at the Historical Rooms. The program consisted of the reports of the officers and sections for the year.

Mr. C. E. Wheelock read the report of the Geologic Section giving a detailed account of the various meetings and conferences. Two new cephalopods, undescribed as yet, were reported from the Goniatite Limestone, making seventeen organisms discovered in this formation.

Mrs. L. L. Goodrich read the report of the Botanical Section. Monthly meetings and weekly classes are held. At one of these meetings on the grounds of the Hon. C. E. Smith, Syracuse, a hybrid chestnut tree, which he had raised, was seen, upon which over a hundred humming birds had congregated to gather honey, a truly remarkable sight. Three new plants, one a fern, have been added to the list from this county. The ferns now number 41.

Dr. C. W. Hargitt gave the report of the Zoological Section. During the past year they have been working largely upon the lower forms, especially the bacteria, of local streams. Variations in local shells have also been recorded. Three new batrachians and 25 spiders have been added to lists from the county, and cyclops and branchippus described and identified.

The annual report of Secretary E. M. Patte<sup>e</sup> showed 40 active, 17 associate and 3 corresponding members. It also recorded the loss by death of Professor J. A. Dakin, the noted ornithologist, during the year. Miss L. W. Roberts, treasurer, reported a balance of \$87. Dr. Wm. M. Beauchamp, president-elect, then read his inaugural address. It was a clear and scholarly address, carefully defining his posi-

tion, and teeming with helpful suggestions and plans for the year.

PHILIP F. SCHNEIDER,  
*Corresponding Secretary.*

THE ACADEMY OF SCIENCE OF ST. LOUIS.

At the meeting of the Academy of Science of March 18, 1901, forty-three persons present, Professor E. H. Keiser delivered an address showing the progress made in the science of chemistry during the nineteenth century. This address will be published in a subsequent number of SCIENCE.

Professor F. E. Nipher exhibited pieces of pine board a foot square, showing the tracks of ball lightning discharges upon them like those formerly described by him in No. 6, Volume X., of the *Transactions* of the Academy. The discharges formerly described had been formed on a photographic film. The balls were very small, and wandered over the plate, leaving a track of metallic silver in their wake. In the present instance the balls were much larger, and they burned a deep channel in the wood. They are formed at the secondary spark gap of a coil. The terminals are pointed and are under control, so that the gap may be changed in length. To start the balls, the pointed terminals are put upon the wood surface, so near that the spark carbonizes somewhat, after which the gap is made longer. These balls travel in either direction, when a direct current is used, with a Wehnelt interrupter. This differs from the results reached on the photographic film with the Holtz machine. There the balls came from the cathode. Even when they originated at isolated points on the film, they traveled away from the cathode.

In the present results, the balls have been caused to originate at isolated points, and two balls have started in opposite directions. Wood which gives little flame shows the phenomenon to best advantage, but the balls preserve their identity and travel slowly along even when completely surrounded by flames of the burning wood.

Three persons were elected to active membership in the Academy.

WILLIAM TRELEASE,  
*Recording Secretary.*

DISCUSSION AND CORRESPONDENCE.

RESIGNATIONS FROM THE SCHOOL OF PEDAGOGY,  
NEW YORK UNIVERSITY.

OWING to long-continued dissatisfaction with the administration of the Department, the following professors of the faculty of the School of Pedagogy of New York University announce their resignation from the University:

SAMUEL WEIR,

*Professor of History of Education and Ethics.*

EDWARD F. BUCHNER,

*Professor of Analytical Psychology, and Secretary of the Faculty.*

CHARLES H. JUDD,

*Professor of Experimental Psychology.*

THE PROPER NAME OF THE ALPINE CHOUGH.

TO THE EDITOR OF SCIENCE: I should like to state the reasons why I cannot agree with Mr. W. J. Fox's proposal made in SCIENCE for February 8 (N. S., Vol. XIII., p. 232) to adopt the name '*Monedula pyrrhacorax*' for the Alpine chough. In the first place, as Mr. Fox allows, Hasselquist's '*Iter Palastium*,' being dated 1757, has no claim to recognition, even by those who take Linnæus's tenth edition (1758) as the commencement of zoological nomenclature. It seems to me, therefore, that the mere republication of his names in a German translation of that work in 1762 is not sufficient to give them validity. But what is still more important is that, as Mr. Fox will find, I think, on reading the original description carefully, it is by no means certain that Hasselquist's *Monedula pyrrhacorax* was based on a specimen of the Alpine chough, though it was referred to that species by Linnæus in his edition of 1758. Hasselquist gives 'Lower Egypt' as the place where his *Monedula pyrrhacorax* was discovered, but, according to the best authorities (see Schelléy's '*Birds of Egypt*,' p. 161), no such bird as the Alpine chough is known in Egypt, and it is indeed a very unlikely species to occur there, though it is found in the high rocky mountains of Algeria. Under these circumstances I maintain that we should not be justified in changing the familiar name *Pyrrhacorax alpinus* to *Monedula pyrrhacorax*.

P. S. SCLATER.

3 HANOVER SQUARE, LONDON, W.,  
March 15, 1901.

## NOTES ON INORGANIC CHEMISTRY.

## ATOMIC WEIGHT STANDARD.

In spite of the all but unanimous decision of the International Committee on Atomic Weights, that the standard should be Oxygen = 16, the question seems not yet to have been finally settled. At the December meeting of the American Chemical Society, a report was presented by the section of the International Committee appointed by the Society, in which it is shown that opinion is still somewhat divided, and an expression of views is called for from the members of the Society. For the guidance of the members a very fair statement is made in brief of the principal arguments for both standards. According to the report, Professor Erdmann writes that out of 143 replies to the teachers' circular, 118 favor the retention of the old standard, Hydrogen = 1. It will be remembered that after the report of the International Committee, six German chemists sent out a circular to the teachers of chemistry in German universities and technical schools, advocating the old standard, and calling for expressions of opinion. It is natural that replies to this *ex parte* circular should have been chiefly received from those who agreed with its views, but the number of favorable replies indicates that there is an element, by no means small, who are opposed to the majority. It is, however, not the teachers alone who are to be considered in this matter; the selection of the standard of atomic weights is of at least as much importance to the practical chemists, who vastly outnumber the teachers.

In the opening number of the *Berichte* for the year, the section of the International Committee representing the German Chemical Society publish the annual table, headed 'Internationale Atomgewichte. O = 16.00,' but they also print a second table with the heading 'Didaktische Atomgewichte. H = 1.00,' with the comment that it is done for those teachers who cannot reconcile their teaching to a standard which is anything other than unity. It is interesting to note that in this table appear for the first time gadolinium, krypton, neon, thulium and xenon, which are thus given a final standing as elements.

In reviewing these tables in the *Zeitschrift für*

*anorganische Chemie*, F. W. Küster reproduces the report in full, except that he omits the second didactic table, as unnecessary for the readers of the *Zeitschrift*. He says the only end gained by printing it would be to keep up the discussion, which should now be looked upon as finally settled. On the other hand, it would seem that in the end unanimity is far more likely to be obtained by still allowing the freest discussion, rather than by suppressing it, while any considerable number of chemists, including some of the most eminent, refuse to acquiesce in the decision.

## ACTION OF ALCOHOL UPON METALS.

SOME time since, a note was made in these columns of a specimen of alcohol contaminated with zinc, which could only have come from its being kept, as is so often the case, in a galvanized iron container. The subject has been more recently investigated by Dr. Malméjac, and his results published in the *Journal de Pharmacie et de Chimie*. In his experiments he used ninety-five-per-cent. alcohol which left no residue on evaporation. The metals, copper, iron, tin, lead, zinc and galvanized iron, were corked up with the alcohol in glass flasks, and kept at ordinary temperature for six months. The copper was entirely unacted upon, but in all the other flasks there was a deposit at the bottom, and the metal was covered with a similar deposit. In the case of tin, lead, zinc and galvanized iron, the deposit was white; that from the iron was red, resembling iron rust. All the liquids, except that in which the lead had been placed, filtered clear; the latter retained its milky appearance after repeated filterings through double filters. The clear filtrates from iron, lead, zinc and galvanized iron gave much residue on evaporation, while the residue from tin was hardly appreciable. In the former cases it is clear that not only had the metal been oxidized, but a considerable quantity had entered into solution. These experiments have an important bearing on the preserving and shipping of alcohol, especially in view of the fact that absolute alcohol is very generally purchased in galvanized iron cans. In such a case redistillation is imperative.

J. L. H.

## CURRENT NOTES ON PHYSIOGRAPHY.

## THE ILLINOIS GLACIAL LOBE.

The elaborate monograph by Leverett on 'The Illinois Glacial Lobe' (Monogr. XXXVIII., U. S. Geol. Surv., 1899, xxi + 817 p., 18 maps, 6 pl. 9 figs.) has, apart from its high worth as the most detailed study of its kind yet published, a great value to the physiographer in warranting a generic treatment of the class of forms that it describes. It is not merely that one may find, in this or that part of Illinois, till plains, moraines, loess beds, gravel trains and the like, but that these several parts have a form and distribution characteristic of their class. Since Chamberlin's recognition of the lobate margin of the glacial sheet indicated by the peculiar arrangement of its terminal moraines, evidence in great variety and quantity has been discovered to confirm his generalization; and we have now come to possess good ground for regarding the moraines and the associated deposits and erosion forms of lobate ice sheets as characteristic elements of our topography, on a large scale horizontally, although of small vertical relief. The type form is relatively simple; it consists of many parts, but they are systematically and genetically related in a highly specialized unit; a unit whose empirical description is as baffling as would be the mention of an oak tree in terms of its items in arbitrary order instead of by its generic or specific name, but whose explanatory description is as easily apprehended as is that of a mature river-and-valley system. The association of several units by repetition of process provides something of the variety of nature; special features due to local conditions require an elastic instead of a rigid conception of the type; and the detection of the changes suffered by the initial forms with the passage of time affords a pleasing exercise for observation and understanding. An abstract of the facts thus understood, with Illinois as the field of their typical occurrence, should enter the high schools of this generation. Room may possibly be provided for them (by the exclusion of less worthy matter) in the grammar schools of the next generation. A closer study of the facts affords good exercise for collegiate students who have previously learned an outline of them in school. The details yet to be discovered in the field

will tax the patience and ingenuity of the investigator for years to come. The monograph is a worthy monument to the skill of the observer who executed it, to the insight of the leader who planned it, and to the broad policy of the organization that supported its preparation and publication.

## THE ALBAN MOUNTAINS.

The group of extinct volcanoes southeast of Rome, sometimes known as the Alban mountains among English writers, but called *Vulcano Laziale* by the Italians, is elaborately described by Sabatini (Mem. descr. Carta geol. ital. X, I Vulcani del l'Italia centrale e i loro prodotti. Parte I., Vulcano Laziale. Roma, 1900, pp. xv + 392, 9 pl., 2 maps). The mountain group is the complex product of successive constructive and destructive actions. A large volcano of about 20 kil. diameter lost its upper portion and then remained as a horseshoe mountain (caldera) now somewhat dissected and open to the southwest. Its central floor had an altitude of 400 or 500 met., and its rim, of 600 to 800 met. This structure is called *Cratere Tuscolano*. A second volcano, called Monte Albano or Laziale, was built on the same axis as the first; its basal diameter being 4.5 or 5 kil., and its altitude 956 met. It has a crater 200 met. deep, open to the northwest. At a still later time, three more or less complex basins or calderas were formed on the south and southwest of the central axis; they now contain lakes Nemi and Albano, of which some admirable views are given, and the plain of Ariccia. Lavas seem to constitute only a small portion of the volcanic mass. Its chief constituent is tufa, which Sabatini explains as successive deposits of volcanic ashes washed by rains, disregarding their suggested origin in torrents of mud ejected from the craters. Engulfment is not accepted as a satisfactory explanation either of the great *Cratere Tuscolano* or of the lake basins, but the argument for the exclusion of this process does not seem demonstrative. The volume of ejected materials is estimated to be about 200 cubic kilometers. More than half of the memoir is given to local and petrographic details. A bibliography occupies 22 pages. The colored geo-

logical map might well serve as a guide to the observant traveler in this most picturesque district.

#### REVERSION IN RIVER DEVELOPMENT.

In the Seven-mountain district of Pennsylvania, the anticlines and synclines of the corrugated Medina sandstone, pitching gently eastward, form an extraordinary series of zigzag ridges. Streams rise in the apex of the synclinal reentrants and flow eastward with the pitch of each synclinal axis toward the Susquehanna; and these axial streams receive branches that descend the dip-slope of the linear monoclinial

ancestral conditions after having passed through a systematic series of metamorphoses, as indicated in the accompanying diagrams. The first section represents initial conditions. An original consequent stream ( $A'$ ) flows along the pitch of a synclinal axis of Pottsville conglomerate and is fed by lateral consequents ( $L'A'$ ) from the slopes of the enclosing anticlines. Section 2 represents a later time when longitudinal subsequents have been developed along the anticlinal axes of the weak Mauch Chunk shales, thus shortening the laterals of the original system ( $L'A'$ ) by favoring the growth of obsequents ( $O'S'$ ). In section 3 the new subsequents have shifted down the dip of their determining formation, thereby developing a new lot of apparently consequent laterals ( $L''S'$ ), and the initial trough has been reversed into a narrow synclinal ridge, crowned by a remnant of Pottsville conglomerate. The original axial consequent ( $A'$ ) has vanished and an anticlinal subsequent of the second order ( $S''$ ) has appeared. With still further erosion, the two first-order longitudinal subsequents ( $S'$ , sect. 3) coalesce by continued monoclinial shifting, and thus form a new axial stream ( $A''$ , sect. 4) with appropriate laterals ( $L''A''$ ) in the trough of the Pocono syncline. By yet another series of analogous changes ending in the fifth section, a third-order axial stream will be developed ( $A'''$ ) fed by a series of third-order laterals ( $L'''A'''$ ) on the Medina syncline, such as at present exist. Although these streams closely imitate the ancestral consequents of the first section ( $A', L'A'$ ), it is evident that the imitation is due to reversion and not to the persistence of a fixed type. Streams of this kind might be called reversional consequents, renewed consequents, reconsequents, or simply resequents.

W. M. DAVIS.

#### CURRENT NOTES ON METEOROLOGY.

QUARTERLY JOURNAL OF THE ROYAL METEOROLOGICAL SOCIETY.

THE January Quarterly Journal of the Royal Meteorological Society contains several articles of general interest. Dr. Nils Ekholm contributes a paper 'On the Variations of the Climate of the Geological and Historical Past and their

ridges which diverge from each synclinal apex. Such a scheme of drainage has usually been called consequent; yet when it is remembered that the present relief has been developed by the removal of a great series of strong and weak strata it appears that the existing streams are not the persistent successors of the original consequents, but that they have reverted to

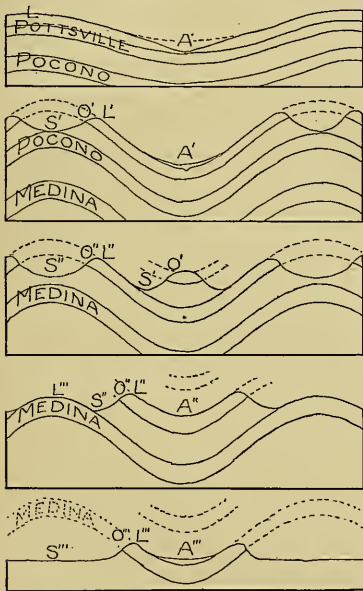

Causes,' which was presented at the recent Jubilee meeting of the Society. The subject is treated at considerable length under the following heads: (1) The general causes of changes of temperature. (2) Geological chronology. The probable age of the earth. (3) The radiation of the sun nearly constant during geological ages. The temperature of the earth's surface explained by the equilibrium between insolation and radiation from the earth into space. (4) Variations in the quantity of carbonic acid of the atmosphere the principal cause of the great climatic variations during geological ages. (5) The secular cooling of the earth is the principal cause of the variations of the quantity of carbonic acid in the atmosphere. Modifying influences. (6) Variations of the obliquity of the ecliptic and their influence on the climate. (7) Climatic variations during historical times, particularly in northwestern Europe. Conclusions. Probable variations of climate in the future. R. H. Curtis considers 'An Improved Mounting for the Lens and Bowl of the Campbell-Stokes Sunshine Recorder,' by means of which the glass ball can be quickly and accurately placed centrally in the bowl, where it is secured by clamping screws. W. H. Dines contributes a paper on the 'Weekly Death Rate and Temperature Curves, 1890-1899,' which contains diagrams showing the death rate of the thirty-three great towns of England, and also curves of the temperature at Greenwich. The author is of opinion that from the health point of view the English climate is one of the best in the world. A pleasanter climate may easily be found, but the majority of health resorts to which Englishmen go in the winter have a higher death rate than London has at the same season, and a far higher rate than any of the country districts of the British Isles. A paper by H. Mellish discusses 'The Seasonal Rainfall of the British Isles.' The rainfall returns from 210 stations are analyzed for the twenty-five years, 1866-1890, and the percentage of the mean annual rainfall for each season is determined.

#### THE OLD YUMA TRAIL.

A STRIKING account of the history of 'The Old Yuma Trail' is given by McGee in the *National Geographic Magazine* for March. The part

played by the arid climate of the region is touched upon here and there, and the terrible loss of life along the Trail during the 'gold-fever renaissance' is thus described: "Many of the travelers were fresh from humid lands, knew naught of the deceptive mirage or the ever-hovering thirst-craze of the desert, and pressed out on the sand wastes without needful preparation. The roll will never be written in full, since most of the unfortunates left no records, scores leaving no sign save some bleaching bones; but observers estimate that there were 400 victims of thirst between Altar and Yuma within eight years, an estimate which so conservative a traveler as Capt. Gaillard thought fair, after he had 'counted sixty-five graves in a single day's ride of a little over 30 miles.'"

#### HANN'S LEHRBUCH DER METEOROLOGIE.

PUBLIC announcement is made of Dr. Hann's forthcoming 'Lehrbuch der Meteorologie,' a book upon which, as was known to his friends, the eminent meteorologist has been at work for some time. The volume is to be published by Tauchnitz, of Leipzig, and may now be subscribed for. It is to come out in eight successive instalments, costing 3 Marks each. Dr. Hann is so well known to scientific men the world over, through his admirable 'Handbuch der Klimatologie' and his many other shorter publications, that his new book, which is already assured a hearty welcome and a large sale, will be awaited with the greatest interest.

#### NOTES.

THE *National Geographic Magazine* for March contains a paper on 'The Sea Fogs of San Francisco,' which is an abstract of an article by A. G. McAdie in the *Monthly Weather Review* for last November. Five excellent half-tones accompany the paper.

THE *Bulletin of the American Geographical Society*, No. I., 1901, pp. 42-46, contains a paper by W. H. Alexander, Observer of the Weather Bureau, on 'St. Christopher, West Indies,' in which there are some statements concerning the climate.

THE full discussion of 'The Eclipse Cyclone and the Diurnal Cyclone,' by H. H. Clayton,



to which reference was made in these notes in SCIENCE for March 1, has appeared in Part I., Vol. XLIII., of the *Annals of the Harvard College Observatory* (pp. 33, pls. IV.).

R. DEC. WARD.

#### SCIENCE AND INDUSTRIAL COMPETITION.

Two small but very significant publications, recently issued from the press, will interest every intelligent citizen, and should particularly interest the man of science, the practitioner in applied science and, perhaps most of all, the always rare but always influential statesman.\* The one is a reprint of letters to the *London Times*, the 'Thunderer,' from an able and distinguished British engineer traveling in the United States and reporting to that paper upon the aspects of 'American Engineering Competition'; the other is a series of addresses and magazine articles by Professor John Perry, the able and original electrician and engineer, upon methods of teaching the sciences. There is possibly an important connection between the two seemingly diverse subjects.

The one describes the latest and best, as well as the most important, of American methods and apparatus of industrial production. The universal adoption of scientific methods; the extensive employment of the product of inventive genius; the utilization of applied science in any and every possible way in the promotion of the arts; the adoption of scientific methods of organization, of administration and of maintenance of the great systems of industry, of production, transportation and distribution; the universal faith in and practice of systematic and scientific processes of ore-production and transportation, of trans-shipment, of reduction; the manufacture of iron and steel, 'manufacturing,' all articles made of iron or steel rather than simply 'making' in older way; the part taken by automatic machines in the rapid transformation of the older into the newer system, with

\* 'American Engineering Competition,' being a series of articles resulting from the investigations made by the *Times*, London; N. Y. and Lond. Harper & Brothers, MDCCCXI. 8vo., p. 139. \$1.00. 'England's Neglect of Science,' by Professor John Perry, M. E., etc., London. T. Fisher Unwin, 1900. 8vo., p. 113. \$1.00.

resulting increase of product per man, and of wages, and yet with decreasing costs and prices: all these elements of industrial progress are discussed. The other sharply arraigns the English educator for his utter neglect of the applied sciences and for his indifference to their utilization in the life and work of the English people, and attributes the later relative retrograde movement of Great Britain in part, at least, to this neglect of science and to the greater activity and the statesmanlike policies and methods of education of Germany and the United States.

The one traces in a most admirably complete, yet condensed and succinct, way the great movements in the fundamental industries of the United States during the past decades and up to its recent astounding development of a foreign trade. It closes a most intensely interesting and instructive and suggestive discussion by two chapters on the labor question, which this author seems to think a much more important element in the relative decadence of Great Britain as a manufacturing nation than even that neglect of science which has awakened Professor Perry's most serious apprehensions. In the other book, that distinguished electrician criticises, not the science-teacher so much, nor even the leaders in the industrial systems of his country, but the members of his own profession who, as he thinks, are themselves indifferent to the progress of science and to its utilization for the benefit of their country and profession. He criticises the methods usual in teaching mathematics, that ultimate basis of all engineering, and discusses in his characteristically original and forceful manner the defect of technical education in England and the defects of such as is attempted. Outside the work of the Science and Art Department at Kensington, he finds apparently little to approve. For that department he has cordial words of praise. His discussion may be taken as an important supplement to John Scott Russell's famous work.\*

After reading these two little volumes one can hardly fail, however, to come to the conclusion that, while it is true that the American producer just now bursting into the field of

\* 'Systematic Technical Education,' London, 1869.

foreign consumption with his cheap but well-made 'interchangeable' wares, owes his seemingly meteoric success to applied science and in large part, in these later years, to the introduction into his manufacturing and transportation organizations of scientifically trained men, and while it is unquestionably the fact that Great Britain is suffering from neglect of science, and from the barbarous spirit and ignorance of her trades-unions, the real, the fundamental, element of difference probably lies behind all this. The ultimate cause of these developments of the United States which have so astonished the world is that perfect freedom, political and conventional, that freedom of the individual to mark out his own life and strive for his own highest goals, unhampered by governmental dictation or by bonds of caste, which has given the American citizen hope, ambition, purpose and effective energy. It is this which gave him invention, power of achievement, his patent laws, his legislation in behalf of essential industries, even his alert mind and his patriotism and love of country. It is this which has given us our common schools, which has promoted the organization of schools of the arts and trades and productive professions and the whole system of technical education and of industrially applied science. This has given our capitalist a new use for accumulated wealth in the endowment of schools of science and the promotion of education generally, has induced the adoption of organized industrial systems on such an enormous scale and has permitted the introduction of labor-assisting machinery without serious opposition on the part of those certain to be ultimately most benefited by the resultant increase of wages and decreased costs of product. Great Britain is still under the enslaving influences, in large degree, of convention and caste, and it is mainly this which lies at the bottom of her slow progress in the adoption of modern scientific methods, of improved systems and of extensive and intensive technical education.

Meantime, these two books will serve for the present as admirable summaries of progress to date and, later, will have great value historically.

R. H. THURSTON.

*THE MALARIA EXPEDITION TO NIGERIA.\**

THE detailed report of the expedition sent out to West Africa last year by the committee of the Liverpool School of Tropical Medicine has not yet been completed, but its main conclusions can now be given. The expedition was under the direction of Dr. H. E. Annett, demonstrator at the Liverpool School of Medicine. Its main objects were: (1) the exploration and investigation of the conditions under which malarial fever occurs and is conveyed to Europeans, (2) the possibility of adopting any preventive measures against the disease, and (3) the corroboration and extension of recent discoveries and researches on the subject. In Nigeria there are no large communities of Europeans such as at Lagos, Accra, Cape Coast and Sierra Leone, but there were from three to ten white men at each of the stations, with the exception of Old Calabar and Lokoja, where they number a hundred or more. The observations of the members of the expedition confirm the recent discoveries regarding the cause of malarial fever and more especially the part played by mosquitoes of the genus *Anopheles* as the carrier of the disease from an infected to a non-infected person. The examination of the blood of the natives themselves corroborated the work of Professor Koch in the East Indies, and of the members of the Royal Society's Commission on Malaria in West Africa, that the blood parasite which gives rise to malarial fever in man is carried by the mosquito from the native to the European—and more especially from the native children. The examination of the blood of hundreds of native children revealed the interesting fact that between 50 and 80 per cent. of those under five years, between 20 and 30 per cent. of ages between five and ten years, and a small percentage over ten years contained malarial parasites, often in very large numbers. The breeding places of the *Anopheles* were found to be chiefly the dug-out native canoes in the regions of the mangrove swamps, claypits and puddles in the forested district, and at Lokoja puddles and ditches on and alongside the roads and footpaths. It was particularly noticed everywhere how carelessness in the construction of roads and footpaths, and more es-

\* From the *London Times*.

pecially in the laying out of the areas surrounding the factories of the European traders was accountable for the production of a large number of breeding places for mosquitoes, which could easily have been avoided. In fact, it is certain that in West Africa such conditions are far more dangerous and more common than the proximity of a marsh or swamp, which is often noted as a cause of fever. Indeed, the mangrove swamp of West Africa has no direct relation to malarial fever, its presence only tending to predispose to a condition of general health rendering the subject more likely to the attack of disease in general. The observations of the members of the expedition lead them to very definite conclusions as to the methods to be adopted for the prevention of malarial fever among Europeans in West Africa. They consider that many of the methods which have been suggested are absolutely impracticable in West Africa—such as the universal dosing of infected persons with quinine for a period, the use of mosquito-proof houses, and of mosquito curtains, and the planting of trees of various kinds; although they are of opinion that such measures among an intelligent and obedient community may be of some efficiency. The two methods upon which alone any reliance can be placed as measures for prevention are (1) segregation of Europeans from natives of all sorts, at a distance of about half a mile; and (2) complete and efficient surface drainage of the whole district in the immediate neighborhood of European quarters. The adoption of these methods in many of the places visited by the expedition would be, even now, easy; in others, especially in the larger towns, it would involve considerable difficulty; but in the stations likely to be made in Nigeria in the near future their adoption would lead to the formation of malaria-free habitations.

#### CONCILIIUM BIBLIOGRAPHICUM.\*

THE beginning of the twentieth century marks a new period in the history of the Concilium Bibliographicum. It is now just ten years since the origin of the movement

\* From the general statement for 1900.

which led in 1895 to the official foundation of the institution by the vote of the Third International Congress of Zoology.

Means were provided for carrying on the work for a preliminary period of five years, in order to determine whether the project could be made a success. The experimental stage is now passed and the verdict of all those who know the work well is that the high hopes entertained for the undertaking have been completely justified.

#### NUMBER OF CARDS PUBLISHED.

	1896	1897	1898	1899	1900	Total
Zoology, systematic.....	3345	2291	7539	7960	8452	29587
Zoology, topical.....			7583	8434	7877	23894
Zool., alphabet. (cross-references).....				350	1256	1606
Anatomy.....		583	1857	936	1875	5251
Physiology.....		150	1230*	1270	433	3083
	3345	3024	18209	18950	19893	63421

A recent report of the Swiss Society of Naturalists endeavors to estimate in a specific case the saving of time afforded by the card catalogue in obtaining references to recent publications in regard to the trout. The saving is estimated at half a day. But in regard to other cases the saving is far greater. Let any zoologist familiar with past bibliographical resources consider how he would go to work to ascertain what has been published in the past five years in regard to some minute question, such as the fauna of Sumatra. A moment's reflection will suffice to show that it would be a task of many weeks to obtain an answer to such a question. Yet a subscriber to the faunistic part of the bibliography of the *Concilium* would only require a few seconds to find 62 publications dealing with the question. The titles of ten of these publications would, it is true, bear no mention of Sumatra; they are classed here because on perusing the text important references to Sumatra were found. Some, indeed, bear titles that would seem absolutely to preclude any notes on the fauna of Sumatra, as, for example, a work on 'The Insects of Germany.' Subscribers to any considerable portion of the bibliography would have received these references for 80 centimes (8d. or 16 cents), and any per-

\* An error was made in this item in our last annual statement, which we now correct.

son, whether a subscriber or not, could receive the information for 3 fr. 10 (2s. 6d. or 62 cents). Surely no comment is necessary to prove the value of the work nor the extreme cheapness of the service.

The gradual success of the work from a scientific standpoint has led to a corresponding improvement of the financial status of the work. For the first three experimental years there was an average annual deficit uncovered by the subsidies of Frs. 5625, while for the last year this deficit had fallen to Frs. 224.

All this has now induced the Swiss Government to take a step which decided the entire future of the enterprise. By a recent vote of parliament its subsidy is increased fivefold, and arrangements are being made to give the work permanence by making it independent of the person of the present director.

In the past year great progress has been made towards bringing the bibliography up to date. For certain departments it is already the most complete bibliography in existence. At present the malacological department, which had been far behind, is being brought up to the standard of excellence maintained by the whole. Later, attention will be given to protozoa and worms, especially as regards notes contained in medical journals, and finally ornithology will follow.

The anatomical bibliography has recently received renewed attention. Indeed the number of titles is more than double that issued in the previous year and yet they form but a small part of the extensive manuscript now ready for publication. The publication of the physiological bibliography, on the other hand, has been suspended and can not be resumed for two or three months, in consequence of technical difficulties which can only be overcome by the purchase of new machinery. This unfortunately can not yet be obtained from the factory. In the meantime a complete set of guide-cards has been published.

The Concilium owns a manuscript card catalogue of new genera and species (including new names) which are recorded as soon as published. From 1901 on, copies of any part of this catalogue may be obtained at the uniform charge of 10 centimes per entry (minimum 50 centimes). Since the cards are arranged faun-

istically as well as systematically, most diversified orders can now be received, *e. g.*: New genera and species of trichoptera, of bombycids, etc., new genera and species described from the Cape Colony, from the Philippines, from Texas, from Perthshire, etc., new reptiles from Japan, or simply new species of *Carabus* or any other genus.

The usefulness of a card catalogue depends largely on its being properly mounted and supplied with guide-cards. The sets of guide-cards issued in previous years are described in a special circular. A description of the new card cabinets of the Concilium is also the object of a special pamphlet. American subscribers would find it, however, more profitable to turn to the well-known Library Bureau.

The cards thus far published have been taken from no less than 1,576 periodicals. A list of journals showing precisely what volumes and numbers have been excerpted is in preparation and will, it is hoped, soon be issued. Experiments are being tried with a view to opening new facilities of subscription in regard to the great faunistic areas. But above all, our program for 1901 is to render the references more complete and to approach more nearly our final aim, which is to *remove the entire burden of bibliographical research from the shoulders of the working biologist.*

In closing, we wish to thank especially the Swiss Government and the Elizabeth Thompson Science Fund for their generous support in the past, without which none of this work could have been carried on.

#### SCIENTIFIC NOTES AND NEWS.

DR. H. A. ROWLAND, professor of physics in the Johns Hopkins University, died suddenly on April 16th.

PROFESSOR J. WILLARD GIBBS, of Yale University, has been elected an honorary member of the London Physical Society.

THE University of St. Andrews conferred its LL.D. on Mr. Alexander Agassiz, of Harvard University, in April. Mr. Agassiz returned from his visit abroad last week.

THE Board of Visitors to the U. S. Naval Observatory held its first meeting at Washing-

ton last week, with all the members in attendance. Professor Young, of Princeton University, was elected Chairman and Professor Stone, of the University of Virginia, Secretary. The members of the Board were received by President McKinley. They visited the observatory, and held a number of sessions, but the proceedings have not been made public.

At the last meeting of the Rumford Committee of the American Academy of Arts and Sciences a grant of \$300 was awarded to Professor Arthur A. Noyes in aid of a research on the effect of high temperatures upon the relative conductivity of aqueous salt solutions.

DR. W. KARAWAIEW has been appointed director of the zoological station at Sebastapol.

THE Washington Academy of Sciences has announced for Wednesday, April 17th, at 8:15 P. M., a lecture in honor of the National Academy of Sciences by Professor Alpheus Hyatt on 'A New Law of Evolution.'

\* THE spring lectures before the Royal Institute, London, include: Dr. Allen Macfadyen, six lectures on 'Cellular Physiology,' with special reference to the enzymes and ferments; Professor Dewar, three lectures on the 'Chemistry of Carbon'; Professor J. B. Farmer, two lectures on the 'Biological Characters of Epiphytic Plants,' and Mr. J. Y. Buchanan, three lectures on 'Climate, its Causes and Effects.' The Friday evening meetings will be resumed on April 19th, when a discourse will be delivered by Professor J. J. Thomson, on the 'Existence of Bodies Smaller than Atoms.'

As we have already announced, Mr. J. H. H. Teall has succeeded Sir Archibald Geikie as director-general of the British Geological Survey. *Nature* now announces the following further changes in the staff: Mr. H. B. Woodward to be assistant director (for England and Wales), and Mr. John Horne to be assistant director (for Scotland); Mr. C. Fox Strangways, Mr. Clement Reid and Mr. Aubrey Strahan to be district geologists for England and Wales; Mr. B. N. Peach and Mr. W. Gunn to be district geologists for Scotland, and Mr. G. W. Lamplugh to be district geologist for Ireland.

PROFESSOR RUDOLPH VIRCHOW will be eighty years old on the 13th of October. When he celebrated his seventieth birthday, a fund was collected in his honor for the endowment of scientific research, and a committee has now been appointed to increase this fund as a further testimonial to Germany's greatest living man of science. It is intended that the testimonial shall be international, and a committee has been appointed in America consisting of Charles A. L. Reed, President of the American Medical Association; Henry P. Bowditch, President of the Congress of American Physicians and Surgeons; William H. Welch, Johns Hopkins University; Robert F. Weir, President of the New York Academy of Medicine; A. Jacobi, 110 West 34th Street. To Dr. Jacobi, who is secretary of the committee, subscriptions may be sent.

THE Geographical Society of Leipzig has made the first award of its Edward Vogel gold medal to Professor Schweinfurth, of Berlin. The Society has elected as honorary members: Professor Penck, of Vienna; Professor von den Steiner, of Berlin, and Dr. Alph-Stuebel, of Dresden.

KING EDWARD has consented to become patron of the Royal Institution, London.

PROFESSOR BRANNER, of the University of California, has sent us an extract from the *Southern Cross*, a newspaper published at Buenos Ayres, which gives a description of the unveiling of a monument in honor of the geologist, Burmeister, lately director of the National Museum in Calle, Peru. The monument is the work of the German sculptor, Aigner, and was erected by public subscription at a cost of \$12,000. The statue, which is of marble on a large pedestal, represents Burmeister seated, holding a mineralogical specimen in his right hand. Commemorative addresses were made by the minister of public instruction and others.

WE record with much regret the death of Dr. William Jay Youmans, which occurred on April 10th, at Mt. Vernon, at the age of sixty-two years. Dr. Youmans, after a thorough education in science and medicine, joined his brother in the establishment of the *Popular Science Monthly* in 1872, and was editor-in-chief

of that journal after the death of his brother in 1887, until last year. In the editorship of the *Monthly* and in many other directions Dr. Youmans did much for the diffusion and advancement of science in America.

We also regret to record the death of Professor John Thomas Duffield, for more than forty years professor of mathematics in Princeton University. He was born in Pennsylvania in 1823, and graduated from Princeton College in 1841, where he was first appointed tutor in Greek and in 1847 adjunct professor of mathematics. Dr. Duffield was the author of various publications on religious and mathematical subjects.

Mr. ARTHUR COPPEN JONES died, at Davos, on March 8th, at the age of thirty-five years. Mr. Jones studied under Huxley at the Royal School of Mines, but was compelled to go to the Engadine when only 20 years old, owing to an attack of tuberculosis. When his health improved, he studied bacteriology and was the author of a paper advocating the view that the tubercle bacillus is a fungus. He translated Fischer's 'Structure and Function of Bacteria,' recently issued from the Clarendon Press.

DR. FRANZ MELDE, professor of physics in the University at Marburg, died on March 16th at the age of sixty-eight years.

MRS. EMMA FLOWER TAYLOR, daughter of the late Roswell P. Flower, has given \$60,000 to Watertown, N. Y., for a public library in memory of her father.

THE committee, appointed by the International Congress of Geologists on the 25th, of August last, has announced as the subject proposed for the Spendiarioff prize for 1903 'A Critical Review of the Methods of Classification of Rocks' (*Revue critique des méthodes de classification des roches*). The value of the prize is 456 roubles or about \$240. Manuscripts should be addressed to M. Charles Barrois, secrétaire général du Congrès Géologique International, 62, boulevard Saint Michel, Paris. At least two copies of papers submitted in competition are required, and they should be sent, at the latest, a year before the next session of the Congress in 1903.

PROFESSOR TODD writes from Port Said on

March 25th, stating that the expedition sent from Amherst College under his direction to observe the eclipse of the sun in the Dutch East Indies, has reached that point two days ahead of his ephemeris and should be in Singapore on or before April 15th. The station for this observation of the eclipse is likely to be the little island of Sinkop, one of the lesser dependencies of the Sultan of Rhiow, about a day's journey southeast of Singapore. In addition to Professor Todd's apparatus for photographing the corona, which is partly automatic, Dr. Wright, of Yale, has provided an equipment of apparatus for determining the photographic polarization of the corona.

AN expedition to Samoa and the Pacific Islands for the study of mosquitoes in relation to the diseases which they bear has been planned at the instance of Dr. Patrick Manson. The sum of \$5,000 has been subscribed anonymously and it is hoped that the British Government will assist. The *Lancet* states that here the investigators would set themselves to study the local mosquito, and, having obtained full knowledge of its habits, they would proceed to investigate the mosquitoes of an island in which malaria is endemic. They are then to convey the *anopheles* from the malarial to the non-malarial island and to endeavor there to breed the *anopheles* under laboratory conditions. In the aquarium thus formed there would be introduced certain plants and animals which are apparently peculiar to Samoa with the view to discover, in one or another of these, something antagonistic to the *anopheles*. The experiment would then be repeated under conditions as nearly natural as might be possible. Dr. Manson hopes that by this means there may be discovered a something which is hostile to the *anopheles*, and which may be subsequently turned to good account by being introduced into islands and localities where malaria is epidemic. The Pacific islands were suggested by Dr. Manson from the fact that they also afford unique opportunities for the study of filariasis and elephantiasis. In many of the islands this latter disease attacks from 20 to 50 per cent. of the population, and in others filariasis attacks from 30 to 60 per cent. But there are also small islands with populations of

from 200 to 300 in which elephantiasis is alleged not to exist, while there are other islands, equally small in population, where almost every individual is affected.

THE *Princeton Alumni Weekly* states that another geological expedition to the far West is projected for next summer, for the purpose of adding to the very valuable collections already in the university museums, a large part of which have been gathered by this means during the last twenty-five years. Ten or a dozen upper classmen are expected to compose the party, besides Dr. M. S. Farr, '92, the new curator of vertebrate paleontology, who will be in command, since Professor W. B. Scott, '77, who has led so many of these expeditions, expects to be in South America next summer. Southern Montana will be the principal field of exploration, though, after two months of research, the party will have a pleasure trip of two or three weeks in the Yellowstone National Park. Dr. Farr expects to go out to Montana about the middle of May to make the arrangements, the other members of the party following after commencement.

THE American Physical Society will hold its next meeting in New York City, on April 27th. The program committee is Professors J. S. Ames, M. I. Pupin and Ernest Merritt.

THE Secretary of the National Educational Association, Mr. Erwin Shepard, has sent out a notice stating that the arrangements for the fortieth annual convention at Detroit next July are progressing satisfactorily. The hotels have agreed not to advance their rates and accommodations for ten thousand teachers are being secured in private houses. The official program will be issued on May 1st.

THE eighteenth annual meeting of the American Climatological Association will be held at Niagara Falls on May 30th and 31st and June 1st. The program includes a special discussion on the home treatment of tuberculosis.

THE Congrès des Sociétés Savantes held last week its annual conference at Nancy. Various geological and archeological explorations have been arranged to follow the Congress.

THE inaugural meeting of a society for the

study of psychology by experimental methods was held in London on April 16th.

THE Anatomical Society of Great Britain and Ireland will hold its summer meeting at Leeds on July 5th and 6th.

THE spring meeting of the Iron and Steel Institute of Great Britain will be held on Wednesday and Thursday, May 8th and 9th, at the Institution of Civil Engineers, London. The retiring president, Sir William Roberts-Austen, will introduce the president-elect, Mr. William Whitwell, who will deliver an inaugural address. The Bessemer Gold Medal for 1901 will be presented to Mr. J. E. Stead. The autumn meeting of the Institute will be held in Glasgow on September 3d and following days.

THE U. S. Fish Commission will make an elaborate exhibit at the Buffalo Exposition, and this is now being arranged by Mr. W. de C. Ravenel, assistant in charge of the division of Fish Culture. There are to be fifty tanks containing fresh and salt water fishes shown as nearly as possible in their natural surroundings. Hatcheries will be in operation throughout the entire summer. There will also be a full exhibit of methods of fishing and of the products of fisheries, including the secondary products, such as oil, shells, skins, etc.

WE learn from the *British Medical Journal* that the Institute of Tropical Medicine established by the Senate of Hamburg, with the support of the German Empire, will shortly be in working order. It is housed in the Old Seamen's Hospital, Hamburg. The director of the Institute is Dr. Nocht, formerly port medical officer of Hamburg. He did admirable service to Hamburg in the cholera epidemic of 1892. He was formerly a surgeon in the German army, and afterwards worked under Professor Koch in the Institute of Hygiene at Berlin. Dr. Nocht has made original researches on the parasitology of malaria. He will have as his assistant in his new office Dr. Ollwig, who accompanied Professor Koch in his tropical expedition.

A MUSEUM of ethnology has been established at the University at Breslau, through the efforts of Dr. Thilenius, professor of anthropology and ethnology\*.

IN connection with the Munich veterinary school, a station has been established for the study of the diseases of fishes.

PLANS for the lion house of the New York Zoological Park have been approved by the executive committee of the Zoological Society.

SIR JOHN MURRAY, who has just returned from a six months' expedition to Christmas Island, during which he crossed the island from end to end—the first occasion on which it has been traversed—has made a statement with reference to his travels to a representative of Reuter's Agency. Christmas Island, which is situated in the Indian Ocean, is 220 miles from the nearest land, and is some 12 miles long by seven broad. It is covered with dense forest, having an area of nearly 50 miles, and the sea depth around its shores is between three and four miles. There is no good anchorage, but only an open roadstead. When Sir John Murray was on the island there were 13 whites, including a doctor, chemist and engineer, living there with their families, together with 720 Indian coolies engaged in working the rich phosphate deposits. The animals and plants on the island are of extreme interest. The whole place is overrun with curious red crabs as much as 18 inches across. They are excellent tree climbers, and once a year there is a regular migration of these crustaceans, who travel in bodies like ants, taking 15 days on the journey, and returning inland after hatching their eggs. There are only five mammals on the island, including two species of rat not known elsewhere. They are of two colors, those on the plateau being brown, while those nearer the coast are black, and in order to keep them down a number of terriers have been imported. On the island are also to be found a toothless snake and a blind snake much like a worm. In exploring the island Sir John Murray had to cut a track through the dense forest until he reached the central plateau at an altitude of 1,000 feet, where traveling was not so difficult. One night he got lost in the forest, and had to subsist on the tops of sago palms, which he cut down. The island is under the Straits Settlements Government, and a resident magistrate has just been despatched thither from Singapore, together with an official of the

Public Works Department, a scientific commission, and a force of police, 35 in all. They will select sites for the administrative buildings to be erected on the island. The climate is perfect, like a hot English summer, and prior to the British annexation no human being is supposed to have lived on the island.

THE annual general meeting of the Chemical Society was held at Burlington House, London, on March 28th. Professor T. E. Thorpe, the president, made an address in the course of which he said according to the *London Times*, that they were proud to think that the Society, in so far as it had administered to the progress of chemistry, might have contributed in some measure to the luster of the reign which had been eminently associated with the spread of science. They had never been unmindful of what their science owed to the royal family, and in particular to the late Prince Consort. They entered on the 20th century mustering 2,368 members, including 33 foreign members. Since the last anniversary 182 communications had been made to the Society, a number greater than that of any preceding year. The volumes published in 1900 by the Society contained 3,758 abstracts of papers, which had appeared mainly in continental journals. For some time past their sister society in Berlin had had under consideration the desirability of establishing, with the cooperation of the various chemical societies in Europe and America, a uniform system of atomic weights. The committee appointed by the Society had decided to recommend that  $O = 16$  be taken as the basis of calculation of atomic weights, and that in assigning a number as the atomic weight of any element only so many figures should be employed that the weight might be regarded as accurately known to one unit in that figure. Some discussion had taken place with regard to the time of the Society's meetings, and the council had decided provisionally to hold the meetings during the coming session at 5:30 P. M. on the first and third Wednesdays of the month. Professor Reynolds J. Emerson was elected president for the ensuing year.

A DESPATCH from New Orleans to the daily papers states that the investigation made by Professor Beyer for the American Ornithologi-



cal Association of the Louisiana Gulf Coast for the purpose of stationing wardens to protect the sea birds shows that action was not taken a moment too soon. Professor Beyer found that nearly all the breeding places of the birds had been destroyed by killing the birds themselves and taking their eggs. Not a trace of birds was found on either Brush or Caillou islands, at one time the home of millions of sea-fowl. The same was true of Calumet and Castelle islands, on which every living thing had been killed. A few gulls and hens were found left on Timbalier Island, and there are said to be a few on Last Island which, however, could not be visited on account of the severe weather. Wardens were appointed wherever birds were found and the fishermen of the neighborhood promised to cooperate with the wardens in preventing the killing of the birds in the breeding season and the stealing of eggs.

THE report of the British Consul at Naples for the past year, as summarized in the *London Times*, describes the recent progress of the Marine Zoological Station in that city, 'the mother of all similar scientific establishments in the world.' Its progress has continued with undiminished activity, and the number of biologists of all nationalities who have carried out their investigations there has largely increased. During the past two years 63 and 71 scientists respectively have availed themselves of the opportunities of research afforded by it. Among other students at the station there has been a regular succession of naval officers sent by the Italian, Russian, German and Spanish governments for the purpose of undergoing a course of training in the commoner methods employed in capturing, investigating and preserving marine organisms. The work done at the station is for the most part of purely scientific interest, but a great many of the contributions to science are of great and immediate practical value. A report of great scientific and economic value has been prepared by the Cavaliere Lo Bianco, the permanent naturalist attached to the station. It contains the results of many years' assiduous study of the seasons of the year at which the animals, as distinguished from the plants, which inhabit the Bay of Naples, breed.

THE Royal Irish Academy has this year taken a step, says *Nature*, which will, it is hoped, still further establish its position in Ireland, and in the world of sciences and letters in general. It has adopted the principle of the by-laws of the Royal Society of London, respecting the mode of election of members; the council is now empowered to select a number of persons, not exceeding twelve, in each year, from the list of candidates for membership proposed, and to recommend these to the body of members for election. The members may, at the single annual meeting at which elections now take place, substitute the name of any candidate already proposed for that of any candidate selected by the council; but the number of candidates elected must not be greater than that fixed by the council for that particular year. Changes have been also made in the by-laws so as to provide for the more frequent introduction of new blood into the council. The position of the Royal Irish Academy becomes at the same time defined in relation to the other great medium of scientific publication and intercourse in Dublin, the Royal Dublin Society. While the latter, by its objects and foundation, must be to a large extent a popular institution, performing its important public functions and scientific work by the support of an extensive body of members, the Royal Irish Academy is able, on the other hand, to maintain its membership as a distinction, and to attract to itself, by this circumstance, those who are mainly concerned with the furtherance of research.

PARTICULARS in regard to the research scholarship founded by Mr. Andrew Carnegie in connection with the Iron and steel Institute of Great Britain, of which association Mr. Carnegie is a vice-president are given in the *London Times*. For this scholarship Mr. Carnegie presented to the institute twenty two \$1,000 Pittsburg, Bessemer and Lake Erie Railroad Company 5-per-cent. debenture bonds, the income derived from which will be applied to awarding annually one or more scholarships of such value as may appear expedient to the council of the institute. The awards will be made on the recommendation of the council irrespectively of sex or nationality. Candidates, however, must be under 35 years

of age, and application must be made on a special form to the secretary of the institute before the end of April in every year. The scholarships will be tenable for one year, but the council will be at liberty to renew them for a further period if thought desirable instead of proceeding to new elections. The object of this scheme of scholarships is not to facilitate ordinary collegiate studies, but to enable students who have passed through a college curriculum, or have been trained in industrial establishments, to conduct researches in the metallurgy of iron and steel and allied subjects, with the view of aiding its advance or its application to industry. It is suggested that the National Physical Laboratory—on the governing body of which the Iron and Steel Institute is represented—would for many reasons be a very suitable establishment in which such a research could be carried out. There is, however, no restriction as to the place of research that may be selected, whether university, technical school, or works, the only absolute condition being that it shall be properly equipped for the prosecution of metallurgical investigations. The results of the researches are to be communicated to the Iron and Steel Institute in the form of a paper to be submitted to the annual general meeting of members. If the paper appears to the council to be sufficiently meritorious the author will be awarded the Andrew Carnegie gold medal. The awarding of the medal in any year, however, will not be obligatory, but will depend upon a paper of sufficient merit being communicated.

IN reply to those who have signed a petition objecting to the opening of the Edinburgh Museum of Science and Art on Sunday afternoons, Lord Balfour has written: "In point of principle I am unable to agree that a visit to a museum is a contravention of any divine law. If a citizen of Edinburgh may not go to a museum, by what right does any one of us enjoy a walk in our own or somebody else's garden? In deciding the practical question, I think we must keep in view the extent of the innocent gratification as well as improvement offered to those whose opportunities for both are otherwise limited. I believe that in these respects the

advantages will be very great as compared with the amount of labor involved. Having regard to this, and bearing in mind the resolution of the House of Commons, I had but little difficulty in coming to the conclusion that it was my duty to decide the question of Sunday opening in the case of the Edinburgh Museum in the way I have done. I did not arrive at that conclusion without careful and anxious consideration, and I cannot hold out any hope that it will be reconsidered unless and until experience of its working in Edinburgh supplies proof that slight use is made of the opportunity offered or that its consequences are in some way detrimental to the public interests."

#### UNIVERSITY AND EDUCATIONAL NEWS.

By the will of the late Mrs. Josephine L. Newcomb, Tulane University will receive a large sum, said to be \$2,000,000, for the Sophie Newcomb College for Women.

Mrs. P. D. ARMOUR and her son Mr. J. Ogden Armour have given \$1,000,000 to the Armour Institute, Chicago. This endowment will be used, it is said, to extend the work of the Institute in the direction of electrical engineering and chemistry.

THE daily papers report that the endowment fund of \$1,000,000 for the Johns Hopkins University has been practically collected and that the donors will be announced on May 1st. It is also said that President Gilman's successor will be announced at that time.

MR. JOHN B. GILFELLAN, of Minneapolis, has given the University \$50,000 for the assistance of poor students.

CREIGHTON UNIVERSITY at Omaha, Nebr., has received \$75,000 from Mr. John A. Creighton for a new building.

THE Board of Regents of the University of Minnesota has approved the recommendation of the faculties abolishing the degrees of bachelor of philosophy and bachelor of science, the degree of bachelor of arts being hereafter given for all liberal studies.

MISS LAURA D. GILL will be installed as Dean of Barnard College on May 1st. A gift of \$5,000 to the College from Mr. Jefferson Seligman has been announced.

# SCIENCE

A WEEKLY JOURNAL DEVOTED TO THE ADVANCEMENT OF SCIENCE, PUBLISHING THE OFFICIAL NOTICES AND PROCEEDINGS OF THE AMERICAN ASSOCIATION FOR THE ADVANCEMENT OF SCIENCE.

EDITORIAL COMMITTEE: S. NEWCOMB, Mathematics; R. S. WOODWARD, Mechanics; E. C. PICKERING, Astronomy; T. C. MENDENHALL, Physics; R. H. THURSTON, Engineering; IRA REMSEN, Chemistry; JOSEPH LE CONTE, Geology; W. M. DAVIS, Physiography; HENRY F. OSBORN, Paleontology; W. K. BROOKS, C. HART MERRIAM, Zoology; S. H. SCUDDER, Entomology; C. E. BESSEY, N. L. BRITTON, Botany; C. S. MINOT, Embryology, Histology; H. P. BOWDITCH, Physiology; J. S. BILLINGS, Hygiene; WILLIAM H. WELCH, Pathology; J. MCKEEN CATTELL, Psychology; J. W. POWELL, Anthropology.

FRIDAY, APRIL 26, 1901.

CONVOCATION WEEK.

## CONTENTS:

<i>Convocation Week</i> .....	641
<i>The National Academy of Sciences</i> .....	643
<i>The Social Service of Science</i> : PROFESSOR WILLIAM HARMON NORTON.....	644
<i>The Gravity Measures of Europe and of the United States</i> : DR. JOHN F. HAYFORD.....	654
<i>The American Institute of Electrical Engineers</i> : W. C. ANDREWS.....	655
<i>Scientific Books</i> :—	
<i>Kölliker's Erinnerung aus meinen Leben</i> : PROFESSOR CHARLES S. MINOT. <i>Eckstorm's Bird Book</i> , and <i>Woodpeckers</i> : C. F. B. STILLMAN'S <i>Engineering Chemistry</i> : PROFESSOR W. A. NOYES. <i>Classen's Method of Analytical Chemistry</i> : PROFESSOR H. P. TALBOT.....	657
<i>Scientific Journals and Articles</i> .....	661
<i>Societies and Academies</i> :—	
<i>Section of Anthropology and Psychology of the New York Academy of Sciences</i> : DR. R. S. WOODWORTH. <i>Geological Society of Washington</i> : DR. F. L. RANSOME and DAVID WHITE. <i>Chemical Society of Washington</i> : DR. L. S. MUNSON. <i>Philosophical Society of Washington</i> : C. K. WEAD, JOHN F. HAYFORD. <i>Anthropological Society of Washington</i> : DR. WALTER HOUGH. <i>The Academy of Science of St. Louis</i> : PROFESSOR WILLIAM TRELEASE. <i>The Elisha Mitchell Scientific Society</i> : PROFESSOR CHAS. BASKERVILLE.....	662
<i>Discussion and Correspondence</i> :—	
<i>Oil in Texas</i> : PROFESSOR G. D. HARRIS. <i>Disclaimer No. 2</i> : PROFESSOR E. F. BUCHNER AND OTHERS.....	666
<i>Shorter Articles</i> :—	
<i>The Development of the Pollen Tube and Fertilization in Pines</i> : MARGARET C. FERGUSON.....	668
<i>Notes on Entomology</i> : NATHAN BANKS.....	668
<i>Working of Patents Acts</i> : PROFESSOR R. H. THURSTON.....	669
<i>A Mineral Survey of Texas</i> : PROFESSOR FREDERIC W. SIMONDS.....	671
<i>Proposed Survey of the Antiquities of Michigan</i> .....	672
<i>The Davenport Academy of Science</i> .....	672
<i>The Statistical Study of Biological Problems</i> .....	673
<i>The School of Pedagogy of New York University</i> .....	674
<i>Scientific Notes and News</i> .....	675
<i>University and Educational News</i> .....	680

THE action of the Association of American Universities recommending the adoption of a 'convocation week' to permit learned societies to hold their meetings at some other period than during the summer vacation has already been reported in these columns. The action was taken in consequence of the request made officially to the Association by the committee appointed by the American Association for the Advancement of Science. The vote determining the recommendation was unanimous, and has now been reported formally to the fourteen universities which are members of the Association making the recommendation. The next step must be the adoption of the plan by our higher educational institutions. It is therefore desirable that all scientific men should understand the project, which may properly claim universal support.

The week proposed is that in which January 1st falls. In some universities, as for example Yale, this week is already included in the regular vacation, so that for them no change is involved. Many universities have already a vacation beginning just before Christmas and extend-

ing to the second or third of the following January. For them the changes will be slight. In those cases in which the two or three days involved cannot, in the opinion of those deciding, be spared, it will probably be practicable to shorten correspondingly one or more of the vacations at other periods of the year. As regards the few colleges and technical schools which do not have the usual Christmas vacation, it may be suggested that it will suffice to vote to grant leave of absence during convocation week to those who desire to attend the society meetings, and perhaps later, when the 'week' has an assured and clearly permanent place these institutions, will conform to what will then be a recognized as a prevailing custom.

Columbia University has the honorable distinction of being the first to adopt the important innovation, and has already changed its calendar for 1901-1902, setting free the week of January first for convocation purposes. It is expected that several other universities also will soon announce their adherence to the plan, and it is hoped that in a short time the majority of American and Canadian universities will adopt the recommendation under consideration.

The reasons for asking for the establishment of a convocation week are obvious, since they are the direct outcome of conditions and experiences which are distinctly American and are familiar to all.

The general proposition that annual meetings of scientific men are desirable requires no demonstration. Every one realizes that, after remaining a long time within the circle of his own university, it is im-

mensely stimulating to meet with a number of other men, pursuing the same branch of science. Moreover, the oral presentation of the results of investigation has certain real advantages over the written form, while the informal discussions at meetings are frequently worth more than the whole cost and trouble of attendance. The gain in these ways and many others is so great for the professors that it must be considered an important part of sound university policy to encourage and promote attendance at scientific meetings, since thereby a university can easily, and often greatly, increase the value of its teaching staff.

It is to be recalled next that attempts to hold meetings in summer time encounter difficulties so serious that such attempts are and can be only partially successful. It is the conviction that this difficulty is great and without remedy which has led the American Association for the Advancement of Science to wish to change its time of meeting to the winter season. It accordingly appointed a committee to take necessary action for this purpose. The committee, of which Dr. Minot is chairman and Professor Cattell secretary, is constituted by Charles S. Minot, President-Elect; R. S. Woodward, President; L. O. Howard, Permanent Secretary; E. L. Nichols and J. McK. Cattell.

The tropical character of the American summer has led to the gradual extension of the national custom of scattering to mountain, seashore and country, and those connected with universities utilize the long vacation to settle down in a summer home, from which it is more than difficult to en-

tice them. It must be further remembered that all those whose studies are with nature—the geologists, botanists, zoologists, anthropologists and others—use the summer for their expeditions, so that for many of them attendance at summer meetings is impossible.

On the other hand, there has grown up within the last dozen or fifteen years the custom of holding meetings of learned societies during the brief Christmas holidays. The first society to adopt this time for its gathering was the American Society of Naturalists, which held its first December meeting in New York, in 1883. Since then a number of other societies, more or less national in scope, have been formed and hold their meetings during the same period. We may mention among scientific societies the following :

- The American Society of Naturalists.
- The American Morphological Society.
- The Association of American Anatomists.
- The American Bacteriological Society.
- The American Physiological Society.
- The American Psychological Association.
- The American Folklore Society.
- The American Society of Plant Morphology and Physiology.
- The Anthropological Section of the American Association.
- The Geological Society of America.
- The American Chemical Society.
- The American Mathematical Society.
- The American Physical Society.

All these societies, we think, without exception, have found from experience that the Christmas holidays are a convenient time for their meetings, except in one respect—that the time is too short, especially when Christmas day falls on a Wednesday or Thursday, for then Sunday falling half way between Christmas and New Year, it is

impracticable to get more than two days for a meeting, and two days, as we have all learned, is far too brief a time for our needs.

These circumstances point obviously to the lengthening of the Christmas vacation past New Year as the remedy, hence the selection of the week in which the first of January falls as 'convocation week.'

Should the proposition be carried out, it will afford an opportunity for the elevation of science in America of inestimable value and will be a contribution to the advancement of learning in all its branches, well worthy to initiate the progress of the new century.

#### THE NATIONAL ACADEMY OF SCIENCES.

THE annual stated session of the National Academy of Sciences was held in Washington, April 16 to 18 inclusive. The following papers were read :

- 'The Climatology of the Isthmus of Panama': HENRY L. ABBOT.
  - 'The Effects of Secular Cooling and Meteoric Dust on the Length of the Terrestrial Day': R. S. WOODWARD.
  - 'The Use of Formulæ in demonstrating the Relations of the Life History of an Individual to the Evolution of its Group': ALPHEUS HYATT.
  - 'Artificial Parthenogenesis and its Relation to Normal Fertilization': E. B. WILSON.
  - 'Simultaneous Volumetric and Electric Graduation of the Condensation Tube': CARL BARUS.
  - 'Table of Results of an Experimental Enquiry regarding the Nutritive Action of Alcohol, prepared by Professor W. O. Atwater, of Middletown, Conn.': Presented by J. S. BILLINGS.
  - 'The Significance of the Dissimilar Limbs of the Ornithopodous Dinosaurs': THEO. GILL.
  - 'The Place of Mind in Nature': J. W. POWELL.
  - 'The Foundation of Mind': J. W. POWELL.
  - 'Conditions Affecting the Fertility of Sheep and the Sex of their Offspring': ALEXANDER GRAHAM BELL.
  - 'The New Spectrum': S. P. LANGLEY.
- Mr. Alexander Agassiz, of Cambridge, Mass., was elected president of the Acad-

emy; Professor Ira Remsen, Baltimore, Md., foreign secretary; Mr. Arnold Hague, Washington, D. C., home secretary—each for a term of six years. The following were elected additional members of the council for the ensuing year: J. S. Billings, G. J. Brush, H. P. Bowditch, Arnold Hague, Simon Newcomb, L. P. Langley.

Five new members were elected as follows:

George F. Becker, U. S. Geological Survey, Washington, D. C.

J. McKeen Cattell, Professor of Psychology, Columbia University, New York City.

Eliakim H. Moore, Professor of Mathematics, University of Chicago, Chicago, Ill.

Edward L. Nichols, Professor of Physics, Cornell University, Ithaca, N. Y.

T. Mitchell Prudden, Professor of Pathology, College of Physicians and Surgeons, Columbia University.

The following were elected foreign associates:

J. Janssen, Director of the Observatoire d'Astronomie Physique, Meudon, France.

Mr. Loewy, Director of the Observatoire de Paris, Paris.

E. Bornet, of the Section of Botany of the Paris Academy of Sciences.

Hugo Kronecker, Professor of Physiology in the University of Bern.

A. Cornu, Professor of Physics, École polytechnique, Paris.

F. Kohlrausch, Professor of Physics at the University of Berlin.

Sir Archibald Geikie, recently Director of the Geological Survey of Great Britain.

J. H. van't Hoff, Professor of Chemistry in the University of Berlin.

The Henry Draper medal was awarded to Sir William Huggins, of London, for his investigations in astronomical physics.

#### THE SOCIAL SERVICE OF SCIENCE.\*

THE extent to which society may be considered as an organism is still, I understand, a matter of controversy with sociologists, but without awaiting its adjudication, we

\*Address of the retiring President, Iowa Academy of Science. Des Moines, December 26, 1900.

may surely make use of a simile as ancient as that of the Apostle who spoke of individual Christians as members of one body, or as that of the wise old Roman who taught the mutinous plebs the parable of the body politic, all of whose members were nourished by the well-fed patrician belly, and consider together this evening the special function of science in the body social.

It may at least supply a convenient means of classifying the various services of science to the common weal, if we consider it not as a distinct corporal member, but rather as a growth force, ever accelerating the evolution of society, providing it with organs of defense, increasing its muscular energy, and perfecting its systems of circulation and communication. And if to these services we add the reaction upon the social mind of the physical environment which science has provided, and the direct influence of scientific truth, we shall then have sketched at least the main functions of science in social evolution.

Among the first services to society which our biologic analogues suggest is that of defense. Under the growth force of science the body social has accomplished an evolution similar to that which brought the vertebrates, assumed to have been at first naked and defenseless, to the stage of the armored fishes of the Devonian, and which in the Tertiary changed tooth to tusk, nail to claw, and frontal boss to horn and antler.

Prescientific society was destroyed largely because it had attained no adequate means of defense. It is safe to say that had the Roman legionaries been equipped with Maxims and Mausers, the episode of the Hun and Vandal invasions of Southern Europe would have been indefinitely postponed.

Modern society, which science has armed with the most terrible of death-dealing weapons, whose explosives are brought from the laboratory of the chemist, whose im-

mense guns are fired at ranges which require the rotation of the earth to be taken into account, and with a precision which considers the difference in density of the air at the top and at the bottom of the bore, whose war ships are armored with the latest discoveries of metallurgy, their turrets turned and their guns loaded and trained by the electric current, and their evolutions directed by invisible vibrations of ether—surely a society thus armed has nothing to fear from any barbarian peril, be it yellow or be it black.

Civilization is safeguarded by science not only from the irruption of savage hordes, but also from the invasion of disease, from such epidemics as that which in the middle of the 14th century swept away more than half the population of England, and twenty-five millions of people in Europe. To-day when the plague appears in San Francisco or in London, it excites little more alarm than Gibraltar would feel at the assault of the Moor. By the simple remedy of vaccination science has saved in each generation of the century more lives, it is said, than were lost in all the wars of Napoleon. Among civilized nations within the last five centuries the death rate has been so lowered that the average duration of human life has nearly doubled. Medicine no longer attacks disease with charm, exorcism and nostrum; she obtains her weapons from the armory of science. From chemistry she brings a pure *materia medica*, new compounds, new processes, new methods of diagnosis, and anesthetics which have made surgery painless. From physics she obtains the appliances of electro-therapeutics, a delicate cautery, and the Röntgen ray, used by physicians in almost every town of size in Iowa within less than half a decade of its discovery.

The debt of the healing art to the sciences of the biologic group is so vast that I will select but one, bacteriology, for illus-

tration. It is to no lucky chance that the discovery is due of man's most subtle and deadly foes, the bacteria. The work of Pasteur, the pioneer, and of his illustrious followers, is marked by the most thorough and painstaking investigation, and the most searching and rigid tests. It is by the application of the scientific method that the enemy has been unmasked, his ambushes and chosen places for assault discovered and rational methods for his destruction demonstrated. It is men of science who have organized the victory of medicine to-day over diphtheria, rabies and the plague, over the venom of the snake and all the diseases to which serum therapy is successfully applied. And where the bacteriologist cannot as yet supply a specific for disease, he can often point the way to its prevention. When the access to the human system of the germs of typhoid and cholera by drinking water is demonstrated, Hamburg builds its filter beds at a cost of \$2,280,000 and Chicago expends \$33,000,000 upon the drainage canal. And so with the great white plague, tubercular consumption. Science has proved the lurking places of the contagium in the sputum, and its carriage in the air we breathe, and reinforced by the high moral sense of our people, she is fast making it as impossible for the consumptive to spit on the pavement unhindered as for the smallpox patient to walk unarrested down our streets.

And who can estimate the number of lives now saved in each generation by aseptic surgery? So long as putrefaction was held, as by Liebig, to be due to the action of the oxygen of the air, no remedy for it could be suggested; but when once its bacterial origin was proved, the step was inevitable to those precautions which have rendered safe and successful the marvelous operations of modern surgery.

Micro-biology extends her ægis also over

the herds and crops of man. She destroys the insect enemies of our grain fields and protects vine and fruit tree from blight and mildew. She saves the silk-worms of Europe from the plague threatening their destruction, and the flocks and herds of America from some of their most destructive diseases.

Thus science performs a service to society incalculable in its value. It defends it from foes both within and without the gates. It prolongs life, assuages pain, lessens disease and makes death a euthanasia. So notable have been its victories during the century that we may almost prophesy the coming of the time when the only deadly bacillus remaining will be that as yet undescribed species, *bacillus senectutis*, or at least when only sufficient disease will be left on earth to provide for a speedy and beneficent extirpation of the unfit.

Viewing organic evolution from the angle of the physicist and considering the animal body simply as a machine for the transformation of potential into kinetic energy, the secular process sums itself up in the production of better and better machines. From the fish of the early Paleozoic, on to the amphibians of the Carboniferous, the reptiles of the Mesozoic, and the mammals of the Tertiary and of the present, we have a series of higher and higher organisms, each capable of doing more work and better work than its predecessors.

It is possible to construe social evolution in the same terms. Primitive society was weak. The energy at its disposal was that only of the human body, the beast of burden, and, to a limited extent, of wind, water and flame. So feeble was the ancient state in what may be termed its musculature, so little could it utilize the forces of nature, that it may be compared with a stage of organic evolution preceding that of the vertebrata, that, let us say, of the turbellarian worm, 'whose arrangement of

muscles,' biologists tell us, 'is far from economical or effective.\*'

In comparison modern society may be likened to one of the higher mammalia, such as the tiger or the elephant, which can not only take up from nature the maximum of energy, but can also apply it in varied movements and a highly complicated conduct.

Consider the vast stores of energy which society has to-day at its disposal. The steam power of the United States alone equals the day labor of one hundred million men. Behind each man, woman and child of the nation stands more than one automaton of steel, with the strength of a man but with manifold his capacity for productive labor. In carding, for example, fingers of steel do in half an hour what the unaided workman of a century ago could not have accomplished in less than eight months. Society finds in machinery a tireless hand capable of performing the mightiest and the most delicate of tasks with equal ease. It strikes with the steam hammer a blow of 2,000 tons, and it rules the Rowland grating with its 48,000 parallel lines to the inch.

Consider also the new indument of energy which science has bestowed upon society in the gift of electricity, a power capable of the swiftest and most ready transmission, of infinite subdivision, and of the greatest known intensity of concentration. And how varied is its functioning. In mine and quarry it picks and drills and fires the blast. At the wharf it lifts and loads and carries. In the factory it forges, casts, welds and rivets. In the home it shines in the most healthful light yet made by man. In electrolysis it produces a hundred substances of value, such as the caustic alkalies, bleaching powder, chloroform, the chlorates, and aluminium, the metal perhaps to give name to the new

\* J. M. Taylor, 'Whence and Whither of Man,' Morse Lectures, 1895, N. Y., 1896, p. 47.



century. From the refuse of the mine it extracts millions of dollars worth of the precious metals. It surfaces the common metals with those more beautiful and precious, and copies infallibly the engraved plate of the map and the type-set page. In the electric furnace it creates new compounds, calcium carbide the source of acetylene gas, carborundum the abrasive of the future, and calcium nitrate, which promises a new source of nitrogen to fertilize and renew exhausted soils everywhere. It aids in the synthesis by which the chemist builds out of the inorganic the dye, the perfume, the essence, and soon perhaps the food, which nature builds only by the processes of life. Such are some of the functions of the new muscular system with which electrical science has equipped the body social.

It is not claimed that pure science is the only factor in industrial progress. Invention, business sagacity, and many other causes cooperate. But the work of science is essential, fundamental, creative. How far unaided invention can go may be seen in China. Here is a people once pliant of intellect and inventive. As artificers they still are given high praise. But Chinese invention, destitute of all scientific foundation, stopped with the fire cracker, the movable type and the directive loadstone. It could not possibly go on to the Lyddite shell, the Hoe printing press, and the compass of Lord Kelvin. Invention is applied science, and as has been well said, "science must first exist before it can be applied. Between the scientific investigator, the discoverer of principles, and the inventor who applies them, there need be no jealousy. If the last has the popular fame and the financial reward of the present, it is often to the first that the future belongs, and, in any event, in the words of the generous Schley at Santiago 'There is glory enough for all.' And after all, why should

the name of science be refused to that vast body of knowledge, classified and tested, which is in daily use in the laboratories of the industries of the world.

But to science even in its most restricted sense the debt of society is incalculable. It has evoked those good genii, steam and electricity. Watt was led to the invention of the steam engine, not by a boy's glance at his mother's tea kettle, but through the discovery by Black of latent heat and after two years of profound study of such abstruse problems as the specific volume of steam and its law of tension under varying temperatures. And the improvements in the steam engine, which since the fifties have more than doubled the speed of the piston, while saving at least one-fourth of the fuel, have been made under the guidance of Joule and the mechanical theory of heat. In the matter of the advantage of superheated steam and high pressure, theory still seems to outrun practice.

In electricity the mechanic can take no important step beyond the scientific discoverer. How happy was the thought which designates the various units of electricity by the illustrious names of the masters of research: volt, in honor of the professor in the University of Pavia, who, one hundred years ago, gave the world in his crown of cups its first effective reservoir of the new power; ampère, the name of the professor of physics in the College of France, founder of the science of electro-dynamics; ohm, in memory of the professor of experimental physics in the University of Munich, discoverer of the law of the strength of the electric current; and farad, in honor of the greatest of them all, Michael Faraday, professor of chemistry in the Institution of England, the prince of experimenters, whose researches, resulting in the dynamo, connected the industries of the world with the first economic source of electrical energy.

Illustrations of the dependence of industry on pure science are everywhere at hand. When, as an amateur in photography, I take up a package of eikonogen or hydroquinon, the label with the name of one of the great aniline factories of Germany, at Elberfeld, Mannheim or Berlin, reminds me of the debt of the *Farbenfabriken* to men of research. To the chemist is not only due the discovery of my developers, and of such other by-products as antipyrine, cocaine, saccharine and vanilline; it was he who first found in the black amorphous coal tar, the former refuse of the gas works, those brilliant crystalline dyes which have so largely replaced other colors in the dye vats of the world. So far as I am aware, no monument has been raised to these discoverers, to Hoffman, Graebe and Liebermann. In a more telling way industry acknowledges her debt to pure science when a great aniline factory such as that at Elberfeld employs sixty professional chemists, and turns the attention of twenty-six of them to pure research in discovery of new compounds.

Science has thus given society command of energies of the highest efficiency. It has made the comforts of life common and cheap, it has lifted from the shoulders of labor its heaviest burdens and set free for higher social services all who are capable of their performance. It is the undiminishing fountain whence flows the world's material wealth.

The evolution of the circulatory system in the body physiologic suggests a similar development in the body social. The process which during the geologic ages slowly changed the primitive gastro-vascular cavity to the perfected circulation of the higher animals to-day, which evolved from a simple pulsating tube the powerful four-chambered heart, may at least serve as a simile to the evolution of the distributory or transportative system of modern society. So obvious

is the analogy that the arteries of commerce is a phrase of common parlance. But for our purpose it will not be necessary to carry the likeness into details, to discriminate, as some ingenious sociologists have done, the various organs, such as the capillaries of the body social, or to liken the red corpuscles of the blood to the golden discs of the circulating medium. Let it suffice to show that by the application of the discoveries of science society has obtained a system incomparably rapid and effective for the distribution of power, of food and of all the products of labor.

The world is enmeshed by lines of railway and steamship. They carry the products of our Iowa farms to western Europe, to South Africa and to China. To our dinner tables they bring in return linen from Ireland, porcelain from France, cutlery from old England and silverware from New England, meats and fruits from States as distant as Texas, California and Florida, spices from the East Indies, and beverages from Japan and Java and the valley of the Amazon. In the United States alone there are now in operation nearly 200,000 miles of railway carrying each year a billion tons of freight and five hundred and fifty millions of passengers.

The carriage of power is accomplished at present almost wholly by the transportation of fuel. The value of this service may be seen by contrast with some railroadless country such as China, where, according to Colquhoun, coal selling at the mine at fifteen cents per ton costs as many dollars ten miles away. But the future doubtless has in store the distribution of power as an article of merchandise. The possibility of long-distance transmission of electricity has already been demonstrated at Niagara, and the time may be near when in our cities power from coalfield or waterfall may be purchased for use in factory and home as readily as water or gas to-day.

What has been said already of the debt of industry to science in the development of its motive powers applies here equally in transportation. Permit a single illustration further of the value of pure science in the evolution of the circulatory system. Every engineer is aware of the large contribution which the steel rail has made to the success of the railway. Durable, strong and cheap, it has displaced on all our railways the weak and short-lived rail of iron. It has made possible heavier trains and higher speeds. Together with other factors it has so cheapened traction that, according to Professor J. J. Stevenson, the coal of West Virginia is now sold at New York City for less than one-fourth the railway freight charges of a quarter of a century ago. But it is no belittlement of the laurels of Sir Henry Bessemer, the inventor who has made all this possible, to point to the fact that the success of his process, which, by ushering out the Age of Iron, and ushering in the Age of Steel, has revolutionized industry and touched every home with its beneficence, is due not only to his use of a great body of facts in the chemistry of the metals, but in especial to the utilization by Mushet of the facts regarding the influence of manganese and its relation to carbon, facts ascertained in the laboratories of science and left on record to await their use by invention at the proper time.

The mobility in the social organism so largely due to science has had far-reaching effects. It stimulates production to the utmost. It opens the markets of the world to the products of every worker. Labor has itself become mobile, and in the factory raw material from distant lands meets operatives from across the seas. It is the cause of vast migrations, such as that which has brought to the United States more than nineteen and a quarter million people since the opening of steamship routes across the Atlantic. It makes impossible in civilized

lands such famines as that which in 1878 in two of the northern provinces of China destroyed more than nine millions of men. It opens to the occupation of a single homogeneous civilized commonwealth such vast areas as the Mississippi valley. To any such it would be as fatal to stop the social circulation made possible by science, as in a limb of the body to ligate the main artery. Dense populations can indeed exist wherever food can be raised in abundance, as on the river plains of China, but without the modes of distribution introduced by the science of the nineteenth century, they neither can be unified into a homogeneous community nor can they be lifted to the levels of modern civilization.

By its systems of circulation which break down all barriers, science has brought about the supreme crisis in social and political evolution. Like the epirogenic movements which mark the crises in geologic history, which united continents and precipitated alien upon indigenous fauna, science has brought civilization and barbarism the world over in all their stages to meet in a life and death struggle, and offers to the fittest the prize of a world-encircling empire.

The fact that in order to operate the railway it is necessary to send signals at greater speeds than those of moving trains, suggests another service of science—the highest material service which it renders the common weal. In the telegraph and telephone a system is supplied for the almost instantaneous transmission of motor and sensory impulses throughout the body politic. In general terms we may compare the growth of the communicating system of society to the development of the nervous system in the history of animal life, where the scattered central cells of nature's first sketch of such a system are later gathered into ganglia, and ganglia massed into a brain connected with every part of the body by ramifying nerve filaments. Of all social

organs this seems the most retarded in its evolution. In primitive society it is only the smallest groups, such as the family and the village community, which have a facility of communication comparable with that of the lowest of the metazoa. In the larger groups of the tribe and nation we find a stage more advanced than that of the hydra only after science has made possible the railway post and the telegraph and telephone.

That Morse is the inventor of the electric telegraph is a statement more vacuous than that of the Vermont farmer who said that everybody knew that Edison invented electricity. But the name of the inventor of every tool of society is legion. Morse set the keystone of the arch, but its voussoirs had been built by investigators unknown to popular fame in many lands, and even the keystone was almost placed in the hands of the distinguished inventor by Henry, the great physicist. And Oersted, who in 1819 deflected the magnetic compass by a voltaic current in a neighboring wire; Arago, whose experiments with iron filings proved that this current would generate magnetism; Ampère with his suggestion of the possibility of signaling at a distance by the deflection of needles; Sweiger, who took up Oersted's experiment, and discovered that the deflecting force of the current was increased when the wire was coiled about the magnet; Sturgeon, who, making use of Arago's discovery, replaced Sweiger's magnetic needle with soft iron and thus constructed the first temporary or soft magnet; Henry, who strengthened the electro-magnet and used it with over a mile of wire to give signals by tapping a bell—all of these men, devoted solely to knowledge for knowledge's sake, are sharers with Morse and Vail in the glory of the invention of the telegraph.

And so with wireless telegraphy. In Marconi's hand this invention blazes with

a sudden brilliance which attracts the attention of the world, but the torch has been conveyed to him along the line of many runners in the torch race of scientific discovery. From Clerk Maxwell, who showed the analogy between electricity and light; from Hertz, with his demonstration of electromagnetic waves; from Onesti of Fermo, and Branly of Paris, and Lodge of London, whose researches produced in the coherer an instrument capable of seeing such waves; from these and others the torch was passed on to the great inventor whose improvements in apparatus made effective the discoveries of science.

In the telephone at least four scientific principles are involved—the voltaic current, the interaction of magnetism and electricity, the temporary magnet and the microphonic action of carbon. Through this marvelous invention each master in electrical science from the time of Galvani who has aided in the elucidation of these principles, though dead, yet speaketh.

Thus we may fairly claim that to science is due in large measure the plexus of post, telegraph and telephone, by which intelligence is flashed throughout the body social even more swiftly than along the nerves of the body physiologic. And how incalculable is the service which science thus renders! Consider the extent of the channels of communication. The domestic mail service of the United States requires each year twenty-one million miles of travel. Sixty-four years ago the first commercial telegraph was built with a length of forty miles. At the close of the century there are not less than one million miles of telegraph in the United States, over which duplex and multiplex messages are carried at the same time, and the rate of transmission has risen to six thousand signals per minute. One hundred and seventy thousand miles of submarine cables moor coasts, islands and continents together. Over one million

miles of telephone wires have already been strung in our own country. Boston, a typical city, measures its electric nerves at a total of one hundred and seventy million feet, and the radius of audible speech from it reached a year since, according to Iles, to Duluth, Omaha, Kansas City, Little Rock and Montgomery.

Note the saving of time and energy thus accomplished. Without leaving his desk the manager of a business is in instant communication with all his employees, and with the business enterprises in his own and other cities. The captains of industry are thus able to command armies of a size unthought of a few decades since. So accurate and instant are the new motor and sensory nerves that the oil refineries, the copper mines, the steel mills, almost any industry that may be mentioned, can be regimented under one control, and an industrial revolution is accomplishing before our eyes.

The electric wire with the fast mail and the newspaper flash the news of the world throughout all civilized countries. When our army attacks Santiago or marches on Peking, the public becomes impatient of even the interval between the morning and the afternoon paper. On the night of a national election the American public listens to the count of votes in every city and in every State. The new discovery of science, the new mechanical process, the new remedy for disease, are communicated without delay to the entire world. In commerce local prices seek the level of the world market, and the entire distributing system is as effectively controlled as are the capillaries of the animal body by the clutches of the nerves. In a theater vast as the whole earth we look down on the stage upon which is played the never-ending drama of current history.

In a still larger sphere the new organ of communication has a reflex on civilization. It makes possible self-governing commun-

ities stretching from the Atlantic to the Pacific and even the federation of the world. Bringing Washington face to face with London, Paris and Berlin, and the other capitals of Europe, it enables the great powers of two continents to arrange without delay a concert of action whose message flashes round the planet and is carried into effect at Tien Tsin and Peking. In direct contrast unscientific China outspreads her bulk like some vast insensate vegetal growth. Under attack, even at a vital point, she can neither mobilize her armies nor even disseminate a knowledge of the danger before it is too late.

It has been said by Giddings that objectively viewed progress is an increasing intercourse, a multiplication of relationships, an advance in material well-being, a growth of population, and an evolution of rational conduct. Subjectively it is the expansion of the consciousness of kind.\*

In all these respects science has been an accelerating force in the evolution of society. Increasing food supply by means of scientific agriculture, lengthening life by the repression of diseases, and introducing a thousand new means of livelihood, it has made possible the extraordinary recent growth of civilized nations. It permits the population of Europe to more than double since 1800, and enables England, which in the seventeenth century men thought too small for its scanty population, to support more than 38,000,000 people in comparative comfort. It lends some encouragement to the sanguine prophecy of Albert Bushnell Hart that the Mississippi valley will sooner or later contain a population of 350,000,000.†

At the same time science has produced a heterogeneity of structure. The scientific principle discovered to-day flowers to-morrow in invention and produces the seeds of

\* 'Principles of Sociology,' New York, 1896, p. 359.

† 'The Future of the Mississippi Valley,' Harper's Mag., Vol. 100, p. 419.

special arts and crafts. To Volta's researches in his villa on Lake Como five million men now employed in the many various arts connected with electricity owe in a measure their livelihood. In promoting the development of the complex organs of society for the handling of energy, for distribution, and for communication, science has constantly been a differentiating force.

By the same means it is accomplishing a more and more complete integration. The separate life of primitive society, the old personal independence, is gone. In the new order all social units and aggregations are interdependent. We are all members of one body. We must not ignore the purely psychic factors of social progress, but these alone could not maintain the new order apart from the physical basis built by science, itself a psychic factor. Were this support withdrawn, it would seem that over large areas now occupied by civilization, society must lapse and break into fragments fast degenerating into the state of the villages of the Russian plain, the scattered communities of the southern Appalachians or even to the pueblos of Arizona.

As we have spoken of the service of science in promoting the physical well-being of society, there remain of Professor Giddings's notes of social progress only the evolution of rational conduct and the consciousness of kind. These phenomena are involved in the evolution of the social mind. Here science acts directly and also by the reflex of the social organism. The organic unity of society is the ground for the expansion of the consciousness of kind. The social ties woven by science help to produce a wider social sympathy. Under the régime of science the barriers of the mark break down everywhere to make way for the market, and with their downfall the provincialism, indifference and hate of once separated peoples pass away. Science has created, as we have seen, a new physical en-

vironment which reacts constantly on the social mind, awakening from torpor, stimulating to greater activity, demanding a more alert attention, and a precision and swiftness of movement before unknown.

Still more directly is science creating an intellectual milieu whose influence on the social mind is as inescapable as is that of climate on the physical life. The world of our forefathers, how close its confines, how dark and shadowy, how uncertain and untrue, compared with the illimitable sphere which science now fills with her clear light. It is a universe, not a multiverse, the new world which science apperceives. It is a world of law, in which each event has adequate cause; the expression of one immanent energy operating across all widths of space and throughout all lengths of time, without loss or increment, and without variableness or shadow of turning; an eternal becoming an evolving order which comprehends the growth and decay alike of solar systems and of the humblest of living creatures. It is of this new world that the two master Victorian poets, inspired by both the scientific and the religious spirit, have written:

All's law, but all's love.

and,

One God, one law, one element,  
And one far off divine event  
To which the whole creation moves.

The effect of these new cosmic conceptions of science penetrates every department of learning and every field of life. It revolutionizes society. It rationalizes the social mind. It has swept to the limbo of things that are not the sprites of evil which affrighted our forefathers. In this science has done a work which neither literature nor art nor religion nor ethical culture has proved itself able to accomplish. It was the pious Melancthon, the gentle scholar of the Reformation, who at Heidelberg saw in falling stars only the paths of

deceitful devils, and the mandarin to-day, learned in all the ethical wisdom of Confucius, a classical scholar of the finest literary taste, still burns his firecrackers at the funeral of a friend that he may frighten away the pestiferous spirits of evil which dog the steps of men through life even to the threshold of the world beyond.

The rationalizing influence of science upon civilization needs no illustration to one versed in the literatures of the prescientific ages, to one who has read Plato's 'Timæus' or Plutarch's description of the moon. And how preposterous were the theories current but a century since, such as those which saw in fossils the freak of some plastic power in nature or the remains of a catastrophe which swept away in a flood of waters the very foundations of the earth. To-day how rare and how interesting are such survivals of this almost forgotten time as the Atlantis of Ignatius Donnelly!

The theory of evolution furnishes one of the best examples of the replacement of the untruths of the past by truths discovered by science, and of their revolutionary effect. Since the discovery of the proofs of this process, man has come to know himself as never before. He understands at last the meaning of history and rewrites his texts on philology, literature and all social and political institutions. He sees, though as yet dimly, some solution to the ethical problems of sin and evil, and beholds as in a panorama the process of his creation.

It is as yet too soon to see the full effect of these new conceptions upon the social mind. Science has not yet come to its own in education, and the irrational and the unreal are far from being wholly banished from society. But more and more the care of the young is entrusted to science to train, as none other can, to be quick of eye, true of speech, and rational in thought, to bring them face to face with reality and to open

to their view the widest and most inspiring vistas. Common knowledge is one of the strongest social bonds. We meet and touch in what we know. The time has been when educated men drew together in a common knowledge of phrases written in extinct languages. To-day they find this rapprochement, this consciousness of kind, more and more in a common training in science. In the laboratory they have measured the energy of the falling body and studied its transformation into sound, heat, light, chemism and electricity; they have tested the ray from the hydrogen atom and found its vibration the same from the flame on the table and in the light of Sirius. They have dissected the tissues of life, and have read in Nature's book the life histories of mountain, river and planet. And thus to-day they have attained to that cosmic conception, overwhelming in its sublimity, which is the best gift of science to man.

The reward which science asks for this service is the wages of going on; she asks for well-equipped laboratories, for longer courses of scientific study in schools, for the endowment of scientific instruction and research. Such foundations as the Lawrence Scientific School, the Field Columbian Museum, and the Smithsonian Institution are examples of appreciation as yet as rare as munificent. I am not aware of any such in Iowa. When wealth builds the spacious laboratory or endows a chair in science in any college of the commonwealth, it is but rendering to science her own. Each dollar earned by railway, telegraph and telephone, mine and quarry, mill and factory, farm and store, may well pay tithe to science which has made these industries possible. The gratitude for a life saved by the applications of science in modern medicine might well be generous. And yet the total gifts to scientific instruction in Iowa by men of wealth do not exceed \$50,000. I am aware of the State appropriations to the

scientific departments in our State institutions, and I should be glad to call them generous. At least they have given Iowa the fame of men whose work in science has achieved national recognition. But these yearly appropriations, were they many times as great, could not supply the place of the great gifts, endowments to be for all time reservoirs of power transmuted constantly into the highest social service. It is the boast of American democracy that by such votive offerings it shows appreciation of education, charity and scientific research.

As members of a guild of workers in science, let us be thankful for even the humblest place. To discover any fact, however trivial, to add anything, however slight, to the sum of human knowledge, this is to shape and dress some stone for the building of science, the home and shelter of the race. Our contribution may go to chink some crevice, or at least some master builder may find in it the keystone of an arch or the cap stone of a column. But whatever its place, if our work was well and truly done it abides as a permanent service to society.

WILLIAM HARMON NORTON.

CORNELL COLLEGE, MT. VERNON, IA.

*A NEW CONNECTION BETWEEN THE GRAVITY MEASURES OF EUROPE AND OF THE UNITED STATES.*

ABSOLUTE measures of gravity, repeated by different observers using different instruments at identical stations, have shown comparatively large disagreements. The general experience has been that differential measures of gravity are much more accurate than absolute measures, and there has, therefore, been a growing tendency to use the differential method rather than the absolute method. The results of such differential measures may be reduced to absolute units either by connecting by the

relative measures many stations at which absolute measures have been made and then making an adjustment to get a mean value, or a single determination of the absolute value of gravity, which is believed to be of a much higher degree of accuracy than any other, may be used in reduction to absolute units.

These general conditions, especially with respect to gravity stations in Europe and the United States, led naturally to the campaign of differential gravity measures carried out by Assistant G. R. Putnam, of the Coast and Geodetic Survey, in the summer of 1900, under the direction of the International Geodetic Association.

The compact and portable half-second differential pendulums known as A4, A5 and A6, and of the type developed under the direction of Dr. T. C. Mendenhall while he was superintendent of the Coast and Geodetic Survey, were swung at Washington in May and again in October, 1900. Between these dates they were also swung at the Kew University, Greenwich Observatory, London Polytechnic Institute, Paris Observatory and at Potsdam, Germany, and thus served to determine with considerable accuracy the relative values of gravity at these points. Some of the principal previous determinations of gravity which have been made at or near these stations, and are therefore connected by the observations of 1900, are at Washington, by Preston in 1889-90, and Defforges in 1893; at the Kew Observatory, by Heavside in 1873-74, by Herschel in 1881-82, by Walker in 1888, by Von Sterneck in 1893; at Greenwich Observatory, by Von Sterneck in 1893; at the London Polytechnic Institute, by Sabine, Kater and Herschel; at the Paris Observatory, by Defforges in 1892, and Von Sterneck in 1893. At Potsdam the observations connect with a most elaborate and painstaking determination of the absolute value of gravity which is now in



progress under the direction of the International Geodetic Association, and which is expected to yield the most reliable value ever yet determined in absolute units.

Other connections of varying degrees of accuracy had previously existed between these six stations. The new measures furnish direct connections of a very high degree of accuracy. These six stations have directly or indirectly been connected by various observations with nearly all the gravity stations of the world.

The work of deducing from the numerous connections between the gravity measures of various countries the best absolute values of gravity at the many points of observation scattered over the whole globe is peculiarly the duty of the International Geodetic Association, and is being performed systematically by that organization. In this investigation the gravity observations of 1900 furnish important new evidence.

The special value of these gravity measures of 1900 to the Coast and Geodetic Survey lies in the fact that they furnish the means of reducing accurately to absolute units all the relative measures made in the United States with the half-second pendulums during recent years. These values have up to the present time been reduced approximately to absolute units by assuming that the value of gravity at the Coast and Geodetic Survey Office is 980.098 dynes. This approximate value was adopted in 1892 and depends upon an absolute determination of gravity at Hoboken, N. J., and three comparisons of Hoboken with Washington by relative measures with three different sets of pendulums, and finally an absolute determination at Washington in 1889-90. In 1894 Mr. Putnam derived twenty-nine different values for gravity at Washington by utilizing all the connections available at that time between Washington and various stations at which absolute

measures had been made by various observers from 1792 to date. The mean of these values was 980.107. As the individual determinations showed a wide range, 0.147, the value 980.098 cited above was retained. From the relative observations of 1900, combined with the preliminary published absolute value of gravity at Potsdam from the observations which are still in progress, the value of gravity at Washington is 980.111. This differs by one part in 77,000 from the approximate value adopted in 1892, and by only one part in 250,000 from the mean of the 29 values deduced in 1894.

JOHN F. HAYFORD.

---

*THE AMERICAN INSTITUTE OF ELECTRICAL ENGINEERS.*

THE first conversazione of the Institute was held at Columbia University on the evening of April 12th. About 1,500 ladies and gentlemen attended and enjoyed a most pleasing entertainment. Through the courtesy of the University authorities every facility in the way of space, current supply and assistance in preparing exhibits was placed at the disposal of the exhibitors, so that the many new devices, etc., were shown in actual operation. The list of exhibitors was long and the character of the apparatus extremely varied, as might be expected from a function held under the auspices of a society which represents the connecting link between pure science and commercial engineering. Many of the names included are well known in scientific circles, but the exhibits were in every case novel and have created a standard which will tax the energies of the Institute to the utmost to repeat in future conversazioni. Many notable persons were present as guests of the Institute, among them President Low and numerous professors of Columbia. President Low was accompanied by Baron von Holleben the German Ambassador to this

country. Mr. Thomas A. Edison was among the distinguished electricians present, while a great number of colleges were represented by exhibitors and guests, Vaszar sending a contingent of a dozen students interested in natural science.

Dr. Michael I. Pupin exhibited the original apparatus used in developing the recent invention for the improvement of long-distance land and ocean telephony which has recently been bought by the American Telephone Company. Mr. Peter Cooper Hewitt showed numerous samples of his recently invented high efficiency lamps. In these lamps mercury vapor is used instead of a filament, the lamp consisting of a long, cylindrical glass tube. At the bottom of each is some mercury, from which, when the current of electricity has passed through it, issues the vapor and a most peculiar colored light is emitted. It is half purple, half green. This is a disadvantage, but it can be obviated by the use of counteracting colored shades. In a room near the Hewitt lights were the akouphone and akoulation invented by Mr. M. R. Hutchison. They are microtelephonic instruments, so constructed as to reproduce and intensify sounds and still preserve their quality, and many successful experiments were made upon deaf mutes, in which they were taught many new words during the evening. One of the largest lecture rooms of the university had been set aside for the use of Mr. Nicola Tesla, where he showed numerous interesting experiments with high-frequency currents.

Much interest was shown in the exhibit of European Nernst lamps, made by Mr. William J. Hammer, who also showed Weldemar Paulsen's new telephonograph and telegraphone, loaned by Leuvig Fog and Emil S. Hagemann of Copenhagen, Denmark.

These instruments receive telephone messages in the absence of the recipient and

record them on a kind of magnetic phonograph, which repeats them when the one for whom they are intended returns.

Another exhibit of Mr. Hammer's was a collection of aeronautical pictures, comprising photographs of Professor S. P. Langley's aërodrome, Sir Hiram S. Maxim's flying machine, Santos-Dumont's dirigible airship, and Count Zeppelin's balloon; together with the balloon tests made during the Aeronautical Congress, at the Paris Exposition of 1900, and by the Aëro Club of France. Most of these photographs were taken by the exhibitor. Prof. S. P. Langley exhibited his latest form of bolometer for spectrum analysis and showed many drawings and diagrams of the principles and results obtained.

Professor W. S. Franklin exhibited a magnesia arc lamp, an electrolytic lamp on the Nernst principle, operating on 1,000 volts.

Professor Francis C. Crocker showed magnetic liquids, with apparatus in operation for showing the magnetic properties of liquids and for measuring their permeability, and Mr. Martin P. Rice, a new X-ray apparatus employing a modified form of Wehnelt interrupter. Radiographing of alternating currents was shown in a large room which could be darkened at will. The exhibitors were Professor Harris J. Ryan and Professor J. O. Phelon, and their method secured stationary and continuous diagrams of alternating current values by records made from the radiographs of a rapidly rotating cathode ray, the rotation being caused by the action of the current.

Professor Elihu Thomson had a most interesting exhibit consisting of a dynamo static machine and a new rotary electrical apparatus. The former contained a small direct-current motor, the windings of which were tapped and connected to two rings, giving a primary alternating current for the operation of a step-up transformer which gave a secondary current of about 20,000

volts, being capable, however, of regulation through a wide range. The tops of the alternating current waves of high potential obtained from this secondary transformer were used to charge a number of glass plate condensers in parallel. The rotating frame synchronously driven with the motor made the connection to the condensers periodically and in synchronism with the alternating current. The connection by the rotating frame is alternately in parallel and in series, the condenser plates being charged to 15,000 volts with ten in parallel, giving 150,000 volts when connected in series. The machine therefore furnishes from low pressure direct current, high potential discharges of definite polarity at the discharged terminals. The new rotary electrical apparatus consisted of an iron sphere heavily electroplated with copper and mounted so that it may revolve on any axis or in any plane. Surrounding this sphere were three coils in planes at right angles to each other. By suitably energizing these coils with polyphase current the sphere was made to revolve on any axis or in any direction, thus illustrating a three dimension polyphase system. This apparatus shows in a very satisfactory manner the principles of the gyroscope and Bohnenberger sphere.

Professor Thomson also exhibited an aluminum disc mounted on a shaft free to rotate, and having applied to it in special ways alternating current magnetic fields, the rotations of the disc involving interesting paradoxes which the visitors were asked to explain.

Mr. E. V. Baillard showed the Parker-Baillard bridge for measuring low electrical resistances for general work and standardization and an ingenious faradmeter for the direct measurement of capacity. Some interesting spark experiments, showing oscillating discharges occurring rapidly during the same half wave, and proving that a short circuit in a high potential current containing

inductances and capacity ruptures itself instantly, were shown by Mr. W. S. Andrews who also exhibited a luminous aluminum cell giving beautiful effects.

Among the many other exhibits were various forms of storage batteries by Mr. Elmer A. Sperry, Mr. Herbert Lloyd, Mr. A. S. Hubbard and Messrs. Frank Perret, J. A. Barrett, and W. H. Meadowcroft. Mr. H. R. Palmer showed a fac-simile picture telegraph in operation, Mr. Otto T. Louis an electric furnace and an ohmmeter. A specimen of the standard United States Army field telephone and telegraph kit used in the Cuban and Philippine campaigns, and wireless telegraphy as improved by the Government, were in charge of Col. Samuel Reber, U. S. A.

W. C. ANDREWS.

#### SCIENTIFIC BOOKS.

*Erinnerungen aus meinem Leben.* Von A. KÖLLIKER. Leipzig. 1899. Svo. Pp. x + 399.

This work of the veteran celebrated histologist is much more than an autobiography, since it includes a number of original contributions to science, with which the anatomist and embryologist must necessarily acquaint themselves.

The first part is strictly biographical, giving a general account of the author's life, which passed without exciting elements along academic paths. Kölliker was born at Zürich, in Switzerland, on July 6, 1817, the elder of two children. He dwells somewhat upon the recollections of his boyhood, recalling with pleasure a few boyish escapades. He early displayed great fondness for nature; he loved the mountains and made collections of plants and minerals, and therefore was led naturally to the study of medicine. But practice had no allurements for him, especially since he soon fell under the spell of the microscope, as a revealing instrument, in the employment of which he has spent his long life. In the summer of 1839 he went to Bonn, hearing there medical lectures in Latin, and the autumn of the same year he passed to Berlin and came under the

direct influence of Germany's greatest morphologist, Johannes Müller, and of Jacob Henle. The latter brought him to the study of the microscopic anatomy of the human body, and so started him upon the career of investigations, which, sixty-two years later, he is still pursuing. It is an interesting coincidence that Kölliker's career began in 1839, the very year in which Schwann established the cell doctrine for animals, so that he has lived through the whole period of the application of that doctrine to the problems of morphology, physiology and pathology, and has, during this epoch, achieved the remarkable distinction of having contributed more than any other single investigator to our knowledge of the cellular structure of animals. It is difficult to realize how many of the fundamental facts of microscopic anatomy, even of those which have been taught in elementary text-books for forty or fifty years, we owe to the discoveries of Kölliker.

In 1841, he became assistant to Henle, who was then at Zürich. In 1844 he was promoted to be professor extraordinarius of physiology. The conditions at Zürich were unsatisfactory, so that in 1847 he accepted a call to Würzburg, where he has since remained, for over half a century. In 1848 he married Maria Schwarz, of Mellingen, in Switzerland.

The volume gives a list of the celebrations in which the author took part, and a list also of all the medals, prizes and other honors which have been bestowed upon him. There are also accounts of his journeys, several of which took him to the sea-shore for purposes of research. The accounts are chiefly in the form of letters, written at the time, and they include a great number of interesting impressions of famous scientific men which offer valuable material for the history of science during the century.

There are three portraits of the author—that which forms the frontispiece is an admirable likeness of the handsome and intellectual face. Another full-page illustration is a photograph of the carved box which was made for the congratulatory address presented to Kölliker on his eightieth birthday.

The second part of the work enumerates his activities as a university teacher and adminis-

trator, including the various courses of lectures he has delivered. Next follows the annotated catalogue of his publications, classified with considerable care. The annotations are often explanatory of the origin and purposes of the separate publications and of the standpoint of the author at the time. Other notes define the share of an essay in developing and fixing scientific conclusions. Finally one encounters, apropos of several articles in the catalogue, additional new observations recorded, which serve to correct and amplify the original record. Some of these observations are illustrated by new figures also. In brief, there is scientific matter included, which is here published for the first time.

Kölliker's 'Erinnerungen' is different in many respects from the usual autobiography, but is certainly a remarkable contribution to the record of the general condition and progress of science during the second half of last century.

CHARLES S. MINOT.

*The Bird Book.* By FANNIE HARDY ECKSTORM. Boston: D. C. Heath & Co. 1901. 12mo. Pp. xii + 276; 24 pls., map, and 31 figs. in text.

*The Woodpeckers.* By FANNIE HARDY ECKSTORM. With Illustrations. Boston and New York: Houghton, Mifflin & Co. 1901. 12mo., pp. viii + 132; 5 col. pls., 21 figs. in text.

The time was, not many decades ago, when the young student of ornithology was, of necessity, self-taught, learning almost wholly by his own unaided observation in the field. Nowadays the demands of a multitude of would-be learners for short and easy paths to knowledge have led to the making of many books, that serve, at least, to show how hard it is for books alone to give the beginner the training he needs. How to observe carefully and thoroughly, and how to interpret what one sees, are not readily learned, except by the hard school of experience.

In these two volumes Mrs. Eckstorm has to a remarkable degree succeeded, where some of her predecessors have failed, and surely has gone far toward accomplishing the seemingly impossible. Even abstruse technicalities and fundamental biological principles are stated so clearly and simply that a child easily may com-

prehend them; and the details of bird life are so told that the reader cannot fail to gain an idea of what things the experienced naturalist looks for, and what he sees.

'The Bird Book' is divided into four parts. A dozen or so descriptive sketches under the title 'Water-birds in their Homes,' are followed by explanations of such matters as the structure, mechanism and use of birds' feet, wings and bills, and the adaptation of their different forms to habits. Then other, more philosophical subjects are unfolded, and made surprisingly plain, such as the principles of classification, the conditions of the struggle for existence, distribution and migration; and the concluding chapters are devoted to detailed accounts of some habits of birds, as 'How the Hawk Eats his Food,' 'The Cave Swallow's Changes in Nest-building,' 'How the Shrike Hunts.'

'The Woodpeckers' is, in form, more a popular monograph of that group of birds. After several chapters on the habits of woodpeckers in general, five widely distributed and representative North American species are taken up in turn, and the characteristics of each discussed. Following this, the peculiarities and uses of the woodpecker's bill, foot, tail and tongue are studied, and then attention is drawn to the modifications of these organs in different genera and to their remarkable adaptation to the specialized habits of each. The volume is concluded by a key for the identification of all the North American woodpeckers.

The books are well written. The style is never dull, and often brilliant. They are abundantly and, on the whole, well, illustrated; and 'The Woodpeckers,' in addition to various figures in the text, contains five colored plates.

It should be added that throughout both volumes the author is remarkably successful in carrying out their evident underlying purpose—not merely to convey information and inspire interest, but to cultivate in the beginner, by example rather than precept, a truly scientific spirit, both in his observations and in his deductions.

C. F. B.

*Engineering Chemistry, a Manual of Quantitative Chemical Analysis for the Use of Students, Chem-*

*ists and Engineers.* By THOMAS B. STILLMAN. Second edition. Easton, Pa., The Chemical Publishing Co. Pp. 22 + 503. Price, \$4.50.

The first edition of this book appeared in 1897. Its usefulness is indicated by the fact that a second edition is required so soon. The work seems to be designed to serve several purposes. The first portion, especially, appears to be intended for the use of students beginning the subject of quantitative analysis. The exercises selected in this portion are satisfactory, but the directions lack that careful detail in regard to methods of manipulation and in regard to the properties of the compounds used in analysis, which are so necessary for the student who is to acquire any adequate knowledge of the subject. It may be objected, of course, that room could not be found in this book for such details. It would seem, however, that these exercises at the beginning should have been omitted altogether or they should have been properly given.

The chemist or student who has already acquired a knowledge of analytical methods will find very much throughout the book that will prove very useful. The subjects discussed cover a wide range, the more important being the analysis and filtration of water, the analysis of coal, gas and other fuels, calorimetry, iron and steel analysis, blast furnace charges, analysis and tests of cements, analysis of clay, alloys, paper, soap, oils, paints and asphalt, pyrometry, electrical units and energy equivalents.

The writer is well aware of the large amount of labor which an author must give to the study of the literature of each topic in writing a book of this kind, in order to determine what is the best present analytical practice, and some mistakes are to be expected. In several cases, however, it would seem that better methods or more accurate directions might have been easily found. Thus, under coal analysis, in giving Eschka's method for sulphur, nothing is said about the danger of absorption of sulphur from an ordinary gas flame; for phosphorus in steel the method of Dudley and Pease is given, although that method has since been modified in several important particulars, and made more accurate without increasing the time required for its execution; for total carbon in iron, solu-

tion with the use of neutral copper sulphate is recommended instead of the acid solution of the double chloride of potassium and copper, which has been shown to be more exact by the American Committee on Standard Methods.

With revised tables of atomic weights, published annually by both the American and German Chemical Societies, it seems hard to find an excuse for a list which includes such values as Al, 27.5; Mg, 24.0; Si, 28.0; Cr, 52.5; Zn, 65.0. Antiquated values are also given for the specific gravity and weight of one liter of hydrogen.

While defects in the book have been pointed out at some length, it would be unfair not to refer to the large amount of valuable material to be found in its pages.

The frequent tables of analysis for commercial products give, in concise form, directions which will be very useful to the working chemist. The specifications for many substances used by railroad companies form a unique and excellent feature. And, while pyrometry, electrical units and energy equivalents do not properly belong in the domain of chemistry, many chemists will find them useful.

W. A. NOYES.

*Ausgewählte Methoden der analytischen Chemie.*

Von PROFESSOR DR. A. CLASSEN. Erster Band unter Mitwirkung von H. Cloeren. Braunschweig, Friedrich Vieweg und Sohn. 1900. 18mo. Pp. xx + 940. Figs. 78. Price, M. 20.

Notwithstanding the astonishing number of books bearing upon analytical chemistry which appear yearly, it is probably within bounds to say that, until recently, only those of Fresenius, Böckmann, Bolley, Post, and possibly that of Crookes, have generally been regarded as fulfilling the requirements as to scope and reliability of a satisfactory book of general reference. In the last few months, however, three works of wide range and excellent promise have appeared—namely, those of Carnot (*Traité d'analyse des substances minerales*), Lunge (*Chemisch-technische Untersuchungs-methode*) and this work of Classen. Classen's work differs, however, from those of Lunge (a continuation of that of Böckmann), Bolley, and Post,

in that he presents his subject matter in such a way as to emphasize rather the general usefulness of the methods described than to present schemes for the analysis of particular bodies, although the application of the methods to special cases is adequately treated. On the other hand, Classen's work differs from those of Fresenius and Carnot, in that he has prepared the book for the use of technical chemists and advanced students to whom the general operations of analytical chemistry, such as weighing, filtering, and the like, are known. These are, therefore, omitted, and he proceeds at once to the description of particular methods.

The present volume includes only the metals and metalloids. Methods suitable for the qualitative detection of each are described, followed by procedures for their quantitative determination by volumetric, gravimetric, colorimetric or electrolytic methods, the selection having been determined upon, he states, only after tests made by him, his assistants or pupils, or, in some instances, after he had become convinced of the accuracy of the processes through published criticism. The descriptions of the procedures for the determination of the metals are, in turn, followed by those of methods for such separations from other elements as occur in ordinary analytical practice, and, in addition to the foregoing, special schemes are given for the analysis of bodies of technical importance, such as irons and steels, aluminum and its alloys, cements, clays, glasses, zinc ores and zinc dust, chrome iron ore and chrome steel, uranium ores, platinum ores and residues, 'osmiridium,' 'platiniridium,' fertilizers, liquid ammonia, ammoniacal liquors, and a scheme for rock analysis.

The value of this book as a work of reference is also much enhanced by the introduction of matter relating to the rarer elements. The methods described for the separation of the rare earths by fractional precipitation and the analysis of monazite sand, as well as of the materials employed in the manufacture of mantles for incandescent lamps, appear to be specially complete.

The author deplors the general absence in text-books and journals of statements indicating the basis of the stoichiometrical calcula-

tions often required in connection with the analytical operations described, and has, wherever these calculations are at all complicated, indicated the method of procedure. Tables to assist in the calculation of analyses are also appended.

References to the original sources of information are uniformly and freely given. Many of these refer to articles published in 1900, indicating that the book has been brought well up to date. The book closes with an excellent subject and author index, and the typography throughout is very satisfactory.

Professor Classen presents, as a product of thirty years of analytical practice in connection with technical chemistry, a work which bears evidence of a high degree of trustworthiness and is, to the extent to which it has been finished, of an unusual degree of completeness. As would have been expected, considerable stress is placed upon electrolytic methods and their advantages, and the omission of certain methods which are known to be reliable may cause some surprise; but there can be no doubt that the work is a distinctly valuable addition to the literature of analytical chemistry, and is sure to be of great service. Its early completion is much to be desired.

H. P. TALBOT.

#### SCIENTIFIC JOURNALS AND ARTICLES.

IN the February-March number of the *Journal of Geology* Thomas L. Watson discusses 'The Origin of the Phenocrysts in the Porphyritic Granites of Georgia.' Detailed descriptions of the rocks of various districts are given. The criteria for distinguishing phenocrysts formed *in place* from those of intratelluric origin are stated and the conclusion is drawn that these were undoubtedly formed *in place*. Under the title of 'Certain Peculiar Eskers and Esker Lakes of Northeastern Indiana,' Charles R. Dryer describes some interesting results of deposition by glaciers or glacial waters which he does not attempt to fully explain. Good contour maps are given which, with the data furnished, will bear study. 'Correlation of the Kinderhook Formations of Southwest Missouri' is discussed by Stuart Weller. A recent State report makes a part of

these rocks Devonian and supposes the section to be poor in fossils. Mr. Weller has collected many fossils from the area and gives in detail the evidence upon which he definitely correlates all the beds with the Chouteau limestone of central Missouri which is Upper Kinderhook. F. W. Sardeson concludes the discussion of 'The Problem of the Monticuliporoidea' begun in the last number. O. C. Farrington contributes a second article on 'The Structure of Meteorites,' giving a detailed description of the chondritic structure. An interesting conclusion gives an account of the synthetic experiments by which it has been attempted to reproduce the structural details of meteorites. Success in this line has not been marked, and it may be necessary to fall back upon extraterrestrial conditions. The intense cold of space is suggested.

IN *The Auk* for April P. B. Peabody describes the 'Nesting Habits of Leconte's Sparrow,' and William Brewster notes 'The Occurrence, in Massachusetts, of Certain Rare or Interesting Birds,' and Frank Coates Kirkwood tells of 'The Cerulean Warbler (*Dendroica cerulescens*) as a Summer Resident in Baltimore County, Maryland.' Joseph Grinnell describes 'Two Races of the Varied Thrush' and J. Lewis Bonhote has some notes 'On a Collection of Birds made by Mr. T. R. Thompson at the Cay Lobos Lighthouse, Bahamas'; and Otto Widmann contributes an article on 'A Visit to Audubon's Birthplace,' Fontainebleau Plantation, near Mandeville, La.; the house is now in ruins. Reginald Heber Howe, Jr., has 'A Study of the Genus *Macrorhampus*' deciding that *M. scolopaceus* is but a subspecies of *M. griseus*. H. W. Henshaw notices 'Birds of Prey as Ocean Waifs,' and Francis J. Birtwell gives 'A Description of a Supposed New Subspecies of *Parus* from Mexico.' Hubert Lyman Clark discusses 'The Pterylosis of *Podargus*, with Notes on the Pterylography of the Caprimulgi,' concluding that the nearest relatives of this group of birds are to be sought for among the nocturnal birds of prey. There is a 'Republication of Descriptions of New Species and Subspecies of North American Birds, No. II.' by J. A. Allen, Wilfred H. Osgood describes

'New Subspecies of North American Birds,' and Leonard Stejneger considers 'The Two Races of *Saxicola oenanthe*.' There is a large number of interesting General Notes, reviews of Recent Literature and Notes and News.

*Bird Lore* for March-April opens with an article by Frederic A. Lucas on 'Walrus Island, a Bird Metropolis of Bering Sea,' with some reproductions of fine photographs by H. D. Chichester. Mrs. Harriet Carpenter Thayer tells of 'Our Blue Jay Neighbors,' with illustrations from photographs by Thos. S. Roberts; F. A. Van Sant has a brief paper on 'Early Larks,' and P. B. Peabody another on 'Saw-whet Homes.' In the third series of 'Birds and Seasons' the theme is treated by various well-known ornithologists, the birds being those for April and May. Elizabeth Hoppin Lewis contributes for young observers an illustrated poetical 'A B C of Bird-Lore.' There are the usual reviews and the section devoted to the 'Audubon Societies.'

THE *Journal of the Boston Society of Medical Sciences* for February contains papers on 'The Relation Between Conductivity and the Inorganic Salts of the Nerve,' by Albert P. Mathews; 'Dermatomyosites, with Report of a Case which also presented a Rare Muscle Anomaly, but once described in Man,' by Walter R. Steiner, and 'The Effect of Carbon Dioxide and Oxygen on Smooth Muscle,' by Allen Cleghorn, assisted by H. D. Lloyd. The remainder of the number is devoted to abstracts of papers presented at the second annual meeting of the Association of American Bacteriologists, in December, 1900. Among these we note one on the possibility of infection from the use of modeling clay in school work.

#### SOCIETIES AND ACADEMIES.

##### SECTION OF ANTHROPOLOGY AND PSYCHOLOGY OF THE NEW YORK ACADEMY OF SCIENCES.

A REGULAR meeting of the section was held on March 25th, Professor Cattell presiding. The annual election of section officers was held, resulting in the choice of Professor Livingston Farrand as Chairman, and Dr. R. S. Woodworth as Secretary.

Professor F. H. Giddings presented a paper on the use of the term 'race.' He spoke in part as follows: "The term 'race' as used by many different groups of investigators—anthropologists, ethnologists, philologists and historians—long since ceased to have a definite meaning. Efforts to establish a technical and conventional use of the word have thus far been unsuccessful. As one more attempt I suggest a combination of the word 'race' with various descriptive adjectives, denoting successive degrees of kinship. The narrowest degree of relationship is consanguinity, or the relationship (physiological, psychological and sociological) of father, and mother and children, brothers and sisters, grandparents and grandchildren, uncles, aunts and cousins. Let us designate this degree of kinship by  $K_1$ . The next degree of kinship, or  $K_2$  is propinquity. The primary meaning of this word is 'nearness in place' and the secondary meaning is 'nearness in blood.' The word is thus perfectly descriptive of a state of facts which we find when a number of families live in the same neighborhood and, through intermarriage and association, become related (but less closely than the consanguinity of  $K_1$ ) in blood, in type of mind, and in institutions.  $K_3$  is nationality, that wide degree of kinship (physical, mental and social) which includes those who speak the same language, and, for many generations, have dwelt together under the same political organization.  $K_4$  is potential nationality, or the degree of relationship (physical, mental and social) of a heterogeneous people composed of many nationalities, undergoing assimilation, or blending, into a new nationality, as in the United States. Potential nationality includes the familiar census divisions, 'native born of native parents,' 'native born of foreign parents,' and 'foreign born.'  $K_5$  is ethnic-race, a group of closely related nationalities, speaking closely related languages, and having well-marked psychological characteristics in common. Examples are the Celtic ethnic-race, including the Welsh, the Irish, the Highland Scotch, some of the Cornish and the Bretons; the Teutonic ethnic-race, including Germans, Swedes, Norwegians, Danes and Dutch; and the Latin ethnic-race, including Italians, Spaniards and Greeks;  $K_6$  is Glot-



tic race. This is that very broad relationship, to a slight extent physical, to a somewhat greater extent mental and social, of those related ethnic-races that speak languages derived from a common ancient tongue. Examples are, the Aryan glottic-race, including the Celtic, Teutonic, Latin and other ethnic-races; the Semitic glottic-race, and the Hamitic glottic-race.  $K_7$  is chromatic race, that extremely wide and vague relationship, which includes related glottic-races marked by the same color. Examples are, the white chromatic-race, which includes the Aryan, Semitic and Hamitic glottic-races; the yellow chromatic-race, which includes the various glottic-races known as Mongolian or Turanian; the brown, the red and the black chromatic-races.  $K_8$  is cephalic-race, or that widest relationship which includes chromatic-races of like cephalic index. The distinction about which I feel most doubt is this between chromatic and cephalic race. Remembering that, according to this scheme, variability and multiplicity of specific characteristics produced by differentiation should increase as we proceed backward from  $K_8$  to  $K_1$ , I think that probably cephalic index is rightly placed as  $K_8$  and color as  $K_7$  because, in the organic world in general, coloring seems to be a less stable characteristic than anatomical structure. The compound terms which I have here introduced are admittedly clumsy, but they have the advantage of conveying precise meanings. If a writer speaks of 'race' without a qualifying word, his reader must guess at his meaning. If he says, 'cephalic-race,' 'chromatic-race,' 'glottic-race,' the meaning cannot be mistaken.'

In reply to a question Professor Giddings said that the clan is developed between  $K_1$  and  $K_2$  and the tribe between  $K_2$  and  $K_3$ .

The following paper was read by Mr. Stansbury Hagar, on the 'Wards of Cuzco.' The speaker presented a portion of the evidence collected by him which tends to show that the twelve so-called wards of Cuzco, the ancient capital of the Inca Empire, were the terrestrial representatives of the signs of the Peruvian zodiac. The evidence bearing on this hypothesis is divided into four main classes. In the

first place, the system of 'mamas,' under which the Peruvians regarded every material object as merely a product of the real spiritual essence of which it was the expression, gave rise to an attempt to imitate on earth the features of the world above as observed in the heavens. This system, in turn, resulted in the production of an elaborate ritual, the features of which, each month, corresponded with the supposed attributes of the 'mama' which governed the corresponding sign through which the sun was passing during that month. The ideas associated with the 'mamas' are shown to correspond with the names of the Cuzco wards. Again, these names correspond very definitely with the names of the zodiacal signs upon the native star map of Salcamayhua. And finally the names of one or two of the wards can be identified directly with definitely known native constellations situated in the zodiac. The nature of the evidence thus adduced is such as to indicate that the native Peruvians had made remarkable advance in astronomical knowledge in times long anterior to the arrival of the earliest Europeans known to history.

R. S. WOODWORTH,

Secretary.

#### GEOLOGICAL SOCIETY OF WASHINGTON.

AT the 113th meeting, held at the Cosmos Club March 27, 1901, the discussion of geological units begun at the preceding meeting was continued by Professors H. S. Williams, C. R. Van Hise, T. C. Chamberlin, and others.

At the 114th meeting, held April 3d, the following communications were presented:

*The Priceite of Lone Ranch, Curry Co., Oregon.*

J. S. DILLER.

This chalky borate of lime occurs rather irregularly upon and in a mass of serpentine, and is probably a hot-spring deposit.

*The Problem of the Archæan:* C. R. VAN HISE.

An historical review of the progress made in differentiating pre-Cambrian rocks, and a statement of the present basis of distinction between Archæan and Algonkian.

At the 115th meeting, held April 10, 1901, the program was as follows:

*The Philadelphia Gneisses:* F. BASCOM.

A study of the petrography, structure, age and genesis of the gneisses in the vicinity of Philadelphia.

*Possible Pre-Wisconsin Till of Massachusetts:*  
MYRON L. FULLER.

In the central portion of this country, the deposits of till have been differentiated into sheets of different ages, but in New England the severe glaciation of the Wisconsin Period removed, as a rule, all traces of earlier tills. Recently, however, a number of exposures have been discovered in the region south of Boston in which highly oxidized or disintegrated tills are found to underlie the ordinary light buff till of the Wisconsin ice invasion.

This lower till contains from two to four times the amount of clay contained by the Wisconsin till, is composed almost entirely of deeply decayed or disintegrated materials, is marked by the presence of the bright colors characteristic of advanced oxidation, lies upon deeply altered and practically unglaciated rock surfaces, has no far-traveled rock fragments, and is sharply separated from the overlying till both by its color and by its composition.

This older till is probably to be correlated with the Kansan or pre-Kansan till of the central portion of the United States.

*The Waverly Group in Northeastern Ohio:* GEORGE H. GIRTY.

In 1900 an effort was made to trace eastward into Pennsylvania the members of Newberry's Waverly section in northern Ohio. The Berea grit of the Waverly group was found to be the equivalent of the Cussewago sandstone of northwestern Pennsylvania. The Orangeville shale of that region is the basal third of the Cuyahoga shale, in part equivalent to Orton's Berea shale. The Sharpsville sandstone representing the middle portion of the Cuyahoga is probably the stratum producing the lower falls at the village of Cuyahoga Falls. The Meadville shale can with little doubt be correlated with the upper portion of the Cuyahoga, and it seems probable that the Shenango sandstone and shale are the equivalents of the Logan group. It is doubtful if the Corry sandstone is represented in Ohio, while the Bedford and

Cleveland shales probably die out before reaching the Pennsylvania line.

F. L. RANSOME,  
DAVID WHITE,  
Secretaries.

## CHEMICAL SOCIETY OF WASHINGTON.

THE 125th regular meeting of the Society was held March 14th. The following papers were presented:

'Notes on a New Indicator,' by E. G. Runyan. In this paper were presented results on the determination of total acidity in both white and colored wines, using as indicator an alcoholic solution of malachite green and commercial rosolic acid or corralin. For comparison, results obtained on the same samples with phenolphthalein and litmus were also presented. The data given seemed to be favorable to the use of the corralin-malachite indicator in titrating wines and similar colored products.

'The Action of Saccharin on Sugars and other Carbohydrates,' by L. M. Tolman. The author stated that saccharin was being sold as a substitute for sugar, and that it was sometimes found mixed with cane sugar. The best method of determining the saccharin present is the Reid method, by which the saccharin is hydrolyzed to the acid ammonium salt of sulfo-benzoic acid, and the ammonia determined by distillation. The benzol-sulfimide was found to be a strong hydrolyzing agent, readily inverting cane sugar. With cane sugar the inversion was as complete as by the official method, and upon heating for a long time there was no destruction of sugar. Lactose and dextrose were not affected by the sulfimide, a fact that may be used in the determination of cane sugar in the presence of milk sugar or dextrin, or both.

'The Nature and Function of Soil Solutions,' by F. K. Cameron.

'Permanganate of Potash as a Chemical Antidote,' by V. K. Chesnut. After a critical discussion of the work of La Cerda, Antal, Schlagdenhauffen and Reeb, Moor, Wood and others, who applied dilute solutions of the permanganate as an antidote in cases of human poisoning caused by snake bites, phosphorus, oxalic and hydrocyanic acids, coronillin, morphine and various plant alkaloids, the writer gave the

results of some experiments made with the salt by Dr. E. V. Wilcox and himself in cases of the poisoning of sheep from eating plants. These experiments were made in Montana where hundreds of sheep are killed by certain poisonous plants every year. Preliminary experiments indicate that a one-per-cent. solution of  $KMnO_4$ , to which one per cent. of the sulfate of aluminum is added, is a wholly satisfactory antidote for poisoning by two of the most poisonous groups of plants of that State, the species of death camas, *Zygadenus*, spp. and the larkspurs, providing, of course, that it be given in the earlier stages of the poisoning. The sulfate of aluminum was added because of the greater oxidizing value which it confers upon the permanganate. The use of the mixed salts in cases of poisoning by other plants is to be further investigated.

L. S. MUNSON,  
*Secretary.*

#### PHILOSOPHICAL SOCIETY OF WASHINGTON.

The 533d meeting was held March 30, 1901. Mr. J. B. Baylor read a paper on the 'Magnetic Survey of North Carolina,' which had been carried on jointly by the State and the U. S. Coast and Geodetic Survey. The total cost was stated to have been \$16.70 per county, including the establishment at each county seat of a meridian line. Charts of isogonic lines showed many local irregularities, and that the declination had changed several degrees within one hundred and fifty years.

Mr. J. E. Watkins, of the National Museum, gave a half-hour paper on 'A Century of Land Transportation by Steam,' narrating the development of rails, wheels and locomotives, with especial reference to early American practice.

An interesting sketch of Titian R. Peale, one of the founders of the Society, was then read by Mr. A. C. Peale. Mr. Peale was born in 1799 and died in Philadelphia, in 1885. He was assistant naturalist with Long's expedition in 1819, and naturalist to the Wilkes' expedition about 1840; he drew the illustrations for many works on natural history, and for twenty-five years was an examiner in the U. S. Patent Office.

C. K. WEAD,  
*Secretary.*

The 534th meeting was held April 13, 1901. The first paper upon the program was by Mr. Edwin Smith, on the 'International Geodetic Association Latitude Service.' It consisted of a short general statement of the history of the development of our knowledge of the variation of latitude up to 1898, of the plan of observations devised by the International Geodetic Association in 1898, and of the very satisfactory progress made in carrying out this program at six stations nearly upon the thirty-ninth parallel. Lantern slides were exhibited showing the distribution of the stations in longitude, various curves illustrating the latitude variation, a graphical representation of the program of observation, and the instrument and observatory at Gaithersburg, Md.

Mr. Artemas Martin read a paper on the 'Properties of Rational Plane Triangles.'

JOHN F. HAYFORD,  
*Secretary.*

#### ANTHROPOLOGICAL SOCIETY OF WASHINGTON.

The 315th regular meeting of the Anthropological Society was held March 26th.

Mr. William Palmer demonstrated the method of making a life-mask, occupying only fifteen minutes in the operation, and without the use of quills placed in the nostrils.

Dr. I. Casanowicz exhibited Babylonian, Assyrian and Persian seals and four magic bowls from Hilleh, the bowls having inscriptions on the inside in early Aramaic and Syriac character. They are in a fine state of preservation, and the inscriptions consist of formulas for exorcism, but so far there is no clue to the method of their use. The seals shown were lately acquired by the National Museum, and among them are some of the finest examples of ancient cutting.

President W. H. Holmes exhibited several fine obsidian knives from California. One of the blades was  $20\frac{1}{2}$  inches long and 5 inches wide, and with it was shown a mass of solid obsidian of the size from which such an implement could have been made. The work of manufacture must have been attended by enormous difficulties. Mr. Holmes explained briefly the process of manufacturing of these remarkable specimens of stone-working.

The first stated paper was by Dr. W. W. Johnston on 'The Ill-health of Charles Darwin,' its nature, cause and its relation to his work. Dr. Johnston presented the results of an extended research into the life of Darwin, showing that up to the age of twenty-seven the philosopher was strong and vigorous; then followed thirty-six years of suffering, and eleven years of improvement to the date of his death. Dr. Johnston stated that the visible beginning of Darwin's intellectual life was during the voyage of the *Beagle*. These five years were characterized by constant strain of overwork, which was continued for several years after the voyage, though his nervous system was exhausted. The break-down of Darwin necessitated a strict regimen, the good results of which appeared in the last decade of his life. Dr. Johnston diagnoses the case as one of neurasthenia brought on by overwork, the symptoms appearing on the voyage of the *Beagle*. The prolongation of Darwin's life was due to the regimen adopted and the unremitting care given him by the members of his family. The paper was discussed by Dr. Frank Baker and Dr. Theo. N. Gill.

Dr. George M. Kober read a paper entitled 'The Progress of Charity Reform in the District of Columbia since 1896.' Dr. Kober's paper was more than locally interesting in showing what may be done by the application of rational methods to the charity problem. These are personal inspection as to the needs of applicants, stimulation to self-help by aid in securing employment, and the encouragement of small savings during times of production, to be drawn upon in times of stress. The progress noted under this system since 1896 is remarkable. Dr. Kober presented statistics showing a great diminution in applicants for aid, a heavy reduction of the expense of conducting the work, and a large increase in the number of those depositing savings.

WALTER HOUGH.

THE ACADEMY OF SCIENCE OF ST. LOUIS.

At the meeting of the Academy of Science of St. Louis on April 1, 1901, thirty-three persons present, a memorial notice of the late Judge Nathaniel Holmes, a charter member of

the Academy, was presented by a committee composed of Professor Nipher, Dr. Sander and Dr. Baumgarten.

Mr. John S. Thurman delivered an address on the many industrial uses now made of compressed air, illustrating his remarks by apparatus in operation, including electric motor air compressor, compressed air auger, drill, disinfecting atomizer, sculptors' and stone-cutters' tools, carpet renovators, etc., and a set of lantern slides showing the practical uses made of these and other implements and machines operated by means of compressed air.

Dr. Theodore Kodis exhibited, under the microscope, slides illustrating a new method of staining brain tissue, whereby, in four or five days, it has proved possible to prepare single or double stained preparations containing nerve cells with the dendrites of the latter brought out by a direct stain, instead of being differentiated merely as amorphous silhouettes, as is the case with the much slower Golgi process commonly employed. It was stated that the material is treated before sectioning, for about twenty-four hours, with cyanide of mercury, followed for approximately the same length of time by a formaldehyde solution, after which sections are cut, stained with phosphomolybdate hæmatoxylin and, if desired, a contrasting stain, such as one of the aniline greens, and mounted in the usual way.

WILLIAM TRELEASE,  
*Recording Secretary.*

THE ELISHA MITCHELL SCIENTIFIC SOCIETY,  
UNIVERSITY OF NORTH CAROLINA.

THE 134th meeting of the club was held on April 9th, when the following papers were read:

'First Aid to the Injured in the United States Army': Professor C. S. Mangum.

'The Work of the Commission for the Examination of the United States Mint': President F. P. Venable.

CHAS. BASKERVILLE,  
*Secretary.*

DISCUSSION AND CORRESPONDENCE.

OIL IN TEXAS.

TO THE EDITOR OF SCIENCE:—You doubtless have remarked that in various commercial journals the oil which flows in such

quantities from the Lucas and other wells near Beaumont, Texas, is said to come from Tertiary sands. As Geologist to the State of Louisiana I crossed over into Texas to examine the wells and their surroundings. I found them located on a slight rise of ground extending in a east-westerly direction. The length of this slight elevation is perhaps  $\frac{3}{4}$  mile, width  $\frac{1}{2}$  mile, and height about 25 feet above the flat surrounding prairie region. Few or no mounds were observed immediately around this rise, but upon the same they are small, but great in numbers. At the time of my visit there was but one well flowing, others not having reached the oil-bearing bed. Strict secrecy was kept as to the depth of the well. I was requested to pick up no specimens and to leave the premises. However, the shells surreptitiously obtained were sufficient to convince me that the Tertiaries were not completely penetrated; and the 'cap rock of the oil' shown in Beaumont seemed to be of decidedly Cretaceous appearance. The conclusion to be drawn was therefore that the well penetrated possibly a thousand feet of rather recent or newer Tertiary strata and then came upon some portion of a Cretaceous anticlinal fold or ridge. A statement to this effect was given to the New Orleans *Picayune*, March 27, 1901 (which see). To-day we notice that the same paper published, on April 10, a log of the Higgins well. We notice in complete corroboration of our theory the following items:

"1030 ft.—Oil-bearing sand, pebbles and sulphur.

"1040 ft.—Sulphur rock; solid.

"1045 ft.—Oil."

The well is therefore, as supposed, *i. e.*, a repetition of the 'Sulphur Miue' condition of Southwestern Louisiana, buried about twice as deeply beneath the surface by recent formations.

Through the kindness of Mr. Pattillo Higgins, a large holder in this new oil territory, we are assured of a set of samples and shells obtained from the various depths of his well. This will enable us to see just how much of the Tertiaries are missing between the Quaternary and Cretaceous oil beds.

G. D. HARRIS.

CORNELL UNIVERSITY, April 13, 1901.

DISCLAIMER NO. 2.

It is necessary that the undersigned inform the general public that the use made of their names by the 'American College of Sciences,' doing business at Philadelphia, in advertising an 'advanced course in personal magnetism, hypnotism and suggestion by seven distinguished specialists,' is wholly unauthorized and unwarranted. The public is warned against the trick of being thus led to believe that we concur in the statements made in this advertising scheme concerning the scientific facts and the practical uses of hypnotic influences. The undersigned believe that the practice of hypnotism should be restricted to a most guarded application.

Our names and the 'courses' advertised in this 'advanced course' are derived from articles which each of the undersigned was requested, individually, by the 'New York State Publishing Company,' of Rochester, N. Y., to prepare for a scientific exposition of the facts and principles of hypnotism and allied phenomena. The compilation appeared from the press late in 1900. Had the undersigned had any intimation whatsoever that this second and unauthorized use of the articles was to be made, *viz.*, as a part of a course of instruction in the general subject, they would have absolutely refused to contribute to the compilation in the first instance. The responsibility of each of the undersigned goes no farther than the contents of the original article he contributed to the compilation.

The disclaimer is to be taken in accord with the one appearing in *SCIENCE*, November 30, 1900, p. 850, and in *The Psychological Review*, January, 1901, p. 63. The names here undersigned appear in an advertising sheet circulated by the 'College' which omits the names appearing under the first disclaimer.

Signed EDWARD FRANKLIN BUCHNER,  
*New York University.*

A. KIRSCHMANN,  
*University of Toronto.*

JAMES ROLAND ANGELL,  
*University of Chicago.*

A. M. BLEILE,  
*Ohio State University.*

EDWIN DILLER STARBUCK,  
*Leland Stanford Junior University.*

## SHORTER ARTICLES.

## NOTES ON THE DEVELOPMENT OF THE POLLEN TUBE AND FERTILIZATION IN SOME SPECIES OF PINES.

DURING the past three years, I have devoted considerable time, under the direction of Professor George F. Atkinson, to a study of fertilization and related phenomena in certain species of pines. A preliminary paper was read before the Botanical Society of America at its Boston meeting, August, 1898. In June, 1900, a more complete report of the work was given in two papers, one of which was presented before the society named above at its meeting in New York City, and the other before the American Association for the Advancement of Science, which Association also met in New York City.

It has been found that the generative cell appears, as a rule, during the first summer rather than shortly before fertilization, as described by other investigators. This cell does not divide while in its place within the pollen grain, as stated by previous writers, but passes into the pollen tube before the sperm cells are formed. In the division of the generative nucleus, the spindle is monopolar in origin; it arises some distance below the nucleus in a prominent cytoplasmic condensation. From this denser area the protoplasm extends in a radial manner towards the periphery of the cell. The sperm nuclei are never separated by a cell wall, but remain surrounded by a common mass of cytoplasm. The two nuclei are of unequal size from the first, and the larger one is always in advance of the smaller one, as regards the apex of the pollen tube.

Just prior to fertilization a cavity is formed in the upper part of the egg cytoplasm. It is believed that this cavity represents the final act of the egg in its preparation for the reception of the sperm cell and other contents of the pollen tube. There is no evidence that it results from the presence, within the egg, of the elements from the pollen tube, as reported by certain writers. The sperm nucleus does not increase in size after its entrance into the egg, but remains much smaller than the nucleus of oösphere. The sexual nuclei come to lie side by side but do not fuse; both nuclei can still be

identified, even after the membrane of each has entirely disappeared. Two chromatic groups are clearly distinguished up to the nuclear plate stage.

In the division of the two segmentation nuclei, the chromatin of each nucleus forms two distinct spires, which doubtless represent the separated-out paternal and maternal chromatic substance. At the time of this second division within the oösphere, the smaller sperm nucleus, which still lies in the upper part of the egg, frequently gives rise to a mitotic figure of more or less definiteness.

Only a few of the results which have been obtained are noted above. Papers giving the details of this research, with discussion and plates, have been sent to the publishers and will appear shortly.

MARGARET C. FERGUSON.

BOTANICAL DEPT., CORNELL UNIVERSITY.

## NOTES ON ENTOMOLOGY.

WITH the December (1900) number the *Entomologische Nachrichten*, long edited by Dr. F. Karsch, closes its career. In its place will be issued a monthly index of entomological publications, called *Entomologische Literaturblätter*.

M. AUG. LAMEERE, in a recent proposed classification\* of the Coleoptera, divides the order, according to the variation of the median vein of the hind wings, into three suborders; viz., *Cantharidiformes*, *Staphyliniformes* and *Carabiformes*; the last is equal to the *Caraboidea* of Ganglebauer. The second suborder equals the *Staphyliinoidea* of that author with the important addition of the *Pulicida*.

M. Lameere's idea that the fleas are Coleopterous insects is certainly novel, and is based on a supposed affinity with *Platypsyllus*, the well-known parasite of the beaver. The *Cantharidiformes* contains all the other families.

M. Lameere makes a list of the characters that (according to him) must have been possessed by the ancestor of Coleoptera; these characters indicate a Neuropterous insect of the group of *Planipennia*. The most primitive Coleoptera he finds in the family *Lymexylidæ*.

\* Notes pour la classification des Coléoptères. *Ann. Soc. Ent. Belg.*, 1900, pp. 355-357.

In this family two genera are mentioned which possess prominent ancestral characters: *Atractodes*, with eight visible ventral segments, and *Hylecoetes*, with a rudimentary median ocellus.

PROFESSOR I. BOLIVAR describes \* and figures a remarkable Coleopterous larva belonging to the family Lampyridæ which he received from the Philippines. At a casual glance the figure looks much like that of some fossil trilobite. The thorax is extremely large and broad, the head apparently sunk in the prothorax; the abdominal segments are small and laterally produced. M. J. Bourgeois, who has examined the figure thinks that it may belong to the genus *Brozylus*, a genus close to our *Calopteron*.

A. SKORIKOW in an article on some Collembola from Spitzbergen † gives a résumé of the known distribution of Collembola on Arctic islands. Of the thirty-four species only fourteen have been recorded from more than one island. Six species are common to four different islands, five of these being well-known European forms. He also tabulates the percentage of species in the various families and compares it to the Russian Collembola. This shows that in the Arctic regions the Aphoruridæ, Poduridæ and Isotomini are the predominant types, while in Russia the Entomobryini and Smythuridæ are the predominant forms.

MR. F. O. P. CAMBRIDGE has begun ‡ a revision of the genera of spiders with reference to their type species. He differs considerably from both Simon and Thorell, who have previously investigated this subject. He makes several important changes in this part. The genus *Drassus* is held not to be a synonym of *Gnaphosa*; *Micromata* becomes transferred to the Clubionidæ, with *M. accentuata* Walck. as type; and *Salticus* has for its type *S. scenicus*, so that *Eptiblenum* falls to the synonymy. It is doubtful, however, if Mr. Cambridge's work will lead to greater uniformity in the use of genera of spiders, as so much depends on the rules used

\* Dos formas larvarias de lampiridos. *Act. Soc. Española de Historia Natural*, Vol. XXVIII., 1899, p. 130-133.

† Annuaire du Musée Zoologique Acad. Imp. St. Petersburg, Vol. V. (1900), p. 190-209.

‡ *Ann. Mag. Nat. Hist.*, 1901, Jan., pp. 51-65.

in type-fixation. Few of the ancient authors had the slightest idea of a genotype, so that every attempt to read this modern idea in their writings will be largely influenced by opinion. In fact there is less uniformity in the use of genera of spiders than there was ten years ago.

S. PROWAZEK has studied\* the development of a Collembolan, *Isotoma grisea*, and finds, among other interesting matters, that the antennæ are primitively post-oral, and attain their pre-oral position at a later stage.

MM. J. DANYSZ and K. Wize have published a little brochure † on the use of fungous diseases against *Cleonus punctiventris*, a weevil injurious to beets and mangel-wurzels in Central Europe. The value of this method had previously been shown by several Russian experimenters, notably by Professor Krassil'schik, of the University of Odessa. The work of the French writers has been principally on methods of inoculating the soil. They found that where the beet is cultivated by rotation every four or six years the fungus was apt to die out. Therefore, they have devised methods for inoculating the beet fields anew each year.

NATHAN BANKS.

#### WORKING OF PATENTS ACTS.

PROBABLY no single influence has had more to do with the advancement of the industrial interests of the United States and with the resultant prosperity of the nation than the patent-acts. They were fundamental elements of primary legislation on the organization of the Government, and Hamilton and other of those early statesmen to whom so much is due initiated a patent system as a first and most effective instrument in the development of manufactures in a country previously deprived of those industries through the repressive legislation of the mother country. The patent system of the United States became a model for the world and, very slowly but none the less steadily, other nations, one by one, took up its most distinctive methods. The United States promptly

\* *Arbeit Zool. Inst. Wien*, XII. (1900), pp. 335-370.

† De l'utilisation des Muscardines dans la lutte avec le *Cleonus punctiventris*. Paris, 1901.

secured a lead, as great in its field as has become, meantime, that of Germany in industrial education. During late years, the patent system of Great Britain, formerly exceedingly crude, costly to the inventor and the nation, and in all ways unsatisfactory to those who were unselfishly and honestly interested in the advancement of British trade, has been greatly modernized and liberalized; but it has not, even yet, been made fairly comparable with that of the United States.

An important commission, appointed by the Board of Trade and composed of some of the ablest experts and best known men in the kingdom, has just reported upon its operation and it is perhaps possible to deduce from this report conclusions that may be useful in promoting the still further improvement of our own system, of late years reduced rather than improved in its efficiency by legislation and by official interpretations of doubtful provisions of law. After examining into the operation of the British patent laws and receiving the testimony of officials of the patent office, of referees, litigants, users of patented articles, patent agents and experts, the commission reported.

It was found that, of patents issued, only 57.6 per cent. were actually novel and unanticipated by previous invention. Nearly 7 per cent. had been fully anticipated in all details; 35 per cent. had been partially anticipated; a few were claims on old devices and others described no method of manufacture. Forty-two per cent. had thus been anticipated, in whole or in part.

The commission states its opinion that the granting of invalid patents is thus a very serious evil and one which should be at once abolished. A method of examination like that of the U. S. Patent Office is recommended, and a scrupulous system of detection and elimination of anticipated claims. It recommends, however, a curious limitation: That "the publication of an invention in specifications of letters patent granted in the United Kingdom dated fifty years or more previous to the date of the application, or in a provisional application, of any date, of the kind before mentioned, shall not in itself be deemed an anticipation of the invention."

It is recommended that time, not to exceed two months (two years time is given in the United States Patent Office) should be allowed for amendment of a claim, and that a system of appeal, very like that long in operation in the United States, be allowed in case of rejection. This provision, restricting amendment to a period of two months, if it had been adhered to in the United States, would have prevented the litigation now in progress over the Berliner and other patents in this country, and would have saved a vast amount of expense to the litigants and insured a larger employment of inventions in improvement of existing practice and would have saved enormous injury to patentees and to the nation.

This British commission also considers the matter of compulsory licenses. It often happens, in that country as in this, that valuable patents are purchased by wealthy and powerful interests and simply held, unused, to prevent their competition with the holders and to evade that serious difficulty often met with in the compulsory replacement of existing and fairly satisfactory apparatus by the improved device. Every great corporation and many smaller organizations hold patents thus concealed and out of use, until their own special interests make it desirable to put them into use; and the public is thus defrauded of all that advantage, meantime, which is its proper compensation for the establishment and maintenance of a patent system. The British patent laws have, for nearly twenty years, provided, as have *not* those of the United States, against this abuse. It is made the duty of the proper officials to grant an order compelling the holder of the patent to grant licenses on terms to be adjudged fair and equitable by the proper government officials. This provision has been subject to some criticism in its details, and the commission advises its amendment and improvement; adhering, however, to the underlying principle that the public should not lose its rights or the advantage assumed to be gained by it when providing the legal forms of a patent system and of protection to the inventor. It is recommended that the 'High Court' shall receive and consider complaints reciting the facts, if they so prove, that the applicant is in-



interested in the invention, that the reasonable requirements of the public have not been satisfied, by reason of the refusal or neglect of the patentee to work, or to grant licenses to work, the patent, and that the court, if the assertions of the claimant appear to be justified by the facts, shall make an order conferring a license upon the applicant on terms found by the court itself to be just and reasonable.

Reciprocity in patent matters is advised as between Great Britain and other countries prepared to offer similar facilities and protection for the foreign patentee. It would be an excellent reform could a real international reciprocity, based on the best practice of the United States, be arranged to include Germany; which country has illustrated some very objectionable and inequitable patent law methods.

Should the recommendations of the commission be accepted and the British Office be reconstructed as proposed, it will provide as practically satisfactory a system of protection as does that of the United States; changing thus from one of the most useless to one of the best of patent systems of the time. It will be interesting to note whether Great Britain, after all, will ultimately provide a more equitable system in regard to purposely delayed issues and unworked patents—the two main defects and abuses of the existing law of the United States—than our 'pioneer' code now offers. It will be most discreditably if our committees of Congress and our Commissioners of Patents do not initiate, and Congress perfect, remedies for these two radical and inexcusable defects in our own patent law.

R. H. THURSTON.

#### A MINERAL SURVEY IN TEXAS.

THE Legislature of the State of Texas has recently passed an act (House Bill 135), approved by the Governor, March 28, 1901, providing for "a mineral survey of the lands belonging to the public schools, university and asylum, or of the State, and to make appropriation therefor, and to provide a penalty for unlawfully disclosing information obtained by such survey; and to loan and authorize the removal to the University of the geological and scientific equipments, collections, specimens and

publications now in charge of the Commissioner of Agriculture, Insurance, Statistics and History; and also declaring an emergency."

By Section 1 the "Board of Regents of the University of Texas are authorized and directed, as soon as practicable, to have made a mineral survey of all lands belonging to the public schools, university, asylums, or of the State."

Section 2 requires that "said Board shall employ for that purpose persons skilled, who have had at least five years' experience, in the science of mineralogy, geology and chemistry, who shall conduct said survey. \* \* \*"

Section 3 relates to the publication annually 'for free distribution among the people of the State [of] all practical information collected in the prosecution of said survey as it progresses.' It provides, as a penalty, a fine 'not exceeding one thousand dollars or two years in jail' for divulging information concerning the public school, university, asylum or State lands in advance of publication.

In Section 4 provision is made 'for assays, analyses and other scientific examinations of specimens of mineral substances found in the State, and for the collection and distribution of statistics relating to the mineral production of the State. \* \* \*' For the assays, etc., a 'uniform and reasonable charge shall be fixed,' except at the request of the Governor or Commissioner of the General Land Office the examination of specimens found upon any of the public lands shall be made free of charge.

Section 5 provides for instruction in the University of Texas 'in practical economic and field geology and mineralogy,' and for the distribution of duplicate specimens to the A. and M. College.

Section 6 authorizes the removal of the specimens, books, and equipment (brought together by the Dumble Survey) now in charge of the Commissioner of Agriculture, Insurance, Statistics and History, to the University. These materials are 'loaned to said board, until such time as the State may desire to otherwise use them.'

Section 7 reads as follows: "For the purpose of carrying out the provisions of this Act, the sum of ten thousand dollars per annum for two years, or so much thereof as may be necessary,

is hereby appropriated out of the general revenue of the State; provided that said mineral survey of the State shall be completed within two years."

Section 8 repeals all laws in conflict with the Act, and Section 9 declares an emergency.

It is the intention of the Board of Regents to immediately institute the work of the survey, which will probably be under the direction of Dr. William B. Phillips, who is in charge of economic and field geology in the University.

FREDERIC W. SIMONDS.

SCHOOL OF GEOLOGY,  
UNIVERSITY OF TEXAS, April 6, 1901.

*PROPOSED SURVEY OF THE ANTIQUITIES  
OF MICHIGAN.*

THE following bill has been introduced in the Michigan Legislature, was reported favorably by the Committee on State Affairs, and is at present referred to the Committee on Ways and Means. An amendment limiting the survey to two years has been made.

The people of the State of Michigan enact :

SECTION 1. That a survey of the antiquities of Michigan be, and the same is hereby established.

SECTION 2. That the survey shall be in charge of a commission comprising the Governor of the State *ex-officio*, the President of the University of Michigan, the President of the Michigan Academy of Sciences, the President of the Pioneer and Historical Society and the President of the Detroit Archeological Society; this commission to serve without compensation, but to be reimbursed for their actual and necessary expenses.

The commission shall have the power to employ an archeologist and one or more assistants and to make such incidental expenditures as the nature of the work may require. The accounts for salaries and other expenses provided herein shall be paid upon the warrant of the Auditor-General monthly, upon the approval of the Governor. At the end of each fiscal year the commission shall cause to be made an annual report, the copy for which, as soon as completed, shall be forwarded to the clerk of the Board of State Auditors for publication by the State printer, the expense of such publication to

be paid from the general fund of the State upon the allowance of the Board of State Auditors.

SECTION 3. For the purpose of carrying out the provisions of this act, exclusive of the cost of publishing the annual reports, there is hereby appropriated from the general fund of the State for the fiscal year ending June thirty, nineteen hundred and two, and each fiscal year thereafter, the sum of two thousand five hundred dollars.

*THE DAVENPORT ACADEMY OF SCIENCE.*

THE annual meeting of the Academy was held on January 25th in Davenport, Iowa. The reports for the year were most encouraging.

We learn from Mrs. Mary L. D. Putnam, President of the Academy, that the Academy has purchased the corner property adjoining its present building and converted the church into a most attractive lecture hall; the high basement makes a fine room to relieve the former crowded museum. The two buildings are connected by a spacious and well-lighted passageway which may also be utilized for museum purposes.

The scientific library of 10,800 bound volumes has been completely catalogued exclusive of a large collection of pamphlets. The library has been acquired by the exchange of the proceedings of the Academy with home and foreign scientific societies.

The Academy is one of the oldest of the scientific institutions in the West, and on December 14, 1900, celebrated the 33d anniversary of its founding by the dedication of Science Hall. President MacLean and Professor Nutting of the State University of Iowa made addresses, and Professor Starr, of the University of Chicago, gave a lecture 'Among Mexican Indians.'

It is planned to give free scientific lectures from time to time in this hall.

With its large museum, especially rich in archeology and enlarged by the recent gift of the rare Griswold College Collection, including 2,000 scientific books, and with its valuable property, the Academy is on a permanent basis, needing only an addition to its general endowment fund.

The publication is assured by the Putnam Memorial Fund. The income of this fund of

\$10,000 has enabled the Academy this last year to bring out Volume VII., containing 316 pages and seventeen full-page plates.

*PROPOSED JOURNAL FOR THE STATISTICAL STUDY OF BIOLOGICAL PROBLEMS.*

It is proposed to establish a *Journal of Biological Statistics* which may serve as a means not only of collecting under one title biological data of a kind not systematically collected or published in any other periodical, but also of spreading a knowledge of such statistical theory as may be requisite for their scientific treatment. The following remarks are offered in justification of this proposal :

A very few years ago, all those problems which depend for their solution on a study of the differences between individual members of a race or species were neglected by most biologists. The complexity of organic structure is so great, and the number of distinguishable forms so enormous, that morphologists were obliged to simplify their conceptions by constructing for every species an ideal type, to which the individuals composing it conform with more or less exactness, and to neglect those deviations from the type which actually occur. Such simplification was not only justifiable, but absolutely necessary for many purposes; it has rendered enormous service to biology in the past, it does so still and will continue to do so; nevertheless, there are many problems which can not be dealt with by its aid.

The starting point of Darwin's theory of evolution is precisely the existence of those differences between individual members of a race or species which morphologists for the most part rightly neglect. The first condition necessary, in order that any process of natural selection may occur among a race or species, is the existence of differences among its members; and the first step in an enquiry into the possible effect of a selective process upon any character of a race must be an estimate of the frequency with which individuals, exhibiting any degree of abnormality in respect to that character, occur. The unit, with which such an enquiry must deal, is not an individual but a race, or a statistically representative sample of a race; the result must

take the form of a numerical statement, showing the relative frequency with which the various kinds of individuals composing the race occur.

As it is with the fundamental phenomenon of variation, so it is with heredity and with selection. The statements that certain characters are selectively eliminated from a race can only be demonstrated by showing statistically that the individuals which exhibit that character die earlier, or produce fewer offspring, than their fellows: while the phenomena of inheritance are only by slow degrees being rendered capable of expression in an intelligible form as numerical statements of the relation between parent and offspring, based upon statistical examination of large series of cases, are gradually accumulated.

These, and many other problems, involve the collection of statistical data on a large scale. That such data may be rendered intelligible to the mind, it is necessary to find some way of expressing them by a formula, the meaning of which can be readily understood, while its simplicity makes it easy to remember. The recent development of statistical theory, dealing with biological data on the lines suggested by Mr. Francis Galton, has rendered it possible to deal with statistical data of very various kinds in a simple and intelligible way, and the results already achieved permit the hope that simple formulæ, capable of still wider application, may soon be found.

The number of biologists interested in these questions, and willing to undertake laborious statistical enquiries, is already considerable, and is increasing. It seems, therefore, that a useful purpose would be served by a journal especially devoted to the publication of statistical data, and of papers dealing with statistical theory. Many persons are deterred from the collection of such data, by the difficulty of finding such a means of publishing their results as this journal would afford, and those results which are published frequently lose much of their value because the data on which they are based are withheld, or because they are isolated in publications largely devoted to other forms of investigation.

It is suggested that '*Biometrika*, a Journal for

the Statistical Study of the Problems of Evolution,' should be published, in the first instance, quarterly, four numbers forming a volume. It is hoped that it will include (a) memoirs on variation, inheritance and selection in animals and plants, based upon the examination of statistically large numbers of specimens (this will of course include statistical investigations in anthropometry); (b) those developments of statistical theory which are applicable to biological problems; and (c) abstracts of memoirs, dealing with these subjects, which are published elsewhere. It is proposed to include memoirs written in English, German, French or Italian.

The expense of such a journal would be at first considerable, and it cannot be undertaken without some promise of support. Those willing to assist in supporting such a journal are requested to write either to Professor Karl Pearson, F.R.S., University College, London, or Professor W. F. R. Weldon, F.R.S., Merton Lea, Oxford, agreeing to purchase the first volume of *Biometrika* at the price of 30 shillings.

#### RESIGNATIONS FROM THE SCHOOL OF PEDAGOGY NEW YORK UNIVERSITY.

We published last week a letter from Professors Weir, Buchner and Judd announcing their resignation from the School of Pedagogy, New York University. In view of comments made by Chancellor MacCracken, we have been asked to publish the following statement signed by Professors Weir, Buchner and Judd:

There have been long-continued disagreements within the Faculty of Pedagogy on points of general policy. The advice of the Chancellor on these matters could not be obtained, as the Chancellor has declined to attend Faculty meetings for more than a year, and has not attended more than two or three times during the last three years. Appeals made to the authorities of the University on matters of general policy were not taken up for definite consideration until in February of this year when two long hearings were held before a Council Committee, consisting of Chancellor H. M. MacCracken, Dr. George Alexander, Chairman; Willis Fletcher Johnson, Secretary; Henry Vau Schaick, and a number of ladies of the woman's advisory committee, including Mrs.

Henry Draper, Miss Helen M. Gould, and Mrs. Eugene Smith. These hearings dealt with questions of administration and curriculum.

After these two hearings and after a meeting of the council of the University on March 4th, the Chancellor announced to the members of the faculty that he had accepted the resignation of the dean of the School of Pedagogy from the deanship. The Chancellor also sent word to one of the members of the faculty that the general theory of reconstruction would make it necessary to vacate his chair in order to make room for a new Dean. The member who was thus to be superseded made an effort to find out the grounds of this theory of reconstruction. He was informed that no criticisms of his academic work and conduct had been communicated to the Chancellor. The only semblance of a reason for the theory appeared in certain vague and indefinite impressions entertained by some of the members of the woman's advisory committee. The other two members of the faculty made an effort to find out the grounds of this theory of reconstruction. They were unable to find reasons other than those already stated, excepting the additional fact that the Chancellor had not in the beginning favored the appointment of this professor. They accordingly entered a vigorous protest, both in person and by correspondence, to the Chancellor and Dr. George Alexander, against what they regarded as an unwarranted and unjust line of action.

The committee of the council, including the members of the woman's advisory committee, then held on April 4th a meeting, and passed a resolution to recommend to the Council that the chairs of all professors of the Faculty of Pedagogy, not vacated by resignation, be declared vacant by the council at its May meeting. It should be noted that this resolution applies not merely to the three professors who have resigned, but to all professors in the School of Pedagogy.

On learning of this action on the part of the Council Committee, the members of the faculty made an effort to get into correspondence with the Chancellor and secure some statement of the grounds of this latest action. The Chancellor withheld the information requested; where-

upon, Professors Weir, Buchner, and Judd resigned from the University. The following is a copy of the resignation sent by each of the professors to the Chancellor :

April 12th.

To the Chancellor of New York University :

Because of long-continued dissatisfaction with the administration of the School of Pedagogy, and because I have learned that the repeated efforts of certain members of the faculty to improve this administration, while they have met with a sufficient degree of official approval to mark these efforts as thoroughly justifiable, have, notwithstanding, resulted in a resolution on the part of a Committee of the University Council to recommend that the chairs of [all] Professors of the School of Pedagogy be vacated at the May meeting of the Council, I therefore resign my professorship in the University, this resignation to take effect at the close of this university year.

I respectfully request that an official statement of the fact, which has been at different times informally stated, that my academic work and conduct as a professor in the University have been satisfactory, be sent to me at once.

A MEETING of students and alumni of the School of Pedagogy was held in the University Building, Washington Square, on April 20th, and the following resolution was passed :

To the Council of the New York University :

We, the former and present students of the School of Pedagogy of New York University, having learned through the public press of the resignations of Professors Weir, Buchner and Judd [from the Faculty of the School of Pedagogy :

Hereby beg leave to express our firm belief that the loss of these professors from the Faculty will greatly weaken public confidence in the institution, and will undoubtedly impair its usefulness in the future. These gentlemen are everywhere recognized as thorough scholars, inspiring instructors, and men of sound judgment and impressive personality.

We beg leave, therefore, to express our further conviction that the University will do itself and the educational public of this city a service by securing, if possible, a withdrawal of these resignations.

#### SCIENTIFIC NOTES AND NEWS.

MR. ALEXANDER AGASSIZ, of Cambridge, Mass., has been elected president of the National Academy of Sciences. The further transactions of the Academy are recorded in a special article published above.

PROFESSOR G. L. GOODALE, of Harvard University, has been appointed delegate from the National Academy of Sciences to the International Association of Academies meeting in Paris.

PROFESSOR E. B. WILSON, of Columbia University, has been invited to deliver the annual address before the Medical School of Yale University.

PRESIDENT ELIOT, of Harvard University, is expected to return to Cambridge this week. He has been for the past three months in Bermuda and the West Indies.

WE learn from the *Botanical Gazette* that a handsome silver loving cup was presented by a number of teachers to Mr. Thomas Meehan, the veteran horticulturist and botanist of Philadelphia, on the occasion of his seventy-fifth birthday.

DR. JAMES E. TALMAGE, professor of geology in the University of Utah, has been elected a life associate in the Philosophical Society of Great Britain, otherwise known as the Victoria Institute, and also a corresponding member of the Royal Scottish Geographical Society.

MR. L. DE NICÉVILLE has been appointed entomologist in the Indian Museum, Calcutta.

WE learn from *Nature* that Professor Eugen Warming and Dr. Victor Madsen have been appointed to the Danish Geological Survey, and that Dr. H. Topsøe has retired from the Survey.

THE Adams prize of Cambridge University for the present year has been awarded to Mr. H. M. MacDonald, of Clare College, for a paper on 'Electric Waves.'

MR. C. E. BORCHGREVINK, the Antarctic explorer, has been created a Knight of the Order of St. Olaf by King Oscar of Sweden and Norway.

DR. ROBERT E. MORITZ, of the University of Nebraska, has received leave of absence for next year which he will spend in study in Germany.

PROFESSOR WATASÉ informs us that at the meeting of the Zoological Society of Tokio, held at the Zoological Institute of the University of Tokio, March 15, 1901, Professor Bashford Dean, of Columbia University, gave an account of his trip to the Philippines. Among others,

he gave a very graphic account of the habits of *Nautilus* which he had observed during his stay at Negros.

PROFESSOR FREDERICK W. STARR, of the University of Chicago, has returned from a four months' expedition among the Mexican Indians. He has secured valuable busts, photographs and collections.

THE section of vertebrate paleontology of the Carnegie Museum will have four field parties engaged during the coming summer in exploring the fossil-bearing horizons of the West. The work will be under the general direction of Mr. J. B. Hatcher, the Museum's curator of vertebrate paleontology. One party will operate near Cañon City, Colorado, where during the past winter a valuable deposit of Dinosaur bones has been unearthed by Mr. W. H. Utterback. A second party will be in charge of Mr. C. W. Gilmore, and will continue the work that has been so successful during the past two seasons in southern Wyoming. A third party will be in charge of Mr. O. A. Peterson, and will explore the Tertiary deposits of western Nebraska, while the fourth party will devote its attention to the Cretaceous and Tertiary deposits of southern Montana. Important results are expected from the various field parties.

DR. HENRY C. COWLES will conduct an expedition of students from the botanical department of the University of Chicago to the mountains of northwestern Montana and northern Idaho during August and a part of September. The purpose of this trip will be an ecological study of the various mountain conditions.

S. M. TRACY, of Biloxi, Miss., has chartered a schooner for the summer, and will spend the next six months in a botanical exploration of the islands along the coast of the Gulf of Mexico. May, June, September and October will be spent on the south Florida coast, and July and August on the Texas coast.

PROFESSOR ENGLER, director of the Botanical Garden at Berlin, is about to visit the Canary Islands, in order to study their flora; at the same time the botanist, Dr. Josef Bornmüller, will also make an expedition.

THE funeral of the late Professor Henry A. Rowland took place during the recent meeting of the National Academy of Sciences, and Dr. S. P. Langley, Secretary of the Smithsonian Institution, and Dr. T. C. Mendenhall, President of the Worcester Polytechnic Institute, were appointed a committee to represent the Academy.

A PORTRAIT of the late Dr. William Pepper was presented to the American Philosophical Society on April 12th by a number of members of the Society. An address was made on the occasion by Dr. Horace Howard Furnace.

DR. FREDERICK J. BROCKWAY, assistant demonstrator in anatomy in the College of Physicians and Surgeons, Columbia University, died of meningitis at Brattleboro, Vt., on April 21st. He was born in 1860 and took his A.B. at Yale and his M.D. from the College of Physicians and Surgeons.

WE regret also to record the death of Richard P. Rothwell, since 1873 editor of the *Engineering and Mining Journal*. He was born in Ontario, Can., in 1836, and studied at Trinity College, Toronto, the Rensselaer Polytechnic Institute and the Paris School of Mines. Mr. Rothwell made numerous inventions and had a large practice as consulting mining engineer. He was president of the American Institute of Civil Engineers in 1872, and was a member of numerous foreign and American Scientific Societies. In connection with the *Engineering and Mining Journal* he published annually 'The Mineral Industry, its Statistics, Technology and Trade,' and the company of which he was president, The Scientific Publishing Company, issued many books relating to industry and mining. His death, which was due to cancer, occurred on April 17th.

PROFESSOR JOSEF VON FEDOR, professor of hygiene in the University of Buda Pesth and the author of many works on this science, has died at the age of fifty-seven years.

THE death is also announced of Dr. P. Kohlstock, lecturer on tropical hygiene at the University of Berlin, and known for his researches on cholera and other subjects. He died at Tien-Tsin, where he was engaged in research.

A PRESS cablegram from Berlin states that Dr. Menke, leader of a German scientific expedition in the South Sea Islands, has been murdered by natives of Macquarie Islands. Two other members of the expedition were wounded.

THE Legislature has not made an appropriation with which the New York Pathological Institute can pay rent for the laboratory it now occupies, and it will be necessary to remove the fine equipment to Manhattan State Hospital on Ward's Island. Dr. Ira Van Gieson will not be continued as director of the Institute after the first of May.

A CORRESPONDENT in San Francisco informs us that the bill making it a felony to publish that cholera or bubonic plague exists within the State of California, unless the fact has been entered on the minutes of the Board of Health, after having been passed by one branch of the Legislature was dropped. Dr. John J. Kinyoun, federal quarantine officer at San Francisco, to whom we understand the investigation of the plague in that city was due, has been transferred at the request of commercial organizations. The attitude of the San Francisco press towards the investigations of the plague by the federal authorities is shown by the following extract from the *Call* of April 16th.

Dr. Kinyoun was the worst enemy the State had ever had. His circulation of bubonic plague reports inflicted incalculable injury upon the State in general and San Francisco in particular. The salient fact that a number of deaths in the Chinese quarter during the past twelve months, with Dr. Kinyoun's bubonic nightmare thrown in, was no greater than for any one of the preceding years, could not stay the damage done by Kinyoun's sensational declarations.

In the London *Times* and in *Nature* we find some information regarding the inaugural meeting of the International Association of Academies which was called to meet in Paris on the 16th inst. The following delegates were expected to be in attendance: Amsterdam, Professor H. G. van de Sande Bakhuyzen, president of the physico-mathematical section of the Academy; Professor H. Kern, president of the section of letters; Professor J. de Goeje. Berlin: Professor H. Diels and Professor W. Waldeyer, permanent secretaries of the Prussian Royal

Academy of Sciences; Professor R. Helmholtz; Professor J. H. van't Hoff; Professor T. Mommsen; Professor E. Sachau. Brussels: Lieutenant-General de Tilly; Professor P. Fredericq. Budapest: Professor C. Than; Professor I. Goldziher. Christiania, not yet announced. Göttingen: Dr. E. Ehlers and Dr. F. Leo, secretaries of the Society; Professor E. Riecke. Copenhagen: Professor J. L. Heiberg; General G. Zachariae. Leipzig: Professor W. His; Professor A. Fischer; Professor H. Gelzer. London: Sir Michael Foster and Professor A. W. Rücker, secretaries of the Royal Society; Dr. T. E. Thorpe, foreign secretary of the Society; Sir Norman Lockyer; Sir Archibald Geikie; Professor A. R. Forsyth; Professor E. Ray Lankester; Professor A. Schuster. Munich: Professor W. Dyck; Professor F. Lindemann; Professor K. Krumbacher. Paris, Academy of Inscriptions and Belles Lettres: Count De Lasteyrie, president; MM. P. Berger, vice-president; H. Wallon, permanent secretary; L. Delisle; G. Boissier; Bréal; Barbier De Meynard; Senart; E. Müntz. Academy of Sciences: MM. Fouqué, president; Bouquet de la Grye, vice-president; Berthelot and Darboux, permanent secretaries; Marey; H. Poincaré; Moissan; Lannelongue. Academy of Moral and Political Sciences: Count de Franqueville, president; G. Picot, permanent secretary; Gréard; Glasson; Lachelier; Sorel; Boutroux. St. Petersburg: MM. Famintzin; Backlund; Oldenbourg; Kouliabko. Rome: Professor S. Cannizzaro; Professor A. Mosso; Professor I. Guidi. Stockholm: Professor G. Retzius, president of the Academy of Sciences. Washington: Professor G. L. Goodale. Vienna: Professor Victor von Lang, general secretary of the Academy of Sciences; Professor T. Gomperz; Professor Leopold von Schroeder; Professor J. Karabacek; Professor J. C. Zirecek; Professor A. Rollett; Professor G. Tschermak. The delegates were to be officially welcomed to Paris by the French Government and the Institute of France; and the arrangements for their pleasure included receptions at the Château de Chantilly, bequeathed to the Institute of France by the Duc d'Autumale, at the French Academy and elsewhere, a visit to the Bibliothèque Nationale under the conduct of its

accomplished director, M. Léopold Delisle, and a special representation at the Comédie Française. On Thursday, the 18th, the Institute of France would give a dinner in honor of the assembly, and on Saturday the delegates were to be entertained at a banquet by the Paris Municipal Council. Regarding the scientific work of the Association, we find less information, but it is said that the Royal Society has on the agenda a proposal relating to the desirability of connecting the measurements of Struve upon the arc of meridian  $30^{\circ}$  E., with those of Gill on the same meridian in South Africa, and the Paris Academy raises the question of the standardization of the recording instruments used in physiology and increased uniformity in the methods of that science.

THE American Metrological Society held its annual meeting at Washington on April 19th with the President, Dr. T. C. Mendenhall, in the chair. Dr. Mendenhall made an address on the recent progress of the metric system here and abroad. Among the other papers was one by Dr. S. W. Stratton, director of the newly established Bureau of Standards, on the plans for the Bureau.

THE annual meeting of the Society for the Promotion of Engineering Education will be held at Buffalo, June 29, July 1 and 2, 1901. The sessions will be held in 933 Ellicott Square.

THE Buffalo Society of Natural Sciences has announced a series of lectures to be given by Mr. Frederick Houghton of the Buffalo schools beginning April 25th. They are on physical geography and are designed specially for teachers. Each lecture will be followed by an excursion to study the local physical conditions described.

THE subject for the Adams Prize at Cambridge University for 1903 is 'The bearing on mathematical physics of recent progress in the theory of the representation of discontinuous quantity by series, with special consideration of the logical limitations of the processes involved,' the value of the prize is about \$1,100, and it is open to those who have taken a degree at Cambridge. The subject for the Sedgwick prize, 1903, is 'The Petrology of some Group of British Sedimentary Rocks.'

THE Fossati Prize of the Lombard Academy of Sciences and Letters will be awarded in 1902 for an essay on the 'Minute or gross anatomy of the brain.' In 1903 the subject is 'The termination of the cranial nerves in the brain.' The prize is of the value of about \$400 and is open only to Italians.

THE *American Mathematical Journal* announces that the Naples Academy of Mathematical and Physical Science has awarded its mathematical prize of 100 lire for 1899 to Dr. G. Torrelli at Palermo for his work on the totality of prime numbers. The subject for the next award is the theory of invariants of the ternary biquadratic, considered preferably in relation to the condition for splitting into lower forms. The essays, which may be written in Italian, French or Latin, must be sent in before March 31, 1902. The next annual prize of the Madrid Academy of Sciences will be awarded for a historical memoir on the Spanish mathematicians of the 16th century.

THE Peruvian Government has offered to give Harvard University additional land for its observatory at Arequipa.

MAYOR VAN WYCK has approved the bill passed by the Legislature enabling the city of New York to accept Mr. Andrew Carnegie's gift of \$5,200,000 to erect sixty-five branch libraries.

REUTER'S AGENCY is informed that the whaler *America* which has been bought by Mr. Evelyn B. Baldwin, the American explorer, for his forthcoming journey to the North Pole, will sail from Dundee on June 18th, by which date Mr. Baldwin expects to arrive from the United States. The *America* will proceed direct to Norway, where she will join the two other ships which are to form part of the expedition, and, after taking on board stores and equipment, will proceed North. Mr. Baldwin will, it is said, take with him 500 dogs and a number of mules. Work is now in progress for preparing the *America* for her voyage, the ship having been fitted with new masts and a new fore-castle, and having been practically re-decked. The vessel, formerly known as the *Esquimaux*, is an auxiliary steam whaler, and has been employed in the whaling industry for



nearly 30 years. Recently she was chartered as a private yacht, and, in addition to the accommodation usual on whalers, has had a suite of commodious cabins specially built in a deck-house aft. Her tonnage is 800, and her 100-horse-power engines give her a speed of seven knots. She is a good sea boat and well fitted to withstand Arctic ice pressure; last year while in Davis Straits she succeeded in getting out of the ice-pack from which a number of other whalers were unable to extricate themselves. Mr. Baldwin has himself left New York to join the *America*. We are unable to learn what scientific men are accompanying the expedition or what scientific work is proposed.

THE daily papers report that the department of physics of Cornell University has set up a camera with which to take each day one picture of the new anatomical laboratory in course of construction. The negatives will be taken on a long bioscopic film, and be used to produce a moving picture of the building from the beginning of its foundation to its completion.

THE *Experiment Station Record* states that the agricultural council of the Russian Ministry of Agricultural and Imperial Estates has taken steps in the direction of improving the character of the live stock and the live stock industry in general of that country. At present this industry is said to be far behind that of other countries, the animals kept being inferior and stock-raising receiving comparatively small attention from the farmers. The council has recommended the holding of live-stock shows, with prizes for excellence, the establishment of breeding farms and furnishing of expert assistance in purchasing good breeding animals, the maintenance of local breeding establishments where the service of pure-bred animals can be secured, and loans to municipalities and societies for the purpose of purchasing pure-bred animals and providing for their care. In order to carry out the above measures the Ministry of Agriculture, with the concurrence of the Minister of Finance, has recommended an appropriation of 5,000,000 rubles (about \$2,000,000) to begin this work and a quadrennial appropriation of 1,125,000 rubles.

WE learn from the same source that at the

third agricultural congress, held at Barbados, January 5th, Dr. D. Morris, commissioner of agriculture for the West Indies, described the progress which is being made under the Imperial Department of Agriculture in the direction of agricultural experimentation and investigation. During the year three new experiment stations have been established at Montserrat and one at Tortola for the Virgin Islands. At the present time there are 9 botanic stations maintained from imperial funds under the charge of the Imperial Department of Agriculture. In addition, there are 20 substations, or experiment plats, started at Grenada, St. Vincent, St. Lucia and Dominica to encourage the improved cultivation of cacao, coffee, limes and other crops. There are 12 central, mauerial and local stations associated with the sugar-cane experiments at Barbados, 7 similar stations at Antigua and 3 at St. Kitts-Nevis. Experimental cultivation with food and other crops will be carried on in connection with all the agricultural schools. During the past year lectures to teachers in charge of elementary schools have been carried on in every part of the West Indies, and the belief is expressed that within a year or two, in the smaller islands at least, every teacher in charge of a school should be qualified, not only to give a certain amount of instruction in the principles of agriculture, but also to interest the children by simple experiments followed by practical demonstrations in the cultivation of plants suited to the district. The first agricultural school in the West Indies affording secondary education for boys was opened at St. Vincent in September, and a similar school was opened at Dominica in December, 1900. It is planned to establish two more agricultural schools during the present year, one at St. Lucia and another, combining the characters of an agricultural school and grammar school, at St. Kitts. Seven scholarships in agriculture at Harrison College, Barbados, have been established by the Imperial Department of Agriculture. Agricultural fairs have been successfully conducted, and have proved of value in stimulating effort toward better production. The Department of Agriculture has encouraged these by prizes amounting to £350 and the distribution of 100 diplomas.

## UNIVERSITY AND EDUCATIONAL NEWS.

THE Minnesota Legislature has appropriated \$60,000 for the College of Engineering of the State University.

THE University of Cambridge conferred last year degrees as follows: M.D., 13; Sc.D., one; Litt.D., one; Mus.D., one; B.D., three; M.A., 342; LL.M., 11; M.B., 49; B.Ch., 61; B.A., 668; LL.B., 44; Mns.B., two.

A PROPOSAL is before the German Federal Council to admit to the medical course in the University students who have certificates from the Realschule, instead of insisting as heretofore upon the classical training of the Gymnasia. The Berlin Medical Society, at a recent meeting, discussed, according to the *British Medical Journal*, this question, and passed a resolution affirming that the certificate of classical instruction should alone give the right of admission to the medical examinations, but on the proposition of Professor Virchow it was agreed to add the declaration that the admission of pupils from modern schools to the medical classes should be subject to the same rules as in the other faculties.

FOR some time there has been an agitation in Liverpool to have a university established in that city. We learn from the *London Times* that Mr. A. L. Jones, of Messrs. Elder, Dempster, and Co., has brought the subject under notice in a practical form. At a recent dinner in commemoration of the new steamer, *Sekondi*, just added to the West African fleet of Messrs. Elder, Dempster, and Co., being about to start on her maiden voyage, Mr. Jones, in proposing 'The African Trade,' said that they had a tropical school in Liverpool which had done a great deal to reduce mortality from tropical diseases, and they hoped to have a cathedral and a university. He would be delighted to see a university established, and would be pleased to give a contribution of £5,000 towards that purpose. That was not much, and he was glad to think that the contributions to follow would be much larger. Manchester men did not treat their native city as Liverpool men did. Liverpool must have a cathedral and a university, and not continue

to shirk her responsibilities. Mr. A. F. Warr, M.P., in proposing 'The Liverpool School of Tropical Medicine,' said that they would not have discharged their duties until they had established a cathedral and university in the city. Professor Boyce responded, and referred to the loss sustained by the death of Dr. Myers, whose family had given £1,000 to the school, and his brother £500. They had established an absolutely international school, which had served as an example to others. Fellowships had been established at University College for the benefit of colonials and others, and the school has shown what a success a real university could be made in Liverpool.

MR. SAMUEL M. COULTER, fellow at Chicago University, has been appointed instructor in botany at Washington University.

AT Columbia University the John Tyndall Fellowship has been awarded to Mr. Berger Davis of New York and the Barnard Fellowship to Mr. J. A. Matthews of Columbia University, now carrying on chemical research in London. University fellowships in the sciences have been awarded as follows:

Robert Henry Bradford, Salt Lake City, Utah, metallurgy.

William Austin Cannon, Washington, Mich., botany.

Fellowship in chemistry to be awarded to an alternate.

William Jones, Sac and Fox Agency, Oklahoma, anthropology.

James Franklin Messenger, Cambridge, Mass., psychology.

Austin Flint Rogers, New York, mineralogy.

Walter Stanborough Sutton, Kansas City, Kansas, zoology.

Charles Partridge Weston, Orouo, Me., mechanics.

James Mickel Williams, New York, sociology.

DR. E. OVERTON, docent in the University of Zurich, has been called to an associate professorship of physiology in the University at Würzburg.

DR. F. REINITZER has been promoted to a full professorship of botany in the Technical Institute at Graz.

# SCIENCE

A WEEKLY JOURNAL DEVOTED TO THE ADVANCEMENT OF SCIENCE, PUBLISHING THE OFFICIAL NOTICES AND PROCEEDINGS OF THE AMERICAN ASSOCIATION FOR THE ADVANCEMENT OF SCIENCE.

EDITORIAL COMMITTEE: S. NEWCOMB, Mathematics; R. S. WOODWARD, Mechanics; E. C. PICKERING, Astronomy; T. C. MENDENHALL, Physics; R. H. THURSTON, Engineering; IRA REMSEN, Chemistry; JOSEPH LE CONTE, Geology; W. M. DAVIS, Physiography; HENRY F. OSBORN, Paleontology; W. K. BROOKS, C. HART MERRIAM, Zoology; S. H. SCUDDER, Entomology; C. E. BESSEY, N. L. BRITTON, Botany; C. S. MINOT, Embryology, Histology; H. P. BOWDITCH, Physiology; J. S. BILLINGS, Hygiene; WILLIAM H. WELCH, Pathology; J. MCKEEN CATTELL, Psychology; J. W. POWELL, Anthropology.

FRIDAY, MAY 3, 1901.

HENRY AUGUSTUS ROWLAND.

## CONTENTS:

<i>Henry Augustus Rowland</i> : PROFESSOR J. H. AMES	681
<i>Immunity and Protective Inoculation</i> : PROFESSOR HENRY WINSTON HARPER	684
<i>An Electro-Chemical Laboratory in the University of Pennsylvania</i> : PROFESSOR EDGAR F. SMITH	697
<i>Legislative Recognition of Scientific Work</i>	704
<i>Spring Meeting of the Council of the American Association for the Advancement of Science</i>	705
<i>Scientific Books</i> :— <i>Lunardi and Leonardi's Gli Insetti Nocivi</i> : NATHAN BANKS. <i>Lassar-Cohn's Introduction to Modern Scientific Chemistry</i> : DR. WILLIAM B. SCHÖBER. <i>Seller's Qualitative Chemical Analysis</i> ; <i>Congdon's Laboratory Instructions in General Chemistry</i> : H. F. MEADE'S <i>Chemists' Pocket Manual</i> : J. E. G. <i>Books Received</i>	706
<i>Scientific Journals and Articles</i>	709
<i>Societies and Academies</i> :— <i>New York Academy of Sciences, Section of Geology and Mineralogy</i> : DR. THEODORE G. WHITE. <i>The New York Section of the American Chemical Society</i> : DR. DURAND WOODMAN. <i>Biological Society of Washington</i> : F. A. LUCAS. <i>The Las Vegas Science Club</i> : T. D. A. C.	710
<i>Discussion and Correspondence</i> :— <i>Priority of Place and the Method of Types</i> : O. F. COOK. <i>The Proper Name of the Alpine Chough</i> : WILLIAM J. FOX	712
<i>Botanical Notes</i> :— <i>The Study of Mosses</i> ; <i>Botanical Facilities afforded to Students by the New York Botanical Garden</i> ; <i>A Study of Wheat</i> : PROFESSOR CHARLES BESSEY	714
<i>Scientific Notes and News</i>	715
<i>University and Educational News</i>	719

IN the death of Professor Rowland, at the age of fifty-three, in the fulness of his activity and powers, the world has lost one of its foremost men of genius; America, its greatest scientist; Johns Hopkins University, the teacher and investigator who has brought it most renown.

Henry Augustus Rowland was born at Honesdale, Pennsylvania, Nov. 27, 1848; he entered the Rensselaer Polytechnic Institute, Troy, and received the degree of C.E. in 1870. After a brief experience in practical engineering on a railroad he accepted the position of teacher of science in Wooster College, where he taught physics, zoology and geology for the year 1871-2. He was then called to the Rensselaer Institute as instructor, and was soon promoted to assistant professor. He remained at Troy until he accepted a position at Johns Hopkins University in 1875. The attention of President Gilman of Johns Hopkins University was directed to Rowland by Professor Michie of West Point; and the first meeting of the two took place at the Academy on the Hudson. Before assuming the duties of his new office, at the suggestion of President Gilman, he spent a year in Europe purchasing apparatus for his laboratory, becoming acquainted with the prominent scientists of England and the Continent, and making a prolonged

MSS. intended for publication and books, etc., intended for review should be sent to the responsible editor, Professor J. McKeen Cattell, Garrison-on-Hudson, N. Y.

stay in Berlin in order to carry out in Helmholtz's laboratory an investigation which he had long contemplated. He returned to America in 1876, was made professor of physics at Johns Hopkins, and at once began his work. His influence was immediately felt not alone in the University, but throughout the whole country; and students came from both North and South to receive inspiration and guidance. As research after research, discovery after discovery, was made, honors came from both home and abroad; his reputation and renown increased until in the whole country there was no one whose influence in all fields of scientific study or application was so great. It was in Baltimore that nearly all his great work was done, and it was here that he died on the 16th of April.

Professor Rowland was honored by being elected a member of many scientific bodies. He was Honorary Member of the Royal Society of London; Honorary Member of the Royal Society of Edinburgh; Honorary Member of the Royal Academy of Sciences, Berlin; Corresponding Member of the Royal Society of Göttingen; Corresponding Member of the Academy of Sciences of Paris; Honorary Member of the Cambridge Philosophical Society; Honorary Member of the Physical Society of London; Foreign Member of the Royal Swedish Academy of Stockholm; Associate Fellow of the American Academy of Arts and Sciences; Member of the National Academy of Sciences, and a member of nine other learned societies.

He was awarded the Rumford Medal by the American Academy in 1884, the Matteucci Medal in 1897, and received medals at the Exhibitions of Chicago and Paris. He received the honorary degrees of Ph.D. from Johns Hopkins in 1880 and of LL.D. from Yale in 1895 and Princeton in 1896. He was made an officer of the Legion of Honor in 1896.

Even as a young man, Rowland was occupied continually with problems and questions pertaining to chemical and physical science; he had his own laboratory and workshop in which he performed experiments and constructed apparatus. He read the works of Faraday and others and made their subject-matter thoroughly his own. His note-books kept when he was still a youth are full of most remarkable conjectures as to the undiscovered truths of nature, of proposed experiments, of most discriminating and accurate observations, and of many interesting theoretical discussions. It is to be earnestly hoped that the contents of these books will some day be published.

It is hardly necessary to give more than a summary of his most important researches. While at Troy he made those investigations on magnetic induction, permeability and distribution, which at once attracted the attention of Clerk-Maxwell. In Berlin he carried out his experiments on electric convection, which proved that an electrostatic charge carried at a high rate of speed has the same magnetic action as an electric current. (The results of this experiment have recently been called in question; but a repetition of the work during the past winter has confirmed them.) His first important piece of work in Baltimore was the determination of the mechanical equivalent of heat, which necessitated more careful thermometric and calorimetric methods than had ever been used before. He then became interested in questions dealing with electricity and, realizing the importance of accuracy in the measurement of electrical quantities, made a most careful determination of the ohm. This work was repeated and extended later, at the request of the United States Government.

The great problem of the connection between ether and matter was always before him, and in the desire of adding some-

thing to our knowledge he devised many experiments which were carried out by his students under his immediate direction; of these the most important were the one performed by Professor Hall, which led to the discovery of the 'Hall effect,' and those recently performed by Dr. Gilbert, which have led to purely negative results. Becoming interested in the study of spectrum analysis, largely through the influence of his colleague Professor Hastings, he realized the importance of securing as perfect gratings as possible. So he constructed a dividing engine for the ruling of gratings, the essential parts of which were a screw of nearly perfect uniformity of pitch and a most ingenious device for the correction of periodic errors. With this machine many gratings were ruled on both glass and speculum metal, the surfaces being plane. But the idea occurred to him to investigate the action of a grating ruled on a spherical concave surface; he discussed the question mathematically and thus discovered the great advantages of such 'concave gratings,' and proceeded at once to rule them. (It should be noted that all the gratings, both plane and concave, which have been ruled under Professor Rowland's direction and are now in use in all the physical laboratories of the world, have been sold at such prices as simply paid the wages of the laboratory mechanic who supervised their construction.) With these gratings the study of the solar spectrum was begun; and in order to supplement eye-observations, he made a careful study of photographic methods, and prepared his own photographic plates. Having mapped the whole solar spectrum from the extreme red to the limits in the ultra violet, he had enlarged maps prepared and offered to the world. Then he undertook the systematic study of the arc-spectra of all the elements, so far as possible; and the final results of this long research are now nearly ready for

publication. Within recent years his attention had been called to the theory of alternating currents and to their application for practical purposes. He devised a system of multiplex telegraphy depending upon synchronous motors, which received a grand medal at the Paris Exposition of 1900.

These are but the most important of Rowland's contributions to science; a complete list would be even more striking. Far more important, however, than the results of the investigations themselves, is the spirit, the aim of the man as made manifest in them. His great purpose was to discover not simply the truth in nature, but the deeply hidden truth. Questions pertaining to the *fundamental* properties of electricity, magnetism, ether and matter were always in his mind; the exact measurement of spectrum lines was interesting to him only in so far as the results might lead to accurate knowledge of molecular constitution or of solar and stellar phenomena; all instruments or methods perfected by him were those which could be used to measure the *great constants* of nature.

To appreciate properly Rowland's greatness as an investigator one must have worked with him. He enjoyed to the utmost the rare gifts of intuitive knowledge and of self-confidence. His energy, his manual dexterity, his ingenuity, his keenness in perceiving and avoiding experimental errors, his skill in devising apparatus, were always evident. No scientist of this generation has had greater power than he of using his imagination under the restraints and guidance of scientific knowledge.

As the director of a great physical laboratory, Rowland was in some ways unique. His enthusiasm and the inspiration of his example were always of the greatest help; his suggestions were invaluable; but his critical powers, his deep insight into any

physical problem, his searching questions were the qualities of untold benefit. He rarely delivered a lecture without calling attention to some subject which needed experimental study; he was never present at a meeting where scientific papers were read or discussed without pointing out some error or possible improvement in the method of experimenting. He was rarely on intimate terms with his students; but no one came near him without recognizing his sweetness of character, his entire freedom from petty faults, his absolute unswerving devotion to the pursuit of truth.

J. S. AMES.

JOHNS HOPKINS UNIVERSITY.

#### IMMUNITY AND PROTECTIVE INOCULATION.\*

"When we search the history of the development of scientific truth we learn that no new fact or achievement ever stands by itself, no new discovery ever leaps forth in perfect panoply, as Minerva did from the brow of Jove.

"Absolute originality does not exist, and a new discovery is largely the product of what has gone before.

"We may be confident that each forward step is not ordered by one individual alone, but is also the outcome in a large measure of the labors of others. The history of scientific effort tells us that the past is not something to look back upon with regret—something lost, never to be recalled—but rather as an abiding influence helping us to accomplish yet greater successes."—Sir Michael Foster.

"Again and again we may read in the words of some half-forgotten worthy the outlines of an idea which has shone forth in later days as an acknowledged truth."—Sir William MacCormac.

THE fact that persons once afflicted with smallpox rarely experienced a second attack of that disease when repeatedly exposed to it was not only early observed, but made a matter of record by the Chinese long before the beginning of the Christian era. That the disease was contagious had long been a matter of common experience,

\* Address of the President of the Texas Academy of Science, given in the Chemical Theater of the University of Texas, on October 26, 1900.

and the means of protection against its ravages early became an interesting subject for investigation.

The Chinese observed that when the dried and pulverized material from smallpox pustules was blown into the nostrils of persons who had not experienced an attack of the disease, the disease in persons thus infected underwent a milder course, was accompanied by a lower death rate, and conferred immunity against further attacks of smallpox. This early method of protection against the ravages of the disease became a common custom in China and India; but was later superseded by a more direct method of inoculation, that of introducing beneath the skin the scab of variolus pustules. The Chinese used the dried scab, the ordinary Hindoos the fluid pus, and the Brahmans pus that had been kept in wool for a period of twelve months. The last is clearly an instance of using attenuated virus.

It should be remembered that smallpox extended westward to Europe during the sixth century, that it reached England toward the close of the ninth century, and at the time of the Crusades became widespread. In 1517 it was carried from Europe to Santo Domingo; reached Mexico in 1520, whence it spread throughout the New World. It was introduced into Iceland in 1707 and to Greenland in 1733.

It should be particularly noted, that in the invasion of new territory the virulence of smallpox at once became greatly intensified—in some instances nearly one-half the population being destroyed by it. Robertson records the death of three million and a half of people in Mexico alone as the result of the invasion of 1520. Again, the dark-colored races seem to be more easily infected than Europeans.

The protective method of directly inoculating the pulverized variolus scab beneath the skin slowly traveled westward; so

slowly, that it did not reach Western Europe until 1718, when Lady Mary Wortley Montagu introduced the process then in vogue in Constantinople. While the year 1718 marks the introduction of protective inoculation to the aristocracy of England, the practice had come into use among Scotch and Welsh peasants at a much earlier date, which probably accounts for the next stage in the evolution of measures of protection against infectious diseases.

Herdsmen and milkmaids in both England and Schleswig-Holstein observed that occasionally on the udder of cows there appeared an eruption resembling smallpox; that this eruption could be communicated to persons engaged in milking; and that persons infected with the cowpox were protected against an invasion of true smallpox. The fact that the notorious Mrs. Palmer, Duchess of Cleveland, was thus protected is evidence sufficient to show that such observations were common as early as 1663. In 1768 Fewster and Sutton in London; 1774, Jesty, a Dorsetshire farmer; 1791, Pless, a Holstein teacher, and May 14, 1796, Jenner, confirmed these observations. It is true that the immortal work of Jenner began as early as the year 1769; for at this time, while a student under John Hunter, he heard a young country woman, in whose presence the subject of smallpox was mentioned, say: "I cannot take that disease, for I have had cowpox." Upon mentioning the subject to his master, Hunter replied "*Do not think, but try; be patient, be accurate.*" Jenner did try; was patient, was accurate; and on May 14, 1796, after years of patient labor, in his 'Inquiry into the Causes and Effects of the Variolæ Vaccinæ,' he experimentally established the following facts:

1. That this disease (cowpox) casually communicated to man has the power of rendering him unsusceptible of smallpox.

2. That the specific cowpox alone, and not other

eruptions affecting the cow, which might be confounded with it, had this protective power.

3. That the cowpox might be communicated at will from the cow to man by the hand of the surgeon, whenever the requisite opportunity existed. And

4. That the cowpox once ingrafted on the human subject, might be continued from individual to individual by successive transmissions, conferring on each the same immunity from smallpox as was enjoyed by the one first infected direct from the cow.

Thus it is seen that Jenner, by inoculating a cow with variolus matter produced in the cow an eruptive disease resembling smallpox, but of a milder type, and that the cultivation of this milder disease in the cow yielded a fixed virus (vaccine) which, transplanted to man, gave rise to a still milder eruptive disease (vaccinia) possessing constant characteristics, and conferring upon persons who underwent it immunity against smallpox.

The older methods of inoculation against smallpox were quickly supplanted by the simpler and far safer method of vaccination; and since the introduction of the latter the appalling ravages of smallpox have been relegated to historical literature.

The subsequent development of vaccination is a matter of such general information that there is no need of its further discussion here. It is sufficient to say that in the great majority (if not in all) of the cases of successful vaccination immunity against smallpox is conferred for an indefinite period, varying from three years to many years—averaging three to seven years—in some cases for life; and that compulsory vaccination and revaccination offer the safest and surest protection against this loathsome disease.

The success of vaccination gave great impetus to the investigation of the problem of immunity, and the annals of the nineteenth century contain a voluminous record of the prolonged and patient efforts of a host of brilliant workers whose contributions have at least laid the foundation upon which the

solution of the problem may, in the future, be built. The building of this foundation can not be recounted here; but it will be necessary to mention some of the materials of which it is made, that the latest progress may be intelligently discussed.

As in the case of smallpox, it had long been a matter of common observation that a number of the acute infectious diseases occur but once in the same individual. Whooping-cough, measles, scarlet-fever and yellow-fever are notable examples of acute infectious diseases one attack of which usually confers immunity against subsequent attacks of the same disease. It was also observed that some infectious diseases confer a very evanescent type of immunity, and that others confer no immunity whatever.

From the standpoint of immunity the infectious diseases may be easily divided into three classes:

1. Diseases one attack of which confers immunity against subsequent attacks of the same disease.

2. Diseases one attack of which confers immunity against subsequent attacks of the same disease for only short periods of time.

3. Diseases an attack of which confers no immunity whatever.

It would seem that these facts, coupled with Jenner's discovery of a fundamental and practical method of producing artificial immunity, clearly outlined the path for future workers to follow; but, strange to say, the nineteenth century was well on its way before this important route found many followers.

The failure to appreciate fully Jenner's brilliant discovery, and to apply his method to the study of other infectious diseases, finds an explanation in the hazy theoretical conceptions of the cause and nature of infectious diseases which prevailed during the early part of the century. The investigations of fermentation by Astier, Sette, Franz

Schulze, Cagnaird de Latour, Schwann, Fuchs, Remak, Mitscherlich, Helmholtz and others did much toward clearing the haziness of that period; but it was the monumental work of Pasteur that 'finally established the truth of the view that all processes of fermentation and putrefaction alike are caused by living things, and that in each different fermentation different kinds of microbes are concerned.' In the light of newer knowledge this statement needs revision. The investigations of Koch on anthrax soon followed, and then came the growth of pure cultures of several pathogenic bacteria.

"The work of Pasteur and Koch afforded the first basis on which the study of artificial immunity could be again undertaken. The possibility of voluntarily producing a number of the most important infectious diseases of men and animals, and of modifying at will pure cultivations of bacteria, either, according to Jenner's precedent, by passage through the animal body, or otherwise on artificial culture media, laid the foundation on which advancement could proceed. Pasteur himself was the first, after Jenner, to produce an artificial immunity by using an attenuated virus; and he was also able to introduce the procedure to some extent into practice with most beneficial results. Still the theoretical explanation of all these facts lagged far behind their practical effects. The very able investigations of Metschnikoff and his theory of phagocytosis were, to many investigators, inconclusive."

Numerous attempts were made to formulate adequate theoretical explanations of the accumulated facts concerning the phenomena of infectious diseases. The followers of Sydenham looked upon the specific disease itself as an *entity*; while Lotze and Virchow viewed it as a *process*. It was clear that a mechanical or dynamical process could not be a living entity. The



physiologists Haller, Reil and Johannes Müller had established this principle for normal life processes, and its extension to abnormal life processes was simple enough. "Whatever be the outside forces that act, the eye perceives only light, and the ear only sound; the glands simply secrete and the muscles contract. It is, therefore, the internal condition of the organism, of its organs, tissues or cells, that alone determines the character of the effect. The impulse that must come from the outside to produce these effects is called the stimulus. Hence there must exist a fundamental internal organization, that is to say, a predisposition to something external. \* \* \* Disease, then, may be regarded as the effect produced by quantitative changes in normal conditions, either when the physiological organization is too feeble or the stimulus too intense." Disease may be viewed as a phenomenon of adaptation.

Against this conception, the parasitic or germ theory, developed by Plenciz, Eisenmann, Henle, Davaine, Pasteur, Klebs, F. Cohn, J. Schröter and Koch, appeared to introduce an entirely new qualitative element. It asserts 'that many diseases are due to the presence and propagation in the system of minute organisms having no part or share in its normal economy.'

Another conception is that of Pettenkofer, which holds that the determining cause is to be found in the external conditions, which vary according to time and place.

It is not difficult to see that these theories are upholding entities as the cause of disease. While a kernel of truth is to be found in each, they all fail to realize the continuity of causes in the sense of modern exact science. "The true and sufficient cause of any effect is always something internal, something that follows from the kind and amount of initial energy, and from that quality and quantity alone and

entirely. \* \* \* It is the absolute thing 'that exists behind all change and remains primordially the same,' as Helmholtz expressed it." Or as the modern physicist would put it: potential energy = cause, kinetic energy = effect; and as a liberating impulse will change potential energy into kinetic energy, so a liberating impulse will change cause into effect.

The cloudiness that characterizes many of the theories that have sought to explain the phenomena of infectious diseases is largely a legacy of Kantism, and is clearly out of place in these days of modern science. It is somewhat strange that 'ontological toys' are still to be found in the workshop of some really brilliant investigators of natural phenomena. Nevertheless, they are there—which explains some explanations that do not explain.

The parallelism which subsists between the phenomena of fermentation, infection and immunity, suggests the mental route to be traveled if an insight into our problem is to be gained; and for this reason it is necessary to first point out a few facts about fermentation.

#### FERMENTATION.

If the phenomena of matter be defined as periodic functions of the atomic and molecular masses which constitute it and the rates of motion of these masses, and the chemical unit be viewed as a 'center through which energy manifests itself,' then the theories of modern chemistry should supply an explanation of the phenomena of fermentation.

The crucial test of every theory which seeks to explain fermentation is the satisfactory explanation of the following phenomena:

Enzymes appear to be capable of disrupting complex chemical bodies without undergoing any apparent chemical change themselves—that is, they bring about a

chemical change in disproportionately large quantities of material. When the newly produced substances attain a certain concentration the further action of the enzyme is inhibited, but its action is reasserted when the concentration of the zymolytic products is again lowered. Maximum, minimum and optimum temperature and pressure influence these changes. The introduction of certain chemical bodies also exerts an accelerating or retarding influence; and phenomena of *selective* action are likewise to be found.

Many hypotheses have been submitted. Very ingenious explanations of some of the phases of fermentation are to be found in them; but under the searching light of completer knowledge their incompleteness is sooner or later developed. Many of the modern theories are little else than translations of the earlier hypotheses into terms of modern scientific terminology, so that the later literature is laden with modern extensions of the catalytic theory of Berzelius, Beal's bioplastic theory, Justus von Liebig's physical theory, the germ theory, etc.

Interesting and enlightening as some of these theories are, their full consideration is not within the purpose of this address, the limits of which will permit only a brief and incomplete review of some of the more modern conceptions of fermentation, to which attention is now asked.

The more recent investigations of the organized and unorganized (soluble) ferments have dealt a severe blow to the vitalistic theory of fermentation. Hansen's admirable biological researches upon the yeasts, followed by the important investigations of Buchner, A. Croft Hill, Emil Fischer and many others brought to light many interesting hitherto hidden facts; and it now seems clear that all the phenomena of fermentation may be explained from a purely chemical basis. The so-

called organized ferments appear to be 'active proteids,' and the unorganized ferments, or enzymes are mostly proteid-like bodies presenting great differences in the complexity of their chemical structure.

Hueppe looks upon 'active proteid' as "a kind of intermediate stage between lifeless 'nutritional' proteid and living cells"; that it 'appears like an anhydride of dead proteid,' inasmuch as hydration converts it into an inactive form. Investigations of Bokorny and Loew demonstrated the existence of active proteid in many plants. Loew speaks of it as reserve protein matter of a highly labile nature, and that it differs from all other reserve proteins. He called it proto-protein, and suggested that it is the 'material which, by being converted into organized nucleo-proteids, forms living matter.' Protein comprises all kinds of albuminous matter, while proteid is used to designate complex compounds of proteins, such as nucleins, hæmoglobin, etc. *Labile* chemical compounds are unstable bodies which easily undergo chemical change. Labile atoms or groups of atoms are atoms or groups of atoms which readily migrate from a center of instability to one of stability. When the migration is intramolecular a stereoisomeric compound is the product of change; when the migration is extra- or intermolecular disruption of the molecules takes place. Loew points out the necessity of distinguishing between 'potentially labile and kinetically labile compounds; in other words, between static labile and dynamic labile'—using the potential chemical energy in the sense of intramolecular chemical energy. Nitroglycerole and certain other explosive organic compounds represent the potential type, while examples of the kinetic are found in the aldehydes and ketones.

The energy stored in a labile compound is beautifully illustrated in the explosion of the trinitrate of glyceryl— $\text{CH}_2(\text{ONO}_2)\text{.CH}$

(ONO<sub>2</sub>).CH<sub>2</sub>(ONO<sub>2</sub>), which when heated to 257° C., or when struck, explodes with great violence. The products of the decomposition are represented by the equation :

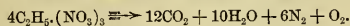

At the temperature of the explosion all these products are gases, and at atmospheric pressure will now occupy the space of about 10,400 liters, having expanded about 18,324 times its original volume.

Another instance is that of mercury fulminate [(C:N.O)<sub>2</sub>Hg + ½H<sub>2</sub>O], which develops a pressure of 43,000 atmospheres by detonating in its own volume.

Chemical changes partially or completely destroy the statically labile compounds, while the dynamically labile compounds readily pass into isomeric or polymeric compounds as a result of atomic migrations, or by polymerization. The classic illustration usually given of the production of an isomeric compound produced by atomic migration is Wöhler's famous discovery: the transformation of ammonium cyanate into urea, which he accomplished in 1828, by evaporating an aqueous solution of ammonium isocyanate. The transformation is represented by the equation :

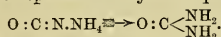

Many others can be cited.

Noting that labile compounds are more easily attacked by chemical agents than stable ones, Loew has elucidated the action of many poisons. He says: "A systematic toxicological review shows us among other things that all compounds acting upon aldehydes and all that easily attack labile amido-groups are poisonous for all kinds of living protoplasm, which fact led me to infer that the lability of the plasma proteids is caused by the presence of aldehyde and amido-groups within the same molecules. \* \* \* The *primum movens* in the living protoplasm must be defined as a mode of motion of labile atoms in the plasma pro-

teins; that is, as a *special case of chemical energy*." According to Loew, the enzymes belong to the dynamically labile compounds.

While the chemical structure of the enzymes is not yet known the researches of Emil Fischer go to show that a knowledge of their constitution is not far beyond our reach. In the fermentation of the sugars Fischer has shown that the enzymes can only 'attack those sugars which possess a molecular configuration corresponding to their own'—that is, they must fit each other 'as the key fits its lock.' Viewing the enzymes as nucleo-proteid bodies, and as being optically active, he reasoned that *their molecules must have an asymmetric structure*. Their selective action toward  $\alpha$  and  $\beta$  methyl-glucosides strongly supports this view.

According to Fischer, two methyl-glucosides are formed by the action of hydrochloric acid (HCl) on a solution of *d* glucose in methyl alcohol, and their configuration is given as follows :

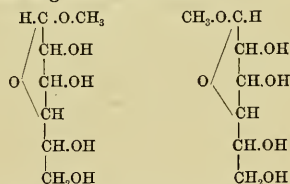

One is called  $\alpha$  the other  $\beta$ , and their difference is found in the configuration of the one asymmetric carbon atom, yet the enzymes which attack the  $\alpha$  will not attack the  $\beta$ , and *vice versa*. This important discovery sheds a world of light upon the vexed problem of fermentation, and will therefore help to explain many of the obscure phenomena of disease and of immunity. It will also find a place in the investigation of many of the difficult problems of physiological chemistry. A very admirable feature of Fischer's hypothesis is its capacity to receive aid

from, and give aid to, several other hypotheses—it possesses a wide range of applicability.

In 1892, our esteemed colleague, Professor J. W. McLaughlin, in his book on 'Fermentation, Infection and Immunity,' elaborated a 'Physical Theory,' a quotation from which is here presented. After developing the modern conception of complex molecules, Dr. McLaughlin goes on to say: "When we add to this conception of atomic and molecular union, that of atomic vibrations in unvarying periods of time which are distinctive of each kind of atom, and that of ethereal wave-motions vibrating in equal periods with the atoms that produce them, the law of 'interference' enables us to understand how atomic wave-motions may be supplemented or antagonized by other atomic wave-motions, and how molecular wave-motions may, likewise, be similarly influenced by other molecular waves; that, in fact, the molecular waves which give a substance its energy will vary with molecular grouping. Now it is in these principles of molecular dynamics, and in chemistry and biology, that, we believe, is to be found the explanation of cell metabolism—constructive and destructive—of fermentation, of infection and immunity." On page 66, he says: "It is only when the molecular vibrations of a ferment, whether this be a living, organized ferment, or a non-living, unorganized ferment, coincide with those of a fermentable substance, that the latter may be disrupted by the former, and fermentation ensue." While these two quotations do not adequately present Dr. McLaughlin's theory, they suggest a connecting link with the physical hypothesis of de Jager.

"Starting with Naegeli's view that fermenting yeast-cells emit vibrations which pass out of the cells and decompose the sugar in the solution surrounding them, de Jager suggests that the enzymes may be

regarded not as substances at all, but as the vibrations themselves, that is as properties of substances rather than material bodies." He compares them to light, electricity, magnetism. Fermentation does not depend upon chemical action of a molecular substance, but chemical transformations are brought about by physical forces. Maurice Arthus has very ingeniously elaborated the theory of de Jager.

O'Sullivan and Tompson have shown that invertase is capable of inverting more than 100,000 times its own weight of cane sugar without exhausting itself; and Tamman proved that under proper conditions the enzyme is decomposed during its activity with extreme slowness. These reactions find their parallel in the action of nitric oxide in the manufacture of sulphuric acid, and in the action of sulphuric acid in the production of ethyl oxide; and Bredig and von Berneck have recently shown that "one gram-atom (193 grams) of colloidal platinum diffused through seventy million liters of water shows a perceptible action on more than a million times the quantity of hydrogen peroxide."

In these four instances it will be observed that the invertase, nitric oxide, sulphuric acid, and colloidal platinum acted solely in the capacity of catalyzers, that is, they modified the time factor of the reaction—the positive catalyzers accelerating, and the negative catalyzers retarding, the velocity of the reactions. Catalyzers, then, serve in the capacity of *liberating impulses*.

That zymohydrolysis is a chemical action finds further support in the recent work of A. Croft Hill on 'Reversible Zymohydrolysis.' By varying the concentration of mixtures of glucose and maltose he found that the equilibrium point of these two sugars was reached when 85.5% of glucose and 14.5% of maltose were present. Increasing the glucose beyond 85.5% sent the hydrolysis one way, and the reaction reversed

when the maltose was increased beyond 14.5%. This is in strict conformity with the law that "every reaction proceeds to a state of equilibrium, with a definite reaction velocity."

The phenomena of reversible reactions have been well worked out, and Konow's reaction of acetic acid upon pentene:

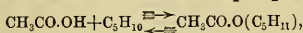

has been shown to conform to the requirements of the law of mass-action by Nernst and Hohmann.

Another very important observation made by Bredig and von Berneck is that "relatively minute portions of certain substances are able to inhibit the catalytic action of platinum, and that these are substances which exert a markedly poisonous effect on the living cell and on enzymes. 1/345,000 gram-molecule per liter of hydrogen sulphide already exerts a strongly restraining action. 1/1,000 gram-molecule per liter of hydrocyanic acid stops it entirely, and much less is able to retard it greatly. Carbon disulphide, and mercuric chloride show a similar behavior." This again parallels the action of ferments and antiferments.

Were it necessary, many other interesting parallels could be drawn to show the intimate connection between the phenomena of fermentation and the phenomena of chemical action; but this must suffice to authorize the statement that the complex phenomena of fermentation can be best understood when viewed from the pinnacle of modern chemical theory—the Avogadro-van't Hoff rule, the phase rule, electrolytic dissociation and the doctrine of energy.

Having shown that chemistry helps us to understand fermentation, let us see what light it is capable of shedding upon infection.

#### INFECTION.

The fact that the poisonous action of the bacteria is due to the soluble products formed by the bacteria was established by

Panum in 1874. Later, Koch, Chauveau and others succeeded in separating these poisons from the bacteria, and by inoculating animals with them proved that the proliferation of a number of pathogenic organisms in the body was less injurious to the body than the soluble poisons produced by them. Briegee viewed these poisons as organic bases, the so-called ptomaines; but, subsequently some of them were shown to be either proteid or proteid-like bodies, and many of them acted not unlike digestive ferments. Briegee and Fränkel named the proteid-like bodies toxalbumins. Among the toxins are uncrystallizable poisons, the complex chemical structure of which has not yet been made out. The ptomaines are crystallizable products of bacterial activity somewhat analogous to the vegetable alkaloids. Some possess toxic properties, while others do not. The chemical structure of some of them is well known, but the structure of toxalbumins is a problem for future work.

In his work on 'Ptomaines and Leucomaines,' Vaughan points out a very interesting chemical relationship between some of the non-poisonous and poisonous members of the cholin group. Starting with trimethyl-ethyl-ammonium hydroxide, by oxidation cholin, neurin, betain and muscarin are derived as follows:

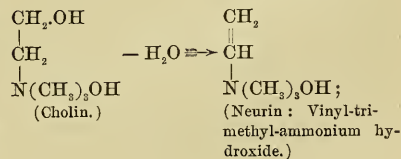
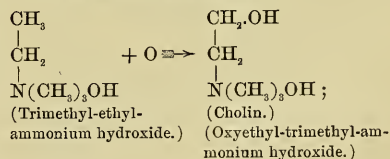

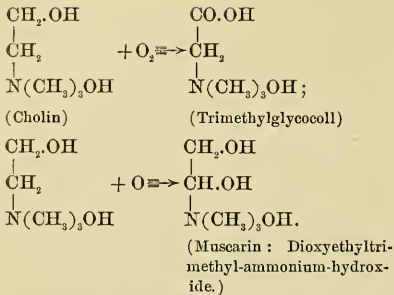

The structural formulæ show the little change that is necessary to convert an innocuous substance into a very poisonous one, and *vice versa*. Cholin is only poisonous in large doses while very small doses of neurin and muscarin are highly poisonous. Betaïn is not poisonous.

Methylguanidin ( $\text{NH} : \text{C} < \begin{array}{c} \text{.NH}_2 \\ \text{.NH}_2 \end{array} (\text{CH}_3)_2$ ), trimethylenediamine ( $\text{CH}_2 : < \begin{array}{c} \text{CH}_2.\text{NH}_2 \\ \text{CH}_2.\text{NH}_2 \end{array}$ ), and tyrotoxon (diazobenzene-potassoxide,  $\text{C}_6\text{H}_5\text{N}_2\text{OK}$ ) are three other poisonous ptomaines whose chemical structure is well known. Typhotoxin ( $\text{C}_7\text{H}_{11}\text{NO}_2$ ) is said to be the toxin which gives rise to the typhoid intoxication, and Brieger has been able to separate from tetanus cultures four bases: tetanin ( $\text{C}_{13}\text{H}_{30}\text{N}_2\text{O}_4$ ), tetanotoxin ( $\text{C}_5\text{H}_{11}\text{N}$ ), spasmotoxin and one other unnamed toxin. According to Brieger, each of these is capable of inducing tetanic intoxication. Against this last statement is opposed the further statement that tetanus toxin is a toxalbumin.

Roux, Yersin and others succeeded in isolating, seemingly in a state of purity, from the cultures of the Klebs-Loeffler bacillus a toxalbumin, soluble in water, which when inoculated into a guinea-pig produced the phenomena characteristic of diphtheria. Prosecuting this line of investigation, these and other investigators have isolated characteristic toxalbumins from

cultures of other germs. These toxalbumins have been divided into two principal groups by Brieger and Fränkel, the classification being based upon their solubility. As previously stated, they are proteid-like bodies, highly complex and poisonous. Their further properties may be considered later; but in passing, an idea of their virulence should be given.

"A tetanus toxin has been prepared, of which 0.00005 milligram killed a mouse weighing 15 grams; a man weighing 70 kilograms, with the same susceptibility, would be killed by 0.23 milligrams. This would make the poison 300 times more potent than strychnine."

Closely related to the toxins which arise as products of bacterial activity there is another group of toxic substances which arise in the living animal tissues as the products of either hyper or of retrograde metabolism of the protoplasm, or result from fermentative action. Some of these are proteid-like bodies (toxalbumins), while others are organic bases (leucomains) not unlike the vegetable alkaloids.

The chemical structure of many of the leucomains is well known; but the same cannot be said of the toxalbumins. The development of their structure must await the unraveling of the proteids—their chemistry seems to flow in channels parallel with the chemistry of the albumins, globulins, albuminates, proteoses and peptones. At least the poisonous principle clings to these products.

The venom of the snake belongs to this class. According to the researches of S. Weir Mitchell, E. T. Reichert, T. R. Fraser and others, snake venom is a very complex mixture containing in addition to the poisonous substances several bodies that are non-poisonous. The poisonous substances are not ferments. Fraser says: "They are substances that produce effects having a direct relationship to the quantity intro-

duced into the body. This quantity in the case of each serpent varies with its size and bodily and mental condition; with the nature of the bite—whether both fangs or only one has been introduced, whether they have penetrated deeply or only scratched the surface; and with other circumstances related to the serpent, such as whether it had recently bitten an animal or not, and thus parted with a portion or retained the whole of the venom stored in the poison glands. The quantity required to produce death being very exactly related to each pound or kilogram of weight." Fraser found the minimum lethal dose per kilogram to be: "For the guinea-pig (of dried venom), 0.00018 gm.; for the frog, 0.0002 gm.; for the rabbit, 0.000245 gm.; for the white rat, 0.00025 gm.; for the cat, somewhat less than 0.005 gm.; and for the grass snake (*Tropedonotus natrix*), the relatively large dose of 0.03 gm."

It is significant that the toxicity of cobra venom is not the same for all animals. Furthermore, it is exceedingly interesting to find that the experiments carried out by Fraser, *in vitro* and in the animal organism, leave practically no room for doubt that the poisonous action of snake venom and the antagonistic action of antivenin are both chemical. In the unprotected animal snake venom injected beneath the skin or into the blood stream gives immediate evidence of reactions of an endothermic character; but when in the same manner it is introduced into protected animals evidence of exothermic reactions is elicited. When introduced into the stomach of an animal snake venom not only fails to induce symptoms of poisoning, but exhibits a neutralizing action upon inoculated venom, and in the uninoculated animal confers immunity against snake venom. Moreover, the ratio between venom and antivenin is quantitatively brought out in the experiments of Fraser. All this can be shown to be in

conformity with well-known chemical laws.

Numerous examples which illustrate the chemical nature of the action of toxalbumins might be drawn from various intra- and intercellular protoplasmic bodies found in the vegetable and animal kingdom, but time will not permit their multiplication here. A bountiful supply is to be found in recent biochemical and medical literature, and interested persons are referred to that source.

The specific phenomena of these poisons as exhibited in the human body when toxic quantities are taken will be found in nearly every text-book of modern medicine, so there is no need to repeat them here.

What has been said of the chemistry of fermentation is equally applicable here. Specific illustrations and their enlargement just now would take us beyond the limits of this address; for that reason it is well to pass on to the consideration of the next phase of the subject.

#### IMMUNITY.

The problem of immunity is so closely entwined with that of protective inoculation that it will be easier to discuss the two conjointly.

In its broadest sense, immunity represents that state of the living organism (animal or vegetable) which enables it to resist the toxic action of substances, whether such substances be introduced from an external source or are developed within the organism. Specific immunity is a state of immunity against a specific substance. This may be *natural*, as when the organism is normally *non-susceptible*; or it may be *artificial* (acquired), as in the case of protection against disease developed by a previous attack of the disease (as in smallpox), or by some other artificial means (vaccination, for instance).

Vexed as the problem is, much enlightenment is to be gained from an investiga-

tion of artificial immunity. Recalling the researches of Jenner, and the quotation from Ehrlich relative to the work of Pasteur, at that time it appeared as though artificial immunity was brought about by specific micro-organisms. Opposed to this view the investigations of Toussaint, Chauveau, Salmon and Smith, Roux, C. Fränkel and others brought forward evidence to show that artificial immunity could be induced by the 'metabolic products' freed from bacteria—accustoming the organism to the specific poison seemed all-sufficient. Later it was shown by Hueppe, Gamaleia and Buchner that the specific toxins found in the culture fluid outside the bacterial cells were not identical with the protective substances found in the germs and their metabolic products.

At this point Hueppe says: It has been "established that: (1) undergoing the disease; (2) inoculation with attenuated germs; (3) inoculation with disease germs which have become wholly impotent; (4) inoculation with saprophytes, and (5) inoculation with the metabolic products of the parasite, can all confer immunity; while, (6) inoculation with the specific poisons effects no immunization." Then followed the experimental proof that completely attenuated bacteria can no longer produce the specific poison. This effectually separates the protective substance and the poison.

The next important advance was the discovery of substances in the blood serum of animals immunized against diphtheria and tetanus that were able to specifically protect other animals against the toxins of these diseases. This discovery was made by Behring, and it at once opened an entirely new and promising field for investigation.

December 3, 1890, in No. 49 of the *Deutsche med. Wochenschrift*, Behring and Kitasato published an article: 'Ueber das Zustandekommen der Diphtherie-Immunität und der Tetanus-Immunität bei Thieren' in which

the statement is made that: "The blood of tetanus-immunized rabbits possesses the property of destroying tetanus toxin. This is possessed by the extravascular blood and is the cell-free serum." They showed that the blood serum of non-immunized animals did not possess this antagonizing action, and that the prepared serum was of therapeutic value. Ogata and Jasuhara proved that blood serum from an animal naturally immune contained substances which, when injected into mice, conferred upon them the same type of immunity. Tizzoni and Cattani (1891) found that the quantitative protective value of the blood serum of animals naturally immune to tetanus (the dog, for instance) could be greatly increased by repeated injections of gradually increasing amounts of tetanus-toxin; and that such serum possessed decided therapeutic value when inoculated into animals suffering from tetanus. This line of investigation has been greatly extended and enriched by Behring, Roux, Koch, Yersin, Haffkine, Pfeiffer, Buchner, Sanarelli, Ehrlich and others, and, as a result, there is to be found in the open market to-day a variety of antitoxin sera, such as antidiphtheritic, antitetanic, Marmoreck's antimycotic, antipneumococcal, antibubonic, antirhabic, yellow-fever, etc.

March 20, 1896, Professor Thomas R. Fraser, M.D., at the Royal Institution of Great Britain, presented a very important contribution on 'Immunisation against Serpents' Venom, and the Treatment of Snake-bite with Antivenene,' in which, for the first time, the quantitative relation between the 'toxic' and the 'anti' substances is shown. The contribution is rich in splendidly marshaled experimental evidence which leads the author to the logical conclusion that, so far as snake venom is concerned, the antidotism of the 'antivenene' is not the result of physiological reaction, is not due to phagocytic action, nor to the



'resistance of tissues,' but, as I have already pointed out, a chemical theory, implying a reaction between antivenene and venom, which results in a neutralization of the toxic activities of the venom, is entirely compatible with the observed facts.

Another significant fact of chemical importance observed by Fraser is that, in carrying out the immunizing process, "the saturation point of the blood for antivenene is reached before the possible maximum non-fatal dose of venom has been administered." The protective value of venom and 'antivenene' when administered by the stomach has already been mentioned.

By this time the use of diphtheria antitoxin as a therapeutic agent in the treatment of diphtheria had become firmly established. The variation in the results obtained caused Ehrlich to search for a quantitative relation between the toxin of diphtheria and the antitoxin of diphtheric serum. The result of Ehrlich's investigation is to be found in the Croonian lecture delivered by him before the Royal Society, London, March 22, 1900. 'By means of test-tube experiments with suspended animal tissues' he brought out some very interesting facts. "The relations were simplest in the case of red-blood corpuscles. On them, outside the body, the action of many blood poisons, and of their antitoxins, can be most accurately studied, *e. g.*, the actions of ricin, eel-serum, snake poison, tetanus toxine, etc. \* \* \* By means of these test-tube experiments, particularly in the case of ricin, I was able, in the first place, to determine that they yielded an exact quantitative representation of the course of the processes in the living body. \* \* \* It was shown that the action of toxine and antitoxine took place quantitatively as in the animal body. \* \* \* It was proved in the case of certain toxines—notably tetanus toxine—that the action of antitoxines is accentuated or diminished under the influ-

ence of the same factors which bring about similar modifications in chemical processes—warmth accelerates, cold retards the reaction, and this proceeds more rapidly in concentrated than in dilute solutions. \* \* \* The knowledge thus gained led easily to the inference that to render toxine innocuous by means of antitoxine was a purely chemical process, in which biological processes had no share."

The distribution of the toxins and the antitoxins in the system is a matter of prime importance, yet not more than a beginning has been made looking toward their localization. That they do possess a selective action has been established by Stokvis, Dönitz, Pfeiffer, Marx, Wassermann and Roux, and these facts throw a great deal of light upon the phenomena of incubation, time reactions, antitoxic action, protective action, serum therapy, etc.

The phenomena of agglutination and lysogenic action, the recent work of Buchner in Germany and Bordet in France, on hæmolysis, and some experimental work on ionic reactions done in my own laboratory, deserve consideration here; but time presses for a summation, and they must be passed without further comment to a future occasion.

From accumulated facts, *acquired immunity* is separable into two distinct types. (The following classification is borrowed from Muir and Ritchie.)

- A. Active immunity, *i. e.*, produced in an animal by an injection, or by a series of injections, of non-lethal doses of an organism or its toxines.
1. *By injection of the living organisms.*
    - (a) Attenuated in various ways. Examples:
      - (1) By growing in the presence of oxygen, or in a current of air.
      - (2) By passing through the tissues of one species of animal (becomes attenuated for another species).
      - (3) By growing at abnormal temperatures, etc.
      - (4) By growing in the presence of weak antiseptics, or by injecting the latter along with the organism, etc.

(b) In a virulent condition, in non-lethal doses.

2. *By injection of the dead organisms.*
3. *By injection of filtered bacterial cultures, i. e., toxins; or of chemical substances derived from these.*

These methods may also be combined in various ways.

- B. Passive immunity, *i. e.*, produced in one animal by injection of the serum of another animal highly immunized by the methods of A.
  1. *By antitoxic serum, i. e.*, the serum of an animal highly immunized against a particular toxin.
  2. *By antimicrobial serum, i. e.*, the serum of an animal highly immunized against a particular organism in the living and virulent condition.

The protective value of active immunity extends through a considerable period of time, while that of passive immunity is evanescent.

An adequate explanation of this vast array of facts is yet before us. The explanation in detail cannot be given to-night; that must await another time; but some generalizations must be made.

1. *Pasteur's theory of exhaustion* of the pabulum is disproved by the fact of passive immunity.

2. The *theory of retention* will have to be greatly modified before it can explain many facts with which it is now in opposition.

3. The *theory of acclimatization or habituation* has limited application and, like the theory of adaptation, takes too little cognizance of details.

4. *Metchnikoff's theory of phagocytosis* falls before the facts of passive immunity; and

5. The *humeral theory* only presents another phase of its own evolution.

6. *Buchner's hypothesis*, which explains immunity as being due to the reactive changes in the integral cells of the body resulting from the action of chemical products absorbed from the seat of vaccination or inoculation, is strongly supported by experimental evidence; and

7. *Ehrlich's side-chain (Seitenkette) theory* presents an exceedingly ingenious and interesting explanation of the phenomena of

immunity adduced by experiments *in vitro* and *in vivo*.

By elimination the problem may be somewhat simplified. The facts themselves may be roughly divided into two groups: (1) biological, and (2) chemical; and the explanations will then be either biological or chemical. In the ultimate analysis, the biological explanation will rapidly pass from the body as a whole to its respective organs and their respective cells, to the nucleated cells, and finally to the biogen of the nucleus; while the chemical explanation will describe the cycle that begins with the minutest atomic reaction, passes onward through more and more complex intra- and intermolecular synthetic and analytic changes so long as chemical equilibrium is disturbed; but eventually finds its beginning and its end—cause and effect—in energy potential, energy kinetic, liberating impulse.

That the problem of immunity will be solved is only a question of time. The active research now in progress is rapidly dissipating the unknown; and when the chemical structure of the various animal proteids becomes a known quantity their interaction will be readily seen and the solution of the problem will be an accomplished fact.

The problem is a biochemical one, and biochemists will solve it. Many, if not all, the phenomena of fermentation, infection and immunity are explainable in terms of modern chemistry, and since modern chemistry is firmly founded on the doctrine of energy we have to consider merely the terms, *energy potential*, *energy kinetic* and *liberating impulse*.

I am conscious of having failed to bring before you a large mass of newly accumulated, interesting facts which should be considered in this connection; but the largeness of the subject together with the enormous accretions annually made to its

literature renders it impossible to present a complete survey of so immense a field of labor in the address of an evening. What has been said is little more than a beginning of what has been done in this line of biochemical research—the promise of its future remains to be told.

Beside the great intellectual gain must be placed the immense practical benefits such investigations have secured for man—as witnessed in the saving of millions of lives of human beings, many times more of the lower animals, and large areas of plant life. They have ever made for the betterment and happiness of man, and for the highest progress of civilization, and so will they continue.

HENRY WINSTON HARPER.

*AN ELECTROCHEMICAL LABORATORY AT  
THE UNIVERSITY OF PENNSYLVANIA.*

The great importance of electricity in chemistry is universally recognized. Universities and technical schools are rapidly adding appliances for the use of this agent to their chemical equipments. Here, at the University of Pennsylvania, the first work done in electrochemistry was in the year 1878. It consisted in the precipitation of cadmium from its salts, also the separation of this metal from copper, and the precipitation of uranium as protosesoquioxide by the electric current. Since that time numerous other methods have been devised, and the practical work has been greatly amplified and incorporated in the course of chemical instruction designed for undergraduate and graduate students in chemistry.

The electric energy was, at first, derived from various types of primary batteries, but as the demand for powerful and steady currents grew, several storage cells of the Julien type were introduced, early in the year 1888, and constantly used until 1895, when the equipment was increased by the addition of twelve chloride accumulators

(Type E), connected to a plug-board, by which any number of cells could be arranged in series or parallel, and attached to any one of three sets of terminals, conveniently placed on a working table. Fig. 1 represents a photograph of the table, showing the board in position. The storage cells were placed in the cupboard back of the distributing board. The arrangement of the plug-board with its connections is clearly indicated in Fig. 2, where the lettered and numbered squares represent brass blocks mounted on a slab of hard rubber, and the dotted lines indicate the electrical connections on the back. Provision was thus made for three students.

As this device and our present laboratory were installed at the writer's suggestion and under his direction by A. W. Schramm, of the Electrical Department of the University, it seems best, to insure accuracy and avoid uncertainty, to introduce the latter's own language in describing the two schemes:

"The brass blocks marked P are each connected to the positive terminal of a storage cell. These cells are marked in the figure by A, B, C, etc. The negative terminals are each connected to two blocks marked N, as shown. The upper line of blocks, numbered 1, are joined together, and, in fact, might be made of one strip except for economy of material. This row is attached to, and forms part of, the positive lead running to outlet No. 1 on the operating table. The negative lead for this same outlet is connected to the lower row of blocks marked 1. Thus: If the operator at outlet No. 1 wanted to use the two cells A and K in parallel it would only be necessary for him to insert plugs between the upper row of 1 blocks and the P blocks of A and K respectively, and between the N blocks of A and K, and lower row of 1's. Similarly, the upper row of blocks marked 2 are connected to the positive lead running to outlet No. 2, and the

lower row of blocks marked 2 are connected to the negative lead of the same outlet. And so on with the blocks marked 3. It will be noticed that one of the two above-mentioned N blocks is located in the same row with the P blocks, and this N block of one cell is adjacent to a P block of its neighbor. This is for the purpose of connecting cells in series.

"For instance, suppose that the operator at outlet No. 2 wanted to use cells B, C and D in series, he would connect the P block

110-volt lighting circuit by means of a small knife switch, conveniently located at the side of the operating table. Incandescent lamps placed in this charging circuit kept the current down to the desired value. The cells were then all connected in series and across the No. 1 leads. Making No. 1 leads the charging circuit also provided means for using the 110-volt current for electrolytic work where the solutions were of such high resistance that the twelve cells in series were insufficient to produce

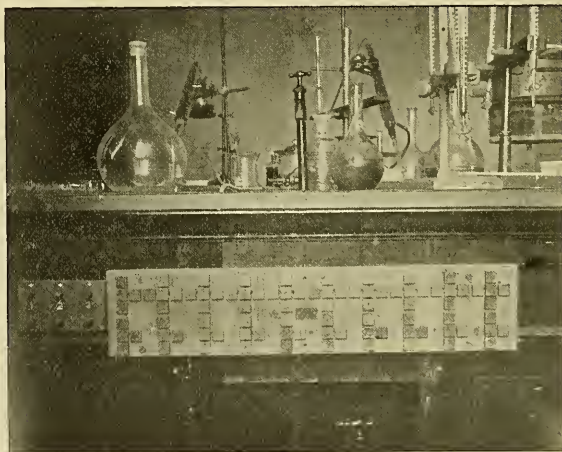

FIG. 1. Old Working Table.

of cell B to 2, the P block of C to the N of B, and the P block of D to the N block of C, finally connecting the N block of D to its adjacent 2 block.

"In addition to the above, the operator at 3 could insert plugs so as to use the cells E, F, G, H, I, J in a combination of all in parallel, three in parallel two in series, two in parallel three in series, or all in series, just as occasion might demand.

"The cells were charged (generally at night) by connecting circuit No. 1 to the

desired results. Portable resistance frames were provided, consisting of wooden frames mounted on neat iron feet, having German-silver wire coils stretched between brass blocks on both sides. There were sixteen pairs of coils of one resistance, and ten pairs of one-tenth of that resistance, all joined in series between two binding posts, and so arranged that any number of coils of either denomination could be short-circuited by means of two plugs; thus the resistance could be altered by small steps.

A third plug was provided to prevent the necessity for opening the circuit when altering the resistance. The measuring in-

struments were portable, Weston's and Hartman-Braun. This entire electrical equipment was fairly satisfactory and was duplicated later. It had many defects; for instance, it was possible to connect cells in parallel and series at the same time and the student sometimes preferred to make connections haphazard rather than work out and understand the whole scheme. And even though he did understand it, the chances for making a wrong connection were too great because of the confusing large number of blocks on the boards. The resistance frames had the fault that the German-silver wire soon became so corroded as to break. Replacing the coils by tinned steel wire proved to be little or no improvement. The portable instruments, too, were in danger of being injured by solutions being spilled on them, and sometimes received rather rough handling, which soon decreased their usefulness.

"For these reasons, and the growing demand for training in electrochemistry, it was finally decided to provide a laboratory and installation sufficient to accommodate eighteen students. The effort was also made to overcome as fully as possible the defects of the previous arrangement. It will readily be seen that the matter of complication would be made indefinitely worse if the number of outlets were increased to eighteen and the number of cells to fifty, so an entirely different arrangement of switch-board had to be devised. The only room available was one fifteen feet by twenty-six feet, as shown in Fig. 3, and it soon became evident that this room would not accommodate more than sixteen students, allowing each individual three feet by twenty inches of table space.

"Storage cells were, because of their constancy, decided upon for this installation. Those in use have 120 ampère hours' capacity, with a normal discharge rate of 15 ampères and a maximum rate of 30 ampères. Two groups of twenty-four cells each were located in the compartments shown; they supply their respective sides of the room.

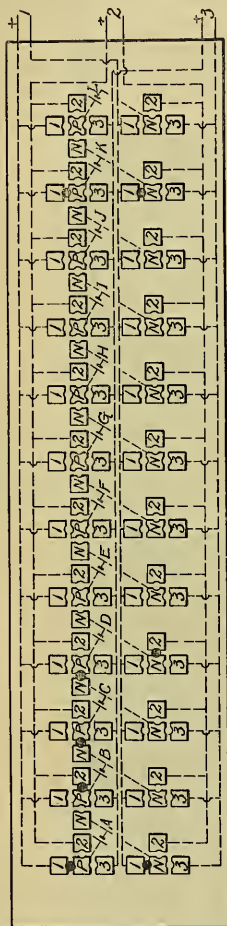

Fig. 2. Old Distributing Board.

struments were portable, Weston's and Hartman-Braun. This entire electrical equipment was fairly satisfactory and was

They are supported on racks of four shelves each, six cells per shelf. Each shelf is thoroughly paraffined and a half inch layer of ground quartz placed around the jars.

two of them each controlling the six places on their respective sides of the room, and the third controlling the four places in the center. The face of one of these boards is

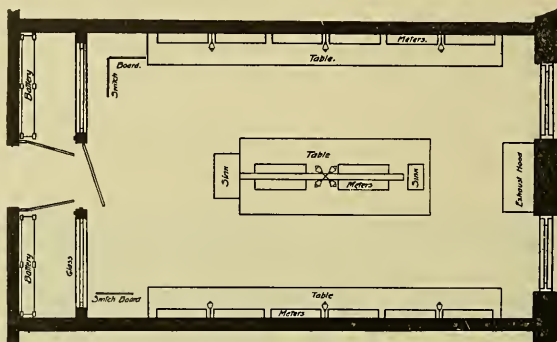

FIG. 3. Electrolytic Laboratory.

Fig. 4 shows one of these compartments with the lead wires and cut-outs for each cell.

shown in Fig. 5, the letters on the face referring to the working tables controlled.

“The switchboards are three in number,

“The switchboard on the east side of the room consists of a slab of enamelled slate



FIG. 4. Battery Room.

24 by 34 inches, one inch thick, and contains, for each of the six outlets to be controlled, one circle of twenty-five contact pieces, and has two spring levers, insulated from each other and moving about a common center, sweeping over them. The contact blocks are numbered consecutively from 0 to 24 and a stop is provided to pre-

wire leads from the six similarly numbered blocks to the junction between two cells. In this lead is provided the usual fuse. The circles are lettered A, B, C, etc., consecutively, corresponding with the letters at the outlets to be controlled.

"Should the operator at the outlet E, for instance, need two cells, he goes to this

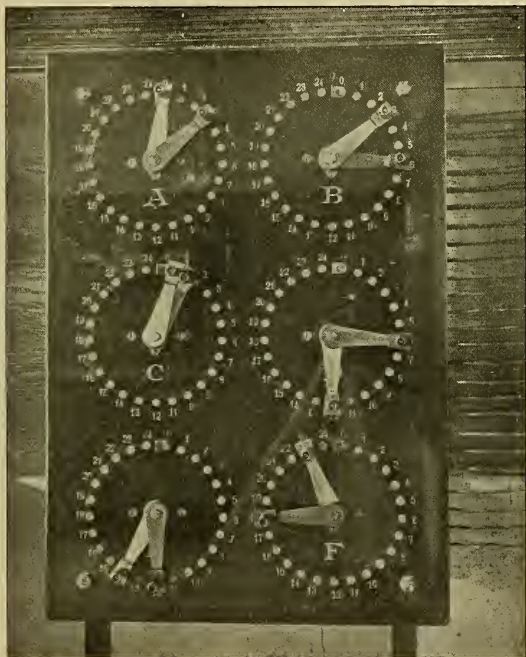

FIG. 5. Distributing Board.

vent the levers from sweeping past the zero. Cell No. 1 is connected between blocks numbered 0 and 1 in each of the six circles, cell No. 2 between blocks numbered 1 and 2, and so on for the remainder of the twenty-four cells in that group, so that all blocks similarly numbered on the one board are connected together, and but a single

board, and finding that the cells from the twelfth cell forward are not being used in any of the circles, he places one of his levers on contact block No. 12 and the other one on No. 14. There is thus very little chance of doing anything wrong, or for persons to interfere with one another, because there is no necessity to use the same cells, and at a

glance one can observe which cells are in use. Fig. 6 shows the electrical connections from one of these distributing boards to the cells and outlets on the working tables. The levers themselves are too narrow at their outer ends to reach across from one block to another, to prevent short circuiting the cells, so they are provided with fiber extensions on each side to prevent their falling between the blocks, and also to prevent their making contact with each other. The switchboard on the west wall is exactly similar to the one just described, it containing the circles G, H, I, K, L, and M, while the third one, which controls the four outlets on the center table, is but twenty-four

charge rate of the cells exceeds the greatest estimated current needed by one operator. All brass parts on the back of the board, as well as the bared ends of the wires, are thoroughly coated with P. and B. paint, while the brass parts on the front are heavily lacquered to prevent corrosion. The surface of the contact blocks can easily be cleaned with fine sandpaper.

"The measuring instruments, after some deliberation, were chosen of the switchboard type. While this necessitated procuring at least one-third more instruments, yet the initial cost was considerably lower than if portable instruments had been provided, and experience with portable instru-

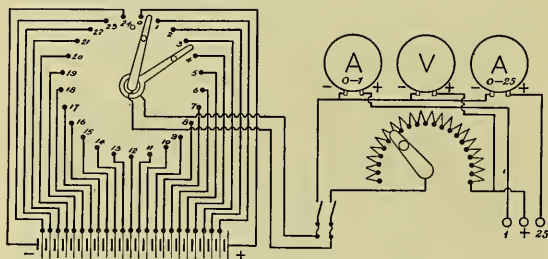

FIG. 6. Connections to Working Table.

inches square, but has twenty-six contact blocks in each circle. They are numbered 0, 24, 25, 26, and so on to 48. Between the two blocks numbered 0 and 24 are connected the cells of the group on the east side of the room; between the blocks 24 and 25 is connected cell No. 1 of the west side of the room, while cell No. 2 is connected between blocks numbered 25 and 26. This arrangement connects the two groups of cells in series, and permits the use of from one to forty-eight cells at the center table when necessity requires. It will, perhaps, have been noticed that there is no provision made for connecting cells in parallel, and this is not necessary, as the maximum dis-

ments leads me to believe that a greater accuracy will be attained with switchboard instruments of a good form, if not immediately, yet surely after the first six months of use.

"Each outlet is provided with a fused switch, a voltmeter, two ammeters, a rheostat and a terminal board. They are connected as shown in Fig. 6. The positive lead after passing through the variable resistance runs directly to the positive binding post. The wire coming from the negative binding post runs to the low reading ammeter and thence to the negative side of the switch, while the negative post marked 25 is connected to the same switch terminal,



but through the ammeter of large capacity. The anode of the electrolytic cell is therefore always connected to the middle binding post and the kathode either to the post 1 or 25, depending upon the strength of current it is intended to pass through the cell. The voltmeter, being connected as shown, measures the potential differences at the terminals of the cell, except for the addition of the small fall of potential through the ammeters.

"The voltmeters on the side of the room

against a backboard with a heavy felt gasket, making the joint. The wires come out through hard rubber tubes sealed at their outer ends by insulating tape. The rheostats are of the enameled type, chosen because of their being impervious to fumes. They have a total resistance of 172 ohms, divided into 51 steps in such a way that their resistances form a geometrical progression. The first step, and the sum of all the steps, being chosen in accordance with data of the resistances of the baths deter-

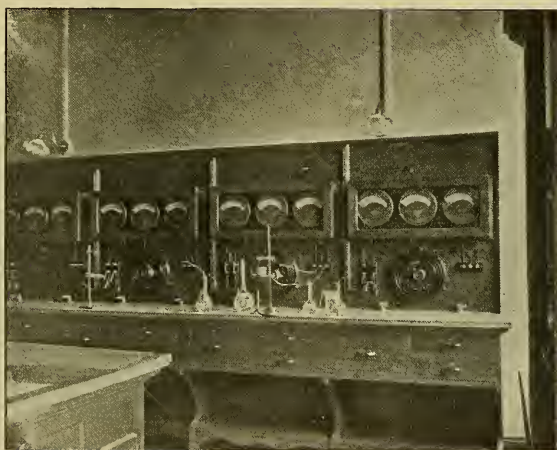

FIG. 7. Working Table.

have scales ranging from 0 to 50, and divided to 1-2 volts. Those on the center table range from 0 to 120.

"The ammeters ranging from 0 to 1 ampère are divided to 1-100 and those reading from 0 to 25 are divided to 1-5 ampères. The three instruments are mounted side by side on an oak backboard extending the whole length of the room and are covered by an air-tight case with a glass front, as shown in Fig. 7. The cases have neither doors nor a back, but are simply screwed

mined for the work done under the old system.

"The wires, both those in the battery rooms and those in the laboratory proper, are covered with rubber, and those in the laboratory are further encased in oak molding, but this rather for appearance's sake than for protection. The whole installation, as well as the other fittings of the room have a very neat and finished appearance.

The problems investigated by students in

this laboratory are the study of the influence of current density and concentration upon the course of chemical reactions, the application of gas analysis to the study of the latter (in the formation of hypochlorites and chlorates), ion transference (in the electrolysis of dilute sulphuric acid or sodium hydrate) with a diaphragm, formation of persulphuric acid (influence of concentration, of current density, of temperature), metal precipitations with soluble and insoluble anodes, the introduction of aid-reactions, experiments with molten electrolytes, experiments with multipolar electrodes, the determination and separation of metals,

The two laboratories afford all that is essential to acquaint the student with the fundamentals of electrochemistry, and give him also ample facilities for research in this domain of chemical science.

EDGAR F. SMITH.

LEGISLATIVE RECOGNITION OF SCIENTIFIC WORK.

It is not often that SCIENCE has the opportunity of chronicling an event such as happened at Madison, Wis., on March 27th, when the Legislature of the State in open session presented to Dr. S. M. Babcock, of the University of Wisconsin, a beautiful



the electrolysis of a series of organic compounds (reduction and synthesis), etc.

The writer is indebted and under many obligations for this installation to Provost Harrison who provided the necessary funds.

In conclusion it may be said that in a second room close by there is also provision for work at high temperatures. A Moissan and two Borscher's furnaces are used for this purpose. They are in direct connection with a 50-horse-power dynamo and are furnished with satisfactory resistance and measuring instruments. They are applied in the reduction of oxides, in the electrolysis of fixed salts, the production of alloys, etc.

bronze medal 'recognizing the great value to the people of this State and the whole world' of his inventions and discoveries, 'and his unselfish dedication of these inventions to the public service.'

Governments such as ours are not prone to recognize deeds of scientific men, but the service rendered in this connection was of such value that the State has honored itself by paying honor to the man who refused to take out a patent on his invention, but gave it freely and willingly to the people.

Dr. Babcock's discoveries in the field of agricultural science have been many,

but the development of his system of rapidly determining the amount of butter fat in milk has practically revolutionized the dairy industry. It saved the system of factory dairying from destruction by giving a method for the equitable division of moneys earned, and its rapid extension into all dairy countries of the world has contributed much to the renown of American science in other parts of the earth.

The recognition of Dr. Babcock's services by the State of Wisconsin is not confined to such narrow geographical limits. Although not an exhibitor, last year he was awarded the Grand Prix d'Honneur at the Paris Exposition. Recently the dairymen of New Zealand have sent him a beautiful testimonial in the shape of an elegantly bound hand-painted album of New Zealand scenery.

Dr. Babcock's fame as an inventor rests largely upon his milk test, but to men of science, who are familiar with dairy and agricultural investigations, his many discoveries in these fields are regarded as even more brilliant and of more value to science than the invention for which he is now honored.

---

*SPRING MEETING OF THE COUNCIL OF THE  
AMERICAN ASSOCIATION FOR THE  
ADVANCEMENT OF SCIENCE.*

THE spring meeting of the Council was held in the Assembly Hall of the Cosmos Club on the afternoon of April 17, 1901. There was a larger attendance of members than is usual at the spring meeting.

The permanent secretary presented a report upon the operations of his office since the midwinter meeting of the Council, including with this a report of the committee appointed at the midwinter meeting and empowered to act upon the applications for membership received in the interim between the midwinter and spring meetings. The report of the committee was

very encouraging. It seems that by means of letters signed by the president and the permanent secretary, and addressed to teachers of science in the universities and collegiate institutions of the country, a large number of new members has been added to the rolls of the Association. Further, local committees have been formed at several hundred points in the United States, and empowered by the president and permanent secretary to make an effort to increase the number of members in their several localities. As a result of this work 540 new members have been elected since last Christmas, a number of these being very prominent men of science, who, although formerly members of the Association, had for one reason or another allowed the membership to lapse.

The general condition of the Association was reported to be admirable. In point of number of members the high-water mark was reached in 1891 at the Washington meeting, when there were 2,054 members on the rolls of the Association. At the present time the actual membership of the Association paid up to January 1, 1901, is in the neighborhood of 2,350 while about 100 additional members have been recently elected, but have not yet completed membership.

The permanent secretary further reported that the arrangement with the journal *SCIENCE* is apparently giving perfect satisfaction and is greatly helping the Association in many ways.

The arrangements for the Denver meeting were reported to be progressing favorably. Local committees in Denver are organizing and a railroad rate of one fare plus two dollars west of Chicago has already been gained. No definite conclusions have been reached by the passenger associations east of Chicago, but it is expected that the details will be settled and that the preliminary announcement concerning the meeting will

be issued to all members of the Association by the middle of May.

The permanent secretary presented his financial statement for the year ending December 31, 1900, which showed receipts amounting to \$12,321.60, and expenditures, including \$1,300 transferred to the treasurer, amounting to \$7,579.84, leaving a balance to new account of \$4,741.76. Some unusual expenditures were mentioned in this account, especially the expenses of the New York meeting, which were borne by the Association instead of by the local committee as at previous meetings, and the storage on back volumes and the expense of their removal to New York, where they are now stored free of charge to the Association in the Library of Columbia University. The account, having been properly audited, was accepted by the Council and ordered printed in the next volume of *Proceedings*.

Changes in their personal plans for the summer having necessitated the resignations of Professor Lord, Secretary of Section A; Dr. Reed, Secretary of Section B; Mr. Penrose, Secretary of Section E; and Miss Benneson, Secretary of Section I, their resignations were accepted. Dr. G. A. Miller was elected to fill the vacancy as secretary of Section A, and provision was made for the temporary filling of the other vacancies by committees.

Dr. C. S. Minot presented a report on behalf of the committee appointed to consider the plan of securing a convocation week immediately after the Christmas holidays. The Association of Universities, consisting of the fourteen leading American universities, passed unanimously a resolution recommending that a week be set aside for the meeting of scientific and learned societies, and steps are now being taken to secure from the universities an agreement not to hold their sessions during the week in which the 1st of January occurs.

Dr. Thomas Wilson made a report of progress on behalf of the committee on the protection and preservation of objects of archeological interest, showing that a bill had been carefully drafted and had nearly passed Congress last session, being laid aside only on account of urgent legislation.

The permanent secretary was instructed to take up the matter of the preparation of an index to the first fifty volumes of the *Proceedings* and to take such preliminary steps as he might deem advisable, and report in full at the Denver meeting.

#### SCIENTIFIC BOOKS.

*Gli Insetti Nocivi.* By DR. A. LUNARDONI and DR. G. LEONARDI. Naples. 4 vols. 1889-1901.

Since our knowledge of European economic entomology has largely been drawn from books descriptive of the injurious insects of middle Europe, it is a distinct pleasure to have before us for reference a large and valuable work on the injurious insects of a part of southern Europe—the Italian region. This work is, however, more than a compendium of the noxious insects of Italy; it is, practically, a text-book of Italian entomology with detailed accounts of injurious species. Volumes I. and II., dealing with the general subject, Coleoptera and Lepidoptera, are by Dr. Lunardoni; Volumes III. and IV., dealing with the remaining orders, are by Dr. Leonardi. Volume I. contains 570 pages; Volume II., 287 pages; Volume III., 549 pages; and Volume IV., 862 pages.

In the general subject are included directions for the control of noxious insects. Of special interest in the part on Coleoptera is a table for the determination of the species of *Scolytini* according to the nature of their galleries. In the second volume, dealing with the Lepidoptera, the chapters treating of the Tortricidæ and Tineidæ are very full. The discussion of remedies for species in these two families is of considerable value to American workers, since many of these moths are injuriously abundant in the United States.

In the third and fourth volumes the figures are more numerous and the bibliographic lists

more complete, but unfortunately the typographical errors are rather annoying. The Hymenoptera occupy 170 pages of Volume III, the larger part of which treats of the gallflies and sawflies. The Diptera occupy the remainder of Volume III., and are treated at more length than the preceding orders. The fleas occupy the position of a family at the end of the order. Several Trypetidæ, especially *Dacus oleæ*, *Ceratitis hispanica* and *Rhagoletis cerasi* are treated in much detail. The Hessian fly, which appears under the unfamiliar generic name of *Mayetiola*, occupies fourteen pages.

In the fourth volume the Neuroptera are passed over rather hastily. The Pseudoneuroptera are included under the Orthoptera. The Hemiptera receive the fullest treatment of all. Over 180 pages are occupied with the Aphidæ, and 200 with the Coccidæ. *Phylloxera* covers 75 pages. Nearly all the Coccidæ are figured. Under the name of *Aonidiella perniciosus*, a long account is given of the San Jose scale. In the Orthoptera considerable space is devoted to the remedies for grasshoppers; spraying machines and catching machines, drawn by two men, seem to be especially favored. The volume concludes with a brief notice of the Thysanura under the ordinal name of Pseudoinsecta.

NATHAN BANKS.

*An Introduction to Modern Scientific Chemistry*, in the form of popular Lectures suited for University Extension students and general readers. By Professor LASSAR-COHN, Ph.D., University of Königsberg. Translated from the Second Edition by M. M. PATTISON MUIR, M.A., Cambridge. New York, D. Van Nostrand Company. Pp. viii + 348. Price, \$2.00.

The author's preface says: "In this introduction to *Modern Scientific Chemistry* an attempt is made to give a succinct and accurate presentation of chemistry on strictly scientific lines, and at the same time in as popular a form as is compatible with the vast range of the subject. The book can be followed easily by any one who takes a serious interest in natural science, and will not, I hope, be unwelcome to the younger chemists who are still pursuing their studies. A teacher of chemistry

who may not have paid special attention to the methods of presenting his subject will perhaps find in the book something useful to himself and helpful to his hearers."

A careful examination of the text impresses one with the idea that the author has made a particularly happy use of the word modern in his title; and that the promises of the preface have been abundantly fulfilled. The author has been eminently successful in solving the difficult problem of giving the theories and facts of chemistry in a form not only popular but exact. The keynote of the book is its emphasis of the fundamental conceptions of the science.

The style is clear, convincing and always interesting. While the book is intended primarily for University Extension students and general readers, to the student and younger teachers of chemistry it offers a wealth of valuable, accurate information, especially concerning the chemical principles involved in the manufactures of illuminating gas, smokeless powders and other explosives, fertilizers, matches, glass, aluminium, etc.

The reader who does not find this book helpful and inspiring must be very well informed in scientific chemical subjects.

The translation is excellent, and will serve to introduce Professor Lassar-Cohn's work to a new world of readers.

The crudeness of the illustrations (by the author) is the only unsatisfactory feature of a book of rare merit.

WILLIAM B. SCHÖBER.

LEHIGH UNIVERSITY.

*An Elementary Treatise on Qualitative Chemical Analysis*. By J. F. SELLERS, Professor of Chemistry, Mercer University, Georgia. Boston, Ginn & Company. 1900. Pp. ix + 160.

The author has attempted in this treatise to place qualitative analysis upon a scientific basis, to do for this subject what Ostwald has done for analytical chemistry in general. It is very evident from the nature and arrangement of that part of the book devoted to the theory of solutions that it is a reflection of Ostwald's 'Foundations of Analytical Chemistry.' As such it is to be commended. The book, how-

ever, is evidently intended for a younger class of students than Ostwald intended his work. The author has so condensed the subject, and has attempted to cover so much ground, that it is believed it will be difficult for the student to grasp the real significance of the subject. It would have been a much more valuable book if the theory of solutions had been presented more simply, perhaps at some greater length, and with more numerous discussion of examples.

Some of the statements will, undoubtedly, give the student a false impression. On pages 19 and 21 it is stated that the amount of dissociation is increased by heat, giving the impression that this is a general law. Again, on page 21 one gets the idea that the greater the dilution the greater is the chemical activity. The explanation of the effect of a salt of a weak acid on the strength of a strong acid is merely a statement of fact.

That portion of the book, pages 27-157, devoted to the processes of qualitative analysis is well arranged, practical and progressive, including all the more recent and approved methods of separation. Considerable stress is laid upon spectroscopic analysis. The application of normal solutions to laboratory reagents is to be commended.

H. F.

*Laboratory Instructions in General Chemistry.* By ERNEST A. CONGDON, Professor of Chemistry, Drexel Institute, Philadelphia, P. Blakiston's Son & Co. 1901. Pp. viii + 110.

It is difficult to review justly a laboratory book of experimental chemistry which is primarily intended for the author's own students, because there is no means of knowing what instruction the student has received from the lectures which accompany the laboratory course. When, however, it is stated that the book can be used with any standard text-book, the reviewer's task becomes much simpler, since the laboratory guide is supposed to follow somewhat closely the text of the standard work.

The first 21 pages of this book are devoted to experiments illustrating principally the laws of physical and chemical changes, and chemical reactions. These experiments, if the student is expected to follow them in order, are poorly selected and badly arranged. Indeed many of

them are entirely out of place. Some of the experiments involve the use of substances, the properties of which must be entirely unknown, and it would be impossible to explain at so early a stage the nature of the reactions taking place. The student is asked, on his second or third day in the laboratory, to try the following experiments: the action of sulphuric acid on a mixture of potassium chlorate and sugar, the preparation of gunpowder, and red and green fires. These experiments undoubtedly do represent physical and chemical changes, but perhaps too violently for a beginner. Under the chapter on reactions, the student is asked to write the reactions between ferric chloride and ammonia, and ammonium sulphocyanide, ferric hydroxide and hydrochloric acid. All this before oxygen has been studied!

Beginning with oxygen, however, the experiments are the standard experiments to illustrate the properties of the various elements.

An appendix of fifteen pages contains quantitative experiments to illustrate the laws of definite and multiple proportions and the various gas laws. It is believed that some of them are too difficult for first-year students in chemistry.

H. F.

*The Chemists' Pocket Manual.* A Practical hand-book containing tables, formulas, calculations, physical and analytical methods for the use of chemists, assayers, metallurgists, manufacturers and students. By R. K. MEADE, B. S., Instructor in Chemistry in Lafayette College, Easton, Penn. Easton, Penn., The Chemical Publishing Co. Price, \$2.00.

The nature and general contents of this book are described in the title. The book is well printed and contains such information as a chemist is almost daily in need of, and can be highly recommended as a reference book. The only feature of the book about which anything else than praise can be expressed is the price at which it is sold. The book is about 4 x 6 inches and contains 193 pages. The 'Chemiker Kalender,' the general nature of which this book follows, with its supplement, contains about three times the amount of material found in this book and only costs one half as much.

J. E. G.

## BOOKS RECEIVED.

*Le système métrique des poids et mesures.* G. BIGOURDAN. Paris, Gauthier Villars. 1901. Pp. vi + 458. 10 fr.

X *A Treatise on Electro-magnetic Phenomena and on the Compass and its Deviations.* COMMANDER T. A. LYONS. New York, John Wiley & Sons; London, Chapman & Hall, Limited. 1901. Pp. xv + 556.

*Phycomyceten and Ascomyceten.* ALFRED MÖLLEE. Jena, Gustav Fischer. 1901. Pp. xii + 318 and 11 plates. Mk. 24.

*Elementary Questions in Electricity and Magnetism.* MAGNUS MACLEAN and E. W. MARCHANT. London, New York and Bombay, Longmans, Green & Co. 1900. Pp. 59.

*The Romance of the Heavens.* A. W. BICKERTON. New York, The Macmillan Co.; London, Swan, Sonnenschein & Co., Limited. 1901. Pp. iii + 284. \$1.25.

X *Text-book of Zoology, treated from a Biological Standpoint.* OTTO SCHMEL. Translated from the German by RUDOLF ROSENBLACK. Edited by J. T. CUNNINGHAM. New York, The Macmillan Co.; London, Adams and Charles Black. 1901. Pp. xvi + 493. \$4.00.

*Diseases in Plants.* H. MARSHALL WARD. London and New York, The Macmillan Co. 1901. Pp. xiv + 309. \$1.60.

## SCIENTIFIC JOURNALS AND ARTICLES.

THE *Botanical Gazette* for April contains further descriptions of new species of North American trees by Professor C. S. Sargent. Among them are thirteen species of *Crataegus*, which is proving to be one of the most prolific of our genera in species, a new *Betula* from Alaska, and a new *Cupressus* from California. Professor C. O. Townsend writes upon the effect of hydrocyanic acid gas upon grains and seeds. Since this gas has become extensively used for fumigating purposes, it has become important to determine its effect upon the germination of seeds and upon their use as food. Professor Townsend has demonstrated that if the grain and seeds are dry the influence of the gas upon the vitality is far less marked than if they are moist. Dry seeds treated with the gas are not injured for food, but damp seeds should not be used until several hours after removal from the gas. Mr. A. C. Life contributes an interesting study upon the tuber-like rootlets of *Cycas revo-*

*luta*, in which the rôle played by the fungi and by the algae upon the formation of these tubercles is worked out. Mr. Newton B. Pierce describes a new bacteriosis of the walnut which has become a well-marked disease in California. The active organism proves to be a new species of *Pseudomonas*. The usual book reviews, minor notices and notes for students complete the number.

THE second (April) number of Volume II. of the *Transactions* of the American Mathematical Society contains the following papers: 'Canonical Forms of Quaternary Abelian Substitutions in an Arbitrary Galois Field,' by L. E. Dickson; 'Certain Cases in which the Vanishing of the Wronskian is a Sufficient Condition for Linear Dependence,' by M. Bôcher; 'An Elementary Proof of a Theorem of Sturm,' by M. Bôcher; 'On the Determination of Surfaces capable of Conformal Representation upon a Plane in such a Manner that Geodetic Lines are represented by Algebraic Curves,' by H. F. Stecker; 'On the Existence of a Minimum of Integral  $\int_{x_0}^{x_1} F(x, y, y') dx$  when  $x_0$  and  $x_1$  are Conjugate Points, and the Geodesics on an Ellipsoid of Revolution; a Revision of a Theorem of Kneser's,' by W. F. Osgood; 'On the Geometry of Planes in a Parabolic Space of Four Dimensions,' by I. Stringham.

THE March number of the *Bulletin* of the American Mathematical Society contains the following papers: 'Report of the December Meeting of the Chicago Section,' by Professor T. F. Holgate; 'Indirect Circular Transformations and Mixed Groups,' by Professor H. B. Newton; 'Pure Mathematics for Engineering Students,' by Professor A. S. Hathaway; 'Review of Adams' Unpublished Papers,' by Professor E. W. Brown; 'Notice sur M. Hermite' (translation of an address before the Paris Academy of Sciences), by M. C. Jordan; 'Notes'; 'New Publications.' The April number contains the following papers: 'Report of the February Meeting of the Society,' by Professor F. N. Cole; 'Green's Functions in Space of One Dimension,' by Professor M. Bôcher; 'On a System of Plane Curves having Factorable Parallels,' by Dr. Virgil Snyder; 'Possible

Triply Asymptotic Systems of Surfaces,' by Dr. L. P. Eisenhart; 'Note on Hamilton's Determination of Irrational Numbers,' by Dr. H. E. Hawkes; 'Review of Muth's Elementarteiler,' by Mr. T. J. I. A. Bromwich; 'Shorter Notices': 'Fricke's Lectures on Higher Mathematics,' and 'Böger's Plane Geometry of Position,' by Professor H. S. White; 'Notes'; 'New Publications.'

#### SOCIETIES AND ACADEMIES.

##### SECTION OF GEOLOGY AND MINERALOGY OF THE NEW YORK ACADEMY OF SCIENCES.

At the meeting of the Section on March 18th, the following program was presented:

'The Cambro-Ordovician Outlier at Wellstown, Hamilton County, New York.' In introducing the subject of the paper Professor Kemp gave a brief account of the physiographic problems presented in the Adirondacks and of the significance of the smaller outlines of Paleozoic strata which occur within the crystalline area. He then discussed the Wellstown exposure and described it in much the same way as he has already done in print in the 'Eighteenth Annual Report of the State Geologist of New York,' page 145. The general conclusion favored the existence of land areas of ancient crystalline rocks in the vicinity of Wells, and, it seemed to the speaker, that the peculiar sediments could not be explained in any other way. Pebbles, as large as one's fist, of gneiss similar to that found in the ancient hills, are imbedded in the Trenton limestone, and much sand is found in the limestones of both the Calciferous and the Trenton. It was admitted that the present valley is due to faulting, as has been previously claimed by Dr. R. Ruedemann, but the shores of the late Cambrian and early Ordovician could not have been far from the present outcrops of the Paleozoics at Wells. Mr. Van Ingen and Doctors Levison, Dodge, White and Julien took part in the discussion of the paper.

Dr. Julien remarked, in regard to the sand found in the limestones to which Professor Kemp referred, that although the smaller and angular portion of the sand, in which feldspar is common, and particles of garnet, epidote

and menaccanite also occur, may possibly be residual, derived from decay of gneiss adjacent to the shores of the ancient basin, the predominant quartz grains, well rounded and even perfectly spherical, could not possibly be of that origin. Their sculpture indicates prolonged action during ages before they assumed spherical form, and that although found in sediments loose or consolidated in all periods from the quartzites of the Laurentian down to the present beaches along rivers, lakes and ocean, they represent in all cases ancient materials which have been worked up over and over again from period to period. In the Potsdam of the North American continent they have been accumulated in an extensive outer-beach deposit, the result of an enormous resorting of materials throughout the vast Cambrian time. These 'paleospheres' were doubtless derived from the same Potsdam horizon which has yielded the oolitic quartz sand of the 'singing beach' on the shores of Lake Champlain, near Plattsburg, not many miles from the Wellstown Ordovician outcrop. They certainly were not swept into this limestone basin by currents, since the absence of sorting and the parallel deposition of their axes show that they were dropped down from the surface in a continuous gentle shower. The conditions which favored this consist of the floating of sand from the beaches along sheltered bays, such as Long Island sound, on every quietly rising tide, with its seaward transport, often to hundreds of miles off the coast, commonly caught in the dredges of surveying steamers, as noted by Verrill and others, and in its constant subsidence over the bottom. Such sand transport was plainly in progress over the quiet embayment occupied by this limestone, from surrounding beaches supplied from the decay and disintegration of an ancient shore of Potsdam and Calciferous sandstones. The various sands referred to in these remarks were illustrated by photomicrographs.

'A Method of facilitating Photography of Fossils' was described by Mr. Gilbert Van Ingen. The process consists in forming, on the surface of the specimen to be photographed, a thin coating of ammonium chloride by the combination near that surface of ammonia gas and



hydrochloric acid gas. Such a coat effectually hides all coloration of the specimen and reflected light, and does not obliterate the finer details of the sculpture. The salt is perfectly harmless and may be readily removed by water, or by a soft brush. The paper was discussed by Professors Stevenson and Kemp, and Drs. Levison, Julien and White.

THEODORE G. WHITE,  
Secretary.

DURAND WOODMAN,  
Secretary.

THE NEW YORK SECTION OF THE AMERICAN  
CHEMICAL SOCIETY.

The regular meeting of the New York Section of the American Chemical Society was held on Friday evening, April 5th, at the Chemists' Club, 108 West Fifty-fifth street, and over fifty members were present.

The following papers were read:

F. A. Sieker—'The Detection of Methyl Alcohol.'  
A. H. Gotthelf—'The Synthesis of Alkyl Ketodihydroquinazolins from Anthranilic Acid.'

Durand Woodman—'Note on the Determination of Moisture in Coal.'

E. F. Kern—'Comparison of Methods for the Electrolytic Precipitation of Iron.'

E. F. Kern—'The Electrolytic Precipitation of Nickel and Cobalt from a double Cyanide Solution.'

In the discussion of Mr. Sieker's paper, Dr. Eccles suggested that for a method of detecting methyl alcohol depending on the production of a specific odor, he thought that which produced methyl salicylate was to be preferred as more characteristic than the one described producing formaldehyd.

Dr. Woodman's paper was an effort to ascertain more clearly the effect of oxidation in drying samples of coal according to the accepted method for determination of moisture. It appeared that the apparent loss of moisture in a stream of dry carbonic acid gas was uniformly less than when the coal was heated in contact with the air. This indicates that by the ordinary method there is a loss by oxidation in the first stages of heating, before the well-known increase of weight begins by more prolonged heating. The paper evoked considerable discussion as to whether the secondary increase of weight was due to oxidation, occlusion or to some change not yet explained. It was stated

that further work was in progress with a view to clearing up some of these points.

Mr. Kern gave a very full and valuable exposition of the electrolytic methods for precipitation of iron, nickel and cobalt.

After the transaction of some miscellaneous business in connection with the twenty-fifth anniversary of the Society, the meeting was adjourned to May 10th.

BIOLOGICAL SOCIETY OF WASHINGTON.

THE 338th meeting was held on Saturday evening, April 6th, and was devoted to an address by Erwin F. Smith, on the subject of 'Bacterial Diseases of Plants,' the speaker considering in detail diseases of the cucurbits, the cabbage and the tomato, illustrating his remarks by numerous slides. These showed the entire plants and their histological structure in health and under the effects of the diseases discussed, showing in certain cases the water canals crowded with bacteria and in others the breaking down of the cell walls and the invasion of the healthy tissue by bacteria. The speaker described the physiological differences between the species treated and said that the diseases considered were mostly conveyed from plant to plant by beetles whose bites inoculated the healthy plants with bacteria derived from the diseased plants on which they had previously fed. Hence the remedy for the disease was to wage war on the beetles.

F. A. LUCAS.

THE LAS VEGAS SCIENCE CLUB.

The regular monthly meeting of the Club was held April 9th. Mr. T. D. A. Cockerell exhibited specimens of *Sphaerium magnum* Sterki MS., found abundantly in the Pleistocene deposit of the Arroyo Pecos, Las Vegas. This species, although undescribed, was known to Dr. Sterki in the living state from Missouri, Kansas, etc.; but it had not been observed living in New Mexico. Mr. Cockerell also exhibited *Veronica agassizi* n. sp., a slug found by Professor Alexander Agassiz in Tahiti. It was related to *V. gilsoni* of the Fiji Islands but apparently distinct. Mr. Emerson Atkins read a paper on

the 'Occurrence of the Western Evening Grosbeak (*Coccothraustes vespertinus montanus*) in Las Vegas,' and exhibited specimens of the birds. These birds had never been seen in Las Vegas, until about October 30th last, when they suddenly appeared in great numbers. They had remained in the town until the present month; Mr. R. H. Powell remarked that he had seen them as recently as April 7th. Mr. Frank Springer stated that he had observed them in Santa Fé during February. Mr. E. L. Hewett exhibited a curiously twisted stone spear-head which had been found at Chappelle, N. M. It was evidently designed to twist in the wound, and was unique among the spear-heads collected in New Mexico. Mr. Hewett also called attention to a triskelion (three-leg) design which he had seen on a piece of ancient pottery from Arizona. He also showed some of the vessels from the burial mounds of the Pajarito district, N. M., in which the same design occurred, but modified, so that what appeared to be hands, with claw-like fingers, took the place of feet.

T. D. A. C.

#### DISCUSSION AND CORRESPONDENCE.

##### PRIORITY OF PLACE AND THE METHOD OF TYPES.

IN SCIENCE for April 12, 1901, Professor N. L. Britton has given an adequate explanation and justification for the rule of nomenclature which accepts precedence of page or position as a substitute for priority in time in determining which of two or more simultaneously published synonyms shall receive permanent recognition. It is further held that the proposed use of the first species as the type of its genus is simply an extreme extension of the idea of priority of place, and all reference to the method of types as a means of securing stability in the application of generic names is omitted.

In reality the priority or precedence analogy of the method of types is quite incidental to the main argument, and has been brought forward only because it seemed likely to influence favorably those who have been zealous in advocating 'page priority.' Professor Britton very properly maintains that there is an important logical distinction between the two propositions, but he does not bring out the facts that while pre-

cedence priority is a small matter, affecting a few isolated instances, stability in the use of generic names is of universal taxonomic importance, and that the method of types\* still remains the only suggested means of obtaining it. Page priority is not particularly just or reasonable, since an author's last treatment of a genus or species is likely, on the whole, to be better than the first, and a rule to take the last of the synonyms appearing in the same book would be quite as definite and as readily applicable as one requiring the use of the first. But such a policy would not be in accord with the principle of priority, and it accordingly received but little consideration when the formulation of a definite rule was undertaken. With the method of types, also, the desideratum is a uniform rule, but thus far those who object to the use of the first species have not proposed to use the last species, or any other species in particular, doubtless because they still fail to realize the taxonomic bearing of the fact that under an evolutionary view of nature a genus is no longer to be treated as a concept† or a definition, but as a group of species.

The reasons for selecting the first species as the nomenclatorial type of a genus are quite as good, to say the least, as those for accepting the first name in a book, but they appear trivial when compared with those which require the taking of *some* species as the type, and that by a definite rule of uniform application. Accordingly, it is scarcely pertinent to bring merely nomenclatorial or historical objections against the proposition to use the first species as the type, until it can be shown that the general systematic and taxonomic requirements met by the method of types can be accommodated by the use of some other than the first species.

Professor Britton's further objection to the use of the first species, that 'it would render useless for nomenclatorial purposes much original investigation through which genera have been definitely established,' must be seriously discounted, to say the least, in view of the fact that the 'original investigation' has been conducted, either without any uniform plan, or

\* SCIENCE, September 28, 1900, XI., 476.

† SCIENCE, October 14, 1898, VIII., 513.

under one incapable of producing the desired uniformity. If we may trust President Jordan's frank statement of the results of his extensive experience with the method advocated by Professor Britton, "The process of elimination has never been consistently followed, nor can the process be so defined that it can yield fixed results in the case of the complex genera of the last century."\*

Instead of supplying an argument for continuing longer on the same lines, the variety and instability inevitable under the method of elimination afford an excellent reason for seeking a more satisfactory rule of procedure. And to obtain this it is not, as Professor Britton seems to imply, necessary that 'historical types' or the expressed wishes of the authors of genera shall be disregarded. Those who are interested in the possibility of such improvements should, however, consider the several steps in the order of their importance and cease to make confusion between the taxonomic principles and the merely nomenclatorial incidents of the process.

The first essential of systematic biology is a convenient and stable taxonomy.

A satisfactory degree of convenience was attained over a century ago by the adoption of the binomial system, involving the joint recognition of generic and specific names.

Stability can be secured by the uniform use of the oldest names applied under the binomial system of nomenclature.

Generic and specific names have nomenclatorial standing when they have been used as parts of binomials.

Priority requires that a species shall bear the oldest name applied to it, and, conversely, that a specific name shall be used only for the first species to which it was applied.

Effective priority or stability in the application of a generic name can be attained by restricting its use to the congeners of the first species to which it was applied as part of a binomial.

All such principles and methods have, however, their logical and practical limitations and exceptions, but it is quite illogical and unpractical to ignore or set aside a more important for

a less important consideration. It is essential that we have some one species permanently designated as the nomenclatorial type of each genus, but it is not essential that it be the first species, and there are good reasons for admitting two exceptions, not of the method of types, but of this suggestion for its nomenclatorial application.

*Exception 1.*—Describers of genera may designate their type species in the papers in which their generic names are published.

*Exception 2.*—Generic names adopted into binomial nomenclature from older writings should be used in their original application. It is not, however, desirable or expedient that such restorations be carried in botanical literature farther back than Tournefort's 'Institutiones' (1700).

The first provision enables us to conserve such parts of systematic literature as can be readily adjusted to present ideals and methods, while the second avoids too abrupt a break between the binomial and the prebinomial literature of botany, and at the same time obviates the principal objection to 1753 as the initial date for botanical nomenclature.

Until an equally practicable alternative proposition is brought forward, the use of the first species as generic type should receive the support due to the idea of stability in biological taxonomy, whether the above exceptions be admitted or not. The exceptions do not, however, militate in any sense against the principles involved, and will but slightly increase the labor of applying the method of types. It is accordingly to be hoped that they will be deemed a sufficient concession by those who have approached biological studies from the traditional and historical standpoints, but who are still able to realize the difference between a rule of nomenclature and a primary requisite of biological taxonomy.

O. F. COOK.

WASHINGTON, D. C., April 15, 1901.

THE PROPER NAME OF THE ALPINE CHOUGH.

TO THE EDITOR OF SCIENCE: My suggestion in a recent number of SCIENCE (N. S. Vol. XIII., p. 232) that the name of the alpine chough should stand as *Monedula pyrrhocorax* L. (Hass),

\* SCIENCE, November 23, 1900, XII., 786.

in view of Hasselquist's use of the name in 1762, for the *Upupa pyrrhcorax* Linné (1758), which latter name was changed to *Corvus pyrrhcorax* by Linné in 1766, Hasselquist's name therefore having priority over the latter one by four years. Hasselquist's name having appeared first in 1757, and later in a German translation of his work,\* Mr. P. S. Sclater (SCIENCE, N. S. Vol. XIII., p. 626) thinks the name should not stand, as it was first described prior to 1758, and after that date only in a translation of Hasselquist's work. If Mr. Sclater's view be adopted, will it not be necessary to exclude many names occurring in the 10th and 12th editions of the *Systema Naturæ*, because they were originally described in earlier editions of that work?

Whether the alpine chough occurs in 'Lower Egypt' or not has in my opinion little bearing on the matter. The question is, is *Monedula pyrrhcorax* Hass, the same as *Upupa* (= *Corvus*) *pyrrhcorax* Linné; and we have Linné, who personally examined Hasselquist's collections, as an authority in the affirmative.

WILLIAM J. FOX.

THE ACADEMY OF NATURAL SCIENCES,  
PHILADELPHIA, PA.

#### BOTANICAL NOTES.

##### THE STUDY OF MOSSES.

DR. A. J. GROUT, of the Brooklyn Boys' High School, has made the study of mosses much easier by the publication of a very pretty little book, entitled 'Mosses with a Hand-Lens,' and two sets of dried and carefully prepared specimens under the titles of 'North American Musci Pleurocarpi' and 'Hand-lens Mosses.' The book is a thin octavo volume of about seventy-five pages, and is a non-technical handbook of the more common and more easily recognized mosses of the North-eastern United States. It is illustrated by helpful figures, which, if not as smoothly engraved as some to be found in recent text-books, have the merit of clearly showing what they are intended to show. The descriptions are, as indicated above, non-technical, but they will perhaps prove all the more helpful to most be-

\* 'Iter Palestinum,' etc., 1762.

ginners on that account. In all, one hundred species are noticed. The volume closes with an appropriate glossary of bryological terms and a brief index. The first collection of specimens will enable the beginner to recognize the genera and species represented, although this was not the use which Dr. Grout had in mind in their preparation. They were designed rather for the benefit of the professional bryologist, but they will serve the beginner as well, since they illustrate the plants and their fruits. The second collection, which is just now appearing, was evidently suggested by the use here indicated. It consists of similar specimens, carefully selected and supplied with neat printed labels.

#### BOTANICAL FACILITIES AFFORDED TO STUDENTS BY THE NEW YORK BOTANICAL GARDEN.

It is probably not generally known to what extent the rich treasures of the New York Botanical Garden are available to students of the several phases of botany. Although the institution is in the first lustrum of its existence, it inherited the collections of books and specimens left by Dr. Torrey after a long life of accumulative activity. There are thus nearly one million specimens in the herbarium and about nine thousand volumes in the library. Added to these are the native plants growing in the woodlands, meadows and swamps of the two hundred and fifty acres of land constituting the domain of the Garden, supplemented by the plantations of herbaceous and woody vegetation, and the already large collections under glass in the great Plant House. The laboratories, of which there are physiological, embryological, chemical, morphological and taxonomic, are housed in the fine building known as the 'Museum Building.' They occupy a suite of fourteen rooms on the upper floor of the building, and are admirably planned for the several lines of work to be done in them. From a recent statement by the director we learn that opportunities are afforded for work in the following subjects: Physiology of the cell, ecology, morphology of algae, morphology of fungi, morphology of bryophyta, morphology of pteridophyta, morphology of spermatophyta, experimental morphology, taxonomy of algae, tax-

onomy of fungi, taxonomy of bryophyta, taxonomy of pteridophyta, taxonomy of spermatophyta, taxonomy of gramineae, embryology of spermatophyta, special taxonomy, regional botany, physiology of nutrition, ecological physiology, physiological anatomy, general physiology. The director says further, "Almost any problem in botany may be taken up by the trained botanist, who may come to the laboratories with the expectation of finding facilities for his work." It should be borne in mind that 'the laboratories never close for a vacation,' and that one may work here when most universities are closed.

#### A STUDY OF WHEAT.

MR. M. A. CARLTON, of the Division of Vegetable Physiology and Pathology of the United States Department of Agriculture, has for several years been engaged in a study of wheat with especial reference to its growth in different portions of this country. He finds that the country may be divided into eight wheat districts, as follows: (1) The soft wheat district, including mainly the north Atlantic states (in Virginia the mountainous region only); (2) the semi-hard winter wheat district, including the north central states; (3) the southern wheat district, including the northern part of the southern states; (4) the hard spring wheat district, including the states of the northern Plains; (5) the hard winter wheat district, including the states of the middle Plains; (6) the durum wheat district including a part of the states of the southern Plains; (7) the irrigated wheat district, in scattered areas in the Rocky Mountains and the Great Basin; (8) the white wheat district, including the larger part of the Pacific Coast states. A colored map illustrates these divisions in the bulletin (No. 24) in which Mr. Carlton discusses this subject. The species and sub-species of wheat recognized by Mr. Carlton are in the main those accepted by Koernicke and Werner in their 'Handbuch des Getreidebaues' as follows:

*Triticum vulgare*, the most valuable and widely distributed species, represented by a greater number of varieties than all other species taken together, including the soft winter wheats, hard winter wheats, hard spring wheats, white wheats and early wheats:

*Triticum compactum*, more properly a variety of the former, including the club sheets.

*Triticum turgidum*, a subspecies of *T. vulgare*, including the Poulard wheats, with such varieties as 'Seven-headed Wonder,' 'Hundred-fold' and 'Miracle.'

*Triticum durum*, a subspecies of *T. vulgare*, including the durum or macaroni wheats.

*Triticum polonicum*, a distinct species, including the Polish wheats.

*Triticum spelta*, a subspecies of *T. vulgare*, including spelt.

*Triticum dicoccum*, a subspecies of *T. vulgare*, including spelt-like wheats bearing the German name of 'Emmer.'

*Triticum monococcum*, a very distinct species, practically unknown in America, and but little grown in Europe, where it bears the German name of 'Einkorn.' It is said to be 'rust proof.'

In discussing the problem of the best varieties for this country the author says that, "considering all qualities, the best wheats in the world are of Russian origin, coming particularly from eastern and southern Russia. They are resistant to cold and drought, and are more or less resistant to leaf rust, and have the best quality of grain." Considerable space is given in the bulletin to the discussion of the means for the improvement of wheat aside from the mere introduction of valuable varieties. This is brought about by selection, and hybridization or 'breeding.' Examples of the latter are shown in a colored plate. The paper closes with a summary which contains many valuable practical suggestions.

CHARLES E. BESSEY.

THE UNIVERSITY OF NEBRASKA.

#### SCIENTIFIC NOTES AND NEWS.

THE officers of the International Association of Academies, which met last month at Paris, are as follows: *Honorary Presidents*, Dr. Mommsen, M. de Goeje, Sir Michael Foster, M. Berthelot, and M. Gaston Boissier; *Acting President*, M. Darboux; *Vice-President*, Dr. Diels; *Secretaries*, MM. Gomperz and Moissan. M. Darboux made an address of welcome, but otherwise the scientific work of the meeting has not been made public. We regret to learn that Professor G. L. Goodale, delegate from the National Academy of Sciences, was unable to

be present, having been detained at Geneva by illness.

MR. HERBERT SPENCER celebrated his eighty-first birthday on April 27th. Mr. Spencer lives quietly at Brighton. His health is fair, but he is not able to undertake much literary work.

THE Manchester Literary and Philosophical Society has awarded the Wilde gold medal to Dr. Metchnikoff, of the Pasteur Institute in Paris. The presentation was made at a meeting of the Society on April 22d, when Professor Metchnikoff delivered an address on the 'Bacterial Flora of the Intestine.'

THE King of Sweden has conferred on Professor J. H. Gore, of Columbian University, Knighthood of the Order of Wasa, in view of his services as a member of the Superior Jury and Committee of Five at the Paris Exposition.

PROFESSOR CHARLES HOWARD HINTON, of the University of Minnesota, has recently been appointed a computer at the U. S. Naval Observatory in Washington.

THE U. S. Department of Agriculture is about to establish an agricultural experiment station in Porto Rico, which will be under the direction of Mr. Frank D. Gardner, now of the Division of Soils.

DR. HARLOW BROOKS, instructor in the University and Bellevue Hospital Medical College, has been appointed pathologist to the New York Zoological Park.

THE corporation of Hull (Yorkshire, England) has recently taken over the Museum of the Literary and Philosophical Society in that town, and has appointed Mr. T. Sheppard as curator.

MR. O. P. AUSTIN, chief of the Bureau of Statistics of the Treasury Department, has gone abroad to study the statistical work of other nations.

DR. CORNELIA L. CLAPP, professor of zoology at Mt. Holyoke College, has been given a year's leave of absence which she will spend in study at Naples.

DR. B. T. GALLOWAY, director of the Bureau of Plant Industry, has been placed in charge of the seed distribution from the Department of Agriculture.

DR. TARLETON H. BEAN, who was superintendent of the New York Aquarium prior to April 1, 1898, was deprived of this position by the abolition of the office. A new position, entitled 'Superintendent of Small Parks,' was shortly afterwards created, and its incumbent was given charge of the Aquarium. Dr. Bean brought suit against the City for re-instatement, as he could not be legally discharged, and the office being abolished appeared to be a subterfuge. The Court has, however, now decided this suit in favor of the City authorities.

THE erection of a memorial to the late Right Hon. Professor T. H. Huxley in Ealing, near London, where he was born and received his early education, is contemplated. On the initiative of the Council of the Ealing Natural Science Society, a committee of those connected with the district who are interested in the project has been formed. The first meeting of this Committee was held on 29th of March last, when an executive committee was appointed (whose chairman is the Rev. Professor G. Henslow, Pres. Ealing Nat. Sci. Soc.). A bronze medallion portrait has been advocated for the central feature of the design, which may take the form of a simple mural tablet or of a more worthy monument as funds are obtainable, while should that support be forthcoming for which its projectors hope an annual grant or medal might also be founded. Subscription to the fund is not confined to the neighborhood or land of Huxley's birth, and those who may be desirous of assisting in the endeavor to keep green the memory of the great scientist in his natal town should communicate with the secretary to the fund, Mr. B. B. Woodward (120 The Grove, Ealing, London, W.).

PROFESSOR F. M. RAOULT, the eminent chemist, known for his important researches on the lowering of the freezing point and lowering the vapor tension of solvents by dissolved substances, has died at Grenoble at the age of seventy-one years.

DR. WILLIAM H. DRAPER, emeritus professor of clinical medicine in the College of Physicians and Surgeons, Columbia University, and one of the trustees of the University, died on April 26th, at the age of seventy years.

MR. E. S. NETTLETON, connected with the Department of Agriculture as an expert on irrigation, died at Denver on April 22d, at the age of sixty-nine years.

SHORTLY before the lamented death of Professor H. A. Rowland, his mechanician in the Physical Laboratory of the Johns Hopkins University, Mr. Theodore C. Schneider, died. He had been connected with the Laboratory ever since the founding of the University. Under Professor Rowland's personal supervision, he constructed the three machines used for ruling the spectrum gratings made at this laboratory and used in all parts of the world where exact measurements in spectroscopy are attempted; and for several years he has had exclusive charge of selecting and of adjusting the diamond points to the machine, and of ruling the gratings. The construction of these ruling machines involved the grinding of screws a foot or more in length, which should be as perfect as possible throughout their lengths. Mr. Schneider ground four of these screws which under the most severe tests to which they can be put have as yet shown no appreciable error. They are without doubt the most perfect screws in the world.

DR. GIULIO BIZZOZERO, professor of general pathology in the University of Turin, died on April 8th at the age of fifty-five years. He was the author of numerous important papers on changes in minute anatomy produced by disease and, more recently, on State medicine.

M. PAUL CHAIX, for many years professor of geography in the University of Geneva, has died at the advanced age of ninety-three years. He had traveled much and was the author of various works on geography.

WE also regret to announce the death of Dr. John Kloos, professor of geology and mineralogy in the Technical Institute at Braunschweig, at the age of fifty-eight years; and of Dr. Daniel Wierzbicki, astronomer in the observatory at Cracow, at the age of sixty-eight years.

THE first *conversazione* of the Royal Society will take place on Wednesday, May 8th.

THE Government of Norway and Sweden has called a conference of representatives of countries interested in marine exploration to meet

in Christiania in May. Germany, Great Britain, Denmark, Holland and Russia, besides Norway and Sweden, have indicated their intention to send delegates, and it is expected that other countries will be represented.

A TELEGRAM was received at the Harvard College Observatory, on April 26th, from Professor Kreutz, at Kiel Observatory, stating that a very bright comet, discovered by Halle at Queenstown, April 23d, was observed at Capetown by Gill, April 24d. 712, Greenwich mean time in R. A. 1h. 30m. 4s. and Dec. + 3° 27'. The comet was observed by Professor E. B. Frost at the Yerkes Observatory on the 27th, just before sunrise and close to the sun.

GOVERNOR ODELL has signed the bill which permits New York City to accept the \$5,200,000 gift of Mr. Andrew Carnegie for a free library system. The bill was drawn by Corporation Counsel Whalen and authorizes the city to purchase, erect and maintain libraries, and to enter into a contract with Mr. Carnegie to accept his gift under the conditions named by him.

THE workshop for the grinding of lenses and construction of telescopes, established by Mr. Alvan Clark, which was purchased from the heirs by one of his daughters, Mrs. William H. Grogan, Jr., and conducted by Mr. Grogan until his death last July, has been sold to the Alvan Clark and Company corporation.

BEGINNING on about the fifteenth of May, 1901, the Biological Department of the University of California will commence a systematic biological survey of the coast of that State. Temporary headquarters are established at San Pedro, and the work for the first summer will be carried south from Pt. Conception toward San Diego. A gasoline launch, which has been obtained for the season, will be fitted out with apparatus for dredging, sounding and making observations on temperature, salinity, specific gravity, etc. The work will be carried on by the members of the Department and graduate students, together with a number of investigators who have already interested themselves especially in west coast faunas. The funds to be used in the work were raised by Mr. W. H. O'Melveny, a graduate of the University, among the citizens of Los Angeles.

THE Mining School of McGill University will this year carry on its summer work in British Columbia. The class expected to leave Montreal by special car on the Canadian Pacific Railway on May 1st, and to go out to the Pacific coast, visiting the various collieries along the line of the railway and on Vancouver Island. The party will then go into southern British Columbia for the purpose of studying the mineral deposits of the Slocan, Trail Creek and Boundary Districts, and, returning by the Crows' Nest Pass route, will visit the coal mines at Fernie Hethbridge, reaching Montreal again about the middle of June.

THE daily papers state that a party of students from Harvard University will undertake, this summer, an expedition to Venezuela for botanical and zoological research. They are to leave New York on the steamer *Caracas*, on June 15th, and will proceed to La Guayra and Margarita Island.

THE assignment of field parties by the U. S. Geological Survey for the present season are as follows: Arizona: T. A. Jaggar, Waldemar Lindgren, J. M. Boutwell, F. L. Ransome, John D. Irving and R. T. Hill; Arkansas: George I. Adams; California: George F. Becker, W. Lindgren, J. C. Brauner, J. S. Diller, Geo. H. Eldridge and H. W. Turner; Colorado: C. W. Cross, Ernest Howe, J. Morgan Clements, S. F. Emmons, John D. Irving and George I. Adams; Connecticut: William H. Hobbs and H. E. Gregory; Delaware: R. D. Salisbury and George B. Shattuck; Georgia: Arthur Keith; Idaho: Bailey Willis; Indiana: George H. Ashley; Indian Territory: J. A. Taff and George I. Adams; Kansas: W. S. Tangier-Smith; Kentucky: M. R. Campbell and George H. Ashley; Louisiana: George I. Adams; Maryland: Continuation of cooperative work as in previous years, William B. Clark, E. B. Matthews and George B. Shattuck, study of ancient crystalline rocks, paleozoic stratigraphy and coastal plain deposits; Massachusetts: B. K. Emerson; Michigan: Frank Leverett, F. B. Taylor, C. R. Van Hise, C. K. Leith and W. S. Bayley; Minnesota: C. R. Van Hise and J. Morgan Clements; Missouri: W. S. Tangier-Smith; Montana: Continuation of special studies in the

Rocky Mountains, Charles D. Walcott, director; W. E. Weed and Bailey Willis; Nevada: G. K. Gilbert; New Jersey: R. D. Salisbury and George B. Shattuck; New Mexico: George H. Girty, R. T. Hill and C. W. Cross; New York: L. C. Glenn, T. N. Dale and J. F. Kemp; North Carolina: Arthur Keith; North Dakota: N. H. Darton and C. M. Hall; Ohio: Charles S. Prosser; Oklahoma: J. A. Taff; Oregon: J. S. Diller; Pennsylvania: Parts of Butler, Armstrong, Indiana, Washington, Westmoreland, Fayette and Tioga counties, M. R. Campbell, A. C. Spencer, George B. Richardson and L. Fuller; northern Pennsylvania: George H. Girty; Philadelphia and vicinity, Professor Florence Bascom and C. R. Van Hise; refractory clays of Pennsylvania, C. W. Hayes; Fulton and Franklin counties, George W. Stone; coal measures, C. D. White; South Carolina: Arthur Keith; South Dakota: N. H. Darton and J. E. Todd; Tennessee: Arthur Keith; Texas, R. T. Hill and George I. Adams; Utah: C. K. Gilbert; Vermont: T. N. Dale and J. E. Wolff; Washington: F. L. Ransome and Geo. Otis Smith; West Virginia: Cooperation with State survey under Professor I. C. White; Wayne county: M. R. Campbell, survey of Ceredo quadrangle; Wisconsin: C. R. Van Hise and W. C. Alden; Wyoming: W. C. Knight, N. H. Darton, George I. Adams and Arnold Hague.

THE correspondent from India of the London *Lancet*, writes under date of March 28th: "Plague has caused 11,560 deaths throughout India during the past week. The mortality is increasing with alarming rapidity in the Lower Provinces. Of the above total, no fewer than 7,315 deaths occurred in the Bengal districts. In Calcutta there were 1,040 deaths. The plague cases reported in this city were 1,199 against 993 during the previous week and the number of fresh living cases seen was 345. Disinfection continues to be extensively practiced, not only in respect of the rooms and houses where the cases occur, but in many of the adjoining houses. The process adopted consists in flushing the floors and spraying the walls with the standard solution of perchloride of mercury. Cases continue to occur in



the disinfected quarters, and it is impossible to show that the measure possesses much value. The outbreak in Calcutta now is more severe than that of last year, notwithstanding the repeated disinfections which have been practiced. As I have before remarked, however, the authorities are apparently able to account for nearly all the plague deaths and the investigations made after death indicate the exact location of the cases. The reported plague deaths in Calcutta nearly account for the excess mortality, and that is more than can be said for any other city. The disease is spreading in Benares and has reached to the cantonment. It continues to progress from village to village in the Gardaspur and Sialkot districts of the Punjab. In Bombay city plague has caused over 1,000 deaths during the past week. An examination of the total deaths in this city since the plague appeared in 1896, shows an excess mortality over the average of 120,000. The official reports only give 60,000 deaths from plague since its commencement in September, 1896, so that there is a very large balance to be accounted for. If the system adopted in Calcutta had been applied to Bombay, it is most probable that the greater part of this excess would have been found to be due to plague, and it is almost safe to say that Bombay city has lost 100,000 of its inhabitants from plague."

Nature learns from the *Victorian Naturalist* that Professor Spencer, F.R.S., of the Melbourne University, and Mr. F. J. Gillen, of South Australia, were expected to start from Oodnadatta, the present terminus of the transcontinental railway, nearly 700 miles north of Adelaide, on their expedition for the purpose of studying the habits and customs of the aboriginals of the northern portion of Central Australia, about the middle of April. The start has been somewhat delayed owing to the drought which has existed for some time in the portion of the continent to be visited. It is also proposed to cross into Queensland and continue Dr. Roth's ethnological work, and afterwards to traverse some of the larger rivers of the Northern Territory, and, if time permit, to visit the Wyndham district on Cambridge Gulf in Northwest Australia.

AN Institute for Tropical Hygiene was opened in Hamburg at the beginning of March. According to the *British Medical Journal*, it is a combination of laboratory and hospital, and the scientific workers in the first department will be able to find their material 'on the premises,' so to speak. The building has been erected close by the harbor; one wing contains 50 beds for tropical cases, such as malaria, beri-beri, etc. (not for infectious diseases); the second wing is taken up by the laboratories, lecture halls, etc. Here courses of lectures, combined with practical work, are to be held for the benefit of ship surgeons, navy surgeons, doctors about to settle in the colonies, and colonial medical officers of the State. The Institute has been erected by and belongs to the Free State of Hamburg, but the German Empire contributes a share of the working expenses, and the disposal of a certain number of laboratory places.

At the last monthly general meeting of the Zoological Society of London, it was stated that there had been 106 additions to the Society's menagerie during the month of March, amongst which special attention was directed to the male Tasmanian wolf (*Thylacinus cynocephalus*), seldom seen in captivity, and also to the Indian birds presented by Mr. E. W. Harper, of Calcutta, new to the Society's series. It was also stated that on Easter Monday the admissions to the Society's gardens were 46,599, being a larger number than had ever passed the gates in one day since the opening of the gardens to the public in 1828. At the close of the general meeting the first of the annual series of lectures was delivered by Professor Charles Stewart, entitled 'On the Protection and Nourishment of Young Fishes.'

---

#### UNIVERSITY AND EDUCATIONAL NEWS.

At a recent meeting of the regents of the University of Kansas, arrangements were made for the expenditure of the \$10,000 appropriated by the Legislature, for improvements in the new chemistry building, and it was also decided to purchase a liquid-air plant. \$7,000 will be

expended for additions to the library, including binding. Competitive plans for the natural history museum building, for which \$75,000 has been appropriated, and the plans of Messrs. Root and Siemans of Kansas City were accepted. This building, which is to be constructed of native stone, will be of the Romanesque style of Southern France, and adapted especially for the display of the North American mammals and other extensive collections owned by the University. It will be practically fireproof in construction and will be three stories in height. The regents will also provide for assistants in the departments of mathematics, English and history, and the men have been practically selected for these positions.

OWING to the increased appropriation made by the Legislature, the University of California has been enabled to enlarge a number of departments. The chair of mechanical engineering is to be divided, the present occupant of that chair, Professor Hesse, becoming professor of hydraulics, while the former associate, Professor Cory, returns to the department (after a year's absence in industrial work) as professor of electrical engineering. The following new instructors were also authorized by the regents at their meeting on May 19th. Two instructors in chemistry, an instructor in civil engineering, an instructor in steam engineering, an instructor in philosophy, an assistant in mechanics and two assistants in physics. The estimates for next year amount to about \$550,000, of which \$344,000 are for salaries and \$60,000 are for permanent improvements.

THE arrangements for the celebration of the bi-centennial of the Yale University in October next have now been made public. The addresses include one by President Gilman, of the Johns Hopkins University, on 'Yale in its Relation to Science and Letters' and one by Professor W. H. Welch, of the same University, on 'Yale in its Relation to Medicine.'

THE freshman and sophomore classes of Rush Medical College will be transferred to the buildings in Hull court at the University of Chicago, and after July 1st the work of the two upper years only will be done in the Rush buildings on West Harrison and Wood streets.

More than \$50,000 has been recently given to the University of Chicago for the additional equipment required. The new arrangement means that 300 medical students will be at work in the University of Chicago proper by next fall. The work of the two upper classes is clinical and must be done near the hospitals. They will have all the facilities of the old building and of a new \$110,000 building on which work has already been commenced.

At a special meeting of the council of University College, Liverpool, on April 16th, the following resolutions were adopted:

1. That, while gratefully acknowledging the advantages which have accrued to University College, Liverpool, by its association with Victoria University, this council is of opinion that a university should be established in the city of Liverpool; that this council will welcome a scheme with this object upon an adequate basis; and that a committee be appointed to consider and report upon the whole question, with power to make inquiries and to communicate with other bodies.

2. That the committee consist of all the members of council, with power to associate with them any other persons whom they may think fit.

DR. ARISTIDES AGRAMONTE, formerly chief of the bacteriological laboratory, has been appointed to the chair of bacteriology and experimental pathology in the medical faculty of the University of Havana, Cuba.

DR. H. S. JENNINGS has been promoted at the University of Michigan from an instructorship in zoology to an assistant professorship.

MR. H. W. KUHN, who is to receive his doctorate from Cornell University in June, having been a scholar, fellow and assistant there during the last three years, respectively, has been appointed an assistant professor in mathematics in the Ohio State University, from which institution he was graduated in 1897. After graduation, Mr. Kuhn was a fellow and assistant in his alma mater for one year. His investigations thus far have been chiefly in a theory of substitution groups—several papers by him in this line have been read before the American Mathematical Society.

AT Bryn Mawr College, Miss Harriet Brooks, A.B. (McGill University), has been awarded a fellowship in physics.

# SCIENCE

A WEEKLY JOURNAL DEVOTED TO THE ADVANCEMENT OF SCIENCE, PUBLISHING THE OFFICIAL NOTICES AND PROCEEDINGS OF THE AMERICAN ASSOCIATION FOR THE ADVANCEMENT OF SCIENCE.

EDITORIAL COMMITTEE: S. NEWCOMB, Mathematics; R. S. WOODWARD, Mechanics; E. C. PICKERING, Astronomy; T. C. MENDENHALL, Physics; R. H. THURSTON, Engineering; IRA REMSEN, Chemistry; JOSEPH LE CONTE, Geology; W. M. DAVIS, Physiography; HENRY F. OSBORN, Paleontology; W. K. BROOKS, C. HART MERRIAM, Zoology; S. H. SCUDDER, Entomology; C. E. BESSEY, N. L. BRITTON, Botany; C. S. MINOT, Embryology, Histology; H. P. BOWDITCH, Physiology; J. S. BILLINGS, Hygiene; WILLIAM H. WELCH, Pathology; J. MCKEEN CATTELL, Psychology; J. W. POWELL, Anthropology.

FRIDAY, MAY 10, 1901.

THE DIGNITY OF CHEMISTRY.\*

## CONTENTS:

<i>The Dignity of Chemistry:</i> DR. H. W. WILEY...	721
<i>Diamond-Glass Fluorescence:</i> DR. ARTHUR L. FOLEY .....	732
<i>How Botany is Studied and Taught in Japan:</i> KEICHI MIYAKE .....	734
<i>Scientific Books:—</i>	
<i>Schuyler on Reservoirs for Irrigation, Water Power and Domestic Water Supply:</i> PROFESSOR I. P. CHURCH. <i>Annual Report of the War Department:</i> PROFESSOR R. H. THURSTON. <i>Titchener's Experimental Psychology:</i> PROFESSOR JOSEPH JASTROW. <i>Pierce on Peach Leaf Curl.</i> <i>Books Received.</i> .....	738
<i>Societies and Academies:—</i>	
<i>American Mathematical Society:</i> DR. EDWARD KASNER. <i>Zoological Journal Club of the University of Michigan:</i> PROFESSOR H. S. JENNINGS .....	744
<i>Discussion and Correspondence:—</i>	
<i>Correction to André's Astronomie stellaire:</i> PROFESSOR GEORGE C. COMSTOCK. <i>An Appeal for Cooperation in Magnetic and Allied Observations during the Total Solar Eclipse of May 17-18, 1901:</i> DR. L. A. BAUER. <i>Clayton's Eclipse Cyclone and the Diurnal Cyclones:</i> H. HELM CLAYTON. <i>Leland Stanford Junior University:</i> PROFESSOR J. C. BRANNER and others.....	746
<i>Current Notes on Physiography:—</i>	
<i>Topographic Atlas of the United States; Terraces fronting the Rocky Mountains; The Formation of Deserts:</i> PROFESSOR W. M. DAVIS.....	751
<i>The American Geographical Society.....</i>	753
<i>Resolution of the Committee of Central Naturalists...</i>	753
<i>Scientific Positions under the Government .....</i>	754
<i>Scientific Notes and News.....</i>	755
<i>University and Educational News .....</i>	760

CHEMISTRY as a profession may be said to have completed its hundredth year, and we have met to-night to celebrate the quarto-centennial of chemical organization in America.

In our democratic country, all attempts to create a class or caste should be discouraged, especially if the attempt be made to endow the class with unusual or special privileges. We have no place for an hereditary or purchasable aristocracy, but in the function of the civic body there must be specialization, and those individuals who by choice or fortuitous incident devote themselves to special duties are brought together by occupation, by congeniality and by desire for mutual helpfulness and improvement. In this mutual attraction we find the genesis of all trade and professional organization. The aggregate is always stronger than the segregate. This unity of purpose and this conformity of effort become reprehensible only when autocratic, imperative and insolent. The assumption of superior virtues, the assertion of peculiar privileges and the interference with the rights of others are never to be advocated nor condoned.

\* An address delivered before the American Chemical Society, April 12, 1901, on the occasion of the celebration of the 25th anniversary of the founding of the Society.

MSS. intended for publication and books, etc., intended for review should be sent to the responsible editor, Professor J. McKeen Cattell, Garrison-on-Hudson, N. Y.

Every honest effort to earn a living and a competency is worthy of equal praise, and therefore in dignity of effort there is no rank. The workman in the woods, the farmer in the fields, the artisan in the atelier and the mechanic in the mill have an equal claim to the dignity of labor with the preacher, the lawyer and the professor. There is no form of labor which is beneath the dignity of any man. Instead of being a curse, labor is the greatest blessing which Providence, fate or evolution has conferred on humanity. Tolstoy, one of the greatest of living novelists, earns his living from the soil. Peter the Great was a carpenter and is said to have done much of the work in building the old palace at Peterhof. Louis XVI. was a locksmith. Washington was a farmer, Lincoln a rail-splitter, Grant a tanner, Garfield a canal boy. The natural and normal desire of men who have achieved greatness is for a piece of land where they can be in touch with the great mother of us all, the soil. To him who appreciates the true dignity of labor, no task is menial. The hands are made for toil as much as for fighting, and sweat is the most efficacious of all detergents. In derision on one occasion the Romans made Cato commissioner of sewers, but he discharged the duties of his menial office with such industry and benefit to the city that thereafter to be made commissioner of sewers was considered to be a distinguished honor.

So the true philosophy should teach us that our calling in life is a *cloacum magnum* which we are to administer, not with closed nostrils, but with open eyes and hands that do not recoil before thickened cuticle and staus.

He who is not proud of his profession is not worthy of it. This does not mean that his profession is any better than another, but when the heart is not in the work the head is sluggish and the hands are slow,

Nor do I mean that a profession should not be regarded as a means of making a living. On the contrary, that is the first and chief end of any occupation. The number of persons who work alone for the love of it is exceedingly small. Perhaps there is only one profession where it is better that a man be rich, and that is the profession of politics. Making a living out of a public position is the most precarious of all professions, and there is no collection of dependent fossils which appeals so pathetically to general commiseration as that vast aggregation of exes which lingers near the cupola of the Capitol. The *functus officio* faster has fed so long at the public crib that he knows not the taste of other food nor the means of getting it. The last of his life is an eternal Lent on which no Easter morn of soothing satiety will ever rise.

In one short walk a few days ago, I met one ex-senator and two ex-representatives, who a few years ago were farming patronage and feasting on lobster Newburgh at Chamberlins, who are now seeking to be attorneys for the holders of claims that live only in the hope that a far-off indulgent future will no longer know their worthlessness. Hungry are the looks of these men, with jaws cavernous as those of Cassius, and sad warnings of the fate of a statesman out of a job. A profession, therefore, should offer some guaranty of a livelihood dependent on merit and industry, and not upon the whim of a capricious public.

It is not my purpose to-night to discuss chemistry as a living provider. Often young men come to me and ask my advice in regard to choosing a profession. They come often with a strong inclination to chemistry and want to know what I think of the prospects for success. If they have already studied chemistry, I invariably ask: Have you a taste for chemistry? Do you love chemical studies? If they do not know, or if the answers are indefinite or

evasive, my advice is always, 'Stay out.' But especially is this so if they propose to study chemistry as a profession because it is an easy road to wealth. Alas! the paths of chemistry seldom lead to easy streets. True it is, you rarely see the chemist begging bread. Perhaps he knows too well of what it is composed. The chemist tramp too, is a kind of a *rara avis in terris cygno similitudine nigra*. The chemist may be able to change phosphorus into arsenic by oxidizing it in presence of ammonia, but even so distinguished a man as Carey Lea could only make silver yellow, and further than this intricate transmutations have not extended. Fortunes have been made by a few. A happy discovery in metallurgy or in manufacturing processes has often brought a modest fortune to the inventor, but most of the roads leading from the Patent Office end in the cemetery of hopes at first vigorous from the pliant pabulum labeled 'Having now described my invention what I claim is,' etc., 'substantially as set forth.' The parchments with the flaming seals that protect you in the sole usufruct of your genius for a period of 17 years serve most frequently as fitting cements for the deceased. If the chemist be a teacher or employed at a salary the prospect for a competence is not much better. At best these stipends are not very large. In a manufacturing enterprise, the chemist often becomes the manager, and in this case he can put by something for 'a rainy day.' If a professor, he sometimes gets to be the president of the college, provided his theology is untainted. But Universities of Chicago are not found in every academic grove. Most of our institutes of higher learning are chronically impecunious, and even the professional chair is not upholstered with a cushion which would tempt the expectant Croesus.

In general, then, it must be admitted that whatever of dignity is due the profession of

chemistry is not attributable to its tendency to wealth. I am not of that school which despises wealth, nor yet of the cult that loves it. Poverty, doubtless, has its uses in evolution and molding of character. Wealth often corrupts youth and makes of manhood but a purveyor of vice. But poverty also invites crime, and is not the most efficient preservative of virtue. A modest competence, possibly, is the ideal state, best suited to highest development and greatest usefulness. It is not always dignified to be in debt. For this reason, I should like to see the influence of this great organization whose foundation we celebrate to-night, exerted to secure better pay and more permanent employment for its members. I know this seems sordid and mercenary, but we must not always live in the clouds. The cerulean atmosphere will be more gratefully stimulating and its views be more thoroughly appreciated if we manage somehow to keep our feet well braced on terra firma. To him who cannot swim, things begin to feel a little queer when the advancing tide leaves him touching only a little flowing sand with the tips of his toes. Good and steady pay, therefore, to its devotees is no small contribution to the dignity of chemistry.

The pursuit of science is nothing else than an effort to know something of the constitution of the natural world. That knowledge is not derived from an ingenious system of vain imaginings, but is secured by a study of nature herself.

"To him who in the love of nature holds communion with her visible forms she speaks a various language," sang one of our great poets at the age of 17. Had he lived until he was 100 and grown in wisdom every year he could not have touched a truer note. The language which nature speaks to the chemist is a description of the ultimate nature of things. It is to the

chemist that nature teaches the alphabet of human knowledge. In this sense the chemist comes nearer than any other to first principles. As we grow in knowledge, we sometimes forget our small beginnings. And so it sometimes seems to me that our professional brethren of other schools are prone to despise the day of little things. Atoms and molecules are too small to cut much of a figure in the economy of nature, think some. But it is no true mark of greatness for the macrocosm to forget the microcosm. A megatherium is not the 'whole show.' It is true that in some respects chemical achievements appeal least of all scientific accomplishments to the popular attention. The isolation of krypton does not have half the interest for the public that attaches to the discovery of a new bug, especially if it have domestic tastes. In fact all the biological sciences, with the possible exception of physics, find a readier and more appreciative public than those which deal with things lifeless and for the most part incomprehensible to the layman. This truth is uttered in no complaining mood, but only to explain why Davy is not as well known as Darwin, nor Hoffmann as Haeckel. It is when chemical studies and discoveries come directly into contact with life that they lead to recognition, as in the case of Pasteur, whose great genius is recognized the world over, perhaps more generally than that of any other scientific man has ever been. But it is not alone for public applause that life is worth living, and the dignity of our science suffers no depreciation because of its apparent remoteness from human interest. I say apparent, because I do not believe that any other science has in reality any nearer bearing on human welfare than chemistry. Think for a moment how many of our industries that lie at the foundation of wealth and progress are based directly on chemistry. Think of the many others that are intimately re-

lated to it indirectly. If the clock of political progress and liberty were turned back 50 years by the battle of Waterloo, think of the loss to humanity should such a disaster befall the hosts of chemistry. Bourbonism is the natural foe of human progress, and unhappily the world is still full of anti-scientific Bourbons.

Whatever may be the branch of the profession which the chemist may pursue, he should not be indifferent to feelings of justifiable pride which come to him when he realizes all that our science has done for humanity. The disciples of evolution may have attached some opprobrium to the epithet, but the chemist is the 'connecting link' between the world of matter and mankind. We stand the nearest of all our brethren to the ultimate constitution of things, so near, in fact, that we almost tremble at the thought that by some subtle synthesis we may yet strike the spark of organic life. Of one thing at least we may feel sure. We know best of all our brethren the environment of development and growth. We may never create an environment which will make autogenesis possible, but we surely can soften some of the harder conditions of existence. To be so near the first forms of life, to be so nearly in touch with the ultimate secrets of nature, are facts which show some of the principal elements of the dignity of chemistry.

No man can lay claim to the term scientific who does not reverence the truth. That is the first element of a scientific mind. The truest proof of a reverence for the truth is a willingness to be convinced. In the times of Cromwell, the truth was supposed to be simply the dogmas of the creed, which led Hudibras to say :

"Convince a man against his will,  
He'll hold the same opinion still,  
And prove his doctrine orthodox  
By apostolic blows and knocks."

The most difficult mental attitude, which the scientific man has to contend with in his struggle for the truth, is bias. We inherit, in a measure, certain notions of things and of life. This natural inheritance is strengthened by the earlier teachings of childhood, so when we reach the age of maturity we have formed certain opinions, we are endowed with certain habits of thought which tend to dominate our mental attitude. Happily, most of these habits and most of these inheritances are sound, but now and then we find one which is clearly opposed to the conditions of existence as science reveals them. How difficult in this case to let go the old notion; how hard to bring one's self into an attitude to receive the truth! Perhaps it is only a species of conservatism which leads man to hold on to that which he has, and in this sense a certain difficulty of conviction is a guaranty of stability of thought and of social, economic and political conditions. In other words, we should heed the warning in the Bible and not be swayed by every 'wind of doctrine.' The tendency to too eagerly accept is more reprehensible than tardiness of belief. We have all seen wave after wave of illogical belief sweep over the country, and no difference how absurd a theory may be or how impossible a course of action which is marked out, it finds plenty of adherents. This instability tends to render all the conditions of natural growth and development precarious. The scientific man must be on his guard against being uncooed by any plausible or specious doctrine, as well as to keep his mind open for the acceptance of the truth. Here is where judgment comes into play, and not only should the scientific mind be open to conviction, but it should also be controlled by a sober and discreet judgment which can discriminate between the true and the false in evidence. But when soberly considered, certain facts are brought home with an

overwhelming evidence of truthfulness, the results of this evidence should be accepted, no matter how contrary they may be to our preconceived notions. Perhaps the greatest offense in this direction which the scientific man commits is a distortion of evidence to suit the case. By a slight inclination this way or that from the true point of direction an observed fact may be made to support this or that theory or condition. I am far from belittling the value of theory. When formed on substantial evidence and with a becoming ingenuity it is a valuable aid in the discovery of further truth, but a theory should never be a fetich to be revered and worshipped with the blind devotion of the religious devotee. There is nothing sacred about the theory. It is only a valuable tool to be cast aside when a better or more effective one is at hand. The dignity of our profession, therefore, has been strengthened and increased by the habit of the chemical mind of accepting the dicta which experimental evidence has provided. Detracting somewhat, however, from this dignity has been the fact that certain contentions have arisen in our profession over the interpretation of ascertained phenomena. Chemists may agree upon the character of certain phenomena which are presented, but construe them differently, and often with acrimony. A scientific discussion should be conducted with all the dignity of a scientific dissertation, and the honest differences between chemists should never be allowed to degenerate into personalities or innuendo. There is no excuse whatever for speaking slightly of the honesty or ability of a brother chemist who may happen to differ from you in his opinion of phenomena. Envy, backbiting, slander and scandal have no place in the chemical profession. I believe every one will admit that there has been less of it in the profession of chemistry than in almost any other. We know to what extent the per-

sonal quarrels among many scientific men have been carried in this country, and we are glad to say that there is no instance in which these quarrels between chemists have come into our organization to influence our action and mold our policies or to cause the growth of faction and the promotion of feuds.

There is enough for every one to do in this country without wasting his energies with envy of the accomplishment of others. About the most unprofitable occupation into which a man can fall is to complain of a lack of appreciation. It is doubtless true that in many cases the worthy man is cheated of his dues and the unworthy receives a reward out of all proportion to his services. These are accidents, which are due to the imperfection of human nature, and not to any peculiarity of scientific pursuits. There should be room for the philosophy of life in chemical science as in every other. The sensible way is to accept what happens, and not to degenerate into a kicker or the carrier of a club. The chips which are found on the shoulders of our associates are usually magnifications of the motes in our own eyes, and not due to the deposition of any really ligneous material upon the clavicle of our supposed enemy. We have plenty to do in this world without going about knocking off hypothetical chips. I have the profoundest sympathy for the man with a just grievance, and I know how many have them, but there is no greater nuisance than this same man with this same just grievance. The man who shuts his mouth, compresses his lips and bears the pain and humiliation without a sign is the one who wins our admiration in the end and often turns disaster into good.

With a proper appreciation of the dignity of our profession, we will therefore do our work as well as we can and be glad of the greater success of our professional brethren,

and not find in it a cause of sorrow and dejection. Every man who succeeds in chemistry does a work to elevate our profession and to help us all, and therefore, even from a selfish motive, we should be glad of his achievements. I realize how hard it is to see others preferred when we feel convinced that we should have had it, and yet I must be allowed to praise the courage of the man who with a smile on his face and a true feeling of well-wishing in his heart can congratulate the more successful man not with hypocritical words, but with a real sentiment of satisfaction.

There is one special way in which I think our great organization can do much to elevate the dignity of chemical science. I have spoken of the fact that chemistry does not appeal directly to the public imagination, and for this reason many of our best people do not have a true appreciation of the value of chemical services. An honorable and praiseworthy part of our profession is the rendering of professional services of a chemico-technical nature to the great industries of the world. Too often the promoters of these industries, the men with the money, the men on the boards of directors, and the stockholders, do not appreciate the real value of the services they ask for. A great corporation is perfectly willing to pay a great lawyer \$10,000, \$15,000 or even \$50,000 for professional services, whereas if a chemical expert should ask \$1,000, it would produce a kind of corporative hysteria or nervous prostration, while, in point of fact, the technical services demanded would probably be of far greater financial utility than the legal services so much more liberally paid for.

There has been a tendency among some of our profession to foster this spirit of contempt for the value of chemical services of a professional nature, not intentionally, I am glad to say, but because of a feeling, which I can hardly describe, that it is not



dignified for a chemist to sell his services for money. The falseness of this position, it seems to me, has been fully set forth in the earlier part of this address, and I believe that every right-minded person will admit that it is not derogatory to dignity to receive pay. Otherwise, I should think that we should cast dignity to the winds and look out for the 'main chance.' In my opinion, it is just as honorable and worthy to give professional advice to a great industry as it is to discover an unknown element. In our society we should have far more *esprit de corps*, more regard for the rights and privileges of each other, and a better understanding of the ethics of our profession. It is true that we now act upon the principle that it is dishonorable to take an investigation out of the hands of a brother who has once commenced it, without his permission, or in any way to trespass upon the fields which he has pre-empted. In like manner we have learned that it is dishonorable to underbid a professional brother in offering our professional services. It seems to me that the Society can do a great good towards promoting the dignity of our profession in this way by establishing not a hard and fast schedule of prices for professional services, but by bringing closer together our members who give these services so they may have a better understanding of the rights and privileges of each other. Other professions do this, especially the medical, and great benefit would be derived from a better understanding in regard to these matters.

Especially is this true from the effect it would have upon the public at large who, seeing a profession stand together and in a dignified manner demand what is right and just, would better appreciate the value of the services which they often hope to get for the very smallest possible consideration.

Perhaps the bitterest criticism to which

the chemist has been subjected has grown out of his services as expert before the courts. Here we often have the spectacle of two men, under oath, one in affirmation, one in negation. It is only natural that the expert should favor his client, but that favor should never go so far as to impugn the truth. When there is room for disagreement, I can see no impropriety in the chemist supporting with all his ability the side that employs him. He is not hired to discuss the whole problem in all its aspects, but to develop those points which make for the benefit of his employer. We cast no reflection on the honesty of the lawyer who defends, nor should we on the rectitude of the witness who testifies. But no worthy chemist will deliberately undertake to support a falsehood. Whatever of viciousness may attach to expert evidence is the fault of the system rather than of the witness. We all admit that it would be far better for the court to employ the expert, and not the plaintiff or defendant. But until that change has been made, the chemist is undoubtedly right in making out the best case possible for his client, provided he distorts no facts.

How far he can go with patent medicines, nostrums and secret preparations is another story. The dignity of our profession forbids any taint of humbug or quackery. This field, therefore, seems to be absolutely closed for professional purposes.

I would not have our Society become a trades union, and especially would I be sorry to see it exercise the tyranny which such unions often manifest, but I would like to see a better understanding established in matters of this kind, both for the sake of our members and for the benefit of the public at large.

The dignity of the profession of chemistry is illustrated in a striking way by the active participation which it exercises in many of the greater walks of life. I have not time

here to go into statistics and show the relative number of chemists employed in the industries as compared with members of other scientific professions. We will admit without such an array of figures that there is no other scientific profession, with the possible exception of physics, which begins to be so numerously represented in the great industries as the science of chemistry, and even in the case of physics, aside from the electrical industries and those of a purely engineering character, the physicists engaged in the active industries are not numerous.

When it comes to mining engineering, we find that the engineer himself must be a chemist in order to be fully able to discharge the duties of his profession. In so far as statistics are concerned, I will content myself with a few citations showing the preponderance of chemical employees in the great scientific agricultural industries of our country.

In a study of the impress which chemical research has made upon agriculture, there has been no factor during the past twenty years which can compare with the work of the agricultural experiment stations of the United States. Richly endowed as they are by the General Government, they have had every opportunity to secure the best results for practical agriculture.

In this work chemical science has played a very important part in the furthering of agricultural prosperity. Of the forty-nine directors of the stations at the present time twenty were professional chemists at the time of their appointment. The selection of so many professional chemists was no mere chance, but evidently had some relation to the dominant position which the science of chemistry holds to the promotion of agricultural chemical research. The list of directors of the agricultural experiment stations of Germany shows the same condition of affairs.

The great influence of chemistry on the agricultural experiment stations of this country is not measured alone by the number of professional chemists which is found in the directorates, but also by a comparison of this number with that of other scientific men holding similar positions. Very few of the other sciences are represented among the directors of stations, and no one of them can compare in its number of representatives to the science of chemistry. Among the working forces of the stations chemists also predominate. There are twice as many chemists employed in the stations as there are men engaged in any other professional scientific work. Statistics show that the number of chemists employed in the agricultural experiment stations of the United States is one hundred and fifty-seven, while the number of botanists is fifty and the number of entomologists forty-two. The number of employees belonging to other branches of science is very much less than that of the botanists and entomologists, and the total number of scientific men employed in all other branches of scientific work in the station does not greatly exceed, even if it be equal to, the number of those employed in chemical research alone.

While dwelling upon the predominance of professional chemists in the directorates and upon the staffs of the experiment stations, it seems eminently proper to mention here in a special manner some of the earlier eminent chemists who have contributed so much to the value of chemical research in our agricultural colleges and experiment stations. Among these must be mentioned Professor F. H. Storer, of the Bussey Institute (Massachusetts), who first began the regular publication of a bulletin recording the work of the school and station, which has 'set the step to which the bulletins from many other stations are still marching.' The bulletins of the Bussey Institute describing original research work on agricul-

tural subjects have proved of the highest benefit to agriculture. Professor Storer's work, entitled 'Chemistry in some of its Relations to Agriculture,' the first edition of which was published in 1887, has had a marked effect upon agriculture in this country.

As early as 1846 Yale University, then called Yale College, appointed a professor of agricultural chemistry. This was John Pitkin Norton, who had devoted himself to the study of scientific agriculture both in this country and in Europe, especially with the celebrated Liebig. He brought to his position a ripe knowledge and wisely directed enthusiasm for agriculture, which he used with the greatest profit in its service. In 1855 Samuel William Johnson was appointed instructor in agricultural and analytical chemistry, and soon after full professor. Perhaps no one ever succeeded more fully in popularizing scientific agriculture than Professor Johnson. His two books, 'How Plants Feed' and 'How Plants Grow,' the first editions of which were published in 1868 and 1870, respectively, have been kept abreast of modern progress in successive editions, and are still used as standard text-books and as authorities on the practical relation of chemistry to agriculture.

In the University of California, the work of Professor E. W. Hilgard must be mentioned as being of fundamental importance in the development of the relation of chemistry to agriculture in this country. Professor Hilgard, in his classical work on soils, has placed himself in the front rank of investigators on this subject, not only in this country, but in the world, and his achievements have been recognized both by his countrymen and by the most celebrated societies of Europe. A knowledge of the soil and its relation to plant growth constitutes one of the fundamental principles of agriculture chemistry, and the researches

of Professor Hilgard in this line have done much to place agriculture in the United States on a strictly scientific basis.

At Cornell, even before her doors were open to students, a professorship in agricultural chemistry was established. Professor G. C. Caldwell was appointed to fill this position, and he has done so with distinction to himself and to the University and with the greatest benefit to agriculture. One of the most important services in connection with Professor Caldwell's labors at Cornell was the publication of his work on agricultural chemical analysis in 1869. At that time no work of a similar nature existed in the English language, and Professor Caldwell's book was a veritable boon to students in agricultural science.

This brief reference to the contributions of some of the earlier workers in agricultural chemical science in this country would not be complete without mention of the labors of Professor C. A. Goessmann, of the Massachusetts Agricultural College.

It is not possible in the space assigned to this address to even name the more prominent later workers.

A national epoch in agricultural education in this country began with the passage of the Morrill Act, in 1862, establishing and endowing colleges where agriculture should be one of the principal branches in which instruction is given. An additional impetus was given to this great work in 1887 by the passage of the Hatch Act, establishing agricultural experiment stations in the several States. The organization list of the agricultural colleges of the United States now shows the great number of men working in lines of agricultural chemistry. This most remarkable evolution of agricultural education has taken place practically within the last thirty years, and there is no country which can now be compared with the United States in the munificence of the endowment for agri-

cultural chemical research or in the vast amount of research and experimental work conducted in these lines.

Another way in which our profession has influenced higher education in this country is found in the large number of chemists who have been called to preside over our higher institutions of learning. Of the leading institutions in this country, Harvard University, Lehigh University, the University of North Carolina, the University of Tennessee and Purdue University are presided over by professional chemists, or rather, I should say, by those who before elevation to the presidential rank were professional chemists. I doubt if any other branch of science can show so many college and university presidents as our own. It is certainly not a mere accident that in the breaking away from the old scholastic habit of placing ministers of the gospel over institutions of learning, chemistry has received so marked a favor. In fact, the pursuits of chemical science, it seems to me, tend more than other scientific occupations to broaden the mind and to bring it in contact with all the varied industries and forces of active life. It is true that other branches of science have their economic aspects, and we do not by any means desire to minimize that important relation, but they do not come so generally into contact with human affairs. While they appeal in the nature of their services more to the public imagination, when it comes to real practice they do not have that influence which our own science possesses.

I am far from saying that the pursuit of chemical studies tends, in any peculiar way, to develop administrative ability, and hence it cannot be in this collateral way that so many of our brethren have reached these higher places of administrative effort.

While we do not claim that chemical science holds in any way the same dominant

position in didactics that it does in agriculture, we do find, even in the smaller institutions of higher learning, that, as a rule, chemical science is taught more thoroughly and more effectively than other branches. The consideration of these facts, if prominently brought before the attention of the public, would certainly do much to increase the estimation in which our profession is held.

The above only illustrates in one industry the dominant influence of chemical research, and in so far as science comes into direct contact with the industries of the world it is evident that in almost every one chemistry occupies the predominant position. This well-recognized fact is a firm basis for the substantial claims of the dignity of our profession.

There is one point, however, in which it seems to me we are much at fault, and that is in the fact that the chemists of this country seem to have taken but little interest in the science of civics. We are too prone to regard politics as a profession beneath the dignity of a scientific man, and yet we must admit that the organization of the body politic for the public good is the highest work to which a man can devote himself. In other words, real politics is the most useful and most honorable of professions. The trouble here in this country is that politics becomes too much of a profession. In other words, it becomes a source of revenue or of sole revenue. How much better it would be if men who have reached success and competence in other professions, without abandoning these in their maturer years, would devote a portion of their time to the public good. In Europe this is commonly the case and we are all familiar with the names of eminent scientific men who have become celebrated also as leaders in political life. In Germany, we recall the name of Virchow, who, for more than thirty years, has been a member

of the National Legislature, and of Mommsen, the great historian, who has taken an active part in politics. In Italy, one of the honorary members of our society, Cannizzaro, is a senator and vice-president of that body. In France Berthelot is a life senator and has been minister of foreign affairs. In England, Roscoe has been a member of Parliament and Faraday and Humphry Davy and other scientific men were active in public affairs. In our country, I believe, only one member of the Chemical Society has ever become a member of the National Legislature and this was due to a fortuitous combination of most incompatible elements, namely, a union of democracy and prohibition.

I think we should all strive to discourage this sentiment, which is so prevalent, that politics is a dirty pool and that men of science should keep out of it. When you have reached competence and distinction in your profession what better service to which to apply your leisure hours than the study of the public weal? There are so many ways in which science can be utilized in political and civic affairs. The conservation of the public health, the prevention of epidemics and contagious diseases, the control of the water supply of cities, the disposal of the refuse of cities, the study of dangerous and fraudulent counterfeits of foods, are all matters affecting directly the public health and the public welfare. To become interested in these matters would be to more actively participate in public affairs, and it seems to me it is an ambition which every scientific man might well entertain, not only to become eminent in his profession, but also to devote a portion of his more mature life to the study of the public welfare and the active participation in those political relations of life which will enable him to become more useful to humanity.

May we not then expect to see the day

when our State and National Legislatures shall not be considered as properly organized until they have among them members representative of the great body of American chemists?

On April 12, 1976, will be celebrated the centenary of our society and shortly thereafter the bicentennial of our national independence. May I drop for a moment the rôle of chemist and assume that of prophet? Our country will have then about 225,000,000 inhabitants. Our foreign export trade will amount to more than \$500,000,000 annually. The revenues and expenditures of our Government will each reach the annual sum of \$4,000,000,000.

The average yield of wheat in the United States will be nearly 25 bushels per acre, and the average yield of other field crops be proportionately greater than now.

Diversified manufacturing industries will flourish in every part of the country, thus distributing population and encouraging agriculture. The product of a day's labor will be double that of to-day, thanks to new processes, improved machinery and greater skill. The condition of the artisan and the laborer will be greatly ameliorated, and the principles of the trust, which now help chiefly the capitalist, will be extended to include the working man as well. The laborer will not only have a larger daily wage, but will also share in the legitimate profits of the business.

The advancement of chemical science will not only make the fields more productive and more easily tilled, but will also teach how their products can be more economically and easily consumed. Good roads will lead everywhere and the horse be relegated to the museum and the stable of the sportsman. New sources of energy will take the place of coal and gas, and this energy will come from the winds and the rains. The sun directly and indirectly will monopolize the power of the country, working

through evaporation and precipitation and by means of electricity or some more useful force.

By a general comprehension of the principles of nutrition, food will be more wholesome and more potent. The general acceptance of the principles of hygiene will make the average life of man longer and his usefulness more fruitful. Man will not only live longer, but he will be happier and practically free from the threats of enzymic, contagious and epidemic diseases. When this Society meets on that founders' day, the membership will be nearly 10,000 and its organization will reach to all quarters of our imperial country. The number of those who to-day are members and who shall live to 1976 is not large, possibly *nil*, but many who are infants to-day will be the revered old men on that centennial occasion. The orator who will address you on that day is perhaps not yet born. I hope he will take for his theme, the 'relation of chemical work to the advancement of mankind in the past century.' He will find in the development of some of the thoughts which I have tried to bring to your attention to-night the most potent causes that make for the good of man. In such a light as he can shed on life and its conditions the coming man will be able to see the true dignity of chemistry. H. W. WILEY.

U. S. DEPARTMENT OF AGRICULTURE.

#### DIAMOND-GLASS FLUORESCENCE.

SOME five years ago I had occasion to cut a large number of photographic dry plates to smaller sizes. They were cut in the usual way—with a diamond and on the side of the plate opposite the film. In developing it was noticed that the film, to a breadth of a few millimeters along the edge of the plate, turned dark as if exposed to light.

Several possible explanations suggested themselves.

1. The breaking of the glass might produce momentary fluorescence and a fogging of the film near the break.

2. The breaking or tearing of the film might result in some sort of change in its character.

3. The scratching of the diamond might set up mechanical disturbances or vibrations in the glass and these might affect the film.

4. The friction between the diamond and the glass might cause a momentary fluorescence along the line traced by the diamond, and the radiation might penetrate the glass and fog the film on the other side.

The first and second suggested explanations were thrown aside at once, for the dark band in the film was found along the diamond scratch, whether the plate was broken or not.

That the third is not the true explanation was shown in several ways. The breadth and density of the dark band did not appear to depend upon the depth of the cut or the rapidity with which it was made. The line was always of about the same breadth on the same plate, but of different breadths on different plates. Moreover, the film always developed first on the side next the glass. The effect was noticeable on the most sensitive plates only.

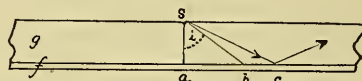

fig 1.

Let  $f$  represent the film on a section of the glass plate  $g$ , perpendicular to the diamond scratch  $s$ . Let  $s$  be a source of radiation.

All rays (as  $sc$ ) outside the critical angle  $i$  are totally reflected and hence do not affect the film. Those having an incident angle smaller than  $i$  penetrate the film and

fog it, if they are of sufficient intensity. The breadth of the fogged line is

$$b = 2a \overline{b} = 2t \cdot \tan i$$

where  $t$  is the thickness of the glass plate and  $i$  is the critical angle for glass and the film substance. Using plates of different thicknesses, it was found that, in every instance,  $b$  varied as  $t$  to the degree of accuracy with which the measurements could be made. When a clear glass plate was laid on the dry plate, scratching the upper plate gave a band whose width varied as the combined thickness of both plates. If, however, the dry plate were turned over so as to have the film between the plates, the breadth of the band varied as the thickness of the upper plate. And in this case when the plate was placed in the developer, the band appeared first on the outer or upper side of the film.

It was found that fluorescence does not always occur when a diamond is drawn over a dry plate. Different diamonds and different brands of plates (glass) gave different results. To determine the cause of this apparent irregularity I made a series of observations, using ten different diamonds and nine kinds of plates. Seven of the diamonds were ordinary glass cutters, rang-

cutter No. 7. Nos. 8, 9, and 10 were Brazilian black diamonds (in emery wheel cutters) known as carbonadoes. They appeared to be amorphous.

Ordinary plates, even the most sensitive, were not very sensitive to this fluorescence. Cramer, Stanley, Seed, Carbutt and Hammer plates were tried. Sometimes the diamond produced a slight fogging; usually it did not. In this respect no constant difference was noted in the different brands of plates.

To determine whether the quality or nature of glass influences fluorescence I asked the M. A. Seed Dry Plate Co. to supply me with plates of different kinds of glass coated with the same emulsion. The Company informed me that they were using four brands of glass, English, French, white crystal and American, and they sent me a supply of each kind coated with their most sensitive orthochromatic emulsion.

Their orthochromatic plate (No. 27) was found to be much more sensitive to diamond-glass fluorescence than the most sensitive ordinary plate. Fogging almost always occurred along the diamond trace, and the dark band was frequently very dense.

The following table embodies the results of the tests of different glass with different diamonds:

TABLE I.

Diamond.	Seed's orthochromatic plates, No. 27.						Seed's ordinary "Gilt Edge."	Total.			
	English glass.		American.		French.				White Crystal.		
1. Small	trace	1	weak	2	trace	1	weak	2	absent	0	6
2. "	strong	4	absent	0	absent	0	weak	2	absent	0	6
3. "	strong	4	weak	2	trace	1	fairly strong	3	trace	1	11
4. Medium	strong	4	fairly strong	3	weak	2	fairly strong	3	weak	2	14
5. "	trace	1	trace	1	absent	0	weak	2	absent	0	4
6. "	trace	1	absent	0	absent	0	trace	1	absent	0	2
7. Large	trace	1	trace	1	absent	0	absent	0	absent	0	2
8. Carbonado	absent	0	absent	0	absent	0	absent	0	absent	0	0
9. "	absent	0	absent	0	absent	0	absent	0	absent	0	0
10. "	absent	0	absent	0	absent	0	absent	0	absent	0	0
Total	16		9		4		13		3		

ing in size from a very small stone in No. 1 (see table) to a large stone in plate glass

Representing by numbers the relative intensities of the fogged bands, any total in

the last column is obtained by adding the intensities for the five kinds of plates and a single diamond. Similarly the last row represents the intensities corresponding to all the diamonds and one kind of glass. The table shows that the fluorescence depends upon the kind of glass, and also upon the particular diamond used. One would expect the former, and one might not be surprised that the black amorphous diamonds do not act as do the clear crystalline stones. But that the latter differ among themselves is strange. It was thought that the difference might be due to differences in shape and the character of the scratch. This conclusion was rejected when it was found that diamond No. 4 would always fog the plate, even when the surface of the plate was not scratched at all. When the diamond was held out of cutting position and drawn across a plate, a dark band appeared on development. Diamonds Nos. 5 and 6 could scarcely be made to fog a plate, however they were held.

That friction has much to do with fluorescence was shown by the fact that sometimes a dark band would be discontinuous in two or three places along a diamond scratch.

The band produced by No. 4 was so strong that it was thought the fluorescent light might be visible. This proved to be true. When the eye was rendered very sensitive by being in absolute darkness for an hour, the conclusions drawn from the table were verified directly. The fluorescence from No. 4 was very marked, especially when English or white crystal glass was used. No visible fluorescence could be obtained with any of the black diamonds.

To test the equation  $b=2t \cdot \tan i$  a dry plate was laid on a table, film upward. A plate of clear glass was then laid on the dry plate and a diamond was drawn across the clear plate. The mean of several measurements of  $b$  and  $t$  gave a critical angle of

about  $39^\circ$ . For the particular plate used, this was approximately the critical angle for yellow light, showing that, whatever other wave-lengths might be present the longest waves that affected the film were those of yellow light. This conclusion was strengthened by the fact that, to the eye, the light appeared to be a greenish yellow, and that orthochromatic plates were much more sensitive to it than ordinary plates.

Measurements of  $b$  and  $t$  for plates of various thicknesses gave values of  $i$  ranging from  $38.6^\circ$  to  $40.4^\circ$ . It would seem that the fogged band should be much broader when the dry plate itself is scratched, for then the critical angle is determined by the ratio of the indices of refraction of gelatine and glass. Measurements did not confirm this point, though they showed a constant ratio between  $b$  and  $t$ .

ARTHUR L. FOLEY.

PHYSICAL LABORATORY,  
INDIANA UNIVERSITY.

---

HOW BOTANY IS STUDIED AND TAUGHT IN  
JAPAN.\*

MODERN botany was practically introduced into Japan twenty-four years ago by the late Professor Yatabe,† who studied botany at Cornell University, graduating in 1876. He became the first professor of botany at the Imperial University of Tokyo. Before him there were several botanists in Japan who studied the native plants quite thoroughly. But most of them being amateurs, did not know much about modern botany. Some of these old botanists still live. The well-known Dr. Keiské Ito, who was the Director of the Botanical Garden of the University before Professor Ya-

\* A paper presented at one of the Botanical Seminars, Cornell University, November, 1900.

† Professor Yatabe was drowned in the sea at Kamakura not far from Tokyo in August, 1899.



tate, still lives, being in his ninety-eighth year.\*

A short sketch of his life, with a portrait, by his grandson Dr. Tokutaro Ito appeared in a late number of *Annals of Botany*. †

Professor Yatabe paid especial attention to systematic botany. Soon after his return from America he began to make a large and extended collection of the native plants, making long expeditions, especially in the summer vacation. It is to his arduous labors in collecting that the larger part of the herbarium of the Imperial University is due. He found and described many plants new to science. But his contributions are rather local and quite hidden from the general notice of many botanists. It is indeed only during the last few years that Japanese botanists have begun to contribute more or less to the general progress of the science.

I will now relate how botany is taught in the Imperial University of Tokyo. Before doing so, it is necessary to say how one must prepare before entering the University. A child goes to the common school at the age of six and remains there for from six to eight years before entering the high school. In the high school, English, mathematics, history, geography, physiography, physics, chemistry, zoology, botany, physiology, mineralogy, together with some Japanese and Chinese literature, are taught. This takes five years. English is the only foreign language taught in the Japanese high schools, except in one school in Tokyo where German is studied instead of English. This is the preparatory school for the medical department of the University.

If one wishes to enter the University one must spend three years after graduating from the high school in the higher high school (Kōtō gakkō). In the higher high school three different courses are given.

\*Since this paper was read Dr. K. Ito has died (Jan. 24, 1901).

† Vol. XIV., No. 55, Sept., 1900.

The first course is required for the students of law and literature; the second is required for the students of science, engineering and agriculture, and the third for the medical students. The students of medicine are separately educated, as it is necessary for them to be thoroughly acquainted with German. In these three courses further subdivisions are made, according to the speciality of the student. If he is a student of botany, he is required to take the second course and to study botany, zoology, physics, chemistry, geology, mathematics, English, German, sometimes French or a little Latin, besides some Japanese and Chinese literature. After graduating from the higher high school he is admitted to the University without examination.

There are now two imperial universities in Japan, one in Tokyo and the other in Kyoto, the old capital of Japan. The latter was founded only three years ago and contains now the Colleges of Science, Engineering, Medicine and Law. No botanical department is yet established.

The Imperial University of Tokyo is divided into six colleges or departments: the Colleges of Science, Law, Literature, Medicine, Engineering and Agriculture, the last including Forestry and Veterinary Medicine. The College of Science is further divided into seven departments. These are physics, chemistry, mathematics, astronomy, zoology, botany and geology. All the courses of the University are required except a very few elective ones. Usually it takes three years to graduate, but in the departments of Law and Medicine four years are required.

The students of botany are required to study zoology, including histology and embryology, geology, paleontology, mineralogy, physiology, physiological chemistry and bacteriology, besides botany. In the first year they have three lectures a week on general botany (morphology and physi-

ology) besides three laboratory hours. The laboratory work begins in identifying the various common plants, making drawings of each. In this work Gray's 'Manual', or 'School and Field Botany,' is often used, as we have no complete manual of Japanese botany. Next comes the gross and minute anatomy from the lower to the higher plants. Especial attention is paid to the various kinds of tissues, often referring to the comparative anatomy and development, together with some microchemical reactions of more common cell-contents. In the third term especial attention is paid to fertilization, embryology and development. The fern and *equisetum* are studied from the germination of the spore to the formation of sexual organs on the prothallia. The fertilization of pine and *gingko* affords good objects for study. Cell-divisions are often studied with the root-tip of beans, pollen mother cells of *Tradescantia*, lilies, etc.

In the second year three lectures on systematic botany are given weekly and three laboratory hours are devoted to plant physiology throughout the year. Various experiments on carbon assimilation, respiration, transpiration, geotropism, heliotropism, rheotropism, hydrotropism, etc., are made. Growth is observed with various auxanometers and horizontal microscopes. Thin micro-chemical studies of various important cell-contents, including the inorganic salts are made. Their distribution and the transformation within the plant bodies are then studied. Artificial pure cultures of various algæ, fungi, bacteria and yeast are made, paying special attention to the nutritive value of various organic and inorganic compounds. Water cultures of the higher plants are also made. Chemotropism of the pollen tube, fungal hyphæ and chemotaxis of bacteria are carefully studied. Regeneration of the liverwort thallus and the dandelion root, nodal growth of Gramineæ are the other objects of study. *Trades-*

*cantia* cell with its red-colored sap affords excellent material for studying the osmotic pressure in the cell. Isotonic coefficient of various organic and inorganic substances are determined according to the method of de Vries. In the third term, sometimes a special subject of study, being either original or a repetition of the previous work, is given to each student.

In the third year the only required studies are: one hour's lecture weekly on plant physiology during the first term, and one lecture and two laboratories on bacteriology during the second term. The rest of the time is spent in the work of graduate theses. Subjects of theses are mostly physiological or anatomical. Following are the subjects of theses presented to the University by the graduates in botany in the last three years:

1898.

T. Inui. 'Anatomy and physiology of the gum-resin duct of lac-tree and the other species of *Rhus*.' (English.)

1899.

K. Shibata. 'Contribution to the physiology and anatomy of bamboo.' (German.)

N. Ōno. 'On the acceleration of growth in some algæ and fungi by chemical stimuli.' (German.)

H. Hattori. 'Studies on the action of copper sulphate upon plants.' (German.)

S. Kusano. 'On the transpiration of evergreen trees during winter in middle Japan.' (English.)

K. Miyaké. 'On the carbon assimilation of evergreen leaves in Tokyo and other parts of Japan during winter.' (English.)

1900.

K. Saitō. 'Anatomical studies of Japanese fiber plants.' (German.)

Y. Yabé. 'A revision of the Umbelliferae of Japan.' (Latin.)

The chief results of the above-mentioned

theses, except that of Mr. Yabé, are already reported in the *Botanisches Centralblatt*,\* by Professor Miyoshi. Some of them have already been published, and the rest will be published soon.

In the graduate course no lectures are given. By presenting a thesis which represents five years' study after graduation the degree of 'Rigaku hakushi' (Doctor of Science) is given. Of these five years the first two must be spent at the University. There are now seven students in the graduate course of botany, one of them studying outside of the University. Their subjects of study are mostly in the lines of plant physiology and physiological anatomy.

At present there are two professors and three assistants in the Botanical Department. Professor Matsumura, who is the head of the department and the director of the Botanical Garden, has charge of systematic botany. He studied in Germany under the late Professor Sachs, in Würzburg, and Professor Pfitzer, in Heidelberg. Professor Miyoshi is the professor of plant physiology. He graduated from the Imperial University and afterward studied in Professor Pfeffer's laboratory at Leipzig for three years. He is the well-known worker on the chemotropism of fungi.

Professor Matsumura is now studying the flora of the islands of Formosa. The results of his study have been partly published. Professor Miyoshi is engaged in investigating the coloring matter of flowers, besides other physiological studies. Mr. Fanjii, the assistant, who has occupied this position for several years after graduating from the University, is making researches along morphological and ecological lines. Mr. Makino, an assistant, is now studying the difficult group of bamboo, besides his systematic researches on Japanese phanerogams and ferns.

\* *Botanisches Centralblatt*, Bd. 80, No. 5, 1899, and Bd. 83, No. 11, 1900.

The Botanical Laboratory is situated in the Botanical Garden. The Botanical Garden is more than two hundred years old. The garden was used primarily for medicinal plants, but now it has many kinds of Japanese and foreign plants. There is also a large green-house. The herbarium of the Botanical Laboratory contains nearly all the Japanese plants, including tropical plants from the islands of Loochoo and Formosa, besides some exotic plants. The cryptogamic herbarium is not yet completed, as many of the lower forms are not well studied. The library of the laboratory contains the leading German, French, English and Italian journals. Zeiss microscopes are commonly used in the laboratory.

There is another botanical laboratory in the College of Agriculture. Professor Shirai has charge of plant pathology and dendrology. He is especially interested in fungi and the plant diseases. He is now studying in Berlin. Professor Ikeno, the well-known investigator of *Cyces*, is giving the lectures on plant morphology and physiology. He is engaged on investigations in histology and cytology. The leading English, German and French botanical journals are also found in this laboratory.

The botany in the higher high school in Tokyo is taught by Dr. Goto, who is a zoologist. In the Higher Normal School of Tokyo, Professor Okubo has charge of the Botanical Laboratory. Professor Miyoshi, of the Imperial University, is now giving the lectures on plant physiology during the absence of Dr. Saida, who is in Germany.

In the Agricultural Experiment Station of Tokyo there are several botanists. Mr. Hori, the chief botanist, has charge of vegetable pathology. Various kinds of plant diseases are constantly studied here. The disease of the mulberry tree, the leaves of which furnish the food for the silkworm, were the special subject of investigation during the last few years by a special com-

mittee. The cause of the disease is found to be physiological, not caused by any organism, as it was thought before. A remedy for the disease is still being investigated.

There are several botanists in Tokyo outside of the above-mentioned institutions. Dr. Okamura, who is the lecturer of the Fishery Institute of the Government, is making continued studies on the marine algae of the Japanese seas. He has just issued the first fasciculus of his 'Algæ Japonicæ Exsiccatae,' which contains fifty species. Dr. T. Itō, who studied botany at the University of Cambridge some fifteen years ago, is making extensive systematic studies on the flora of Loochoo islands. A part of the work was published in a late number of the Journal of the College of Science, Imperial University of Tokyo.

The works of the Japanese botanists are often published in the Journal of the College of Science, Imperial University of Tokyo, as well as in the leading foreign journals. The shorter papers appear in the *Botanical Magazine*. The magazine is published monthly, partly in Japanese and partly in the European languages. It is the organ of the Tokyo Botanical Society. The Society has about three hundred members, living in various parts of Japan. Among them we find many high and common school teachers. There are two series of small pamphlets published monthly with figures and descriptions of Japanese plants. One contains figures, with brief descriptions and remarks of the flowering plants and ferns of Japan. The other contains those of the lower cryptogams. The illustrations and descriptions in the former are made by Mr. Makino. The latter is contributed to by many Japanese botanists and edited by Professors Matsumura and Miyoshi.

A still larger work on Japanese botany has just begun to be published. This is the 'Icones Floræ Japonicæ,' a large-sized

pamphlet with minute and careful drawings and descriptions of Japanese plants, compiled by the Botanical Department of the University. Volume I., Part 1, has lately been published. Mr. Makino is now engaged on the work. All the drawings and descriptions are made by his own hand.

In closing I must not neglect to make a brief statement of the Botanical Laboratory in the Agricultural College of Sapporo far north in 'Hokkaido,' the Yezo Island. The director of the Botanical Laboratory and the Botanical Garden is Professor Miyabé. He studied at Harvard University some ten years ago. The herbarium of the Laboratory has a complete set of the plants of the Yezo Island, besides other Japanese and foreign plants. Professor Miyabé is interested in fungi and plant diseases. Several works in this line have been done both by him and by his students. Professor Miyabé also studied the Laminariaceæ of the northern seas. Two new genera have been established by him in this single family.

Japan is a long country, though narrow, extending from 51° north to the tropics. The variety and richness of the flora are incomparable. Though the phanerogams and the ferns of the empire are pretty well known, many lower cryptogams have not been thoroughly investigated.

KRICHI MIYAKÉ.

BOTANICAL DEPARTMENT,  
CORNELL UNIVERSITY.

#### SCIENTIFIC BOOKS.

*Reservoirs for Irrigation, Water Power, and Domestic Water Supply.* By JAMES DIX SCHUYLER, M. Am. Soc. C. E., etc., etc. New York, John Wiley and Sons, 1901. \$5. Pp. xvi + 414. 174 figs., with maps and appendix.

The subject of reclaiming by irrigation the extensive arid tracts of western North America is pressed upon the attention of the general public, and also upon that of the engineering and financial world, with increasing emphasis from year to year. Private capital is urged to

provide reservoirs and irrigation works and has already done so to some extent, and the question of aid from the national government in extending the work is under debate. Much light is shed upon what has already been done in this direction, as well as upon what is proposed and is under way, by Mr. Schuyler's interesting book, which embodies the material used in his reports to the U. S. Geological Survey in 1896 and much additional matter of more recent date.

The book is unquestionably a valuable one for civil engineers, giving, as it does, a description of the principal dams built, and now projected, in the western portion of the United States; and also some account of large dams in foreign countries, already completed or in progress, such as those at Assuan and Assiout in Egypt; giving also (to quote from the title page), "A discussion of the available water supply for irrigation in various sections in arid America; the distribution, application, and use of water; the rain-fall and run-off; the evaporation from reservoirs; the effect of silt upon reservoirs," etc. In some cases details are presented in great fullness; and illustrations, views, profiles, maps and plans occur in profusion throughout the work, thus greatly enhancing its value. As an instance in point, it may be noted that in the description of the Sweetwater dam, in southern California, built after the design, and under the superintendence, of Mr. Schuyler himself, there are fourteen distinct illustrations (views at different stages of construction, sections, maps, etc.), the description itself occupying seventeen pages.

This same dam offers a striking instance of the benefits obtained by the erection of such a structure. During the thirteen irrigation seasons up to 1900 'the impounded water has created values aggregating several millions of dollars, reckoning all improvements made in the district directly dependent on it for water supply.' Domestic water supply is also furnished to a population of from 2,500 to 3,000 people. The cost of the dam was \$234,000 and the area at present irrigated from it is 4,580 acres.

The dams described are classified according to their mode of construction and may be briefly referred to as follows:

'Rock-fill' dams are composed of stones deposited loosely together in a trapezoidal form, water-tightness being provided by a sheathing of plank on the upper side, or by an earth facing. This plan originated some fifty years ago in the mining regions of California, when the transportation of cement into remote districts was very expensive, or impracticable. Later construction employed a concrete 'skin' on the upper side; or a central and vertical steel plate, covered on both sides with hot asphalt and burlap, and then imbedded in a wall of concrete. Sometimes the steel plates formed a facing on the upper side.

The 'hydraulic-fill' dams were composed of earth and gravel deposited by 'sluicing' the material into position; that is, by washing down the soil by jets of water from higher elevations in sluices or pipes into the desired position. In this way, by proper management, the finer soil could be made to occupy the center of the dam or embankment, while the coarser gravel and stones formed the outer portions; and extreme cheapness of construction was often attained. Thus, the Tyler dam, in Texas, 575 ft. long and 32 ft. high, cost only \$1,140; including the expense of pumping water to form jets for loosening and sluicing the soil. As the water drains off gradually the gravel, sand and clay are more compacted, it is claimed, and hence a more water-tight dam obtained, than if the material had been laid dry and then tamped.

Naturally, the chapter on the masonry dam, as being the most durable and stable construction, occupies a greater space in the book than any other. Here the usual arguments are presented in favor of the gravity dam, as against the horizontal arch; though the curved form is advocated in certain cases for esthetic reasons, and as providing for remote contingencies. A full description is given of that 'eighth wonder of the world,' the noted Bear Valley dam, in California, which with its very slender dimensions depends for stability solely on its arched form; this form having been given to it to effect a saving in the cost of masonry, since the cost of hauling cement to the locality was at that time (1884) \$10 per barrel. The Sweetwater dam, already mentioned, belongs to this

class and was built in 1888. An interesting fact with regard to sedimentation in this reservoir is that during the twelve years of its use the bed of accumulated silt in the deepest part (some 90 ft.) was only 3 ft. in thickness. This is in great contrast with the rapid silting of Lake Macdonald, the reservoir created by the Austin dam of Texas, whose design and construction, and also final failure in April, 1900, are described by Mr. Schuyler.

Concrete dams are next taken up, including the structure of that type built for the Hydraulic Laboratory of Cornell University; in connection with which an account is given of the device adopted for 'concentrating the contraction due to temperature changes in the concrete to a central point of weakness.' The resulting fissure was filled up in cold weather and continuity thus secured.

In the chapter on earthen dams mention is made of the ancient 'tanks' or storage basins, of Ceylon, one of which was closed in by an embankment 11 miles in length and 200 feet high; also of several in India. The other earthen dams mentioned are in Colorado and California, one of them (5.5 miles in length) serving to close in the Buena Vista Lake Reservoir, which has great extent (25,000 acres) but is only about 7 feet deep. As a result of this, the annual loss of water by evaporation is estimated at 70 per cent. of its capacity. However, when the evaporation is most active, the loss is made good continuously by the influx from the river.

The Ash Fork steel dam in Arizona, described on p. 222, was erected in 1897 and is an unusual construction, consisting of a number of vertical steel frames or trusses, connected or 'bridged over' at the upper side by curved plates of steel which form a continuous and water-tight covering. The structure is 33 feet high, 184 ft. long, and cost \$45,000.

Natural reservoirs are next mentioned; *i. e.*, ready-made reservoirs or depressions, waiting only for water to be turned into them from neighboring streams of sufficient elevation and for suitable provision for its regulated escape.

The last chapter, on 'Projected Reservoirs,' is of considerable length and full of detail, treating of many irrigation surveys and projects

for impounding water, throughout the Western States and Territories. Several of the structures mentioned are already in process of construction. An appendix of various tables made for the U. S. Geological Survey, and contoured maps of reservoir systems, complete the work.

A very commendable feature of Mr. Schuyler's book, and one that will be appreciated by civil engineers, is the information given as to the *cost* of many of the dams and other structures described in the work.

I. P. CHURCH.

*Annual Reports of the War Department: Report of the Chief of Ordnance.* Washington, Govt. Print. 1900. 8vo. Pp. 474. Numerous appendices and plates.

The reports of the War Department always contain much of interest to the general reader and to the thoughtful citizen, apart from their purely technical matter, as, for example, the accounts of work performed under the River and Harbor Bill. Those of the Chief of Ordnance are particularly interesting to the student of metallurgy and to the engineer as giving much valuable information regarding materials. Occasionally a side-light is thrown upon interesting phases of governmental and official administration; as where the report of the chief of a bureau permits the reader to see the hand of the politician in the determination of the location of important locks, in river improvements in the West and the reason for the displacement of a worthy and capable officer insisting upon correct business methods, or where, as in the report before us, the official documents reveal the fact that a Committee of Congress, composed mainly if not entirely of non-experts, or amateurs at best, decides to 'try an experiment' with Government funds, to the extent of many thousands of dollars, directly against the expressed opinion of the official expert advisers of the Department and of Congress, or where official and expert authorities are permitted to be accused of refusing to permit the civilian expert reasonable opportunity to display his talent, and the charge is left without complete and decisive investigation and report. Amateurism is not altogether a monopoly with departments.

The Report of the Chief of Ordnance, proper, is a very brief, business-like and well-condensed summary of the operations of the bureau for the fiscal year ending June 30, 1900, covering 42 pages of the volume. The details of the work are exhibited in the remaining four hundred pages, in which are given forty appendices, mainly reports of officers charged by the Bureau with important duties and including the operations of the various arsenals.

Watervliet Arsenal, for example, has turned out during the year 45 ten- and twelve-inch rifles and mortars, and five smaller rapid-fire guns, and has made a large quantity of accessory material. Springfield Armory made about 60,000 army rifles and carbines and attained an output of 400 guns a day. Working eight hours a day, it now turns out about 200. As usual, a large amount of experimental work has been performed. Watertown Arsenal has been engaged upon sea-coast gun-carriages and its great testing-machines—it now has one of 200,000 pounds capacity, in addition to the older machine of 80,000 pounds—have performed a considerable amount of valuable scientific work in addition to that of the routine operation of the Department. Frankford Arsenal has made, during the year, 23,000,000 small-arm cartridges and can now issue about 90,000, per day of eight hours, continuously. Rock Island Arsenal turns out most of the infantry and cavalry equipments of the army. It makes blanket-bags at from \$1 upward, haversacks at from 85 cents, canteens at 32 to 38 cents and tin cups cost but 10 cents to make. Costs have come down and wages gone up with the use of improved machinery. A new small-arms factory is under construction here, to produce 200 to 250 guns a day. Heavy guns for fortifications have been so extensively supplied that the Department is now turning its attention to the smaller rapid-fire guns. A muzzle velocity of 3,000 feet per second is to be attained in the later construction.

Wire-wound guns continue a subject of experiment, but still without complete success. It has come to be a question whether the disappearing gun-carriage for heavy mounts is best practice and whether it has not been too exclusively adopted. The Bureau does not

express a decided opinion on this point. The automatically operating rapid-fire gun is reported upon and recently invented automatic pistols are the subject of investigation, with the result of choice of the Colt construction for army use, if later approved by the Department.

Interesting investigations of the composition of acceptable gun-steels give the valuable deduction that for an elastic limit of 70,000 to 75,000 pounds per square inch, and a tenacity of 100,000, with an elongation 15 to 20 per cent., the compositions should include about one-half of one per cent. carbon, one per cent. manganese, one-fifth to one-tenth per cent. silicon, and well under one-tenth of one per cent. of sulphur or phosphorus. Oil-tempering is not of advantage. Rolling is best performed at a temperature a little way below that of the blue 'critical heat.' One curiously interesting deduction is that the action of smokeless powder, or other high explosive, attaining a given pressure in the barrel of a gun, is less destructive than a similar pressure produced by ordinary static testing. The duration of the pressure is about 0.0004 second only, and time is thought to have an important influence upon results. The normal powder pressure in the army rifle is about 42,000 pounds per square inch. The singularly interesting phenomenon, extensively investigated by the writer many years ago, 'the exaltation of the normal elastic limit by strain,'\* finds application here, as in so many other matters of applied science; the practice being now established of rolling and forging parts at a minimum temperature to insure high elastic limits and maximum tenacity.

R. H. THURSTON.

*Experimental Psychology.* A Manual for Laboratory Practice. By EDWARD BRADFORD TITCHENER. Volume I. Qualitative Experiments; Part I. Student's Manual. Pp. 214. Part II. Instructor's Manual. Pp. 456. New York, The Macmillan Co. 1901.

The place of laboratory practice in the teaching of psychology has, in American universities at least, become assured. It is by no means

\* *Trans. A. S. C. E.*, 1873. 'Materials of Engineering,' Vol. II., Chap. X.; Vol. III., Chaps. XIII., XIV.—R. H. T.

settled in method, mode of instruction, arrangement of the work, or indeed of the principal aims to be accomplished. There has been too little time for any usage to become traditional or classic; and individual solutions of the important as well as of the incidental problems have been the unavoidable rule. Such usage is likely to become established through the influence of laboratory manuals more easily than through any other source. Sanford's manual is the pioneer in this field, and has been available in various stages of incompleteness for five years or more. Cattell maintained an attractive announcement in a publisher's list for some years; but this was withdrawn on the publication of Sanford's book. Scripture has published some helpful notes on the conduct of experimentation in the psychological laboratory; Höfler and Witasek have recently published a book of *Schulversuche*; and other sporadic contributions to special parts of this topic may be found by the industrious seeker. Professor Titchener's volumes form a weighty addition to this small group of pedagogical aids, and one certain at once to take high rank and to have an important part in the shaping of experimental usage in psychology.

The plan of the work covers two volumes; the first devoted to qualitative experiments, the second to quantitative experiments. These, again, will appear in two forms; the one for the students and the other for the use of the teacher. The present two volumes include the qualitative experiments for the student and for the instructor. It is, therefore, as yet premature to judge of the scope of the completed work; but the architectural principles upon which it is reared are sufficiently represented in this first portion to enable one to intelligently estimate the place which the whole is to occupy in the literature of psychology. The student's manual proceeds, after a brief introduction on the general arrangement of experimentation, to consider sensation (six chapters, including the five senses and organic sensation), the affective qualities, attention and action. Then follows a consideration of the rôle of perception, and the association of ideas—falling into chapters on visual space perception, auditory perception, tactual space perception, ideational

type and the association of ideas. This range of matter is grouped in thirty-seven experiments, many of them rather complex in character and involving a considerable number of separate observations. The experiments are clearly and suggestively elaborated, the instructions lucid, the emphasis laid on the interpretation of the results commendable. There are numerous illustrations, and the mechanical features of the volume leave nothing to be desired. The work represents the result of many years of experience of an experimental psychologist who emphasizes, as markedly as any of his colleagues, the importance of laboratory practice, and has evolved for his own use as comprehensive a system as is in vogue in any laboratory of psychology. The scholarly character of the result, the authoritativeness of the positions therein embodied, are unmistakable. Every director of a laboratory of psychology, small or large, will find much direct aid and more indirect suggestion in this newest manual.

The central question, upon which there is likely to be a marked difference of opinion, relates to the plan of the work and its adaptability to the several needs and facilities of the university and college courses in psychology. The division of the work into a qualitative and a quantitative part is evidently fundamental in the author's conception. Sanford's manual combines the two in a serial treatment of topics. How the two camps will divide it is not easy to foresee; for though we may hold that pedagogy is a science, it does not give unambiguous answers to such queries. The analogy to chemistry is at once suggested. But in chemistry there is in the main only a repetition of the one analysis with added mathematical factors; this seems hardly the case in psychology. The separation of the two in chemistry introduces no sense of incompleteness; and for introductory instruction, the one has a traditional and well-founded prestige. Neither fact is true of psychology. The practical question of economy of time and advantage in going over the ground once qualitatively and again quantitatively will deter many from introducing this practice even if they favor it upon logical grounds.

The present writer, after weighing the pros and cons both of a theoretical and of a practical



sort, must decide for his own part in favor of a topical treatment in which qualitative and quantitative analyses are conjointly used and regarded as methodical aids to the elucidation of principles and the determination of results. As in physiology we consider first the bony system, then the circulatory, then the nervous system, and so on and in the end and all the way through keep in mind the mutual interrelations of these systems, and introduce quantitative determinations so far as they aid the comprehension of the functions considered; so in psychology there is good ground for considering that the greatest pedagogical success and the clearest insight into the significance of mental phenomena will be reached by the pursuance of a similar method of exposition. For those of this opinion, it will still be possible to use the qualitative and quantitative parts together, though with some readjustment of method. Another marked characteristic of the manual is the selection of a relatively few groups of experiments and the careful elaboration of these. In this an exemplar may be found in the usage of many laboratories of physics. In the unsettled status of psychological practice this point is also likely to be favored by some and rejected by others. The principle involved is this: How far shall an experiment represent a verification by each individual of the essential facts of a given principle or trait of mental processes? or shall it be a miniature reestablishment of the method and the evidence which led to the formulation of that principle? Sanford adopts the former plan, Titchener the latter. Again, both practical and theoretical considerations will affect one's decision; that the former practice is the more readily assimilated to the ordinary practice courses of our universities admits of little doubt. These, then, are some of the differences of route which the psychological tourist will encounter; and he must choose his own guide and take the benefits and losses that result from his choice. Which is the easier road to travel, which affords the better outlook, experience alone will decide. It is fortunate that our psychological guides, in this case, are animated by the best of motives and equipped with admirable training for their tasks.

Both Sanford's and Titchener's manuals are adapted to the student with a marked and well-grounded interest in the work. They are manuals for 'long course' specialized students. There is still an urgent need for a more elementary manual that will cover a small number of carefully selected experiments in a way suited to the 'short course' students. Such seems to have been promised by the announcement which Cattell withdrew, and is in a measure accomplished by the German manual above referred to, and may be approximated by a judicious selection and reconstruction of Sanford's experiments. While welcoming a new and important aid to the teaching of experimental psychology, this need, that is still to be satisfied, may be appropriately noted.

The instructor's manual is a complete innovation in the literature of psychology, and one to be highly valued. It is to be understood that this is an entirely different book from the other, though necessarily following the same order of experiments and the same unfolding of topics. Yet the text is addressed to the director of the experiments; he is given a complete account of the sources of error, and the precautions to be followed in the conduct of the experiment, is referred to the appropriate literature, and to more exact apparatus and observations not suited to student use. This, indeed, is in many ways the most valuable portion of the work. It makes possible for the first time the systematic training of the assistant by the director of the laboratory, and gives the special student in experimental psychology a reliable and methodical guide to the problems with which he is in the main to be concerned. The use of this manual as a basis of a special course for advanced students, in training to become professional psychologists, is one of its possibilities apart from its primary function. Professor Titchener has here placed at the disposal of his colleagues the result of years of very special and successful devotion to the problems of psychology susceptible to treatment by the experimental methods, and for this service so admirably accomplished he is entitled to the honors and privileges attaining to the distinction of carrying through so difficult and important a piece of pioneer work.

It is in the instructor's manual, likewise, that the spirit of the author's laboratory methods comes more clearly to the foreground. The presentation is more intimate, the descriptions more comprehensive, and the insight into the training which the course is intended to give more manifest. The genial set of instructions headed 'How to Fail in Laboratory Work,' might serve a good purpose if prominently exhibited in the laboratory. But the main point to be noted is the thorough appreciation of the fact that the psychological experiment carries with it its own conditions and peculiarities; that in becoming a 'subject' the individual retains all his peculiarities; and that these must be dealt with by tact and resource. The difference between good and bad observation upon mental matters depends upon this, almost equally with the acquaintance with method and technique. Both for the method and the matter, these volumes and the two to follow must be valued as amongst the most important of recent contributions to the furtherance of the aims of experimental psychology.

JOSEPH JASTROW.

*Peach Leaf Curl: Its Nature and Treatment.* By NEWTON B. PIERCE, in charge Pacific Coast Laboratory, Santa Anna, California. Bulletin No. 20, Division of Vegetable Physiology and Pathology, U. S. Department of Agriculture. Washington, Government Printing Office. 1900. Pages 1-204; plates I.-XXX.

A carefully detailed and exhaustive account of the geographical distribution, history, horticulture, botany and pathology of this destructive disease, and of experiments with the various remedies, methods and appliances for treating it. The most important of the conclusions is that very large percentages of the injuries due to the parasitic fungus *Ectoascus deformans* are not caused by the renewed growth of perennial mycelium, but are the result of new infections occurring in early spring, and thus preventable by spraying the still unopened buds with Bordeaux mixture or other fungicides. Previous failures with such treatments are explained by the fact that the remedy was applied after the pathogenic organism had hidden itself in the tissues of its host.

As the annual losses from leaf curl in the United States are estimated at \$3,000,000, the determination of these simple points is of great economic importance, and also of the widest interest, since this disease, unlike the yellows, extends to all regions where the peach is cultivated.

Ind. +

BOOKS RECEIVED.

*Select Methods of Food Analysis.* HENRY LEFFMANN and WILLIAM BEAM. Philadelphia, P. Blakiston's Son & Co. 1901. Pp. viii + 383. \$2.50.

*L'évolution du pigment.* G. BOHN. Paris, G. Carré and C. Naud. 1901. Pp. 96. 2 fr.

*Towers and Tanks for Water Works.* J. N. HAZLEHURST. New York, John Wiley & Sons; London, Chapman & Hall. 1901. Pp. ix + 126.

SOCIETIES AND ACADEMIES.

AMERICAN MATHEMATICAL SOCIETY.

A REGULAR meeting of the American Mathematical Society was held at Columbia University, New York City, on Saturday, April 27, 1901. About thirty-five persons attended the two sessions. Vice-President Thomas S. Fiske occupied the chair. The following persons were elected to membership: Mr. C. W. McG. Black, Yale University; Dr. S. E. Slocum, University of Cincinnati. Two applications for membership were received.

To relieve the increasing burden of administration, the office of Assistant Secretary was created and filled by the appointment of Dr. Edward Kasner, to serve until February, 1902.

The library of the Society, which at present consists mainly of some five hundred unbound volumes of journals received as exchanges, is about to be deposited in the library of Columbia University, under an agreement by which the University undertakes to bind, catalogue and care for the books now on hand and all future additions, and to make them easily accessible to the members of the Society. Arrangements will be made by which the books may be temporarily loaned to members living at a distance. The library is to be kept as a separate collection, duplicating as far as may be the general University library, and aiming to become as complete as possible in itself. The title to the books remains in the Society, which reserves

the right to withdraw them under agreed conditions.

The following papers were presented at this meeting:

Dr. W. A. GRANVILLE: 'Invariants of some  $m$ -gons under certain projective Lie groups in the plane.'

Dr. EDWARD KASNER: 'The algebraic potential surfaces.'

Professor F. MORLEY: 'On the real foci of algebraic curves.'

Mr. GEORGE PIERCE: 'A curious approximate construction for  $\pi$ .'

Professor E. W. HYDE: 'On a surface of the sixth order which is touched by all screws belonging to a three-conditioned system.'

Professor L. E. DICKSON: 'The hyper-orthogonal groups.'

Professor E. W. BROWN: 'On least action and minimal surfaces.'

Professor W. H. METZLER: 'On certain aggregates of determinant minors.'

Professor E. B. VAN VLECK: 'On the convergence of continued fractions in the complex elements; supplementary note.'

Professor W. F. OSGOOD: 'On a fundamental property of a minimum in the calculus of variations.'

Professor E. O. LOVETT: 'The geometry of quadrics.'

Professor E. O. LOVETT: 'The differential geometry of  $n$ -dimensional space.'

Dr. G. A. MILLER: 'On the groups generated by two operators.'

Dr. EDWARD KASNER: 'The relations between the angles of any number of lines in  $n$ -space.'

Dr. L. P. EISENHART: 'Isothermal conjugate systems of lines on surfaces.'

Dr. E. J. WILCZYNSKI: 'Geometry of a simultaneous system of two linear homogeneous differential equations of the second order.'

Dr. H. F. BLICHFELDT: 'A new determination of the primitive continuous groups in two variables.'

The summer meeting and colloquium of the Society will be held at Cornell University, Ithaca, N. Y., beginning August 19, 1901, and extending over a week.

EDWARD KASNER,  
Assistant Secretary.

ZOOLOGICAL JOURNAL CLUB OF THE  
UNIVERSITY OF MICHIGAN.

At the meeting of January 17th, Professor Jacob Reighard gave a paper on 'The Behavior of Plankton Nets.' This was based on plankton

work done on Lake Erie in 1899 and 1900, in company with Professor H. B. Ward, under the auspices of the United States Fish Commission. The amount of water strained by the nets was directly measured by the use of a meter. It was thus possible to determine accurately the coefficient of the nets under various conditions, to judge as to their constancy, and to decide as to the correctness of the coefficients calculated by other investigators. The results have a fundamental bearing on the worth of all plankton work hitherto done; details will be published in a paper now under preparation.

January 24th, Mr. Raymond Pearl gave an account of work on the 'Electrotaxis of Infusoria.' The paper was accompanied by demonstrations with the projection apparatus. The following demonstrations were given:

1. The reactions of *Paramecium* to the current. The orientation and movement toward the kathode in a weak current were first shown. Then by a gradual increase in the intensity of the current the speed of swimming was made to decrease, and in a very strong current the characteristic changes in body form were seen to occur.

2. The reactions of a species of *Oxytricha*, one of the *Hypotricha*. It was seen that on making the current a part of the animals immediately oriented and went toward the kathode, while others swam in an oblique direction more or less transverse to the current. Attention was called to the fact that during the transverse swimming the animal often jerked sharply to one side, the direction of this jerk always being the same—that is, toward the right side of the organism. It was shown that by this process of frequently jerking toward the right side while swimming obliquely, orientation with the anterior end toward the kathode was ultimately brought about. It was pointed out that the reason why a part of the animals oriented at once, while others did so only in the indirect way thus described, was owing to the different position of the axes of the body with reference to the anode and kathode at the time of making the current. When the long axis of the body was transverse to the direction of the current and the oral side was toward the kathode, the transverse or oblique swimming

occurred, while from all other positions immediate and direct orientation with anterior end toward the kathode followed the closing of the circuit. On reversing the current, it was seen that the animals always gained the new orientation with anterior end to the new kathode by turning to the *right*. The fact was shown that sudden breaking (as well as reversal) of the current always caused the typical motor reflex that is given by the organism as a response to stimuli of other sorts—the animal always turning to its right.

3. The kataphoric effect of currents of moderate intensity in carrying *Chilomonas* and suspended particles in the water toward the anode was shown.

Following the demonstrations an account was given of the electrostatic reaction of a number of infusoria, and the bearing of the results on the recent work of other investigators was discussed. Reference was made to the reactions of some of the lower Metazoa which resemble in many ways the reactions of the infusoria.

H. S. JENNINGS,  
Secretary.

#### DISCUSSION AND CORRESPONDENCE.

##### CORRECTION TO ANDRÉ'S ASTRONOMIE STELLAIRE.

THE favorable notice of André's 'Traité d'astronomie stellaire' contained in the number of SCIENCE for April 19, 1901, leads me to call attention to the following curious error contained in that work, which appears to have escaped the notice of all its reviewers.

In Vol. I., § 225, the author seeks to account for the well-known fact of a progressive variation in the periodic time—interval from minimum to minimum—of certain variable stars, and resorting to the hypothesis of a uniform

motion in the line of sight, he proceeds by elementary mathematical methods to derive the effect of this motion in altering the periodic time of the light variations. It is almost self-evident that the effect of this motion is to produce a small but constant difference between the true period, and that furnished by observation, and this result is confirmed by the author's analysis when properly executed. But at the equation marked (2) in the text, André commits the algebraic error of dividing two terms of his equation by a certain factor,  $n' - n$ , while neglecting to divide the third term and obtains thereby an erroneous result which he interprets, correctly enough so far as the equation itself is concerned, as showing that the star's radial velocity produces a progressive change in the periodic time of its light variations. He applies this equation to certain well-known variables having secular terms in their light equations, and derives from purely photometric data, numerical values for their motion in the line of sight, which, although plausible enough in respect of magnitude, are entirely wrong in principle. The entire section entitled 'Terme séculaire' should be suppressed since it is completely vitiated by the algebraic error noted above.

GEORGE C. COMSTOCK.

##### AN APPEAL FOR COOPERATION IN MAGNETIC AND ALLIED OBSERVATIONS DURING THE TOTAL SOLAR ECLIPSE, MAY 17-18, 1901.

To further test the results obtained by the United States Coast and Geodetic Survey during the total solar eclipse of May 28, 1900, arrangements are being made for obtaining simultaneous observations of the magnetic elements and of allied phenomena over the entire globe during the next total solar eclipse, May 17-18, 1901.\*

##### \*CIRCUMSTANCES OF THE ECLIPSE.

	Greenwich Mean Time.	Longitude from Gr.	Latitude.
Eclipse begins	May 17 d. 14 h. 59 m. .9	51° 34'.4 E.	20° 21'.9 S.
Central eclipse begins	17 15 57 .6	40 11 .2 E.	27 27 .6 S.
Central eclipse at noon	17 17 28 .8	96 51 .9 E.	2 07 .1 S.
Central eclipse ends	17 19 10 .2	156 53 .6 E.	12 49 .0 S.
Eclipse ends	17 20 07 .9	145 04 .5 E.	5 38 .0 S.

To make the investigation exhaustive, an earnest appeal is herewith made to all persons who have instruments at their disposal to participate in the proposed observations and to put themselves in communication with the Division of Terrestrial Magnetism, U. S. Coast and Geodetic Survey, Washington, D. C., so that the necessary directions may be given them.

The scheme of work proposed embraces the following:

1. Simultaneous magnetic observations of any or all of the elements, according to instruments at the observer's disposal, every minute from May 17, 14 h. to 21 h., Greenwich mean astronomical time.\*

[To insure the highest degree of accuracy attainable, the observer should begin work early enough to have everything in complete readiness in proper time.†]

2. At magnetic observatories all necessary precautions should be taken, so that the self-recording instruments will be in good operation, not only during the proposed interval, but also for some time before and after, and eye-readings should be taken in addition, wherever circumstances will permit.

3. Such meteorological observations as are possible for the observer should be made at convenient periods (as short as possible) throughout the interval. It is suggested that temperatures, *e. g.*, be read every fifth minute (directly after the magnetic reading for that minute).

4. Observations of atmospheric electricity and of earth currents should be made wherever possible, and any other phenomena of importance should be fully noted.

The request is made that observers send, as soon as possible, a full report of their work to the Superintendent of the Coast and Geodetic Survey.

L. A. BAUER.

\*For America this interval occurs during the night hours of May 17th and 18th, civil dates, while for Europe, Asia, Africa and Australia, it occurs during the morning or afternoon hours (according to longitude of station) on May 18th, civil date.

†See directions followed by the Coast and Geodetic Survey during the recent eclipse, Journal 'Terrestrial Magnetism,' Vol. V., p. 143.

CLAYTON'S ECLIPSE CYCLONE AND THE DIURNAL CYCLONES.

In a letter with the above title, in SCIENCE of April 12th (N. S., Vol. XIII., p. 589), Professor Bigelow criticizes my papers on the 'Eclipse Cyclone and the Diurnal Cyclones.' His criticism is subdivided into two heads: (1) concerning 'some minor errors' which he thinks he finds in the formulas, and (2) concerning the theory of the cold-center cyclone.

My method of treating the winds observed during the eclipse was first to find the mean wind during the eclipse at each station, then to find the deflections of the observed wind from this mean at intervals during the eclipse, in order to see if there were any systematic changes which might reasonably be attributed to the eclipse. In getting the mean wind, I plotted the individual observations of direction and velocity, taking them as nearly as possible at regular intervals, and drew the resultant direction for each station. As a check on this method and for greater exactness I next computed the mean wind for stations where the wind directions were recorded to degrees of azimuth, or the observations were otherwise considered sufficiently accurate. Observations to only eight points of the compass are not in general sufficiently accurate to show the eclipse wind. The general winds were from the southwest near the central path of the eclipse of May 28, 1900, in our Southern States, and the observations with which I had to deal were something like the following:

Direction in degrees. Velocity in miles.

(1) S. 23° W. 3

(2) S. 56° W. 2

(3) S. 80° W. 1

These were plotted as shown in diagram 1 A, in which the continuous arrows are the observed winds and the broken arrow is the mean wind. With the above values the plotted mean was found to be S. 44° W. Calling the observed wind  $o$  and its velocity  $v$ , the mean was then computed as follows:

	sin. $o$	cos. $o$	(sin. $o$ ) $v$	(cos. $o$ ) $v$
(1)	.391	.921	1.173	2.763
(2)	.829	.559	1.658	1.118
(3)	.985	.174	.985	.174
Sum.			3.816	4.055

$$\begin{aligned} \log. 3.816 &= 0.582 \\ \log. 4.055 &= 0.608 \\ \hline \text{diff.} = \log. \tan. \theta &= 9.974 \\ \theta &= 43^\circ \end{aligned}$$

$\theta$  is the mean wind, and in computing it in the present case it was not necessary to consider the sign of the quadrant, as all were in the same quadrant. It is seen that the plotted mean and the computed mean agree within one degree, and agreements approximating to this I found throughout the work. Diagram 1 *B*, gives an example of another set of winds. These examples are only to illustrate the methods. In the actual computations there were from 10 to 30 observations. In my statement of the formula, Professor Bigelow thinks the  $v$  should precede the  $\sin. o$  and  $\cos. o$ , but why he attaches importance to this I do not know. The product of  $xy$  is the same as that of  $yx$ . It is distinctly stated in my paper that  $o$  is the observed direction and  $v$  the observed velocity, so I fail to see how there could be any misunderstanding; but, if a change is needed, it would seem to me best to give the formula thus:

$$\tan. \theta = \frac{\sum (v \sin. o)}{\sum (v \cos. o)}$$

Having found the mean wind, my next step was to find the direction and velocity of the wind which, acting on the mean wind, would produce the observed wind in each case. This I sought to do by means of the well-known parallelogram of forces, as shown in Fig. 2. In this diagram, if  $AB$  represents the mean wind and  $AC$  the wind observed at some given time, then  $AC$  may be assumed to be deflected from the mean by a wind having the velocity and direction of  $AD$ . By plotting the observations in this way, I obtained the resultant winds for different portions of the eclipse area, and having plotted them, found evidence of a systematic circulation around the center of the eclipse area. This circulation followed the eclipse, and hence I conclude that it is caused by the eclipse. As before, I endeavored to check the plotted results and obtain greater accuracy by computing the resultant wind  $AD$  for certain of the stations. To do this, without changing the position of  $AD$ , I drew a line as represented by the dotted line  $BD$ , and from

FIG. 1.

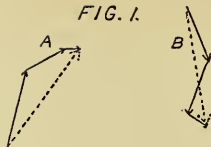

FIG. 2.

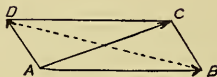

FIG. 3.

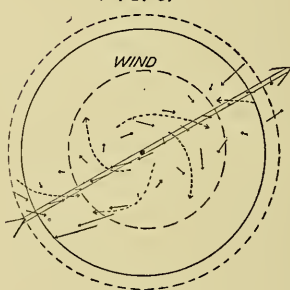
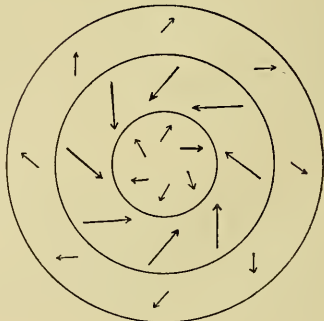

FIG. 4.



the triangle  $ABD$  proceeded to compute  $AD$  by well-known trigonometrical relations. I do not know why Professor Bigelow should find confusion because, in changing from plotting  $AD$  to computing  $AD$ , I changed the diagonal from  $AC$  to  $BD$ . I explained much of this in my paper, but, as I was writing for scientific men, it did not seem to me necessary to explain all the elementary processes.

Further details are given in the *Bulletin* of the Blue Hill Meteorological Observatory containing my discussion (*Annals* of the Astronomical Observatory of Harvard College, Vol. XLIII., Part 1, Observations and Investigations of the Blue Hill Meteorological Observatory, A. Lawrence Rotch, Director).

The final results as regards the wind circulation are illustrated in Fig. 3. In this diagram the arrows indicate, in the usual way, the direction of the resultant wind for different portions of the eclipse area, and the lengths of the arrows indicate the velocity of the wind. The central dark spot shows the area where the eclipse was total and the outer continuous circle shows the outer limit of the penumbra. The inner circle of broken lines shows the position of a probable ring of low pressure and the outer circle of broken lines shows the probable position of a ring of high pressure. The change of pressure found during the eclipse was in perfect accord with this latter conclusion derived from the wind circulation, and Professor Bigelow says that the observations of the Weather Bureau confirm my curve of pressure. The tendency to an anticyclonic circulation of the wind near the central area of the eclipse is confirmed by the observations of Professor Upton and Mr. Rotch in previous eclipses. (See *Amer. Meteor. Jour.*, Vol. IV., p. 456, Feb., 1888; also *Annals* of the Astronomical Observatory of Harvard College, Vol. XXIX., p. 18, 1893.)

I infer that Professor Bigelow does not seriously question the results as given by me, as he says Ferrel's 'cold-center cyclonic circulation \* \* \* is just the opposite of the result of the eclipse observations.' It is the interpretation of the observations to which Professor Bigelow objects.

When I discover a new fact, it seems to me

proper and even necessary for the advancement of science to consider the relation of the new fact to earlier known facts and to accepted theories and generalizations. In doing this I attempt to compare all the various facts and theories accessible to me and accept the best.

In considering the bearings of the eclipse data, I read among other things the views of Professor Bigelow in the International Cloud Report to which he refers. I find myself unable to accept his views of the air circulation in cyclones which he derives from the cloud observations, nor is his explanation of the diurnal change in pressure as an electromagnetic phenomenon satisfactory. However, in publishing results it is usually not possible for an author to enter into detail in regard to conclusions with which he is not in accord, nor is it best because it arouses strife and feeling. It seems best to give one's own conclusions and leave the future student to decide between conflicting views, as we have done.

In comparing my eclipse data with the different theories, I found that the results agreed so perfectly with certain views expressed by Ferrel concerning the cyclone with a cold center, that it leaves me no room for a new theory nor an improvement on his.

Ferrel says, "The conditions of a cyclone with a cold center which are the most nearly perfect are those furnished by each hemisphere of the globe, as divided by the equator, in which the pole is the cold center, and the temperature gradient from the pole toward the equator is somewhat symmetrical in all directions from the center. \* \* \* The center of a cyclone with a cold center may, or may not, have a minimum pressure, according to circumstances. A certain amount of temperature gradient, and of pressure gradient which is independent of the gyratory motion, as explained in § 72 in the case of the general circulation of the atmosphere, is necessary to overcome the friction in the lower strata and to keep up the vertical circulation, upon which the cyclone depends; and the pressure gradient, which depends upon the temperature gradient and is independent of the gyrations, may be such that the increase of pressure in the central part due to this cause may be greater than the decrease of pressure

arising from the cyclonic gyrations, especially where surface friction is great" ('A Popular Treatise on the Winds,' pp. 338-339). This is from Ferrel's latest book, and note that he says the increased pressure 'is independent of the gyrations.' He explains that the velocity,  $v$ , of the air circulation tends to decrease the pressure at the center of the cyclone and not at the same time cause a rise of pressure, as is assumed by Professor Bigelow. The § 72 referred to reads as follows:

"The first effect of the motion in the upper strata of the atmosphere from the equator toward the pole, as in the case of the water flowing from the warmer toward the colder end of the canal, would be to fill up a little, as it were, the polar region with air from the equatorial, the effect of which is to increase the pressure a little in the former and to decrease it a little in the latter region, thus creating at the earth's surface and in the lower strata a gradient of pressure decreasing from the pole toward the equator, which would cause a counter current in the lower strata."

Ferrel does not state here whether the counter current would be anticyclonic or not, but states in other passages that such a gradient under the influence of the earth's rotation would produce an anticyclonic circulation. However, we are not left to inference in regard to Ferrel's views in this matter, for in the *American Journal of Science* (2 Ser., XXXI, p. 33, par. 15) he states his views explicitly as follows:

"Near the poles the tendency to flow toward the equator seems to be the greater, and causes a current there from the poles, which being deflected westward (5) causes a slight northeast wind in the north frigid zone, and a southeast wind in the south frigid zone. But this is only near the earth's surface, and the general tendency of the atmosphere in the upper regions must be toward the east as will be seen."

In the paper just quoted Ferrel gives a diagram of the air circulation in the polar cold-air cyclones which shows the circulation about the north pole as given in Fig. 4, in which I have made the north pole the center of the circulation for comparison with the eclipse circulation. The circulation around the pole indicated by Ferrel agrees with that shown by ob-

servations, as will be seen by comparing it with the carefully prepared charts in the 'Report on the Scientific Results of the Exploring Voyage of H. M. S. *Challenger*, 1873-76' (Vol. II.).

The similarity to the wind circulation found in the eclipse area must be apparent to every one (compare Figs. 3 and 4). The chief difference is that the anticyclonic circulation around the center, as compared with the surface inflow, is relatively larger in the eclipse circulation, and the outer circle of outblowing winds in the latter is only faintly indicated, owing to lack of observations. But the larger anticyclonic circulation around the center in the eclipse is exactly what theory would indicate for a circulation over a continental area where surface friction is great, and in a case where the gradient necessary to overcome the friction is feeble.

It may be asked why the diagram quoted here from Ferrel differs so radically from those given by Professor Bigelow. The explanation, I think, is simple. Ferrel, for the purpose of mathematical treatment, in the examples which Professor Bigelow quotes, was dealing with ideal cases in which there was little or no friction. When his theory was applied to actual conditions on a globe possessing friction, his illustration of the cyclone with a cold center was like that I have given, with an increase of pressure and an anticyclonic circulation in the center at the earth's surface. The greater the friction the larger the central anticyclone must be to overcome the friction and maintain the circulation.

This view of Ferrel's theory is exactly that taken by Professor Davis, who is probably the ablest student of Ferrel in this country (*Quar. Jour. of the Roy. Meteor. Soc.*, April, 1899, p. 165).

The necessity of making every detail clear about the eclipse cyclone makes it necessary to omit consideration of the diurnal cyclones, but I think enough has been said to make clear the reasons for the contrasted views of myself and Professor Bigelow.

H. HELM CLAYTON.

BLUE HILL OBSERVATORY,  
April 16, 1901.



LELAND STANFORD JUNIOR UNIVERSITY :

To the Friends of Stanford University :

The undersigned, members of the University Council [professors and associate professors] of the Leland Stanford Junior University, in view of the numerous publications following upon the resignation of Professor Ross, which reflect on the University and its founder, and on our connection with it, deem it wise to issue the following statement.

In doing this we do not impeach the good faith of those who have interested themselves in this matter because of the question of university policy involved, but we wish to affirm our confidence in the University, its founder and its president.

We have examined all records, letters and copies of letters in the possession of the University bearing upon this case, and are agreed :

1. That in the dismissal of Professor Ross, no question of academic freedom was involved.

2. That in the dismissal of Professor Ross, President Jordan was justified.

J. C. BRANNER, *Professor of Geology.*

O. P. JENKINS, *Professor of Physiology and Histology.*

MELVILLE B. ANDERSON, *Professor of English Literature.*

J. M. STILLMAN, *Professor of Chemistry.*

FERNANDO SANFORD, *Professor of Physics.*

CHAS. D. MARX, *Professor of Civil Engineering.*

CHARLES H. GILBERT, *Professor of Zoology.*

DOUGLAS HOUGHTON CAMPBELL, *Professor of Botany.*

EWALD FLÜGEL, *Professor of English Philology.*

CHAS. B. WING, *Professor of Structural Engineering.*

FRANK ANGELL, *Professor of Psychology.*

W. R. DUDLEY, *Professor of Botany.*

A. T. MURRAY, *Professor of Greek.*

JULIUS GOEBEL, *Professor of Germanic Literature and Philology.*

NATHAN ABBOTT, *Professor of Law.*

JOHN E. MATZKE, *Professor of Romanic Languages.*

GEORGE M. RICHARDSON, *Professor of Organic Chemistry.*

JAMES O. GRIFFIN, *Professor of German.*

WALTER MILLER, *Professor of Classical Philology.*

RUFUS L. GREEN, *Professor of Mathematics.*

O. L. ELLIOTT, *Registrar.*

VERNON L. KELLOGG, *Professor of Entomology.*

LIONEL R. LENOX, *Professor of Analytical Chemistry.*

A. G. NEWCOMER, *Associate Professor of English.*

ARTHUR B. CLARK, *Associate Professor of Drawing and Painting.*

F. M. MCFARLAND, *Associate Professor of Histology.*

CLEM. A. COPELAND, *Associate Professor of Electrical Engineering.*

G. C. PRICE, *Associate Professor of Zoology.*

J. C. L. FISH, *Associate Professor of Civil Engineering.*

H. C. NASH, *Librarian.*

ELLWOOD P. CUBBERLEY, *Associate Professor of Education.*

GUIDO H. MARX, *Associate Professor of Mechanical Engineering.*

GEORGE A. CLARK, *Secretary to the University.*

JAMES P. HALL, *Associate Professor of Law.*

OLIVER M. JOHNSTON, *Associate Professor of Romanic Languages.*

GEORGE J. PEIRCE, *Associate Professor of Botany.*

HERMAN D. STEARNS, *Associate Professor of Physics.*

STANFORD UNIVERSITY, CAL.,

March 18, 1901.

#### CURRENT NOTES ON PHYSIOGRAPHY.

TOPOGRAPHIC ATLAS OF THE UNITED STATES.

The second folio of this atlas, prepared like the first by Gannett, includes some striking topographic types. The Dismal swamp (Norfolk sheet, Va.) is given as an example of a coast swamp; discharge of its waters is prevented by the abundant vegetation on the flat uplands of a low coastal plain whose surface has been somewhat dissected and whose shore line has been extended inland by a slight submergence which has drowned many valleys. A number of the branching bays are headed by valley swamps of a different type from those of the plain. The lower Missouri is given as an

example of graded river (Marshall sheet, Mo.); that is, "its course has been eroded to almost as low a stage as possible, and its slope has become very slight, so that its cutting power is trifling." Reference to the balanced relation of load and carrying power might have here been made to advantage. There is perhaps some objection to citing the Missouri as an example of a normally graded river, as it is probable that the present Missouri has established its flood plain by aggrading rather than by degrading the valley floor. The Platte river (Lexington sheet, Neb.) is instanced as an 'overloaded' stream, of which class it is certainly a very striking example; but it is to be regretted that, as the term 'graded' was adopted for the Missouri, 'aggraded' or 'aggrading' was not employed for the Platte.

The linear Appalachian ridges are beautifully shown where the Susquehanna cuts across them (Harrisburg sheet, Pa.), types of their class for the world. The text of this example is somewhat less satisfactory than that of the others: tributaries are said to cut down their beds more rapidly than the main river; the sinuosities of the side streams are ascribed to the retarded erosion of the Susquehanna across the hard rocks, instead of to the pause in uplift, during which the inter-ridge lowlands were etched out; indeed, no explicit mention is made of these lowlands as local weak-rock penepains, although the extraordinary enclosed meanders of Conedoguin creek are referred to a time when the Susquehanna was 'held at one level for a considerable period'; 'subsequently, by some means, the river succeeded in lowering its bed' and its tributary followed suit. 'By some means' might be well replaced by 'after an uplift.' The diagram giving a section of some of the ridges does not properly represent the dip of their strata, and the Medina formation is labelled Potsdam. Finer examples than the alluvial fans ('cones') of southern California and the huge basin of Crater lake in Oregon could not be selected for the closing numbers of this folio, which contains ten sheets in all.

#### TERRACES FRONTING THE ROCKY MOUNTAINS.

AT various points piedmont to the Front range of the Rocky mountains in Colorado, there are

sloping gravel-covered plains or mesas, into which the streams have cut their valleys. Lee describes some of these (The origin of débris-covered mesas of Boulder, Colorado. *Journ. Geol.*, VIII, 1900, 504-511, 4 figs.) and emphasizes the contemporary date of the graded piedmont surface, beveled across the underlying rocks, and the deposits of coarse waste with which it is covered; both are the product of the lateral shifting of streams, cutting on one side and filling on the other; the waste, 25 to 50 feet in thickness, being chiefly a flood deposit. The present action of the stream at Boulder in its channel and on its flood plain imitates the former action by which the intermediate mesa terrace and the higher mesa were produced. It is suggested that the three grade plains thus indicated "do not seem necessarily to require the assumption of any change in the attitude of the land subsequent to the elevation of the mountains, but are the natural sequences of erosion as influenced by the local distribution and difference in hardness of the formations involved." A gradual down-cutting with an active lateral shifting appears to account for the features described.

#### THE FORMATION OF DESERTS.

'Das Gesetz der Wüstenbildung in Gegenwart und Vorzeit' (Berlin, 1900, 175 p., 50 views) is a new work by Walther, already known for his studies of desert denudation. The book opens with a comparison of sea floors and desert surfaces; each one becomes smoother by filling with waste from the enclosing highlands, the coarser waste remaining near the margins; but the deposits in one contain few records of life, while those of the other may teem with fossils. Special accounts are given of the process and results of dry weathering, of wind erosion (deflation) and of water action in arid regions. The forms assumed under these processes are well described and illustrated. Rock ledges are left bare, frequently with a pitted surface; they are sometimes found worn down to a small relief and strewn with a scanty covering of waste. The popular impression that deserts are plains is held to be not so far from the truth as is sometimes taught, since so large a part of arid landscapes is degraded

or aggraded to a nearly even surface. The crescentic sand-dune is taken as a normal form on an open surface. The necessity of a former pluvial period to explain the wadies of deserts, as stated by some writers, is doubted; and in spite of the violence of occasional cloud-burst floods, the chief agency in the preparation of desert topography is held to be the wind; a conclusion that seems to have been long familiar to the Bedouin, just as the transportation of erratics by a former extension of glaciers has long been known to Swiss peasants. The importance of identifying ancient desert formations in the geological series is emphasized.

Although penneplanation under arid conditions is not excluded from the Walther discussion, the systematic advance of the processes of arid denudation through an ideal cycle and the description of the forms thus successively developed are not fully presented. Old and young deserts are not clearly separated. In some arid regions, the marginal deposits of the coarse waste rise upon the flanks of the enclosing mountains; in others a piedmont slope of evenly degraded rock, veneered with thin sheets of waste, slopes gently forward from the mountain base. The first is probably a younger form than the second; but no one has yet studied out the full series of still younger and still older forms of an arid landscape.

W. M. DAVIS.

#### THE AMERICAN GEOGRAPHICAL SOCIETY.

THE American Geographical Society will move into its new building in 81st Street, New York, in the course of the next two or three months. The Society has at present about 1,200 members and, to still further increase its numbers, has sent out a circular, from which we quote the following:

The objects of the American Geographical Society are: The collection, discussion and diffusion of geographical information; the promotion of the exploration of our territory and of the survey and preservation of our harbors; the establishment in the chief maritime city of the Union of a place where will be afforded the means of obtaining accurate information of every part of the globe, and the registration and careful record of discoveries and studies in geography and the related sciences.

The Society was founded in 1852. One of but twelve similar societies at that time, it now exchanges its publications with three hundred scientific associations scattered throughout the world.

The Society has outgrown the house, No. 11 West Twenty-ninth Street, in which it has been lodged for more than twenty years. A handsome fireproof building is now being erected in West Eighty-first Street, opposite Manhattan Square. This will afford perfect security to the library of 30,000 volumes—one of the foremost geographical libraries of the world—the thousands of maps and charts and the collection of atlases of the sixteenth, seventeenth and eighteenth centuries, now in the map rooms, and will also provide ample accommodation for readers and students.

Travelers, men of science, and others properly accredited, are welcomed at the rooms of the Society and freely offered the use of the library and collections.

The Society is now free from debt and possesses a property which has of late been steadily growing in value.

It is desired to add to the number of fellows on the roll in order to strengthen and extend the influence and the usefulness of the Society.

No special qualification for fellowship is required other than interest in the spread of knowledge and the advancement of science. The annual dues are \$10.

#### RESOLUTION OF THE COMMITTEE OF CENTRAL NATURALISTS.

AT a meeting of the committee appointed by the Chicago meeting of naturalists to arrange for the next meeting, held at Chicago, March 28th, the following was voted. The vote has since been submitted to a number of the older members of the American Society of Naturalists living in the Central States and has been approved by them. It may, therefore, be taken to represent the prevailing sense of the naturalists of the Central States.

VOTED: Whereas, the naturalists of the Central States propose to meet annually at some convenient point for intercourse and the reading of papers;

And whereas, no point east of the Alleghenies (to which territory the meetings of the American Society of Naturalists are by its constitution confined) is practicable as such meeting point;

And whereas, the central naturalists would view with approval the formation of a national body which might properly be called the Amer-

ican Society of Naturalists, by which name the eastern society is now known ;

And whereas, it is desirable that the organization of the central naturalists should be coordinate with the eastern society ;

And whereas, it is desirable that all the naturalists of the country should, as far as possible, come together from time to time in a national general gathering ;

*Resolved*, that the naturalists of the Central States form a permanent organization and that they favor a coordinate relation of this association and that of the Eastern States, as eastern and central branches respectively of the American Society of Naturalists.

That the two organizations meet annually in their respective territories (except as stated below), have the same conditions of membership, elect their own officers and collect and disburse their own funds ;

That the records of the two branches, including lists of members, be published jointly at joint expense and under the joint editorship of the secretaries of the two branches ;

That every third year the two branches meet together alternately in the East and in the Central States, that the officers of the meeting be those of the receiving branch, and that visiting members enjoy full privileges, except as may be agreed upon at the time of joint ratification of this resolution ;

That this resolution be transmitted to the American Society of Naturalists at its Chicago meeting, with the suggestion that it be referred to a committee to arrange further details and that the report of the committee be received and acted upon at the same meeting ;

That, a copy of these resolutions be printed in *SCIENCE* to give an opportunity for full discussion of them.

C. B. DAVENPORT,  
*Secretary of Committee.*

#### SCIENTIFIC POSITIONS UNDER THE GOVERNMENT.

A NUMBER of important scientific positions will be filled by civil service examination on June 3d. It is desired to establish an eligible register for the positions of plant physiologist and plant pathologist in the office of Plant

Industry, United States Department of Agriculture, with salaries of \$1,800 per annum. The competitors will not be assembled for this examination, but must make application for the special form and send the following information not later than the date mentioned. The statements in physiology, those in pathology being similar, together with the weights, are as follows :

1. A statement of the line of study pursued in the colleges in which the competitor has received degrees or in which he has carried on work :
  - (a) Technical and practical work with plant physiology. .... 20
  - (b) Scientific research in physiology and coordinate lines ..... 20
  - (c) Submission of a list of articles on physiology and related subjects published by competitor ..... 25
2. A statement of the competitor's experience as an executive officer or teacher..... 15
3. A statement of not less than 500 words setting forth the present status and prospective development of plant physiological research..... 20

An examination will be held on the same day in any city where postal free delivery has been established for the position of assistant in the seed laboratory of the Division of Botany with a salary of \$1,200, the subjects and weights being as follows :

1. Essay on methods of conducting purity tests (orthography and penmanship will be marked on this exercise) ..... 10
2. Structural botany..... 15
3. Morphology of the seed ..... 20
4. Reading botanical German ..... 10
5. Drawing of seeds ..... 15
6. Identification of seeds..... 30

An examination under similar conditions will be held for the position of a field assistant in the Department of Agriculture, with a salary of \$1,000. Here the subjects and weights are :

1. Forestry.....(sheet 1)..... 60
2. Botany.....(sheet 2)..... 10
3. English composition.....(sheet 3)..... 10
4. Education and experience.....(sheet 4)..... 20

An examination for the position of computer in the Division of Forestry, with a salary of \$1,000, will also be held, the subjects being :

1. Forest mensuration..... 60
2. General forestry..... 25

3. Education and experience.....	15
For the position of ethnologist in the Bureau of American Ethnology, at a salary of \$1,500, an examination will be held as follows :	
1. Essay on ethnologic and archeologic subject.....	20
2. Experience in ethnologic work (a) in the field ; (b) in writing, teaching, etc.....	20
3. Original publications on ethnologic and archeologic subjects.....	20
4. The geographic, ethnologic, and archeologic features of Arizona and New Mexico.....	30
5. Literature of ethnology and archeology of southwestern United States.....	10

#### SCIENTIFIC NOTES AND NEWS.

A MEETING was held at Cambridge University on April 27th to arrange for some acknowledgment of the services to science and the University of Professor G. D. Liveing. Professor Liveing is now seventy-three years of age. In 1852 he organized the chemical laboratory at Cambridge which was the first scientific laboratory in the University.

DR. EDMUND B. WILSON, professor of zoology at Columbia University, and Dr. J. Playfair McMurrich, professor of anatomy at the University of Michigan, are among the Americans who will attend the International Zoological Congress to be held in Berlin from the 12th to 19th of August.

THE U. S. Biological Survey has been engaged for several years in studying the geographic distribution of animals and plants in Texas, with a view to the preparation of maps showing the limitations of the life zones and faunal areas in that State. Mr. Vernon Bailey, chief field naturalist of the Biological Survey, has charge of this work and has recently gone to southwestern Texas to begin field operations for the season of 1901. He is assisted by Mr. H. C. Oberholzer.

DR. D. A. CARMICHAEL, recently appointed federal quarantine officer in San Francisco, has arrived in that city. He has presumably been given this appointment on account of his success in suppressing the plague in Honolulu.

DR. GEORGE BLUMER, of the Bender Laboratory at Albany, has been appointed director of the Bureau of Bacteriology and Pathology, newly established by New York State.

PROFESSOR H. POTONIÉ and Dr. Aug. Denckmann have been appointed geologists in the Geological Bureau at Berlin.

MR. EVELYN BALDWIN, who is shortly to lead the North Polar expedition equipped by Mr. Ziegler, has gone to Norway and Denmark in connection with his preparations. He will shortly go to Dundee to join the steamer *America* which he recently acquired for the expedition.

MR. W. H. C. PYNCHON has given a course of six lectures at Trinity College upon the 'Geology of the Connecticut Valley Lowland.'

MISS C. M. DERICK, lecturer in botany at McGill University, has been granted a year's leave of absence, and will study botany under Strasburger at Bonn.

DR. THOMAS CONRAD PORTER, since 1866 professor at Lafayette College, died on April 27th, at the age of seventy-nine years. Dr. Porter at first taught the natural sciences at Lafayette College, while later his work was confined more especially to botany. He was made emeritus professor four years ago, but remained dean of the Pardee Scientific School. He was the author of a 'Botany of Pennsylvania,' 'A Synopsis of the Flora of Colorado' and other works. He was a man of great learning, belonging to the older school of naturalists, and, although he left very valuable collections and notes, it is to be feared that a vast fund of valuable information is lost by his death.

THE death is announced, at the age of 82 years, of Mr. James Douglas Reid, who was interested in the construction of the early telegraph lines in this country. He was the author of a book entitled 'The Telegraph in America,' and for a while conducted a journal devoted to telegraphy.

WE regret also to record the death at the age of 82 years, of F. K. M. Feofilaktow, lately professor of geology in the University at Kiev, of Dr. Adolph Hirsch, professor of astronomy in the University of Neuchatel and director of the observatory, and of Dr. S. Lamanski, the physicist of St. Petersburg.

THE International Association of Academies

will hold its next meeting in London in 1904. It does not seem possible to obtain information in regard to the recent meeting until the *Comptes rendus* are published.

THE Thirty-ninth Congress of the Sociétés Savantes met at Nancy last month with about two hundred and fifty delegates in attendance.

A CONFERENCE of State University presidents will be held at the University of Illinois on May 1st and 2d. The following presidents are expected to attend the meeting: James H. Baker, of the University of Colorado; Joseph Swain, of the University of Indiana; George E. McLean, of the University of Iowa; Acting Chancellor W. C. Spangler, of the University of Kansas; James B. Angell, of the University of Michigan; Cyrus Northrop, of the University of Minnesota; R. H. Jesse, of the University of Missouri; Chancellor E. B. Andrews, of the University of Nebraska; W. C. Thompson, of the University of Ohio; W. E. Stone, of Purdue University, and Acting President E. S. Birge, of the University of Wisconsin.

A METRIC Association is being organized in Canada, the object of which is to prepare the people for the adoption of the metric system.

THE French Association of Anatomists held its third meeting at Lyons in April under the presidency of M. Renaut. There were about fifty students of anatomy in attendance, including a number of foreigners. The next meeting of the Association will be held at Montpellier in 1902 under the presidency of M. Sabatier.

THE committee of the British National Physical Laboratory announces that it is prepared to receive applications for appointments as members of the staff of this laboratory, the buildings of which will be in the grounds of Bushyhouse, Teddington. It will appoint a superintendent of the engineering department, with a salary of £400 per annum; one or two assistants in the physics department, with salaries of from £200 to £250 per annum; and one assistant in the physics department to take charge of such chemical investigations as may be required, with a salary of £200 per annum. The committee is also prepared to receive applications for a small number of junior assistantships, at salaries of from £100 to £150 per

annum. Applications, accompanied by a limited number of testimonials, should be made, not later than May 24th, to the director, National Physical Laboratory, Old Deer Park, Richmond, Surrey.

PREPARATIONS are being made by the Division of Forestry of the Department of Agriculture to remove from its present crowded quarters to offices on the sixth, seventh and eighth floors of the Atlantic building. Under the reorganization plan of the Department of Agriculture, authorized by the last Congress, the Forestry Division will, on July 1st, become a bureau of the Department.

THE American Museum of Natural History, New York, has acquired a valuable collection of Peruvian antiquities, including Indian pottery, musical instruments, stone implements, gold and silver vessels, and the like.

THE New York Academy of Medicine has been given a fund of \$10,000 by Mrs. S. B. Gibbs and Miss G. B. Gibbs for the establishment of the Edward N. Gibbs memorial prize fund.

M. SANTOS-DUMONT, to whom the prize of the Paris Aeronautical Club was awarded in 1900, has returned the money to the Club to be used as the foundation for a new prize. The amount is 100,000 fr., and the income is to be given to the members of the Club who can make a circuit of the Eiffel Tower and return to the point of departure at St. Cloud.

A TELEGRAM has been received at the Harvard College Observatory, dated May 2d, from its station at Arequipa, stating that a very bright comet was seen at eleven hours thirty-five minutes (Greenwich mean time) in R. A. 3<sup>h</sup> 30<sup>m</sup> and Dec.—1°. This is presumably the comet announced by Dr. Gill, April 24, 1901. It seems to be no longer visible in the northern hemisphere.

THE *Electrical World* states that the Administration of Posts and Telegraphs contemplates the introduction of wireless telegraphy in Spain on a large scale. It is rumored that Marconi will soon go to Madrid to arrange matters with the Government. The Balearic and Canary Islands are first to be connected by this system, which will then be extended from these islands

to the Continent. Several places on the coast of Morocco, such as Ceuta, etc., will be connected with Algeciras and Tarifa.

Mr. H. E. BIERLY, professor of biology in the State College at Tallahassee, Fla., succeeded during the last meeting of the State Teachers' Association in having child-study made a special department of the Association, and was elected director. During the last month the women's clubs, mothers' clubs and kindergarten associations in the State have been taking up the subject under his direction. The State superintendent of public instruction recommends the work officially. All the colleges, normal schools, etc., in the State are giving their hearty support to the movement and are very much interested in the subject.

THE Paris correspondent of the *New York Evening Post* writes as follows regarding an address made by Professor Bernheim, at the congress of French learned societies held recently at Nancy :

The venerable Professor Bernheim, the founder of the famous school of Nancy, which still holds out against Charcot and the Salpêtrière, made an impassioned declaration of his beliefs and principles. He utterly denies the hypnotic character of the phenomena observed in the patients of the Salpêtrière, whom he declares to be mere hysterical personages. He developed at length his theory of the universal suggestibility of all men ; he denied once more the existence of anything like a magnetic fluid, under whatever name. There is a radical defect in experiments concerning thought transference, which he says ought rather to be spoken of as treason than as a veritable transference of brain influence. There was some bravery in this renewed declaration of opinion on the part of one who has already suffered excommunication from the most recent science.

Just what is meant by the last sentence is not clear, but it is apparently intended to indicate that Professor Bernheim's science is antiquated because he does not believe in the vagaries of the Salpêtrière or in telepathy. It is difficult to understand why a journal as carefully edited as the *New York Evening Post* should not submit its scientific news to an expert for revision.

THE London *Times* states that an apparatus, invented by Mr. Poulsen, of Copenhagen, for recording telephonic messages is now being

shown in London. The invention, which can be used in substitution for, or in cooperation with, any ordinary telephone receiver, consists essentially of a long steel wire or ribbon, which passes rather rapidly before the poles of a small electromagnet. This electromagnet, which is wound with very many turns of exceedingly fine wire, is inserted in the telephone circuit by the current in which it is magnetized. The steel wire is of course also magnetized, and the essence of the machine lies in the fact the magnetization induced in the successive portions of the wire varies in agreement with the undulations of the electric current in the telephone circuit, produced by the voice of the speaker. To read the message it is only necessary to pass the steel wire in the same direction past the poles of the same or a similar electromagnet, when the same undulations will be set up in the current passing through its coils and consequently the same sounds reproduced in the attached receiver. In the instruments in London these reproduced sounds are remarkably true and pure. It is said that the same message may be reproduced from what may be called the sensitized ribbon an indefinite number of times, but, if it is desired to remove the record, that can be simply effected by subjecting the wire to a constant magnetizing force, such as is obtained by passing an unvarying current through the electromagnet. In one form of the machine ordinary pianoforte wire is employed, and is wound helically round a brass cylinder rotated by a electric motor. In another, which is adapted for longer messages, thin steel ribbon is wound on and unwound from two rolls alternately. The curious thing here is that, although no magnetic screen or insulator is interposed between the successive layers of ribbon, the magnetization produced in every portion of them is preserved unaltered. In a third form, a continuous steel band is stretched between two revolving pulleys; at one point is placed the electromagnet connected with the transmitting telephone, and beside it is any number, limited only by considerations of space, of electromagnets connected with receiving telephones, each of which in turn receives the message impressed on the ribbon. After the ribbon has passed all these electromagnets it is sub-

jected to the influence of several permanent magnets by which it is, so to speak, wiped clean and prepared to receive another series of magnetic impressions.

M. DARBOUX, in welcoming the delegates to the International Association of Academies at the recent Paris meeting, according to the report in the London *Times*, attributed the original idea of association for scientific research to Lord Bacon, recalling the curious conception of the College of the Six Days' Work of the House of Solomon, which, however, was never realized. To-day, such was the range of scientific activity, no such scheme could ever be realized, and only the common agreement and reciprocal support of the nations could suffice even to undertake the solutions of the problems which were now imposed in all their multiplicity on the attention of the world. Such agreement had been secured for a certain number of special questions, such as the International Bureau of Weights and Measures, the International Geodetic Association, the Association for the Map of the Heavens and, notably, the international catalogue of scientific literature, due entirely to the initiative of the Royal Society. M. Darboux then continued: "This international cooperation, which has always proved its value in all the cases where it has been found indispensable, will be assured in a lasting, normal and universal way by the formation of our Society. The task that we have undertaken may appear difficult, but it has become absolutely necessary, and the spirit actuating us ought to give us the assurance that we shall succeed by our united efforts in overcoming all difficulties." In constituting under a visible and permanent form this universal academy, which had been conceived and prepared by Leibnitz, many of whose other dreams, moreover, have been realized or are being realized, our Association will render to civilization and science a service of which it is impossible to exaggerate the importance. Thanks to it, the man of science devoting his life to the most delicate or the most abstract researches will cease to feel himself isolated, while still preserving that independence which is the greatest good and the primary need for the investigator. By uniting in the different academies

all those who are studying the same subjects, by giving them, if they wish it, the opportunity of joining in a common work, by drawing the attention of the governments to all the schemes the speedy realization of which is necessary, or desirable, by indicating to them also the means of executing these schemes in the most favorable conditions and with the greatest possible saving, and by proposing and preparing through the common understanding of *savants*, in the domain of theory the agreements of peoples in the basis of practice and facts, our Association is destined to become rapidly one of the most powerful instruments of concord and of progress. It is with this firm conviction that I declare open the first general assembly of the International Association of Learned Societies.

At a meeting of the Geological Society of London, on March 6th, Professor George Frederick Wright, of Oberlin College, presented a communication entitled, Recent Geological Changes in Northern and Central Asia, the paper being the outcome of a journey made by the author in company with Mr. Frederick B. Wright in 1900-1901. He said that in North America an area of about 4,000,000 square miles was brought under the direct influence of glacial ice during the Glacial Epoch. The result of six weeks spent in Japan was to show that there are no signs of general glaciation in Nippon or Yesso. Neither is there any sign of glaciation along the border of the Mongolian Plateau, where the general elevation is 5,000 feet, but the whole region is covered with loess. This has usually accumulated like immense snow-drifts on the southeastern or lee side of the mountains, and in its houses and villages are excavated. In the mountainous region, strata of gravel and pebbles are so frequent in the loess, that it is necessary to invoke both wind and water in order to explain fully the origin of the deposit. At the present time the loess in the interior is being washed away by streams much faster than it is being deposited by the wind. The journey across Manchuria from Port Arthur along the Lao-Ho and Sungari rivers was through valleys choked with alluvium, and there was no evidence that the drainage of the Amur had ever been reversed by ice, like that



of the St. Lawrence; nor was there any other evidence of glaciation. The lower course of the Amur indicates subsidences. Again, there are no signs of glaciation on the Vitim Plateau. Lake Baikal appears to be of recent origin; it is 4,500 feet deep and has not been filled by the great quantities of sediment brought down by the Selenga and other rivers. Although glaciers could frequently be seen on the mountains which border the Central Asiatic Plateau to the northwest, there was no evidence that the glaciers had ever deployed on the plain. The less region of Turkestan, and indeed the whole area from the Sea of Aral to the Black Sea, appears to have been recently elevated, in some places as much as 3,000 feet. Desiccation took place at the same time, so that the larger lakes are only brackish or still fresh. Direct evidence of this in the form of deposits is given. The author thinks it likely that the absence of glaciation in northern Asia may have been due to the rainlessness of the region and that, while America was elevated, Asia was depressed during the Glacial Epoch.

THE Brussels Academy of Sciences announces, as we learn from *Nature*, the following prize subjects for 1901: New researches upon the compounds formed by the halogens between themselves (800 francs); the determination of the form of the principal terms introduced into the formulæ of nutation in obliquity and longitude by the elasticity of the earth's crust (800 francs); historical and critical discussion of Weber's experiments on unipolar induction, and new experiments bearing upon the laws and interpretation of this physical fact (300 francs); a contribution to the study of mixed forms with a number of series of variables, and the application of the results to the geometry of space (600 francs); history of researches on the variation of latitude, and a discussion of the interpretations of this phenomenon (600 francs); investigations of the physiological rôle of albuminoid substances in the nutrition of animals or plants (800 francs); new researches on the organization and development of *Phoronis*, and the relations existing between the animals *Rhadinopleura* and *Cephalodiscus*, and the class to which the name *Enterozooneusta* has been applied (1,000 francs); descrip-

tion of simple substances; sulphates and binary compounds of Belgian soil (800 francs); researches on the influence of external factors on karyokinesis and cellular divisions in plants (800 francs). We learn from the *Lancet* that on April 10th the committee of the Marine Biological Station at Millport received representatives from various educational bodies at the Station, with a view to extend a knowledge of the educational resources at their command. Dr. J. F. Gemmill, the president, gave a sketch of the new teaching arrangements, which include a course of lectures on marine zoology and botany, with practical demonstrations on Saturdays from April 27th to June 15th, inclusive, the introductory lecture to be delivered by Sir John Murray, K.C.B., F.R.S. The visitors were afterwards conducted over the laboratories, tank-room and museum by Dr. James Rankin, and then proceeded on a dredging excursion on the steam-launch *Mermaid*, recently presented to the institution. It is hoped that the new teaching arrangements will encourage the practical study of natural history among board school and other teachers, upwards of 40 of whom have already entered their names for the new classes. The science students in the University of Glasgow also find the station an admirable center for practical work, and the younger dons in the science faculty are energetically assisting in its development.

It is announced that, through an expedition to Kébai Peninsula by Mr. Andrew J. Stone in the interests of the American Museum of Natural History, the Museum has received some fine specimens of the big Alaskan moose, recently described as *Alces gigas*. This animal is the largest known representative of the deer tribe, and differs from the moose of eastern Canada and Maine in its larger size and darker colors, but especially in the great development of its antlers, which are much larger than those of the eastern moose. Mr. Stone also obtained specimens of two species of bear and the head of a fine caribou. Other recent acquisitions of note are a collection of mammals from Peru, consisting of about one

hundred and fifty specimens, and representing some twenty-five species, of which quite a number proved new to science and others had been only recently described from specimens received at the British Museum. With this collection was also received a small collection of birds, which contained many species new to the Museum collection and several new to science.

#### UNIVERSITY AND EDUCATIONAL NEWS.

MR. GEORGE W. CARROLL, of Beaumont, Texas, has given \$60,000 to Baylor University, at Waco, Texas, for a science building.

BY the will of Miss Mary Shannon, of Newton, Mass., \$125,000 is distributed among charitable and public institutions. Wellesley College receives \$15,000 and several institutions for the education of negroes receive sums ranging from \$5,000 to \$10,000.

A BUILDING to contain the bacteriological and pathological laboratories is to be erected at the University of Michigan at a cost of \$100,000.

As we have already announced the degree of Bachelor of Arts will hereafter be given at the University of Michigan without any requirement in the classical languages either at entrance or afterwards. It has now been decided that there will be no required subjects in the course, except English in the freshman year. In addition first-year students may select three subjects from the following: Greek, Latin, French, German, history, mathematics, physics, chemistry, biology.

It is expected that Cornell University will this June grant 380 baccalaureate degrees and 74 advanced degrees. They are apportioned as follows: 125 A.B. degrees; 1 B.S.; 44 LL.B.; 16 B.S.A.; 9 D.V.M.; 5 B.S.F.; 6 B.Arch.; 51 C.E.; 123 M.E. (including electrical, marine and railway M.E.); and 21 A.M. degrees; 9 M.S. in Agr.; 4 M.C.E.; 10 M.M.E.; 1 D.Sc.; 29 Ph.D.

THE forty-five graduate students of the New York University, with one exception, have signed the following resolution, and forwarded

it to the chancellor of the University and to the president of the University Council:

*Resolved*, that we, the undersigned members of the Graduate School of the New York University, sincerely regret the resignation of Professor Edward F. Buchner, Ph.D., Samuel Weir, Ph.D., and Professor Charles H. Judd, Ph.D., whose departure threatens the high standard and continuity of our courses, as well as the usefulness of the Graduate School, and respectfully request the authorities of the University to secure the continued services of those professors. Some of us also hold our Bachelor's and Master's degrees from this and other universities, and we believe that we are competent judges of professional worth, and hereby desire to express our unqualified repudiation of the aspersions cast upon the professional efficiency of Dr. Edward F. Buchner. Many of us have been in his classes, and we have uniformly found Dr. Buchner to possess a rich and rare gift of insight, a profound grasp of philosophical problems, as well as felicitous power of expression and painstaking and sympathetic class-room methods. Believing that this rare gift as a teacher and a scholar makes him an ornament to his profession and a credit to the University, we trust that the University Council will give this resolution full weight in their deliberations.

PROFESSOR E. A. ROSS, of the University of Nebraska, recently of Leland Stanford Junior University, has been appointed a visiting lecturer at Harvard University for next year.

OWING to the recent complications, Dr. Arthur O. Lovejoy, associate professor of philosophy at Stanford University, has resigned.

DR. MAX FARRAND, professor of history at Wesleyan University, has accepted the chair of history in Stanford University.

DR. EDMUND ARTHUR ENGLER, professor of mathematics at Washington University, St. Louis, and dean of the College of Engineering, has been elected president of the Worcester Polytechnic Institute.

MR. J. W. H. POLLARD, Dartmouth '95, has been appointed physical director in Lehigh University.

DR. J. STAFFORD, lately of the University of Toronto, has been appointed lecturer in zoology at McGill University.

DR. J. A. GMEINER has been appointed associate professor of mathematics at the German University of Prague.

# SCIENCE

A WEEKLY JOURNAL DEVOTED TO THE ADVANCEMENT OF SCIENCE, PUBLISHING THE OFFICIAL NOTICES AND PROCEEDINGS OF THE AMERICAN ASSOCIATION FOR THE ADVANCEMENT OF SCIENCE.

EDITORIAL COMMITTEE: S. NEWCOMB, Mathematics; R. S. WOODWARD, Mechanics; E. C. PICKERING, Astronomy; T. C. MENDENHALL, Physics; R. H. THURSTON, Engineering; IRA REMSEN, Chemistry; JOSEPH LE CONTE, Geology; W. M. DAVIS, Physiography; HENRY F. OSBORN, Paleontology; W. K. BROOKS, C. HART MERRIAM, Zoology; S. H. SCUDDER, Entomology; C. E. BESSEY, N. L. BRITTON, Botany; C. S. MINOR, Embryology, Histology; H. P. BOWDITCH, Physiology; J. S. BILLINGS, Hygiene; WILLIAM H. WELCH, Pathology; J. MCKEEN CATTELL, Psychology; J. W. POWELL, Anthropology.

FRIDAY, MAY 17, 1901.

THE PLAGUE IN SAN FRANCISCO.

## CONTENTS:

<i>The Plague in San Francisco</i> .....	761
<i>The Destruction of Sea Lions in California</i> .....	765
<i>On the Vital Activity of the Enzymes</i> : PROFESSOR J. H. KASTLE.....	765
<i>The Progress made in Engineering during the Nineteenth Century</i> : PROFESSOR J. L. VAN ORNUM.....	771
<i>Monaural Localization of Sound</i> : PROFESSOR J. R. ANGELL.....	775
<i>Food of Sea Lions</i> : DR. C. HART MERRIAM.....	777
<i>Scientific Books</i> :—	
<i>McGee on the Seri Indians</i> : PROFESSOR ALEXANDER F. CHAMBERLAIN. <i>Verhandlungen der Deutschen Zoologischen Gesellschaft</i> : PROFESSOR CHARLES A. KOFOID. <i>Bolton's Bibliography of Chemistry</i> : PROFESSOR JAS. LEWIS HOWE. <i>Benedict on the Determination of Carbon and Hydrogen</i> : PROFESSOR W. E. ORNDORFF.	779
<i>Books Received</i> .....	779
<i>Scientific Journals and Articles</i> .....	785
<i>Societies and Academies</i> :—	
<i>Anthropological Society of Washington</i> : DR. WALTER HOUGH. <i>Philosophical Society of Washington</i> : CHARLES K. WEAD. <i>Biological Society of Washington</i> : DR. WILFRED H. OSGOOD. <i>Torrey Botanical Club</i> : PROFESSOR EDWARD S. BURGESS.....	786
<i>Discussion and Correspondence</i> :—	
<i>The Keeler Memorial</i> : PROFESSOR F. L. O. WADSWORTH. <i>The Larynx as an Instrument of Music</i> : PROFESSOR JOSEPH LE CONTE. <i>The Photography of Fossils</i> : PROFESSOR HENRY S. WILLIAMS.....	789
<i>Shorter Articles</i> :—	
<i>Variation in Light of Eros</i> : PROFESSOR EDWARD C. PICKERING. <i>A Simple Osmometer</i> : E. E. BOGUE.....	790
<i>Current Notes on Physiography</i> :—	
<i>The Texas Region</i> ; <i>The Nashua Valley, Mass.</i> : PROFESSOR W. M. DAVIS.....	791
<i>Current Notes on Meteorology</i> :—	
<i>Monthly Weather Review</i> ; <i>Mean Monthly Rainfall</i> ; <i>Notes</i> : PROFESSOR R. DEC. WARD.....	793
<i>François Quesney</i> : DR. THOMAS WILSON.....	794
<i>Wisconsin Archeology</i> : HARLAN I. SMITH.....	794
<i>Scientific Notes and News</i> .....	795
<i>University and Educational News</i> .....	799

IN the spring of 1900 the city bacteriologist of San Francisco and the quarantine surgeon of the Marine Hospital Service, stationed at Angel Island, San Francisco Bay, made the discovery that the death of a Chinaman had been caused by plague. In accordance with the provisions of the laws governing these two officers in their respective functions, the case was officially reported. Other cases soon developed, and the occurrence of these cases was likewise officially reported. The reports of the quarantine surgeon were published in the Public Health Reports of the Marine Hospital Service in accordance with law and with international agreements. The truth of the reports was at once questioned by the larger portion of the local public press, the objections being partly of a political and partly of a commercial character. A certain portion of the medical profession also opposed the recognition of the diagnosis, and the opinions of these physicians constituted the basis of the denial by the press of the truth of the existence of plague. The diagnosis had been established in accordance with the conceptions of plague as determined by the scientific study of the

disease in the Orient by Yersin and Haffkine, and by the various plague commissions which were sent to the Orient by various European governments for the study of plague; in short, the diagnosis was established precisely as it was in India, China, Japan, Portugal, Alexandria, Sydney and Cape Town; and the fact that the scientific methods, which in the countries quoted are unreservedly accepted as trustworthy and reliable, were in San Francisco disregarded and ridiculed is a sad commentary upon that portion of the medical profession which maintained the negative attitude.

Fearing that the State Board of Health might quarantine the city and that other States might quarantine the city, or even the State, to the vast injury of public and commercial interests, the commercial interests of the city solicited the establishment by the City Board of Health of a quarantine of 'Chinatowu,' the portion of the city occupied by the Chinese in which all the reported cases had occurred. This request was acceded to, and the quarantine was established. At the solicitation of the railway companies, the Marine Hospital Service, through its surgeon-general in Washington, though against the protest of the surgeon stationed at Angel Island, laid a similar quarantine against 'Chinatown.' The public was given to understand that plague was a disease of frightful contagiousness and rapid spread, and that this quarantine was necessary to prevent the spread of the disease through the entire city. The quarantine, though inadequately enforced and obviously ineffective, was quite naturally

obnoxious to the Chinese residents of the quarantined area, and they sought relief in the courts.

In the opinion rendered upon the case, Judge Morrow decided the establishment and maintenance of the quarantine illegal, but marred what was, under the laws, a correct decision by the prejudicial and unwarranted statement that no cases of plague had existed in San Francisco. That the quarantine was, in the light of our knowledge of plague and in the light of the Oriental experiences with the disease, an unwarranted and mistaken procedure is obvious. As a rule plague is not a personal infection, it is a house infection; the best evidence of this fact is the statement of one of the European commissions that about the safest place in Bombay is the plague hospital. As a general rule plague may be said to become a personal infection only when the pneumonic form is prevalent, and even under such circumstances the sensitiveness of the *Bacillus pestis* to sunlight and desiccation renders the infectiousness of the disease much less than is observed with other infections. As stated, the public in San Francisco had been led to believe that plague was a disease of frightful contagiousness; when then the quarantine was raised, and the Chinese population was allowed to go where it chose in the light of the aforestated information, the disease was expected to spread at once through the city. It did, of course, nothing of the sort. And naturally the general public at once lost confidence in the local board of health and in the correctness of the diagnosis.

Following this date fresh cases occurred from time to time, and the occurrence of these cases was officially reported by the city bacteriologist and by the surgeon of the Quarantine Station of the Marine Hospital Service. The public press then began a campaign of personal abuse of Surgeon Kinyoun, the quarantine surgeon of the Marine Hospital Service, though this officer had done nothing but follow his orders and obey the law. Matters dragged on until the opening of the State Legislature. In his message, his Excellency Governor Gage denied the existence of plague in the State and passed severe strictures upon the surgeon of the Marine Hospital Service. A motion was then introduced into the Legislature requesting the National Government to recall surgeon Kinyoun, the implication again being that Dr. Kinyoun had exceeded his authority, a charge which was entirely unfounded, as every other surgeon in the service would of necessity have done exactly as did Dr. Kinyoun. Dr. Kinyoun thereupon demanded an investigation of the hygienic state of affairs in San Francisco. The Treasury Department thereupon sent to San Francisco a special committee composed of men of international reputation as experts in matters of the kind, men entirely without connection with the Marine Hospital Service, and in fact connected with large institutions of public learning. The committee consisted of Professor Flexner, of the University of Pennsylvania, Professor Novy, of the University of Michigan, and Professor Barker, of the University of Chicago.

Upon the advent in San Francisco of

these gentlemen, bills were introduced into the State Legislature making it a criminal offense for any one to report the existence of plague without the confirmation of the State Board of Health, and prohibiting the handling of cultures of the *Bacillus pestis* as prejudicial to the public health; these bills were not pushed, and did not pass; they are mentioned simply to illustrate the mental attitude from which they sprang. It had been previously charged that the bacteriologists reporting the cases of plague had intentionally infected with the *Bacillus pestis* the bodies of Chinamen dead of other causes, in order to bolster up their diagnoses; this absurdly vindictive charge is repeated simply to illustrate to what an appalling extent of mental and moral error prejudice will carry men. The special commission spent several weeks in San Francisco, saw and studied six cases of plague, and presented a report confirming the existence of the disease in the city. On the receipt of the information of the contents of this report, a committee of citizens went to Washington, and an agreement was entered into with the national authorities, that the city of San Francisco and the State of California were to furnish the funds wherewith the section of the city known as Chinatown was to be cleaned and disinfected under the supervision of an officer of the Marine Hospital Service, and this disinfection is now in progress.

That the existence of plague in San Francisco has been of considerable commercial loss to the State is without question. That the misfortune of the occurrence of plague in San Francisco must, in the

nature of things, have been attended with some commercial loss is obvious. The men who have maintained the existence of the disease have the interests of the State as closely at heart as have those who have opposed the diagnosis; they differ in their convictions as to the best and least injurious method of procedure. The men who have maintained the existence of plague reason thus: Plague is here; clinically, pathologically and bacteriologically it has been proved to be here. Under the circumstances the best method of procedure, the one affording the best protection to the public health and the least injury to the business interests of the State, is to acknowledge the truth, undertake energetic measures, and clean and disinfect 'Chinatown' in such a manner as to stamp out the disease at once. The opposition comprises two sets of men. One set does not believe that plague is here, and for them there can be no necessity for hygienic action. Though honest in their convictions, it must be insisted on that the existence of plague is a matter for scientific consideration, and is not within the scope of the judgment of business men. The second class realizes that the disease is present, but reasons that, as there are so few cases and as these are largely confined to Chinese, the situation is not serious and should be concealed in the hope that the disease will die out, and that public recognition and active hygienic measures should be deferred until the conditions become so serious that the public health is gravely jeopardized. The scientists know that there are but few cases, that the general

health is not in serious danger, but believe it better to stamp out the infection while in its infancy, with the attendant small commercial loss, than to wait, in the hope that the disease will die out of its own accord, until the situation shall have become very serious, with the risk of overwhelming commercial losses in the event of a generalization of the infection.

There can be no question that the first course was the correct one. That now, one year after the trouble began, the State is compelled to do what it all along refused to do, undertake the hygienic renovation of 'Chinatown,' is an obvious proof of the correctness of the frank and open course. Had the Chinese section been promptly and effectively cleaned one year ago, the disease would have been stamped out at little cost, and the episode would have been ere this forgotten. At present the pall still hangs over California, and there is a general distrust of her on the part of the other States. We trust that the present measures will prove effective, and that the State has escaped the occurrence of a serious epidemic; but this escape will have been purely accidental, and in matters like these a community has not the right to trust to the fortune of chance.

Conditions have apparently not been favorable to the immediate spread of the disease. This is, however, an old experience; in many places and at many times the plague has dragged along for a long while, only to suddenly flare up into an active epidemic. The recent experience in Cape Town is a fresh illustration. The plague has been present and dragging along in

Cape Town for eighteen months; on account of the military situation, its effective eradication was neglected, and now the disease has roused into active form. It is this risk which San Francisco has been running, and this risk no community has the right to assume.

*THE DESTRUCTION OF SEA LIONS IN CALIFORNIA.*

PROFESSOR WOODWARD'S wholesome address on the necessity of verifying theories by the observation of facts finds an excellent illustration in the sea lion question in California. These animals, which have long been prized by lovers of nature as one of the great attractions of the coast, have fallen into disrepute among the fishermen because their presence was supposed to account for the deterioration of certain fishing grounds. So confident was the belief in their fish-devouring habits that their destruction—or at least a great reduction of their numbers—was advocated and in part accomplished by the State Commission of Fisheries. But it now appears that this belief was without substantial foundation. The appeal to fact has been made by the critical examination of the stomachs of slaughtered sea lions, and it has been found by Professor Dyche that the twenty-five animals examined had eaten only squids and other cephalopods, eschewing fish altogether. The case is suggestive of the old philosophical puzzle: Why is it that a live fish adds nothing to the weight of a bucket of water? and would be amusing but for the sad fact that the unfounded theory has already led to the killing of many of these graceful creatures.

The investigation of food-habits by means of stomach examination is of far-reaching importance. Dr. Merriam, whose letter on sea lions we print on another page, is engaged, through the Biological Survey, in the most elaborate

study of animal foods ever made. For many years the stomachs of wild birds and mammals have been systematically collected and laboriously studied, to the end that the favorite and the occasional foods of each species in each season of the year, and in each part of the country, may become known. As each group is worked up the facts are published by the Department of Agriculture, and farmers and legislators are thus informed what species may properly be regarded as friendly, and what as hostile, to the interests of the people. In many instances it has been found that popular impressions, almost necessarily founded on a comparatively small number of facts, are altogether erroneous, so that war has been waged on our friends and protection given our enemies. \*

*ON THE VITAL ACTIVITY OF THE ENZYMES.\**

IN spite of the vast amount of work that has been done on the soluble ferments, since the discovery of diastase by Kirchoff, in 1814, the exact chemical nature of these substances is, perhaps, even more of an enigma to-day than the nature of albumen itself. Indeed, beyond the fact that the enzymes, or at least the greater number of them, are albuminous, that they probably belong to the group of nucleo-proteids and that they contain phosphorus, and probably iron, in addition to carbon, hydrogen, oxygen and nitrogen, we know but little more concerning their exact chemical composition than was known to Payen and

\* In slightly different form this paper was read before the Cincinnati Section of the American Chemical Society, December 15, 1900.

Many of the biological memoirs referred to in the following were inaccessible to the writer in the original. He, therefore, desires to acknowledge his indebtedness to the following authorities: 'The Soluble Ferments and Fermentation,' Green; 'Die Fermente und Ihre Wirkungen,' Oppenheimer; 'The Cell in Development and Inheritance,' Wilson; 'Plant Physiology,' Sachs; 'Plant Physiology,' Pfeffer; Hueppe's 'Principles of Bacteriology,' Jordan.

Persoz in 1833, or to Bussy, when in 1840 he wrote that up to that time it had not been possible for him to obtain myrosin in crystalline condition. Apart from this uncertainty respecting their chemical composition, however, there has been a growing conviction in the minds of many most familiar with the peculiar and remarkable properties of these substances, that in the soluble ferments we have to deal with certain subtle and peculiar activities similar to those manifested by the living organism itself. The idea that the enzymes retain at least some vestiges of the original activity of the cell or organ of which they once formed a part is one that has appeared again and again in the scientific literature of the last twenty years with a curious persistency and under almost as many different guises as the proteid molecule itself is supposed to assume. According to Loew,\* who was probably the first to advance any ideas of this kind, the enzymes are to be regarded as *active* or *labile* proteids or peptones, the activity of which is probably traceable to the presence of amido and aldehyde groups in the molecule, and whose instability is in some way connected with various molecular rearrangements involving these groups. He has also pointed out that many of the so-called protoplasmic poisons are just such substances as are known to readily attack amido and aldehyde groups in organic molecules, and it was in this connection that Loew first called attention to the silver reduction test as a means of distinguishing between active and inactive ferments and dead and living protoplasm. According to Loew† the conversion of the albumin of living into that of dead protoplasm presents a remarkable analogy to the transformation of an unstable substance into its stable modi-

fication. Such a transformation, for example, as is met with in the change of the yellow iodide of mercury into the more permanent red variety of this compound.

In the same way Medwedew,\* like Loew, has found it necessary to assume that certain of the enzymes at least possess a residuum, as it were, of the vital forces of the living cell; and finally Armand Gautier† has gone even further in his assumptions and has taken the extreme view that the enzymes are to be regarded as *dissolved cells*, and that in addition to their other remarkable properties, they possess in common with other cells the power of assimilation and reproduction. Remarkable and suggestive as these ideas certainly are, they do not seem to have met with anything like general acceptance at the hands of biologists; indeed, in certain quarters, at least, they have encountered a very vigorous and decided opposition, and by some have been pronounced as far too vague to constitute even a satisfactory working hypothesis.‡ Apart from the fairness and justice of this criticism, there can be no doubt that, in his earlier work upon this subject, at least, Loew was inclined to lay too much stress on the silver reduction test as the basis of a sharp and accurate distinction between *active* (living) and *inactive* (dead) proteid; and while the terms *splinters of protoplasm* and *dissolved cells* may appeal very strongly to the poetical side of our nature, it cannot be denied that they are far too hazy to express with any sharpness of definition a scientific truth.

On the other hand, it would seem to the layman, particularly if he happen to be a chemist, that the whole trend of modern biology, until very recently at least, has been toward form rather than substance, and that all of the efforts of the biologist to

\* Pflüger's *Archiv.*, 27 (1882), 203, and 36 (1885), 170.

† Pflüg. A., 65, 249, 1897.

\* Pflüg. A. 65, 249, 1897.

† See Effront, 'Les Diastases.'

‡ See Pfeffer's 'Plant Physiology,' 67, 69, 1900.



account for vital phenomena have been directed to the vital mechanism to the exclusion of the material substratum.

Indeed, it is not an uncommon thing to see the argument advanced that on account of their instability we can never hope to learn very much concerning the chemistry of those substances entering immediately into the composition of the living cell, for the reason that any attempt at their isolation from the cell contents at once results in their decomposition or permanent alteration. And yet the fact remains that even now at least fifty apparently distinct and different substances are known apart from, and independent of, the cell, which, in addition to some peculiar and characteristic property, such as the power to convert starch into sugar or split a fat into glycerin and a fatty acid, possess many of the more general properties and activities of the cell itself. These substances are the soluble ferments. In two very recent communications on the subject Bokorny\* has given us some additional evidence of the sensitiveness of the enzymes and some additional reasons for believing in the inherent similarity between these substances and protoplasm. According to Bokorny, the sensitiveness of the ferments and their general similarity to protoplasm are to be observed in their conduct towards heat, light and the protoplasmic poisons. He therefore reaches the conclusion that the enzymes are substances similar to protoplasmic albumen, and that in all probability the two are only to be distinguished by the fact that the enzymes are wanting in organization. As the result of some recent work on certain aspects of enzyme action, the writer has been brought to see the necessity of these or similar conclusions from a somewhat independent standpoint; and, aside from their extreme instability and their delicate sensi-

tiveness to their physical environment and to chemical reagents, the conclusion that the enzymes are active, in the sense of retaining certain of the vital activities of the living cell, would seem to derive considerable support from the following considerations:

First, their widespread and universal occurrence in all living things.

Secondly, their importance and necessity in metabolism.

Thirdly, their mode of origin.

Finally, in what follows it will be pointed out that the ferments exhibit a remarkably close analogy to the living non-nucleated fragments of the cell.

Since the discovery of diastase, in 1814, a large number of enzymes have been recognized, and what is of still greater interest and physiological significance, a large number of them, such as diastase, lipase, trypsin, etc., etc., have been found in both the vegetable and the animal organism, and, for that matter, in nearly every living cell. By means of diastase, starch is rendered available as a food-stuff both to the animal and to the plant. Trypsin occurs not only in the digestive fluids of the intestines, but is also found in the pineapple and the leaves and sap of the *Carica papaya*. The fat-splitting enzyme has been found not only in the pancreatic secretion, but also in the blood and liver and in nearly every organ and tissue of the hog. Its presence also has been proved in many seeds and seedlings. Myrosin, the mustard ferment, is found not only in the many species and varieties of Crucifere, but in many other natural orders of plants as well. Emulsin is another enzyme of the widest distribution in the vegetable kingdom. It has been aptly said, therefore, concerning the occurrence of the enzymes, that 'wherever life exists there also occurs the enzyme.' The one is the inseparable companion of the other. It is in connection with growth

\* Chem. Ztg., 24, 1113-1114, Dec. 19, 1900; Chem. Ztg., 25, 1136-1138, Dec. 26, 1900.

and metabolism that the importance of the soluble ferments to the vital economy is seen to the greatest advantage. According to Thompson,\* "The power of growth, of adding to itself substance of the same nature as itself, is the real mystery of living matter." So far as is known at present, it is mainly with growth that the enzymes are concerned. As a general thing they effect those changes which have to do with nutrition, *i. e.*, with the digestion and assimilation of food on the part of the organism. As a rule the enzymes bring about hydrolytic cleavages, the net result of which is to transform insoluble and non-absorbable reserve or food materials into absorbable and assimilable form. The transformation of starch into sugar, the change of inulin into levulose and that of cellulose into glucose, the hydrolysis of fats and the conversion of albumen into peptone, are all important and interesting examples of enzyme action. That the enzymes can also effect certain polymerizations and syntheses seems scarcely to admit any longer of a reasonable doubt; indeed, it seems not improbable, in the light of our present knowledge, that many changes hitherto looked upon as resulting from the vital activity of the living cell itself may in reality be accomplished through the instrumentality of a ferment. † Indeed it has been found that the soluble ferments stand in the closest possible relation to the vital activities of the animal and the plant. For example, Maquene ‡ has recently pointed out that the predominating, if not the only, rôle in the conservation and development of seeds must be attributed to the enzymes, and that

\* 'The Study of Animal Life,' J. A. Thompson, p. 138.

† See the work of Croft Hill 'Reversible Zymohydrolysis.'—*Jour. Chem. Soc.*, London (1898), Trans., 634. Also, the work of Kastle and Loevenhart on the Synthesis of ethyl butyrate by lipase.—*Am. Chem. Jour.*, XXIV., 491-525.

‡ *Ann. Agron.*, 1900, 26, 321-332.

the causes which retard the alteration and activity of the enzymes tend to maintain the germinating powers of seeds, and that, when preserved under conditions favorable to the enzymes remaining inactive, seeds may be kept indefinitely.

In this connection Sachs\* long ago pointed out that the so-called dormant periods of seeds and buds are probably intervals during which the necessary ferments are being produced in the cell. The vital relation of the enzyme to the living cell is also indicated by the fact that the ferment is often produced by the cell to meet some new necessity arising from a change in external conditions or environment. For example, it has been found that the molds produce no diastatic or proteolytic enzymes so long as they are freely supplied with sugar. When cultivated on an albuminous medium, however, they speedily develop a proteolytic enzyme and on starch they soon produce diastase, and in the same connection Bernard has observed that the larva of one of the common flies, *Musca lucilia*, contains a large amount of glycogen, but no diastase. As soon as the larva passes into the chrysalis stage, however, where the glycogen is required, a diastatic ferment at once makes its appearance.

Apart from the production of several of the enzymes from their corresponding zymogens by the action of dilute acids, no enzyme has ever been produced outside of the living cell. In this connection it will be recalled that the zymogens are the mother substances of the ferments and that they in turn have never been produced outside of the living cell. In the light of these facts, the mode of origin of the ferments becomes a matter of considerable interest and importance. It has been proved that just as the nucleus and cytoplasm both participate in the formation of new cells by cell-division, so also both participate in the

\* Sachs' 'Plant Physiology,' 1887, p. 352.

formation of the zymogen granules, and that these, in turn, ultimately give rise to the soluble ferments. In this connection, it might be well to recall the interesting histological investigations of Heidenhain on the pancreas of the dog during the different phases of nutrition. In the case of a dog that had been fasting for a little over one day, each cell of this gland was seen to consist of two zones. The inner zone, abutting on the lumen of the alveolus, was observed to be much the larger of the two and to be thickly studded with fine granules, while the outer one, towards the basement membrane, was narrow and its substance clear and homogeneous. The nucleus of the cell was observed to be considerably shrunken and corrugated and to lie at the border of the two zones. In a pancreas of another dog, that had been killed during full intestinal digestion, the same two zones were visible. The inner granular zone, however, was much contracted and the granules much less numerous, whereas the outer hyaline zone was much wider. The cell, as a whole, had become smaller, the nucleus had regained its spherical shape and was situated near the center of the cell. These changes in the cells were observed to repeat themselves during the several phases of digestion. In the same manner other observers have been able to demonstrate a close connection between the degree of granularity of the cell and the amount of enzyme secreted. In studying the secretion of diastase by the scutellar epithelium of germinating barley, Brown and Morris were able to determine that when the secretion of diastase had ceased the marked granularity of the cells had also disappeared, and, what was even more remarkable, the nucleus of the cell had disappeared also. It would seem, therefore, that for each enzyme there exists in the gland cell a distinct antecedent substance or zymogen, ready to be transformed

into the ferment the moment the latter is required. That these zymogens are not enzymes has been proved by Langley, for pepsin at least, in the most masterly and convincing manner; and the same thing has been shown for other zymogens by other equally competent observers.

The most important histological studies on the formation of the zymogens have been made by Macallum. By employing nuclear stains he was able to make out that during the formation of the zymogen a part of the chromatin of the nucleus was extruded into the cytoplasm of the cell in the form of a substance which he calls prozymogen. On coming into the cytoplasm it unites with some component thereof, as the result of which combination the granules of zymogen are produced. These granules were observed to gradually increase in size, apparently at the expense of some substance in the cytoplasmic portion of the cell. It will be observed that Macallum's view of the formation of the zymogen granules enables us to understand the shrinking and disintegration of the nucleus during secretion. It should be borne in mind, however, that in the formation of the mother substance of the ferment both nucleus and cytoplasm supply their quota.

This view of the formation of the zymogens strongly supports the conclusion that the enzymes retain a part, at least, of the original activity of the living protoplasm. In the formation of a new cell or an individual, the cell nucleus and the cytoplasm, of either the same or different cells, are involved. We have just seen, however, that in the production of the zymogen granules both the nucleus and cytoplasm participate. If, therefore, we look upon the cell nucleus as the formative and directive force in the one case, it would seem logical to so regard it in the other, the only difference being, that while upon the one hand its energies go to the forma-

tion of a new cell, on the other, they are consumed in the synthesis of an exceedingly active compound. So that scrutinize the matter as carefully as we may, we are able to see no break or discontinuity anywhere between protoplasmic activity on the one hand and the activity of the enzyme upon the other, and, originating as they do, it would be very strange indeed if the enzymes were found to be inactive substances. In this connection Langley's view on the relation of pepsin to the gland cells is highly suggestive. He says, I conceive the matter thus: "The protoplasm of the gland cells does not at one swoop form zymogen as it occurs immediately previous to its conversion into pepsin, but forms certain intermediate bodies in which the zymogen radicles become more and more isolated. Since the zymogen contains the radicle of the ferment, the ferment will be obtained with greater difficulty from the imperfectly elaborated zymogen, *i. e.*, as we ascend from the final meso state to protoplasm, the ferment will be split off less and less readily. The last traces of the ferment, then, which are obtained by repeated extractions, I take it, arise from substances which are on the way to be converted into zymogen."\* From such clear and beautiful reasoning it is but a short and logical step to the modern view of Reynolds Green,† who sees in the power to produce fermentation a fundamental inherent property of protoplasm; and who sees in the secretion of a particular enzyme 'a mark of differentiation within the living substance, just as in the slow movements of amoeboid protoplasm we recognize something which in the higher and more differentiated organism appears as the contraction of muscular fiber.'

The general conduct of the enzymes is

\* 'The Soluble Ferments and Fermentation,' Green, p. 384.

† 'The Soluble Ferments and Fermentation,' Green, p. 371.

such, therefore, that if, in addition to their other properties, we could invest them with morphological characteristics and with the power of growth and reproduction, even the most conservative would, I take it, be inclined to place the soluble ferments in the category of living things. If they possess morphological characteristics, however, these are beyond the reach of the highest magnifying powers in our possession to-day; and while the enzymes exhibit certain recuperative tendencies,\* they have never been made apart from the zymogen granules or the living cell, and while in perfectly dry condition they are fairly stable under ordinary conditions, their solutions speedily deteriorate, and only in a very few instances has there been observed any spontaneous

\* The tendency on the part of the enzymes to regain their activity after they have once lost it, for any cause, is very suggestive in the light of these considerations. Bussy in his investigation of myrosin long ago pointed out that after the activity of this ferment had been destroyed by small amounts of ether or weak acids it regained the same by remaining in contact with water for 24 to 48 hours.—*Liebig's Ann.*, 34 (1840), 227.

In like manner Bokorny has found that a 0.01-per cent. solution of formaldehyd renders malt diastase inactive for 24 hours without destroying the enzyme altogether.—*Chem. Ztg.*, 24, 1113-1114, 19/12, 1900.

Quite recently Hanriot has observed that serum lipase is rendered inactive by small amounts of free acid. After neutralization, however, the ferment regains its activity. He concludes, therefore, that the acids first combine with the enzyme to produce substances no longer capable of hydrolyzing fats, and that upon neutralization these compounds are decomposed and the ferment regenerated.—*C. R.*, 132, 146-149.

In this connection it is further interesting to note that by treatment with caustic potash Scholl was able to partially restore to blood serum the antiseptic powers which it had lost as the result of heating. At present the germicidal property of serum is believed to be zymotic. Hueppe's 'Principles of Bacteriology.'—*Jordan*, p. 86.

It is further interesting to note in this connection also that during life protoplasm shows a faintly alkaline reaction. Hammarstan's 'Physiol. Chem.' Also 'Lehrbuch der Physiol. Chem.' Neumeister.

increase in the activity of such solutions. Outside of the living cell, therefore, these substances do not seem to be able to grow or to reproduce.

In this connection it has occurred to the writer that the enzymes sustain about the same relation to the living cell as do the non-nucleated cell fragments. It has been proved as the result of numerous observations that, if a unicellular organism be subdivided by mechanical means, each fragment thereof will still manifest vital activity. To the biologist, all these fragments are alive and yet their ultimate fate may be very different. Those that are nucleated have been found to have the power of completely repairing their injuries and ultimately develop into complete cells again and reproduce by cell-division. On the other hand, while the non-nucleated fragments frequently retain their vitality for days, for example, non-nucleated fragments of the amœba have been known to live for fourteen days, they ultimately perish. In some cases the non-nucleated fragments may even heal their wounds and engulf food particles; the latter, however, remain undigested and the fragment ultimately dies without reproduction. In this connection Verworn has pointed out that a nuclear fragment entirely devoid of cytoplasm can no more regenerate the entire cell than can the non-nucleated cytoplasm alone. He is, therefore, of the opinion that the formative energy of the cell cannot derive from either the nucleus or cytoplasm alone, but from both. To him the cell itself, and not merely the nucleus, is the vital unit, the activities of which are contributed to, in part at least, by both the nucleus and the cytoplasm, and that numerous exchanges of material actually go on between them is supported by the most trustworthy histological evidence of the present day. We see thus that in the formation of a new cell, whether by the natural repair of a cell

fragment or by the usual process of reproduction, both the cell nucleus and the cytoplasm are concerned. It has also been shown, however, that both the nucleus and the cytoplasm are concerned in the production of the zymogens and ultimately of the ferments. It would seem, therefore, that the enzyme and non-nucleated cell fragments stand in essentially the same relation to the living cell. Both originate in much the same manner, both lack the power of growth and reproduction, and yet both exhibit certain vital activities. Would it be far from the truth, therefore, to look upon the enzyme as the chemical basis of life?

J. H. KASTLE.

STATE COLLEGE OF KENTUCKY,  
LEXINGTON.

*THE PROGRESS MADE IN ENGINEERING  
DURING THE NINETEENTH  
CENTURY.\**

The progress made in engineering during the nineteenth century, on the one hand, furnishes in itself a reminder of its ultimate dependence upon mathematics and the sciences, and, on the other hand, it attests the fact that its great and growing inspiration has been the welfare of all the civilized world. A hundred years ago but little of engineering worth or prominence was in existence; so little, comparatively, that a glance at contrasting conditions then and now will reveal striking differences.

A century ago traveling in its highest development was limited on land to the horse and coach, covering perhaps a wearisome fifty miles in a day; now a day's travel is eight hundred miles. Then, a trip from New York City to Philadelphia consumed as much time and occasioned more fatigue than one from New York to St. Louis now; or a journey then from New York to St. Louis consumed the greater

\* Read before the Academy of Science of St. Louis on February 18, 1901.

part of a month at best and was considered a greater hardship than a journey to India or China now. Then, the wind furnished the sole motive power for the ships of the ocean, and a voyage took as many weeks as now it does days. A hundred years ago the great canals were not built (one making the route to India as short as was formerly the distance to the half-way point—the Cape of Good Hope); nor monolithic lighthouses erected along the coasts for the safety of ocean voyagers. Then a building three stories in height was unusual; now a sixteen-story building is not uncommon. The century has seen the chaise give place to the horse-car and this to the cable, and finally the electric car with its speedy service brings the office within easy reach of the suburban residence.

The military engineer, while still trained and ready to engage in the fiercest shock of battle, has also developed plans of hasty works to accelerate transportation and the march, to make practicable the temporary entrenchments of the battlefield or the more permanent works of encampment and the siege; and he has perfected to a high degree the many stupendous works of permanent fortification and defense. While in the preceding century architecture was considered a branch of engineering,\* yet in the century just closed they have been definitely divorced.

The mine engineer has developed methods and perfected details, until the total yield of mineral wealth now each year exceeds a thousand millions of dollars, while a hundred years ago it was but a modicum. Copper has been needed for electric purposes and the arts, and he has driven adits and shafts, drifts and tunnels, until some regions are honeycombed in the search for the metal to depths exceeding a mile. The same watchful enterprise char-

acterizes<sup>r</sup> the search for other metals. But by far the most important products of the mine are coal, devoting over seven hundred million tons a year to the countless uses of commercial and industrial life, and more than seventy million tons per annum of iron and steel, whose services in the century's developments are preeminent.

The marine engineer has developed not only the speed of ocean vessels as noted, but their safety and size as well, developing a marvel of steel construction that will contain the lading of a score of barks of a hundred years ago and carry a small city of people across the seas with a safety all but perfect. Less than a hundred years ago the first successful steamboat was built, of 4 H. P. and steaming at a rate of seven miles per hour; now the tonnage of our great steamships reaches 16,000, with a H. P. of 37,000, a length of more than seven hundred feet and a speed of twenty-seven miles per hour, while some military steamboats attain an hourly speed exceeding forty miles. A century ago the tonnage of steamships was naught; now this yearly addition to the commerce of the world is more than two million tons. Since the days of the *Clermont* and the *Savannah*, the marine engineer has been applying new discoveries and evolving improvements, slowly at first and then with increasing success, until the perfected steel giants of to-day cost about four million dollars each, instead of twelve thousand dollars for the sailing vessel of a century ago. And now there are more than fourteen thousand steamships in the world aggregating nearly twenty million tons register—a great world's fleet that, steaming abreast, would cover a width of a hundred miles.

The electrical engineer, within the latter portion of the century, has developed a field felt in all phases of practical progress, ranging from the inauguration of the telegraph of the mid-century and the submarine cable

\* *Vide* 'Science des ingenieurs,' Belidor, Paris, 1729.

of about forty years ago to the enormous electric stations, furnishing power for our expanding industries, turning night into day in our cities and making practicable the great development in electric traffic in urban districts, electric elevators in our stores and electric apparatus of infinite variety everywhere to minister to our needs and comforts. Through the electric transmission of power has a vast field of industry been opened. Through all the ages had great water power been useless because of its remoteness, until the development of electric machinery, suited to the purpose, made practicable the transmission of power, twenty, thirty, forty miles, with much greater distances in prospect. As indications of the inevitable result, witness the busy life in the new cotton mills of the Piedmont regions of the Southern States, or the quickened industries of the Pacific Coast.

The mechanical engineer had invented the steam engine before the beginning of the century just closed, but its development was crude, as shown by the winding and pumping engines, the sun and planet, and beam engines placed in South Kensington Museum to illustrate the practice of that day, engines which were then considered unusual if they developed one two-hundredth part of the power of engines of today; while the total for the world is now not far from seventy million horse-power, which is greater than the aggregate physical power of the total population of the world, even were it possible to exert this power without cessation. And the engine is only one instance of the unparalleled advance; we should also mention such inventions and developments as the cotton-gin and cotton-bailing machinery, the gas and oil engines, the harvester, the sewing machine, the hydraulic press and other hydraulic machinery, the steam-hammer, and countless other labor-saving, epoch-marking ma-

chines of wide import and far-reaching significance, like the printing press, capable now of printing, folding and counting 1,600 eight-page newspapers per minute, where the hand-press a century ago could make not more than four or five impressions in the same length of time.

The metallurgical engineer has added his full share to the increased productive capacity of the world. A hundred years ago only a pitiful modicum of iron and steel was produced, and this with great expense and almost infinite pains. The blast furnaces then were about one-half their present diameter and one-third the height, producing perhaps five thousand tons per annum, where furnaces now will produce thirty to forty times that amount. Wrought iron was produced by the Bloomery, Catalan or other crude direct processes, or by the direct open-hearth fineries of Sweden or Wales; and steel by the Catalan, cementation or crucible steel processes, likewise very expensive and slow. At the present day we have, for the production of pig iron, blast furnaces a hundred feet high, costing seven hundred thousand dollars each; and for the finished product we have the puddling furnace (first introduced by Cort close to the end of the eighteenth century), producing malleable iron, and the Siemens open-hearth and the Bessemer processes (developments of the last half-century) for the production of steel. These last two inventions mark the greatest advance ever made in metallurgical processes, and have made possible the wide range in construction in steel in all the various branches of engineering. Figures are wanting to give the quantity of steel produced a century ago. It could not have exceeded a hundred thousand tons, for fifty years ago Sheffield, then the great steel-producing city of the world, manufactured about fifty thousand tons per year; and the cost of crucible steel, made from Swedish iron, worth sev-

enty dollars, was two hundred and fifty dollars per ton. Now steel is produced at less than thirty dollars; single steel firms produce millions of tons each year, and the annual product of the world is nearly thirty million tons. To show the great growth of this interest, Sir Henry Bessemer illustrated the total production of Bessemer steel of the world by saying that if the product of a single month were made into a solid shaft of one hundred feet diameter it would reach 557 feet high. This illustration of the world's production eight years ago is now equally applicable to the United States alone, nor does it include the production of open-hearth steel, or wrought or pig iron, the total for the world approaching eighty million tons annually. There is hardly any personal, municipal or corporate life, or hardly an enterprise of war or peace, that has not more or less closely connected with its development the use of this remarkable engineering material.

In the domain of the civil engineer progress is none the less marked. Within a score of years there has been developed the tall office and other buildings of the steel skeleton type, where the engineer has had to so design the steel frame that it will support sixteen, eighteen or twenty stories, crowded with busy life and industry, as well as to bear the weight of the walls and the great wind pressures that such high buildings sometimes must sustain; and not only this, but he has so considered and controlled methods and materials in the design and in protecting this all-important steel skeleton from fire that the occupants are safer in them than in the older style of building. Steel bridges have had a longer reign, though less than forty years ago it was considered a very remarkable feat to build an iron bridge whose length of span was 320 feet. Thirty years ago the magnificent steel-arch bridge of our own city, consisting of three spans, with the central

one 520 feet in length, was erected by Captain Eads. Twenty years ago the Brooklyn suspension bridge, of 1,600 feet length of span, was being constructed. Ten years ago the great cantilever bridge across the Firth of Fourth was built, containing two spans of 1,710 feet each. And now there are plans, perfectly practicable, for a suspension span of 3,200 feet, to carry eight railway tracks across New York harbor and to weigh between sixty and seventy thousand tons. In railway affairs the engineer has perfected the problems of transportation as we have seen, until the total mileage of the century is great enough to girdle the world fourteen times. In questions of water supply and sewage all our cities provide systems as a necessity, where a hundred years ago they were the luxuries of the very few, and woefully inadequate at that; and the engineer and the biologist have been collaborators in developing successful methods of preventing danger of contagion from these public utilities. Harbors and docks have been constructed and improved consonant to the spirit of the age. Foundations for great bridges and towering buildings are carried to depths requiring methods and inventions of particular resourcefulness, including the famous pneumatic processes. The development of hydraulic principles has made possible a varied series of achievements of far-reaching significance. Irrigation enterprise, which had been dead for centuries in its ancient home and was dormant even in India, has spread over the arid regions of the globe and is making oases of the waste places of the earth. In only two-thirds of the year one of the small canals of the century transports merchandise of a greater value than have the imports of China, for which the great world powers are so strenuously alert. The construction of the proposed canal from ocean to ocean across Central America will be a stupendous undertaking; humanity has never ceased to



marvel because of the great pyramids, and they have always been considered one of the wonders of the world; but, reckoned at the present cost of masonry, a dozen such pyramids could be built for the expense involved in the Nicaragua Canal. And when it shall be built the engineer may well improve the great waterways of the interior and build fleets of steel barges that can withstand the sea, so that our products can be sent without transhipment from our inland cities to the western coasts of the Americas. Another product of the century of significant import is Portland cement. With the aid of the chemist this material has been so improved and made accessible that now the artificial stone made from it is most widely used and is superior to most natural ones. Furthermore there is the unequivocal indication that, in combination with the all-important steel, many classes of structures of superior characteristics will be designed. Already there have been built many steel and concrete bridges which are a hundred feet in span and more, and for the Memorial Bridge at Washington, maximum spans of this construction are planned to be 192 feet each in length; while the engineer who designed it considered perfectly practicable an alternative plan of similar arches 283 feet in length. Arches of such majestic span are among the imminent constructions of the engineer.

A half-century ago Macaulay said, "Those projects which abridge distance have done most for the civilization and happiness of our species." And yet, since then, transportation facilities have increased many-fold, the first ocean cable had not been laid, nor was the telephone in use, nor other distance-annihilating inventions made. The attainment of results both definite and valuable has been in constantly accelerating ratios through all the broad field of endeavor which marks the

domain of the engineer, viz., the 'direction of the great sources of power' and the development of the boundless resources of materials in nature to the use and convenience of mankind. The effect and value of this art pervade all lines of human interest and of contact, whether following Macaulay's idea of potentially bringing peoples nearer together or in the way (largely developed since his day) of rendering it possible to make life more thorough and intense by the concentration of power and of effort in great centers of activity, which is made possible by engineering structures and developments such as the towering office and industrial buildings of the last score of years; the tremendous concentrated power in steam and electric machinery of the present; the penetrating circulation of life-bringing, waste-removing water, ministering to our cities as does the blood to the body; and other examples of almost infinite variety which would cause amazement were they not so common now.

The glory and the power of the civilization of to-day result from the concentration of forces, both human and material, commanding the resourcefulness of mankind, applying the principles and discoveries of pure science, and developing the resources of nature for this purpose; and such is the degree of successful adaptation already reached, that the span of life of man potentially surpasses the millennial existences of legendary times. 'Better fifty years of Europe than a cycle of Cathay.' And the crowning glory of the measure of achievement thus far reached is that its inspiration is the welfare of the race.

J. L. VAN ORNUM.

WASHINGTON UNIVERSITY.

#### MONAURAL LOCALIZATION OF SOUND.

IN the *Psychological Review* for May, 1901, occurs a detailed account of an investiga-

tion conducted by Dr. Warner Fite and the present writer upon the capacities of auditory localization in a man totally deaf in one ear. The readers of SCIENCE may be interested in a brief statement of the essential facts observed.

The subject of the experiments is a man of thirty, who lost his hearing in one ear during early childhood, as the result of scarlet fever. The present symptoms, as reported by expert clinical test, indicate total nerve-deafness and consequently lesion of the labyrinth. The drum membrane was originally destroyed by ulceration of the middle ear and a scar has now replaced it. The precise condition of the bones of the middle ear cannot be determined. The malleus appears to be intact. The uninjured ear is decidedly more acute than the average, but in no such degree as would warrant the term hyperesthetic.

Without entering into details, the apparatus employed in the experiments may be described as consisting of a mechanical device, whereby noises and tones may be given in various directions and at a constant distance from the subject's ear. The arrangement permits the exact registration, in connection with the surface of an imaginary sphere, of each location from which a sound is given. The instrument permits all the adjustments to be made noiselessly, so that the subject, who keeps his eyes closed during the experimentation, receives no suggestion whatever of the direction from which the sound proceeds. The stimuli used consisted of tuning fork tones, the tones of a Galton whistle and the snapping sound made by sending an electric current through a telephone. The tones of the forks are practically pure. The notes of the whistle are more complex and the noise of the telephone is highly complex, containing a large number of partial tones.

It will facilitate a succinct statement of the results to imagine the subject seated in

the center of a large clock dial placed horizontally. The figure twelve is directly in front, the figure six behind, three is opposite the right ear and nine opposite the left ear, which is deaf. The sounds of which we shall speak first are given at the height of the ear.

Pure tones are almost, if not wholly, unlocalized by this subject. Often he can assign no position whatever to such tones, and, when he does hazard a location, the percentage and character of error show that the process is extremely inaccurate. On the other hand, complex sounds are localized with an accuracy which follows closely the number and audible nature of the partial tones they contain. The one exception to this is the region lying between eight and ten on the face of our illustrative dial. This is the region immediately opposite the deaf ear. To offset this defect the discrimination between positions immediately in front and those directly behind is superior to that of normal persons, for whom this distinction is notoriously uncertain. For the remaining regions, from ten toward the right around to eight, the localizations are only slightly inferior to those of normal individuals. Occasional confusions of the right and left hemispheres occur, which are almost unknown to binaural hearing. But in general, both as regards the character of the error and as regards the amount, the localizations are surprisingly like those of the binaural type.

In normal persons the localization of sounds is commonly supposed to depend upon the differences in the stimulations reaching the two ears. These differences are describable as partly differences in intensity and partly differences in quality. Thus, a sound opposite the right ear, for example, stimulates that ear more intensely than it does the left ear, and, if it be a complex sound, more of its component overtones will be noticeable to the right ear

than to the left, so that qualitatively it will be perceived as different from the same sound when heard directly in front. In the case of monaural hearing it is clear that the intensity of a sound can afford only the most ambiguous information. An apparent change in intensity in such a case may mean change of distance, change of direction, change of actual intensity or some combination of these alternatives. But the single ear is by no means so helpless as regards the detection of qualitative differences due to changes of direction. Our subject himself connected his capacity to localize sounds with this noticed change in quality. His results show that (although in every case he remained ignorant of his success or failure during the experimentation) he possessed to begin with a relatively accurate auditory orientation on the basis of these qualitative peculiarities of sounds due to their direction, and, furthermore, that after gaining a little familiarity with the sounds, his localizations became very accurate. Nor did he seem to find any serious difficulty in determining direction, when the absolute distance of the sounds was varied, nor yet when the absolute intensity was varied. Pure tones he could not localize for they undergo no qualitative modifications by change of direction. Intensity changes are the only ones of which they are susceptible. Slightly complex sounds he can localize fairly. Highly complex sounds, possessing component tones well inside the range of ready detection, he can localize extremely well, save in the region just opposite the deaf ear. The same statements hold for localizations above and below the equatorial plane, to which we have confined our description. The modifications met with outside this plane are all conformable to the fundamental theory of the dependence of the localizations upon qualitative differences in the sounds. The pinna, the meatus, the

bones of the head, etc., all contribute to the production of these qualitative modifications.

JAMES ROWLAND ANGELL.

THE UNIVERSITY OF CHICAGO.

#### FOOD OF SEA LIONS.

THE California State Board of Fish Commissioners during the past two years has taken steps to kill off a very large number of sea lions on the California coast, on the ground that these animals are highly destructive to the salmon fishery. The president of the board, Mr. Alexander T. Vogel-sang, claims that it is not the intention of the board to exterminate the sea lions, but merely to kill '10,000 of the 30,000 that now infest our harbor entrance and contiguous territory.'\* The opinion of observers familiar with the sea lion rookeries is that the number of animals has been greatly exaggerated, and that long before Mr. Vogel-sang has killed the contemplated 10,000 there would not be a living sea lion left on the whole coast. Already many have been killed and, unless public sentiment is aroused to check the movement, some of the most interesting rookeries of the State are in danger of depletion. The Fish Commissioners have employed men to shoot the sea lions, and are loud in their lamentations because the Government light-house reservations have not been thrown open to the slaughter.

The local fishermen, the State Fish Commission and others assert without qualification that the sea lions feed extensively on salmon, and the inference from their statements is that the animals subsist chiefly, if not entirely, on fish. A few years ago, when similar complaints were made against the fur seals, I took the trouble to examine the stomach contents of a large number of these animals, and found to my surprise

\*In letter to Hon. Lyman J. Gage, Secretary of the Treasury, dated San Francisco, June 3, 1899.

that the great bulk of their food consisted of squids, hundreds of whose beaks and pens were found in the stomachs, while in only a few instances were any traces of fish discovered.

In 1899, a well-known naturalist, Prof. L. L. Dyche, of the University of Kansas, spent the months of June, July, August and September on the California coast, at a time when the sea lions were being slaughtered in the alleged interests of the fishermen. Professor Dyche became interested in the question of their food, and took the trouble to examine the stomachs of 25 sea lions, not one of which contained so much as a trace of fish. The region visited extends from Monterey Bay southward along the coast for about 25 miles.

Between June 25th and July 16th, there were washed ashore within three miles of Point Pinos, at the mouth of Monterey Bay, eight sea lions which had been shot, the fishermen said, because they were feeding on salmon. Professor Dyche examined the stomachs of all of these and has given me a detailed record of the contents of each. It would take too much space to print this in full. Suffice it to state that the remains of squids and cuttlefish (*Octopus*) were found in all, and that several were filled with large pieces of the giant squid. Notwithstanding the fact that at the same time and place salmon were being caught by fishermen, not a fish scale or bone was detected in any of the stomachs. Whenever possible Professor Dyche opened the stomachs in the presence of the fishermen, who invariably expressed the greatest surprise at the result. On July 20th, Professor Dyche moved his headquarters southward and established a camp about twelve miles below Monterey Bay, between Point Carmel and the lighthouse, near which is an extensive rookery of sea lions. Between July 20th and August 16th, the stomachs of seventeen additional sea lions were ex-

amined. Eight out of the seventeen were well filled with the flesh of the giant squid; two were gorged with large octopus, while the remaining seven contained pens and beaks of squids, the quantity varying from half a pint to about a quart.

Professor Dyche was told that there were no fish within two or three miles of the sea lion rookeries near his camp, as the sea lions had caught or driven them away. In the face of this statement, he himself caught a dozen rock cod one morning between shore and the seal rocks, and his boatman, George Carr, an old salmon fisherman, caught plenty of rock cod weighing from one to eight pounds each, within sixty feet of the flat rock where from one to 300 sea lions landed each day. The water close to these rocks, where the sea lions had lived for ages, proved to be the best fishing ground in the locality. Professor Dyche states further that he landed a number of times on the rocky islands where in places the excrement from the sea lions formed a layer a foot thick. He hunted through this for fish bones and scales, without being able to discover a single one. On the other hand, the tough pens from the backs of the squids were abundant.

Professor Dyche found the fishermen loud in their denunciation of the sea lions on account of their alleged destruction of salmon, but, although he was on the fishing grounds continuously for more than three months, the fishermen were unable to show him a single instance in which a sea lion had killed a salmon. He adds, "You can hardly imagine the surprised look on these fishermen's faces when they saw the great masses of squid meat roll out of the sea lions' stomachs when cut open."

The fact that sea lions in captivity will eat fish rather than starve has little bearing on the question, and the additional fact that salmon in nets are sometimes found bitten off or eaten is by itself no evidence

at all, particularly in places where either sharks or otters occur.

It is not claimed that sea lions in their native element never eat fish; at the same time the only actual evidence we have on the subject fails utterly to substantiate the allegations of the fishermen. On the contrary, all of the twenty-five stomachs of sea lions examined by Professor Dyche contained remains of squids or cuttle fishes, and not one contained so much as the scale or bone of a fish. And is it not significant that in former years, when sea lions were much more plentiful than now, salmon also were vastly more abundant? If the fishermen will look into their own habits and customs during the past twenty-five years, it is believed that the cause of decrease of the salmon will not be difficult to find, and this without charging the decrease to the inoffensive sea lions, whose rookeries constitute one of the greatest attractions to the visitor on the California coast.

C. HART MERRIAM.

#### SCIENTIFIC BOOKS.

*The Seri Indians.* By W J MCGEE. Extract from the Seventeenth Annual Report of the Bureau of American Ethnology. Washington, Government Printing Office, 1898 [1901]. Pp. 344, with 62 plates, and 42 figures in the text.

Seldom has one to chronicle the appearance of a work so thoroughly 'a contribution to human knowledge' as is this modestly titled essay. Brinton, in his 'American Race' (N. Y., 1891), styles the Seri 'a Yuma folk,' and consecrates a few lines to the enumeration of their not very prepossessing characteristics. Indeed, although these Indians came into contact with the whites in 1530-1540, they remained till towards the close of the nineteenth century perhaps the least studied of all the North American aborigines. The expeditions sent out in 1894 and 1895 by the Bureau of American Ethnology, under the efficient leadership of Dr. McGee, have resulted in the shedding of a flood of light upon one of the most interesting and

remarkable groups of savages on the globe. After a brief introduction dealing with the salient features of the people, geographical nomenclature, etc., come sections on habitat (pp. 22-50), summary history (pp. 51-122); tribal features—nomenclature, external relations, population (pp. 123-135); somatic characters—stature, color, etc., skull, skeleton, pedestrian habit, fleetness and endurance, absence of 'knife sense,' race sense, cheirization, alternation of states (pp. 136-163); demotic characters—symbolism and decoration, industries and industrial products, social organization, language (pp. 164-344). Throughout these pages one is made aware of that noteworthy combination of keenness of perception and aptness of expression, that harmonious unity of the explorer and the recorder, which make the author's anthropological publications rank with the most suggestive and most stimulating scientific literature of the day.

The Seri (the word is Opatá and means 'spry'), or, as they call themselves (by a name including fire and the animal world) *K<sup>m</sup> káak*, 'our-great-mother-folk-here,' inhabit Tiburon Island (some 30 miles in length by from 12 to 20 in width) in the Gulf of California, and a limited adjacent area on the mainland of the Mexican State of Sonora. Two centuries ago they are said to have numbered several thousands, but almost uninterrupted warfare has reduced them to some 350, of whom not more than 75 are adult males or warriors; and, notwithstanding the fact that, under the renewed isolation of the last decade or two, they seem to have rallied their strength a little, or at least to have held their own, Dr. McGee holds out to us no other prospect than the 'early extinction of one of the most strongly marked and distinctive of aboriginal tribes.' In the historical summary the chief events in the contact of Caucasians and Seri, with their terrible results, in so far as the latter are concerned, are outlined, the concessions (now reported) of Seri territory to American speculators may be the beginning of the end. If so, the Seri will not have passed away without meeting an able and sympathetic chronicler. The importance of Dr. McGee's monograph for those engaged in the study of the phenomena of heredity and

environment, of somatic and mental relationship, of tribal and individual expressions, of isolation and *Wanderlust*, of race antagonisms and human affections, of labor and repose, of the matter-of-fact and the mystical, can hardly be exaggerated, since, as he claims, with seeming justice, 'the Seri must be assigned to the initial place in the scale of development represented by the American aborigines, and hence to the lowest recognized phase of savagery' (p. 295). The environment of the Seris consists of the broad Desierto Encinas (the eastern boundary), the mountainous zone of Sierra Seri, Tiburon Island (with adjacent islets), the navigable straits and bays about the islands and the mainland. The mainland is a sort of a dependency, for Tiburon Island (the eastern shore especially) is the real home of the Seris. To their dwelling chiefly on the prolific seashore of Tiburon Dr. McGee attributes the fact that the Seris 'never learned the hard lesson of desert solidarity,' and so have 'held aloof from that communality of the deserts which has brought so many tribes into union with each other and with their animal and vegetal neighbors through common strife against the common enemies of sun and sand—the communality expressed in the distribution of vital colonies over arid plains, in the toleration and domestication of animals, in the development of agriculture, and eventually in the shaping of a comprehensive solidarity, with the intelligence of the highest organisms as the controlling factor' (p. 133). The isolation of the Seris is reflected in their enmity towards aliens—the Papagos, the Yaquis, the Caucasians—an enmity which removes them in thought and life from all contemporaries so that 'they far out-Ishmael the Ishmael of old on Araby's deserts.' The local antipathy is even greater than the race antagonism for the whites, who have been sometimes tolerated for a time as food-bringers or wonder-workers. This antagonism amounts to obsession, and is 'crystallized into a cult'; yet among themselves, we are told, 'they were fairly cheerful, and the families were unobtrusively affectionate'—maternal affection, especially, is strong.

The waters about Seriland, as some of the Spanish names—El Infiernillo, Sal-si-puedes,

etc.—indicate, are very stormy and dangerous to navigation, but 'the fierce currents and frequent storms of the region \* \* \* have undoubtedly contributed to the development of the peculiarly light, strong and serviceable water-craft [balsas] of the aboriginal navigators among the islands' (p. 45). The primary resource of Seriland is potable water, and the springs and water-holes are few and far between. Yet it is the tribal policy (based perhaps on military instincts) to 'locate habitations in places surprisingly remote from running water' (p. 183). This has naturally developed the water-industry, and it is not strange that the Seris 'are essentially and primarily water-carriers, and all their other industries are subordinated to this function.' As remarkable as their conquest of the stormy sea is the Seri invention of an olla or water-jar, which, in so far as capacity is related to weight of vessel, is about twice as economical as the corresponding ware of the Pueblos or the Papagos. These Indians seem to have conquered the desert also in this respect. The basketry of the Seris is likewise of very noticeable lightness.

Among the most striking physical characteristics of the Seris are 'the noble stature and erect yet easy carriage,' the dark color of the skin, breadth and depth of chest, 'slenderness of limbs and disproportionately large size of extremities (especially the feet),' long and luxuriant hair, and 'a peculiar movement in walking and running.' But a single Seri skeleton has been scientifically studied, and the details of the measurements, as given by Dr. Aleš Hrdlička, occupy pages 141-147 of the work under review. The skeletal facts confirm the deductions from the living body as to the slowness of the organism in attaining maturity—somatic growth continues 'throughout an exceptionally long term in proportion to other stages in the life of the individual.' The range of variation in stature, color, etc., is less than is the case with neighboring Indian tribes. The segregative habit and antagonism to aliens—'protean manifestations of race-pride'—amount to what Dr. McGee calls *race-sense*. Indeed, the Seri are so close to each other and so far from all others that a member of the tribe 'can no more

control the involuntary snarl and growl at the approach of the alien than can the hunting dog at sight or smell of the timber-wolf' (p. 155). The pedestrian habit and the adaptation of the body in its movements (simulating almost the antelope) to the needs of progression in a particular environment, are quite remarkable, and the skill of the Seri runners, like their swiftness of foot, is almost incredible—in men, women and children, the pedestrian art is highly developed. Another conspicuous peculiarity of these Indians is 'habitual use of hands and teeth in lieu of the implements characteristic of even the lowly culture found among most primitive tribes.' They practically lack the 'knife sense,' and are, moreover, conspicuously unskilful in all mechanical operations involving the use of tools. Seri warriors are said often to have recourse to tooth and nail in battle.

Except face-painting, which is practically confined to the female members of the tribe (being of blood-marking significance; the 'elder-women' are very prominent), and recalls the markings of animals, decoration or tangible symbolism is rare among the Seris. Not only are these people less advanced in æsthetic development than other American Indian tribes, but they are also 'at the bottom of the scale in the ratio of æsthetic to industrial motives' (p. 176).

A dearth of fishing tackle is also noted, but in the capture of the sea-turtle (a most prominent article of diet), the adaptation of means to ends is beautifully illustrated: 'The graceful and effective balsa is in large measure an appurtenance of the industry; the harpoon is hardly heavier and is much simpler than a trout-fishing tackle, yet serves for the certain capture of a 200-pound turtle; and the art of fishing for a quarry, so shy and elusive that Caucasians may spend weeks on the shores without seeing a specimen, is reduced to a perfection even transcending such artifacts as the light harpoon and fragile olla' (p. 189). The ingenious use of the young or crippled pelican, as an aid in the procurement of food may possibly have been borrowed from other California tribes. The arrow, the weapon of the chase, is, perhaps, even more notably perfected than the

harpoon. Between the arrow and the harpoon, on the one hand, and the fire-drill on the other, there is a remarkable structural homology, the harpoon having been in all probability the primary device. With the Seris, the bow has now replaced the atlatl, or throwing stick formerly in use. In contrast with the arrow, the bow is a rude and clumsy device. The posture of the Seri archer is one of the most remarkable known. The development of the hunt has apparently 'blinded the Seri to the rudiments of agriculture,' and goes far to explain 'their intolerance of all animal associates, save the sly coyote that habitually hides its travail and suckling in the wilderness, and perhaps the deified pelican' (p. 203). The hunting of the horse is an acquisition of post-Columbian date, in which these Indians have developed rare skill.

As to food, the Seris are omnivorous, and their systematic scatophagy—the 'second harvest' of the tuna is carefully stored—gives them almost a bestial character, though in this peculiar practice the beginnings of a thrift-sense and the germs of industrial economy are possibly to be seen. The 'houses' of the Seris are of the rudest sort, merely shelters adapted to the roving needs of the tribe, but it is very interesting to learn that 'placing and fitting of the beams and tie-sticks are accompanied by a chant, usually led by the eldest matron of the group,'—for women are the builders here. The chant is probably a very primitive 'worksong' of the sort Professor Bücher has recently discussed. The absence of the breech-clout (so common an article of primitive clothing) is, Dr. McGee thinks, accounted for by conditions of environment making 'the free-flowing and easily removable apron' of most service as a protective dress. An autochthonous dress of the Seris is the pelican-skin kilt, while as cords, fasteners, etc., fabrications of human hair are abundantly employed.

In so far as their peaceful industries are concerned, the Seris are among the most primitive of known tribes, and 'combine the features of the zoomimic and protolithic stages more completely than any other known folk, and in such wise as to reveal the relations between these stages and that next higher in the series with

unparalleled clearness' (p. 253). Their implements of stone reflect the conditions of their habitat remarkably well.

Seri warfares, like the hunting customs of the tribe, is 'largely sortilagic,' and the warfare of the tribe (devoid of military tactics in the strict sense of the term) is 'merely an intensified counterpart of their chase' (p. 261). To the 'blood-craze' of the hunters corresponds the 'war-frenzy' of the fighters. Poor in offensive and in defensive devices, the Seri Indians, apart from the natural conditions of their habitat, find their effective protection in 'their fleetness coupled with their habitual and constitutional timidity.' The famous 'poison arrows' of the Seris are discussed at pages 255-261, and a description given of the loathsome mess compounded by the medicine-man for tipping them.

The most interesting fact in Seri sociology is 'prominence of the females, especially the elderwomen, in the management of every-day affairs' (house building, transportation of family property, regulation of personal conduct, productive labor, shamanism, proprietary affairs, legislative and judicative functions, etc.). The social unit appears to be the maternal clan, with certain modifications and additions due to the general feeling of the tribe, the clan-mother being the central figure of the group, but the executive power residing in her brothers in the order of seniority. In other words, 'while the personal arrangement of the group is maternal, the appellate administration is fraternal' (p. 275). The contests for the chiefship are sometimes very protracted, but 'the choice really reflects physical force.' The process of adoption, so important generally with primitive peoples, seems 'entirely foreign to the thoughts of the tribe,' only a few sporadic and uncertain cases being on record. Since there is a surplus of women among the Seris, polygamy naturally prevails, although the practice is perhaps incidental and of comparatively recent origin. Of the sexual unions of these Indians the author remarks (p. 279): 'The primary mating of the Seri is attended by observances so elaborate as to show that marriage is one of the profoundest sacraments of the tribe, penetrating the innermost recesses of tribal thought, and interwoven

with the essential fibers of tribal existence. Few, if any, other peoples devote such anxious care to their mating as do the Seri [the author compares them with the Australian aborigines]; and among no other known tribe or folk is the moral aspect of conjugal union so rigorously guarded by collective action and individual devotion.' The premarital tests are severe, and the conditions of the probationary period are such as to demand indubitable proof of control of sexual passion. Of the mortuary customs of the Seris, the most remarkable feature is 'the special dignification of females in respect to funerary rites,' something without exact parallel among other American aborigines. Traces of at least an inchoate belief in a future life, and of strong veneration for, or fear of, the spirits of the departed (matrons in particular), were noted, as indeed is indicated by certain funeral customs.

The Seri linguistic material was submitted to Mr. Hewitt, of the Bureau of American Ethnology, whose thorough-going comparative study (rather too decided, perhaps, in some respects) occupies pages 299-344. The result is to settle the status of Seri speech as an independent tongue, and not a Yuman dialect, as some have thought. Taken altogether, the Seri mind shows itself to be 'local, chance-dominated, exceeding lowly, and especially autochthonal in its contents and workings.' The author's views as to the meanings of the correlation of race-sense and stirpiculture are of great interest to all students of racial and individual development (p. 162): 'Even if the measure of the incarnation of ideals be reduced to the lowest maximum consistent with human knowledge it remains true that the progeny of successive generations are not the offspring of average parents, but of pairs at the perfection and conjugal culmination of their virile and muliebrile excellencies; so that the generations must run in courses of cumulatively increasing racial (or human) perfection, under a general law of conjugal conation.' Well, indeed, do the Seri Indians illustrate the incarnation of primitive ideals, as indeed the Greeks once did, and with not such moral descent as the latter sustained.

Another general fact concerning the Seris, of great importance to the psychologist, and



suggesting at once comparisons with childhood and the phenomena of genius, is the marked alternation of intense activity and complete repose—activity measured by hours, intervals of rest measured by days. Equally noteworthy is the rapidity of change from one state to the other. According to Dr. McGee, "the Seri are at once the swiftest and the laziest, the strongest and the most inert, the most warlike and the most docile of tribesmen; and their transitions from rôle to rôle are singularly capricious and sudden" (p. 156). This throws a new light upon the question of savage laziness and hints how unfair some of the earlier writers have been in picturing primitive man as uniformly inert. This essay is emphatically a valuable addition to the scientific literature about primitive man. The appearance of the author's companion study of the Papagos will be awaited with great interest.

ALEXANDER F. CHAMBERLAIN.

CLARK UNIVERSITY,  
WORCESTER, MASS.

*Verhandlungen der deutschen Zoologischen Gesellschaft auf der zehnten Jahresversammlung zu Graz, den 18 bis 20 April, 1900. Im Auftrage der Gesellschaft herausgegeben von Prof. Dr. J. W. Spengel, Schriftführer der Gesellschaft. Mit in den Text gedruckten Figuren. Leipzig, Verlag von Wilhelm Englemann. 1900. Pp. 170. Preis M. 6.*

The most important matter brought before the tenth meeting of the German Zoological Society at Graz was the report of Professor Franz Ellhard Schultze, editor-in-chief of *Das Tierreich*. The year preceding the report witnessed the publication of several sections of this great work upon systematic zoology, the most notable being that of Labbé upon the 'Sporozoa' and that of Michaelson upon the 'Oligocheta.' That substantial progress will be made in the near future is seen in the fact that the following manuscripts were ready for the press: 'Hydrachnida' by Piersig, 'Halicarida' by Lohmann, 'Nemertina' by Bürger, the first division of the 'Amphipoda' by Stebbing, the 'Palpigrada' and 'Solifuga' by Kraepelin, the 'Libytheida' by Pagenstecher. The following sections are now in the process of edi-

torial revision: calcareous sponges by Breitfuss, the second division of the 'Copepoda' by Giesbrecht and Schmeil, the second division of the 'Decapoda' by Ortmann, the first division of the 'Formicida' by Emery, the 'Pneumonopoma' by Kobelt, the 'Rodentia' by Trouessart, the 'Rhizopoda reticulosa' by Rhumbler, and the first division of the 'Apida' by Friese.

To insure prompt publication of the accumulating manuscript is a problem for whose solution the recommendation is made that a competent 'Superreviser, Secretar, and Bureauchef' be appointed to assist the editorial bureau in matters of terminology, nomenclature and bibliography, and to maintain the unity of this monumental work which the German society has undertaken. Arrangements were consummated whereby in the future the *Tierreich* will be issued conjointly by the Society and the Royal Prussian Academy of Sciences, as will be shown by the title page of future issues.

The principal address of the session was given by Professor Karl Heider on 'Das Determinationsproblem,' a masterly review of the whole subject of experimental morphology. In a second paper Professor Heider calls attention to a new and strange genus of trematodes parasitic in the dolphin. This new type, *Braunina*, is peculiar in possessing a pedicel and a mantle developed to a degree hitherto unknown in the group, while suckers are entirely lacking.

Herr Künkel has investigated the capacity of *Limax* for the absorption of water which enters the body not only through the mouth, but also through the skin by absorption. The volume of the slug may be increased by this process as much as 209% while the specific gravity is correspondingly decreased and feeding activities are suspended until the water is reduced. The consumption of oxygen in respiration was studied and the rate of exhaustion of the air was found to be 0.36 ccm. per hour for each cubic centimeter of the slug's body. The respiratory process is carried on not only in the air-chamber, but also on the surface of the body.

Dr. Hans Rabl finds no evidence to support the ectodermal origin of the pigment cells in embryos of cephalopods. From their first

appearance the chromatophores are found *only* in the mesoderm. They are single cells with a single large nucleus, appearing to be multi-nuclear only when in degeneration they are invaded by adjacent connective-tissue cells. The author explains the expansion of the cells by the contraction of the radial fibers around it and its contraction by the elasticity of the cell membrane.

Other papers are by Herr Thon on 'The Copulatory Organs of the Hydrachnid Genus *Arrhenurus* Dugès'; by Dr. Doflein on 'The Inheritance of Cell Characteristics'; by Dr. Simroth on 'Self-Fertilization in Pulmonates'; by Dr. Escherich on 'The Germ Layers in the Muscidæ'; and a history and description of the Graz 'Zoologisch zoolomische Institut,' by Professor L. v. Graff.

The excursion of this session was made to the Austrian Zoological Station at Trieste founded twenty-five years before, largely through the efforts of Professor F. E. Schultze. Since the retirement, in 1896, of Professor Carl Claus, director of the station for many years, the control of the enterprise has been in the hands of a board representing the leading Austrian universities. With the change has come renewed activity, an enlarged building and increased equipment.

CHARLES A. KOFOID.

UNIVERSITY OF CALIFORNIA.

*A Select Bibliography of Chemistry 1492-1897.*

By HENRY CARRINGTON BOLTON. Section VIII.—Academic Dissertations. City of Washington: published by the Smithsonian Institution. 1901. Pp. iv + 534.

This volume—number 1253 of the Smithsonian Miscellaneous Collections—is the third in Dr. Bolton's 'Bibliography of Chemistry.' It is devoted exclusively to those academic dissertations which have been printed independently, and especially to those from the universities of France, Germany, Russia and the United States. The number of the last is exceedingly small, for it seems not yet to be the custom of most American universities to require the printing of theses for the doctor's degree, although much of this work finds its way sooner or later into periodical literature. About seven thousand

dissertations are catalogued in the volume, about four-fifths of the titles being German, and a large share of the remainder French.

The reviewer has been interested in tabulating the results of an examination of sample pages, scattered uniformly through the book. From this it appears that nearly five thousand of the dissertations are from German universities, slightly more than a thousand from French, and perhaps seven hundred and fifty from the Swiss schools. Of the German universities, Erlangen, Berlin, Göttingen and Leipzig stand first, each furnishing about five hundred titles, while Freiburg and Heidelberg stand considerably lower, and are not very closely followed by Rostock, Tübingen, Jena and Würzburg. Of the Swiss universities, Zürich furnishes about as many titles as Rostock, and Berne as many as Jena. More than half the French dissertations are from l'École de pharmacie de Montpellier, most of the remainder being from Paris and from l'École de pharmacie de Paris, those from the latter being rather more in number than from the former. One hundred and thirteen titles are in Russian, and perhaps nearly as many more are from the University of Dorpat.

This glance reveals to us the position which Germany occupies in the teaching of chemistry, and, if the dissertations of the last few years alone were considered, it would be found that France stands much lower than is shown by the figures above.

Dr. Bolton will receive the thanks, especially of all chemists who are engaged in research, for this addition to his many valuable contributions to bibliography, for it affords access to a very important field of chemical literature, which, for want of an index, has hitherto been practically closed. The original dissertation is often of far more value to the investigator than the re-edited work which appears in the journals. The value of this book is still further increased by reference to those dissertations which are in the libraries of the Geological Survey and of the Smithsonian Institution; and also—this would certainly be missing in no book of Dr. Bolton's—by a very complete index, which fills ninety double-column pages.

While this volume completes the undertaking

begun by the author in 1888, of preparing a 'Select Bibliography of Chemistry,' he has now in preparation a fourth volume, which will afford him an opportunity of supplying omissions in the three already published.

JAS. LEWIS HOWE.

WASHINGTON AND LEE UNIVERSITY,  
LEXINGTON, VA.

*Elementary Organic Analysis, The Determination of Carbon and Hydrogen.* By FRANCIS GANO BENEDICT, PH.D., Instructor in Chemistry in Wesleyan University. Easton, Pa., The Chemical Publishing Co. 1900. 8vo. Pp. 86. Price \$1.00.

The author states in his preface, "Perhaps no analytical operation is at once so fundamentally important and exasperatingly vexatious as the organic combustion. Notwithstanding this fact, save for the meager statements in one or two of the larger books on organic chemistry, no description of the process of the determination of carbon and hydrogen is accessible to most students. As a rule a knowledge of the operation is chiefly obtained by word of mouth.

"This little manual is presented in the hope that the descriptions of processes here recorded will aid in making this method of analysis more familiar and more satisfactory."

The author states that he has had an experience with over two thousand combustions and that in this book he has embodied such modifications of the general method as have been suggested by that experience.

Some idea of the book will be obtained from the following table of contents: Introduction, preparation of oxygen, compressed oxygen, gasometers or gas holders, air, purifying apparatus, rubber tubing and stoppers, combustion furnaces, combustion tubes, oxidizing agents, filling the combustion tube, boats, absorbing agents, absorbing apparatus, cleaning and weighing absorbing apparatus, weight of material used, burning out the combustion tube, general process of the combustion, combustion of nitrogenous substances, combustion of bodies containing the halogens, combustion of bodies containing sulphur, combustion of bodies containing the alkali metals, combustion of difficultly combustible bodies, combustion of liquids and vola-

tile bodies, combustion of explosive bodies, calculation of results, appendix and index.

The book is well printed and of convenient size for laboratory use. For use in teaching students of chemistry the methods of combustion analysis it will be of great value, and even the experienced chemist will find in it many suggestions and new ideas.

W. R. ORNDORFF.

#### BOOKS RECEIVED.

*Cyclopedia of American Horticulture.* L. H. BAILEY, assisted by WILHELM MILLER. Vol. III., N-Q. New York and London, The Macmillan Company. 1901. Pp. xv + 1055-1486. \$5.

*School Geography, Europe and other Continents with Review of North America.* RALPH S. TARR and FRANK M. MCMURRY. New York, The Macmillan Company. 1901. Third book. Pp. xx + 574.

*The Limits of Evolution and other Essays illustrating the Metaphysical Theory of Personal Idealism.* G. H. HOWISON. New York and London, The Macmillan Company. 1901. Pp. xxxv + 396. \$1.60.

#### SCIENTIFIC JOURNALS AND ARTICLES.

*The American Naturalist* for April has as its first article a paper by B. Arthur Bensley, on 'A Theory of the Origin and Evolution of the Australian Marsupialia.' The adaptive modification of their teeth and feet are compared with those of placental mammals, the author concluding that the marsupials were differentiated from Didelphid forms, but adding no evidence to show from what direction they entered Australia. R. M. Strong presents in detail 'A Quantitative Study of Variation in the Smaller North American Shrikes,' and Frank Russell describes 'A New Instrument for Measuring Torsion' in the long bones of the human skeleton, but applicable to other purposes. The valuable series of 'Synopses of North-American Invertebrates' is resumed, the present paper, the fourteenth of the series, by C. W. Haggitt, being devoted to 'The Hydromedusæ, Part I.' The number contains the quarterly record of gifts to institutions, and the appointments, retirements and deaths of scientific workers.

*The Journal of Physical Chemistry*, March, 1901, 'On the Dielectric Constants of Nitrils,' by Herman Schlundt. The fact that solutions

of salts in nitrils are good conductors of electricity makes a determination of the dielectric constant of importance. Hydrocyanic acid was found to have a higher dielectric constant than water. An increase in the size of the molecules of nitrils by the addition of carbon and hydrogen lowers the dielectric constant. 'The Fundamental Equation of a Multiple Point,' by Paul Saurel. 'On a Property of the Pressure-Volume Diagram,' by Paul Saurel. 'Dissociation Studies,' by Wilder D. Bancroft. A study of the equilibrium relations of the three modifications of ethyl-aldehyde.

THE April number (No. 2, Vol. XXIII.) of the *American Journal of Mathematics* contains the following memoirs: 'The Cross Ratio Group of 120 Quadratic Cremona Transformations of the Plane,' by H. E. Slaught; 'Memoir on the Algebra of Symbolic Logic,' by A. N. Whitehead; 'On a Special Form of Annular Surfaces,' by V. Snyder; 'On the Transitive Substitution Groups, whose Order is a Power of a Prime Number,' by G. A. Miller; 'Geometry on the Cubic Scroll of the Second Kind,' by F. C. Ferry.

THE leading article of the May number of *Popular Astronomy* is the concluding one of the series written by Herbert A. Howe, on 'Astronomical Books for the Use of Students.' G. Seneca Jones contributes a discussion of Professor Holden's recent article in *McClure's Magazine*, entitled 'What we Know about Mars'; George C. Comstock an article on 'Establishing a Meridian Line,' and Dr. J. Morrison the third instalment of a series on general perturbations and the perturbative function. 'The New Star in Perseus' is discussed by A. E. Douglass, of the Lowell Observatory, Flagstaff, Arizona, and by George E. Hale, of the Yerkes Observatory, and Professor J. G. Hagen's second chart and catalogue are printed. Observations are reported by David E. Hadden, F. E. Seagrave and Wm. E. Sperra. Dr. H. C. Wilson writes of the approaching total solar eclipse of May 17-18, 1901, accompanying his article by charts showing the path of the eclipse and its track across Sumatra and Borneo. The General Department contains notes upon Amherst College Total Eclipse Expedition, the

Benjamin Apthorp Gould fund, Eros a Double Planet, Astronomy in High Schools, List of Stellar Novæ and So-called New Stars-Book, reviews of Serviss, 'Pleasures of the Telescope,' and Comstock's 'Text-Book of Astronomy,' 'Astronomy in the 20th Century' and the Alvan Clark and Sons Corporation. The usual planet and asteroid notes are also included.

#### SOCIETIES AND ACADEMIES.

##### ANTHROPOLOGICAL SOCIETY OF WASHINGTON.

AT the 317th meeting, held on April 9th, Mr. George C. Maynard exhibited an interesting series of early time-keeping apparatus, consisting of a set of four sand glasses, mounted in a frame, used during the fourteenth century in churches; a water clock; a pewter and glass time lamp; a time candle, and a small coconut cup from Lower Siam, having a perforation; the cup, when floated on a basin of water, sinks in a stated period.

Hon. Edward F. McSweeney, Assistant Commissioner of Immigration, port of New York, read a paper on the immigration question. The paper was accompanied by charts and photographs of racial types. Mr. McSweeney, in discussing the subject of immigration, gave some historical account of the origin and cause of such movements, and, in reference to the tide that early set toward this country, he called attention to the variety of peoples that were represented. In the chart showing immigration by years, the diminution of the influx of foreigners during the periods of industrial depression was most marked. Mr. McSweeney pointed out that the foci of immigration have shifted from northern Europe to eastern Europe, and that the bulk of immigrants are Italian, Slavic and Oriental, of an undesirable class. He fears that the present tendency to concentration in all fields of industrial endeavor may be utilized in connection with the introduction of vast hordes of these aliens to break down labor conditions and wage standards, and suggests that legislation to exclude this undesirable class should be framed. The paper was discussed by Major J. W. Powell, John R. Proctor, and a number of others present.

WALTER HOUGH.

## PHILOSOPHICAL SOCIETY OF WASHINGTON.

THE 535th regular meeting was held April 27th, President Walcott in the chair.

Mr. I. M. Cassanowicz, of the National Museum, presented an interesting paper on 'The Funerary Rites of the Ancient Egyptians.' He said the monuments and remains of ancient Egypt are chiefly of a sepulchral character. The Egyptians believed in a personal existence after death. Their conception of the conditions and localities of the future existence was vague, but these seem to have been patterned after the conditions known in Egypt: the dead formed a nation who worked for Osiris as for a Pharaoh. As the Egyptians could not conceive of existence apart from a tangible substance, a link was needed to connect the *Ka*, the representative of personality, with the world of substantial things; this link was the body, and so its preservation was indispensable.

The various modes of embalming were then described, all involving a process of steeping in natron for 70 days. The bodies of the poor were preserved by soaking in salt and hot bitumen, whence the name 'mummy.' Then followed a minute description of an Egyptian funeral, largely derived from the Papyrus of Ani, a finely illustrated 'Book of the Dead' a facsimile of which is in the National Museum.

The next paper was by Mr. A. L. Baldwin, of the Coast and Geodetic Survey, on 'The Measurement of Nine Primary Bases in 1900.' The bases referred to are those required to control the triangulation which is now being carried both northward and southward from the great transcontinental belt of triangulation in latitude 39°, and will eventually give an arc of the ninety-eighth meridian twenty-three degrees long in the United States. On this triangulation it was decided to measure the bases with considerable rapidity while keeping the accuracy fully up to the requirements of the triangulation. Five sets of base apparatus, namely, the Eimbeck duplex bars and four tapes, were used on each base, about one-fifth of the measurement being made with each. Each set of apparatus was standardized under the field conditions at the first and last base, using the iced bar formerly employed on the Holton Base as the standard. The paper was a state-

ment of the methods of measurements and of some of the results obtained in the field, and closed with a good series of twenty-six lantern slides showing the different forms of apparatus in actual use in the field. The greatest difference between measures of the same base was 20 mm. to the kilometer. The nine bases were measured by a party of ten officers and men in but little more than six months.

CHARLES K. WEAD,  
*Secretary.*

## BIOLOGICAL SOCIETY OF WASHINGTON.

THE 339th meeting was held on Saturday evening, April 20th. Mr. O. F. Cook read a paper on 'The Shading of Coffee,' in which he advanced the belief that there is no basis in reason or observed fact for the common idea that shade is a general necessity for the coffee plant. It was shown that the beneficial effects connected with shade arise only from the protection afforded against drought, erosion and winds, and that in regions not affected by injurious climatic extremes the planting of shade trees is justified from the cultural standpoint only by the increased fertility imparted to the soil by means of the nitrogen-fixing root tubercles of leguminous species. This being the case, it was thought that leguminous fertilizing might be effected by shrubs and herbs yielding edible or otherwise useful fruits and requiring no more space or care than those yielding no direct returns.

Mr. Charles L. Pollard presented a paper entitled 'Some Strange Methods of Plant Naming,' giving a brief review of the various classes of incorrect generic and specific names, and commenting on the practices that have been followed in each case. He discussed particularly the so-called barbaric names of Adanson and Necker; those falsely constructed from classical sources, and those whose meanings are at variance with actual facts. The speaker also discussed the modern tendency to carelessness in the publication of scientific names, and recommended that botanists give united support to some movement in favor of greater exactness in nomenclature.

Dr. Theodore Gill made some remarks 'On the Mode of Progression and Habits of some

Dinosaurs,' contending that the supposed saltatorial habits of forms like *Hadrosaurus* and *Iguanodon* were physical impossibilities. Besides noting that the force of gravity would prevent so much action in such ponderous animals, the speaker also mentioned structural characters incompatible with it—notably the absence of the calcaneum.

WILFRED H. OSGOOD,  
Secretary.

TORREY BOTANICAL CLUB.

At the meeting of the Club on February 27, 1901, the scientific program was introduced by Dr. Britton with a paper 'On some *Senecios* of the Eastern United States.' The critical study of this genus dates from 1893, when Dr. Rusby collected in the Green Mountains a peculiar plant, described but not published in the middle of the century by Oakes and named by him *Senecio Robbinsii*. Dr. Rusby described this plant in the *Bulletin* in 1893.

While working up the genus for the Illustrated Flora 1895-6, Professor Britton found that *Senecio aureus* of Gray's Manual included the six following species: *Senecio obovatus*, *S. discoideus*, *S. Balsamitae*, *S. Smallii*, *S. compactus*, *S. Robbinsii*; besides *S. aureus* with two varieties. Professor Britton showed specimens of the species discussed: 1st, *S. aureus*, common and known by its large cordate basal leaves, growing in wet meadows; 2d, var. *gracilis*, with smaller cordate leaves, considered by Professor Greene a distinct species. Professor Britton had on one occasion observed intermediate forms and thought the distinction not clearly established. Both forms are growing in the Composite beds in the Garden. 3d, var. *pauciflorus*, smaller in every way than *S. aureus*, found in Newfoundland and Labrador; 4th, *S. Robbinsii*, smooth, with thin and jagged leaves, belonging to New England and the Adirondacks; 5th, *S. Smallii*, with long basal leaves and large corymbs of small heads. This occurs in the south, and is reported as far north as Pennsylvania. 6th, *S. obovatus*, with obovate leaves, including two subspecies, the first *elongatus* from the Delaware valley, with the lower portion of the leaves elongated, and smaller heads almost devoid of rays; the second,

*rotundus*, from Tennessee and Missouri, which may be a distinct species. *S. discoideus* and *S. compactus*, are western species, separated by Dr. Rydberg.

Professor Britton quoted from a recently published study of *Senecio* by Professor Greenman, who distinguishes two additional varieties of *S. balsamitae*, *pauperculus* and *prelongus*. Professor Britton said that there was much need of further material and observations in the field of all these forms.

Specimens of the *tomentosa* group of *Senecio* were then shown: *S. tomentosus* of Michaux, common along the Atlantic seaboard as far north as New Jersey; *S. antennarifolius*, found by Dr. Allen and Professor Britton at the White Sulphur Springs in West Virginia. This species is established in the Garden and flowers early.

A peculiar and undescribed species was exhibited collected by Professor Earle in Heury County, Alabama, resembling the *tomentosa* group in general characters, but having no tomentum. This differs from all other species in having the teeth tipped with round glands.

Dr. Britton expressed the hope that field notes on this genus would be made during the coming season.

The second paper, also by Dr. Britton, was on *Eupatorium*, and illustrated the three Linnean species, *E. purpureum*, *E. maculatum*, and *E. trifoliatum*; the first two were collected at Copake Iron Works last summer on a field excursion of the Club. Of these, *E. purpureum*, with thin almost glabrous leaves with sharp teeth, grows in woodland and copses; and *E. maculatum* has leaves thick and rugose, with prominent veins broader and more ovate, and not as sharply serrate as the last; stem rough and spotted; grows in open meadows.

*E. trifoliatum* has been found in the South, as far north as Pennsylvania; it was named by Elliott *E. ternatum*.

The essential distinction of this species is the crenate leaves; the stem is smooth, the leaves narrower and inflorescence often larger than *E. purpureum*.

Dr. MacDougal showed an opened spathe of skunk cabbage found in the Garden, which was greeted as the first authentic sign of spring.

He exhibited an experiment on the force exerted in the swelling of seeds; a strong iron pipe was filled with peas and water, and a test tube inserted in the top. In 24 hours from the time the peas were put in, a pressure was registered of eight atmospheres, or 120 pounds to the square inch, the highest pressure hitherto recorded by this means.

Dr. MacDougal also discussed malformations in *Arisaema*, and showed specimens of *A. triphyllum* with the spathe double or forked, with the spadix divided and flattened or proliferous, and with two leaves from the same petiole. Also *A. dracontium* with the tapering end of the spathe divided into double hood-like forms. He called attention to the fact that early specimens may be infested with a fungous growth which causes the hood to stand erect.

EDWARD S. BURGESS,

*Secretary.*

#### DISCUSSION AND CORRESPONDENCE.

##### THE KEELER MEMORIAL.

PROFESSOR KEELER'S sad and sudden death last August came as a great and unexpected shock to his many friends and admirers. Of his work and life it is unnecessary to speak here; it has been sympathetically and ably described by Campbell, by Hale, by Brashear, by Perrine and others. The whole scientific world has united to mourn his loss, both as a colleague and as a friend. But nowhere has his death been more keenly felt than among his many friends and associates whom he formed while connected with the Allegheny Observatory. It was here that he began his scientific career as assistant to Professor Langley, and it was here, as Langley's successor, that he subsequently accomplished much of the work that has rendered his name famous.

It seems therefore particularly fitting that the new Allegheny Observatory, the first plans for which were drawn by Keeler, should contain a memorial to his memory. When the news of his death was received we arranged to have his name placed on the frieze of the new building among the names of other great American astronomers of the past. But some more special tribute is needed to mark our appreciation of his high attainments as a scholar, of his dis-

tinguished services not only to our own observatory, but to the whole scientific world, and last but by no means least to his noble character as a man.

Keeler's last great work, the work upon which he was still engaged when death so suddenly cut him down in the prime of life, was being carried on with the Crossley reflecting telescope, an instrument which for the first time under his able management was being made to demonstrate its possibilities. It is proposed, therefore, to erect the 30-inch reflecting telescope of the new Allegheny Observatory as a peculiarly fitting memorial to his memory; one which he himself would prefer to any monument or statue. The suggestion has met with much favor among his many friends, and a fund is now being raised to carry it into effect.

We desire to make this memorial a general rather than a local tribute to Professor Keeler. A number of voluntary subscriptions have already been promised, and many of his scientific friends and colleagues from other institutions have expressed a desire to contribute. We feel sure that there are many others that only await an opportunity or an invitation to join the movement, and I have therefore written this notice to bring the subject to their attention. Those who wish to subscribe to the fund will kindly send their names and the amount of their subscription to Mr. John A. Brashear, chairman of the Observatory committee, or to the writer. All contributions will be acknowledged from time to time in SCIENCE. If the fund raised exceeds in amount the estimated cost of the memorial telescope, which is \$10,000,\* the balance will be used either to found a general fellowship for the study of astrophysics, 'the Keeler Fellowship,' or for the award of a 'Keeler Medal' for work in the same field, as the majority of the contributors may decide; the award in either case to be made by the Astronomical and Astrophysical Society of America or some other scientific body equally representative of general interests.

We hope all scientific men will join us in this effort to do honor to the name of one who did so much for the advancement of knowledge in

\*It is expected that at least this amount will be subscribed here in Pittsburg and Allegheny alone.

his chosen field of work, who was so broadly sympathetic in his views, and who endeared himself to so many by his personal character and attainments.

F. L. O. WADSWORTH.

ALLEGHENY OBSERVATORY,  
May 1, 1901.

#### THE LARYNX AS AN INSTRUMENT OF MUSIC.

I SEE in the last number (April) of the *American Journal of Science* an excellent paper by Professor Scripture on the 'Nature of Vowels.' After a graphic analysis of these sounds, he criticizes with much acuteness the views of other writers. Of this I have nothing to say, except that I have been greatly interested. But in the last paragraph he concludes that the so-called vocal cords cannot vibrate in the manner of strings nor of tongues of reed-pipes, but must vibrate *compressively* in the manner of *elastic cushions*.

Now I write this to say that somewhat similar views have been expressed by me in my class lectures on comparative physiology for 25 years, although not published until last year in my book on 'Comparative Physiology and Morphology of Animals.'

On p. 210 of that work, speaking of the *larynx as a musical instrument*, after showing that it cannot be likened to a stringed instrument nor to a reed-pipe, I say: "It is strange that no one has thought to liken it to an ordinary *horn*—a stage horn, or better, a *French-horn*. In this instrument the sound is modulated exactly as in the larynx, viz., by the *tension* and the *pressing together* of the *lips of the performer*. The edges of the *rima glottidis* ought to be called the *vocal lips*—as indeed they are, and not the *vocal cords*—which they are not in any sense. The analogy between the two instruments is perfect. The performer on the horn presses his lips together tighter, makes them tenser and the opening between them smaller, in proportion as he desires a higher note. He then drives the air between the tense lips so as to set their edges in vibration. This vibration, by alternate partial closing and opening of the aperture, gives rise to *successive jets or pulses of the out driven air*, and this in its turn gives corresponding pulses to the air in

the sounding cavity of the horn. Precisely the same, as we have seen, takes place in the larynx. The only wonder is that so small an instrument as the larynx and the mouth-cavity should be capable of such marvelous effects.'

It is true I do not say anything about '*compressive vibrations*,' but I think there can be no doubt that the nature of the vibrations in the two cases is identical.'

JOSEPH LE CONTE.

BERKELEY CAL., April 24, 1901.

#### THE PHOTOGRAPHY OF FOSSILS.

TO THE EDITOR OF SCIENCE: In the current issue of SCIENCE (May 3, 1901), p. 710, report is given of a paper read before the New York Academy of Science by Mr. Gilbert van Ingen, on 'A method of facilitating Photography of Fossils.'

It may be of interest to your readers to know that a patent covering the process there described was issued in December 1899, and a company, the 'Scientific Photograph Company,' under the business management of Roger H. Williams (Address 28 East 28th St., New York) has been formed to execute orders for the preparation of illustrations by this patented process. The results obtained are successful in reproducing the most delicate details of the form of opaque objects of all kinds in which accuracy is demanded. The process eliminates both the interpretation of the artist and the distorting effects of color and uneven reflection of natural surfaces, and is proving of great value as a means of reproducing, in publications, the exact form of fossils and other objects.

HENRY S. WILLIAMS.

YALE UNIVERSITY,  
May 7, 1901.

#### SHORTER ARTICLES.

##### VARIATION IN LIGHT OF EROS.

THE range of variation in the light of Eros, which has been diminishing during the spring, has now become zero. In February, 1901, it was found by European astronomers to amount to 2.0 magn. Observations by Professor O. C. Wendell, with the Harvard Equatorial, showed that the range on March 12, 1901, was 1.13



magn.; on April 12 it was 0.40 magn., and on May 6 and 7 it was imperceptible and apparently less than 0.1 magn.

EDWARD C. PICKERING.

HARVARD COLLEGE OBSERVATORY, May 8.

#### A SIMPLE OSMOMETER.

THE end of a thistle tube is drawn out, broken off and closed temporarily with wax. The bulb is then filled with molasses and a piece of pig's bladder,\* is securely but loosely tied over the



mouth. The wax is removed from the end of the stem and the end well fused. Two thicknesses of strong linen are tightly drawn and securely tied over the membrane to take the strain. The bulb is then placed in water, when in a few minutes the column of liquid becomes higher and the air column compressed by the osmotic action through the membrane.

In two or three days the maximum pressure is obtained, then the length of the air column is taken. The air in the stem is allowed to

expand to its normal condition by puncturing the membrane with a needle and the length of the air column measured; which length, divided by the length under compression, gives the pressure in atmospheres.

The greatest pressure I have yet obtained with an apparatus of this sort is the expansion of 1.5 cm. to 13.2 cm., showing a pressure of 8.8 atmospheres, or 668.8 cm. of mercury, or 129 pounds per square inch.

The highest pressure I find recorded for Pfeffer's cell is 436.8 cm. mercury.\*

The air column after expanding will not be so long by six to eight per cent. as it was before compression, showing that some of the air has been absorbed by the liquid.

The accompanying figure will serve to show how the apparatus is arranged.

E. E. BOGUE.

LABORATORY OF PHYSIOLOGICAL BOTANY,  
HARVARD UNIVERSITY, April 16, 1901.

#### CURRENT NOTES ON PHYSIOGRAPHY.

##### PHYSICAL GEOGRAPHY OF THE TEXAS REGION.

THE third folio of the Topographic Atlas of the United States is entitled 'Physical Geography of the Texas Region' by Hill. It may well serve as a type of many to follow. Twelve folio pages are given to text, chiefly concerned with an explanation of relief and drainage; then follow a sheet of nine climatic and other diagrams, four sheets holding 22 photographic views of typical landscapes, five sheets presenting 24 small topographic maps of typical reliefs and streams, and finally a folded map of Texas drawn under Hill's direction by Selden and Johnson on a scale of 25 miles to an inch with contours every 250 feet. The imperial area of the 'Texas region' is indicated by the statement that each of more than twenty physiographic subdivisions has an extent equal to that of an average State. Mountains, plateaus and plains, canyons, valleys and waste-floored basins (bolsones) are described in so great variety that selection for special remark is difficult. Descriptions are marked by a thorough-going adoption of explanatory methods, such as have always found ardent ad-

\* These bladders may be obtained of Kny-Scheerer Co., 19th street and 4th Avenue, New York City. They are clean and dry like parchment, and cost ten cents each or one dollar per dozen.

\* Goodale's 'Physiological Botany,' Vol. II., p. 229.

vocacy in Hill's writings. Terminology is largely flavored with words of Spanish origin, taken from the language that was once general and that is still familiar towards the Rio Grande. Plains are classified as constructional and destructional; the first being the result of accumulation, the second of denudation. Constructional plains are either sea-made or land-made; the latter including many examples of surfaces covered by the coarse or fine wash from higher ground. The destructional plains here found are usually 'stratum plains,' that is, surfaces of hard strata from which weaker overlying strata have been stripped; and of these three sub-classes are given, mesa plains, dip plains, and cut (or dissected) plains. Paleoplains is suggested as a name for buried destructional plains, but the word is objectionable etymologically; ancient plain may serve instead, as all the other classes of plains are indicated by adjectives. The descriptions of the Texan rivers show clearly enough that the conventional idea of a river as a constant current of water needs many modifications to fit it to regions of moderate rainfall and plentiful rock waste.

#### THE NASHUA VALLEY, MASS.

THE 'Geological History of the Nashua Valley during the Tertiary and Quaternary periods' is discussed by Crosby (*Technology Quarterly*, Boston, XII, 1899, 288-324, 2 maps, 2 pl.). The lower lands of eastern Massachusetts are regarded as parts of a Tertiary peneplain, eroded beneath the uplifted Cretaceous peneplain of the central and western uplands of Massachusetts; the remnants of the latter form hills on the former. Previous to the Tertiary erosion, a coastal plain of Cretaceous sediments is supposed to have overlapped the southeastern part of the older peneplain and through this cover a number of east or southeast-flowing rivers were superposed on the greatly deformed and denuded underlying rocks. Traces of this system of drainage are found in the headwaters of certain rivers whose valleys now converge in a general southeasterly direction towards notches in the hills through which their united volume is thought to have once continued in about the same course, but from which it seems to have been in several cases diverted by headwater

capture by small streams that grew along a belt of weak slates. The upper Nashua river is the best example of this kind, a number of its head-

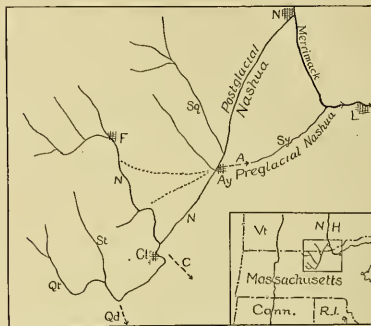

Rough Diagram of Nashua River System, Mass. Cities: Ay., Ayer; Cl., Clinton; F., Fitchburg; L., Lowell; N., Nashua. Streams: N. N., Upper Nashua; Qt., Quinepoet; Sq., Squannacook; St., Stillwater; Sy., Stony. Tertiary Water Gaps: A., Ayer; C., Clinton; Qd., Quinsigamond.

water branches having been gathered from other systems into a single trunk. During the progress of these captures and adjustments, broad, low-grade valleys were opened, their sub-confluent floors constituting the Tertiary peneplain, above mentioned. A number of narrow gorges in these valley floors, now concealed by drift and discovered by borings in connection with the extensive works of the (Boston) Metropolitan Water Board, are explained as the result of a preglacial elevation; and as such they may come to be compared with the narrow young valleys so distinctly seen in the uplifted Tertiary peneplain of Pennsylvania, but not hitherto identified in central New England. During the retreat of the ice sheet, lakes were formed in front of it in the upper Nashua valley; their outlets were across notches among the hills, at whose level a number of deltas and sandplains are now found. Drift obstructions in the broad notch traversed by the preglacial Nashua trunk seem to have diverted its flow northeastward along its present lower course into the Merrimack.

It is to be hoped that fuller details, especially in

the form of maps, may in due time be presented regarding the glacial lakes above noted. As to the restoration and development of the Tertiary drainage systems, the problem is inherently difficult on account of the unproved inland extension of the Cretaceous coastal plain, of the complicated rock structure of the region, of the uncertain relation between river volume and valley size in the advanced stage reached by the Tertiary cycle of erosion before the glacial period, and of the large volume and irregular distribution of the drift. Additional examples of streams, explainable by the same theoretical process, would perhaps lead as far towards demonstration as the case allows.

W. M. DAVIS.

#### CURRENT NOTES ON METEOROLOGY.

##### MONTHLY WEATHER REVIEW.

THE *Monthly Weather Review* becomes more and more indispensable to teachers and students of meteorology with every succeeding number. Under the able editorship of Professor Cleveland Abbe, the *Review* is rapidly enlarging its scope and its sphere of usefulness. The number for December (issued in February) contains, among its special contributions, 'The Circulatory Movements of the Atmosphere,' a translation of portions of a paper by Professor V. Bjerknes, recently published in the *Meteorologische Zeitschrift*, and 'Line Integrals in the Atmosphere,' by Professor F. H. Bigelow. In the 'Notes by the Editor,' Professor Abbe takes up a great variety of topics. In 'Micro-Photographs of Snow Crystals,' the history of the study of snow crystals is briefly reviewed. Under 'Bombarding the Hail Clouds' the question as to the possibility of dispersing hail storms by means of cannonading is answered by Professor Abbe as follows: "The Editor would state that although statistics show that during the past year 15,000 shooting stations were established in Italy, and a very large number in southern France and Austria, yet there is no evidence whatever that the shooting done by these stations has had any effect whatever upon the hailstorms or the hail." A short paper on 'Oscillations of the Lakes and the Climate in Arid Regions' mentions the decreas-

ing depth of Great Salt Lake, the notable diminution of the quantity of water in the streams and wells of Turkestan and Bokhara, and the shrinking of Lake Ngami, in South Africa, and points out that these observations do not indicate a permanent change in the conditions of the atmosphere, these lakes having gone through many similar dry periods before now. Other papers are 'The Commercial Importance of Storm and Weather Forecasts,' 'The Evolution of the Thermometer' (a review of Dr. H. C. Bolton's recent book); 'Correlation of Weather in Distant Localities,' and 'Lightning from Cloudless Skies.' A recent investigation of the 'Relations between Summer and Winter Temperatures,' by Dr. O. L. Fassig, of Baltimore, is found to show that neither warm nor cold summers have any more relation to the succeeding winter temperatures than have the normal summers, or, in general, that there is no regular alternation or period in atmospheric temperatures.

##### NEW CHARTS OF MEAN MONTHLY RAINFALL.

THE first charts showing the mean monthly rainfall for the world were constructed by Dr. A. J. Herbertson, and published in Bartholomew's new 'Atlas of Meteorology' (1891). Several charts of mean annual rainfall had previously been published, the first fairly complete one being that of Loomis (*Am. Journ. Sci.*, third series, Jan., 1882; revised edition, *Ibid.*, Jan., 1883). Seasonal rainfall charts have recently been constructed by Supan. Herbertson's monthly rainfall charts have now appeared in 'The Distribution of Rainfall over the Land' (*Roy. Geogr. Soc.*, London, 1901, 8vo, pp. 70), on a considerably larger scale than that adopted for them in the 'Atlas of Meteorology.' The discussion is also much more extended than in the 'Atlas.' This monograph will naturally not attract as much attention as it would have done had not the charts already appeared, but nevertheless it may be said that Herbertson's 'Distribution of Rainfall over the Land' is one of the most important meteorological publications of recent years.

##### NOTES.

ARCTOWSKI, the meteorologist of the *Belgica* expedition, contributes to *Ciel et Terre*

for March 16th a paper entitled 'A propos de la question du climat des temps glaciaires,' in which he states it as his belief that the problem of the climate of glacial periods will be solved through a careful study of the meteorological and other conditions of the Antarctic.

MR. H. N. DICKSON, lecturer in physical geography in the University of Oxford, contributes a paper on 'The Circulation of the Surface Waters of the North Atlantic Ocean' to the *Philosophical Transactions of the Royal Society of London*, Series A, Vol. 196, pp. 61-203. The plates, which are colored, show the monthly distribution of temperature and of salinity in the surface waters of the North Atlantic during the years 1896 and 1897.

'CLOUD observations during 1896 and 1897 at Toronto' is the title of a recent publication of the Meteorological Service of the Dominion of Canada (4to, Toronto, 1901, pp. 27). These observations were begun September 21, 1896, and were made by means of theodolites. The full tables of observations are given, but there is no discussion of the results, there being only the briefest summary of average altitudes and velocities by months.

MAMMOTH Tank, in the eastern portion of San Diego Co., Cal., on the line of the Southern Pacific R. R., is one of the most interesting meteorological stations in the United States. 'The Climatology of Mammoth Tank' is the title of a brief article in the February number of *Climate and Crops: California Section*. The mean annual rainfall for 23 years is 1.81 inches. The maximum temperature recorded was 130°, on Aug. 17, 1878. The warmest month is July, with a mean temperature of 98.5°.

R. DEC. WARD.

#### FRANÇOIS QUESNAY.

THE Smithsonian Institution has received a *Livre d'Or*, published in commemoration of M. François Quesnay, who died in December, 1774, at the age of eighty years, and was buried at his birthplace, Méré, Seine-et Oise, France.

The monument and book were the project of the Société populaire, of which M. J. Allain-Le Canu was president and prime mover. The monument was determined upon at Méré dur-

ing the Fête Scolaire held July 10, 1892, and was completed and inaugurated August 23, 1896. At both ceremonies there were large attendance and great enthusiasm. At the former, addresses were delivered by M. Quesnay de Beaurepaire, the great-grandson of him whom they honored, and at the latter by MM. Bourgeat, representing the Minister of Public Instruction and Beaux Arts, Frederick Passy, M. Bellan and M. Marcel Habert.

M. François Quesnay was an ignorant country boy. He did not learn to read until after he was eleven years old, when he became enamored of the science of medicine, in which he acquired such skill as that he was appointed physician to the King, Louis XV. He became the founder of the science of political economy in France, and finally one of the most learned men of his country and his age. His eminence in these branches of science was such that, two hundred years after he was born, his friends and the neighbors of his town, desiring to give him honor according to his renown, erected a monument in his memory in the town of his birth.

Alexander Quesnay, descendant of François, came to America and fought on her side during the War, of Independence. He remained here after the war, taking up his residence in Richmond, Va., where he was chosen and served as president of the Academy.

THOMAS WILSON.

#### A SUMMARY OF WISCONSIN ARCHEOLOGY.

MEMBERS of the Wisconsin Society of Natural History are making systematic efforts to summarize the data of Wisconsin archeology and to preserve the archeological records, specimens and mounds of the State. A committee has been appointed for this purpose. It consists of C. D. Stanhope, H. Denison, W. J. Bennetts and Charles E. Brown. This committee has prepared a circular letter to be sent to every person in the State who is thought to be interested in the archeology of Wisconsin.

There are about three hundred collections of specimens from Wisconsin, varying in size from five hundred to five thousand objects, which

are known to be in different parts of the State. There are no headquarters for these collections, or for a typical series from them, nor is there any record covering the entire range of forms or number of geographical areas. Many specimens pass to foreign countries without a record or photographs being taken for the State. It is not the desire of the Wisconsin people to prevent the study of the antiquities of the State by outsiders or even their acquirement of specimens, but rather to secure records, drawings and other data for a central State collection to be available for study by all. Eventually State appropriations for a survey of the mounds are to be sought.

The Wisconsin Society of Natural History was founded by Increase Lapham and others, who began archeological work on a firm basis. It now proposes to establish a new grade of membership in the archeological section, for people living at a distance from Milwaukee. The regular membership fee is three dollars per year. The fee for the new grade will be one dollar. A meeting will be held at the Milwaukee Public Museum in May, to which all known students and collectors of Wisconsin archeology residing in the State will be invited. The object of this meeting will be to discuss ways and means for the study and preservation of Wisconsin antiquities.

It is hoped that students and collectors will be brought into closer relationship by the publication of a bulletin, which, it is expected, will be established as a result of this meeting. The foundation of an anthropological reference library, the lack of which is keenly felt, and a central place of record, where reports of explorations may be heard and discussed, is also expected by the committee as an outcome of the meeting.

The people interested in this movement may do lasting good by striving to preserve the prehistoric mounds by enclosing them in parks, by a close cooperation with the State University, by a broadening of the proposed archeological research into that of general ethnology, and, finally, by the foundation of a permanent department of anthropology in the University.

HARLAN I. SMITH.

#### SCIENTIFIC NOTES AND NEWS.

At the annual meeting of the American Academy of Arts and Sciences, held on May 8th, it was unanimously voted to award the Rumford Medal to Professor Elihu Thomson 'for his inventions in electric welding and lighting.' The Academy has granted to Professor Theodore W. Richards, of Harvard University, the sum of \$500 from the income of the Rumford Fund, in aid of a research upon the Thomson Joule effect.

PROFESSOR J. H. VAN'T HOFF, of the University of Berlin, will give a limited number of lectures on physical chemistry at the Kent Chemical Laboratory of the University of Chicago, beginning on June 19, 1901.

M. BERTHELOT, the eminent chemist, ex-Minister for Foreign Affairs, and permanent secretary of the Paris Academy of Sciences, who has been elected a member of the French Academy in succession to M. Bertrand, the mathematician, was officially welcomed to the Academy by Mr. Lemaître on May 2d.

M. ZEILLER has been elected a member of the botanical section of the Paris Academy of Sciences in the place of the late Adolphe Chatin. M. Zeiller received twenty-five votes, while twenty-two were cast for M. Renault. MM. Bureau Costantin and Mangin were also candidates.

THE following fifteen candidates have been recommended by the Council of the Royal Society for election to membership: Professor Alfred William Alcock, M.B., Mr. Frank Watson Dyson, M.A., Mr. Arthur John Evans, M.A., Professor John Walter Gregory, D.Sc., Captain Henry Bradwardine Jackson, R.N., Mr. Hector Munro Macdonald, M.A., Mr. James Mansergh, M.Inst.C.E., Professor Charles James Martin, M.B., Major Roland Ross, M.R.C.S., Professor William Schlich, Ph.D., C.I.E., Professor Arthur Smithells, B.Sc., Mr. Michael Rodgers Oldfield Thomas, F.Z.S., Mr. William Watson, B.Sc., Mr. William Cecil Dampier Whetham, M.A. and Mr. Arthur Smith Woodward, F.G.S.

At the annual meeting of the American Academy of Arts and Sciences, held May 8th, the following elections took place: *Associate*

*Fellows*, T. C. Chamberlin, of Chicago, and John Fritz, of Bethlehem Pa.; *Foreign Honorary Fellows*, A. Celli, of Rome; A. Engler, of Berlin; F. von Richthofen, of Berlin, and G. Paris, of Paris.

At a meeting held at Cambridge University on April 27th to make some acknowledgment of Professor G. D. Liveing's services to science it was resolved:

That as a mark of our personal regard for Professor Liveing and in recognition of his valuable services to science and to the University, town and county, a testimonial be presented to him, and that it consist of a portrait of him to be painted by an artist selected by a committee in conjunction with Professor Liveing; the destination of the portrait to be determined by the subscribers.

At a meeting of the New York Academy of Sciences held on May 6th, Professor Franz von Leydig, of Würzburg, was elected an honorary member of the Academy. The Academy adopted also the following resolution, to be presented to Professor Leydig on the occasion of his eightieth birthday, on May 21st: "The New York Academy of Sciences extends to Professor Franz von Leydig many hearty congratulations on the occasion of his eightieth birthday. In offering to Professor Leydig an election to honorary membership, the members of this Academy desire to express their appreciation of his long-continued services to science, and of the profound and lasting influence that his memorable researches have exerted on the progress of zoology. With all best wishes they send him a cordial greeting from America."

MR. CHARLES HAWKSLEY has been elected President of the Institute of Civil Engineers, London. The council has made the following awards for papers read and discussed before the institution during the past session: A George Stephenson medal and a Telford premium to Mr. Harry E. Jones; Telford medals and premiums to Mr. G. A. Hobson and Mr. E. Wragge; a Watt medal and a Telford premium to Mr. Joseph Husband; Telford premiums to Mr. J. T. Ford, Mr. L. L. Buck, Mr. W. H. Stanger, Mr. B. Blount and Mr. W. J. Doak; Crampton prize to Mr. E. Sandeman.

KING EDWARD VII. has consented to become patron of the Royal Geographical Society and

to continue the royal premium of two previous reigns for the promotion of geographical research, which takes the form of the two royal medals awarded annually. The Society itself has resolved to found a Victoria medal, to be awarded occasionally for research in scientific geography.

DR. REINHARD SÜRING has been appointed chief of division, and Dr. Johannes Edler aid, in the Meteorological Institute at Berlin.

DR. WILLIAM COLLINGSBRIDGE has been appointed medical officer of health for the City of London.

DR. ADOLPH MEYER will represent Clark University at the celebration of the 450th foundation of the University of Glasgow. Dr. Meyer is at present abroad, working in Germany and Switzerland.

PROFESSOR R. S. TARR, of Cornell University, will spend the summer vacation in Switzerland.

MR. T. NELSON DALE, geologist of the U. S. Geological Survey, who recently resigned his position as instructor in geology and botany at Williams College, will make his home, in September, at Pittsfield, Mass., and from that point continue his geological field work in eastern New York State and western Vermont.

DR. JUDSON SYKES BURY will deliver the Bradshaw lecture before the Royal College of Physicians in London, his subject being 'Prognosis in relation to disease of the nervous system.'

DR. IRVING COLLINS ROSSE, the author of various works on medicine and travel, died at Washington, on May 3d, at the age of forty-two years. Dr. Rosse was at one time professor of nervous and mental diseases in Georgetown University, and, in addition to his medical work, had taken part in several Arctic expeditions.

It is announced that the Rev. James Chalmers, known for his anthropological observations in New Guinea, has been murdered by the natives.

DR. JOHN CAVAFY, formerly lecturer on physiology, demonstrator in histology and physician at St. George's Hospital, London,

has died at Brighton at the age of about sixty years. He was the author of numerous contributions to the medical journals.

MR. ANDREW CARNEGIE, who recently gave £6,500 to the British Institute of Mining Engineers for the encouragement of research, has now doubled this sum.

A TELEGRAM was received at the Harvard College Observatory on May 7th from Professor Kreutz at Kiel Observatory, stating that the south comet will appear in the Northern Hemisphere. It was observed at the Cape of Good Hope May 3<sup>d</sup>. 2115 Greenwich Mean Time in R.A. 3<sup>h</sup> 40<sup>m</sup> 32<sup>s</sup>.4 and Dec. — 0° 31' 49" and was also observed May 4<sup>d</sup>. 2187 Greenwich Mean Time in R.A. 3<sup>h</sup> 54<sup>m</sup> 29<sup>s</sup>.2 and Dec. — 0° 18' 27". The physical appearance is as follows: circular, less than 1' diameter, brighter than 3d magnitude, well-defined nucleus, tail longer than 2°.

THE Society for the Promotion of Engineering Education will hold its ninth annual meeting at Buffalo, beginning on June 29th.

A CABLEGRAM to the *New York Times* states that at a meeting of the Royal Society last week a plan was considered to enlarge the scope of the Society, so that it should embrace literature, and the other subjects included in the five academies of the Institute of France. It is said, however, that no action was taken.

WE learn from the *Northwestern Daily Mail* of April 22d (Barrow-in-Furness, Lancashire, England) that an urn of ancient workmanship has been discovered below the upper Boulder Clay, in the Isle of Walney, near Barrow. The urn lay ten feet below the surface and some forty feet above sea-level in coarse sand on a pan of sandstone beneath the clay. The excavation was for brickworks, the manager of which is confident that the rock had not previously been disturbed. The urn is eight inches in diameter, with a wall average one-fourth inch in thickness composed of at least four layers of a very fine paste of a brown tint and exceedingly hard; its outer surface is smooth and unornamented. This important find is being further investigated by Mr. Harper Gaythorpe of Barrow-in-Furness.

It is stated in the *Times* that experiments were carried out in London on May 1st by a

party of balloonists under the direction of Mr. Percival Spencer, with the object of testing the general direction of the atmospheric currents across London and of investigating the phenomena of sound in the higher reaches of the atmosphere. Four balloons ascended from the Crystal Palace, St. Anne's-grounds, Barnes, the Welsh Harp, at Hendon, and the West Ham Gas Works. The balloon from the Crystal Palace, which ascended at 4:04 p. m., reached Dorking at 5:55. The balloon which left West Ham at 4 p. m. descended at Headley, near Epsom. The greatest altitude attained was 5,500 ft. Snow was encountered above the height of a mile.

THE annual meeting of the members of the Royal Institution was held in London on May 1st, Sir James Crichton-Browne, the treasurer, being in the chair. The annual report of the committee of visitors, testifying to the continued prosperity and efficient management of the Institution, was read and adopted, as was also the report of the Davy-Faraday Research Laboratory. Forty-seven new members were elected last year, and 63 lectures with 19 evening discourses were delivered. The following were elected as officers for 1901-1902: President, the Duke of Northumberland; Treasurer Sir James Crichton-Browne; Secretary, Sir William Crookes; Managers, Sir Frederick Abel, Sir William de W. Abney, Sir James Blyth, Sir Frederick Bramwell, Dr. Thomas Buzzard, Viscount Gort, Dr. Donald Hood, Lord Kelvin, Sir Francis Laking, Mr. Hugh Leonard, Dr. Frank McClean, Mr. James Mansergh, Mr. George Matthey, Mr. W. H. Spottiswoode, and Lord Justice Stirling; visitors, Sir Andrew Noel Agnew, Dr. C. E. Beevor, Mr. W. H. Bennett, Dr. Francis Elgar, Mr. Joseph G. Gordon, Dr. J. Dundas Grant, Lord Greenock, Mr. Maures Horner, Mr. H. F. Makins, Sir Thomas Sanderson, Mr. W. S. Squire, Mr. Harold Swinbank, Mr. J. J. Vezey, Mr. Roger W. Wallace and Mr. James Wimshurst.

AT the meeting of the Council of the Royal Geographical Society, on April 28th, the Royal medals and other awards were made as follows: The founders' medal to the Duke of

the Abruzzi. The Duke undertook, at his own expense, in 1897, an expedition to Mount St. Elias in northwest America, which he for the first time ascended to its summit, 18,060 feet above sea level (July 31, 1897). In 1898 he organized, again at his own expense, an expedition towards the North Pole by the Franz Josef Land route. The expedition made a successful voyage to Franz Josef Land, where winter quarters were established. During the winter the Duke organized a sledge expedition to the north, and, being incapacitated by frost-bite from leading it in person, entrusted the command to Captain Cagni, who succeeded in reaching the highest latitude yet attained by man— $86^{\circ} 33'$  or  $22'$  beyond Nansen's furthest. By this journey over the frozen ocean Captain Cagni disproved the existence of the land shown on the maps to the north of Franz Josef Land, the northern parts of which were for the first time accurately surveyed. The scientific work of the expedition included determinations of positions by astronomical observations, observations of the state and distribution of the ice, investigation of the meteorological and tidal phenomena, the aurora borealis, gravity, and the geology of the lands visited. The patrons' medal was awarded to Dr. A. Donaldson Smith, who in 1894 organized at his own expense an expedition for purposes of exploration between Shebel river and Lake Rudolf, which had at that time never been reached from the north. Starting from Berbera in July, 1894, he pushed southeast to the headwaters of the Shebel, on which he threw much new light, made a wide circuit to the south, crossing the Jub, and making his way westward to Lakes Stefanie and Rudolf. He explored the lower course of the Omo, skirted the east shores of Lake Rudolf and, striking southeast through hitherto unknown districts to the Tana river, reached the east coast, having thus traversed the whole extent of the Somali and Galla countries from north to south. In 1898 he organized a new African expedition for the purpose of completing his former work. Leaving Berbera in August, 1888, he again reached the north end of Lake Rudolf, making *en route* considerable rectifications of the map; and, con-

tinuing his march westward, crossed for the first time the unknown tract of country lying between Lake Rudolf and the Upper Nile. Throughout his journey he executed a careful route survey, carrying a triangulation through from Somaliland to the vicinity of the Nile, and supporting this by frequent astronomical observations with theodolite and chronometers. The other awards were made to Mr. Louis Bernacchi and Captain Colbeck for their aid in the Southern Cross Antarctic expedition, and to Captain Cagni for his journey to  $86^{\circ} 33' N.$ , on the Duke of the Abruzzi's expedition.

PROFESSOR WILLIAM RAMSAY has issued a report on the subject of the proposed institute for post-graduate education, which a wealthy Parsee, Mr. Tata, recently offered to endow. This report, according to the London *Times*, states that the institute should be placed with reference to the situation of raw products; its site should be where the climate admits of energetic work during most of the year; and it should, if possible, be near a coalfield or some source of electric power. Bangalore is selected as an ideal site; for the Mysore State is rich in minerals (iron, gold, magnesite, manganese ore, corundum, &c.), and sugar-cane and the poppy are cultivated there. The climate is temperate, the place is easily accessible, and the Cauvery Falls can provide enough power for many factories. The Mysore Government have offered land for the institute, and would probably aid the scheme with pecuniary support in recognition of the benefits which would accrue to the State from its operations. Professor Ramsay discusses the salaries, period of office, vacations, duties and restrictions of members of the staff, and the method of appointment to chairs. He suggests that mechanics should be engaged to make apparatus and to teach the students to use their hands. A mechanician in brass and iron and a glass-blower might be procured who could train native boys to become skilled workmen capable of constructing apparatus and machinery as the work of the institute increases. Students should be selected from Indian colleges and should be graduates in science, except those who come from engineering colleges. The students would



accumulate at the rate of 15 to 20 a year, and the total number in the institute would not exceed 60, an ample number for a staff of nine teachers in research work. In order that the scheme may be set on foot, Mr. Tata's generous benefaction needs a supplement of about £5,000 from the Government of India. As the Viceroy and several members of his Council have promised favorable consideration, it may be hoped that this modest grant will be forthcoming. "I can imagine few ways," says Professor Ramsay, "in which a contribution from the State is likely to have such substantial and far-reaching results on the prosperity of the whole people. For the establishment of industries would result not merely in giving employment to the small number of experts for whom this Institute is designed, but to a vast army of clerks, artisans, workman and also merchants, whose object would be the disposal of the manufactured articles produced from the raw materials existing in the country; whereas, by exporting the raw materials as such, the country is impoverished, for their extraction gives employment only to navvies and to the railway companies."

#### UNIVERSITY AND EDUCATIONAL NEWS.

THE Legislature of Minnesota has recently appropriated \$25,000 for a new laboratory of agricultural chemistry, and \$25,000 for the erection and equipment of a building for instruction in, and investigation of, veterinary science.

PHILLIPS ACADEMY, of Andover, Mass., has established a department of archeology with a fund of \$150,000. A museum is about to be erected. Dr. Charles Peabody, of Harvard, is hon. director, and Mr. W. K. Moorehead is curator. There are about 40,000 specimens with which to begin study. They were collected during the past six years by Mr. Moorehead for the founder, whose name, at his own request, is withheld from publication.

MR. H. M. HANNA has given to Western Reserve University \$12,000 to establish a research fellowship in its medical school in the departments of physiology and pathology.

THE alumni of Columbia University are making efforts to collect \$400,000 for a hall for the college. It is hoped that the building may be erected by the time of the celebration of the hundred and fiftieth anniversary of the founding of the University in 1904.

EFFORTS are now being made to promote the better equipment of Queen's College, Belfast. It appears that the chair of pathology has been endowed and that a laboratory of physics and engineering has been promised by Mr. Pirrie. The sum of £5,000 has been given by Sir James Musgrave.

GROUND has been broken for the new Administration and Science Building of Colorado College. The sum of \$160,000 has been secured for its erection and equipment, of which sum Dr. Pearsons, of Chicago, and Mr. W. S. Stratton have each contributed \$50,000. The building will contain laboratories in all departments of science, lecture and recitation rooms, and a large natural history and geological museum.

THE Kent Laboratory of Chemistry at Yale University is now being enlarged in accordance with the bequest of \$50,000 by A. E. Kent.

THE courts have decided that the Loomis laboratory must be relinquished by New York University. It would in this case go to the Cornell University Medical College, but we understand that the litigation will be continued.

AT the conference of the Presidents of the State Universities held at the University of Illinois, on May 1st, 2d and 3d, the following subjects were brought up for discussion:

1. What can be done to stimulate publication among university teachers and graduate students without over-stimulating it?

2. Is a uniformity of system in keeping the records and making the reports of State universities desirable and practicable?

3. How does one get rid of a professor who is industrious and attentive to his duties, who has good sense, whose influence upon students is good, but who by lack of ability and training is paralyzing the instruction of his department?

4. Should entrance requirements for colleges of agriculture be lower than for other colleges? What technical courses might be offered in agriculture without entrance conditions?

5. What, if anything, do the State universities owe to applicants for admission who are mature and anxious to increase their working efficiency, but who cannot meet entrance requirements?

6. What proportion of the Morrill Fund is usually devoted to agriculture, and what to mechanic arts, languages, etc., or branches not connected with agriculture?

7. Can anything be done to promote system in 'Agricultural Experimentation' under the Hatch Act?

8. What is to be said concerning physical training departments and athletic matters?

9. To what extent should university authorities permit class rushes and scrimmages?

10. What is the wise policy touching university inspection of high schools?

11. Should our universities maintain summer schools? Or, are four regular terms in the year advisable?

12. What ought our universities to do concerning the professional training of teachers?

13. Is a uniform standard for 'units' or 'points' in entrance requirements practicable?

14. What ought the State universities to claim in reference to the right of their graduates to teach in the common schools without examination by local commissioners?

15. How can other educational interests secure such national cooperation and pecuniary support as are accorded to the agricultural interests?

THE *Yale Alumni Weekly* compares the changes in the election for senior studies next year with those of the class of 1886, when the elective system began. It appears that ancient languages fall from 34.8 per cent. to 23.9 per cent.; European languages rise from 10 per cent. to 14.7 per cent.; English from 9.2 per cent. to 14.7 per cent.; mathematics fall from 18.8 per cent. to 10 per cent.; natural sciences rise from 7.4 per cent. to 8.4 per cent.; philosophy falls from 9.1 per cent. to 5.6 per cent.; history rises from 7.2 per cent. to 10.1 per cent., and social sciences rise from 3.5 per cent. to 12.2 per cent.

THE Council of the New York University has accepted the resignations of the entire faculty of the School of Pedagogy, consisting of six members, including the Dean. A special committee which recommended this action was authorized to reorganize the faculty.

It is expected that two new professorships will be established at the University of Toronto,

one in geology and paleontology, and the other in mineralogy.

DR. FRANKLIN CARTER has resigned the presidency of Williams College after twenty years of service.

AT Columbia University Henry E. Crampton, Ph.D., has been made adjunct professor of zoology at Barnard College, and Mr. W. E. Kellicott assistant in this science. Mr. William Findlay has been made tutor in mathematics and Miss Julia L. Collis assistant in physics. In other departments of the University the following promotions and appointments have been made: George H. Ling, tutor in mathematics; Charles S. Forbes, assistant in mathematics; Alexis P. Anderson, curator of the herbarium; H. W. Shimer, assistant in paleontology; George I. Finlay, assistant in geology; George Canning Hubbard, assistant in analytical chemistry and assaying; Myron S. Falk, C.E., tutor in civil engineering; Adolph Black, instructor in civil engineering; Joseph C. Pfister, instructor in mechanics; A. L. J. Iveane, tutor in metallurgy; Gilbert Tolman, assistant in physics; Holmes C. Jackson, assistant in physiological chemistry.

WILLIAM J. MOENKHAUS, graduate student at the University of Chicago, has been appointed assistant professor of zoology at the University of Indiana.

C. J. FRANCE, who expects to take the Ph.D. degree at Clark University, has been given charge of the biological work in the Jacob Tome Institute.

THOMAS HUDSON BEARE, professor of mechanical engineering at University College, London, has been appointed to the chair of engineering in the University of Edinburgh, in succession to the late Professor Armstrong.

J. J. SUDBOROUGH, D.Sc., senior lecturer and demonstrator in chemistry at Nottingham University College, has been appointed professor of chemistry, at Aberystwith, in place of Dr. Lloyd Snape, now Secretary for Education for the County of Lancaster.

DR. R. SPITALER, docent and assistant in astronomy in the German University at Prague, has been promoted to an associate professorship.





H. A. Rowland

# SCIENCE

A WEEKLY JOURNAL DEVOTED TO THE ADVANCEMENT OF SCIENCE, PUBLISHING THE OFFICIAL NOTICES AND PROCEEDINGS OF THE AMERICAN ASSOCIATION FOR THE ADVANCEMENT OF SCIENCE.

EDITORIAL COMMITTEE: S. NEWCOMB, Mathematics; R. S. WOODWARD, Mechanics; E. C. PICKERING, Astronomy; T. C. MENDENHALL, Physics; R. H. THURSTON, Engineering; IRA REMSEN, Chemistry; JOSEPH LE CONTE, Geology; W. M. DAVIS, Physiography; HENRY F. OSBORN, Paleontology; W. K. BROOKS, C. HART MERRIAM, Zoology; S. H. SCUDDER, Entomology; C. E. BESSEY, N. L. BRITTON, Botany; C. S. MINOT, Embryology, Histology; H. P. BOWDITCH, Physiology; J. S. BILLINGS, Hygiene; WILLIAM H. WELCH, Pathology; J. MCKEEN CATTELL, Psychology; J. W. POWELL, Anthropology.

FRIDAY, MAY 24, 1901.

## CONTENTS:

<i>Professor Rowland, 1848-1901</i> (with plate): PRESIDENT DANIEL C. GILMAN .....	801
<i>An Outline of the Progress in Chemistry in the Nineteenth Century</i> : PROFESSOR EDWARD H. KEISER .....	803
<i>Campanus</i> : C. S. PIERCE .....	809
<i>The American Association for the Advancement of Science</i> .....	811
<i>Scientific Books</i> :—	
<i>Wilson on Topographic Surveying</i> : PROFESSOR J. H. GORE. <i>Meteorological Reprints</i> : A. LAWRENCE ROTCH. <i>Brub's Die Pflanzen Alkaloide</i> : HENRY KRAEMER. <i>Enzymes and their Application</i> : ALBERT F. WOODS. <i>The Cyclopaedia of American Horticulture</i> : T. ....	820
<i>Societies and Academies</i> :—	
<i>The American Physical Society</i> : PROFESSOR ERNEST MERRITT. <i>The Chemical Society of Washington</i> : L. S. MUNSON. <i>The Onondaga Academy of Science</i> : PHILIP F. SCHNEIDER. <i>The Baconian Club of the State University of Iowa</i> : DR. C. E. SEASHORE. <i>The Academy of Science of St. Louis</i> : PROFESSOR WILLIAM TRELEASE. ....	823
<i>Discussion and Correspondence</i> :—	
<i>The Larynx as an Instrument of Music</i> : PROFESSOR ARTHUR GORDON WEBSTER. <i>The New Comet</i> : GEORGE A. HILL. <i>The Teaching of Physiology in the Public Schools</i> : PROFESSOR S. W. WILLISTON .....	827
<i>Shorter Articles</i> :—	
<i>Unilateral Coloration with a Bilateral Effect</i> : PROFESSOR C. H. EIGENMANN and CLARENCE KENNEDY. <i>Velocity of Ions from Electric Arcs and from Hot Wires</i> : DR. C. D. CHILD. <i>Modulus of Constant Cross Section</i> : BENJAMIN H. BROWN .....	828
<i>Notes on Inorganic Chemistry</i> : J. L. H. ....	831
<i>Botanical Notes</i> :—	
<i>International Botanical Association</i> ; <i>Stock-poining Plants</i> ; <i>North American Ferns</i> : PROFESSOR CHARLES E. BESSEY .....	832

## Museum Notes :—

<i>Publications of the Carnegie Museum; The Field Columbian Museum; The South African Museum</i> : F. A. L. ....	834
<i>Aquatic Resources of the Hawaiian Islands</i> .....	835
<i>The British Antarctic Expedition</i> .....	836
<i>Scientific Notes and News</i> .....	836
<i>University and Educational News</i> .....	839

## PROFESSOR ROWLAND, 1848-1901.\*

A GREAT man has fallen in the ranks—great in talents, great in achievements, great in renown. Not now need we recall the incidents of his life, nor estimate the characteristics of his impressive personality, nor enumerate his contributions to physical science. We are assembled in this academic hall as his friends, his pupils, his colleagues, about to follow his deserted body to the church, and there in silence to give thanks for such an example, or to utter, with his kindred, words of faith and hope, consecrated by the comfort they have given to the mourners of many climes and of many centuries. Before these last rites, we pause to think what sort of a man was this whom we so love and honor, whom we so lament, whose death, in one aspect, seems so premature; in another, crowned with the best that earth can give.

\* An address before the officers and students of the Johns Hopkins University, assembled before the funeral, April 18, 1901.

Our friend was born with a powerful mind, and the older he grew the more powerful it appeared to those who knew him intimately and to those most capable of understanding the problems and the methods which engaged his thoughts. Others may have eyes as keen and fingers as facile, but his vision and his dexterity were controlled by a brain of extraordinary fineness, versatility and strength. Nobody could walk with him, hunt with him, sail with him, talk with him, work with him, without perceiving his firm grasp, his clear aim, his concentrated energy, his extraordinary powers. In early youth his mind was directed to the study of nature—not so much to plants and animals as to physical and chemical forces. This was the bent of his life. It is true that he was fond of music, classical music especially—Chopin's funeral march, for example—and he loved good works of art—the Madonnas of Raphael, for example.

Yet he cared but little for literature, having showed, in his early days, a boyish animosity toward Greek and Latin which he never wholly overcame. Aristotle was no authority to him. But the mysterious forces of the physical world—gravitation, sound, light, heat, electricity and magnetism—were his constant study. The principles of mechanics were to him of fundamental importance, and mathematics was subservient to all his investigations. In this broad field he was a reader, a student, an experimenter, an inventor, a discoverer, a philosopher. He knew how to ask a difficult and far-reaching question, and he knew how to seek the answer.

Extraneous considerations were excluded when he saw the point of an inquiry, and on that point he concentrated all his powers. For example, when he began the brilliant series of experiments in spectrography which made him peerless in this domain, he saw that the spectrum depended on the ac-

curacy of the gratings, and the gratings on the dividing engine, and the dividing engine on the screw—so he began the study of light by devising and making a screw more exact than any screw that has ever been produced by the most accomplished makers of instruments of precision, and then he saw that photography must be improved before he could reveal to the eye of others the intricacy of the solar spectrum.

His intellectual apparatus was controlled by a powerful will. When he was determined upon a given course, no regard for consequences, no apprehension of perils or of difficulties, no dread of failure, proved a barrier. They heightened his zest. Fortunately his ends were noble and his proceedings wise, so that rarely, if ever, did failure disappoint him or weaken his self-confidence. He would have been a great soldier, a great explorer, a great lawyer.

But above his keen perceptions, his logic, his adaptation of means to ends, and his marvelous concentration, I must place another moral quality—one that appeals to every one of us, whether we understand his determination of the mechanical equivalent of heat, or the steps by which he arrived at the value of the ohm. This moral quality is the love of truth. Of course, he was true in all the ordinary relations of life. That is the beginning of truth, but not the end of it. He was also true in all his investigations, careful to eliminate errors, to avoid preconceptions, to shrink from hasty conclusions and inferences, to be critical of other investigations, to be accurate, exact, conscientious, to spare no pains, to shrink from no efforts, to conceal no difficulties, in order that the absolute facts might be established, so far as this can be done by limited humanity. To him science was another word for truth—not all the truth, but that amount of truth which the limited powers of man have discovered. He was a follower of Isaac New-

ton, picking up upon the seashore a few pebbles and discerning their lessons.

At the close of our first decennium, two speakers were brought forward to tell, respectively, what had been the aims of this University in providing for the study of science and letters. These speakers were Professor Gildersleeve and Professor Rowland. They had no preliminary conference, but each brought his discourse to a close by a return to the key-note—the key-note which had governed and should govern our personal behavior and the harmonies of our associated lives as members of the Johns Hopkins University.

Said the exponent of letters: "First and last, the scientific standard must be upheld for the university man, be he a student of letters, be he a physicist; and that standard is the absolute truth, the ultimate truth. 'Nothing imperfect is the measure of anything,' says the prince of idealists."

Said the man of science: "But for myself, I value in a scientific mind most of all that love of truth, that care in its pursuit, and that humility of mind which makes the possibility of error always present more than any other quality. This is the mind which has built up modern science to its present perfection, which has laid one stone upon the other with such care that it today offers to the world the most complete monument to human reason. This is the mind which is destined to govern the world in the future and to solve problems pertaining to politics and humanity as well as to inanimate nature.

"It is the only mind which appreciates the imperfections of the human reason and is thus careful to guard against them. It is the only mind that values the truth as it should be valued and ignores all personal feeling in its pursuit. And this is the mind the physical laboratory is built to cultivate."

These are words worthy to be recalled

by the successive groups of students who come here for instruction and counsel as the years roll on. Let us sacredly cherish our inheritance.

In closing, let me call our departed brother, our dear colleague, our honored teacher, our ornament, our pride and our delight, by another nobler title. He was a servant of the Lord. If one who leads a life of purity, fidelity and integrity, and who consecrates, without self-seeking, his strength, his talents, his time, at home and at his laboratory, in health and in bodily infirmities, in youth and in maturity, to the interpretation of the laws by which the cosmos is governed, is a servant of the Lord,—then reverently and truly we may say of our departed friend he was a servant of the Lord, Maker of heaven and earth. Let me apply to him words of the Master, whom he was taught from childhood to revere. His 'eye was single' and 'his whole body was full of light.'

DANIEL C. GILMAN.

JOHNS HOPKINS UNIVERSITY.

*AN OUTLINE OF THE PROGRESS OF CHEMISTRY IN THE NINETEENTH CENTURY.\**

CHEMISTRY is one of the youngest of the natural sciences. Its growth and development have taken place almost entirely in the past one hundred years. Nevertheless, it is well to remember that some of the foundation stones of the science were laid in the latter part of the eighteenth century. There was no such thing as a science of chemistry in the time of the ancient Greeks and Romans. Nor during the middle ages, nor previous to the year 1750 can there be said to have been any systematized chemical knowledge.

In the middle of the eighteenth century the attempt was made to explain in a general way that most striking of all ordinary

\* Address delivered before the Academy of Science at St. Louis, on March 18th.

chemical changes, namely, fire or combustion. It was noticed that there are two classes of bodies, those that will burn and those that will not. The former were assumed to contain the element of fire or phlogiston. In the process of burning the phlogiston was supposed to escape into the air; the ashes or products of combustion remained behind. The act of burning was looked upon as a decomposition. Combustible bodies were all supposed to be of a compound nature, consisting of phlogiston and the products of combustion. In the act of burning these two elements separated, the phlogiston going off into the air, the products of combustion remaining behind as the ashes.

This first theory of chemistry was replaced by a better one in the year 1785 by Lavoisier, the distinguished French chemist. Last summer a bronze statue of Lavoisier was unveiled in Paris. It bears a single inscription, namely, 'The founder of Modern Chemistry.' Lavoisier found that when bodies burned the products of combustion were heavier than the original substances. A few years previous to this, in 1774, Joseph Priestley, the English clergyman, had found that when the red calx of mercury is heated oxygen gas is obtained, and that substances burn very brilliantly in this gas. Lavoisier repeated the experiments of Priestley, saw, what the latter failed to see, that burning was the union of oxygen with the burning substance and that combustion was a chemical combination and not a decomposition. 'There is no such thing as phlogiston, the element of fire,' said Lavoisier; and from this time on all substances that could not be resolved into simpler substances weighing less than the original substances were called elements.

Thus began a new era for chemistry, a quantitative era, in the year 1785. From now on the balance became the chief instrument of chemical investigation. Such

in brief was the condition of chemistry one hundred years ago. The ideas of Lavoisier had, at the opening of the last century, come to be very generally accepted, but very little was known beyond these. Oxygen was the chief element and the oxides the chief compounds or, as Berzelius said: 'Oxygen was the center point about which chemistry revolved.' The knowledge of the composition of other substances was very imperfect. It was not even known at that time that substances do have a fixed composition; indeed the fundamental laws of chemical action were still all undiscovered. Almost nothing was known of the composition of substances of vegetable or animal origin, that great and important class of bodies that we now know as organic substances. A century ago it was not known that alcohol contained oxygen; this fact was found out in the year 1809. There were no laws and principles, no generalizations; chemistry consisted of purely descriptive matter, and that was often very imperfect. In organic chemistry was largely mineralogy, organic chemistry was chiefly botany.

Limited as chemical knowledge was when the nineteenth century opened, there were, however, certain men at work, who had adopted the quantitative methods of Lavoisier, and who soon made important discoveries. First of all Proust, in 1801, announced that every chemical compound has a fixed and definite composition, that when substances unite chemically they do so in definite ratios by weight. This statement of Proust's was not allowed to go unchallenged. C. L. Berthollet maintained that compounds have a variable composition, and that if there are any that do appear to have a fixed composition it is an exception and not the rule. For eight years the controversy was carried on between these men. Proust finally came out victorious. More and more analyses of compounds were made,



until it was clearly established that every distinct substance has a fixed and unalterable composition. The second great law of combination was discovered in 1804 by John Dalton, and it is commonly called the law of multiple proportions. To explain these laws of combination, Dalton introduced the atomic theory into chemistry, and from now on the great problem was to determine the relative weights of the atoms. When the history of chemistry in the nineteenth century comes to be written, it will be largely the history of the atomic theory, and for more than sixty years the two great problems to which the most eminent men gave their attention were the determination of the atomic weights and of the arrangement of the atoms in compounds. It would be a long story to trace out step by step how these problems were solved. The men who did most in this direction were Berzelius, Dumas, Liebig, Gerhardt and Laurent, Cannizzaro and Kekulé. As a result of their work, it began to be generally recognized, about 1865, that these two problems had been satisfactorily solved, and from that time on there has been no question as to the reasoning employed in fixing upon a number to represent the atomic weight of an element, or to determine the way in which the atoms are linked together in a compound.

Side by side with this development of chemical theory has gone the discovery of new elements and compounds. Instead of the thirty elements or simple substances known at the beginning of the last century, we now have seventy-eight. Instead of a few scores of distinct compounds of definite composition, we now have thousands of these substances. To-day there are known 75,000 compounds of carbon alone. In the years 1859 and 1860 Bunsen and Kirchoff devised the spectroscope, and it has become, next to the balance, the most important instrument of chemical investigation. By means of it

the elements rubidium, cesium, thallium, indium, gallium, scandium and helium have been discovered.

#### THE PERIODIC LAW.

Soon after the atomic weights had been determined satisfactorily, a very remarkable relationship was discovered by Lothar Meyer and Mendelejeff to exist between the atomic weights and the properties of the elements. It was found that when the elements were arranged in the order of increasing atomic weights, beginning with the lowest and going up regularly to the highest, there was a periodic variation in the properties of the elements. For example, it was noticed that the 8th element resembled the first, the 9th was analogous to the 2d, and so on. Mendelejeff expressed this fact in the following way: "The properties of the elements," he said, "are a periodic function of their atomic weights." By means of this law Mendelejeff was able to foretell the existence of new elements and to predict their chemical and physical properties. When the table of elements was first arranged it was incomplete, there were blank spaces. Mendelejeff predicted that elements would be found that would fill these spaces, and from the properties of the adjoining elements he foretold the properties of the unknown elements. In this way he predicted the properties of an element that would resemble boron, another that would be analogous to aluminum, and a third that would be closely related to silicon. These predictions have all been fulfilled. In 1879 Nilson discovered scandium and found that it had all of the properties of the unknown element that resembled boron, in 1875 Boisbandran discovered gallium; it was the element resembling aluminum, and in 1885 Winkler discovered germanium; its properties were almost identical with those that had been predicted for the element resembling silicon.

## NEW ELEMENTS FOUND IN AIR.

In the last few years it has been found that ordinary air contains some elements, the existence of which had not even been suspected. For nearly three-quarters of a century it was supposed that we knew all about the composition of the air, but in 1892 Lord Rayleigh found that a globe filled with atmospheric nitrogen weighed more than the same globe filled with nitrogen made from chemical compounds containing nitrogen, and this observation followed up led to the discovery of argon, an inert gas, present to the extent of about one per cent, in the air. Then efforts were made to find argon in mineral substances; certain minerals that were supposed to give off nitrogen on heating were heated in vacuous vessels and thus helium was discovered. Recently Professor Ramsey has found two other inert gases in air besides argon; he obtains them by the fractional evaporation of liquid air, and he has named them neon and krypton. Quite recently it has been claimed that the mineral pitch blende contains the elements radium, polonium and actinium, and that these elements emit rays that are capable of producing skiagraphic images on sensitive plates, and of discharging electrified bodies.

## PROGRESS IN INDUSTRIAL CHEMISTRY.

Hand in hand with the development of scientific chemistry and the discovery of new compounds has gone the improvement of manufacturing processes and the methods of industrial chemistry. At the beginning of the last century potash was the chief alkali, and this was obtained from wood ashes. Leblanc invented a method of obtaining soda from salt, and for many years this was the only way of getting alkali on the large scale. Now this method has been almost entirely replaced by the Solvay or ammonia-soda process, and it is very probable that before many years this

in turn will be replaced by the electrolytic process of obtaining alkali from salt solutions. There is a constant evolution of new methods in chemical industry, the older processes have to give way to more economic and perfect methods. For more than one hundred years, all the sulphuric acid that is used has been made in lead chambers, and one improvement after the other was added to this process until it was brought to a high state of perfection; but now, with the opening of the new century, the sulphuric acid manufacturers are pulling down their lead chambers. A new and better method of making the acid has been devised. Sulphur dioxide and air are led over finely divided platinum and the resulting sulphur trioxide is conducted into water. It has long been known that sulphuric acid can be made in this way on the small scale in the laboratory, but it is only recently that the principle has been adapted to the commercial preparation of the acid. Heretofore the difficulty has been that the contact substance, the finely divided platinum, soon lost its activity. Now it has been found that this can be overcome by carefully purifying the gases before they come in contact with the platinum, and that, by keeping the temperature of the interacting gases below the point of decomposition of the sulphur trioxide, the action can be carried on indefinitely and on the commercial scale. The resulting sulphur trioxide is led into water and sulphuric acid of any degree of concentration obtained.

Other important changes in industrial chemistry have been brought about by the application of electricity to the preparation of chemical elements and compounds. Places like Niagara Falls that have abundant water power for the production of electric currents are rapidly becoming the seats of important chemical industries. The electric current is at present used chiefly in two ways in inorganic chemistry. First

it is used for the production of very high temperatures in the electric furnace. In simple form the electric furnace consists of a box made of fire bricks in which the carbon poles of an electric arc light are placed. Under the influence of the high temperatures produced between the carbon pencils nearly all metal oxides are reduced by carbon. Aluminium oxide is reduced in this way at Niagara Falls, and aluminium bronze, an alloy of aluminium and copper, is made. Sand is reduced in the same way, and the element silicon unites with the excess of carbon and forms the compound carborundum, an exceedingly hard substance which is used so extensively as a substitute for emery. Artificial graphite and phosphorus are also made in the electric furnace and the carbides of a large number of metals have been prepared. Of these carbides calcium carbide has become of commercial importance, as it is used extensively for making acetylene.

The other way in which the electric current is utilized is for the electrolysis of liquids, either solutions of substances in water or fused substances. At Niagara metallic sodium is now made by the electrolysis of fused caustic soda. One of the uses of the metallic sodium is to prepare sodium peroxide, the new bleaching agent, for which purpose the metal is burnt in dry air. Metallic aluminium is obtained by the electrolysis of aluminium oxide in a fused bath of cryolite. Caustic soda and chlorine are made by the electrolysis of salt solutions, and potassium chlorate by the electrolysis of potassium chloride solution. The electric current is also used in refining certain metals, for which purpose sheets of the crude metal are suspended at one pole in a bath of the metal salt and the pure metal deposited at the other pole.

During the past century great progress has been made in the methods of extracting the metals from their ores. Not only

has this been true of iron, but of all the useful metals. As an example, it is only necessary to call attention to the cyanide process of extracting gold and silver. Gold and silver ores which are so poor that it was unprofitable to work them in previous years are now successfully treated with a solution of potassium cyanide, which has the power, in the presence of air, of dissolving the noble metals. It is this method which has largely contributed to the increased production of gold in recent years. Side by side with this improvement of metallurgical processes has gone the utilization of by-products. Not only is blast-furnace slag used in making Portland cement, but other slags, such as those obtained in the basic steel process and which contain phosphoric acid, are used as fertilizers. The sulphur dioxide formed by roasting lead and zinc ores is no longer allowed to escape into the air, but is converted into sulphuric acid.

#### PROGRESS IN ORGANIC CHEMISTRY.

But undoubtedly the most rapid strides in the development of chemistry have been made in the past century in that department known as organic chemistry. One hundred years ago our knowledge of the compounds occurring in the organs of plants and animals was very meager indeed. A few organic substances had been isolated, but their composition was very imperfectly known, as the methods of analysis were very crude. Liebig in 1830 improved the method of analyzing these compounds and thus laid the foundation of organic chemistry.

A century ago it was generally believed that organic compounds could not possibly be made artificially by synthesis in the laboratory, as was the case with mineral compounds. It was thought that a peculiar vital force in some way intervened in their production in the organs of plants and

animals, and that we could never expect to prepare them in the laboratory. But this idea soon had to be abandoned, for in 1828 Wöhler succeeded in building up urea from simple inorganic substances, and thus the first synthesis of an organic substance was effected. This was soon followed by that of acetic acid by Kolbe, and then year after year an ever larger and larger number of substances was added to the list of synthetic compounds. It would take too long to enumerate all the compounds that have been made artificially in the laboratory. It is enough to say that the hydrocarbons of petroleum, common alcohol, wood alcohol, fusel oil, the ethers, the ethereal and essential oils, the fatty acids, glycerine, grape sugar and fruit sugar, coloring matters and dye stuffs like indigo and turkey red, aromatic substances like oil of bitter almonds, vanilline and coumarine and many others, have been made.

One hundred years ago it was generally believed to be impossible for two substances of entirely different properties to have the same composition. When Liebig in 1823 found that Wöhler had analyzed silver cyanate and stated the percentage composition, he saw that it was identical with the percentage composition of silver fulminate as found by himself. He at once wrote to Wöhler and told him that he must have made a mistake. Silver cyanate and silver fulminate were very different substances, he said; they could not possibly have the same composition. Wöhler repeated his analyses and found that they were correct. Liebig again analyzed silver fulminate and found that his figures also were correct. Both substances had the same percentage composition. A few years after, Berzelius showed that racemic and tartaric acids have the same composition, but different properties, and from this time on substances of this kind have been called isomeric. This phenomenon of isomerism, so rare at

one time, is now very common. We have, for example, 55 substances having the formula  $C_6H_{10}O_3$ , all having the same elements in the same proportions, or the same kind of atoms and the same number of atoms of each kind. To explain isomerism it was necessary to assume that in these different bodies the atoms are differently arranged or grouped. Thus there came into chemistry the idea of structure or constitution, and by this term is meant the way in which the atoms are united to form the smallest particles of compounds. By studying the methods of formation and of decomposition of compounds it has been found possible to draw conclusions as to which atoms are more closely associated with one another. In the year 1865 the methods of determining the constitution of substances had been brought to a high state of development as the result of the work of Professor Kekulé in Bonn. Kekulé proved experimentally that in a compound each atom is not united directly with all the other atoms, but that certain atoms act like links in a chain and hold different atoms together to form definite structures.

The immediate effect of this theory was that it led to a great deal of work, the object of which was to determine the way in which the atoms are linked in different substances. When once this structure had been determined, it was easy to see how the compound might be built up from simpler substances. The outcome was that hundreds of substances were made synthetically, and in the attempt to make artificially the valuable and useful substances, very often new ones were discovered that in turn were found to possess valuable properties. For instance, after determining the constitution of atropine, Ladenburg, in making it synthetically, succeeded in making several modified atropines, such as homoatropine, which also have valuable properties. Professor Fischer attempted to unravel the

structure of grape sugar and to make it synthetically; he succeeded in this, but, in addition, he has made 20 other sugars that had never been known before.

As work went on in organic chemistry and the methods of working with these substances were improved, and the means of distinguishing between them became more refined, it was found that there were even finer kinds of isomerism than had at first been observed. It is possible to have two or more substances of identical composition and of exactly the same chemical behavior, but differing from one another in only a very slight way. For example one compound will rotate the plane of polarized light a certain number of degrees to the right while the other will rotate the plane the same number of degrees, but to the left. In short there are right and left handed compounds. This physical isomerism, as it is called, can only be explained by assuming a different arrangement of the atoms in space. Since 1888 a great deal of work has been done in the development of the theories of space chemistry or stereochemistry. We are in a position now not only to determine how the atoms are linked to one another but also how they are actually grouped in space. Stereochemistry is the most attractive field of research in organic chemistry to-day. Prominent among the men who have contributed to this department of chemistry are Van't Hoff, Wislicenus, Baeyer and Emil Fischer.

#### PROGRESS IN PHYSICAL CHEMISTRY.

During the past fifteen years the borderland between chemistry and physics has been very successfully cultivated, and a new department of chemistry has resulted. This is the department known as physical chemistry, and it deals with such subjects as thermo- and electrochemistry, with chemical statics and chemical dynamics and with the laws of solution and electrolytic

dissociation. A great deal of progress has been made in all these directions. It is especially the new theories of solution and of electrolytic dissociation that have most profoundly changed our ways of looking at chemical action. We now regard a substance in solution as in a condition analogous to the gaseous state. Like a gas, the dissolved substance exerts pressure, and this pressure, which is known as osmotic pressure, obeys the same laws that gas pressure does. One great practical benefit that has resulted from the laws of solution is that it is no longer necessary to convert a substance into a gas in order to find its molecular weight; it is only necessary to dissolve it in some solvent, and from the changes which it produces in the freezing point or boiling point or vapor tension of the solvent to calculate the molecular weight.

The theory of electrolytic dissociation has greatly modified our ways of interpreting the ordinary reactions of analytical chemistry. We now hold that in all dilute solutions of acids, bases and salts, in short the compounds of inorganic chemistry, we have no longer the unchanged substances, but their positive and negative ions. In the act of dissolving in water the acids, bases and salts are more or less completely split into their ions, and the chemical changes that take place in these solutions are reactions between these ions. A great many facts of analytical chemistry, of electrolysis and such empirical laws as the law of thermoneutrality of salt solutions and of the constant heat of neutralization of acids and bases, heretofore inexplicable, have now received a rational and natural explanation by means of this theory of electrolytic dissociation.

EDWARD H. KEISER.

---

#### CAMPANUS.

MANY of the early editions of the 'Elements' of Euclid, among them the *editio prin-*

*ceps* of 1482, carried a commentary said to be by 'Campanus of Novara.\*' That means that everything except the enunciations was by Campanus; for the early notion was that all the demonstrations were the work of editors. Of course that was entirely erroneous and, as far as the first book is concerned, a most monstrous error, since that book is one of the most deeply studied statements that ever was drawn up in any branch of thought.

The Latin text of Euclid which accompanied this commentary had been derived indirectly from an excellent Greek text, decidedly superior to the common traditional text of later times; though in certain details it was faulty. But there are many indications that the translation was not made directly from the Greek, but from the Arabic. There is said to be a 'controversy' as to whether the translation was due to Campanus or not. But as far as I can discover, the 'controversy' consists in this, that everybody who has made any independent inquiry into the matter, such as Tiraboschi and Charles Jourdain, says that the version is that of Adelard of Bath; while the German writers, none of whom have really examined the evidences, either roundly assert that it is by Campanus or decline to enter into what they call the 'controversy.'

The commentary of Campanus is very unequal. In some places, especially in the tenth book, it rises to a high level of mathematical reasoning; while in some other places it is beneath criticism. For the most part, it is very respectable.

Campanus himself has remained an obscure personage. He has usually gone

\*The colophon of the first edition reads: *Opus elementorum euclidis megarensis in geometriam artem. In id quoque campani perspicacissimi commentationes finiunt. Erhardus ratdolt Augustensis impressor solertissimus venetijs impressit. Anno salutis MCCCCLXXXII Octavis Calendis Junii. Lector Vale. Euclid was always confounded with Euclides of Megara.*

by the name of Campanus, *tout court*; but now and then he has been called Johannes Campanus. It appears that Joannes de Lyneriis, who, about 1310, wrote an 'Abbriviatio Instrumenti Campani,' so calls him; and there is other XIVth-century evidence to prove that that was his name (see Boncompagni, XVII., 733, 784). In regard to his age, a MS. work of Petrus Peregrinus, to which internal evidence assigns the date 1261, refers to the planetary tables of Campanus (Boncompagni, I., 5), while Roger Bacon is said to speak of him as still living. These facts agree with the assertion of Baldi (whose life of Campano, dated 1588, is given in Boncompagni, XIX., 591), and fully proved by Tiraboschi (*Storia della Letteratura Italiana*, Tomo IV., Libro II., capo ii., § 8), that he was chaplain of Pope Urban IV., who reigned from 1261 to 1264.

I think that I can fix the date of the commentary upon the 'Elements' within a year or so. In the collection of elementary mathematical works which have been brought together by George A. Plimpton, Esq., there is a manuscript of this commentary upon vellum, written in a very handsome, but stiff and slightly elongated, book-hand, which might have been written at any part of the last half of the XIIIth century, though I think it would be surprising to find that it was as early as 1250. Just below the colophon of this MS., where the owner of such a book frequently wrote his name, one can read in a careful cursive hand of, say, the third quarter of the XIIIth century, or thereabout, a pious sentence in the first person by 'Jacobus Dei gratia Patriarcha Jersalemitorum.' Observe that one hardly uses the phrase 'Dei gratia' except in speaking of oneself.

It can, therefore, be asserted with considerable confidence that, soon after this MS. was written, it came into the possession of a person so describable. But that could only be Jacques Pantaleone, who, having

been only a short time before elevated to the dignity of Patriarch of Jerusalem, became on the 29th of August, 1261, Pope Urban IV., the known friend of Campanus. He would naturally receive one of the first copies. Indeed, there is evidence that it was hastily given to him; for the geometrical figures are not drawn all the way through the MS., notwithstanding its being an exceptionally handsome MS., for such a work. It seems, then, that the book must have been published, say, within a year of August, 1260.

If this inference be admitted, we have in the commentary of Campanus, considering its respectable strength, occasionally its remarkable strength, additional evidence of the promising beginning of science which was made in the thirteenth century until all that sort of thing was swept away before the flood of scholasticism; while in its lapses into utter absurdity, though they are but rare, we meet with another characteristic which is marked in Petrus Peregrinus, in Roger Bacon, and in other scientific students of that period.

C. S. PEIRCE.

P. S. I notice that Moritz Cantor (II., 100) will have it that Urban reigned until 1281. Considering what a difference it would have made for the history of Sicily, for our friend Roger Bacon, and for some famous works of literature, if he had, the slip is, perhaps, worth notice.

When I can have the privilege of examining the MS. again and of consulting a library, I think I can strengthen my proof of the date of the work.

*THE AMERICAN ASSOCIATION FOR THE  
ADVANCEMENT OF SCIENCE.*

THE following is the list of those who have been elected members of the American Association for the Advancement of Science and have completed their membership from January 1 to April 30, 1901. The list

includes the names of twenty-six former members and fellows, who have since January 1st been restored to the list by payment of arrearages for more than two years.

- Adams, C. C., University of Chicago, Chicago, Ill.  
 Adams, Frederick C., Teacher of Science, Classical High School, Providence, R. I.  
 Alderson, Victor C., Dean of the Technical College, Armour Institute of Technology, Chicago, Ill.  
 Alexander, Chas. Anderson, M.E., 10 Vine St., Batavia, N. Y.  
 Alleman, Gellart, Ph.D., Instructor in Chemistry, Washington University, St. Louis, Mo.  
 Alpers, Wm. C., 45 West 31st St., New York City.  
 Ames, Oakes, Assistant Director of the Botanic Garden of Harvard University, North Easton, Mass.  
 Appleton, John Howard, Professor of Chemistry, Brown University, Providence, R. I.  
 Ashmead, Wm. H., Department of Insects, U. S. National Museum, Washington, D. C.  
 Baekeland, Leo, M.D., 'Snug Rock,' North Broadway, Yonkers, N. Y.  
 Baerecke, John F., Ph.D., M.D., Professor of Biology, Stetson University, DeLand, Fla.  
 Bagby, J. H. C., Dept. Physical Science, Hampden-Sidney College, Hampden-Sidney, Va.  
 Baker, James H., President of the University of Colorado, Boulder, Colo.  
 Ball, Elmer Darwin, Assistant Professor of Zoology, Agricultural College, Fort Collins, Colo.  
 Ball, Miss Helen Augusta, 43 Laurel St., Worcester, Mass.  
 Bancroft, Frank Watts, Ph.D., Instructor in Physiology, University of California, Berkeley, Cal.  
 Bancroft, Wilder Dwight, Instructor in Chemistry, Cornell University, Ithaca, N. Y.  
 Bardeen, Charles Russell, Anatomical Laboratory, Wolfe and Monument Sts., Baltimore, Md.  
 Barr, Charles Elisha, Professor of Biology, Albion College, Albion, Mich.  
 Bauder, Arthur Russell, Instructor in Physics, Boardman High School, New Haven, Conn.  
 Beach, Miss Alice M., 932 W. Illinois St., Urbana, Ill.  
 Beach, Charles Coffing, M.D., 54 Woodland St., Hartford, Conn.  
 Beede, Joshua William, Atchison County High School, Effingham, Kans.  
 Beers, M. H., 410 Broadway, New York City.  
 Bentley, Wray Annin, Instructor in Metallurgy, Columbia University, New York City.  
 Bergström, John Andrew, Ph.D., Associate Professor of Psychology and Pedagogy, Indiana University, Bloomington, Ind.

- Berkey, Charles Peter, Ph.D., Instructor in Mineralogy, University of Minnesota, Minneapolis, Minn.
- Berry, Edward W., News Building, Passaic, N. J.
- Biggs, Charles, 13 Astor Place, New York City.
- Billings, Miss E., 279 Madison Avenue, New York City.
- Billings, Miss Laura, 279 Madison Avenue, New York City.
- Bishop, L. B., M.D., 77 Whitney Avenue, New Haven, Conn.
- Blaok, Newton Henry, Master of Science in Roxbury Latin School, Boston, Mass.
- Blake, Joseph A., M.D., 601 Madison Avenue, New York City.
- Blakeslee, Olin Safford, Wesleyan University, Middletown, Conn.
- Blasdale, Walter Charles, Ph.D., Instructor in Chemistry, University of California, Berkeley, Cal.
- Boas, Emil L., 37 Broadway, New York City.
- Boas, Dr. Franz, Am. Mus. Nat. History, Central Park, New York City.
- Bolton, Thaddeus L., Ph.D., Dept. Philosophy, University of Nebraska, Lincoln, Nebr.
- Boon, John Daniel, Professor of Physics, Chemistry and Geology, Granbury College, Granbury, Texas.
- Bouton, Charles Leonard, Instructor in Mathematics, Harvard University, Cambridge, Mass.
- Bowlus, E. Lingan, Professor of Biology, Mt. Union College, Alliance, Ohio.
- Brackett, C. F., Princeton University, N. J.
- Bradley, Walter Parke, Ph.D., Professor of Chemistry, Wesleyan University, Middletown, Conn.
- Brewer, Charles Edward, Professor of Chemistry, Wake Forest College, Wake Forest, N. C.
- Brewster, George Richard, Newburgh, N. Y.
- Brooks, Morgan, Professor of Electrical Engineering, University of Nebraska, Lincoln, Nebr.
- Brown, Amos Peaslee, Ph.D., Assistant Professor of Geology and Mineralogy, University of Pennsylvania, Philadelphia, Pa.
- Brown, Stewardson, Germantown, Pa.
- Brown, W. L., 42 West 72d St., New York City.
- Bruner, Henry Lane, Ph.D., Professor of Biology, Butler College, Indianapolis, Ind.
- Bruner, Lawrence, Professor of Entomology, University of Nebraska, Lincoln, Nebr.
- Buist, John Robinson, M.D., City Board of Health, Nashville, Tenn.
- Bullard, Warren Gardner, Ph.D., Instructor in Mathematics, Syracuse University, Syracuse, N. Y.
- Bunker, Henry A., M.D., 158 Sixth Avenue, Brooklyn, N. Y.
- Burt, Edward Angus, Ph.D., Professor of Natural History, Middlebury College, Middlebury, Vt.
- Butler, Frank Edward, A.M., Th.G., President of Grayson College, Whitewright, Texas.
- Butterfield, Arthur Dexter, Assistant Professor of Mathematics, University of Vermont, Burlington, Vt.
- Cain, William, Professor of Mathematics, University of North Carolina, Chapel Hill, N. C.
- Calder, George, 105 East 22d St., New York City.
- Campbell, Douglas H., Stanford University, Cal.
- Campbell, William Wallace, Director of Lick Observatory, Mt. Hamilton, Cal.
- Carey, E. P., Professor of Chemistry, Physics and Geology, University of the Pacific, College Park, Cal.
- Carroll, James, M.D., U. S. A., Washington, D. C.
- Carroll, James J., Waco, Texas.
- Carter, Henry C., 475 West 143d St., New York City.
- Caswell, W. H., M.D., 201 West 55th St., New York City.
- Cathcart, Miss J. R., The Barnard, 71st St. and Central Park, New York City.
- Cattell, H. W., M.D., 3709 Spruce St., Philadelphia, Pa.
- Chamberlain, Charles Joseph, Dept. of Botany, University of Chicago, Chicago, Ill.
- Chamberlain, W. E., M.D., 111 Water Street, New York City.
- Chambers, Frank R., 569 Broadway, New York City.
- Chandler, Elwyn Francis, Instructor in Mathematics, University of North Dakota, University P. O., N. Dak.
- Channing, Walter, M.D., Brookline, Mass.
- Cheesman, T. M., M.D., Garrison-on-Hudson, N. Y.
- Chester, Wayland Morgan, Associate Professor of Biology, Colgate University, Hamilton, N. Y.
- Child, Charles Manning, Instructor in Zoology, University of Chicago, Chicago, Ill.
- Chisholm, Hugh J., 813 Fifth Avenue, New York City.
- Chisolm, George E., 19 Liberty Street, New York City.
- Chittenden, Russell H., Director of Sheffield Scientific School of Yale University, New Haven, Conn.
- Church, E. D., Jr., 63 Wall Street, New York City.
- Church, Royal Tyler, Turin, Lewis County, N. Y.
- Clark, Edmund, 105 Beech St., Flushing, L. I., New York.
- Clark, Gaylord Parsons, Professor of Physiology, Syracuse University, Syracuse, N. Y.
- Clark, Herbert A., Professor of Physics and Chemistry, High School, Kansas City, Kansas.
- Clark, Hubert Lyman, Ph.D., Professor of Biology, Olivet College, Olivet, Mich.



- Clarke, James Frederick, M. D., Fairfield, Iowa.  
 Clarke, Samuel Fessenden, Williamstown, Mass.  
 Cockerell, T. D. A., Professor of Biology, Agricultural College, East Las Vegas, New Mexico.  
 Cockran, Hon. W. Bourke, 31 Nassau St., New York City.  
 Coffin, C. A., 44 Broad St., New York City.  
 Collett, Samuel Williamson, Professor of Science, High School, Xenia, Ohio.  
 Collier, Price, Tuxedo Park, N. Y.  
 Conklin, E. G., Professor of Biology, University of Pennsylvania, Philadelphia, Pa.  
 Coulter, John M., University of Chicago, Chicago, Ill.  
 Cook, James B., Randolph Building, Memphis, Tenn.  
 Corter, William Harrison, Professor of Mathematics, Stone Mountain, Ga.  
 Craig, Wallace, 624 Howes St., Ft. Collins, Colo.  
 Crane, James M., Board of Education, Newburgh, N. Y.  
 Cranford, J. P., Wakefield, New York City.  
 Crocker, Francis B., Professor of Electrical Engineering, Columbia University, New York City.  
 Cryer, Matthew H., M.D.; 1420 Chestnut St., Philadelphia, Pa.  
 Curtis, Charles B., 9 East 54th St., New York City.  
 Cushing, John J., 1001 Union Trust Bldg., Cincinnati, Ohio.  
 Cushman, Allerton Seward, Ph.D., Instructor in Chemistry, Bryn Mawr College, Bryn Mawr, Pa.  
 Cushny, Arthur R., Professor of Materia Medica and Therapeutics, University of Michigan, Ann Arbor, Mich.  
 Cutler, Colman Ward, M.D., 36 East 33d St., New York City.  
 Cutter, W. D., College of Physicians and Surgeons, New York City.  
 Daniel, John, Professor of Physics, Vanderbilt University, Nashville, Tenn.  
 Davis, George S., Detroit, Mich.  
 Davis, Herman S., International Latitude Station, Gaithersburg, Md.  
 Davis, N. S., Jr., 291 Huron St., Chicago, Ill.  
 Dawson, Percy Millard, M.D., Johns Hopkins Medical School, Baltimore, Md.  
 Day, William Scofield, Tutor in Physics, Columbia University, New York City.  
 Delafond, E., Ingenieur Chimiste, San Juan, Porto Rico.  
 Dennis, David Worth, Professor of Biology, Earlham College, Richmond, Indiana.  
 Deveraux, W. B., 99 John St., New York City.  
 Dexter, Franklin, M.D., Associate Professor of Anatomy, Harvard Medical School, Boston, Mass.  
 Dimock, Mrs. Henry F., 25 East 60th St., New York City.  
 Dodge, Chas. Richards, U. S. Department of Agriculture, Washington, D.C.  
 Dodman, Alfred C., Jr., 235 West 108th St., New York City.  
 Dowell, Philip, Ph.D., Professor of Natural Science, Muhlenberg College, Allentown, Pa.  
 Downs, Edgar Selah, Assistant in Physics, Yale University, New Haven, Conn.  
 Droppers, Garrett, President of the State University, Vermillion, S. Dak.  
 Duane, William, Ph.D., Professor of Physics, State University, Boulder, Colo.  
 DuBois, Wm. E. B., Professor of Economics and History, Atlanta University, Atlanta, Ga.  
 Duke, Frank Williamson, Professor of Mathematics, Hollins Institute, Hollins, Va.  
 Dunstan, A. St. C., Professor of Electrical Engineering, Polytechnic Institute, Auburn, Ala.  
 Duval, Edmund P. R., Austin, Texas.  
 Dwight, Thomas, M.D., Harvard Medical School, Boston, Mass.  
 Eckles, C. H., Instructor in Dairy Bacteriology, Iowa State College, Ames, Iowa.  
 Ehrenfeld, Frederick, Ph.D., Instructor in Geology, University of Pennsylvania, Philadelphia, Pa.  
 Eiesland, John, Ph.D., Professor of Mathematics, Thiel College, Greenville, Pa.  
 Elliott, George T., M.D., 36 E. 35th St., New York City.  
 Ellis, H. Bert, M.D., 243-246 Bradbury Block, Los Angeles, Cal.  
 Enders, Howard Edwin, Professor of Biology, Lebanon Valley College, Annville, Pa.  
 English, William Thompson, M.D., Professor of Physical Diagnosis, Western University of Pennsylvania, Pittsburg, Pa.  
 Eno, A. F., 32 Fifth Avenue, New York City.  
 Epper, Rev. Frowin, O.S.B., Mt. Angel, Oregon.  
 Esmond, Darwin W., Newburgh, N. Y.  
 Faile, Thomas H., 45 South St., New York City.  
 Falk, Gustav, 24 East 81st St., New York City.  
 Farrand, Livingston, Columbia University, New York City.  
 Faight, John B., Professor of Mathematics, Northern State Normal School, Marquette, Mich.  
 Fay, L. G., Naval Office, 20 Exchange Place, New York City.  
 Findlay, Merlin C., Professor of Biology, Park College, Parkville, Mo.  
 Fisher, Irving, Professor of Political Economy, Yale University, New Haven, Conn.

- Fisher, Robert Jones, 614 F St., N. W., Washington, D. C.
- Fisk, Herbert F., Principal of the Academy, Northwestern University, Evanston, Ill.
- Fiske, Thomas S., Columbia University, New York City.
- Fleming, Dudley D., 249 Washington St., Jersey City, N. J.
- Fletcher, Andrew, 339 West 77th St., New York City.
- Flint, Austin, M.D., LL.D., Professor of Physiology, Cornell University Medical College, New York City.
- Foote, Warren M., Credit Lyonnais, Dept. d'Etranger, B'd. des Italiens, Paris, France.
- Poster, Lafayette Lumpkin, President of the Agricultural and Mechanical College of Texas, College Station, Texas.
- Poster, William, Newburgh, N. Y.
- Fraenkel, Joseph, M.D., 46 East 75th St., New York City.
- Frankland, Frederick W., 346 Broadway, New York City.
- Freeborn, George C., M.D., 215 West 70th St., New York City.
- Freedman, William Horatio, Professor of Electrical Engineering, University of Vermont, Burlington, Vt.
- Freeman, Charles, Ph.D., Director of Clark Chemical Laboratory, Westminster College, New Wilmington, Pa.
- Freer, Paul C., Ann Arbor, Mich.
- Freley, Jasper Warren, Wells College, Aurora, N. Y.
- Frost, William Dodge, Instructor in Bacteriology, University of Wisconsin, Madison, Wis.
- Fuller, George W., 220 Broadway, New York City.
- Fuller, Myron L., Assistant Geologist, U. S. Geological Survey, Washington, D. C.
- Fulton, Weston Miller, Instructor in Meteorology, University of Tennessee, Knoxville, Tenn.
- Gager, C. Stuart, Professor of Biologic Science, New York State Normal College, Albany, N. Y.
- Garrett, Hon. John W., 11 South Street, Baltimore, Md.
- Gates, Fanny Cook, Instructor in Physics, Woman's College, Baltimore, Maryland.
- Geisler, Joseph F., New York Mercantile Exchange, New York City.
- Genthe, Karl Wilhelm, Instructor in Zoology, University of Michigan, Ann Arbor, Mich.
- Gifford, John Clayton, Assistant Professor of Forestry, New York State College of Forestry, Ithaca, N. Y.
- Gillette, C. P., Professor of Zoology, Agricultural College, Fort Collins, Colo.
- Gleason, W. Stanton, M.D., Newburgh, N. Y.
- Glenn, L. C., Ph.D., Professor of Geology, Vanderbilt University, Nashville, Tenn.
- Gordon, Reginald, Columbia University, New York City.
- Gouldy, Miss Jennie A., Newburgh, N. Y.
- Graham, R. D., 35 Wall St., New York City.
- Green, Horace, 80 E. Washington Sq., New York City.
- Greene, Charles Wilson, Ph.D., Professor of Physiology, State University of Missouri, Columbia, Mo.
- Gregory, Herbert E., Yale University, New Haven, Conn.
- Griffith, C. J., Instructor in Dairying, Agricultural College, Fort Collins, Colo.
- Griffith, Herbert Eugene, Professor of Chemistry, Knox College, Galesburg, Ill.
- Griffith, John Howell, Professor of Mathematics and Civil Engineering, Clarkson School of Technology, Potsdam, N. Y.
- Griffith, W. W., Instructor in Physics, State University, Columbia, Missouri.
- Griswold, Clifford S., Head of Dept. of Physics, Groton School, Groton, Mass.
- Grover, Frederick Orville, Professor of Botany, Oberlin College, Oberlin, Ohio.
- Hague, James D., 18 Wall St., New York City.
- Hall, Edwin Bradford, Wellsville, N. Y.
- Halley, Robert Burns, Professor of Physics and Chemistry, Sam Houston Normal Institute, Huntsville, Texas.
- Halstead, Charles H., Board of Park Commissioners, Newburgh, N. Y.
- Haslacher, Jacob, 100 William St., New York City.
- Hard, Jas. M. B., Orizaba, Mexico.
- Hastings, Edwin George, Assistant Bacteriologist, College of Agriculture, University of Wisconsin, Madison, Wis.
- Hatcher, John Bell, Carnegie Museum, Pittsburg, Pa.
- Havemeyer, John C., Yonkers, N. Y.
- Havemeyer, W. F., 32 Nassau St., New York City.
- Hazard, R. G., Peace Dale, R. I.
- Heald, Fred. DeForest, Ph.D., Professor of Biology, Parsons College, Fairfield, Iowa.
- Hedgecock, George Grant, University of Nebraska, Lincoln, Nebr.
- Heller, Napoleon B., Professor of Mathematics and Astronomy, Fort Worth University, Fort Worth, Texas.
- Henderson, William Edward, Ph.D., Ohio State University, Columbus, O.
- Hering, Daniel Webster, Professor of Physics, New York University, University Heights, New York City.

- Herrick, Glenn W., Professor of Biology, A. & M. College, Agricultural College P. O., Miss.
- Herter, Christian A., M.D., 819 Madison Avenue, New York City.
- Hewett, Edgar L., President New Mexico Normal University, East Las Vegas, N. M.
- Hodge, Frederick Humbert, Professor of Mathematics, Bethel College, Russellville, Ky.
- Holmes, Miss Mary S., 1331 N. Twelfth St., Philadelphia, Pa.
- Hopkins, George B., 25 West 48th St., New York City.
- Hornung, Christian, Professor of Mathematics and Astronomy, Heidelberg University, Tiffin, Ohio.
- Howard, Orson, M.D., Professor of Biology, University of Utah, Salt Lake City, Utah.
- Howard, S. Francis, Professor of Chemistry, Mass. Agric. College, Amherst, Mass.
- Howe, Henry M., Columbia University, New York City.
- Howe, Herbert Alonzo, Director of the Chamberlin Observatory, University of Denver, University Park, Colo.
- Howe, J. Morgan, M.D., 12 West 46th St., New York City.
- Howell, John W., Ballantine Parkway, Newark, N. J.
- Howell, William H., Ph.D., M.D., Professor of Physiology, Johns Hopkins University, Baltimore, Md.
- Hower, Harry Sloan, Instructor in Physics, Case School of Applied Science, Cleveland, Ohio.
- Howerth, Ira Woods, Instructor in Sociology, University of Chicago, Chicago, Ill.
- Hoyt, Alfred M., 934 Fifth Avenue, New York City.
- Huber, G. Carl, M.D., Junior Professor of Anatomy and Director of Histological Laboratory, University of Michigan, Ann Arbor, Michigan.
- Hull, Gordon Ferrie, Professor of Physics, Dartmouth College, Hanover, N. H.
- Hun, Henry, M.D., Professor of Diseases of the Nervous System, Albany Medical College, Albany, N. Y.
- Hunter, Samuel John, Associate Professor of Entomology, University of Kansas, Lawrence, Kansas.
- Hyde, Miss Edith E., U. S. National Museum, Washington, D. C.
- Iorns, Martin J., Professor of Science, Fort Worth University, Fort Worth, Texas.
- Jacobs, Henry Barton, M.D., Instructor in Medicine, Johns Hopkins Medical School, Baltimore, Md.
- Jarvis, Samuel M., 1 West 72nd St., New York City.
- Jesup, James R., 555 Fifth Avenue, New York City.
- Johns, Carl, Instructor in Biology, Bethany College, Lindsborg, Kans.
- Johnson, Frank Edgar, 747 Warburton Avenue, Yonkers, N. Y.
- Johnstone, William Bard, Assistant in Physics, Columbia University, New York City.
- Johannott, Edwin Sheldon, Ph.D., Rose Polytechnic Institute, Terre Haute, Ind.
- Jones, Charles C., M.D., Galveston, Texas.
- Jones, Lynds, M.Sc., Instructor in Zoology, Oberlin College, Oberlin, Ohio.
- Jones, Philip Mills, M.D., Mills Building, San Francisco, Cal.
- Jones, W. R. T., 1 East 39th St., New York City.
- Jordan, Edwin Oakes, Ph.D., University of Chicago, Chicago, Ill.
- Kahl, Paul Hugo Isidor, Curator of Entomological Museum, State University, Lawrence, Kansas.
- Kaufmann, Paul, M.D., Professor of Bacteriology, Pathology and Hygiene, State University, Columbia, Mo.
- Kean, Mrs. Hamilton Fish, 25 East 37th St., New York City.
- Kellogg, Vernon Lyman, Professor of Entomology, Stanford University, California.
- Kennedy, Frank Lowell, Instructor in Lawrence Scientific School, Harvard University, Cambridge, Mass.
- Kepner, Harry V., Instructor in Chemistry, Denver Manual Training High School, Denver, Colo.
- Kern, Josiah Quincy, Ph.D., 507 6th St., N. W. Washington, D. C.
- Keyser, Cassius Jackson, Instructor in Mathematics, Columbia University, New York City.
- Kimball, Arthur Lalanne, Professor of Physics, Amherst College, Amherst, Mass.
- King, Cyrus A., Ph.D., Instructor in Botany, University of Indiana, Bloomington, Ind.
- Kinney, Charles Noyes, Professor of Chemistry, Drake University, Des Moines, Iowa.
- Kirk, Elliott W., Teacher of Science in High School, Veedersburg, Ind.
- Kirschmann, A., Ph.D., Toronto University, Toronto, Canada.
- Krause, Otto H., Prospect Ave., Hackensack, N. J.
- Landis, W. W., Dickinson College, Carlisle, Pa.
- Landon, Francis C., Staatsburg-on-Hudson, N. Y.
- Lane, Alfred C., State Geologist, Lansing, Mich.
- Langsdorf, Alexander Suss, Instructor in Physics and Electrical Engineering, Washington University, St. Louis, Mo.
- Lanneau, John Francis, Professor of Applied Mathematics and Astronomy, Wake Forest College, Wake Forest, N. C.
- Lauman, George Nieman, Instructor in Horticulture, Cornell University, Ithaca, N. Y.

- Lawrence, James W., Professor of Mechanical Engineering, Agricultural College, Fort Collins, Colo.
- Leach, Miss Mary F., 74 Pitcher St., Detroit, Mich.
- Leaming, Edward, 437 West 59th St., New York City.
- Leathers, W. S., Professor of Biology, University of Mississippi, University P. O., Miss.
- Lee, Waldemar, Passaic, N. J.
- Leeds, Morris E., 3221 North 17th St., Philadelphia, Pa.
- Le Grand, Leroy, M.D., Graham, Texas.
- Le Rossignol, James Edward, Ph.D., Professor of Economics, University of Denver, University Park, Colo.
- Leslie, Miss Augusta, Newburgh, N. Y.
- Lichthardt, G., Jr., 18th and M Sts., Sacramento, Cal.
- Lillie, Frank R., Assistant Professor of Zoology, University of Chicago, Chicago, Ill.
- Ling, Charles Joseph, Instructor in Physics, Denver Manual Training High School, Denver, Colo.
- Linn, Alvin Frank, Professor of Chemistry, Wittenberg College, Springfield, Ohio.
- Little, C. A., Analyst at Lorain Steel Works, Elyria, Ohio.
- Little, Henry P., Superintendent of Union Schools, Mokenca, Ill.
- Long, William Henry, Jr., A.M., 2101 San Gabriel St., Austin, Texas.
- Loomis, Frederick B., Ph.D., Assistant in Zoology, Amherst College, Amherst, Mass.
- Lough, J. E., Professor of Psychology, State Normal School, Oshkosh, Wisconsin.
- Lowber, Rev. James William, Ph.D., 113 East 18th St., Austin, Texas.
- McAlpin, C. W., 11 East 90th St., New York City.
- McKinney, Thomas Emory, Professor of Mathematics and Astronomy, Marietta College, Marietta, Ohio.
- McLanahan, George William, 1601 21st St., N. W., Washington, D. C.
- McMahon, D. J., M.D., 239 East 21st St., New York City.
- McNulty, John J., 17 Lexington Avenue, New York City.
- Mangan, Daniel C., M.D., 95 Park Avenue, Brooklyn, N. Y.
- Mark, Edward Laurens, Director Zoological Laboratory, Harvard University, Cambridge, Mass.
- Marston, Edwin S., 291 Clinton Ave., Brooklyn, N. Y.
- Martin, W. R. H., 56 West 33d St., New York City.
- Matas, Rudolph, M.D., Professor of Surgery, Tulane University, New Orleans, La.
- Mercer, William Fairfield, Ph.D., Professor of Biology, Ohio University, Athens, Ohio.
- Merrill, Payson, 111 Broadway, New York City.
- Merrill, Joseph Francis, Ph.D., Professor of Physics and Electrical Engineering, University of Utah, Salt Lake City, Utah.
- Metcalf, Maynard M., Professor of Zoology, The Woman's College, Baltimore, Md.
- Metcalf, Wilmot V., Professor of Chemistry and Physics, Carleton College, Northfield, Minn.
- Metcalf, Captain Henry, 143 Liberty St., New York City.
- Mezes, Sidney Edward, Professor of Philosophy, University of Texas, Austin, Texas.
- Millar, John M., Escanaba, Mich.
- Miller, Edmund H., Columbia University, New York City.
- Miller, Ephraim, Professor of Mathematics and Astronomy, State University, Lawrence, Kansas.
- Miller, George N., M.D., 811 Madison Ave., New York City.
- Miller, John Craig, M.D., Professor of Natural Science, Lincoln University, Chester Co., Pa.
- Miller, Miss Louise Klein, 631 Grand Ave., Dayton, Ohio.
- Miller, Pleasant T., Temple, Bell County, Texas.
- Mills, James, Ontario Agricultural College, Guelph, Ontario.
- Mills, Samuel C., Newburgh, N. Y.
- Mitchell, Edward, 44 Wall St., New York City.
- Mitchell, Henry Bedinger, Tutor in Mathematics, Columbia University, New York City.
- Mitchell, James, Newburgh, N. Y.
- Mitchell, Roland G., 141 Water St., New York City.
- Montgomery, Edmund, M.D., Hemstead, Texas.
- Montgomery, James H., Meadville, Penna.
- Moody, William Albion, Professor of Mathematics, Bowdoin College, Brunswick, Maine.
- Moore, Ernest Carroll, Ph.D., Instructor in Philosophy, University of California, Berkeley, Cal.
- Morgan, H. A., Professor of Zoology and Entomology, State University, Baton Rouge, La.
- Morse, Albert P., Zoology, Wellesley, Mass.
- Mottier, David M., Ph.D., Professor of Botany, University of Indiana, Bloomington, Ind.
- Moulton, Forest Ray, Ph.D., Instructor in Celestial Mechanics, University of Chicago, Chicago, Ill.
- Mt. Carmel Scientific Society, Mt. Carmel, Ill.
- Nason, Frank L., West Haven, Conn.
- Nelson, Aven, Professor of Biology, University of Wyoming, Laramie, Wyoming.
- Nesmith, John W., 1100 Colfax Ave. E., Denver, Colo.
- Notestein, F. M., Professor of Mathematics and Physics, Alma College, Alma, Mich.
- Nylander, Olof O., Box 165, Caribou, Aroostook County, Maine.

- Obrig, Adolph, 'The Dakota,' 1 West 72nd St., New York City.
- Oestlund, Oscar W., Entomologist, State University, Minneapolis, Minn.
- Oglevee, Christopher S., Instructor in Biology, Lincoln University, Lincoln, Ill.
- Osborn, Frederick A., Professor of Physics, Olivet College, Olivet, Mich.
- Osborn, Mrs. W. H., 32 Park Ave., New York City.
- Osborne, Frank Russell, Professor of Physics, John B. Stetson University, DeLand, Fla.
- Osborne, George Abbott, Professor of Mathematics, Mass. Inst. of Technology, Boston, Mass.
- Osburn, Raymond Carroll, Professor of Zoology, Fargo College, Fargo, N. Dak.
- Owen, Charles Lorin, Field Columbian Museum, Chicago, Ill.
- Owen, Miss Juliette A., 306 North 9th St., St. Joseph, Mo.
- Owen, Miss Mary Alicia, 306 North 9th St., St. Joseph, Mo.
- Owens, William Gundy, Professor of Chemistry and Physics, Bucknell University, Lewisburg, Pa.
- Paddock, Wendell, Professor of Botany and Horticulture, Agricultural College, Fort Collins, Colo.
- Painter, Charles Fairbank, M.D., 372 Mulboro, St., Boston, Mass.
- Pammel, L. H., Iowa Agricultural College, Ames, Ia.
- Parker, George Howard, Assistant Professor of Zoology, Harvard University, Cambridge, Mass.
- Parker, J. B., M.D., U. S. N., Washington, D. C.
- Parmelee, H. P., 594 Cherry St., Grand Rapids, Mich.
- Parsons, Mrs. Edwin, 326 West 90th St., New York City.
- Paton, Stewart, M.D., 213 West Monument St., Baltimore, Md.
- Peabody, George Foster, 28 Monroe Place, Brooklyn, N. Y.
- Pell, Alfred, 15 East 35th St., New York City.
- Piel, G., 148 Riverside Drive, New York City.
- Piersol, George A., Professor of Anatomy, University of Pennsylvania, Philadelphia, Pa.
- Pilcher, James Evelyn, Ph.D., Professor of Sociology and Economics, Dickinson College, Carlisle, Pa.
- Pinchot, J. W., 1615 Rhode Island Ave., Washington, D. C.
- Plant, Albert, 28 East 76th St., New York City.
- Plowman, Amon Benton, Professor of Physics, Ohio Wesleyan University, Delaware, Ohio.
- Pollock, Horatio M., Ph.D., N. Y. State Civil Service Commission, Albany, N. Y.
- Porter, W. Townsend, M.D., Assistant Professor of Physiology, Harvard Medical School, Boston, Mass.
- Powel, Colonel de Veaux, 29 Broadway, New York City.
- Prentiss, Daniel Webster, M.D., 1101 14th St., N.W., Washington, D. C.
- Price, Robert Henderson, Professor of Horticulture and Mycology, A. & M. College, College Station, Texas.
- Puffer, Wm. L., Assistant Professor of Electrical Engineering, Mass. Institute of Technology, Boston, Mass.
- Purdue, Albert Homer, Professor of Geology, University of Arkansas, Fayetteville, Ark.
- Ramsey, Rolla Roy, Instructor in Physics, Indiana University, Bloomington, Ind.
- Raymer, George Sharp, E.M., Instructor in Mining, Harvard University, Cambridge, Mass.
- Raymond, Wm. G., Rensselaer Polytechnic Institute, Troy, N. Y.
- Reid, Hon. Whitelaw, 451 Madison Avenue, New York City.
- Rice, Martin Everett, Assistant Professor of Physics and Electrical Engineering, University of Kansas, Lawrence, Kansas.
- Richardson, Alonzo Blair, M.D., Superintendent of Government Hospital for Insane, Washington, D. C.
- Richardson, Major Charles A., Canandaigua, N. Y.
- Ricker, N. Clifford, Dean of the College of Engineering, University of Illinois, Urbana, Ill.
- Riggs, Robert Baird, Ph.D., Professor of Chemistry, Trinity College, Hartford, Conn.
- Riker, Samuel, 27 East 69th St., New York City.
- Ritter, William Emerson, Associate Professor of Zoology, University of California, Berkeley, Cal.
- Robb, J. Hampden, 23 Park Ave., New York City.
- Roberts, Rev. Wm. C., D.D., LL.D., President of Centre College, Danville, Ky.
- Robinson, Charles Dwight, Newburgh, N. Y.
- Rogers, Edward L., 4 East 74th St., New York City.
- Root, Hon. Elihu, Secretary of War, Washington, D. C.
- Rothschild, Jacob, Hotel Majestic, New York City.
- Roy, Arthur J., C.E., First Assistant at Dudley Observatory, Albany, N. Y.
- Runyon, William Henry, Teacher of Science, Lyons Township High School, La Grange, Ill.
- Russak, Frank, 19 East 65th St., New York City.
- Russell, James E., Dean of Teachers College, West 120th St., New York City.
- Sackett, Robert L., C.E., Professor of Applied Mathematics and Astronomy, Earlham College, Richmond, Indiana.
- Sager, Fred. Anson, Assistant Professor of Physics, University of Illinois, Urbana, Ill.

- Sanford, Fernando, Professor of Physics, Stanford University, Cal.
- Sardeson, Frederick William, Ph.D., Instructor in Geology, University of Minnesota, Minneapolis, Minn.
- Satterlee, F. LeRoy, M.D., 8 West 18th St., New York City.
- Schiedt, Richard Conrad, Professor of Biology, Franklin and Marshall College, Lancaster, Pa.
- Schieffelin, Eugene, 865 Madison Ave., New York City.
- Schlichting, Emil, Analytical Chemist, 103 North Front St., Philadelphia, Pa.
- Schmitt, A. Emil, M.D., 310 East 57th St., New York City.
- Schwarz, E. A., U. S. Department of Agriculture, Washington, D. C.
- Seal, Alfred Newlin, Ph. D., Professor of Chemistry, Girard College, Philadelphia, Pa.
- Sedgwick, William Thompson, Massachusetts Institute of Technology, Boston, Mass.
- Seligman, Isaac M., 36 West 54th St., New York City.
- Seymour, Paul Henry, 215 East 61st St., Chicago, Ill.
- Shattuck, Samuel Walker, Professor of Mathematics, University of Illinois, Champaign, Ill.
- Sheldon, John Lewis, Botanist, Lincoln, Nebraska.
- Shelton, Edward M., Box 593, Seattle, Wash.
- Shiland, Andrew, Jr., 262 West 78th St., New York City.
- Shrader, John Clinton, M.D., LL.D., President Iowa State Board of Health, Iowa City, Iowa.
- Shute, D. K., M.D., 1101 13th St., N. W., Washington, D. C.
- Sickels, I., M.D., 17 Lexington Ave., New York City.
- Skeel, Frank D., M.D., 58 East 25th St., New York City.
- Slingerland, Mark Vernon, Assistant Professor of Economic Entomology, Cornell University, Ithaca, N. Y.
- Smith, Arthur George, Assistant Professor of Mathematics, State University of Iowa, Iowa City, Iowa.
- Smith, Eugene, C.E., 317 Washington St., Hoboken, N. J.
- Smith, Rev. J. Barry, S.J., Professor of Chemistry, Georgetown University, Washington, D. C.
- Smith, James Hervey, 217 North Central Ave., Chicago, Ill.
- Smith, Thomas A., Professor of Mathematics and Physics, Beloit College, Beloit, Wis.
- Smith, William Benjamin, Professor of Mathematics, Tulane University, New Orleans, La.
- Smith, Wm. Sidney Tangier, Ph.D., U. S. Geological Survey, Washington, D. C.
- Suelling, Charles Mercer, Junior Professor of Mathematics, University of Georgia, Athens, Ga.
- Sommerfield, William I., 32 West 13th St., New York City.
- Soper, George A., Ph.D., 29 Broadway, New York City.
- Spencer, John Campbell, M.D., Medical Department, University of California, San Francisco, Cal.
- Speyas, Clarence Livingston, Associate Professor of Chemistry, Rutgers College, New Brunswick, N. J.
- Stanton, Timothy W., Paleontologist, U. S. Geological Survey, Washington, D. C.
- Starks, Edwin Chapin, Curator and Instructor, Department of Zoology, Stanford University, Cal.
- Starr, M. Allen, M.D., 5 West 54th St., New York City.
- Steer, Justin, M.D., Medical Department, Washington University, St. Louis, Mo.
- Stephens, Henry Matthew, Professor of Biology, Dickinson College, Carlisle, Pa.
- Stevens, Frederick W., Physics, Lake Forest, Ill.
- Stillhamer, Arthur G., Physics, Bloomington, Ill.
- Stone, Isabelle, Ph.D., Instructor in Physics, Vassar College, Poughkeepsie, N. Y.
- Stump, James A., Instructor in Physics, Agricultural College, Fort Collins, Colo.
- Summers, Henry E., Professor of Zoology, Iowa State College, Ames, Iowa.
- Talmage, James Edward, Ph.D., Professor of Geology, University of Utah, Salt Lake City, Utah.
- Tandberg, John P., Instructor in Physics and Chemistry, St. Olaf College, Northfield, Minn.
- Tatlock, John, Jr., 32 Nassau St., New York City.
- Taylor, Alonzo Englebert, Professor of Pathology, University of California, Berkeley, Cal.
- Thaxter, Roland, Professor of Cryptogamic Botany, Harvard University, Cambridge, Mass.
- Thelberg, Elizabeth B., M.D., Professor of Physiology and Hygiene, Vassar College, Poughkeepsie, N. Y.
- Thom, Charles, Instructor in Botany, University of Missouri, Columbia, Mo.
- Thompson, James Edwin, 3224 Broadway, Galveston, Texas.
- Thompson, W. Gilman, M.D., 34 East 31st St., New York City.
- Thorne, Mrs. Phoebe Anna, 558 Madison Avenue, New York City.
- Tiffany, L. C., 27 East 72d St., New York City.
- Tilley, Charles Edward, Teacher of Physics and Chemistry in the Hope Street High School, Providence, R. I.
- Tilson, P. S., Associate Professor of Chemistry, A. & M. College, College Station, Texas.
- Tingle, J. Bishop, Assistant Professor of Chemistry, Lewis Institute, Chicago, Ill.

- Titus, E., Jr., 10 East 70th St., New York City.  
Tower, Olin F., Ph.D., Instructor in Chemistry, Adelbert College, Cleveland, Ohio.  
Trask, Spencer, 27 Pine St., New York City.  
Trimble, Robert E., Assistant Meteorologist and Irrigation Engineer, Agricultural College, Fort Collins, Colo.  
Trowbridge, Charles Christopher, Tutor in Physics, Columbia University, New York City.  
Tucker, Richard Hawley, C.E., Astronomer, Lick Observatory, Mt. Hamilton, Cal.  
Tufts, Frank Leo, Tutor in Physics, Columbia University, New York City.  
Tuohy, John, Tulare, California.  
Turnbull, Thomas, Jr., M.D., Assistant Professor of Practice of Medicine, Allegheny University, Allegheny, Pa.  
Tyler, Ansel Augustus, Ph.D., Professor of Science in Bellevue College, Bellevue, Nebr.  
Vail, Miss Anna Murray, 29 Washington Sq., New York City.  
Van Amringe, John Howard, Professor of Mathematics, Columbia University, New York City.  
Vanderpoel, Frank, M.D., 153 Center St., Orange, N. J.  
Van Duyn, John, M.D., 318 James St., Syracuse, N. Y.  
Van Dyck, William Van Bergen, Instructor in Electricity, Rutgers College, New Brunswick, N. J.  
Van Gelder, Arthur P., Landing, N. J.  
Velsor, Joseph A., 105 McDonough St., Brooklyn, N. Y.  
Voris, Floyd Thomas, Professor of Natural Science, Buena Vista College, Storm Lake, Iowa.  
Votey, J. William, Professor of Civil Engineering, University of Vermont, Burlington, Vt.  
Wadman, W. E., 102 Lord Ave., Bayonne, N. J.  
Walker, John A., 260 Montgomery St., Jersey City, N. J.  
Walter, Miss Emma, 109 North 16th St., Philadelphia, Pa.  
Walter, W. J., 115 West 57th St., New York City.  
Ward, Willard Parker, Ph.D., Mining Engineer, 164 West 58th St., New York City.  
Watson, Elizabeth S., Weymouth, Mass.  
Webb, Howard Scott, Professor of Electrical Engineering, University of Maine, Orono, Maine.  
Webster, Albert Lowry, C.E., 112 East 40th St., New York City.  
Webster, Edgar H., Professor of Physical Science, Atlanta University, Atlanta, Ga.  
Welin, John E., Professor of Physics and Chemistry, Bethany College, Lindsborg, Kansas.  
Wells, Eliab Horatio, M.D., Professor of Natural Science, Baylor Female College, Belton, Texas.  
West, Haarlem E., Mining Engineer, Libby, Montana.  
Westinghouse, George, Pittsburg, Pa.  
Weygant, Colonel Charles H., Newburgh, N. Y.  
Wheeler, Alvin Sawyer, Ph.D., Assistant Professor of Chemistry, University of North Carolina, Chapel Hill, N. C.  
Wheeler, Eben S., U. S. Engineer Office, Detroit, Mich.  
Wheeler, William Morton, Professor of Zoology, University of Texas, Austin, Texas.  
Whitaker, Milton C., Columbia University, New York City.  
White, Horace, 18 West 69th St., New York City.  
Wiechmann, F. G., M.D., 771 West End Ave., New York City.  
Wilbur, Ray Lyman, M.D., Assistant Professor of Physiology, Stanford University, Cal.  
Wilkinson, John G., Newburgh, N. Y.  
Wilkinson, Levi Washington, Professor of Industrial and Sugar Chemistry, Tulane University, New Orleans, La.  
Wilcox, Miss Mary Alice, Ph.D., Professor of Zoology, Wellesley College, Wellesley, Mass.  
Williams, Charles S., 166 Montgomery St., Newburgh, N. Y.  
Williams, Frank H., Greene, New York.  
Williams, Stephen Riggs, Professor of Biology, Miami University, Oxford, Ohio.  
Williamson, Edward Bruce, Zoology, Bluffton, Ind.  
Willets, Joseph C., Skaneateles, Onondaga Co., N. Y.  
Willis, Bailey, U. S. Geological Survey, Washington, D. C.  
Wilson, Mortimer, M.D., Port Huron, Mich.  
Wilson, Henry Van Peters, Professor of Biology, University of North Carolina, Chapel Hill, N. C.  
Winters, J. E., M.D., 25 West 37th St., New York City.  
Woods, Charles D., Professor of Agriculture, University of Maine, Orono, Maine.  
Woods, James Houghton, Ph.D., Instructor in Anthropology, Harvard University, Cambridge, Mass.  
Wright, Rev. C. B. B., Ph.D., 796 Astor St., Milwaukee, Wis.  
Wright, Walter Livingston, Jr., Professor of Mathematics, Lincoln University, Chester Co., Pa.  
Yates, J. A., Professor of Natural Science, Ottawa University, Ottawa, Kansas.  
Young, Stewart Woodford, Assistant Professor of Chemistry, Stanford University, Cal.  
Zeleny, John, Associate Professor of Physics, University of Minnesota, Minneapolis, Minn.

## SCIENTIFIC BOOKS.

*Topographic Surveying*, Including Geographic, Exploratory and Military Mapping. By HERBERT M. WILSON, U. S. Geological Survey. New York, John Wiley & Sons. 1900. 205 Figures.

It is always a source of great satisfaction in picking up a book to know that the author by training and experience is qualified to speak with authority on the subject therein discussed. In the case of the book under review we have as its writer a graduate of one of our best schools of engineering, who afterwards served an apprenticeship under Mr. Henry Gannett, the master topographer, and then, after spending considerable time abroad, became one of the Division Chiefs of the Geological Survey.

Every feature of topographic work is taken up, treated exhaustively, and with the aid of illustrations and tables left in the shape deemed the most serviceable to the student. The descriptions of instruments and their adjustments are scattered through the book and the tables are inserted at the point where reference to them is first made. This is not the usual practice, and its practicability is a question of personal preference. Ordinarily we look in the back of the book for all tables and expect to find the first pages devoted to the description of instruments.

An important topic, seldom referred to, that is found in this treatise is the way in which to equip a party for field work, including the supplies needed, medicines that should be provided, and also suggestions as to how to look after the details of camp life. In this connection it might be suggested that space is given to some matters of trifling importance. However, the severest criticism that suggests itself is the frequent comparison of the work of the U. S. Coast and Geodetic Survey with that of the Geological Survey. This contrasting places the relative accuracy and cost in a misleading light and should not be so presented by an official of either organization. Then, too, the most expensive work of the Coast Survey has been to a great extent experimental, and many organizations have profited by the lessons thus learned—none more so than itself.

As, for example, the work of Professor Woodward, which resulted in perfecting the tape-line base-measuring system whereby it was possible for a single party in the Coast Survey to measure nine bases in a single season. A wrong impression is given in comparing cost and accuracy, except when great emphasis is put on the fact that the cost increases rapidly with the accuracy—apparently out of reasonable proportion. If we say that one party can execute a primary triangulation at a cost of 90 cts. a square mile with a probable error of one-tenth of a foot for each side of this square while another charges \$30 for a square mile and secures a probable error of three-hundredths of a foot, it looks as though we were paying more than thirty times as much to secure a probable error one-fourth as great. A still greater cause for comment is the statement that while both organizations demand the same degree of precision in precise leveling, one costs \$10 a mile, while the other costs only \$5.

It is far from the purpose of this review to question the accuracy of these statements, but the opinion is held that such comparisons create wrong impressions and react upon the author. It is believed that the author is in error when he says that in the topographic survey of the District of Columbia no system of bench marks was left in the course of the leveling, also that the St. Albans base was measured with the secondary apparatus, and that any form of tape-stretcher is more quickly manipulated than that used by the Coast Survey. The reason for referring to the matters just mentioned is that in the eyes of many they mar a book otherwise most excellent, and in the main practically beyond improvement.

It is safe to say that there is not a book on topography in the English language, or perhaps in any other language, that gives with such clearness and discrimination the amount of detail required for maps intended for various purposes, and the simplest and quickest methods for securing the necessary data. For this reason it is believed that it is eminently fitted for use as a text-book—a rare quality in technical treatises—as well as for a handbook for those actively engaged in topographic work.



The sketches, diagrams and maps are taken from work actually done, thereby establishing confidence in the processes described. In this connection it might be suggested that a word of caution should be uttered regarding the tendency to give the interval of contours that have been *sketched*. Beyond this one point, a careful reading has not disclosed anything but meritorious features in all that pertains to the technical side of the book.

J. H. GORE.

COLUMBIAN UNIVERSITY.

*Neudrucke von Schriften und Karten über Meteorologie und Erdmagnetismus herausgegeben von PROFESSOR DR. G. HELLMANN. No. 13, Meteorologische Beobachtungen vom XIV. bis XVII. Jahrhundert.* Berlin, A. Asher & Co. 1901. 4vo. Pp. 70 introduction and notes + pp. 130, fac-similes. Price, 18 Marks.

This is the latest of these reprints that have been reviewed from time to time in *SCIENCE*, and its object is to elucidate the beginning of meteorological observations and to eradicate the impression, which is common even among specialists, that with very few exceptions there were no continuous observations before the end of the 17th century. It is here shown that already at the close of the 15th century many series of observations existed, including some simultaneous ones, and it seems probable that regular observations of the weather were made even in very ancient times. The present volume deals with two kinds of records, meteorological observations on land—those without instruments from 1337 to 1645, and those with instruments from 1649 to 1700—and observations made at sea between 1492 and 1700.

The earliest journal of the weather extant is that kept by William Merle at Driby, in Lincolnshire, England, between the years 1337 and 1344. The Latin MS. was reproduced in facsimile, with a translation, about ten years ago by the late Mr. Symons, but, as the edition was limited and hardly went outside of England, Dr. Hellmann has thought it worth while to reprint a portion. The next oldest record (1439) is also English, and then come German, Austrian, Italian, Swiss, Belgian, Spanish and Danish observations. It is certainly not known generally that observations in Brazil preceded

those in this country, and that the first weather observations in North America were by a Swede, Johann Campanius, on the Delaware River, near Philadelphia, during 1644 and 1645, a summary of the weather for each month being given. The first observations with instruments were readings of the barometer each day during the years 1649, 1650 and 1651 in Clermont (Auvergne) and at the same time at Paris and at Stockholm. Of these only M. Périer's observations in Clermont have been preserved and they are reproduced. The original log-book of Christopher Columbus's first voyage (1492-93) no longer exists, but an extract relating to the change of weather on this side of the Canary Islands, and an account of a West India cyclone encountered on the return voyage, and which is the first description of such a storm, are quoted. There are nine other extracts from logs of early voyages, making, with the observations on land, 36 rare journals. Even if known to students, hitherto these have been practically inaccessible, but now they are presented as nearly as possible in the original form and enriched with copious notes by the best authority on the subject. These reprints have not been put on sale in America, but one or two copies of the current volume may be had at the publisher's price, viz., \$4.50, from the Blue Hill Observatory, Hyde Park, Mass.

A. LAWRENCE ROTCH.

*Die Pflanzen-Alkaloide.* Von JUL. WILH. BRÜHL, Professor an der Universität Heidelberg; in Gemeinschaft mit Edward Hjelt und Ossian Aschen Professoren an der Universität Helsingfors. Mit Eingedrucktten Abbildungen. Braunschweig, F. Vieweg und Sohn. 1900. Mk. 14.00.

The discovery of plant alkaloids belongs to the early part of the nineteenth century, and their subsequent study and investigation rank among the important achievements of modern chemistry. In 1803, Derosue, a French apothecary, obtained impure morphine from opium. In 1805, Sertürner, a German apothecary, isolated the pure alkaloid and, in 1817, recognized its basic character and showed it to be the active principle of opium. Since that time the study of alkaloidal chemistry has been steadily pro-

gressing, until from certain plants, as cinchona and poppy, at least twenty different alkaloids have been obtained.

The present monograph is a separate edition of Volume VIII. of 'Roscoe & Schorlemmer's Lehrbuch der organischen Chemie,' and treats of the plant alkaloids apart from the synthetic alkaloids and ptomaines. The author has divided this class of the alkaloids into certain fundamental groups, but has wisely not attempted to extend the classification further, having subdivided them according to the plants or families in which they occur. The main divisions are as follows: I. PYRROLIDIN GROUP, hygrine. II. PYRIDIN GROUP, trigonellin, piperin, chrysanthemin, nicotin, sparteine and cytisin, alkaloids of the Solanaceae, jaborandi, areca nut, conium, coca leaves and bark of the root of pomegranate. III. CHINOLIN GROUP, cinchona, strychnos and curare alkaloids. IV. ISOCHINOLIN GROUP, alkaloids of opium, hydrastis, berberis and corydalis. V. ALKALOIDS OF UNKNOWN CONSTITUTION as in ergot, Lycopodiaceae, Coniferae, Gnetaceae, Liliaceae, Apocynaceae, Aristolochiaceae, Buxaceae (Cactaceae), Lauraceae, Papilionaceae, Loganiaceae, Papaveraceae, Ranunculaceae, Rubiaceae, Rutaceae, and including glyco-alkaloids and other miscellaneous alkaloids.

Of the more than one hundred alkaloids, the constitution of only a comparatively few is known. In his treatment of these principles, Professor Brühl gives the following data concerning them: History, occurrence, preparation or method of isolation, physical and chemical properties and, wherever possible, the constitution, synthesis and the salts which have been studied.

Concerning the origin and purpose of the alkaloids in plant life, the author seems to agree with Guareschi that they are in the nature of waste products of the living protoplasm and that when once produced they are not again assimilated. It may be said, however, that this view is contrary to the recent researches of Barth, who has shown that in the seeds of *Datura stramonium* L. and *Conium maculatum* L. the alkaloids are located in the nucellus and that after germination they disappear. It would appear, therefore, that they, in some instances

at least, like the glucosides, are to be considered in the nature of reserve products. Then, too, the recent discovery of the glyco-alkaloids seems to favor this view.

The author has shown a masterly treatment of the chemistry of the plant alkaloids and the book is welcome as an important contribution to the subject; it is not only of special interest to the chemist and apothecary, but also to the physician, more particularly the therapist, as it is being shown that the constitution of chemical compounds has a more or less definite relation to physiological action.

HENRY KRAEMER.

PHILADELPHIA COLLEGE OF PHARMACY.

#### ENZYMES AND THEIR APPLICATION.\*

A VOLUME of 217 pp., 8vo, has recently been added to l'Encyclopédie Scientifique des Aide-Mémoire, by M.-E. Pozzi-Escot, editor of the Revue Générale de Chimie pure et Appliquée, on the subject of enzymes and their application. The book is written, as the author states in the preface, for engineers and chemists, and not for biologists. The first part of the book, including nine chapters, deals with the general problems of enzymology, classification of enzymes, secretion, chemical composition, general properties, mode of action, etc. There are some statements in the text which physiologists at least could hardly accept as facts without more proof—for example, on p. 9, that enzymes are transformed vegetable albuminoids, or on p. 17, that enzymes are immortal, and on p. 50, that the secretion of diastase depends simply on the food furnished the cell, etc. The writer's use of the word diastase is also inconsistent. Following Duclaux he uses it most often as a general term equivalent to enzyme, but on pp. 42-43 it is used as equivalent to amylase. On p. 50 amylose is used when amylase was evidently intended, also rhamnose where rhamnose was intended (p. 28). Similar typographical errors are painfully numerous.

The second part of the book deals with enzymes in their industrial applications. This, like the first part of the book, is too briefly dealt

\* 'Les Diastases et Leurs Application,' par M.-E. Pozzi-Escot. Gauthier-Villars-Masson et Cie., Paris, 1900.

with to make it valuable as a handbook, but the work will serve a good purpose in stimulating a desire on the part of the reader to know more of the subject and lead him to examine some of the more complete works.

ALBERT F. WOODS.

THE CYCLOPEDIA OF AMERICAN HORTICULTURE.\*

It is scarcely a year since the first volume of Bailey and Miller's *Cyclopedia of American Horticulture* appeared. The third volume, bringing the work down to page 1486, has now come from the press, and there is reason to hope that the concluding volume will not be delayed much beyond the end of the summer. Considering the large number of persons who have written 'copy,' the many illustrations to be selected and prepared, and the extent of the work, this promptness of publication is not only deserving of commendation but quite remarkable.

What has been said of the quality of the earlier volumes (*SCIENCE*, June 1 and August 10, 1900) applies equally to the one now under consideration. Perhaps the general reader will be most interested in the excellent brief horticultural treatment of the States the names of which begin with N to P—therefore comprising most of the great horticultural States of the country—and of the Philippines and Porto Rico, and in the articles on parks, perfumery gardening, photography as applied to horticulture, physiology of plants, plant breeding, and the correct methods of potting and pruning plants. The most extensive botanical monographs are those of *Opuntia*, *Pinus*, *Populus*, *Prunus*, *Pyrus* and *Quercus*; and the most important horticultural monographs, aside from some of these, are those of the Orange, Peach, Pear, *Pelargonium*, Pecan and *Primula*.

T.

SOCIETIES AND ACADEMIES.

THE AMERICAN PHYSICAL SOCIETY.

AT the meeting of the Society, held at Columbia University, on April 27th, Professor A. A.

\* Bailey, L. H. and Miller, W. *Cyclopedia of American Horticulture*. N-Q. Pp. xv + 432. Pl. 11 + f. 606. New York, 1901. The Macmillan Company. Price, \$5.00.

Michelson, of Chicago, was elected president to fill the vacancy caused by the death of Professor H. A. Rowland, and Professor A. G. Webster, of Clark University, was elected vice-president. The following resolution was adopted and made a part of the minutes:

The Physical Society desires to record its deep sense of sorrow for the death of its late president, Professor H. A. Rowland, and its appreciation of his services to science. By his brilliant researches he did much to advance our knowledge of physics, and by his work as a professor he stimulated many students to greater zeal for accurate scholarship and scientific investigation. His interest in the Society was shown from its beginning, and it owes much to the care with which he watched over the organization. By his death the Society, the science which it represents, and our country have sustained a loss which will be severely felt.

At the same meeting of the Physical Society Professor S. W. Stratton gave an account of the organization of the National Bureau of Standards which is to be established at Washington, and which, it is hoped, will prove of great value both to the scientific workers of the country and to manufacturers.

A paper by Mr. Bergen Davis on a 'New Phenomenon produced by Stationary Sound Waves' described some interesting quantitative experiments with organ pipes. The apparatus and methods employed by Mr. Davis gave results in close accord with what theory would predict, and they make it appear possible to bring the experimental study of these subjects on to an exact quantitative basis.

Mr. H. J. Hotchkiss presented a paper on the 'Counter E. M. F. of the Electric Arc,' giving an account of an experimental study of one phase of this much-discussed question. Mr. Hotchkiss employed an oscillograph, of a type which he has developed and used in numerous previous investigations, to determine whether the arc contains a counter electromotive force which lasts for an appreciable time after the current has been removed. The period of the needle of the oscillograph was about  $1/5,000$  of a second, and a study of the curves obtained by it has led Mr. Hotchkiss to the conclusion that if a counter electromotive force does exist, which lasts as long as a ten-thousandth of a second after the current is broken, then the

average value of this E. M. F. cannot exceed  $\frac{2}{3}$  of a volt. The paper also described experiments to determine the conductivity of the arc after the circuit was broken. The conductivity was found to depend upon the direction in which current was sent through the arc, and the results seem to indicate something in the nature of a counter E. M. F., whose value is less than one volt.

Professor A. G. Webster showed a method by which the Maxwell top might be used to indicate the path of the invariable axis in a body moving under the influence of no forces. A second paper by Professor Webster described quantitative experiments with a top. The traces obtained from the top under various known conditions were found to agree satisfactorily with the predictions of theory.

A paper by Professor E. L. Nichols on the 'Efficiency of the Acetylene Flame' gave the results of experiments on this subject since the presentation of Professor Nichols' previous paper in June. The values obtained at that time have been only slightly modified by the later work.

A paper on the 'Specific Heats of Electrolytes,' by Professor W. F. Magie, gave a formula for computing the specific heat in the case of solutions in which electrolytic dissociation occurs. A comparison with experimentally determined values showed an extremely satisfactory agreement.

A paper by Mr. J. W. Miller, on the 'Elastic Properties of Helical Springs,' describing numerous experiments on this subject, completed the program.

ERNEST MERRITT.

#### CHEMICAL SOCIETY OF WASHINGTON.

THE 126th regular meeting was held April 11th, when the following program was presented:

'A New Method for the Estimation of Cane Sugar, in presence of Lactose,' by L. M. Tolman. Benzolsulphinide was used as the hydrolyzing agent, because it has no action on the rotation of lactose, even after heating for several hours, while a solution of sucrose is completely inverted in 30 minutes, by use of one-half gram of the sulphinide. The results

obtained showed that it was a satisfactory and accurate method. The method used in condensed milk was as follows: Twice the normal weight of the milk was weighed into a 200-cc. flask and 10 cc. of a 10-per-cent. solution of citric acid added to coagulate the casein. The liquor was then filtered, 75 cc. of the filtrate measured into a 100-cc. flask, one half gram of saccharine added and, after shaking, in order to break up the lumps, immersed in a boiling water bath for 30 minutes. Two cc. of acid mercuric nitrate were then added, the solution made up to volume, filtered and polarized at as near 20° C. as possible. The direct reading was taken in the ordinary way and the volume of precipitate corrected for by double dilution. The results obtained were very satisfactory.

'Classification of Alkali Soils,' by Frank K. Cameron. The views presented in this paper may be summarized as follows: (1) A classification as black alkali or white alkali, depending upon the presence or absence of sodium carbonate, is inadequate in view of our present knowledge of alkali phenomena. A more comprehensive classification is desirable. Such a classification appears to be possible on chemical grounds, considering alkali conditions as the result of the action of aqueous solutions of certain soluble salts upon less soluble salts. (2) The action of sodium chloride solutions upon gypsum is the predominating feature in certain areas and seems to be well typified by the conditions in the valley of the Pecos in New Mexico. The solubility of the gypsum is apparently much increased by the presence of the sodium chloride due to the formation of the soluble salts, sodium sulphate and calcium chloride. In such an area practically the only salts which will have to be considered in the ground solutions are sodium chloride and sodium sulphate, as well as calcium sulphate. Calcium chloride is sometimes found concentrated to a considerable extent, but usually in localized and generally small spots. Owing to its keeping the soil of these spots moister and, therefore, darker than the surrounding soils, such spots are locally known as black alkali spots. (3) The action of solutions of sodium chloride upon calcium carbonate is the predominating feature of some areas. The region about

Fresno, Cal., seems to furnish a good illustration of this class. As a result there is always found a greater or less formation of sodium carbonate, the soluble and very noxious component of black alkali, and the very soluble calcium chloride. Such regions are generally further characterized by the presence of a hardpan at a distance of a few feet below the surface and generally parallel to it, the cementing material of which is calcium carbonate. In such areas there is a tendency toward an accumulation of the soluble carbonates at the surface of the soil. Calcium chloride accumulations, in spots of comparatively restricted area, are frequent accompaniments and are often mistaken for bad black alkali spots, although the presence of soluble carbonates in more than very small quantities is an impossibility. (4) The class of alkali most commonly encountered is that in which the predominating feature is the simultaneous action of solutions of sodium chloride upon gypsum and calcium carbonate. In such an area the formation of soluble carbonates can take place to only a very limited, generally negligible, extent. The apparent increase in the solubility of the gypsum is also much less than when the calcium carbonate is not present. The alkali of the Salt Lake Valley appears to be a good illustration of this type. (5) Much less frequently other types of alkali are encountered, as at Billings, Mont., where the soluble material in the soils appears to be almost entirely sulphates. (6) Modifications of the types described above are more or less frequently found. They may possibly be of such importance as to warrant a separate classification, as, for example, the conditions found to exist in the valley of the Sevier, Utah. (7) The classification here proposed is believed to be comprehensive and is founded on scientific principles. It is elastic and will readily admit of modifications. Principles other than those now recognized in it may be introduced without the accompaniment of radical changes. It can be made as specific as the advance of our knowledge from time to time will justify.

'Chemical Examination of Alkali Soils,' by Atherton Seidell. In this paper the author pointed out the necessity for uniform methods in the examination of the water-soluble com-

pounds of alkali soils, in order that the work of various investigators may be compared. A description of the procedure and methods in use in the U. S. Department of Agriculture was given, with a full discussion of the basis therefor. The unique features are the preparation of the solution for analysis, the preliminary determination of the salt content, by means of the electrolytic bridge, and the determination of carbonates, bicarbonates and chlorides. The statement of the results was also discussed at length.

L. S. MUNSON,  
Secretary.

#### THE ONONDAGA ACADEMY OF SCIENCE.

THE 46th regular meeting of the Society was held in the Historical Rooms, on April 19, 1901.

The first paper was by Professor J. D. Wilson, entitled 'The Fauna of the Goniatite Limestone.' In most places this formation consists of two layers of rock scarcely more than two feet in thickness, but exceedingly rich in goniatites and other cephalopods. He had collected 18 varieties of goniatites, orthocerata, and related forms, nearly all of them confined to the upper layer of limestone. Recently he had found several specimens, one a coiled form, evidently related to *Gyroceras transversum*, and ornamented with nodes, but having a cross section distinctly decahedral. The name *Thoracoceras Wilsoni* is suggested. In the discussion Professor Philip F. Schneider called attention to a much smaller and less prominent fauna of the limestone, which is principally confined to the lower layer. It consists of 3 gasteropods, 2 pteropods, 1 brachiopod and 1 trilobite, thus increasing the list to 25 specimens.

The second paper, entitled 'Recent Theories as to the Cause of the Glacial Period,' was given by Dr. T. C. Hopkins of Syracuse University. He spoke briefly of several of the recent theories and carefully described the 'Atmospheric Theory.' This theory is based on the principle that slight variations in the amount of carbonic acid and watery vapor present in the atmosphere produce grave changes in its temperature, and he would entirely account for the great differences in the tempera-

ture of the past in this manner. The detail of the theory resolves itself into a question of accounting for the differences in the amount of carbonic acid present, all of which was carefully worked out and described by Dr. Hopkins.

A plan for the federation of all local societies with kindred interests was favorably discussed.

PHILIP F. SCHNEIDER,  
*Corresponding Secretary.*

THE BACONIAN CLUB, STATE UNIVERSITY OF IOWA.

THE following formal papers have been read during the current year:

- 'Forestry in Iowa': Assistant Professor B. Shimek.
- 'The Extent and Significance of Food Adulterations': Dr. E. W. Rockwood.
- 'The Geology and Scenery of the Pipestone Region': Professor Samuel Calvin.
- 'Some Features of the Architecture in Westminster Abbey': Dr. J. G. Gilchrist.
- 'Jelly Fishes and their Relation to the Hydroid Colony': Professor C. C. Nutting.
- 'Three Famous Problems in Geometry': Dr. J. V. Westfall.
- 'A Sketch of the Geology of Canada': Mr. R. D. George.
- 'The Rôle of Insects in the Spread of Diseases': Dr. W. L. Biering.
- 'The Mechanics of a Harp String': Professor Laenas G. Weld.
- 'Concerning the Scope of University Training': Professor Launcelot W. Andrews.
- 'The Psychology of Profanity': Professor G. T. W. Patrick.
- 'The Lost Art of Wood Engraving': Mr. John Springer.
- 'Some Features of the Road Problem': Professor A. V. Sims.
- 'The Inscribed Polygon of Seventeen Sides': Assistant Professor Arthur G. Smith.
- 'The Sympathetic Relation of the Two Eyes': Dr. F. J. Newberry.
- 'Measurement by Light Waves': Mr. Charles F. Lorenz.
- 'The Pecuniary Economy of Foods': Mr. A. M. Goettsch.
- 'Twentieth Century Protoplasm': Professor T. H. Macbride.
- 'The Psychological Theory of Organic Evolution': Dr. H. Heath Bawden.
- 'Photographic Optics': Professor A. A. Veblen.
- 'The Modern Theory of Solution': Dr. Carl von Eade.

'Railroad Construction': Mr. W. D. Weeks.

'The Causes of Blindness in Iowa': Dr. L. W. Dean.

Several of the above papers were original contributions to science and have been or will be published.

Among the voluntary reports that have been given during the year the following deserve mention as first announcements: December 7, Professor C. C. Nutting reported on the discovery of a new method of reproduction among the hydro-medusæ. The hydranth has been seen to proceed from the proboscis of the medusa, by a process of budding. December 14th, Professor A. A. Veblen exhibited a new copying-camera table which is capable of all needed adjustments. January 4th, Dr. J. G. Gilchrist reported upon the successful treatment by trephining of three cases of epilepsy of long standing. February 15th, Professor Launcelot W. Andrews exhibited a model to illustrate the process of electrolysis. The same model illustrates Faraday's law of the decomposition of chemical substances. April 26th, Miss Mabel Williams reported the discovery of 'the area-volume illusion,' according to which any dimension of a surface seems larger than the corresponding line and one face of a volume seems larger than the corresponding plane surface. The speaker has demonstrated that the illusion is due to the presence of the judgment 'there is more of it,' which exerts a subconscious influence in the perception. October 12th, the secretary exhibited a new ergograph, and April 19th, new apparatus employed in the study of the voluntary control of the pitch of the voice in singing and speaking. C. E. SEASHORE,

*Secretary.*

THE ACADEMY OF SCIENCE OF ST. LOUIS.

AT the meeting of the Academy of Science of St. Louis on the evening of May 6th, twenty-two persons present, Mr. C. F. Baker presented an embryological demonstration, including gross and microscopic specimens, covering the development of the chick during the first forty-eight hours of incubation, intended to illustrate a working course in embryology for high schools.

One person was elected to active membership.

WILLIAM TRELEASE,  
*Recording Secretary.*

ELISHA MITCHELL SCIENTIFIC SOCIETY.

At the 135th meeting of the Society on May 4th, the following papers were read:

'Transit Methods for Laying Sewer Grades': Mr. Wm. Cain.

'Acid Crystallization': Mr. Charles Baskerville.

'The Probable Complexity of Thorium': Mr. Chas. Baskerville.

'The Recent Geological Formations of the Mississippi Valley': Mr. J. A. Holmes.

CHAS. BASKERVILLE,  
*Secretary.*

#### DISCUSSION AND CORRESPONDENCE.

##### THE LARYNX AS AN INSTRUMENT OF MUSIC.

TO THE EDITOR OF SCIENCE: In this week's number of SCIENCE Professor Joseph Le Conte remarks upon Professor Scripture's description of the mode of action of the vocal chords, and quotes from a work of his own to show that the larynx 'cannot be likened to a stringed instrument nor to a reed-pipe,' continuing, "It is strange that no one has thought to liken it to an ordinary horn; a stage horn, or better, a French horn."

In Helmholtz's 'Tonempfindungen,' of which the first edition was published in 1862, occurs, under the caption, 'Membranöse Zungen,' the following statement: 'Als musikalische Instrumente kommen nur zwei Arten solcher membranöser Zungen in Betracht, nämlich die menschlichen Lippen beim Anblasen der Blechinstrumente und der menschliche Kehlkopf in Gesänge.'

This is the exact comparison suggested by Professor Le Conte. There follows a minute description of the mode of action of the vocal chords, and of the action of the lips in blowing a horn, which has never needed any improvement or correction. Both these cases are, very properly as it seems to me, classified under reed pipes, the sorts of reeds described being of great variety. The model pictured at the head of the section, for the study of membranous reeds, is certainly, as I think will be admitted by anyone who has made one, a very convincing demonstration of the mode of action of the

larynx. Professor Scripture's elastic cushions are certainly to be classified as reeds.

ARTHUR GORDON WEBSTER.

CLARK UNIVERSITY, May 17, 1901.

##### THE NEW COMET.

TO THE EDITOR OF SCIENCE: In SCIENCE for May 3d, page 717, appears an announcement of the discovery of the new comet, to which is added a section, stating that Professor Frost, of the Yerkes Observatory, had observed the comet on the morning of April 27th, just before sunrise. The last number of the *Astronomical Journal* also contains a similar statement, saying the comet was seen by him 20 minutes before sunrise, half an hour afterwards, and 15° north of the sun.

Here at the Naval Observatory two of the computers, and also I, myself, hunted diligently for the comet, both in the morning and evening, for several days after the receipt of the first telegram, and until we had positive information on the direction of motion.

Now that a set of elements of the comet has been received, it is perfectly clear that whatever Professor Frost sighted on April 27th, it was not the comet. On that day the object was 13° south of the sun, and very close to it in right ascension.

Moreover, as seen from the Yerkes Observatory, it would not rise until about 40 or 45 minutes after the sun, as any one can easily demonstrate by computing the place of the comet for that day, the semi-diurnal arc for it and the sun, for Yerkes Observatory, and take the difference between those two quantities.

GEORGE A. HILL.

NAVAL OBSERVATORY, WASHINGTON,  
D. C., May 16, 1901.

##### THE TEACHING OF PHYSIOLOGY IN THE PUBLIC SCHOOLS.

ABOUT two years ago I wrote a letter for SCIENCE concerning the text-book in physiology adopted by the State Board and used throughout the public schools of Kansas. Much dissatisfaction has been expressed by the more intelligent teachers of the State, but there is, nevertheless, no redress—the book must be used as a text in every school in the State.

The results may be inferred. I can exemplify them no better than by giving some of the actual answers to questions in physiology by high school candidates who had just been passed in physiology in the grammar grades.

'Pleurisy is a disease of the skin'—'an indication that some nerve has been affected.'

'Alcohol, tobacco and opiates thicken the blood of the nerves.'

'The respiratory center is in the heart.'

'The heart is the center of respiration.'

'Residual air is the air in the heart.'

'The body should be bathed frequent'—'should be bathed at least once a year.'

'Appendicitis and pleurisy is a condition of the throat.'

'The blood is carried to the liver through the right and left auricles.'

'The meatus auditorius is in the intestines'—'is an artery leading from the heart'—'is in the eye'—'is a tube in which the blood passes through before entering the stomach.'

'The patella is a network of small blood vessels'—'is the lining of the abdomen'—'is a tube in the chest'—'is a muscle over the knee.'

'The motores oculi is in the veins'—'is an organ of voice.'

'The mitral valve is at the lower end of the stomach'—'is located in the liver.'

'Excretion is mingling with saliva,' etc., etc.

Such absurdities are by no means rare in the Kansas schools. For several years it was the writer's duty to pass upon the papers in physiology of candidates for the State teachers' certificate, and many answers as ridiculous as any of the above, were observed. Thus: to the question 'Why does the human body cease to grow in stature after about the twenty-fifth year?' the reply was almost invariably, 'Because it has got its full growth.' Four out of fifteen answered the question as to what the lymphatic system is by saying that it is a system of vessels that take up the impurities of the blood and discharge them into the kidneys! It was the rare exception that the papers came up to the standard of a respectable high school.

The worst of it all is that many intelligent people defend such ignorance by saying that

you must not expect teachers in the public schools to be experts in physiology. Is it not time that such 'science' is banished from the public schools? I do not know whether Kansas is an exception in this particular, as it is perhaps in some others, to the other States of the Union. Certain it is, however, that such defects cannot be ascribed to the public school system of the State in general, for I honestly believe that this stands on a higher plane than in a majority of the other States. Is public school physiology everywhere a farce?

S. W. WILLISTON.

#### SHORTER ARTICLES.

##### UNILATERAL COLORATION WITH A BILATERAL EFFECT.\*

WHILE describing the larval eels or Leptocephali belonging to the United States National Museum two specimens claimed especial attention. Structurally these two specimens are very different and might readily be referred to distinct species. In one the nares are approximated, and the pectorals are well developed, in the other the nasal openings are wide apart and the pectorals have disappeared. The index that pointed to the probability that the two specimens were different stages of the same species is their unique coloration. There are eight large black spots much larger and much more conspicuous than the color markings of any other Leptocephalus. One of these is located over the alimentary canal a short distance in front of the anus. The others are along the side. Each one of these spots is formed by a single enormous chromatophore extending laterally over three or four somites. Sometimes a few minute chromatophores are to be found at the margin of the large one. There are three of these large chromatophores on the left side of the body and four on the right. In each case the spots of one side are arranged at irregular intervals, but in both cases the spots of the one side alternate with the spots of the other side, so that together they form, even in the alcoholic specimens of these transparent

\* Contributions from the Zoological Laboratory of the Indiana University, No. 45. x



creatures, a series of seven spots placed at nearly regular distances along the middle of the side. The effect is precisely the same as if the seven spots were repeated on the two sides.

In opaque animals the color markings of the two sides approach bilateral symmetry. In the present case the markings are strikingly asymmetrical in that there are three spots on one side and four on the other. This asymmetry in the number of spots on the two sides and their positions at irregular distances from each other makes it quite certain that their arrangement

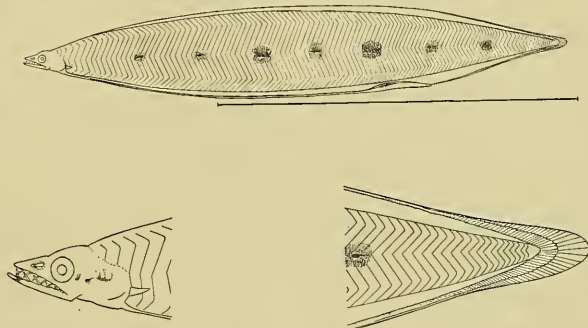

on opposite sides so as to alternate and form a series at more or less regular intervals is not accidental but the normal condition, *i. e.*, a mutual adaptation in the location of the spots of the two sides. This adaptation of the two sides to each other is emphasized in the younger specimen where the first two spots are on the right side, leaving the first forty segments of the right side without a spot.

The following are the details of the distribution of the spots on the somites, counting from the pectoral backwards:

Number of segments between the centers of successive spots.	Number of the segments and the sides on which the spots occur.
YOUNGER SPECIMEN:	
12	15-16-17 R
13	27-28-29 R
11	40-41-42 L
11	51-52-53 R
14	62-63-64-65 L
15	76-77-78 R
	91-92-93 L

OLDER SPECIMEN:

12	12-13-14 R
12	24-25-26 L
12	36-37-38 R
10	48-49-50 L
13	58-59-60 R
17	71-72-73 L
	87-88-89-90 R

The two specimens differ structurally as follows:

*A.* Body more elongate than in *AA*; pectorals a mere ridge; nostrils remote from each other

for a distance nearly equal to the diameter of the eye; leptocephalous teeth wanting; lower jaw projecting, its tip rounded and entering the profile; no pigment spots about the head; depth  $8\frac{1}{2}$  in length, head distinctly more than half the depth of the body, nearly 11 in the length; eye 7 in head,  $1\frac{1}{2}$  in snout; segments  $73 + 43$ . One specimen 51 mm. long. New Providence (type).

*AA.* Body elliptical: pectorals well developed: nostrils not yet separated: leptocephalous teeth: jaws nearly equal: a pigment spot near the end of the lower jaw, another within anterior nares, two succeeding each other between the lower margin of the pupil and the lower margins of the auditory capsule: depth 6 in the length: head little less than half greatest depth: eye five in head: segments  $76 + 38$ .

One specimen 38 mm. long. Albatross Station 2566.

The *Leptocephalus* has not been referred to

its adult form and may be termed *Leptocephalus diptychus*.

C. H. EIGENMANN,  
CLARENCE KENNEDY.

UNIVERSITY OF INDIANA.

VELOCITY OF IONS FROM ELECTRIC ARCS AND  
FROM HOT WIRES.

MUCH interest is being shown at present concerning ionization of gases and 'electron' theories of electricity. An investigation now in progress promises to throw further light on this subject, in fact to change one idea which has been held. It has been stated by eminent authorities that in the case of discharge through gases the negative ions always go faster than the positive under the same conditions. The present investigation shows that this is not always the case and a brief account of it may not be amiss.

The work had its origin in an attempt to explain the phenomena of the electric arc. It was shown in the *Physical Review*\* that all the phenomena of the arc could be explained by assuming, first, that the current in the arc was carried by ions, and second, that the positive ions move the more rapidly. The second part of this hypothesis did not at first seem probable, since in all cases which had previously been investigated the negative ions had been found to move the more rapidly. Two sets of experiments were, however, given as tending to substantiate that hypothesis, but neither of them could be considered conclusive. †

More recently experiments have been performed with ions drawn out from an arc by a charged body in the neighborhood. ‡ The positive ions in this case were found to have the greater velocity. Quite recently the same fact has been shown by an application of a

method used by Zeleny\* for finding the velocity of ions produced by X-rays. These methods are entirely independent and the agreement of the results in the two cases leaves little reason to doubt the correctness of the conclusion that the positive ions here move the more rapidly.

Of course, this is not a proof that the positive ions in the arc itself move more rapidly than the negative, but since such an assumption would explain the phenomena of the arc and since the positive ions just outside the arc do have the greater velocity, it seems reasonable to assume that they do also within the arc.

It opens up, however, a still more interesting field of inquiry, *i. e.*, that concerning the condition under which the positive ions show this peculiarity. The discharge from hot platinum and iron wires was accordingly investigated. It has long been known that positive electricity escapes from hot metals easier than negative. An examination of the velocity of the ions from the hot metals showed that here also the positive ions move the more rapidly. Both the methods used in the previous investigation led to the same conclusion.

But in all these cases the action is complicated by the fact that both gases and solids are present. For example, in the case of discharge from hot platinum wire atoms of platinum are no doubt given off, since it is a well-known fact that platinum wire when heated to a white heat decreases in weight. † It may be that because of some contact difference of potential the negative ions of the metal never escape from the metal. A comparison of positive ions of one substance with negative of another would not be of great value. One would wish to know whether the positive ions move faster than the negative ions from which they have been separated.

The case of the arc is still more complicated, for many different solid and gaseous substances enter into the arc. The investigation by Arons ‡ on the arc between metals in *H* and *N* at different pressures shows that both the terminals of the arc and the gases about it must be considered.

\* *Phil. Trans. Roy. Soc. Lon.*, 195, 193.

† *Wied. Ann.*, 37, 319.

‡ *Drude Ann.*, 1, 700.

\* *Phys. Rev.*, 10, 151.

† Since publishing the above-mentioned article I find that part of the work there described had already been described by Dewar (*Chem. News*, 45, 37). My own work was performed without knowledge of that done by Dewar, and the method used was not the same as his. The results of the two investigations agree fully. The explanation of the results offered by myself was not suggested in his article.

‡ *Phys. Rev.*, 12, 137.

Fortunately one case has been studied which is not thus complicated, *i. e.*, the arc in mercury vapor between mercury terminals. In this case only one element is to be considered, and here Arous\* found that the greater fall of potential was at the anode. In the light of the work now described we may interpret this to mean that the positive ions in such an arc move the more rapidly.

Warburg † found that in case of discharge in a vacuum tube containing some mercury vapor the fall of potential at the cathode was approximately the same as it was in nitrogen. Arous in discussing this calls attention to the fact that when discharge is taking place through a gas the greater fall of potential is at the cathode, when through a metal vapor at the anode. Possibly we may now modify this statement and say that when *gases are ionized the negative ions move the more rapidly, but that when metal vapors are ionized the positive ions move the more rapidly.* All the facts that have thus far been observed could be explained by such a hypothesis. If this should be shown to be correct, it will no doubt lead us to modify somewhat our ideas concerning the relation of metals to electricity.

C. D. CHILD.

#### MODULUS OF CONSTANT CROSS SECTION.

THE longitudinal rigidity of a solid, represented by Young's modulus, depending as it does upon both the volume elasticity and simple rigidity, leaves one condition unprovided for *viz.*: the case of longitudinal extension with cross section remaining unchanged. This case probably does not occur with an unrestricted stress, but it is easily conceived in theory. I can find no mention anywhere of a modulus of constant cross section, and have undertaken to approach the problem in this wise. Add to Young's modulus that fraction of the simple rigidity represented by Poisson's ratio. This preserves the longitudinal rigidity and restores to the new modulus the numerical measure of that portion of the strain called out by the change in lateral dimensions.

If this be a true modulus, it offers an easy

\**Wied. Ann.*, 58, 78.

†*Wied. Ann.*, 40, 10.

method of determining approximately the mechanical equivalent of heat, and provides a practical experiment for laboratories not supplied with costly and complete apparatus. Thus a brass wire of density 8.5; sp. heat, of .09, coefficient of expansion .000018, volume elasticity  $10 \times 10^{11}$ , simple rigidity  $3.7 \times 10^{11}$ , and Young's modulus  $10.4 \times 10^{11}$  gives roughly,

$$\frac{\left[10.4 \times 10^{11} + \left(\frac{22.6}{67.4} \times 3.7 \times 10^{11}\right)\right] \frac{1}{2} \times .000018}{\frac{8.5 \times .09}{3}} = 4.1 \times 10^7$$

as the value of the calorie in C. G. S. units.

BENJ. H. BROWN.

#### NOTES ON INORGANIC CHEMISTRY.

WITHIN the past few years much has been added to our knowledge of the chemistry of the alums. To the aluminum, chromium, iron, gallium, and indium alums have been added those of titanium, vanadium, manganese, and cobalt. This completed the series of alums of the metals of the period from titanium to cobalt, but beyond this no alums were known of metals outside of the third group. In the last number of the *Zeitschrift für anorganische Chemie* Professor Piccini of Florence, the discoverer of the titanium and vanadium alums, has described a series of rhodium alums, including those of potassium, ammonium, rubidium, cesium and thallium. This is of peculiar interest, since rhodium belongs to a period in which no alums have been known, and opens the question as to whether there may be other alums in the same period, which includes molybdenum and columbium. Piccini is at present endeavoring to form iridium alums, which the preparation of the rhodium alums makes seem possible.

IN a paper in the last *Berichte* of the German Chemical Society, on radio-active lead, Professor K. A. Hofmann of Munich and Eduard Strauss describe two new substances which appear to be new chemical elements. Both are found in the lead chlorid obtained from pitchblende, and are separated from the lead by fractional crystallization. The one substance possesses no radio-activity and resembles some-

what ruthenium. Its combining weight is 50.46, and hence if bivalent it would have an atomic weight of 100.92. In this case it would be the missing eka-manganese, but the authors put this forward merely as a suggestion, pending a more thorough investigation. That which would tell most strongly against this supposition is the fact that the new substance forms a white sulfate which is insoluble in water and in dilute sulfuric acid, and stable up to a temperature of 400° to 500°. The second new substance described by Hofmann and Strauss is found in the lead chlorid, both from pitchblende and from bröggerite. This substance is radio-active, though the authors express doubt as to whether the activity of the lead from these minerals is due solely to the presence of this new substance. It appears to have a combining weight of 86, from which an atomic weight of 172 would follow, provided the metal is, as would seem probable from its resemblance to lead, bivalent. It might then be a metal of the fourth group, between tin and lead, and the representative of the period, none of whose members are definitely known. Of the compounds of this element, if such it be, the sulfate alone shows radio-activity. After the action of the kathode rays the substance shows a fluorescence, which lasts for upwards of two minutes.

THE same number of the *Berichte* contains the description by Professor Hoffman and W. Prantl of a new element in the euxenite from Brevig. This euxenite, which is a complex silicate, titanate and columbate of the rare earths, iron, and aluminum, contains about two per cent. of what is supposedly zirconia. Hofmann finds that half of this is a new oxid, differing from zirconia, by its insolubility in ammonium carbonate, its giving no color reaction with curcuma, and having a combining weight of 44.4, which is nearly double that of zirconium. The atomic weight of the new element, if quadrivalent like zirconium, would be about 178. The same mineral seems also to contain another hitherto unknown element, which bears some resemblance to tantalum, but which has not yet been carefully examined.

IN spite of the incredulity with which his claims to convert phosphorus into arsenic and

antimony have been received by chemists, Fittica still continues his work upon the subject. In his latest experiments he heats amorphous phosphorus with lead oxid and boron. At 140° water is formed and after heating to 205° the residual mass is found to contain lead sulfate and the borid of nitrogen. If boric acid anhydrid is used in the place of the litharge, water, sulfuric acid and the borid of nitrogen are likewise formed, but also arsenic and sometimes antimony. From these experiments Fittica concludes that amorphous phosphorus is a compound of nitrogen, sulfur and hydrogen, and he assigns to it the formula  $N_2SH_2$ . He does not, however, furnish satisfactory proof that this represents the actual quantitative composition of phosphorus. He also admits that when amorphous phosphorus is oxidized with nitric acid no trace of sulfuric acid is formed.

J. L. H.

#### BOTANICAL NOTES.

##### INTERNATIONAL BOTANICAL ASSOCIATION.

A CALL, signed by sixteen botanists of Europe and America, has been issued for a meeting of the botanists of the world at Geneva, Switzerland, on the 7th of August next, for the purpose of organizing an International Botanical Association. In the call it is stated that the chief object of the Association will be the foundation of a bibliographic periodical, criticizing in a perfectly impartial manner all botanical publications in such a way that the more important shall be separated from those which are of less value. Other advantages to be derived from the proposed organization are presented, and correspondence with the secretary, Dr. I. P. Lotsy, of Wageningen, Holland, is solicited.

##### STOCK-POISONING PLANTS.

THE Division of Botany of the United States Department of Agriculture has recently issued a valuable bulletin (No. 26) dealing with the plants which are known to be poisonous, or which are thought to be poisonous to stock in the State of Montana. About twenty-five pages are given to a general discussion of the conditions under which poisoning occurs, and of remedies and their application. Then follow about sixty pages devoted to a few plants of the

greatest importance, viz.: death canas (*Zygadenus venenosus*), larkspurs (*Delphinium* of two species), water hemlock (*Cicuta occidentalis*), loco weeds (*Aragallus* sp.) and lupines (*Lupinus* sp.). The first is said to be the most important of all the plants reputed to be poisonous to stock in Montana. It grows everywhere in Montana in moderately moist places on open ranges, and outside of the State is found from British Columbia to South Dakota, Nebraska, Utah and California. Feeding experiments show that both leaves and bulbs are poisonous. Two species of larkspurs (*D. glaucum* and *D. bicolor*) have attracted the most attention, although other species are more or less under suspicion. The foliage is the poisonous part in these plants. Water hemlock is usually known as 'wild parsnip' and is commonly supposed to be the garden parsnip run wild, an error, of course. The roots and foliage are poisonous, and cases of poisoning of cattle, sheep and even human beings are reported. This species is very much like the eastern (*C. maculata*) in appearance and action. The loco weeds affect animals quite similarly to the related plants called loco weeds on the Great Plains. The species of most importance is *Aragallus spicatus* which is closely related to *A. lamberti* of the Missouri Valley. Several pretty species of lupines (*Lupinus*) are shown to be poisonous. These are locally known as blue peas, blue beans, wild peas, wild beans, etc., and in spite of their pretty flowers are to be placed among the noxious plants. The report devotes about a dozen pages to poisonous plants of less importance, about as many to suspected plants, and closes with a discussion of some species which have been wrongly accused of possessing poisonous properties. Thirty-six plates help to make this a very valuable and useful report.

#### NORTH AMERICAN FERNWORTS.

ABOUT twenty years ago Professor Underwood issued a little book on the ferns of the country, which has proved to be so useful that it has been revised again and again, its latest title (sixth edition) being 'Our Native Ferns and their Allies.' From time to time it has undergone considerable changes at the hands of its author, and in its latest form this is most

marked. Here the results of the latest studies both in morphology and nomenclature have been used to such an extent that the old-time fern collector will often find himself somewhat dazed and confused, unless he has kept himself well informed as to the tendencies of these later years. Thus to find the common brake under the name of *Pteridium aquilinum* instead of *Pteris aquilina*; to find *Phyllitis* substituted for *Scolopendrium*; *Dryopteris* and *Polystum* for *Aspidium*; *Filix* for *Cystopteris*; *Matteuccia* for *Struthiopteris*; and *Dennstaedtia* for *Dicksonia*, is disquieting for the botanist who learned about ferns twenty or more years ago. It shakes one's faith in the immutability of things to find old friends under unfamiliar names. For the peace of mind of such persons it would be well not to buy the later editions of systematic books, for in all of them—even the most conservative—we find many of these tiresome changes.

In a recent paper ('A List of the Ferns and Fern-Allies of North America north of Mexico, with principal Synonyms and Distribution') published by William R. Maxon in the *Proceedings of the United States National Museum* (Vol. XXIII.) our information as to the Fernworts of North America is considerably augmented. While in Professor Underwood's book the total number of entries is 279, Mr. Maxon brings them up in his list to 307. This increase is mostly due to the separate recognition and enumeration of varieties, and in part to the addition of new species and varieties. Among the new species are *Polypodium hesperum*, from western United States; *Adiantum modestum* from New Mexico; *Dryopteris aquilonaris* from Alaska; *Isoetes heterospora* and *I. hieroglyphica* from Maine; *I. harveyi* from Maine and Massachusetts; *I. gravesii* from Connecticut, besides about as many more new varieties. *Athyrium* is given generic rank and separated from *Asplenium*, carrying with it the species *thelypteroides*, *filix-foemina* and *cyclosorum*. The synonymy is considerably fuller than in Professor Underwood's book, and the ranges are often modified and extended. We note still the omission of Unalaska as one of the stations for *Adiantum capillus-veneris*, although specimens are in herbaria which were collected on that island many years ago. The ranges of *Lycopodium*

*clavatum* and *L. complanatum* should be so extended as to include Iowa, as shown by Professor Shimek's recent list of Iowa Pteridophyta.

CHARLES E. BESSEY.

THE UNIVERSITY OF NEBRASKA.

#### MUSEUM NOTES.

PUBLICATIONS OF THE CARNEGIE MUSEUM.

WITH the issue of No. 1 of the *Annals of the Carnegie Museum*, this rapidly growing institution enters upon its career as a museum of publication; the publications are to appear as *Annals* and *Memoirs*, the first in octavo form, the second in quarto, and they are to be published from time to time as material is provided. In the 'Museum Notes,' with which this number of the *Annals* begins, it is stated that the Museum is to re-open the quarry at Como, Wyoming, where Professor Marsh obtained a number of his best specimens, including a number of skulls of Dinosaurs. The first systematic paper is by E. B. Williamson, on 'The Crayfish of Allegheny County, Pa.,' and describes six species. John A. Shafer gives a 'Preliminary List of the Vascular Flora of Allegheny County, Pennsylvania,' stating that it is issued largely as an incentive to others to participate in the preparation of a fuller, more complete catalogue. While the order of arrangement is that of Gray's Manual, the author states that this is selected merely as a matter of convenience and that he is fully in accord with the nomenclature of the most recent authors. The data on which the species are admitted to the list are indicated by means of signs. J. B. Hatcher notes 'Some New and little known Fossil Vertebrates,' showing that *Platacodon nanus* is unmistakably a fish and describing the character of the dermal covering of *Claosaurus*. Of special interest is a description of the principal characters of a primitive rhinoceros, *Trigonias osborni*, of which Mr. Hatcher was so fortunate as to secure an almost complete example, the species having been founded on the anterior part of the upper jaw and a ramus of the lower jaw. The dentition was noted as of a primitive type since three incisors and a canine were present on either side of the upper jaw. The rest of

the skeleton agrees with this, the superior molars being simple in their structure, while there are four digits in the forefoot. D. A. Atkinson gives a list of 'The Reptiles of Allegheny County, Pennsylvania,' prefacing the paper with the remark that civilization means the destruction of a certain portion of the natural fauna of a region and that many species now rare in Allegheny County must have formerly been abundant, while two species have been exterminated within the last forty years, these being the prairie and the mountain rattlesnakes. In all, thirty-four species of reptiles are recorded. The concluding paper of the part is by R. W. Shufeldt on the 'Osteology of the Herodiones,' and contains a detailed description of the native genera of the group and with some foreign forms.

#### THE FIELD COLUMBIAN MUSEUM.

THE *Annual Report of the Director of the Field Columbian Museum for 1899 1900* shows a marked increase of the collections in the line of anthropology, mainly in the way of material collected from the Hopi Indians and from the western States, through expeditions sent out. In botany is noted the accession of the Patterson herbarium of 30,000 North American plants, and a series of a thousand specimens from California and Colorado. A special form of herbarium case is described and figured which is said to combine freedom of access with security from insects and the exclusion of dust. Good progress has been made in cataloguing and labeling and a large number of books and pamphlets have been added to the library, making the present total somewhat over 24,000 titles. Two courses of eight lectures each were given during the year. The total number of visitors is not stated, but we are told that there was an increase of 42,595 over the previous year. The frontispiece of the report is an excellent portrait of the late George M. Pullman, and there are a number of full-page plates showing some of the ethnological and anthropological exhibits, among them two of Mr. Akeley's fine groups of African antelopes.

#### THE SOUTH AFRICAN MUSEUM.

PARTS IV. and V. of the *Annals of the South African Museum* are to hand, the former con-

taining a detailed description of 'The Anatomy of *Opisthopterus cinctipes* Purc., with notes on other, principally South African, Onychophora,' by W. F. Purcell, including the color variations, number of legs and distribution of the species. Part V. contains a 'Description of New Species of South African Pselaphidæ,' by Achille Roffray; 'Description of Seven New Species of the Family Mutillidæ,' by L. Péringuez, and 'Description of a New Species of the Genus *Japyx*,' by the same author.

F. A. L.

#### AQUATIC RESOURCES OF THE HAWAIIAN ISLANDS.

IN compliance with a resolution of Congress, Hon. George M. Bowers, United States Commissioner of Fish and Fisheries, is arranging to send an expedition to the Hawaiian Islands to make a comprehensive study of the fishes and other aquatic resources of those islands. The investigations will be under the immediate direction of Dr. David Starr Jordan, President of Stanford University, and Dr. Barton W. Evermann, the ichthyologist of the Commission, who will have the assistance of a number of experts.

It is the intention to make the investigations sufficiently comprehensive to enable the Commission to publish a very exhaustive report on the subject. The investigations during the present summer will be by shore parties and will pertain chiefly to the following lines:

1. A thorough qualitative and quantitative study of the commercial and shore fishes, mollusks, crustaceans and other aquatic animals and plants. Attention will be given to the actual and relative food values and commercial importance of the different species, their migrations, spawning time and place, food, feeding habits, enemies, maximum and average size, and other important facts in their life-histories.

2. The methods, extent and history of the fisheries, the kinds of apparatus used, the manner of using each and the species taken in each; the manner of caring for, and disposing of, the catch; the statistics of the fisheries, value of each kind of apparatus; number and nationality

of people engaged in fishing; quantity and value of each species caught, and prices paid the fisherman, also the wholesale and retail prices; and changes in the methods of the fisheries since the coming of Americans, Europeans and Asiatics to the islands will be investigated.

3. The development of proper and just fishery laws will receive special consideration; the history of fishery legislation, including the system of tabu, and the present laws and methods with reference to each species covered by any law, special or general, and the possibility of trade in fishery products with the United States, improvement in the methods of the fisheries, and the methods of handling and marketing the fish will receive careful consideration. Attention will also be given to the possibility of fish-cultural operations with reference to such species as may be in danger of extinction or serious diminution.

Drs. Jordan and Evermann will sail for Honolulu May 30th and remain until September, when they will return to America and submit a preliminary report to Commissioner Bowers. Subsequently, they will return to Honolulu with the *Albatross* and make a study of the deep-water fauna of the islands.

The other members of the present expedition will be Dr. O. P. Jenkins, of Stanford University, Messrs. E. L. Goldsborough and John N. Cobb, of the United States Fish Commission, and Messrs. A. H. Baldwin and C. B. Hudson, who will paint in life colors the more important food-fishes of the islands. Messrs. Hudson and Baldwin are the artists who made the very accurate and beautiful colored drawings reproduced in Dr. Evermann's recent book on the Fishes and Fisheries of Porto Rico, of which Congress ordered the printing of an extra edition of 7,500 copies. It is expected that the Hawaiian report will be even more handsomely illustrated than is the report on Porto Rican fishes.

4. Mr. William H. Ashmead, Assistant Curator, Division of Insects, U. S. National Museum, will also accompany the expedition, and will make special efforts toward increasing our knowledge of the insect fauna of the archipelago.

## THE BRITISH ANTARCTIC EXPEDITION.

DR. J. W. GREGORY, who was appointed scientific leader of the British Antarctic Expedition and as such recently contributed to *Nature* a plan of the scientific work, has now stated that he cannot accept service under the regulations laid down. This resignation, for so it has been regarded by the committee, is a very severe blow to the prospects of the expedition, or at least to the scientific results that might have been expected. Some, perhaps, prophesied failure when they saw the attempt that was made from the first to place the expedition under admiralty control and naval discipline. Friction and consequent heat became inevitable when the committee proceeded to appoint two leaders—a naval and a scientific—without defining their powers from the outset. It is well known that the meetings of this committee have been a series of fights between the geographers and naval men as opposed to the purely scientific men; and Dr. Gregory has over and over again been on the point of resigning. We understand that the ultimate dispute was over the question of landing, which Dr. Gregory wished to have fixed as a main object of the expedition, and not left entirely to the discretion of an unscientific commander. But the actual cause of rupture is immaterial. The position, thanks to the naval manoeuvres, has always been an impossible one for the scientific men. While Dr. Gregory's absence in Australia has placed him at a disadvantage. Sir Clements Markham may be congratulated; but the committee will have a difficulty in finding a head for the scientific staff with half the competence of Dr. Gregory. The only satisfactory feature of the affair is that there has been no unpleasantness between members of the scientific staff, though doubtless some of them would be glad to follow Dr. Gregory's example.

## SCIENTIFIC NOTES AND NEWS.

DR. FREDERICK PETERSON, of Columbia University, has been appointed by Governor Odell the medical member of the State Lunacy Commission. Dr. Peterson's appointment at the present time is especially fortunate, owing to the complications in connection with the State Pathological Institute, which will doubtless be settled with regard to the best interests of science and the care of the insane in the State hospitals.

AT a meeting of convocation on April 20th, McGill University conferred on Dr. Robert Bell, of the Geological Survey of Canada, the degree of Doctor of Science.

DR. JACOB ERIKSSON, professor of plant physiology at the Agricultural Station, Stockholm, has been elected a member of the Stockholm Academy of Sciences.

DR. ERNST KOKEN, professor of mineralogy and geology in the University at Tübingen, has been elected a corresponding member of the Geological Society of London.

THE Geographical Society of Paris has awarded the Henri Duveyrier gold medal to Dr. Cureau and the Alexandre Boutroué silver medal to Dr. F. Weisgerber.

CAMBRIDGE UNIVERSITY has conferred the degree of D.Sc. upon Professor A. H. Church, F.R.S., in recognition of his contributions to chemical and mineralogical science.

A. S. HITCHCOCK, of the Kansas Agricultural Station, has been appointed assistant agrostologist in the United States Department of Agriculture.

DR. CLAYTON H. SHARP, instructor in physics at Cornell University, has resigned this position to become testing officer of the Lamp Testing Bureau. This bureau is a corporation organized under the laws of the State of New York, which has hitherto been engaged solely in testing incandescent lamps, but which is in the near future to establish a laboratory in New York City for testing and standardizing not only electric lamps, but also all kinds of electrical apparatus and instruments.



DR. WILLIAM H. SQUIRES, who has spent the past two years in study at the University of Munich, is expected to return in September to Hamilton College, where he has been appointed professor of psychology, logic and pedagogics.

AT the general meeting of the Royal Institution, London, on May 6th, the following vice-presidents were nominated for the ensuing season: Sir Frederick Bramwell, Sir James Stirling, Sir William Abney, Lord Kelvin, Mr. George Matthey and Mr. Frank McClean.

DR. ERNST GILG has been appointed curator of the Botanical Museum of the University of Berlin.

DR. L. O. HOWARD, chief of the Division of Entomology, U. S. Department of Agriculture, lectured at Orange, N. J., on May 16th, giving practical information in regard to the relations of mosquitoes to disease and directions for exterminating the insects.

MR. ELWOOD MEAD, expert in charge of irrigation experiments, U. S. Department of Agriculture, Washington, D. C., is in Cambridge for the month of May giving a course of lectures on irrigation to the engineering students of Lawrence Scientific School of Harvard University.

WE learn from the *British Medical Journal* that the Croonian Lectures before the Royal College of Physicians of London will be given by Professor W. D. Halliburton, F.R.S., on June 11th, 13th, 18th, and 20th. The subject of the course is 'The Chemical Side of Nervous Activity.' The Goulstonian Lectures, 'On Certain Mental States associated with Visceral Disease in the Sane,' postponed owing to the illness of Dr. Head, will be given on June 25th and 27th, and July 2d.

THE sum which is being raised for the purposes (a) of placing a bust, relief or portrait in the Bodleian Library, and (b) of forming a fund to be called the 'Max Müller Memorial Fund,' which may be held by Oxford University in trust for the promotion of learning and research in all matters relating to the history and archeology, the languages, literatures and religion of ancient India, now amounts, as we learn from

the *London Times*, to about £1,750. The subscribers include the King, the German Emperor, the King of Sweden and Norway, Prince Christian, the Duchess of Albany, the Prime Minister, the Crown Prince of Siam, a number of Indian princes, and a great many well known people in Oxford and the country generally. It is hoped eventually to raise £2,500, so that at least £2,000 may be available for the 'Memorial Fund.' Professor A. A. Macdonell is honorary secretary to the movement, and Mr. C. Grant Robertson, All Souls College, Oxford, honorary treasurer.

PROFESSOR H. G. VAN DE SANDE BAKHUYZEN, the Secretary of the International Geodetic Association, has sent from London an announcement calling attention to the death of Dr. Adolphe Hirsch, director of the Observatory at Neuchâtel. Professor Hirsch was a member of the Association, since the first meeting in Berlin in 1866, and was the following year elected secretary. This office he held for thirty-five years, having resigned it at the meeting at Paris last year, owing to the condition of his health.

DR. CHARLES RICE, chairman of the revision committee of the United States Pharmacopoeia, died in New York City on May 15th. Dr. Rice was born in Munich in 1841. He received a very thorough education in Vienna, Munich and Passau, acquiring a mastery of several oriental languages, the classics and the modern tongues. He was an accomplished linguist and was recognized as an authority on questions of philology and etymology. Dr. Rice came to America in 1862 and, during the war, served in the navy as surgeon's steward. After his discharge from service he entered the Department of Public Charities and Corrections, of New York City, and has been the chemist of that department and superintendent of its drug department for many years. He has served as chairman of the revision committee of the United States Pharmacopoeia since 1880, and, in the language of Dr. Horatio C. Wood, President of the last Pharmacopoeial Convention in May, 1900, 'has made it in its scientific accuracy, in its general usefulness and in the efficiency and elegance of its resulting preparations, the peer of the best.'

DAVID SHEPARD HOLMAN, the inventor of accessories to the microscope and other devices, died on May 13th. He was for a long time actuary of the Franklin Institute, Philadelphia, for which he frequently lectured. Recently he has been an expert in the laboratory of the Atlantic Refining Company.

THERE will be a civil service examination on June 3d for the position of soil analyst in the Bureau of Soils, Department of Agriculture, at a salary of \$750. The subjects of the examination are physical chemistry, soil analysis, soil physics and German.

THE Godard and Bertillon prizes of the Anthropological Society of Paris will be awarded during the present year. The Godard prize (500 fr.) will be given for the best memoir on an anthropological subject, and the Bertillon prize (500 fr.) for the best memoir on a subject concerned with demography. Manuscripts or publications in competition for the prizes should be in the hands of the secretary of the Anthropological Society (15 rue de l'École de Médecine, Paris) not later than July 11, 1901.

THE Federation of the Agricultural Unions of Italy has decided to offer an international prize of the value of about \$200 to be awarded to the person who discovers and makes public the best method for obtaining exact and constant results in the determination of the fineness of the flowers of sulphur and of mixtures of sulphur and copper sulphate. Competitors must send in their papers in a sealed envelope to the head office of the Federation (Ufficio direttivo della Federazione Italiana dei Consorzi agrari, Piacenza, Italy) before March 1, 1902. The papers will be examined by a special commission to be named by the Reale Accademia dei Lincei, Rome.

THE extensive herbarium of the late Dr. T. Bernard Brinton has been presented to the Botanical Garden of the University of Pennsylvania.

CABLEGRAMS to the daily papers report that the observations of the solar eclipse on the 17th instant were only partially successful, the sun being more or less obscured by clouds. The corona was of the expected minimum type,

being more diffuse and less definite than in the case of the eclipse a year ago.

A TELEGRAM was received on May 16th, at the Harvard College Observatory, from Professor R. H. Tucker, Lick Observatory, stating that Comet Queenstown was observed by Dr. R. G. Aitken, May 15<sup>h</sup>.6668 Greenwich Mean Time in R. A. 5<sup>h</sup> 38<sup>m</sup> 25.8 and Dec. + 3° 52' 12".

NEW YORK UNIVERSITY'S Hall of Fame will be dedicated on May 30th with elaborate ceremonies. The different tablets will be unveiled and addresses will be made. Professor B. L. Robinson, of Harvard University, and Professor B. D. Halsted, of Rutgers College, will unveil the tablet to Asa Gray, and Professor R. H. Thurston the tablet to Eli Whitney. The tablet to S. F. B. Morse has been assigned to the American Institute of Electrical Engineers, to be represented by Carl Hering, president, who will associate with him the president-elect. The tablet to Robert Fulton will be unveiled by James R. Croes, president, and Charles Warren Hunt, secretary, of the American Society of Civil Engineers. It has not yet been announced who will unveil the tablet to the memory of Audubon.

ACCORDING to a preliminary program, issued by the American Society of Electrical Engineers, the summer meeting of the Institute will open on August 14th, when a formal reception will be held in New York City. It is planned to spend the two following days in visits to the electrical works in the neighborhood, and on Sunday to go to Albany, traveling in part by boat up the Hudson River. On August 19th, the works of the General Electrical Company at Schenectady will be visited, after which the party will proceed by special train to Buffalo. It is proposed to hold the general meeting at Buffalo on Tuesday morning and to visit the Exposition in the afternoon. On the three following days the morning sessions will be devoted to the reading and discussion of papers. August 22d will, if possible, be devoted to an excursion to Niagara Falls, where the electrical works will be visited. The various sub-stations at Buffalo will also be open to members. The closing meeting will probably be held on August 24th.

THE Royal Society of Canada held its spring meeting at Ottawa, beginning with the meeting of the council on May 26th. We hope to publish some account of the proceedings in a subsequent issue.

THE second meeting of the Russian Surgical Congress will be held at Moscow in January, 1902 (9th, 10th and 11th), under the presidency of Professor A. Bobroff.

THE Liverpool School of Tropical Medicine will send to West Africa, during the present month, an expedition against the *Anopheles* mosquito under Major Ronald Ross. A leading Glasgow citizen has placed at the disposal of the school and Major Ross a sum of money sufficient to defray the expenses of one year's trial in some malarious city. A staff of workers with all necessary appliances will therefore be maintained at a selected West African city, attacking mosquitoes in the city and environs.

A SMALL collection of pictures, illustrative of the people of the Senegal and French Soudan and their customs, painted by M. Joseph de la Nézière, is on exhibit at the rooms of the Royal Geographical Society, London.

A CORRESPONDENT to the *London Times* writes that the meeting of the Royal Society on May 9th was strictly private, the usual admission of a certain number of the general public being suspended. The Society was engaged in discussing the report of a committee appointed to consider some means of establishing a British academy of larger scope than the existing Royal Society, which should represent philosophical-historical branches of study, as well as the more exact sciences to which the Royal Society has in the main, if not altogether, confined itself. The idea sprang out of the fact that the Royal Society has taken an active part in the formation of an international association of the principal scientific and literary academies of the world. This association is divided into two sections—scientific and literary. While the Royal Society can represent Great Britain in the scientific section, it seems that it has no organization eligible to represent Great Britain in the other section, which includes history, antiquities, philosophy, economics and so forth—subjects which may

be studied in a scientific spirit, but do not lend themselves to experiment and exact verification. The discussion, like the report upon which it was based, was inconclusive. The Royal Society shrinks from taking an active part in the formation of another academy dealing with the subjects in question, which might in various ways, and especially in its demands upon the public purse, become a serious rival to the Royal Society itself. The only alternative is that the Royal Society should enlarge itself in one way or another so as to include the studies classed on the Continent as literary. But, though more than one way of doing this has been suggested, the difficulties in every case are obvious and great. So far as can be gathered, the weight of opinion in the Royal Society is against any attempt to meet what, after all, is a rather visionary demand. If the disadvantages flowing from the want of an academy are as serious as they are represented, it is obviously the students of the subjects in question who ought to supply the need they feel. The Royal Society has a vast field for its energies in connection with its own proper work.

#### UNIVERSITY AND EDUCATIONAL NEWS.

PRESIDENT J. H. BARROWS has announced that of the \$300,000 necessary to secure the conditional gift of \$200,000, offered by Mr. John D. Rockefeller to Oberlin College, the sum of \$150,000 has already been promised.

A GIFT of \$25,000 to the Yale Bicentennial Fund has been made by William C. Whitney, of New York City.

MRS. S. H. CAMP, of Hartford, Conn., has given \$10,000 to the Philosophical Department of Yale University for a departmental library.

IN 1897 Governor Roswell P. Flower presented to Cornell University \$5,000 to found a library for the use of the New York State Veterinary College; and Mrs. Flower has now given \$10,000 to endow this library. With the books and periodicals obtained with the original gift, and those which can be obtained from year to year by the income of the endowment fund, it is believed that the Flower Library will become one of the best equipped libraries of comparative medicine in the world, and be

of great service to the live stock interests, and therefore an important factor in the prosperity of the State.

MR. WILLIAM JOHNSON, a Liverpool ship-owner, has established two fellowships in physiology and pathology, in University College, Liverpool, one open to members of British colonial universities and medical colleges; the other to foreign students and intended especially for students in the United States. The provisional regulation governing the latter fellowship are as follows:

1. This fellowship has been founded to commemorate the late John W. Garrett, of Baltimore, United States, and shall be called 'The John W. Garrett International Fellowship in Pathology and Physiology.' The value of the fellowship shall be £100 a year.

2. The fellowship shall be open to members of universities and medical schools in the United States, without, however, absolutely precluding members of other foreign schools.

3. The fellow shall be elected by the faculty, on the nomination of the professors of pathology and physiology.

4. The fellow shall be elected for one year and shall be eligible for re-election.

5. The fellow shall devote himself to research in physiology or pathology and bacteriology under the direction of the professors of physiology and pathology. He shall undertake no work which shall in any way interfere with these duties.

6. The work shall be done in the Thompson-Yates laboratories of University College, Liverpool, but, by special permission from the faculty, the fellow may be allowed to follow his investigations elsewhere.

7. The expenses of the research shall be met out of the funds of the laboratory under the direction of the professors of physiology and pathology.

THE committee of the National Educational Association on a National University met at Columbia University May 23rd. It was expected that the committee would then adopt its final report. This will doubtless be on the lines of the preliminary report that we published some time ago. A national university will not be approved, but plans for utilizing the scientific opportunities at Washington will doubtless be proposed.

DR. JOHN E. CLARK, James E. English professor of mathematics at Yale University, has retired on account of ill health. He has been

made professor emeritus, and Dr. Percy F. Smith, associate professor of mathematics, has been appointed as his successor. In the Sheffield Scientific School of the same university, Dr. Earle Raymond Hendrick, of Ann Arbor, has been appointed instructor in mathematics, and Mr. Edwin Hoyt Lockwood has been promoted to an assistant professorship of mechanical engineering.

DR. TRUMAN H. SAFFORD, professor of astronomy at Williams College, has retired from the active duties of his professorship.

AT Harvard University Dr. Jay Backus Woodworth has been promoted to an assistant professorship of geology, and James K. Whittemore has been made instructor in mathematics.

DR. JOSHUA W. BEEDE, B. S. (Washburn College) and Ph.D. (Kansas) has been elected instructor in geology in Indiana University.

THE following fellowships in the sciences have been awarded at Cornell University: The McGraw fellowship, Augustus Valentine Saph, B.S., M.S. (California), in civil engineering; the Schuyler fellowship, Kūchi Miyake, Imperial University of Tokyo, in botany; the Goldwin Smith fellowship, Lee Barker Walton, Ph.B. (Cornell), A.M. (Brown), in entomology; the President White fellowship, Floyd Roe Watson, B.S. (California), in physics; the Erastus Brooks fellowship, John Wesley Young, Ph.B. (Ohio State University), in mathematics; Susan Linn Sage fellowships in philosophy and ethics, John Wallace Baird, A.B. (Toronto), Georgia Benedict, A.B. (Wells), and Henry Wilkes Wright, Ph.B. (Cornell).

DR. J. N. LANGLEY, reader in histology at Cambridge University, has been appointed, for a period of two years, as deputy for Sir Michael Foster, M.P.

MR. W. E. THRIFT, fellow of Trinity College, Dublin, has been elected Erasmus Smith professor of natural and experimental philosophy, in succession to the late Professor Fitzgerald.

DR. B. NĚMEC, docent in botany at the Bohemian University at Prague, has been appointed director of the Institute for Plant Physiology.

# SCIENCE

A WEEKLY JOURNAL DEVOTED TO THE ADVANCEMENT OF SCIENCE, PUBLISHING THE OFFICIAL NOTICES AND PROCEEDINGS OF THE AMERICAN ASSOCIATION FOR THE ADVANCEMENT OF SCIENCE.

EDITORIAL COMMITTEE: S. NEWCOMB, Mathematics; R. S. WOODWARD, Mechanics; E. C. PICKERING, Astronomy; T. C. MENDENHALL, Physics; R. H. THURSTON, Engineering; IRA REMSEN, Chemistry; JOSEPH LE CONTE, Geology; W. M. DAVIS, Physiography; HENRY F. OSBORN, Paleontology; W. K. BROOKS, C. HART MERRIAM, Zoology; S. H. SCUDDER, Entomology; C. E. BESSEY, N. I. BRITTON, Botany; C. S. MINOT, Embryology, Histology; H. P. BOWDITCH, Physiology; J. S. BILLINGS, Hygiene; WILLIAM H. WELCH, Pathology; J. MCKEEN CATTELL, Psychology; J. W. POWELL, Anthropology.

FRIDAY, MAY 31, 1901.

THE SEA BOTTOM—ITS PHYSICAL CONDITIONS AND ITS FAUNA.\*

## CONTENTS:

<i>The Sea Bottom—its Physical Condition and its Fauna</i> : PROFESSOR C. C. NUTTING.....	841
<i>Reminiscent Remarks on the Top</i> : PROFESSOR CARL BARUS.....	852
<i>The Solar Eclipse</i> .....	854
<i>Silas W. Holman</i> : PROFESSOR CHAS. R. CROSS..	857
<i>Scientific Books</i> :—	
<i>Two High School Text-books on Botany</i> : PROFESSOR CHARLES E. BESSEY. <i>Korschelt and Heider's Embryology of Invertebrates</i> : F. R. L. GROOS <i>on the Play of Man</i> : O. T. M. RICHTER'S <i>Inorganic Chemistry</i> : PROFESSOR E. RENOUF. <i>Books received</i> .....	859
<i>Scientific Journals and Articles</i> .....	863
<i>Societies and Academies</i> :—	
<i>The New York Academy of Sciences, Section of Anthropology and Psychology</i> : DR. R. S. WOODWORTH. <i>Section of Biology</i> : PROFESSOR HENRY E. CRAMPTON. <i>Section of Astronomy, Physics and Chemistry</i> : DR. F. L. TUFTS. <i>Torrey Botanical Club</i> : DR. D. T. MACDUGAL.....	864
<i>Discussion and Correspondence</i> :—	
<i>The Bibliography of Geodesy</i> : PROFESSOR J. H. GORE.....	868
<i>Shorter Articles</i> :—	
<i>Note on the Western Tertiary</i> : DR. FREDERICK W. SARDESON. <i>An Unusual Type of Auriferous Deposit</i> : OSCAR H. HERSHEY.....	868
<i>Current Notes on Physiography</i> :—	
<i>Tallulah Gorge, Georgia</i> ; <i>Prehistoric Landslides in the Alps</i> ; <i>Great African Lakes</i> : PROFESSOR W. M. DAVIS.....	871
<i>Recent Progress in Paleontology</i> :—	
<i>Congestion of Museums</i> ; <i>Special Investigations</i> ; <i>Evolution of the Horse</i> : H. F. O.....	872
<i>An Archeological Map</i> : HARLAN I. SMITH.....	873
<i>The Biological Station of the University of Montana</i> .....	873
<i>Synoptic Wireless Telegraphy</i> .....	874
<i>Wireless Telegraphy in the Navy</i> .....	875
<i>The American Association for the Advancement of Science</i> .....	875
<i>Scientific Notes and News</i> .....	876
<i>University and Educational News</i> .....	880

It is hard to realize the fact that, up to a comparatively recent date, nearly three-fifths of the actual solid surface of the earth was absolutely a 'terra incognita,' a region as unknown as the poles, and as full of mystery as the center of the earth. Yet, if it be true that the sea covers nearly three-fifths of the surface of the earth, it is also true that its bottom, which is the actual solid surface of the globe, was, up to the middle of the century just ended, absolutely unexplored, excepting a very narrow strip around the edges.

For the purpose of our study this evening, we may define the deep sea as all that is deep enough to exclude sunlight and vegetable life in appreciable quantities from the bottom. We may safely assume that this limit is at a depth of about 150 fathoms. Sensitive photographic plates are said to be unaffected beyond the depth of about 125 fathoms clear water.

It thus becomes apparent that we shall have to include as deep sea almost all the area covered by the oceans of the world, there being but an inconsiderable strip around the edges that is within the 150-fathom line. The average depth is very

\* Lecture delivered before the Nebraska Chapter of the Society of the Sigma Xi, February 14, 1901, by Professor C. C. Nutting, of the State University of Iowa.

much greater than that. Indeed, we now know that more than one half of the actual surface of the globe is over two miles beneath the surface of the water, and that about seven million square miles are buried under more than 3,000 fathoms of ocean.

Still greater depths are by no means uncommon. The *Challenger* sounded at a depth of 4,561 fathoms in the North Atlantic, and Uncle Samuel, not to be outdone by his British brother, very recently found a depth of 5,200 fathoms near the lately acquired Island of Guam. This is, so far as we know, the deepest abyss of the ocean, being 31,200 feet, or nearly six miles. Into such a depth the highest terrestrial mountain could be plunged without any resultant peril to navigation, as there would still be some 2,000 feet above the highest crest.

As already indicated, this vast realm of darkness was unexplored previous to about the middle of the nineteenth century. The pioneer explorer of the sea bottom was a Norwegian zoologist, Michael Sars. Then followed several expeditions under the patronage of the British Government, culminating in the *Challenger* voyage, the results of which stand to-day as a peerless example of a wise and liberal policy in the encouragement of scientific research.

The United States has come well to the front in deep-sea investigation, and now owns the best equipped vessel for this work in the world. I refer to the *Albatross*, of which we shall hear more later. Americans may well take pride in remembering that the oceanic basins near our eastern and southern coasts are more thoroughly explored than any other parts of the sea bottom.

Investigations of this nature have been attended with almost insuperable difficulties, necessitating the devising of a number of entirely novel instruments and machines for this particular work. Several of the most successful of these were invented by American naval officers, of whom Captain

Sigsbee, of the ill-fated *Maine*, has been the most prominent. Our knowledge of the sea bottom has been gained mainly by the use of the following appliances:

1. The *sounding machine*. To drop a weight attached to a line to the bottom of the sea would seem to be as simple a proposition as could well be devised. As a matter of fact, however, its successful accomplishment has taxed the inventive genius of the most accomplished engineers. Sigsbee's sounding machine, with detachable weight and piano-wire line has proved the best device for obtaining accurate soundings and adequate samples of the bottom. This and the other instruments about to be mentioned will be illustrated and briefly explained later.

2. The *thermometer*. Temperature observations have been of the utmost importance in determining the physical conditions of the deep sea, and various kinds of thermometers have been devised to withstand the enormous pressure and register the maximum and minimum heat. Not infrequently these expensive instruments have been brought to the surface with their bulbs crushed to powder by the terrific pressure of the abyss.

3. The *water bottle*. Not only must depth and temperature be ascertained, but the actual composition and condensation of the water must be found by means of samples that can be secured free from admixture with sea water of other depths. Here also the genius of Captain Sigsbee was equal to the emergency, and the 'Sigsbee water bottle' has proved itself a convenient and efficient instrument, being so constructed that it will take a sample of water at any given depth and then automatically seal itself and remain hermetically closed until opened by hand.

4. The *dredge*, for scraping over the bottom and securing specimens of the animal life of the deep.

5. The *trawl*. A large bag-like net, useful on soft bottoms, over which it will pass without digging into the soil. It has a larger mouth and greater capacity than the dredge.

6. The *tangle-bar*, to sweep over rocky bottoms on which the other instruments would foul and often be lost. It is in effect a series of long swabs that will entangle in its hempen fibers almost anything from coral rock to fishes. It is probably the most effective all-around instrument for general work, and the least likely to fail or be lost. We found it invaluable in West Indian waters of moderate depths.

With these six instruments, then, the sea bottom has been sounded, its temperature taken, samples of both water and bottom secured and specimens of its animal life brought to light, both figuratively and literally. As yet this vast territory has been but scratched here and there. We can speak with confidence, however, concerning the general physical conditions, and we are acquainted with thousands of the strange and bizarre creatures that constitute its fauna.

Regarding the physical features of this under world, the following points are worth consideration :

The temperature is uniformly low, probably below 40°, except in enclosed seas in tropical regions such as the Red Sea. In many places the temperature is actually below the freezing point of fresh water. I well remember the surprise felt by the members of a dredging party one excessively hot day off Havana, indeed within sight of the now famous Morro Castle, when they plunged their hands in a mass of mud brought up in the dredge and found it so cold as to make them fairly ache. Of course the cold water reaches the surface in high latitudes, but it covers the entire floor of the ocean at depths over 150 fathoms. This practical uniformity of temperature

over the entire submarine surface of the globe plays an important part in the well-known wide distribution of deep-sea species.

The general impression that high temperature is more favorable than a low one for the best development of animal life is certainly not true of marine animals in general, whatever may be the facts concerning some special groups. If other conditions are favorable, a luxuriant fauna will be developed in any temperature short of the freezing point of salt water. But a *change* of temperature, if a sudden one, is sometimes the cause of oceanic tragedies of frightful extent, a fact illustrated by the following example :

The tile-fish is a deep-water species, living upon the bottom on what is known as the Gulf Stream slope, off the New England coast. Here the water is normally comparatively warm, coming as it does from the superheated region of the Gulf of Mexico.

During a series of unusually severe gales in the summer of 1882 this mass of water was pushed aside, as it were, and replaced by the colder water. As a result, millions and millions of these fish were killed, and their dead bodies literally covered the surface of the sea for hundreds of square miles. So great was the slaughter that for years it was feared that the tile-fish were exterminated. Fortunately, however, the region has been recolonized, probably from the south, and numerous tile-fish have been taken during the past two seasons.

Probably the most remarkable of the conditions of deep-sea life is the enormous pressure, which varies of course with the depth. At the average depth (2,000 fathoms) the pressure is about two tons to the square inch of surface, and at 4,000 fathoms each square inch of surface is subject to a pressure of about four tons. This fact led the earlier physicists to maintain that or-

ganic life was impossible in the great depths. It has been proved, however, that animals of all classes, except the higher vertebrates, have been dredged from even the deepest abysses of the ocean.

The great pressure to which they have been subjected has a curious effect on the deep-sea fishes when they are brought to the surface. Under these circumstances, being released from the accustomed pressure, they fall to pieces, as it were. The eyes bulge out, the swim-bladder protrudes from the mouth, the scales fall off and the flesh comes off in patches, the tissues being remarkably loose. Now these fishes, disreputable as they appear when brought to the surface, were doubtless respectable enough in their proper habitat, and, like some other creatures, become loose and far from correct in appearance when away from home, simply because the pressure is less.

In the depths they are doubtless no more conscious of the pressure of four or five tons to the inch than we are of the fifteen pounds of atmospheric pressure under which we live and move and have our being.

Owing to the incompressible nature of water it does not differ appreciably in density at different depths, and any object that will sink at the surface will continue to sink until the bottom is reached, however deep that may be.

The presence of oxygen is of course of vital import to animal life in the deep sea as elsewhere, and it was long deemed impossible that any considerable quantity of oxygen could exist at great depths. It has been found, however, that there is no lack of this vital element either near the surface or in the deepest soundings. Sir Wyville Thomson, the naturalist in charge of the *Challenger*, made a very careful study of oceanic currents and found that the cold water of the polar regions, charged with oxygen derived from the superincumbent atmosphere, creeps along the bottom to-

wards the equator from both poles, thus carrying oxygenated water over the vast area of sea bottom throughout the oceanic floor of the world. It also appears that the general trend of the surface water is toward the poles. This great scheme of circulation involves the general rise of the cold, deep water of the equatorial regions toward the surface, where it receives a fresh supply of heat and oxygen, carries much of the heat to northern regions and, after giving it off, returns southward again in the form of oxygen-bearing undercurrents. To my mind there are few terrestrial phenomena more impressive than this majestic cosmic current with circulation slow and sure, carrying with it the tremendous potency of life to and throughout the uttermost depths of the sea. Were it not for this world circulation, it is altogether probable that the ocean would in time become too foul to sustain animal life, at least in its higher manifestations, and the sea, the mother of life, would itself be dead.

The condition of the physical environment of the life of the ocean depths that strikes one as the most forbidding is the practical absence of sunlight from the enormous area included in the deep sea. As already stated, actual experiment has shown that photographic plates are not affected at a depth of over 125 fathoms in clear water, and light, which can not be detected by the exceedingly delicate eye of the camera, is surely invisible to any organ of vision constructed on the same general plan as the human eye. There is practical agreement among all the authorities, save one, that I have been able to consult that the rays of the sun do not penetrate perceptibly below the 200-fathom line at the farthest. Professor Verrill is the exception referred to, and he has advanced the theory that a pale green light penetrates even to the deepest waters. He thinks that all the other colors of the spec-



trum are removed from the sun's rays by absorption, leaving the green rays only. He comes to this conclusion from a study of the colors of the animals of the deep sea, which demonstrate, in his opinion, the presence of light of some kind. He apparently assumes that this light comes from the sun, and resorts to the explanation just referred to to prove its presence in the oceanic depths.

We shall see presently, I hope, that it is not necessary to assume the presence of sunlight at the sea bottom in order to meet the demands for light revealed by a study of the coloration of its inhabitants.

The bottom waters, then, are almost freezing cold, subject to tremendous pressure, moved by slow currents creeping from pole to equator, supplied with sufficient oxygen to sustain animal life, and devoid of sunlight. Could a more uncomfortable and altogether forbidding habitat be conceived of for an animal population? Certainly not, from our standpoint. But it must be remembered that we are neither fishes, nor mollusks, nor jelly-fishes; and that everything depends upon being used to environment. A practical application of this fact would result in the saving of a lot of otherwise wasted sympathy in human as well as zoological affairs.

Let us now turn our attention briefly to the topography of the sea bottom. It may be said, in general, that there are few abrupt changes of level; that the ascents and descents are gradual, and that there are few areas which, if laid bare, would present anything like the broken contours of a mountainous region. In areas adjacent to continents and archipelagoes the topography is often considerably broken, but away from the land masses the sea bottom is, ordinarily, as level as a western prairie. Few, if any, bare rocks are to be found, except where recent submarine volcanic explosions have torn up the subjacent

strata, or the cooling lava has encrusted the bottom. Practically the entire sea bottom is covered to an unknown depth by a soil that varies with the depth in a definitely determinate manner. This soil, like that of the upper world, is organic in its origin, being composed in large proportion of the remains of a few species of very widespread forms, individually minute, but collectively of stupendous bulk. These animals belong almost exclusively to the Protozoa, or one-celled forms, and largely to the class Rhizopoda. They are of immeasurable importance from a biological standpoint, furnishing, as they do, the food basis for all marine life. As a type of these organisms *Globigerina bulloides* stands forth preeminent, a form of exquisite beauty of structure, being like a series of minute chalky spheres, exquisitely sculptured, from which radiate many and almost infinitely slender and delicate spicules which serve to support the living animal on the water, which, in places, is rendered of a reddish color by the hosts of these Rhizopods. It has fallen to the lot of but few naturalists to examine these creatures in a living and perfect state, as the slightest touch will rob them of their beautiful spicules and cause the living protoplasm to retreat within the hollows of the spheres. Minute and fragile as they are, the skeletons of these animals, and of others equally small, cover at the present time many millions of miles of the sea bottom, and in times past were the main element in building up the mighty chalk deposits of the world.

If we were to run a line of soundings from the continent of North America eastward to the mid-Atlantic, we should find that the bottom could be easily divided into three regions on the basis of the soil, as I have termed it, covering everywhere the actual rocks. For the first few miles the bottom would be covered with débris of many kinds from the adjacent land.

Rocks and gravel and sand, together with mud and silt, if near the mouth of a river, would succeed each other. The surface might be broken into rocky pinnacles and caverns, water-worn in fantastic shapes in the region of a rocky coast; or, if the coast be low and sandy, there might be a perfectly even and gradual slope from the shore to a depth of 150 or perhaps 200 fathoms.

This slope, covered with continental débris, is known as the 'continental slope,' and is very apt to be more uneven and broken in its topography and to support a more luxuriant fauna than any other part of the sea bottom. Beyond the continental slope the descent becomes more abrupt, leading down to a depth of 1,500 fathoms or more.

The bottom samples will now take on a distinctly different character, being composed of a grayish mud. If a little of this is examined under a microscope, it will be found to be made up of countless millions of the tests of *Globigerina* and other unicellular animals. Not a single thimbleful of this mud is devoid of its hosts of skeletons. This wet and slimy bottom soil is known the world over as '*Globigerina ooze*,' and it covers the ocean floor for many millions of square miles.

In a line of dredgings made by the *Challenger* from Teneriffe to Sombrero, taking in the widest part of the Atlantic, about 710 miles were found to be covered with *Globigerina ooze*, which was found in characteristic form from a depth of 1,525 to one of 2,220 fathoms. Beyond the latter depth the bottom was of a distinctly different character, changing to an extremely fine-grained reddish-brown mud, oily to the feel. It is so finely divided that it takes many hours to settle when mixed in a glass of water. This is known among oceanographers as 'red clay,' and is supposed to be derived almost exclusively from two widely different sources:

First: The residue of the innumerable hosts of pelagic animals remaining after their calcareous skeletons have been dissolved in sea water.

Second: Pumice and volcanic dust, either from submarine upheavals or from the atmosphere. From either or both of these sources the accumulation of the red clay must have been almost infinitely slow, taking perhaps millions of years to deposit a few inches in thickness on the ocean floor. This sort of bottom deposit is of much greater extent than either of the others, and is supposed to cover about one-half of the sea bottom, an area greater than the total land surface of the globe.

It can easily be conceived that no stretch of the land surface can compare in dreary monotony with those awful solitudes of the *Globigerina ooze* and the red clay. Even if illuminated by the sun's rays, they would be forbidding and dreary beyond compare.

Resting immediately upon the bottom already described is a layer of unknown depth of a flocculent material that is of incalculable importance in our discussion. When first discovered this substance, owing to its strange movements in alcohol, was supposed to be alive, and was described by Huxley under the name of *Bathybius*, and considered as a sort of primordial organism from which the entire life of the globe may have originated. *Bathybius*, however, was doomed to be regarded as one of the colossal jokes of science, and a thorn in the flesh of its describers.

But, after all, it is now thought that the much-derided *Bathybius* is fully as important as claimed by Huxley, but in another way. It is not alive, to be sure, but still it is organic, consisting of the partially decomposed remains of the pelagic animals, such as *Globigerina* and other forms already referred to. These have died near the surface, and have gradually but surely found their way to the bottom, where they remain

partially suspended in a layer of soup-like consistency and character. *Bathybius*, then, is now no longer known as *Bathybius*, but as 'bottom broth,' an exceedingly suggestive term, and it is supposed to be the inexhaustible supply of nourishment, the basal food store-house of the innumerable creatures that live and move, or simply live without movement, at or near the bottom of the sea, the simplest and most helpless of which have but to open their mouths, if mouths they have, and suck in bottom broth as the infant does pap. If Old Ocean is really, as so often asserted, the mother of terrestrial life, then bottom broth can truly be regarded as a sort of mother's milk, for the nourishing of her weak and helpless offspring.

Having discussed the physical conditions under which the animals of the deep sea exist, let us now turn our attention to the animals themselves.

Personally, I may say that nothing regarding the animals dredged from deep water has impressed me more than their colors. It seems an unquestionable fact that they live in practical darkness, and one naturally expects them to be colorless.

Now we know of a considerable number of animal forms that certainly do live in utter darkness in the subterranean waters of extensive caves, such as Mammoth or Wyandotte Caves. These animals have been very carefully studied, especially by my friend Dr. Eigenmann, of Indiana University, who tells me that true cave species are always practically blind and colorless. But the animals brought up from the deep waters of the ocean are often very brightly and conspicuously colored.

The question at once arises: What is the significance of these colors? Are they merely fortuitous, or have they a meaning that can be deciphered, giving a clue that may lead to a further understanding of the mysterious realm beneath the waters? It

is my purpose this evening to attempt to answer these questions, but before doing so let us examine briefly the main facts regarding the colors of abyssal animals. We will call as witnesses some of the naturalists of the widest experience in the science of thalassography, and supplement this evidence by facts of personal observation.

Professor Mosely, of the *Challenger* staff, says: "Peculiar coloring matter giving absorption spectra has now been found to exist in all the seven groups of the animal kingdom. The Echinodermata and Cœlenterata appear to be the groups which are most prolific in such coloring matter. Pentocrinin and antodonin seem to be diffused in immense quantities throughout the tissues of the crinoids in which they occur and the Echinoderms generally seem to be characterized by the presence of evenly diffused and abundant and readily soluble pigments." Again, he says: "The same coloring matters exist in the deep-sea animals which are found in shallow water forms."

Alexander Agassiz, than whom no living man has had more experience in deep sea work, says: "There are many vividly colored bathyssal animals belonging to all the classes of the animal kingdom and possessing nearly all the hues found in living types in littoral waters. \* \* \* There is apparently in the abysses of the sea the same adaptation to the surroundings as upon the littoral zone. We meet with highly colored ophiurans within masses of sponges themselves brilliantly colored at a depth of more than 150 fathoms. \* \* \* While we recognize the predominance of tints of white, pink, red, scarlet, orange, violet, purple, green, yellow and allied colors in deep water types, the variety of coloring among them is quite as striking as that of better known marine animals. \* \* \* There is as great a diversity in color in the reds, oranges, greens, yellows, and

scarlets of the deep-water starfishes and ophiurans, as there is in those of our rocky and sandy shores. \* \* \* Among the abyssal invertebrates living in commensalism the adaptation to surroundings is fully as marked as in shallow waters. I may mention especially the many species of ophiurans attached to variously colored gorgonians, branching corals and stems of *Pentacrinus* scarcely to be distinguished from the part to which they cling, so completely has their pattern of coloration become identified with it. There is a similar agreement in coloration in annelids when commensal upon starfishes, mollusks, actiniæ or sponges, and with Crustacea and actiniæ parasitic upon gorgonians, corals, or mollusks. The number of crustaceans \* \* \* colored a brilliant scarlet is quite large."

Professor Verrill, of Yale University, in his report on the Ophiurans, collected by the Bahama expedition from the University of Iowa, repeatedly calls attention to the agreement in color between these animals and the forms upon which they grow.

My own observations fully confirm those of the naturalists just quoted. Among the crustaceans were many species colored a bright scarlet, and one was an intense blue. The echinoderms were particularly striking in their coloration. Yellow and purple Comatulæ abounded in deep water near Havana. Serpent-stars were brown, white, yellow, red, purple and deep violet. A basket-fish, colored chocolate-brown and vivid orange, was abundant off the Florida Keys. There were sea urchins with crimson and white spines; another particularly gorgeous one had a test with alternating zones of chocolate and orange, and spines barred with carmine and white. The cœlenterates told the same story, but it is unnecessary to multiply further the evidence. Enough has been given for our purpose, which was to demonstrate the ex-

istence of bright colors in considerable quantities in the deep waters of the ocean, and we feel justified in making the following general statements regarding these colors:

1. The colors are often as brilliant as in shallow water.

2. The reds, orange, yellows, violet, purple, green and white predominate.

3. The colors when present are usually in solid masses in striking contrast, or else the whole animal is brilliantly colored. Fine patterns are very scarce, and nature seems to have used a large brush in adorning her children of the depths.

Now let us return to our question: What is the significance of these brilliant and varied colors?

I must confess to being a Darwinian of the strict constructionist school, and believe fully in the doctrine that no animal possesses any character, including color, that is not of use to the species to which it belongs, or has not been of use to the ancestors of that species. It is my conviction that if we knew all the circumstances surrounding the past history and present life of any animal, we could explain on the score of utility every character, using the word in the zoological sense, possessed by that species. And it is my purpose to use the coloration of deep-sea animals to illustrate this law.

In my opinion, the presence of all these colors can mean but one thing, and that is that there is light even in the deepest depths of the ocean. Or, to state the matter in another way, if we can prove the presence of light in considerable quantity at the bottom of the sea, the colors of its inhabitants become entirely explicable. We can then explain them as we do the colors of the animals of shallow waters, regarding the colors as protective, aggressive, alluring, attractive, directive, and so forth, as the case may be.

There is another line of evidence tending to prove the presence of light at the sea bottom, and this is the fact that most of the vertebrates inhabiting the depths have functional eyes, often more highly developed than in shallow water, and only exceptionally are the eyes aborted or absent. Dr. Alexander Agassiz has the following to say on this point:

"We should not forget, on the one hand, that blind Crustacea and other marine invertebrates without eyes, or with rudimentary organs of vision, have been dredged from a depth of less than 200 fathoms, and, on the other, that the fauna as a whole is not blind, as in caves, but that by far the majority of animals living at a depth of about 2,000 fathoms have eyes either like their allies of shallow water, or else rudimentary or sometimes very large, as in the huge eyes developed out of all proportion in some of the abyssal crustaceans and fishes."

And Professor Verrill says: "That light of some kind and in considerable amount actually exists at depths below 2,000 fathoms may be regarded as certain. This is shown by the presence of well-developed eyes in most of the fishes, all of the cephalopods, most of the decapod crustacea, and in some species of other groups. In many of these animals the eyes are relatively larger than in the allied shallow-water species."

In view of the almost uniformly blind condition of cave animals on the one hand, and of the well-tested Darwinian doctrine that useless structures, unless rudimentary, do not exist, on the other, I think we are justified in saying that a study of the coloration of the deep-sea animals, in connection with the general presence of functional eyes, is reasonable proof that light in appreciable quantities exists even at the greatest oceanic depths.

This being granted, we naturally turn to a consideration of the question: What is the nature of this abyssal light?

As already intimated, it is incredible that sunlight could penetrate in appreciable quantities to any such depth as 2,000 fathoms or over, or even to one-tenth of that depth, notwithstanding the theory advanced by Verrill, who seems to consider the presence of sunlight necessary to explain the facts of coloration. I think we are safe in assuming with Agassiz that at 200 fathoms the light from the sun is possibly that of a brilliant starlight night, and we are also justified in concluding that coloration would be useless in such a light. Did you ever notice how little of color can be seen even in the clearest moonlight night?

Sunlight being out of the question, is there evidence of any other light that would satisfy the conditions of coloration [and organs of vision already referred to?

I have, on other occasions, sought to collect the evidence of the existence of abyssal light, and to determine its nature and function in the life economy of the deep sea. These efforts resulted in the belief that the light sought for is a phosphorescent light, and that it is adequate to explain the phenomena already discussed in connection with the colors of deep-sea animals.

This idea has been suggested before by several writers, notably by Andrew Murray, of the *Challenger*, but it has heretofore been only a suggestion which no one has taken the pains to seriously investigate. It will be of interest, therefore, to consider the extent to which phosphorescent life is characteristic of the deep sea.

For the purposes of the discussion we will divide the animals of the sea bottom into two classes, the free swimming and the fixed forms.

Considering the free swimming forms first, we find among the fishes several allied to *Lophius* and *Antennarius*, which are provided with a bait said to be luminous, which serves to attract the prey. Others are luminous along the lateral line in defi-

nite spots. The utility in this case is not certainly known, but two suggestions may be made, one to the effect that the light attracts the mate and thus serves the purpose of attractive coloration; the other that it attracts the prey and serves the purpose of alluring coloration.

A very large number of crustaceans are highly phosphorescent. Many of these have large eyes and are particularly active in movement and voracious in appetite. They feed on minute organisms for the most part, and it can hardly be doubted that they often use their phosphorescent powers for the purpose of illuminating their surroundings and revealing their prey. Here again it is probable that the strangely attractive power of light serves a definite purpose in the life economy of the animal.

Among the mollusca we have few instances, so far as I know, of phosphorescent organs. At the Detroit meeting of the American Association for the Advancement of Science, Professor William E. Hoyle, of England, read an exceedingly interesting paper on certain organs possessed by cephalopods secured by the *Challenger*. These organs were regarded as phosphorescent by Professor Hoyle, who described a highly specialized apparatus designed to reflect light from the phosphorescent bodies downward to the bottom over which the animal passed. In this case it appears that there is not only a light, but also a reflector, an efficient bull's-eye lantern for use in hunting through the abyssal darkness. Among the worms are many forms possessing a high degree of light-emitting power, which may be either attractive, alluring or directive in function, and thus of direct advantage to its possessors.

Most of the echinoderms, although not truly fixed, are not capable of rapid locomotion, and we are, therefore, not surprised to find few references to phosphorescence in connection with them. Perhaps the

most active of this group are the serpent stars, and it is interesting that the only account that I find of phosphorescence in the echinoderms is Agassiz's description of a serpent star, which he says 'is exceedingly phosphorescent, emitting at the joints along the whole length of its arm a bright bluish-green light.'

Coming to the coelenterates, we find many notable phosphorescent organisms. The ctenophores and medusæ comprise the greater part of the free swimming members of this subkingdom, and it is among these that we encounter amazing displays of the living light. The most brilliant exhibition of phosphorescence that I have seen was caused by immense numbers of ctenophores in Bahia Honda, Cuba. The animals kept in a compact body, producing a maze of intertwining circles of vivid light. The phosphorescence may help to keep them together, and thus serve the purpose of directive coloration among vertebrates and insects. This same explanation may apply to many of the phosphorescent medusæ. In the subtropical Atlantic hundreds of square miles of the surface are thickly strewn with a medusa, *Lingera mercurius*, which glows like a living coal at night.

In general, it may be said that phosphorescence is found abundantly in free swimming marine animals, and serves the same purpose as protective, aggressive and alluring coloration, and at the same time, in many cases, aids in securing prey by illuminating its retreat.

We come, now, to a consideration of the phosphorescence of the fixed animals of the deep sea and its uses. Most of the light-emitting organisms of this group belong to the subkingdom coelenterata. The sponges are mentioned by several writers as being especially brilliant in their flashes of light. The gorgonians, or flexible corals, are often phosphorescent, and Agassiz says: "Species living beyond 100 fathoms may

dwelt in total darkness and be illuminated at times merely by the movements of abyssal fishes through the forests of phosphorescent alcyonarians."

Many authors have noted the light-emitting powers of numerous hydroids. These occur in great quantities over certain areas of the sea bottom, and must add considerably to the sum total of deep-sea light.

It may, I think, be said that in general the fixed marine forms are not behind their free swimming allies in either the equality or the quantity of their light-emitting powers. The question now arises, of what value is the phosphorescence of fixed forms to its possessors? They have no eyes, and therefore can not be guided to their food by the light, neither can it aid them in finding mates nor in revealing the presence of enemies. Perhaps the most generally accepted explanation is that given by Professor Verrill, who says that the phosphorescence protects its possessors. Most *coelenterates*, he says, are possessed of *nematocysts* or netting cells, and the phosphorescence may serve to give notice to predaceous fishes that feed largely on hydroids, etc., that these netting cells are present, and thus induce them to seek other provender. It is somewhat unfortunate for this argument that few if any of the *coelenterates* that are remarkable for their phosphorescence possess netting cells that are likely to be regarded by a hungry fish as at all formidable.

Another explanation is, however, possible. The food of the *coelenterates* consists mainly of either crustacea of the smaller sorts, their embryos, protozoans, or unicellular plants. Now most of the crustacea have functional eyes, and it has been repeatedly demonstrated that they are attracted by light, both artificial and natural. Crustacean embryos usually have eyes that are proportionally very

large. In many cases these too are attracted by light, and it is reasonable to suppose that they are attracted by phosphorescent light. If this is true, the light emitted by the fixed *coelenterates* would cause the small crustaceans, and more surely their embryos, to congregate near the illuminated areas and thus be captured. The process would be analogous, perhaps, to what is known as the effect of alluring coloration among insects and birds. The phosphorescence would thus be of direct utility to the fixed *coelenterates* in securing food.

The application of this idea may be still further extended to include the attraction of Protozoa and even diatoms, both of which groups contain many species that are strongly attracted by light, which appears to act as a direct stimulus to both unicellular animals and plants by virtue of its well-known effect upon protoplasm itself.

One other fact, bearing directly on our discussion, that impresses itself strongly upon every one who has had actual experience in deep-water dredging, is the very uneven distribution of life over the sea bottom. In other words, the distribution is 'spotted.' A haul over certain areas will result in a dredge full of a profusion of animal forms, while the immediately adjacent bottom, although of apparently identical nature, will yield practically nothing. Our party repeatedly observed this while dredging on the Pourtales Plateau. It seemed as if species were distributed in densely crowded colonies of very limited areas. Sometimes one particular species seems to have fairly carpeted the bottom, and in other localities a great assemblage of species would be secured at a single haul, showing a profusion of life, perhaps greater than can be found on a similar area either in shallow water or on land. Again the tangles would come up with nothing but sand and bottom débris.

It seems, then, that we are justified in

concluding that the sea bottom is, for the most part, utterly dark, but that there are scattered areas, often of considerable extent where animal life is aggregated in masses, and where the phosphorescent light is of sufficient quantity to render the colors, laid on as we have seen in broad patterns, visible to animals with functional eyes. These colors would then be of the same utility to their possessors as in the upper world, and act as protective, aggressive, directive, attractive and alluring agencies. We are further justified in maintaining that phosphorescence is in all cases of direct utility to its possessors, and that in the fixed eyeless forms it serves to attract food, and perhaps in some cases to warn enemies of the presence of the irritating netting cells.

As a sort of compensation for the feebleness of the phosphorescent light, and for its absence over vast areas, many animals, especially fishes and crustaceans, are furnished with very large eyes, or with organs which serve as lanterns, or with enormous mouths and stomachs to make the most of a very occasional square meal, or with greatly elongated feelers or tactile organs. Others still are provided with a luminous bait to attract the prey.

The main thing that I would impress upon you this evening is the fact that we have a right to expect to find utility for every character, not rudimentary, possessed by animals, a utility not necessarily to the individual, but certainly to the species. And I would protest most vigorously against the vain and impotent conclusion that anything is useless simply because we have been too ignorant or too indolent to find its function. I have small patience with a statement such as the following taken from a recent writer on animal coloration: "The inevitable conclusion, therefore, from these facts appears to be that the brilliant and varied colorations of deep-sea animals are

totally devoid of meaning; they can not be of advantage for protective purposes or as warning colors, for the simple and sufficient reason that they are invisible."

This sort of thing is deeply injurious to science, because it is a helpless surrender of one of the most powerful of all incentives to research. If we can loll back in our easy chairs and declare that natural phenomena of widespread occurrence are meaningless, or, what amounts to the same thing, that Nature is guilty of a lot of vapid nonsense, we have indeed sold our scientific birthright for a mess of exceedingly thin pottage, and have stultified ourselves in the eyes of the thinking world.\*

C. C. NUTTING.

STATE UNIVERSITY OF IOWA.

#### REMINISCENT REMARKS ON THE TOP.

SOME time ago, I wrote a short article in this journal,† in which among other things I endeavored to give an intelligible explanation of all that, from an elementary point of view, is interesting in the dynamics of the top. The treatment of this famous and ubiquitous apparatus in all text-books known to me is too sketchy and, didactically considered, useless. In my judgment this is a real gap and well worth filling. But my friends have so frequently and even quite recently taken me to task for my explanation, that I feel bound to reassert its correctness here.

Everybody will agree that up to the second order of approximation, and a vigorously spinning top or gyroscope, in which  $\dot{\theta}$  is the polar velocity and  $\varphi$  and  $\psi$  the parameters of azimuth and altitude,

\* Most of the facts and sometimes whole paragraphs concerning the coloration of deep-sea animals and phosphorescence, have been taken from the following papers by the author: 'The Color of Deep Sea Animals,' *Proc. Iowa Acad. of Sci.*, Vol. VI.; 'The Utility of Phosphorescence in Deep Sea Animals,' *Am. Nat.*, Oct., 1899.

† SCIENCE, V., pp. 171-5.



$$\Psi = K \dot{\theta} \sin \phi \cdot \dot{\phi}, \quad (1)$$

$$\Phi = -K \dot{\theta} \sin \phi \cdot \dot{\psi}, \quad (2)$$

will express the motion. Here  $\Psi$  and  $\Phi$  are the torques around the horizontal and vertical axes, respectively, and  $K$  the polar moment of inertia; friction is disregarded.\* Hence  $\dot{\theta}$ ,  $\dot{\phi}$ ,  $\dot{\psi}$ , are of the first order of small quantities,  $\ddot{\phi}$  and  $\ddot{\psi}$  of the second order.

The point is now to show that these equations are reproduced in my geometrical constructions relative to the common theorem of the equivalence of torque, and the change of angular momentum per second around any particular direction.

I. *Torque ( $\Psi$ ) around the horizontal axis only. Precession.*—Take any two positions of the top axis, a second of time in position apart. Lay off the angular momenta  $K\dot{\theta}$ ,

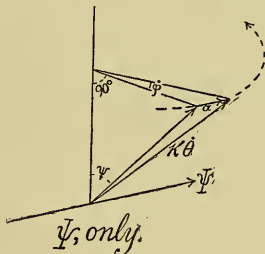

along these axes. They are equal by the premises. Hence the horizontal arc,  $a$ , is the rate of change of angular momentum due to the torque  $\Psi$  around the parallel axis shown. In the second of time stated, the angle of azimuth has changed by  $\dot{\phi}$ , as shown in the figure. Therefore, the arc

$$a = K \dot{\theta} \sin \phi \cdot \dot{\phi},$$

and hence

$$\Psi = K \dot{\theta} \sin \phi \cdot \dot{\phi},$$

II. *Torque  $\Phi$  around the vertical axis only.*

\* Otherwise, if there is polar acceleration,  $\Phi = -K(\dot{\theta} \dot{\psi} \sin \psi - \cos \psi \cdot \ddot{\theta})$  may be deduced without difficulty by the method of § II.

—This requires gyroscopic mounting. Let the horizontal axis be seen end on at  $A$ . Take two positions of the top axis, a second of time in position apart. Lay off the (equal) angular momenta,  $K\dot{\theta}$ , along these

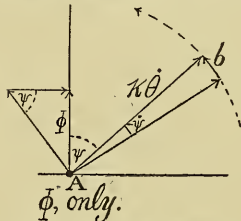

axes. Then the arc  $b$  is the rate of change of angular momentum, and the angle,  $-\dot{\phi}$ , subtended, the speed in altitude. Hence

$$b = -K \dot{\theta} \cdot \dot{\phi}.$$

The arc,  $b$ , cannot be resolved with advantage, for there is no way of accounting for both components.  $\Phi$ , however, may be resolved; for if one component is made parallel to  $b$ , this is the equivalent of  $b$ ; whereas if the other component tends to twist across  $A$  (in a plane at right angles to 'around  $A$ '), *i. e.*, in the plane of this axis, it can produce stress only, but no motion. Hence, as seen in the figure, the effective component is  $\Phi / \sin \phi$ , a result a little subtle, I grant, but none the less logically straightforward. Therefore

$$\Phi / \sin \phi = b,$$

whence

$$\Phi = -K \dot{\theta} \sin \phi \cdot \dot{\phi}.$$

Of course my explanation was intended for the man interested in *spinning* tops. The other man, who prefers the top toppling through all stages of inebriety, may take such solace as comes from products of parameter speeds and accelerations. But for him I have no message other than my blessing.

CARL BARUS.

BROWN UNIVERSITY, PROVIDENCE, R. I.

## THE SOLAR ECLIPSE.

IN view of the fact that some time must elapse before it is possible to publish a complete account of the results of observations on the solar eclipse of May 17th-18th, the following letter, written from Padang by a correspondent of the London *Times*, describing the preliminary arrangements, is of interest :

The last few days of our very prosperous voyage across the Indian Ocean in the Dutch mail boat *Koningin Regentes* have brought with them the sense that we are coming to a land where it is 'always afternoon.' But our days of eating lotus were nearly over just as we reached this beautiful land. The lighthouse close to Siberut, rising high above the palms, warned us that Padang was not more than ten hours away. The sight of this light produces the same thrill that seizes one when, after crossing the Atlantic, the Fastnet comes into view and tells that the voyage is safely accomplished. It is the first land that we sighted since we passed the splendid headland of Somaliland, Cape Guardafui, on March 27th; our course took us through the Maldives at night; and, though we passed through the 'S° Canal,' Minicoy was left so far to the north that we got no glimpse of the light. All the members of the expedition who have traveled out by this direct route to make observations during the total eclipse of the sun visible in Sumatra disembarked at Padang.

Three parties of observers have traveled out on the *Koningin Regentes*—(1) the English expedition, consisting of Mr. H. F. Newall, of Cambridge, Mr. F. W. Dyson, of the Royal Observatory, Greenwich, accompanied by Mrs. Newall and by Mr. J. J. Atkinson, who has volunteered assistance to the party in this distant land, just as he did to the Astronomer Royal's party last year in Portugal; (2) the Dutch expedition, consisting of Dr. A. A. Nijland, of

Utrecht, Dr. W. H. Julius, professor of experimental physics at Utrecht, and Mr. J. H. Wilterdinck, of the Leiden Observatory, accompanied by Mr. J. H. Hubrecht, a son of Professor Hubrecht, the eminent embryologist, who lately received the honorary degree of Sc.D. at Cambridge University; (3) a party from the Massachusetts Institute of Technology, consisting of Professor Burton, Mr. H. W. Smith, Mr. G. Hosmer, and Mr. G. H. Matthes. The instruments of all these parties were also carried by the same mail boat, which starts from Amsterdam and calls at Southampton and Genoa.

The eclipse of the sun which will occur on the 17th-18th of May is of special interest on account of the long duration of the total phase. The shadow of the moon will first touch the earth at sunrise near Madagascar, and in the course of the next five hours it will traverse a long path on the earth's surface. Passing at first in a northeasterly direction over Mauritius, it speeds across the Indian Ocean and traverses Sumatra and Borneo. It grazes the equator, but only a small part of the shadow touches the northern hemisphere. Then its course bends southeastwards and passes over the Malay Archipelago, Celebes, Seram, and thence over New Guinea. At sunset in the Coral Sea, between Melanesia and Australia, the shadow leaves the earth.

The partial phase of the eclipse will be visible over a vastly greater region of the earth's surface, as far north as Somaliland, India, Siam, and China, and also over the whole of Australia; but the real interest of the eclipse lies in the total phase, which can only be observed at stations lying on the line indicated. The shadow of the moon will be about 140 miles across as it passes over Sumatra, and it will travel with a speed of about 1,500 miles an hour. Hence any observer stationed near the path of the center of the circular shadow will be in the shadow for about a tenth of an

hour, or, if more exact calculations are used, for 6 min. 29 sec.

In recent eclipses the duration of totality has been much shorter; thus in America, Spain, and Algiers, in May, 1900, the total phase lasted not much more than one minute; whilst in India, in January, 1898, the duration was only a little more than two minutes in the most favorable stations.

Hence the coming eclipse is welcomed as an unusual opportunity for collecting observations by the photographic methods which play so important a part in modern investigations. Especially in spectroscopic researches is the photographic method serviceable; for by the nature of this kind of research the light gathered by the instruments is spread out over a much greater extent of the photographic plate. Accordingly to collect information about the spectrum of the faint light of the corona long exposures of the photographic plate are necessary.

The valuable information published by the *Koninklijke Natuurkundige Vereeniging* in Batavia over the signatures of Major Muller, the chief of the Trigonometrical Survey, and Dr. Figeo, the director of the Meteorological Observatory, Batavia, showed that the weather conditions were probably most favorable, or, shall we say, least unfavorable, in Sumatra, especially near the west coast. It is therefore not surprising that most of the observing parties converge on Padang, the port that gives access to the province of the West Coast, and lies actually on the course of the moon's shadow.

The joint permanent eclipse committee of the Royal Society and the Royal Astronomical Society favored the sending of an expedition to Mauritius, and we understood on leaving England that Mr. E. W. Maunder, of the Royal Observatory, Greenwich, was to go thither to make observations in conjunction with Mr. Claxton, the director

of the Royal Alfred Observatory, Mauritius. We also learn that Mr. D. P. Todd, of Amherst, U. S. A., is to be stationed at Singkep, an island noted for its tin mines, lying on the east coast of Sumatra, due south of Singapore. Otherwise all the observers have come to Padang and are receiving the most courteous and helpful reception by the Dutch authorities. Probably most of the parties have similar obligations to acknowledge. The English expedition received every assistance from Mr. Joeekes, the Governor of Sumatra's west coast. Thus Mr. Dyson was at once made welcome to use the Government launch to make preliminary inspection of Trusan Bay and of the island Aoeer Gedang, about six miles to the west of Painau and 30 miles to the south of Padang; whilst Mr. Newall received every assistance from Mr. Delpeat, the chief of the railways, to go inland and search for a suitable site on the east side of the Barisan Mountains. And so within four days of landing at Padang the sites for observing stations of the English expedition were chosen.

In order to increase the chances of securing observations of the eclipse, the parties distribute themselves as far apart as possible. The extreme stations in Sumatra are occupied by English parties. Mr. Dyson and Mr. Atkinson, assisted by his Majesty's ship *Pigmy*, a gunboat commanded by Lieutenant Oldham, R.N., and sent from the China Station to assist the observers, have established their camp on the island Aoeer Gedang, and will be the first to catch the eclipse. Here the program of observations will be to secure (1) photographs of the corona on a large scale to show details of the structure; (2) photographs on a small scale to get the greatest possible extensions of the coronal streamers; (3) photographs of the ultra-violet spectrum of corona and chromosphere and also of the green and yellow spectrum, with slit spec-

trosopes in both cases. At the eastern extremity of the Sumatra stations Mr. Newall will be established at Doerian, above the Oembilien Coal Mines, near Sawah Loento, at the extreme end of the railway. The engineer of the mines, Mr. van Lessen, has put a house at the disposal of this party, and a very good site has been found close at hand for the setting up of the instruments, which consist of (1) a powerful flint spectroscope, to be used in an attempt to determine whether the corona rotates; (2) a quartz spectroscope, to be used for photographing the extreme ultra-violet spectrum and for a special search for Fraunhofer lines such as might be attributed to sunlight reflected by dust in the corona; (3) a cœlost, to be used in connection (*a*) with polariscopic cameras in investigating the polarization of the light of the corona, (*b*) with a telephoto camera in photographing the corona, (*c*) with a powerful grating spectroscope in getting monochromatic images of the corona. This station is 1,200 ft. above sea level and it is at a considerable distance to the east of the main range of the Barisan Mountains. It is to be hoped that, with the considerable uncertainty that exists in the weather and wind conditions, one at least of these extreme stations may be favored with a good view of the eclipse. At various points between these extreme stations many other parties are established. The Dutch party have a large camp at Karang Sago, close to Painau, on the coast, and have an extensive programme, including (*a*) photographs of the corona with cameras of very varied dimensions ranging from a 40-ft. telescope with aperture f191 to a short camera with aperture f13.5; (*b*) spectroscopic observations of the corona and chromosphere; (*c*) polariscopic observations to be carried out visually; (*d*) measurements of the heat-radiation of the corona. (Professor Julius

has constructed a specially delicate thermopile with a view of getting absolute measures of the total radiation of the whole corona and comparing it with that of the uneclipsed sun.) A party will probably also be sent with a prismatic camera to Fort de Kock, near the northern limit of the shadow.

The observers from the United States Naval Observatory, together with affiliated parties from the Yerkes Observatory and the Smithsonian Institution, are established in an excellent site, the old fort at Solok. Here Professor Barnard is setting up his cœlost and 61-ft. telescope with which he is going to photograph the corona, exposing plates 40 in. square for  $2\frac{1}{2}$  minutes, being led to expect detail right up to the edge of these plates. For the shorter exposures he will be content to use smaller plates 30 in. square and 17 in. square. Professor Abbot and Mr. Draper, from the Smithsonian Institution, come with this party and find a room in the fort that will serve admirably for their bolometric apparatus. Dr. Humphrys will probably take spectrographic apparatus to Fort de Kock not far from the northern edge of the moon's shadow. Mr. Jewell brings out a battery of gratings of unusual size, both plane and concave, and will use films 36 in. long and  $2\frac{1}{2}$  in. wide in getting extended spectra of the chromosphere and corona, special attention being given to the ultra-violet region of the spectrum. Professor Skinner, who is in charge of the whole party, has also brought large cameras, which will be used in a search for an intra-mercurial planet.

Mr. Perrine, from the Lick Observatory, has established his camp on the race-course at Padang, and is setting up a 40-ft. telescope to point direct at the sun. He also has four 12-ft. cameras to be mounted on one axis and used in a search for Vulcan; in this research 12 plates, 17 in. by 14 in., will be exposed, covering a wide range on either

side of the sun, duplicate plates of each region being taken. He has also two spectroscopes, each with a single prism and with polarizing apparatus, for special study of the coronal light.

Members of the party from the Massachusetts Institute of Technology have found a good site near Sawah Loento, and are setting up in addition to their eclipse instruments, a number of geodetic instruments, among others a short-period pendulum. They also have a program of observations with magnetometers in continuation of their work in last year's eclipse, in which definite movements were detected in the magnets at the moment of totality.

The Japanese party, including Professors Shin Hiroyama and Seiji Hirayama, of Tokio, and five Japanese assistants, will probably find a station at Padang, as also will the parties from the Jesuit Colleges at Calcutta and Manila. We learn that a German expedition is to arrive on April 28th, and that Count de la Baume Pluvinel will arrive on the same date and proceed to Solok.

It is too early to speak of the chances of clear skies for the various parties, and at present it would seem that success is very precarious. It is fortunate that totality occurs at midday; the sky is frequently clear then, though many fleeting clouds pass over the sun. Meanwhile, the preparations are being pressed forward with a good will by observers and resident authorities alike.

---

SILAS W. HOLMAN.

SILAS WHITCOMB HOLMAN was born at Harvard, Massachusetts, Jan. 20, 1856, and graduated from the Massachusetts Institute of Technology in 1876, having made a specialty of the study of physics throughout his course. He was thereupon appointed to a position as assistant in the physical laboratory of that institution, but on ac-

count of illness did not enter upon his duties until a year later. Continuing in the service of the Institute, he was promoted to more advanced positions and was made professor of physics in 1893. Even at this date his health, never firm, had become much impaired, and a few years later it became necessary for him to relinquish active work. In 1897 he was made emeritus professor of physics. He died April 1, 1900.

Professor Holman's original contributions to science are of high merit and give evidence both of great skill in manipulation and of remarkably clear insight into the choice of methods for conducting a difficult investigation.

The most important of his researches are those upon the viscosity of air and carbonic acid as affected by temperature, which were published in the *Proceedings* of the American Academy of Arts and Sciences in 1876 and 1885, the first of which was based upon his graduating thesis at the Institute of Technology. These contain by far the most complete study of this difficult subject which had been made up to their date, and the results are still of standard value. Indeed, within the past few years, they have played an important part in the advancement of the kinetic theory of gases.

In the same *Proceedings* for 1886 is found a further noteworthy paper, written in conjunction with one of his pupils, upon the determination of fixed reference points for thermometric measurements at high temperatures in which several such points are established.

A number of years later, in 1895, appeared another group of papers, the last published by him, relating to the thermo-electric measurement of high temperatures, and a single paper upon calorimetry, which subjects had occupied much of his attention for some time previous. Of these, the one entitled

'Thermo-electric Interpolation Formulæ' is particularly valuable for its critique of the various methods of interpolation which have been employed in dealing with the results of high temperature observations, and that upon the 'Melting Points of Aluminium, Silver, Gold, Copper and Platinum,' published in collaboration with his pupils, Messrs. Lawrence and Barr, contains what are undoubtedly the best measurements of the points of fusion of these metals that had been obtained at the time of their publication. A third paper contains a description of a novel method of calibrating the LeChatelier thermo-electric pyrometer, and the fourth a new method of applying the cooling correction in measurements of the heat of combustion.

The papers of Professor Holman, thus far referred to, have all been published in the *Proceedings* of the American Academy. Several others of minor importance have appeared in different scientific journals. An extended critique upon thermometry of precision, presented at the Boston meeting of the American Association for the Advancement of Science in 1880 unfortunately was never printed.

Besides his published researches, Professor Holman was the author of several valuable scientific works. The two volumes of 'Physical Laboratory Notes,' prepared for the use of his pupils in the Massachusetts Institute of Technology, embody the results of many years of successful experience in teaching and form an important contribution to the literature of the subject. They contain much original matter and exhibit a rare discrimination in the selection and comparison of the methods of measurement which are discussed. This is particularly the case with the volume relating to electrical measurement and testing.

In 1892 he published a treatise upon 'The Discussion of the Precision of Measurements,' the basis of which consisted

of the notes of lectures given to his classes. This volume, which is quite unique in its contents, contains in convenient form a very compendious and lucid consideration of the application of the principles of least squares to the theory of observations, the calculation of their precision and the choice of proportions in designing physical apparatus to be used for measurement. Its value as a text-book has been very great.

The collection of four- and five-place logarithmic tables, prepared in 1896, embodies several features of marked originality, and is prefaced by a brief but exceedingly useful discussion of the fundamental principles of computation which contains many useful suggestions for the economizing of labor.

The last work written by Professor Holman, entitled, 'Matter, Energy, Force and Work,' appeared in 1898 and is of a character widely different from any of those which preceded it. It is a philosophical study of the fundamental concepts of modern physics, in which the subject is approached from the point of view that matter and energy, rather than matter and force, are the primary entities with which physics, has to deal, and that matter itself may be dependent upon energy for its own existence. While not technical in its character, and intended especially for the help of teachers not wholly familiar with modern views, it is distinguished throughout by great clearness and is a remarkable presentation of the newer modes of viewing the subjects which it considers.

Valuable as are his scientific publications, however, Professor Holman's great work was that of a teacher of young men in the laboratory. From the beginning of his service as an assistant in the Rogers Laboratory of Physics his influence was marked, and by his patient labors extending through many years, he brought the work which was under his charge to a high state of develop-

ment. He possessed great skill in the planning of apparatus and methods and remarkable judgment as to the processes best suited either for purposes of instruction or for the securing of accurate scientific results. To the development of the Laboratory of Electrical Measurements in the Massachusetts Institute of Technology he gave for years his best endeavors, and to him is due the success of its work. He was also placed in charge of the newly instituted Laboratory of Heat Measurements, and though prevented by failing health from developing this as he would have chosen, he laid a solid foundation for those coming after him.

Professor Holman was born a teacher, and never grew weary in his profession. His personal relations with his pupils were very intimate. By that example which is better than the wisest precept, he impressed upon them the preeminent necessity of thoroughness, accuracy and honesty in all the work which they might be called upon to perform, either as students or in professional life. He is remembered by them with the most affectionate regard.

Reference has already been made to the interference of ill-health with the prosecution of the labors of Professor Holman. In fact, after reaching manhood he was never in good health, and during almost the whole of his active life as a teacher he struggled with a painful chronic disease, which gradually, though with some intermissions, sapped his strength. His cheerful disposition and persistence in carrying on his work were such that none but those who knew him well were aware of the fact that it was only his indomitable courage which prevented him from yielding to his malady for some years before it finally overcame him. In the spring of 1890 he was obliged to discontinue work for a time. He spent the following year abroad and came home much improved in health; but the

relief was only temporary. In 1895 he finally gave up his work of instruction. For some years after this, however, though confined to his chair and at last even deprived of his sight, he continued to labor diligently and published the tables of logarithms and the work on matter and energy mentioned above. His latest years were his best ones, and his whole life was a fine illustration of the manner in which a noble spirit may rise superior to circumstances and produce the best results under conditions to which an ordinary mind would utterly succumb.

CHAS. R. CROSS.

---

SCIENTIFIC BOOKS.

*Botany—An Elementary Text for Schools.* By L. H. BAILEY. New York, The Macmillan Company. 1901. 8vo. Pp. xvi + 356. Price, \$1.10.

*Foundations of Botany.* By JOSEPH Y. BERGEN, A.M. Instructor in Biology, English High School, Boston. Boston, U. S. A., Ginn & Company. 1901. 8vo. Pp. xii + 412 + 258. Price, \$1.50.

Within the past three or four months two notable text-books on high-school botany have appeared, the one from the ready pen of Professor Bailey, of Cornell-University, to whom we are already indebted for so many helpful and suggestive books on various phases of plant life, the other from Instructor Bergen, of one of the Boston High Schools, who also has the distinction of having written acceptably in the preparation of an earlier, very useful, although much simpler, text-book for high-school students.

The two books are quite different in both content and mode of treatment. Professor Bailey takes the quite extreme position that 'the schools and teachers are not ready for the text-book which presents the subject from the viewpoint of botanical science,' and is particularly opposed to the use of the compound microscope in high schools, as when he says: "The pupil should come to the study of plants and animals with little more than his natural

and native powers. Study with the compound microscope is a specialization to be made when the pupil has had experience, and when his judgment and sense of relationship are trained." A little later he says: "It is often said that the high-school pupil should begin the study of botany with the lowest and simplest forms of life. This is wrong. The microscope is not an introduction to nature." We do not quite like the tone of non-approval in regard to science and specialists which is heard now and then in the author's preface, as in the first sentence quoted, where botanical science is referred to, and in this, "A book may be ideal from the specialist's point of view, and yet be of little use to the pupil and the school," and, "Every statement in an elementary text-book has two values—the teaching value and the scientific value," and, again, "Education should train persons to live, rather than to be scientists," and still, again, "Expert specialists are so likely to go into mere details and to pursue particular subjects so far, when teaching beginners, as to miss the leading and emphatic points." There is already too much of this feeling abroad in the land, as witness the recent discussions in Congress on matters of scientific importance, and there is no call for any one to increase it by discrediting any department of science or those who have devoted their lives to scientific work. Of course, we know that the author does not wish to be understood in this way, but his wording is unfortunate and will certainly be so understood by many people.

It would be unfair to quote the foregoing sentences, with the wording of which at least we most emphatically do not agree, and refrain from some quotation of those in regard to which there will be no question, as for example, "In the secondary schools botany should be taught for the purpose of bringing the pupil closer to the things with which he lives, of widening his horizon, of intensifying his hold on life," and, "Botany always should be taught by the 'laboratory method': that is, the pupil should work out the subjects directly from the specimens themselves."

The book is divided into four parts under the titles of 'The Plant Itself,' of 195 pages; 'The Plant in its Environment,' of 37 pages;

'Histology, or the Minute Structure of Plants,' of 42 pages, and 'The Kinds of Plants,' of 66 pages. The first is almost entirely devoted to the gross anatomy and elementary physiology of seed plants, but 24 pages being given to the structure of algæ, fungi, lichens, liverworts, mosses, ferns, horsetails and quillworts. The second part is ecological in a very elementary way, the treatment being well adapted to the needs of the pupils for which the book is designed. The third part, on the contrary, is quite severely technical, in spite of the author's prefatory remarks about the compound microscope, including such technical matters as fixing, imbedding, sectioning with the microtome, staining and mounting, and even not excluding karyokinesis! Part IV, consists of a handy little manual about 300 selected species of ferns and seed plants. Throughout the book the illustrations, of which there are 500, are very pretty, many of them being 'half-tone' reproductions of photographs.

We distinctly do not like the lists of questions at the close of the chapters, each question matching an italic or heavy-type sentence in the text. These will certainly lead to grave abuses. On the other hand, there is much to commend in the book. It is charmingly written by one who knows a great deal about plants, and who is desirous of having the young people know plants as he knows them. His enthusiasm will inspire many a pupil to take up the serious study of plants who otherwise might have passed them by had the subject been presented in a different way, especially where the teacher has little knowledge of botany.

In Instructor Bergen's book we have less divergence from the generally accepted principles in secondary botanical teaching. The author 'has attempted to steer a middle course between the advocates of the out-of-door school and of the histological school of botany-teaching.' That he is not afraid of the scientific or technical aspects of botany is shown by the following quotations:—"The latest authorities in the various departments of botany have been consulted on all doubtful points, and the attempt has been to make the book scientifically accurate throughout, yet not unduly difficult."



\* \* \* "The author has no sympathy with those who decry the use of apparatus in botany teaching in secondary schools and who would confine the work of their pupils mainly within the limits of what can be seen with the unaided eye. If the compound microscope plainly reveals things shown only imperfectly by a magnifier and not at all with the naked eye, use the microscope. If iodine solution or other easily prepared reagents make evident the existence of structures or substances not to be detected without them, then use the reagents." \* \* \* "When the university professor tells the teacher that he ought not to employ the ordinary appliances of elementary biological investigation in the school laboratory because the pupils cannot intelligently use them, the teacher is forced to reply that the professor himself cannot intelligently discuss a subject of which he has no personal knowledge." It is evident from the foregoing that the two authors approach the task of outlining the work for the pupil in the secondary schools with very different ideas as to what may be and should be done.

The book contains three parts, viz., 'Structure, Function and Classification of Plants,' 'Ecology, or Relations of Plants to the World about Them,' 'Key and Flora.' The first part begins with the seed and its germination, followed by chapters on the movements, development and morphology of the seedling, roots, stems, buds, leaves, flowers and fruits. In all this there are many physiological experiments, as well as much work with the compound microscope, one short chapter on protoplasm and its properties being interpolated. We have illustrated here, also, the usual exaggerated emphasis too commonly given to the flowering plants, which have 235 pages given to them as against but 63 pages for the slime moulds, bacteria, fresh-water and marine algae, fungi, lichens, bryophytes, ferns and their allies. The second part is ecological, and follows the usual German treatment of this subject. It contains much interesting information, and pretty and suggestive pictures, but we do not look for much scientific training from the pupil's study of these chapters. At best the pupil will obtain but a very general and vague

notion of the many things referred to here. Some serious errors mar this portion of the book, as in the treatment of 'plant formations' and 'prairies' on page 310.

The 'Flora' is much like most other manuals for beginners, which are made easy by the device of omitting certain families, which among teachers are reputed to be quite too difficult for the young student. It includes seed plants only.

CHARLES E. BESSEY.

THE UNIVERSITY OF NEBRASKA.

*Text-Book of the Embryology of Invertebrates.* By DR. E. KORSCHULT and DR. K. HEIDER. Translated from the German by MATILDA BERNARD. Revised and edited with additional notes by MARTIN F. WOODWARD. Vol. IV., Amphineura Lamellibranchia, Solenoconcha, Gastropoda Cephalopoda, Tunicata, Cephalochorda. London, Swan, Sonnenschein & Co., Ltd.; New York, The Macmillan Co. 1900. 18s.

This is the concluding volume of the somewhat tardy translation of Korschelt and Heider's standard 'Lehrbuch der vergleichenden Entwicklungsgeschichte der wirbellosen Thiere' 1893. As the editor notes in the preface, invertebrate embryology has made immense advances during the last eight years; thus a mere translation of the thorough and scholarly German work would fail to give an adequate account of the present state of knowledge. The translation itself by Matilda Bernard is a very faithful rendering into good English of the original. But the separation of the offices of translator and editor has necessarily limited the revision largely to numerous footnotes and some interpolations. This has the decided defect of preserving conspicuously all that later researches have shown to be errors in the original German edition, and of relegating the corrections to subordinate paragraphs or footnotes in small type easily overlooked by the average student. Thus, to take but a single example, the account of the cleavage of the lamellibranch ovum in the original has been shown to be incorrect, and it is illustrated by diagrams that faithfully and forcibly confirm the error. Yet both are given literally in the translation, and it would re-

quire one already versed in the literature to extract the truth from the footnote revision. Even, however, if the student succeeds in this, he will soon be confused by the plain unrevised statement on p. 106 that the course of cleavage is different in lamellibranchs and gastropods, whereas the recent work has demonstrated a fundamental similarity. It is also to be regretted that the editor should, apparently, have felt unable to replace some of the older figures with more accurate recent ones; not a single figure from the newer works is introduced.

A feature of the revision that will be heartily welcomed is the appendices to the lists of literature, in which the works published since 1893 are included. An important omission from the usually full and accurate lists is that of Heath's valuable paper on *Ischnochiton*, the more noticeable from the scantiness of the literature of the embryology of the *Amphineura*.

Misprints are not common, but it is rather a serious one that credits Hatschek's figures of the cleavage of *Amphioxus* given on p. 537, to Salensky. The present writer finds his initials once F. K. and again F. H., which arouses the suspicion that others also may have ground for complaint.

Take it all in all, the book is a good translation of the standard work on the subject, and the revision will at least suffice to guide the serious student to the more recent literature.

F. R. L.

*The Play of Man.* By KARL GROOS. Translated by ELIZABETH L. BALDWIN, with a preface by J. MARK BALDWIN. New York, Appleton & Co. 1901. Pp. 412. Price, \$1.50.

This is not a drama, as the ambiguous title might signify, but a scientific treatise on sport and pastime, the performance of life's activities not for serious purposes, but for the solitary or cooperative pleasure in them. The author includes in his term the playful activity of the sensory apparatus in feeling, temperature, taste, smell, hearing and sight; the playful use of the motor apparatus, and the playful use of the higher mental powers. His second order of play is socionomic, that is, it takes two or more

to fight, play chess, torment, haze, court, cooperate in diversion. The facts and results of over play and diseased play are not neglected.

Part III. is devoted to theoretical explanation of the sport, the author finding its groundwork in the following:

1. The discharge of superabundant vigor—the physiological cause.

2. Activities of ancestors wrought in their children in the form of hereditary predispositions—the biological cause.

3. Pleasurableness and freedom from purpose—the psychological cause.

4. The enjoyment of imitating what produces agreeable or intense feelings—the esthetic cause.

5. The strengthening of the social tie—the sociological cause.

The closing pages are devoted to the relation of play to pedagogics. We have only space to quote one sentence, "At school one should learn to work, and he who does everything playfully will always remain a child." The reader will find throughout the work a becoming modesty in view of a new science, and a goodly portion of playfulness to relieve the monotony of dull classification.

O. T. M.

*Text-book of Inorganic Chemistry.* By VICTOR VON RICHTER. Edited by PROFESSOR H. KLINGER, University of Königsberg. Authorized translation by EDGAR F. SMITH, Professor of Chemistry in the University of Pennsylvania, assisted by WALTER T. TAGGART, Instructor in Chemistry. Fifth American from the tenth German edition. Carefully revised and corrected. With sixty-eight engravings on wood and colored lithographic plate of spectra. Philadelphia, P. Blakiston's Sons & Co. 1900. Pp. 430. \$1.75.

The continued popularity of this book is shown by the frequent editions; in this edition, notices on liquid air, the new gases in the atmosphere, and ten pages of physical chemistry introduced into the chapter on metals, indicate careful revision, and a desire to bring the book up to date, without changing its general character. The characteristic of von Richter's book is the great amount of condensed

information which it contains compared with other books of its size; indeed, it might be criticized as giving too much for a text-book for beginners, too little for advanced students; yet as this has always been the characteristic of the book through the different editions, the popularity of the work may be held to answer such criticism.

E. RENOUF.

BOOKS RECEIVED.

*Water Filtration Works.* JAMES H. FUERTES. New York, John Wiley & Sons. 1901. Pp. xviii + 283.

*Leçons sur les séries divergentes.* ÉMILE BOREL. Paris, Gauthier-Villars. 1901. Pp. 183. 4 fr. 50 cts.

*Essai sur les fondements de la géométrie.* A. W. RUSSELL. Translated into French by ALBERT CADENAT. Paris, Gauthier-Villars. 1901. Pp. x + 274. 9 fr.

*Moteurs synchrones à courants alternatifs.* A. BLONDEL. Paris, Gauthier-Villars. 1901. Pp. 241. 3 fr.

*The Sea-beach at Ebb-tide.* A. F. ARNOLD. New York, The Century Co. 1901. Pp. x + 490. \$2.40.

SCIENTIFIC JOURNALS AND ARTICLES.

*The Journal of Comparative Neurology* for April opens with two articles from the Neurological Laboratory of the University of Chicago, by Shinkishi Hatai. The first on 'The Finer Structure of the Spinal Ganglion Cells in the White Rat,' describes and figures two varieties of spinal ganglion cells and considers the smaller variety, the chromophilic cells of Nissl, to be an immature stage in the development of the larger variety. In the second paper, 'On the Presence of the Centrosome in Certain Nerve Cells of the White Rat,' the centrosome is described in nerve cells of new-born rats from the following localities: great pyramids of the cerebral cortex, Purkinje's cells, nucleus dentatus, ventral horn of spinal cord and spinal ganglion cells. The centrosomes were less easily demonstrated in the adult and were not found at all in some of these localities. Earl E. Ramsey, of Indiana University, describes 'The Optic Lobes and Optic Tracts of *Amblyopsis spelæus* DeKay,' a blind fish from the limestone caves of the Ohio Valley in which the eye and optic nerve are almost wholly degenerate. The optic lobes of the brain are greatly shrunken, the optic tracts and all parts of the optic tectum directly related to them are

entirely wanting and the remaining layers are generally reduced in thickness. G. E. Coghill, of Brown University, discusses 'The Rami of the Fifth Nerve in Amphibia.' In the course of an examination of the nerve components of *Amblystoma*, he clears up the morphology and homologies of the maxillary and ophthalmic branches of this *Urodele* and of the frog. Dr. Strong (Columbia University) presents a 'Preliminary Report upon a Case of Unilateral Atrophy of the Cerebellum,' in which the left hemisphere of the cerebellum was almost completely wanting. Finally, 'A Bibliography of the Literature on the Organ and Sense of Smell' is given by Dr. H. Heath Bowden, of the University of Iowa. This list contains 885 titles, including anatomical, physiological and psychological subjects.

*The Popular Science Monthly* for May begins with an account of 'The Carnegie Museum,' by W. J. Holland. Frederick A. Cook describes 'The Aurora Australis,' as observed from the *Belgica*, with illustrations showing some of the many forms assumed by this interesting phenomenon, and we have the first instalment of a paper on the 'Progress and Tendency of Mechanical Engineering during the Nineteenth Century,' by Robert H. Thurston. An article on 'Primitive Color Vision,' by W. H. R. Rivers, gives a very good résumé of the evidence on which is based the deduction that color vision has been a comparatively recent acquirement of the human race, and the fifth portion of 'A Study of British Genius,' by Havelock Ellis, is devoted to childhood and youth. Under the title 'The Frog as Parent,' E. A. Andrews gives an interesting account of some of the curious breeding habits to be found among the frogs. In 'Recent Physiology,' G. N. Stewart tells of some of the lines of modern investigation and their results. The final paper, by David Starr Jordan, on 'The Blood of the Nation,' is a study of the decay of race through the survival of the unfit.

*The Plant World* for April contains the following articles: 'Hints on Herborizing,' by A. H. Curtise; 'Notes on the Flora about Nome City,' by J. B. Flett; 'The Native Oak Groves of Iowa,' by T. J. and M. F. L. Fitzpatrick, be-

sides brief articles, including a note on a fossil flower related to *Hydrangea*. The supplement, devoted to 'The Families of Flowering Plants,' by Charles Louis Pollard, treats of the *Sarracinales* and *Rosales*.

AN editorial article in the *Observatory* accuses the *Astrophysical Journal* of reprinting without credit an article on the 'Siderostat' by M. Cornu. As the *Bulletin astronomique*, in which the French copy of the article appeared, was published in February, 1901, and the number of the *Astrophysical Journal* in March, 1901, the editor of the *Observatory* must appreciate the promptness of American methods. As a matter of fact important European articles on astrophysics are published by the authors simultaneously in the *Astrophysical Journal*. This makes the concluding sentence in the editorial in the *Observatory* interesting: "they print the same paper in several journals, so that it may be widely read, whereas in Europe we have made it a point *not* to reprint."

---

#### SOCIETIES AND ACADEMIES.

##### SECTION OF ANTHROPOLOGY AND PSYCHOLOGY OF THE NEW YORK ACADEMY OF SCIENCES.

A REGULAR meeting of the Section was held on April 22d, with Professor Farrand in the chair. Professor Eberhardt Fraas, of Stuttgart, a corresponding member of the Academy, was introduced by Professor Osborn, and briefly addressed the meeting.

Mr. A. L. Kroeher presented some 'Notes on the Arapahoe Indians.' In this paper the social and ceremonial organization of these Indians was compared with that of other Plains Indians. On superficial examination various tribes appear to be organized according to identical principles, but fuller knowledge generally reveals differences among the similarities. From this it was concluded that such terms as gens, band, age-fraternity and dance-society have no stable or exact meaning and hence little descriptive value, detailed information being the great desideratum.

Professor C. H. Judd reported an experimental study on 'Practice in Visual Perception.' It is a generally recognized fact that an illusion grows weaker as the observer be-

comes more familiar with it. A quantitative determination of the disappearance of the illusion seen in the Müller-Lyer figure was the subject of the paper. Two series of results were reported, one from an observer who looked forward to the disappearance of the illusion, the other from an observer who did not know that the illusion would disappear and did not discover that it was disappearing. In both cases the illusion disappeared in about 1,000 observations. The curves of practice differ in form and show many details of effects of pauses. In the case of the first observer the effects of the practice gained in the first series was easily marked in all the additional series which were performed with other figures and with other positions of the first figure. In the case of the second observer the effect of the practice was in some cases positive, but in one case it was so decidedly negative that it exaggerated the illusion and prevented any disappearance of it through a series of 1,500 observations.

Professor E. L. Thorndike, in a paper discussing the 'Origin of Human Intellect,' proposed as a working hypothesis that the development of ideation and rational thinking in the human species was but an extension of the typical animal form of intellect. He defended this hypothesis by showing that mere increase in the number, delicacy and complexity of associations between sense-impressions and impulses might give concepts, feelings of relationship and association by similarity as secondary results, that in the human infant this seemed to occur and that down through the vertebrate phylum a clear evolution of the associative processes along these lines could be traced.

The last report of the evening was by Dr. R. S. Woodworth, on the 'Voluntary Control of the Force of Movement.' By recording simultaneously the force of a blow struck by the hand and the extent of the movement preliminary to the blow, it is possible to see how far the force is dependent on the extent. The results showed a certain degree of correlation between the two, but comparatively a slight degree. The inference was that the force of the movement was only partially and loosely dependent on the extent, and that the control and perception of the force of a movement were in

some measure a direct and independent function.

R. S. WOODWORTH,  
Secretary.

SECTION OF BIOLOGY OF THE NEW YORK ACADEMY OF SCIENCES.

A REGULAR meeting of the Section was held on April 8th, Mr. M. A. Bigelow presiding. The following program was offered :

E. B. Wilson: 'The History of the Centrosomes in Artificial Parthenogenesis, and its Relation to the Phenomena of Normal Fertilization.'

F. S. Lee: 'Some Observations on Rigor Mortis.'

In continuation of his communication given at the December meeting, Professor E. B. Wilson presented the results of further studies on the development of the unfertilized eggs of *Toxopneustes* when treated by Loeb's magnesium chloride method. The principal points considered were the origin and history of the centrosomes and the general relation of the phenomena to those occurring in normal fertilization. Evidence was brought forward that the cleavage centrosomes of the primary division figure arise by the division of a single primary centrosome that is formed outside, but immediately upon, the nuclear membrane. As regards the chromatic transformation of the nucleus, two types of chromosome formation were described. In both cases a large nucleolus is formed, which attains a much greater size than in the fertilized eggs. In one type this nucleolus remains a plasmosome, or true nucleolus, which fades away at the time of division, the chromosomes arising nearly in the usual manner from the chromatin network. In the second type, the entire chromatic content of the nucleus is gradually accumulated in the nucleolus, which thus forms a chromatin-nucleolus, from which the chromosomes are afterwards derived nearly in the same manner as in *Spirogyra*. In regard to the accessory asters, or cytasters, it was shown that they contain central bodies often indistinguishable in sections from the centrosome of the nuclear figure, though in many cases less well developed. Sections demonstrate that the division of the cytasters is preceded by division of the central body, which draws out to form a

central spindle in a manner similar to that described by MacFarland in the eggs of gastropods. This fact, taken in connection with the physiological activities of the cytasters, seems to remove every doubt regarding the identification of the central bodies as true centrosomes. In comparing the phenomena in the magnesium eggs with those of normal fertilization, it was pointed out that the formation of accessory asters at the time of fertilization or cell-division is a widespread phenomenon. In normal fertilization or division, the accessory asters are of very transient character. In the magnesium eggs they attain a much greater development both structurally and functionally, but they are probably to be regarded as differing only in degree from those which appear during the normal process. In all cases, their disappearance is probably due to a concentration of the protoplasmic activities about the more active centers, connected with the nucleus, which alone survive to perform the normal functions of division. Evidence was adduced that the nuclear transformation occurring in normal fertilization is not primarily due to the union of the sperm-nucleus, or sperm-centrosome with the egg-nucleus, but to a general stimulus of the ovum effected by the entrance of the spermatozoon. Apart from the different character of the stimulus, this transformation of the egg-nucleus does not differ essentially from that taking place in the magnesium eggs. This is proved by the fact that in etherized eggs the egg-nucleus may undergo the karyokinetic transformation *without union with the sperm-nucleus or centrosome* — an observation which agrees with the much earlier results of O. and R. Hertwig on eggs treated with chloral hydrate. In normal fertilization this activity of the egg-nucleus is modified through its union with an active individualized sperm-centrosome, the presence of which inhibits the formation of an egg-centrosome such as occurs in the magnesium eggs.

Professor F. S. Lee stated that rigor mortis is characterized by a shortening of the muscles of the body, accompanied by a coagulation of the contents of the muscle cells. The nature of the phenomenon is disputed. Hermann has long insisted that it is analogous to muscular

contraction and is the final vital act of the dying muscle cell. In connection with his studies of muscle fatigue, the author, with Mr. C. C. Harrold, has made some observations on cat's muscle, which seem to contradict Hermann's conclusion. Fasting, which is characterized especially by a diminution of the free carbohydrates in muscle, hastens the on-coming of rigor mortis. The administration of the peculiar drug, phlorhizin, which eliminates both the free and the combined carbohydrates, has a similar but much more pronounced effect. On the other hand, the ingestion of grape-sugar by a phlorhizinized animal delays rigor. Hence the conclusion seems justified that the absence of carbohydrates is favorable, and their presence unfavorable, to the development of rigor mortis. As regards the ability of the muscle to contract, carbohydrates have exactly the opposite effect, their absence being unfavorable and their presence favorable. Hence, in this respect, contraction and rigor mortis are not analogous processes.

HENRY E. CRAMPTON,  
*Secretary.*

SECTION OF ASTRONOMY, PHYSICS AND CHEMISTRY OF THE NEW YORK ACADEMY OF SCIENCES.

THE section met on May 6th, at 8:15 P. M. The first paper of the evening was by Mr. C. B. Warring, entitled 'What Theology owes to Modern Science.' The paper was a very interesting interpretation of the Mosaic cosmogony in the light of modern scientific theories. The author defended the thesis that the order of events given in the cosmogony of Genesis did not necessarily contradict the order assumed by modern science. The paper was followed by a very interesting discussion.

The second paper of the evening, 'A Differential Astatic Magnetometer, suggested by Professor Rood,' was read by Mr. C. C. Trowbridge. The essential part of the instrument described is the suspension system, which consists of two groups of small magnets, set 23 cm. apart, rigidly connected by a fine glass fiber. The system is suspended by a single raw silk fibre 10 cm. long. By making the polarity of the two groups of magnets opposite, a system that is approximately astatic is obtained.

The object of the arrangement employed is partly to annul the effects of distant magnetic disturbing influences, such as those that arise from trolley car motors, etc., and partly to obtain a sensitive system that will act on the differential principle.

A magnet placed within a meter of the instrument and outside of the neutral plane between the two groups of magnets acts strongly on the nearest group, producing a deflection of the system.

The instrument was used in relative determinations of magnetic moments.

Mr. Trowbridge also gave a preliminary note on some experiments conducted by him on the influence of liquid air temperatures on the magnetization of steel and iron.

Magnets made from Crescent Co. and Sheffield magnet steels were chiefly tested.

The magnetic moment of bars magnetized at  $-186^{\circ}\text{C}$ . and at  $20^{\circ}\text{C}$ . were found to be approximately the same, other conditions being equal. This was found to be true for both the steels mentioned.

Three Crescent steel bars magnetized at  $-186^{\circ}\text{C}$ . were found to lose 38, 30.6, and 30.2 per cent. of magnetism when warmed to  $20^{\circ}\text{C}$ . A bar of this steel magnetized at  $20^{\circ}\text{C}$ . lost 9.5 per cent. of magnetism when cooled to  $-186^{\circ}\text{C}$ .

These magnets after 9 days of approximately constant temperature at  $20^{\circ}\text{C}$ . were found to have further lost 6.1, 5.7, 8, and 12 per cent. of magnetism respectively.

Two bars made from Sheffield tungsten steel magnetized at  $-186^{\circ}\text{C}$ . lost 12.2 and 15.7 per cent. magnetism when warmed to  $20^{\circ}\text{C}$ .

One bar of this steel magnetized at  $20^{\circ}\text{C}$ . lost 6.5 per cent. when cooled to  $-186^{\circ}\text{C}$ .

A bar of Stubbs tool steel magnetized at  $20^{\circ}\text{C}$ . changed in magnetic moment, when cooled and heated between  $-186^{\circ}\text{C}$ . and  $20^{\circ}\text{C}$ ., as follows: at  $-186^{\circ}\text{m}$ .  $-12.7$ ; at  $20^{\circ}$   $-30.5$ ; at  $-185^{\circ}$ ,  $+18$  per cent.

Mr. Trowbridge stated that results similar to that found in the experiment with Stubbs steel have already been obtained by Professor Dewar.

F. L. TUFTS,  
*Secretary.*

## TORREY BOTANICAL CLUB.

AT the meeting of the Club on March 10th, Dr. Marshall A. Howe discussed 'The Algal Genera *Acetabularia* and *Acicularia*' in the light of specimens recently collected by him in the Bermudas. One of the specimens he had identified as *Acetabularia Schenckii* Möbius by comparison with type material from Brazil. Since its original collection in Brazil the species has been found, according to Count Solms-Laubach, on the island of Curaçoa, off the Venezuelan coast, and also in Guadaloupe, but its occurrence now in Bermuda, about a thousand miles further north, is a point of some interest. The aplanospores in this species surround themselves each with a thick calcareous shell and these shells adhere so that on the decay of the sporangium wall the spores are left in a single coherent mass. On this ground, Solms-Laubach refers *Acetabularia Schenckii* to the fossil genus *Acicularia*, hailing it as the only known living species. The generic separation from *Acetabularia* was thought by Dr. Howe to be defensible, but doubt was expressed as to the nature of *Acicularia pavantina*, the fragmentary fossil on which the genus *Acicularia* was established. Efforts are now being made to secure this *Acicularia* type for examination. With the aid of material preserved in formalin, stages in the development of the disk of both *Acicularia Schenckii* and *Acetabularia crenulata* were followed out which have been observed hitherto only in *Acetabularia mediterranea* and more completely in some respects than have been recorded for this species. This complete series of developmental stages of the disk seems to confirm, with much certainty, the morphological explanation of the disk put forward by Solms-Laubach in 1895. The disk as a whole is evidently not a complex aggregate of primary 'leaf-whorls' or primary whorls of sterile branches, as is taught by Wille in 'Die natürlichen Pflanzenfamilien' and by others, but is to be homologized with a single primary whorl of sterile branches, as has been suggested somewhat tentatively by Count Solms-Laubach. A point of some biological interest is found in connection with the aplanospores of *Acicularia Schenckii*, the walls of which are provided with a circular lid or operculum to permit the

escape of the zoogametes. As the spores lie embedded in the calcareous massula the lid is always turned toward its surface and is but slightly, or not at all, incrustated with lime. It is expected that Dr. Howe's paper will be published in full in an early number of the *Bulletin*.

The second paper, by Mrs. E. G. Britton and Miss Alexandrina Taylor, was on the life-history of *Schizaea pusilla*, *Lygodium palmatum* and *Vittaria lineata*. Living and pressed specimens were shown of all three; also microscopic preparations and drawings illustrating the gametophyte from the spore to the sporophyte in the various stages of development. For *Schizaea pusilla* the exhibit of the life-history was very complete, and the descriptions and plates have already been published in the *Bulletin* of the Torrey Botanical Club for January, 1901. In *Lygodium palmatum* the development has been slow. During the winter, in the laboratory, the spores have germinated and formed an irregular protonemal growth, finally perfecting their normal prothallia, which are spatulate and bifurcated at apex. Thus far no antheridia or archegonia have been found. Of *Vittaria lineata*, fresh material was received from St. Augustine, Florida, early in February and a complete series of slides and drawings secured, showing a much branched thallus, bearing gemmæ at the extremities, as described by Goebel in certain East Indian species. The gemmæ were found bearing antheridia, radicles and young prothallia, evidently serving the double purpose of a sexual reproduction and cross-fertilization. The sporophyte in its young stages was also studied and the structure and venation worked out. Pressed specimens, named *Vittaria lineata*, were shown from the herbarium of Columbia University, which had been compared with Fee's monograph of the genus. Many of these were found to be incorrectly named as a comparison of the spores, sporangia and bracts at the base of the leaf proved.

Professor Underwood commented on the Linnean treatment of the *Vittarias*, and their subsequent mutations.

Professor Millsbaugh, of the Field Columbian Museum, Chicago, spoke briefly on the results

of a recent trip to the West Indies for the purpose of studying the economic fruits of the tropics.

D. T. MACDOUGAL,  
*Secretary pro tem.*

DISCUSSION AND CORRESPONDENCE.

BIBLIOGRAPHY OF GEODESY.

TO THE EDITOR OF SCIENCE: In the Report of the United States Coast and Geodetic Survey for 1887 there was published a Bibliography of Geodesy. Since the date named so many important contributions have been made to the literature of this subject that during the last meeting of the International Geodetic Association a resolution was passed requesting the undersigned to prepare a new edition of the Bibliography.

This work is now well under way, and every possible effort will be made towards making it complete. This desirable end can be attained only with the assistance of those authors who are good enough to send as soon as possible titles of their publications to the address given below.

As in the first edition, it is proposed to include all papers, books and reviews, pertaining to geodesy, least squares, figure of the earth, density of the earth and gravity determinations, including theoretical discussions of the pendulum.

In complying with this request, authors should give:

1. Full name.
2. Complete title.

a. If book, give size, number of pages in *preface* and in *body* of book, number of plates and illustrations, date and place of publication.

b. If in a serial publication, give name of publication, volume, and year and pages occupied by the contribution.

- c. If a review, state the title of work reviewed.

In case the work has been reviewed, give name of reviewer and where the review may be found.

If preferred, in order to insure harmony in the form of making out the titles, publications may be sent to the undersigned. The International Exchange Service of the Smithsonian Institution has graciously consented to transmit

such works as may be forwarded with the object named in view. They should be sent in my name to the Smithsonian Institution, Washington, D. C.

By giving this their early attention, author will confer a favor upon the compiler and upon those who may find it necessary to consult the work when published.

J. H. GORE.

COLUMBIAN UNIVERSITY,  
WASHINGTON, D. C.

SHORTER ARTICLES.

NOTE ON THE WESTERN TERTIARY.

THE recently published discussion on 'The Freshwater Tertiary Formations of the Rocky Mountain Region,'\* by Professor W. M. Davis, in which he indicates published evidence to prove those supposed lacustrine deposits not to have deposited in large lakes, but rather in regions of lakes and rivers, explains well the Eocene deposits which I have seen in north-western Wyoming in the Bighorn basin. This region was visited by a party from the University of Minnesota in the summer of 1899.

The Eocene badlands there show an extent of horizontal strata which, when viewed as it is exposed for miles around one, does suggest at once a large filled lake basin. But there is a rapid alternation of clay and sand strata, and the several diverse kinds observed recur so unequally, and yet often so monotonously that the theory of a large permanent lake does not suffice to explain the phenomena. In fact while exploring for fossils I had the impression that we were not beyond the supposed lake's marginal zone, even when 40 miles or more from the formational boundary, and came finally to believe that this freshwater Tertiary might be different from others of the West. Professor Davis's argument now convinces me that it is not.

In order to find fossils rapidly one had to search out what we called rivers and bogs. The former are shallow trough-shaped beds of sand occurring either as intercalated masses or as thickened parts of a regular stratum. The bogs occurred here and there, more or less

\* *Proceedings Am. Acad. Arts and Sci.*, Vol. XXXV., p. 345.



clearly indicated by color and by small rough clay-iron residuum when weathered. Fossils occurred most frequently in those deposits and one became aware of their discontinuity when trying to follow them in search of their contents. The sand troughs or rivers yielded the whole bones, *i. e.*, vertebrae with processes and even rarely whole skeletons. The bogs yielded fragmentary bones. These were found to have been gnawed, as a rule, and the gnawing had been done also where they now lie in the strata. Legs were found bitten off at the knees, as if the animal had mired and its buried parts thus escaped being devoured. Also numerous fragments of, evidently, a single animal would occur scattered about, the ends and thin parts of bones being gnawed off. For example, more than once a *Coryphodon's* large tooth was found with the surface, including the enamel, chiseled off by some corrugated tooth, probably that of some Tillodont mammal. Plates of turtles' plastron had likewise been nibbled all around their margins. In fact, worthless fragments composed the greater part of the fossils.

When one had become skilled in detecting the differences between those pieces fractured before, and those after, fossilization, many strange things began to be evident, such as fragments taken from the same stratum at some distance apart, proving to be those of one bone; and again fragments representing the same parts of several animals occurring in one spot, the other parts of all being absent. A lot of molar teeth and an odontoid process seem often to represent a head and neck. This all appeared to be incidental to the feasting that had preceded fossilization.

That crocodiles and turtles may have done the gnawing in part was suggested by their fossil remains, but that the chiseling process was theirs could not be maintained. In some cases, maceration had left the bones shapeless or thickly encrusted with iron. And this maceration as well as the chiseling might well argue the subaerial deposition of the bones.

I may mention also two geologically significant phenomena which require close observation to distinguish them. Original stratigraphic inequalities, amounting sometimes to local un-

conformability, might be passed unnoticed among the numerous similar looking inequalities due to unequal induration of the rock, the latter being intimately associated as to its cause with the physiographic changes now developing. And the color banding may be both original stratigraphic and secondarily modified. I remember one fine example of a large trough filled with a series of clay and sand strata, seen at a distance on the left of the trail ascending Tatman's butte to the Buffalo basin. But not having had time to examine it minutely, I scarcely dare assert that it might not be secondary cross-coloring. Close at hand one would not have noticed it, because the whole could not have been seen, and the slow thinning out of individual strata would be nothing unusual. Expeditions into badlands for the purpose of collecting fossils can not well take time in one season to gather and verify occurrences sufficient to prove the exact geologic nature of the deposit of part, much less the whole, of a basin, which, however, expeditions for that express purpose might do.

FREDERICK W. SARDESON.

UNIVERSITY OF MINNESOTA,

April 6, 1901.

#### AN UNUSUAL TYPE OF AURIFEROUS DEPOSIT.

ONE of the most unique deposits of gold-bearing material which the writer has ever seen has been worked during the past three or four years at the King Solomon mine. It is situated near the summit of Cañon mountain, in the basin of the South Fork of Salmon river, in the southwestern part of Siskiyou county, California.

The ore consisted of a body of semi-decomposed country-rock, including micaceous schist, slate and greenstone, heavily stained with the oxides of iron and manganese and containing fine particles of free gold disseminated through it. The deposit had a length of about 500 feet, an average width of 60 feet and mainly a workable depth of 50 feet, although a much narrower body of ore continues to greater depth. Mining operations have been conducted in several large open pits, beneath the floors of which have been excavated tunnels. The ore is shoveled from the loose crumbling slopes of the pits into

barrows, then wheeled and dumped through chutes in the floor, and hauled out of the tunnels in cars.

Along certain narrow streaks the ore was of good grade, carrying values as high as several hundred dollars to the ton; but it has been the policy of the company to work the deposit on a large scale and in a cheap manner; hence, everything has been removed which contained sufficient gold to pay a small profit. In this way the average yield per ton of the ore was, during the first few years, brought down to \$7 and even \$5 in gold and later this was further decreased to \$3.50. From month to month the ore showed a remarkable uniformity in tenor, although but 40 to 70 tons were handled per day, and this was taken haphazard within the limits of what was determined to be the ore-body.

Running through the center of the deposit, and parallel with its major axis, there was a narrow dike of white acid porphyry, such as is commonly associated with gold-bearing veins of this region, and the entire ore-body has frequently been reported as a mineralized dike. However, the acid dike is not ore, but is thrown away as waste. On both sides the ore-body extended away from it to a distance of 20 to 50 feet and terminated irregularly in the mass of the decomposed rock, there being no well-marked walls or other evidences of common vein action. The grade of the ore was closely connected with the intensity of the iron stain and particularly with the quantity of brown manganese oxide present.

At first thought, this large deposit of red, soft, decomposed rock carrying free gold was considered the upper or oxidized portion of a zone of impregnation of auriferous sulphides such as are rather common in this northwestern California region; but a consultation with the superintendent of the mine, Mr. F. N. Fletcher, brought to light some facts which demonstrate that it is certainly of an entirely different character. It is unique among deposits of this country in the following two points:

1. It is absolutely free from any traces of pyrites changed to limonite such as are always found in panning the surface portion of other veins.

2. It does not present any evidence of passing in depth into a shear zone modified by solfataric action and impregnated with auriferous sulphides.

Upon first arrival at the mine, the writer was impressed by the marked resemblance in the tint and character of the deep red staining to those of certain accumulations of residual red clay found frequently in hollows in the surface of limestone formations, as, for instance, over the Galena limestone in the Mississippi basin. This suggested an explanation for the origin of the deposit which was subsequently worked out as follows:

The site of the King Solomon mine, which is at present the top of a mountain ridge, was once the bottom of a rather deep, broad basin eroded by subaerial agencies from a series of quartzites, black slates and limestone. This series was intersected by numerous narrow branching dikes of greenstone. Evidence that a small amount (say a trace) of gold was a primary constituent of this system of eruptives has been found in different parts of this country.

The carbonated meteoric waters circulating laterally and downward beneath the slopes of the basin, dissolved gold out of these greenstone dikes and carried it, along with iron and manganese salts (derived from pyrites in the quartzites and slates), to the center of the basin, where, just beneath the surface, these minerals were precipitated as free gold, ferrous carbonate or hydrous ferric oxide and some salt of manganese, perhaps the last in its present form of oxide. Precipitation was probably due, as in the case of limonite and wad in bogs, to the decreased circulation of the water at the center of the basin, and in part also to the water rising close to the surface and becoming subjected to the oxidizing influence of the atmosphere.

Subsequently, through great erosion of the region, the water level was depressed in the strata, the basin no longer existed, and the limonitic deposit worked downward, penetrating to unequal depths in different places. The porous schists and slaty rocks were deeply stained with the oxide and impregnated with gold, but the acid dike in the center of the deposit was largely impervious to the solution and escaped heavy mineralization.

In short, the King Solomon ore-body has had a mode of formation roughly analogous with that of the limonite ore deposits of the Great Valley of the Appalachian region, and of the limestone regions of southern Missouri. Such accumulations of ferruginous matter as the result of deposition from waters of ordinary surface temperature, and circulating within several hundred feet of the surface of the earth, are of common occurrence in many parts of the world, and may be found in other sections of northwestern California, but they are not often auriferous to an appreciable extent. It is its gold contents which make this King Solomon deposit so remarkable.

To the writer, the scientific interest of the preceding facts appears to be in their bearing on the question of the power of ordinary sub-surface waters to dissolve and redeposit gold under conditions not favorable to the production of iron pyrites. We seem to have here a clear case where metallic gold has been put through the same process of solution, concentration and precipitation as has the staining material, the oxides of iron and manganese.

OSCAR H. HERSHEY.

BERKELEY, CALIF., Jan. 20, 1901.

#### CURRENT NOTES ON PHYSIOGRAPHY.

##### TALLULAH GORGE, GEORGIA.

THE studies of Hayes and Campbell on the southern Appalachians have made us familiar with the general features of a contested drainage area in northeastern Georgia, where the headwaters of the Savannah (Tugaloo) river are capturing those of the Chattahoochee. Some further details of the changes thus effected are described in a brief essay on 'The Geology of the Tallulah Gorge,' by S. P. Jones (Amer. Geol., XXVII, 1901, 67-75). The gorge is narrow, steep-sided, and over 500 feet deep; the river flows through it in a succession of cascades and rapids; it is evidently a young river course. The precise order of events in the development of the gorge does not appear to have been made out; indeed the author here cited does not seem entirely convinced of the process of capture as an efficient cause for the new order of things. Yet it is certainly signifi-

cant that the gorge, unusual if not unique in sharpness of form among the southern Appalachians, should occur in immediate association

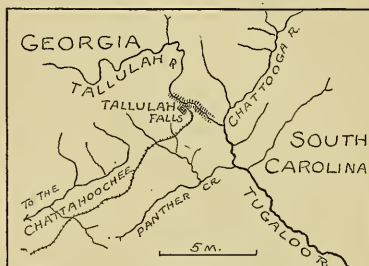

with a group of features whose systematic relations would seem to point unequivocally to the invasion of one river basin by the head branches of another.

In view of the open form and gradual descent of the Chattooga valley in contrast to the narrowness of the Tallulah gorge and the rapid descent of the river through it, one may reasonably conclude that the first was captured much earlier than the second. This makes it seem probable that the Tallulah formerly followed a course near the railroad line, and that its entrance into the Chattooga is the result of diversion by the headward growth of a creek on the line of the gorge; although a somewhat different opinion is expressed in the article here abstracted.

##### PREHISTORIC LANDSLIDES IN THE ALPS.

CERTAIN Alpine valleys contain huge accumulations of mountain waste, described as moraines by earlier observers, but now interpreted as landslides (see SCIENCE, II., 1895, 618). The latest special study on this subject is by J. Oberholzer ('Monographie einiger prähistorischer Bergstürze in den Glarner Alpen,' Beitr. Geol. Karte der Schweiz, n. f., IX, Lief., Bern, 1900). It discusses a number of large prehistoric slides in the neighborhood of Glarus, giving abundant details as to structure, source, path, volume, etc. A colored map, 1:20,000, shows the geological formations of the district in the slides as well as in the mountains. Some of the slides still bar their valleys and hold back lakes;

others have been trenched by streams. All show more or less distinct changes of form by weathering and washing (especially where torrent fans are built upon them), although generally retaining something of the tumult of surface that characterizes recent slides. One of the slides (that by Schwanden in the Linththal) has a small amount of morainic material strewn over its surface, as well as more abundant moraine beneath it; and from this Oberholzer concludes that it occurred during the last interglacial epoch. But inasmuch as its surface is still very uneven, it can hardly be believed that it has been overridden by more than a small and short-lived glacier.

No reference is made to the suggestion, which is certainly gaining ground among Swiss observers, that the landslides of the class here described result from the oversteepening of the basal slopes of valleys that have been overdeepened by glacial erosion.

#### THE GREAT AFRICAN LAKES.

THE peculiar likeness of the fauna of Lake Tanganyika to marine forms has prompted a special study of the Great African Lakes by an expedition under the direction of J. E. S. Moore, whose report contains matter of much value (Tanganyika and the countries north of it. Geogr. Journ., XVII., 1901, 1-85).

North of Tanganyika, the floor of the great rift valley or *graben* in which the lakes lie rises to form a strong barrier which once constituted part of the divide between the Congo and the Nile drainage systems. But now a group of large and active volcanoes some 50 miles further north, one of which is 13,000 feet high, have built a second barrier on the valley floor, thus cutting off the basin of Lake Kivu from that of Albert Edward Nyanza, and raising the former nearly 2,000 feet. That Kivu was once tributary to the Nile is clearly shown by its fauna, which is in nearly all respects identical with the normal fresh-water lake fauna of the Nyanzas to the north; but its outlet, Rusisi river, now flows south with many cataclysms over the rocky swell in the valley floor, thus connecting Kivu with Tanganyika; and it is evidently since this connection was made that a fish characteristic of the Congo basin has

reached Kivu. The rift valley, the active volcanoes far inland, the great lakes and their peculiar fauna combine to make this a region of remarkable interest.

W. M. DAVIS.

#### RECENT PROGRESS IN PALEONTOLOGY. CONGESTION OF MUSEUMS.

IT is very important that the various museums of the country should receive special funds with which to work up the collections of vertebrate fossils that are rapidly accumulating. Much more time is required in preparing a fossil than is spent in collecting and shipping it from the field. The result is that all the museums of the country which have been collecting during the past few years are greatly congested with material. According to a moderate estimate, from five to fifteen years of constant work must be spent upon the collections now in each of our museums. The delay in working up fossils of various types threatens to cause serious inconvenience and delay in the matter of publication. Even highly trained preparators are unable to prepare a fragile fossil rapidly. Some single dinosaur vertebræ, for example, are so broken that from a month to six weeks must be spent upon them. The collections which have already been made in the West fill thousands of boxes, and the most welcome gift which could be made to any of our museums would be a gift especially for the purposes of preparation.

#### SPECIAL INVESTIGATIONS.

A GRATIFYING division of labor is in progress among the vertebrate paleontologists of the country. In Kansas University, Professor Williston is beginning a very careful study of the Plesiosaurs, which will form a sequel to his admirable memoir upon the Mosasaurs. In the University of California, Dr. Merriam is making a special examination of the John Day fauna. In Yale University, Dr. Wortman is thoroughly revising the rich collections made in the Eocene or Bridger beds, and will publish a series of papers illustrating Professor Marsh's principal types. In the American Museum, Dr. Hay is especially studying the fossil *Chelonia* of the American Museum and Cope collections; Dr. Matthew is making a study of the *Creodonts* of

the Miocene fauna of Kansas and eastern Colorado, of which much remains to be done; Mr. Gidley is working upon the Pleistocene horses, and has just completed a very careful revision of the species; Dr. McGregor is working upon Belodon and the Phytosauria, comparing the American and German types; Professor Osborn is especially studying the Titanotheres. At Princeton, Professor Scott is working up the Patagonian mammals. In the Carnegie Museum, Mr. Hatcher has just completed a memoir upon *Diplodocus*.

#### EVOLUTION OF THE HORSE.

A FRIEND of the American Museum of Natural History has recently presented a fund, which is to be used exclusively for the collection, exhibition and study of the fossil horses of America. Professor Osborn has planned two expeditions for the coming season, with the especial object of filling gaps in the already rich series. It is proposed also to mount as complete a series of fossil skeletons as possible, showing all the chief stages in the evolution of the horse from *Hyracotherium* to *Equus*. Four complete skeletons have already been procured, two of which have been mounted. It is also proposed to exhibit recent types of skeletons, showing the effects of artificial selection. H. F. O.

#### AN ARCHEOLOGICAL MAP.

BENEDICT'S map of Chain-O'-Lakes, near Waupaca, Wis., copyrighted by F. M. Benedict in 1896, although not well known, is yet of considerable value and interest to archeologists. It locates the Wisconsin and Wolf River Indian trail, and by numbers indicates village sites, a bake hole, kitchen middens, graves, and conical, ovals and effigy mounds.

The location and description of such remains, however brief, are always valuable. The great number of archeological sites, and the comparative ease with which they could now be located and described, seem to cause local students to ignore the great need of present work in this line. They do not realize that the facilities for the work at the present time are far better than they will be a few years hence, when but a fragment of the same results could be accomplished. Mounds plowed over are

harder to find, and crops ruined by the excavations of the explorer are more expensive than anything injured on wild land. Permission of owners is also harder to secure in more thickly settled regions. In this connection Mr. Benedict's efforts certainly are commendable.

It is very desirable that such a map be constructed by every local student or lover of archeology, until every county in the country is covered. It might be saved for future use either by being published or by filing duplicate copies of it in several libraries or museums. Certainly specimens found by such students deserve a careful record and preservation in the nearest substantial public museum or college.

HARLAN I. SMITH.

#### THE BIOLOGICAL STATION OF THE UNIVERSITY OF MONTANA.

THE Biological Station of the University of Montana will be open for its third season beginning July 22d, for four weeks. The laboratory is near the P. O. of Holt, Montana, at the northern end of Flathead Lake, and from it a great variety of collecting grounds is easily accessible: Flathead Lake is 32 miles long and 16 wide, with an elevation of 4,000 feet; Swan River debouches into the Lake near the station, and numerous other large and small streams, swamps, smaller lakes, forests and mountains with an altitude of ten thousand feet offer a variety of conditions not within reach of many similar institutions.

Courses in zoology, botany, ornithology and nature study will be offered. A small party will leave Missoula early in June and will make explorations in the Cabinet or Mission mountains, reaching the Laboratory at the beginning of the sessions.

The facilities of the station which are placed at the service of students and investigators embrace a gasoline launch, row-boats, botanical apparatus, insect nets, pumping apparatus, etc., and a team and wagon equipped with camping outfit.

The New York Botanical Garden will cooperate in the botanical work of the Station. Dr. D. T. MacDougal, director of the laboratories in that institution will join the party in

the field for the purpose of making collections, and pursuing some investigations upon the relations of climate and vegetation, and will continue both lines of work at the Station; the botanical work during the season will be under his guidance. Attention will be given to general botany, and to the special features of the flora of Montana. Mr. R. S. Williams, of the same institution, will spend the month of June in making collections in the northwestern part of the State, and will be present during a part of the session, giving especial attention to mosses and ferns.

No tuition fees are charged either to students or investigators; microscopes and glassware are supplied free, but the worker is expected to meet the cost of material actually consumed.

Applications and correspondence should be addressed to the Director, Professor Morton J. Elrod, Missouli, Mont., until July 10th; after this date to the Biological Station, Holt, Flat-head Co., Mont.

#### SYNTONIC WIRELESS TELEGRAPHY.

At a meeting of the Society of Arts, on May 15th, Mr. Marconi read a paper on 'Syntonic Wireless Telegraphy.' In the course of his paper, according to the report in the *London Times*, he gave an account of two methods by which he has been able to arrange a selective action in his instruments, so that, for example, two stations can converse with each other without being overheard by an intermediate one. In the first he employed an ordinary vertical radiator placed near an earthed conductor, the effect of the latter being to increase the capacity of the radiating vertical wire without increasing its radiative power; in this way syntonic results were obtained without difficulty. In one form of this arrangement the radiating and resonating conductors consisted of a cylinder, the earthed conductor being placed inside. Using cylinders of zinc only seven meters high and  $1\frac{1}{2}$  meters in diameter, good signals were obtained between St. Catherine's Point and Poole (50 kilometres distance), which were not interfered with or read by other wireless-telegraph installations at work in the immediate vicinity. The closely adjacent plates and large capacity of the receiver caused it to be a

resonator with a very decided period of its own, and, therefore, it was not apt to respond to frequencies differing from its own period, or to be interfered with by stray ether waves, such as were sometimes caused by atmospheric disturbances, and occasionally proved troublesome in the summer. His second syntonic system was the outcome of experiments with the discharge of Leyden jar circuits. Taking for granted that the chief difficulty with the old system lay in the fact that the oscillations were very dead-beat, he tried, by associating with the radiator wire a condenser circuit known to be a persistent oscillator, to set up a series of persistent oscillations in the transmitting vertical wire. In one application of this principle the vertical conductor was connected to earth through the primary of a transformer, the secondary of which was in circuit with the coherer, and, in order to make the tuning between these two circuits more marked, an adjustable condenser was placed across the coherer. To obtain the best results, it was necessary that the free period of electrical oscillations of the vertical wire primary of the transformer should be in electrical resonance with the secondary of the transformer which included the condenser. It was easy to understand that, if there were several receiving stations, each tuned to a different period of electrical vibration, of which the corresponding inductance and capacity at the transmitting station were known, it would not be difficult to transmit to any one of them without danger of the message being picked up by the others for which it was not intended. But, further, it was possible to connect to the same vertical sending wire, through connections of different inductance, several differently tuned transmitters, and to the receiving vertical wire a number of corresponding receivers; then different messages could be sent by each transmitter to the radiating wire simultaneously, and received simultaneously by the vertical wire connected to differently tuned receivers. A further improvement had been obtained by the combination of the two systems described in the paper, the cylinders being connected to the secondary of the transmitting transformer and the receiver to a properly tuned induction coil, with

all the circuits tuned to the same period. The fact that signalling had been successfully carried out over a distance of 50 kilometers with a cylinder only 1.25 meters high and one meter in diameter led to the possibility of constructing portable apparatus for use in the field. He had designed a complete installation on a steam motor-car, on the roof of which was placed a cylinder, only six or seven meters high, that could be lowered while traveling. By means of this, communication had easily been carried on with a syntonized station 50 kilometers distant, a 25-cm. spark induction coil, taking about 100 watts, being used for transmitting. A strip of wire netting dragged behind the car was sufficient for earth connection, or in lieu of any earth connection the electrical capacity of the boiler might be utilized. As to the distance over which signalling had been effected, last spring he established a station at the Lizard and opened communications with St. Catherine's—a distance of over 300 kilometers. The amount of energy used in this case was not more than 150 watts, and the aerial conductor consisted of four parallel vertical wires  $1\frac{1}{2}$  meters apart and 48 meters long, or of a strip of wire netting of the same length. In conclusion, Mr. Marconi gave some examples of the progress made in the practical utilization of his system, and also briefly examined a method proposed by Professor Slaby.

#### WIRELESS TELEGRAPHY IN THE NAVY.

ADMIRAL BRADFORD, chief of the naval bureau of equipment, has given out the following extract from the report of the board which has investigated the question of transmitting messages by wireless telegraphy:

"From the examination of the subject, as outlined in the orders of the department, the board makes the following recommendations:

"1. That the use of homing pigeons be discontinued as soon as wireless telegraphy is introduced into the navy.

"2. That, pending such action, no new pigeon codes be established.

"3. That wireless telegraphy be adopted by the navy for transmission of messages between distant points.

"Referring to the last recommendation, the

board is of the opinion that a high degree of special electrical training is demanded for the successful operation of any system of wireless telegraphy, and it therefore suggests as necessary the establishment of two stations sufficiently far removed from each other for the training of officers and men.

"In its opinion this requirement would be best met by the establishment of such stations at the Navy Yard, Washington, and the Naval Academy, Annapolis. If wireless telegraphy fulfills what now seem to be its possibilities, the cadets should be thoroughly trained in it.

"As the investigation made by this board is not technical, there being no apparatus of any kind ready for test, but general in its character, such partial examinations as outlined above would not change the recommendations already made.

"The selection of any special system of wireless telegraphy is, in the opinion of the board, very largely a matter of business detail.

"If for any reason any competitive test of different systems is thoroughly desirable the board recommends, in view of the fact that the improved Marconi apparatus will not be available for several months, and that improvement in other systems may occur in that interval, that it be made only after due notice and preparation therefor, and by a special board of experts appointed for the purpose."

#### THE AMERICAN ASSOCIATION FOR THE ADVANCEMENT OF SCIENCE.

ARRANGEMENTS for the Denver meeting of the American Association for the Advancement of Science are locally assuming very definite shape. A meeting of the Colorado Science Teachers Association was held in Denver on May 11th and all the members of the American Association residing in Colorado were invited to attend, a special point being made in the call that the meeting would consider the August meeting of the American Association. The cooperation of the Society was pledged to the Local Executive Committee, and the committee itself was organized by the election of Mr. George Lyman Cannon as chairman and Mr. Arthur Williams, secretary of the Chamber of Commerce and Board of Trade, as secretary.

Mr. Jas. F. Callbreath, Jr., editor of the *Mining Reporter*, was appointed chairman of the committee on printing and will at once proceed to publish the Preliminary Announcement, which will be distributed to all members of the Association.

The permanent secretary has as yet been unable to secure definite information regarding the railroad rates. This is the first time the Association has met in the far West and all the passenger associations are holding their decisions contingent upon that of the Western Passenger Association, in whose territory the meeting is to be held. This association is not in the habit of taking definite action on meetings of this character until within 60 days of the meeting, and this has complicated the railroad question. The peculiar character of the Association, in that it is composed so largely of men connected with college faculties, who have a long summer vacation and desire to make their plans well in advance, and, in fact, the majority of whom leave home after commencement and are difficult to reach by mail, has been shown to the railroad people and a speedy decision is hoped for. The permanent secretary thinks it most probable that a rate of not to exceed one fare plus \$2 will be secured for the territory west of Chicago, and surely the passenger associations east of Chicago will make a rate at least as low as one fare and one-third. An effort is still being made to secure a one-fare rate for the entire trip.

#### SCIENTIFIC NOTES AND NEWS.

PROFESSOR WILLIAM JAMES, of Harvard University, began his course of Gifford Lectures at Edinburgh on May 16th.

THE Paris Academy of Sciences has elected Dr. Zeuner, of Dresden, a correspondent in the section of mechanics. The other nominations were: Professor Henry T. Eddy, University of Minnesota and Professor Zabonodsky, of St. Petersburg. In the section of geography and navigation, Dr. Oudemans, of Utrecht, was elected correspondent. The other nominations were: Mr. Wharton, of London, Professor Albrecht, of Potsdam, and Professor Neumayer of Hamburg.

THE following have been elected honorary

members of the American Chemical Society: Professor William Ramsay, University College, London, Sir Henry E. Roscoe, University of London, Professor Emil Fischer, University of Berlin, Professor Adolph Baeyer, University of Munich, and Professor George Lunge, University of Zurich.

SIR WILLIAM MACCORMAC, president of the Royal College of Surgeons, London, has been elected a foreign associate fellow of the College of Physicians of Philadelphia.

MR. WILLIAM WHITWELL has been elected president of the British Iron and Steel Institute in succession to Sir William Roberts-Austen.

MR. W. LANGDON has been nominated for the presidency of the Institution of Electrical Engineers, London.

THE Linnean Society, London, has awarded its gold medal to Lieutenant Colonel Sir George King, the botanist, lately superintendent of the Royal Botanic Garden at Calcutta. He has published important monographs on the flora of India, China and the Malay Peninsula.

THE Bessemer Gold Medal of the British Iron and Steel Institute has been conferred upon Mr. John Edward Stead, F.I.C., in recognition of the value of his investigations of the physical and chemical properties of iron and steel.

DR. G. T. MOORE, of the department of biology at Dartmouth College, has been appointed algologist in the Department of Agriculture.

*Nature* states that news has been received of the safety of Professor W. Baldwin Spencer and Mr. Gillen. They report themselves in good health and already busy taking phonographic and cinematographic records. The Postmaster-General of South Australia has provided them with pocket apparatus for tapping the overland telegraph line when in the vicinity of their route.

THE president of the University of Tokyo, Deiroku Kikuchi, will represent Japan at the bi-centennial celebration of Yale University next October.

KING EDWARD VII. has consented to be patron of the British Medical Association.



A DEPARTMENT of experimental psychology has been established in connection with the Pathological Laboratory of the London County Council Asylums at Claybury. Dr. W. G. Smith, recently of Smith College, Northampton, has been placed in charge.

DR. OTTO LUGGER, State entomologist of Minnesota, died of pneumonia on May 21st. Dr. Lugger was an entomologist of wide reputation. He was assistant to the late Professor C. V. Riley at the time when the latter was publishing his well-known 'Reports on the Insects of Missouri.' Subsequently he became curator of the Maryland Academy of Sciences and, still later, an assistant in the Division of Entomology, U. S. Department of Agriculture, from which place he went to Minnesota as State entomologist in 1887. The latter office he has held for nearly 14 years with great success. His reports have been models of their kind and his investigations along certain lines have been of great value to agriculture.

DR. WILLIAM D. THOMAS, professor of psychology in Richmond College, Va., died on May 22d.

THE death is announced of Dr. E. Breten-schneider at St. Petersburg. He was for many years physician to the Russian Legation at Pekin, and made important researches on Chinese archeology, geology, etc. His books include two on Chinese botanical work.

THE death is also announced of Dr. Peter Helmling, formerly professor of mathematics at the University of Dorpat, at the age of eighty-four years, and of Dr. George Asp, professor of anatomy at Helsingfors.

The officers of Section C, Chemistry, of the American Association have issued the following preliminary announcement:

The 50th annual meeting of the American Association for the Advancement of Science will be held in Denver, Colorado, August 24-31, 1901. The meetings of Section C will be held as heretofore in connection with the meetings of the American Chemical Society. The officers of the Section ask the cooperation of all the members in making the meeting a successful one. To this end you are personally requested to present one or more papers. Will you kindly fill out and return the enclosed blank giving us informa-

tion as to whether you expect to attend the meeting; also the titles of any papers which you will present. According to the constitution, such abstracts of the contents of the papers as will give a general idea of their nature must be sent to the Secretary of the Section as early as possible. If you cannot present the abstract at this date, kindly send the title of the paper and furnish the abstract later. It is hoped to have reviews of the recent progress made in the various fields of chemistry. The presentation of such reviews by any of the members will be greatly appreciated. The officers of the Section will also appreciate any suggestions in reference to the program.

WILLIAM MCPHERSON,  
*Secretary of Section C.*

OHIO STATE UNIVERSITY,  
COLUMBUS, O.

THE American Microscopical Society will meet at Denver, in conjunction with the American Association for the Advancement of Science, on August 20, 30 and 31. The Secretary, Professor Henry B. Ward, of the University of Nebraska, promises that the meeting will be the best and most enjoyable yet held.

THE Council and Board of Directors of the American Chemical Society have authorized the expenditure of \$500 for the publication in a separate volume of the proceedings of the twenty-fifth anniversary meeting of the Society, held last month.

IN addition to the civil service examinations that we have already announced for June 3d, there will be two others: that of secretary of the National Bureau of Standards, with a salary of \$2,000, and that of field assistant in tree-planting in the Division of Forestry, with a salary of \$1,000. On June 15th examinations will be held as follows: assistant ethnologist in the Bureau of Ethnology, at a salary of \$1,200; zoological clerk in the Bureau of Animal Industry, at a salary of \$840; a botanical clerk and assistant in the Department of Agriculture, at a salary of \$1,000, and a special statistical compiler, Department of Agriculture, at a salary of \$720. Those desiring further information concerning these positions should apply to the Civil Service Commission, Washington, D. C.

Two buildings for the Pacific Botanical Station, which is being established by the botanists

of the University of Minnesota, are in process of erection at a cost of about \$2,500. The British Columbian Parliament has passed a grant for the construction of a road between the Port Renfrew dock and the Station site on the Straits of Juan de Fuca. A party of thirty or forty western botanists will leave Minneapolis under the direction of Professor Conway MacMillan and will spend the latter part of June and the first two or three weeks in July in the study of marine vegetation at the new seaside station, and of mountain vegetation at Banff, Alberta, and Field and Glacier, British Columbia. A subordinate party proposes to explore some of the little-known mountains of northern Vancouver.

WE learn from the *Botanical Gazette* that the valuable herbarium of the late Professor Agardh has been secured by the University of Lund.

MR. L. COCKAYNE, of Tarata, New Zealand, has recently presented to the New York Botanical Garden a large number of seeds of plants indigenous to the island, and has also donated nearly a hundred fine photographs, showing distinctive features of the vegetation of that island and also of Chattham Island, which he has explored within the last year.

THE collection of Indian relics and prehistoric anthropological specimens collected by Andrew E. Douglass has been presented to the American Museum of Natural History, New York. It contains about 23,000 specimens which were selected with great care.

THE collection of butterflies of the American Museum was opened to the public on May 24th. There are about 5,000 specimens, including the valuable collection given some time since to the Museum by the Rev. E. A. Hoffman.

THE library and collections of the late Dr. Jared P. Kirtland have been placed in the custody of Adelbert College by his granddaughter, Mrs. Caroline P. Cutter. Dr. Kirtland was a pioneer naturalist of the Western Reserve, the founder of the Kirtland Academy of Natural Science, and a man of wide attainments. His library contains about 2,200 volumes and embraces a wide field, including zoology, botany, geology, horticulture, travel, exploration, biography and local history. It is particularly rich

in general and descriptive zoology of the mollusks, insects and fishes.

MR. SCHUYLER S. WHEELER presented to the Institute of Electrical Engineers, New York City, at its meeting on May 21st, the extensive and valuable library of electrical works collected by the late Latimer Clark, of London.

AT the monthly meeting of the Royal Meteorological Society on May 15th, Mr. W. Marriott gave an account of the bequest by the late Mr. G. J. Symons to the Society. By his will Mr. Symons bequeathed to the Society his Cross of the Legion of Honour, the Gold Albert medal awarded to him by the Society of Arts, the testimonial album presented to him in 1879 by the Fellows of the Royal Meteorological Society, and the sum of £200, as well as such of his books, pamphlets, maps and photographs of which there was no copy in the Society's library. Mr. Marriott stated that from Mr. Symons's valuable collection he had selected for the society over 5,000 books and pamphlets and about 900 photographs. A large number of the books were old and rare works, 750 bearing dates previous to 1800, while eight were as early as the 15th century. By this bequest the Royal Meteorological Society is said now to possess the most complete meteorological library in existence.

MR. CARNEGIE has given £100,000 for branch libraries for the city of Glasgow.

THE current issue of *Nature* contains the following further information and comments concerning the resignation of Professor J. W. Gregory from the leadership of the scientific staff of the antarctic expedition:

The great majority of scientific men in the country were confident that Professor Gregory possessed unique qualifications for the post of scientific leader of an expedition in which many branches of science required study and coordination. Under his direction, and with a competent naval head who should have an absolute veto upon all operations which involved risk to ship and crew, great scientific results were assured.

The opposition of the representatives of the Royal Geographical Society, which had obtained most of the funds voluntarily subscribed, and of a few scientific men belonging to the Navy, rendered it impossible that these full powers could be granted; but a compromise acceptable to Professor Gregory was passed

by a large majority (16 to 6) of the Joint Antarctic Committee, including the officers of both societies and almost every expert on their joint lists.

The compromise provided, in the words submitted on February 12th to the joint committee, 'that a landing party, if possible, be placed on shore, under the charge of the director of the civilian scientific staff.' Professor Gregory was informed of this, accepted it, and the next day sailed for Melbourne.

The Royal Geographical Society's council refused to accept the compromise, and deputed three of their number to suggest to the officers of the Royal Society that the matter should be settled by a new committee of six, three to be appointed by each council. The Royal Society consented; the committee, chiefly composed of non-experts, met, and proposed modifications which Professor Gregory has been unable to accept.

We shall await with some interest to see whether the majority of Fellows of the Royal Society, and of other scientific men in this country, will approve the manner in which the Royal Society has acted as the guardian of scientific interests.

A CALL has been issued for the formation of an international botanical association, the first meeting of which will be held at Geneva on August 7th. One object of the association is the establishment of a bibliographic periodical, giving abstracts in English, German and French. An option for the purchase of the *Botanisches Centralblatt* has been secured. The Americans signing the call are Professor W. G. Farlow and Dr. David D. Fairchild, and the secretary is Dr. J. P. Lohse, Wageningen, Holland.

THE eighty-fourth annual meeting of the Swiss Scientific Society will be held at Zofingen on the 4th, 5th and 6th of August. In conjunction with it, meetings are held of the Geological, Zoological, and Botanical Societies of Switzerland.

THE German Association for the Promotion of the Teaching of Mathematics and the Natural Sciences held its general meeting at Giessen from May 27th to 30th. The program included lectures on the teaching of physics and of geometry and on the use of text-books in the biological sciences.

THE second session of the New York State Entomological Field Station will be held at Ithaca during the summer months. Professor J. G. Needham, of Lake Forest University, will continue in charge of the work. The re-

port of the first session, held at Saranac Inn last summer, is expected to be issued shortly.

THE Peary Arctic Club has chartered for this summer the steamer *Erik*, lately purchased from the Hudson Bay Company by Captain James A. Farquhar, of Halifax. It will sail from Sydney, C. B., about the middle of July, and will return, it is expected, about two months later, with full details of what has occurred during the two years since Mr. Peary has been heard from; also with information of the voyage of the *Windward*, in which Mrs. Peary and Miss Peary sailed from Sydney last year for the North.

It is reported in the English papers that an American citizen has presented to the Pope a large telescope for the observatory in the Vatican. This observatory, under Father Denza, has carried on active researches since its reorganization in 1888.

A CABLEGRAM to the daily papers from Berlin states that during the past month experiments have been made between Berlin and Hamburg with the system of rapid telegraphy invented by the late Professor H. A. Rowland, of Baltimore, and it is said that the results are most satisfactory—the new system easily doing double the work done by the Baudot apparatus—and that the German Postal Department intends to introduce the Rowland system between Berlin, Hamburg, Cologne, Leipsic, and Frankfort. The system makes possible the transmission of eight messages simultaneously over a single wire, four in each direction, at the rate of forty words a minute.

WE learn from *Nature* that this year's Deutscher Geographentag opened at Breslau on Monday, May 27th. On the morning of May 28th Professor Neumayer proposed to present the report of a committee upon Antarctic exploration and to speak upon magnetic investigations in polar regions; Dr. E. Philippi on the 'Geological Problems of the German Antarctic Expedition,' and Professor A. Supan on the 'Antarctic Climate.' At the second sitting the subject to be discussed was the organization of geographical instruction, the speakers being Professor H. Wagner, Dr. Auler and Herr H. Fischer. On Wednesday morning, May 29th,

the subjects brought before the meeting related to the scientific study of lands and native races of German colonies. The speakers include Professor F. v. Richthofen, Professor G. Volkens, Dr. E. Kohlschütter, Professor K. Dove and Professor Schenck. The methods of geographical instruction were discussed in the afternoon of the same day by Mr. A. Becker, Professor A. Fischer, Professor A. Kirchhoff, Professor Langenbeck and Professor A. Bludau; demonstrations will also be planned by Professor K. Dove and Dr. M. Ebeling. In the evening an illustrated lecture was announced on glacier markings in Montenegro, by Professor K. Hassert, and one on the volcanoes of central France, by Dr. M. Friederichsen. At the fifth sitting, on May 30th, the papers dealt with various aspects of glaciers and glaciation, and the speakers included Professors Finsterwalder, H. Meyer, S. Günther, A. Penck, W. Goetz and Dr. W. Halbfass. On the afternoon of the same day, reports and papers were received from Professor A. Kirchhoff and C. M. Kan, and Dr. K. Sapper; and the general business of the association was transacted. Excursions have been arranged for a few days at the end of the meeting, and exhibits of geographical interest are on view in two museums in Breslau.

#### UNIVERSITY AND EDUCATIONAL NEWS.

THE Wisconsin Legislature has appropriated for the University of Wisconsin, at Madison, \$210,000, in addition to the regular income previously derived from the State. Of this sum \$150,000 is for a new building for the College of Agriculture, which is to house the administration offices of this department and the experiment station as well as the departments of bacteriology and chemistry. This College also receives \$10,000 annual increase to its present income. The College of Engineering receives \$30,000 for equipment of its new building which was provided by the last Legislature; also \$7,500 annual increase in income. The newly organized School of Commerce secures \$3,500 annual increase in its appropriations.

MR. EDWARD TUCK has given Dartmouth

College \$100,000 for a building for the Amos Tuck School of Administration and Finance. The College has also received a bequest of \$10,000 from Mrs. Susan A. Brown as a library fund for the Department of Philosophy.

THE trustees of the John Carter Brown Library, acting under the provisions of the will of the late Mr. John Nicholas Brown, have decided to present the library with its \$650,000 endowment to Brown University. This is the finest collection of Americana in existence. In addition to the books, whose value it is difficult to estimate, there will come to the university \$150,000 for a library building and \$500,000 of permanent endowment.

MR. ANDREW CARNEGIE has, as our readers doubtless know, offered to give £2,000,000 to the four Scottish Universities, Edinburgh, Glasgow, Aberdeen and St. Andrews, for the free education of Scottish students. He estimates that this income will pay the fees of all the students in the universities, including, we understand, the professional schools.

THE Council of Columbia University has resolved that all candidates for degrees at commencement shall be presented in English and that all degrees shall be conferred in English. Hitherto Latin has been used in part.

PROFESSOR R. W. WOOD, of the University of Wisconsin, has been appointed professor of physics in the Johns Hopkins University.

PROFESSOR H. B. LATHROP, who holds the chair of rhetoric at Stanford University, has resigned and has accepted the position of assistant professor of English in the University of Wisconsin.

ALBERT PRESCOTT MATHEWS, PH.D. (Columbia), has been elected assistant professor of physiological chemistry in the University of Chicago, and will be head of the department.

DR. O. M. STEWART, instructor in physics in Cornell University, has been appointed assistant professor of physics in the University of Missouri.

DR. E. SCHELLWEIN has been promoted to an assistant professorship of geology and paleontology at the University at Königsberg.

# SCIENCE

A WEEKLY JOURNAL DEVOTED TO THE ADVANCEMENT OF SCIENCE, PUBLISHING THE OFFICIAL NOTICES AND PROCEEDINGS OF THE AMERICAN ASSOCIATION FOR THE ADVANCEMENT OF SCIENCE.

EDITORIAL COMMITTEE: S. NEWCOMB, Mathematics; R. S. WOODWARD, Mechanics; E. C. PICKERING, Astronomy; T. C. MENDENHALL, Physics; R. H. THURSTON, Engineering; IRA REMSEN, Chemistry; JOSEPH LE CONTE, Geology; W. M. DAVIS, Physiography; HENRY F. OSBORN, Paleontology; W. K. BROOKS, C. HART MERRIAM, Zoology; S. H. SCUDDER, Entomology; C. E. BESSEY, N. L. BRITTON, Botany; G. S. MINOT, Embryology, Histology; H. P. BOWDITCH, Physiology; J. S. BILLINGS, Hygiene; WILLIAM H. WELCH, Pathology; J. MCKEEN CATTELL, Psychology; J. W. POWELL, Anthropology.

FRIDAY, JUNE 7, 1901.

FRANÇOIS MARIE RAOULT.

## CONTENTS:

<i>François Marie Raoult</i> : PROFESSOR H. C. JONES.....	881
<i>Charles Hermité</i> : JUAN J. DURÁN-LORIGA.....	883
<i>The Extra-Nuptial Nectaries in the Common Brake, Pteridium aquilinum</i> : PROFESSOR FRANCIS E. LLOYD.....	885
<i>The British National Antarctic Expedition</i> : PROFESSOR EDWARD B. POULTON.....	890
<i>First Report of the Limnological Commission of the American Microscopical Society</i> : PROFESSOR A. E. BIRCE, PROFESSOR C. H. EIGENMANN, PROFESSOR C. A. KOFOID, DR. G. C. WHIPPLE, PROFESSOR H. B. WARD.....	897
<i>North Carolina Section of the American Chemical Society</i> : DR. C. B. WILLIAMS.....	899
<i>The American Association for the Advancement of Science</i> .....	902
<i>Scientific Books</i> —	
<i>Ward on the Mesozoic Flora of the United States</i> : PROFESSOR D. P. PENHALLOW. <i>Kent's Steam-boiler Economy</i> : PROFESSOR R. H. THURSTON. <i>Dodge's Reader in Physical Geography</i> : DR. J. PAUL GOODE. <i>Air, Water and Food</i> : PROFESSOR WILLIAM P. MASON. <i>Books Received</i> .....	904
<i>Scientific Journals and Articles</i> .....	908
<i>Societies and Academies</i> —	
<i>Biological Society of Washington</i> : F. A. LUCAS. <i>Chemical Society of Washington</i> : DR. L. S. MUNSON. <i>Torrey Botanical Club</i> : PROFESSOR E. S. BURGESS. <i>The Onondaga Academy of Sciences</i> : DR. PHILIP F. SCHNEIDER.....	909
<i>Discussion and Correspondence</i> —	
<i>The Larynx as an Instrument of Music</i> : PROFESSOR E. W. SCRIPTURE. <i>Physiology in the Schools</i> : PROFESSOR THEODORE HOUGH.....	913
<i>Shorter Articles</i> —	
<i>The General Equations of Rotation of a Rigid Body</i> : PROFESSOR C. BAERUS. <i>On a Crinoidal Horizon in the Upper Carboniferous</i> : DR. CHARLES R. KEYES. <i>The Process of Freezing in Plants</i> : JAMES E. DANDENO.....	914
<i>The American Mathematical Society</i> .....	917
<i>Scientific Notes and News</i> .....	917
<i>University and Educational News</i> .....	920

MSS. intended for publication and books, etc., intended for review should be sent to the responsible editor, Professor J. McKeen Cattell, Garrison-on-Hudson, N. Y.

THE death of Raoult, on April 1, 1901, removes from France one of her most brilliant investigators. Raoult was born at Fournes (Nord) on May 10, 1830, and was, therefore, nearly seventy-one years old when he died. After finishing his academic training in Paris, he began his career as a teacher in the Lycée at Reims at the age of twenty-three. In 1870 he was called to the chair of chemistry at Grenoble. In 1889 he was elected dean of the Faculty of Sciences in Grenoble—a position which he held until his death.

The earlier work of Raoult was devoted to problems of a purely physical nature. His thesis, presented for the degree of Doctor of Science was on 'The Electromotive Force of Voltaic Cells,' and much of his earlier work had to do with the phenomena connected with electrolysis.

His most important work, however, and that with which his name will always be connected, was done after 1870, while at Grenoble. When Raoult took up the study of the lowering of the freezing-point and of the vapor-tension of solvents by dissolved substances, our knowledge of these phenomena was hardly more than qualitative. A few regularities had been pointed out by Blagden, Coppey, Wüllner, Emden, Rüdorff and others, but scarcely any generalization worthy of the name had been reached.

The reason why the laws which obtain in these fields had not been discovered is to be found chiefly in the fact that aqueous solutions had been used, and we know to day that water dissociates electrolytes, and in varying amounts depending upon the dilution of the solution. Thus, of all the solvents which could have been used in studying these phenomena, no one was so poorly adapted to the discovery of any relations which might exist as water.

When Raoult took up the study of the lowering of the freezing-point of water by dissolved substances, he did not limit himself to aqueous solutions, but employed solutions in acetic acid, benzene, nitro-benzene, etc. From his work with non-aqueous solutions he discovered his well-known law: "A molecule of any substance dissolved in one hundred molecules of a liquid lowers the freezing-point of the latter a nearly constant amount." The experimental data upon which this law is based were published in 1884.\*

A little later (1886) Raoult took up the study of the lowering of the vapor-tension of solvents by dissolved substances. Here also he worked with non-aqueous solutions, and showed that the lowering of the vapor-tension is proportional to the ratio between the number of molecules of the dissolved substance and the total number of molecules present.

The work of Raoult, then, brought out this important point, that the lowering of the freezing-point of a solvent, as well as the lowering of its vapor-tension, depends only upon the ratio between the number of parts of the dissolved substance and the number of parts of the solvent which are present.

This work of Raoult, however, led to a still more important discovery. He found that electrolytes, *i. e.*, those substances which in solution conduct the current, give greater

lowering of the freezing-point of water than non-electrolytes. An example will make this clear. Hydrochloric acid, sodium hydroxide and sodium chloride in water lower its freezing-point nearly twice as much as methyl alcohol of the same concentration. We recognize in the acid, base and salt types of electrolytes, and in methyl alcohol a typical non-electrolyte. Raoult was not able to point out the meaning of this important discovery. This was left for another.

The work of Pfeffer on the osmotic pressure of solutions led, in the hands of van't Hoff, to the discovery of the relations between the osmotic pressure of solutions and the gas-pressure of gases. But these relations hold only for the osmotic pressures of non-electrolytes. The electrolytes all exert an osmotic pressure which is greater than that shown by the non-electrolytes. van't Hoff was not able to explain the abnormally large osmotic pressures exerted by the electrolytes.

The Swedish physicist, Arrhenius, took up this question, and, as we know, furnished a satisfactory answer to it. He asked, Why is it that electrolytes give abnormally large osmotic pressures, abnormally large depressions of the freezing-point and vapor-tension of solvents? The work of Raoult had shown that lowering of freezing-point and of vapor-tension depends only upon the number of parts present in a given volume of the solution. Therefore, when these phenomena manifest themselves to an abnormally large degree it means that we have more parts present in the solution than we suppose. This gave to Arrhenius the key to the solution of the problem, and the theory of electrolytic dissociation was the result.

This work of Raoult, together with that of Pfeffer on osmotic pressure, forms the foundation of the new physical chemistry.

An account of the work of Raoult should

\* *Ann. Chim. phys.* [6] 2, 66. Harper's Science Series, IV.

be supplemented by a brief reference, at least, to his more important characteristics. He was not a man who desired fame, but devoted his whole life to one ideal—the discovery of truth. Although connected with a comparatively small institution, he never lost his enthusiasm for his work, and one of his very last investigations, on the lowering of the freezing-point of water produced by non-electrolytes, probably contains the most accurate measurements of these values which have ever been made.

Raoult as a man seems to have combined most of those qualities which are so much admired. We have abundant evidence of his kind-heartedness and genial disposition. A letter from his pen was always an inspiration to more strenuous effort in research, and invariably left the impression that the highest aim of man should ever be to increase the sum of human knowledge.

In Raoult not only France has lost her most prominent physical chemist, but the world has lost one of the leading men of science.

HARRY C. JONES.

CHARLES HERMITE.

THE fourteenth of January, 1901, should be marked with a black stone in the annals of mathematics. Then the eminent geometer, the incomparable man, the great Hermite, one of the glories most pure of France, was lost to science, and implacable death threw into mourning his family, his friends and his admirers.

As mathematician of the first rank he leaves to the glory of his country and of all humanity a superb scientific monument erected in sixty years, completely dedicated to 'his dear *analyse*' (to use one of his phrases) and to preparing, by the infusion of his genius placed at the service of teaching, that galaxy of illustrious mathematicians who now so much adorn our sister nation. Like Sturm, he united in an

extraordinary degree the qualities of a professor who wins the love of his disciples to those of one who inculcates the love of science for science.

Endowed, like his compatriots Pascal and Clairaut, with singular precocity, we see him, yet a scholar of the lyceum Louis le Grand, win the prize for mathematics with a noteworthy thesis, and shortly after, as student of the Polytechnic School, attract the attention of Jacobi with his first works and place himself as of right in the first rank among the analysts of Europe.

It is not our object to make a minute analysis of the works of the great geometer, to which would be necessary time and competence that we lack. Our aim is much more modest; we seek to render what is heartfelt homage to the man we have so deeply venerated and from whom we have received infinite proofs of benevolence during the fifteen or sixteen years that we have had the honor to possess his friendship, in so many ways precious.

It is not possible, speaking of Charles Hermite, to fail to say how in the higher analysis, in algebra and in the theory of numbers, one encounters everywhere the footprints of his giant tread. How could we leave unmentioned his memoir on the exponential function, where in demonstrating the transcendence of the number  $e$  he opens the way which eleven years after conducted Lindemann to the demonstration of the analogous property of  $\pi$ , solving in negative form the celebrated problem which for two thousand years had in vain fatigued geometers?

Nor can we pass in silence the enormous contribution which Hermite brought to the *Theory of Forms*: his law of reciprocity, his admirable researches on associate covariants, his work on quintic forms, his memoir on the equation of the fifth degree and his celebrated theorem having Sturm's as corollary.

The works of Charles Hermite in the theory of functions are a new revelation of his genius. His profound investigations on Abelian functions, their division and their transformation, as also those relative to elliptic functions, form a monument of glory erected to French science, disclosing the sagacity of the grand analyst in the facility with which are deduced from the most lofty analytic investigations, corollaries which unveil difficult properties of the theory of numbers.

Neither can we neglect to mention the work, 'Sur quelques applications des fonctions elliptiques' (1885), of which only the first part was published: in this are found the beautiful applications of these functions which conduct him to the general integral of the equation of Lamé on the equilibrium of temperature of a homogeneous ellipsoid, which leads the author, in two particular cases, to the study of the rotation of a solid body around a fixed point (when there do not exist accelerating forces) treated by Jacobi, and to the consideration of the conic pendulum.

So far as we know, Hermite leaves two didactic works: his 'Cours de la faculté des sciences de Paris' (1891), and his 'Note sur la théorie des fonctions elliptiques' (168 pages), which serves as appendix to the 'Cours de calcul différentiel et intégral,' of J. A. Serret (4th ed., 1894).

We have from him also two brief but interesting notes on the invariants of binary forms of the 5th and 6th order in the French translation of Salmon's 'Higher Algebra.'

The French geometer had the good fortune not granted all great men to see recognized in his lifetime by the scientific world his extraordinary merit. The 24th of December, 1892, his sixtieth birthday, the friends, the disciples, the admirers of the great geometer assembled at the Sorbonne to present him the gold medal struck in his honor by international subscription. The

illustrious artist Chaplain cut upon it the bust of the one commemorated, and translated on to metal with admirable fidelity his venerable face, affable and frank, illuminated by the scintilla of genius.

The Minister of Public Instruction, M. Ch. Dupuy, presented to Hermite in the name of the President of the Republic the insignia of Grand Officer of the Legion of Honor, and the messages were read of those who from various parts of the world associated themselves with the splendid ceremony.

High testimony of admiration and sympathy was offered the great geometer more recently upon the occasion of the meeting at Paris, last August, of the International Congress of Mathematicians.

The Congress sent him a telegram of admiration and sympathy (he was at Saint-Jean-de-Luz). This act caused vast satisfaction and profound emotion to the scientist, as he wrote me in one of his last letters.

Hermite retained to the last day of his life his privileged intelligence; but his body suffered. In a long letter of his, a few days before his death, he complained of his attacks of asthma and of the lack of appetite and of sleep: he seemed to foresee the nearness of his end, so that sending me one of his works, he said that this would be without doubt *the last!* and that he had in great part accomplished it at Saint-Jean-de-Luz, where by benefit of the mild climate had reawakened his mathematical activity. This last work is a letter to Professor Pincherle published in Tomo V. of the *Annali di Matematica*.

He told us also that he had sent a brief article to the new journal, *Le Matematiche*, of Professor Alasia.

We will end by expressing a wish. We wish that those who have the authority would take the initiative toward an international subscription for a work containing an extended biography of the ever-memo-



rable geometer, and a minute analysis of his works; perhaps might be added some brief articles by very illustrious living mathematicians; something, in fine, which would be as a funeral crown offered to the memory of the great dead.

[Written by Juan J. Durán-Loriga for *Le Matematiche*, and translated by the English editor G. B. Halsted.]

THE EXTRA-NUPTIAL NECTARIES IN THE  
COMMON BRAKE, *PTERIDIUM*  
*AQUILINUM*.

THE common brake, *Pteridium aquilinum* Kuhn (*Pteris aquilina* L.) has for a number of years been used in educational institutions in this country as a laboratory type, more especially in connection with introductory courses in general biology in which both animal and plant types are used. That the presence of nectar-secreting organs in this form, therefore, should have been so generally overlooked as the writer has been led to believe, the more especially as they were made known to the botanical world as early as 1877,\* is a matter of some surprise.

It is our purpose by means of the present paper to review the facts already published, and to present them, together with the writer's own observations, in order to draw to the attention of teachers of biology the fact of the presence, in a non-flowering plant, of an organ such as is thought of usually in connection with the phanerogams alone. Interest attaches to this structure, also, from the fact that a definite organ of secretion may be observed by students in a much-used laboratory type, thereby enhancing its value as such.

The extra-nuptial nectaries in *Pteridium aquilinum* were discovered by Francis Darwin (*l. c.*), and their microscopic appearance was briefly described by him in

\* Darwin, Francis. *Jour. Linn. Soc.* 15: 407. 1877.

1877. The possible biological meaning of these organs was also discussed.

Two years later, Bonnier\* pointed out the presence of similar structures in certain genera of ferns, namely, in *Cyathea*, in *Hemitelia* and in *Angiopteris*, and briefly described some points in their anatomy. In addition, this author examined the nectar of the plant here under discussion.

In 1891, in view of the scanty description till then extant, W. Figdor† published a fuller account of the nectaries in *Pteridium*. This description includes the external appearance and the histology of the gland, and is accompanied by two illustrations. Later in the same year Figdor's paper was reprinted, accompanied by some notes and one illustration‡ additional, by H. Potonié.§

EXTERNAL APPEARANCE.

The nectaries in *Pteridium aquilinum* occur on the fronds at the bases of the pinnæ and pinnule on the morphological lower side of the leaf. The largest and most conspicuous are the lowermost, that is, those at the bases of the first pair of pinnæ. On one developing frond, therefore, one may observe a complete developmental series. When examined macroscopically the glands appear as approximately oval areas just below and extending somewhat into the angles formed by the mid-veins of the first and second, and second and third, orders. The external surfaces of the glands are smooth, because of the absence of the chaffy scales found elsewhere on the young frond.

\* Bonnier, G. 'Les nectaires.' *Aun. Sci. Nat. Bot.* VI. 3: 5-212. 1878.

† Figdor, W. 'Ueber die extranuptialen Nectarien von *Pteridium aquilinum*.' *Oesterr. botan. Zeitschr.* No. 9. 1891.

‡ Reproduced in Engler and Prantl's 'Natürlichen Pflanzenfamilien,' 1: 67.

§ Potonié, H. 'Die 'extranuptialen' Nectarien beim Adlerfarn.' *Natur-Wiss. Wochenschr.* 6: 401. 4 O. 1891.

Their color, according to Figdor, is brown-red in the central part of the nectarial surface, developing into red on the edges. Darwin's statement is that they are 'smooth green.' In our east North American plants, the color in the young state is much as described by Figdor. Later the red color is lost, and the organs are then deep green. Darwin's and Figdor's statements may, therefore, be harmonized as they appear to apply to different stages of growth, if indeed the European plants do not differ among themselves and from the American. Figdor further notes that the membranes of the nectaries early become brown and that, later, they thicken considerably. The use of the red color is quite problematical.

The secretion of nectar is very abundant during the unfolding of the frond. So abundant is it, in fact, that large beads of the limpid fluid may be seen from a distance, resting on the nectaries or running down the petiole. With a hand lens, one may easily note the accumulation of nectar after the surface has been wiped off. Darwin found that a drop of the liquid was formed in six minutes. Handling and tasting the secretion shows it to be sirupy and very sweet. According to Bonnier (*l. c.*) the sugars saccharose and glucose are present. Here, as in analogous organs in other plants, the exudation is quite independent of bleeding pressure. Leaves which have been broken off continue to produce nectar for some days, provided, of course, that they be kept in fair condition. As the frond ages, the activity of the glands is lowered, until they finally cease to secrete and become functionless as nectaries.

#### ANATOMY.

The epidermis consists of polygonal cells, with a depth that is greater by about one-third than that of the rest of the epidermal

cells of the petiole; in transverse section they are nearly square (Fig. 5). These cells have red coloring matter in their sap, although the color is not confined merely to the glandular areas, but is usually extended from them in bands of various breadths up and down the petiole. The loss of this color as the age of the leaf increases has been noted above.

Scattered here and there on the surface are a number—a dozen or more—of stomata. These are irregular in position, in surface view very much rounded (Fig. 1a), resembling in this respect very closely the water pores of the garden nasturtium (*Tropaeolum* sp.).



FIG. 1a. Stoma from nectary.

FIG. 1b. Stoma in which the guard cells have been spread apart by growth of the surrounding tissues.

They do not, however, lack so entirely the characters found in air stomata, as is shown in the figure. The delicate hinge mechanism is not present, and the thickening of the walls is even all around, in which the stomata agree in essential detail with water stomata, such as are found in *Secale cereale*, *Conocephalus ovatus* and other plants.

In some cases the stretching of the epidermis incident to growth causes a displacement of the guard-cells (Fig. 1b), and a consequent enlargement of the pore. The guard-cells are raised above the general surface (Fig. 2), in which particular the writer's observations fail to coincide with those of Figdor, whose illustration in other regards also does not show the guard-cells to possess any characters usually found in such. Figdor states that a 'test with a sugar solution indicated that some of the

stomata carry on the usual function while others serve for the exudation of nectar.'

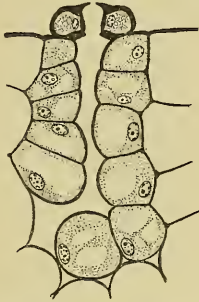

FIG. 2. Transverse section through a stoma and adjacent tissue of the nectary.

It is, however, not clear how the test was applied, and we believe that in view of the facts the question of the function of the stomata may be decided upon other grounds. A very few of these which occur on the edge of the nectarial surface have the appearance of air stomata, but by all odds the big majority have the characters above described, from which it appears that the guard-cells are in such cases quite functionless in opening or closing the entrance. Furthermore, the nectar when it is being secreted is so abundant that it must needs hinder completely the gas interchange at that time. That such interchange takes place later is almost certainly the case, as is indicated by the condition of the chlorophyll-bearing cells of the gland. Nor does the immobility of the guard-cells call for remark, inasmuch as the amount of tissue involved in transpiration coincident with respiration is relatively so very small as to have no effect upon the turgor of the whole leaf. Stomata are absent from the rest of the petiolar surface, excepting that, as Potonié\* has pointed out, they are present along two

bands on either side of the morphological upper flattened side of the leaf-stalk, beneath which the hypodermal stereome is absent, though elsewhere present except in the nectaries. The relation of these bands to the glands should here be pointed out. As just stated, the rachis possesses two such bands, which pass *without dividing*, each along the lower margin of one of the first pair of pinnae. The band lying along the upper margin of a pinna and that along the side of the rachis nearer the same and above its insertion arise at *the same point*. At this point lies the nectary. These relations, which are exhibited in Fig. 3, *a* and *b*, are repeated at each fork in the frond.

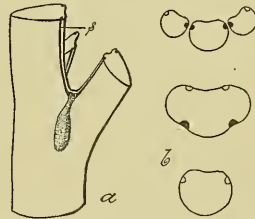

FIG. 3. *a*, lateral view of rachis showing the nectary and the stomatal bands, *s*; *b*, diagrams showing the distribution of the bands.

Through these true pneumathodes, by reason of the anatomical relations just indicated, the gas interchange may easily take place between the glandular tissue and the air. On old dead fronds the nectarial stomata are so large as to be seen with the naked eye, from which fact the presence and extent of the gland beneath may be determined.

Beneath the epidermis lies the glandular tissue extending to a depth of 1 mm. or a fraction more. In a transverse section through fresh material, the extent of the same may be recognized by the deeper green color contrasting with the lighter color of the surrounding tissues. The cells are rounded in form, as described for

\* Potonié H. Jahrb. des Königl. bot. Gartens zu Berlin, 1 : 310-317. 1881.

*Hemitelia* by Bonnier (*l. c.*), and contain relatively much more protoplasm than the contiguous cells, large nuclei and chloroplasts. The cytoplasm is vacuolated and the cell walls are thin. The cells stand in contrast with the ground parenchyma on account of their smaller size, their diameters being between the ratio of 1 to 3 and 1 to 4. The cells near the epidermis are larger than those lying deeper in the gland. In making the foregoing statement, we differ from Figdor, who says "The single elements of the gland are about the size of the cells of the fundamental parenchyma." Frequent small intercellular spaces occur. These connect with each other and finally with the substomatic spaces which are of considerable size (Fig. 2). Through these, therefore, the secretion may find its way to the surface of the gland. Bonnier, in the paper above cited, makes no mention of the substomatic spaces in the special treatment of the ferns. Further on, however (p. 151), he makes a general statement to the effect that he had established the fact that, in the cases of nectaries with stomata, these are either without a substomatic space or have only very small ones. His figure representing the nectary of *Hemitelia obtusa* (on his Pl. 1, Fig. 9) certainly bears out his general statement. We cannot, however, regard this figure as satisfactory. No attempt was made to delineate the stomata, except in very schematic fashion, on account of the small size of the drawing, for which reason also the possibility of representing substomatic and intercellular spaces was very much lessened. The presence of a large substomatic space, however, may not be regarded as of any importance in the economy of such an organ as a nectary, in which the movement of the fluid is the important and characteristic feature.

Passing on to consider the relation of the nectary to the vascular tissue, we notice in the first place the distribution of bundles in

the immediate vicinity of the former. Fig. 4 shows, in diagrammatic form, this relation, from which there appears to be little variation to be noted beyond. A broad

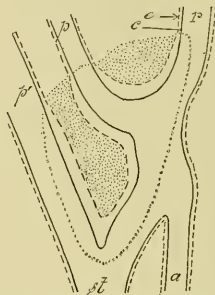

FIG. 4. Diagram showing the relations of the vascular tissue and gland. The dotted outline shows the extent of the latter. *c*, limit of the cribral part of the bundle; *e*, endodermis. The pericycle is included between these.

stele\* (*st*) divides at the lower angle of the nectary, one branch (*p'*) running along one side of the gland and thence into the pinna, the other and larger passing along the other border of the gland, broadening as it goes into a vascular plate which consists of a dense complex of short, irregular wood elements, well-developed cribral cells and a several-layered pericycle, to be described below.

From this plate of vascular tissue, which lies beneath and somewhat obliquely across the nectary, pass forward two branches, *p* and *r*, which go into the pinna and rachis, respectively. Sometimes four branches arise by the splitting of these two, but the general character of the arrangement is quite constant. Sometimes a small stele runs into the complex, as shown at *a*, Fig. 4.

\*The term stele is used here, in the ferns, without reference to the question of morphological propriety. See Jeffrey, E. C., 'The morphology of the central cylinder in the angiosperms,' *Trans. Can. Inst.*, Vol. 6.

In no case examined, however, does a bundle end in a gland, as held by Figdor (*l. c.*). The relations of the glandular and vascular tissues are none the less intimate and striking, as we shall see in coming to the second point.

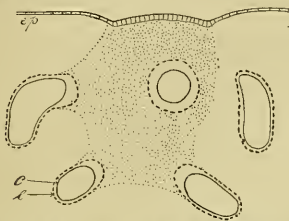

FIG. 5. Diagram of a transverse section through a nectary. *ep*, epidermis; *c* and *e*, as in Fig. 4.

In examining a transverse section we see the glandular tissue extends towards and comes partially to surround the vascular bundles adjacent (Fig. 5), and, further, that the pericycle of these bundles, in the regions contingent upon the gland, consists of three to four layers of enlarged cells, and not, as is to be found elsewhere, of a single layer of cells (Fig. 6, *a* and *b*). These enlarged pericycle cells are abundantly supplied with cytoplasm of fine, tenuous structure with large and often irregularly shaped nuclei. The cytoplasm is little vacuolated.

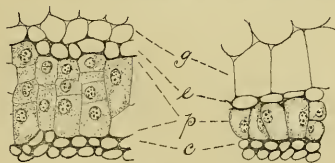

FIG. 6. *a*, transverse section through a portion of the pericycle in contact with the glandular tissue. *b*, a similar portion in a bundle adjoining the ground tissue. *c*, cribral cells; *p*, pericycle; *e*, endodermis; *g*, ground parenchyma.

The pericycle cells found elsewhere in the petiole, where the glands are active, are supplied with a scant amount of cytoplasm.

The endodermis,\* which is usually regular and well marked, is, in the vicinity of the nectary, quite irregular and often difficult to recognize, and its cells have very much the character of the adjoining gland cells in shape and content. We may thus regard these cells, namely, those of the endodermis and pericycle, where the bundles and nectary touch, as a part of the gland. Whether we may assign a different function or the same to these cells may not be answered. Bonnier (*l. c.*) has indicated that, besides the two sugars above named, an invertin is to be found in the gland. The suggestion occurs to us that this substance originates in the pericycle. Nevertheless, the greater development of the pericycle as already indicated can perhaps be entirely accounted for by the activity of its cells in passing the soluble carbohydrates from the moving sap into the gland.

After the activity of the gland ceases, the thickening of the walls of the endodermis commences, in all the bundles lying in the petiole near the fork formed by the pinna, and the process extends to the surrounding parenchyma. In this way the strength of the fork is very materially heightened. We notice also, with Figdor, a thickening of the walls of the gland cells, a process which takes place in all the chlorophyll-bearing cells beneath the stomatal bands.

In offering a teleological explanation of the organs above described, F. Müller pointed out that in Brazil the fern is visited by an ant (*Cremogaster* sp.) of which a leaf-cutting species, an *Oecodoma*, stands in dread. To this Francis Darwin † answers that the plant has few natural enemies—meaning, presumably, in England, though this is equally true, so far as observation goes, in North America. Francis Darwin further suggests, in the view of the possible weakness of the above explanation, that the

\* Derived from the phloeoterma of Strasburger.

† *Nature*, 16: 100.

gland is either an organ which was formerly of use and is now passing away, or that it is connected 'with some unknown process of nutrition.' That its activity 'is decidedly connected with the growth of young fronds' stands in favor of the latter view. A supplementary suggestion has already been made by the writer to the effect that the solution of actively secreted sugar may act as a carrier for some other substance in the nature of an excretion.\*

The writer has observed on the surface of the gland in some cases a felt of dark-colored fungal hyphae. The occurrence of these, when the leaf-blade has not yet unfolded, carries with it the suggestion that the nectarial surface is a constant infection-point, the sugary fluid acting as a nutrient medium and the entrance of the hyphae being made easy by the large stomata.

#### ORIGIN OF THE NECTARY.

Certain facts which have been pointed out give us grounds for offering a view of the origin of the nectaries, to the effect that they have arisen as portions of the respiratory areas of the petiole and its branches, which have become secondarily specialized as nectar-secreting glands.

In support of this view, we recall the relation of the nectaries to the stomatal bands (pneumathodes), with which they have a practically identical structure, with, however, a more intimate connection with the vascular system. We regard the wide distribution of these band-shaped pneumathode regions in the ferns as indicating a phylogenetically greater age than that of the nectaries as such. If this be true, Francis Darwin's suggestion, quoted above, that the nectary is an organ once useful but now on the wane, must probably be thrown out of court, though not necessarily. Further, the stomata, while clearly func-

\* Bonnier (*l. c.*) has shown that other substances are thrown off in small quantities.

tionless as pneumathodes during the period of the gland's activity, and deprived of the delicate mechanisms for closure both by their own development and the manner of growth of the surrounding epidermis, are nevertheless to be regarded as respiratory mechanisms, serving the function of setting free the nectar. The analogous conditions in *Tropaeolum* and other plants may be cited as a parallel case save in the nature of the exudate. The presence of the substomatic spaces, usually broader beneath the stoma than represented in Fig. 3, together with the intercellular spaces both suggest the same thing.

It is to be questioned if the presence of chlorophyll in the gland has any necessary relation to the activity of the organ as a gland, upon which point further study of the cytological phenomena may throw light.

Haberlaudt\* has drawn the provisional conclusion with regard to nectaries in general, that they have been derived phylogenetically from hydathodes. In summarizing the present paper we submit the case described herewith as one in which the nectaries have been derived both ontogenetically and phylogenetically from pneumathodes.

FRANCIS E. LLOYD.

TEACHERS COLLEGE,  
COLUMBIA UNIVERSITY.

#### THE BRITISH NATIONAL ANTARCTIC EXPEDITION.†

The resignation of the man who is, before all others, fitted to be the Scientific Leader of the National Antarctic Expedition will lead the fellows of the Society to expect some statement of the causes which have produced a result so disastrous to the interests of science. The following statement gives an account of the efforts which

\* 'Physiologische Pflanzenanatomie,' p. 432.

† A letter addressed by Professor Edward B. Poulton, of Oxford University, to the fellows of the Royal Society.

have been made to prevent the injury which has occurred.

In the autumn of 1899, Captain Tizard, F.R.S., and I were appointed as the representatives of the Council of the Royal Society on an Antarctic Executive Committee of four, Sir Clements Markham (Chairman) and Sir R. Vesey Hamilton being the representatives of the Royal Geographical Society's Council. Our functions were defined under various heads in a printed form previously agreed upon. No. 2 instructed us to submit a program of the Expedition for approval to the Joint Antarctic Committee (consisting of sixteen representatives of each Council), "such a programme to include (a) A general plan of the operations of the Expedition, including instructions to the Commander, so far as this can be laid down beforehand. (b) The composition of the executive and scientific staff to be employed, the duties, preparation and accommodation for, and pay of, the several members." No. 4 instructed us "to make the appointments of the several members of the executive and scientific staff, subject to the final approval of the Joint Committee." The word 'civilian' was nowhere employed. The four members of the Executive Committee were placed on the Joint Committee and all Sub-Committees.

Before the first meeting of the Executive Committee, Captain Tizard and I were seen by Professor Rücker, who informed us that one of the first points which the Council of the Royal Society desired us to raise was the relation in power and status between the Commander and the Scientific Leader. In the German Expedition, which was to start about the same time, the Scientific Director had absolute power, and we were asked to consider the possibility of such an arrangement in the English Expedition.

At one of our first meetings, I think the very first, I raised this question and sup-

ported the German arrangement. The other three members, who were all naval experts, convinced me that English law required the Captain to be supreme in all questions relating to the safety of his ship and crew. Since that time I have never disputed this point, but always maintained that the scientific chief should be head of the scientific work of all kinds, including the geographical, and that the Captain should be instructed to carry out his wishes, so far as they were consistent with the safety of ship and crew.

We then considered the appointment of Scientific Leader and decided to nominate Professor J. W. Gregory, then of the British Museum of Natural History. In suggesting his name to my colleagues, I was influenced by his proved success in organization and in the management of men in a most difficult expedition (British East Africa in 1893), by the wide grasp of science which enabled him to bring back valuable observations and collections in so many departments. His ice experience in Spitzbergen and Alpine regions was also of the highest importance, together with the fact that his chief subject was geology, a science which pursued in the Antarctic Continent would almost certainly yield results of especial significance. In addition to all these qualifications, Professor Gregory's wide and varied knowledge of the earth rendered his opinion as to the lines of work which would be most likely to lead to marked success extremely valuable in such an expedition. No one was more competent to state the probable structure of the Antarctic Continent and its relation to that of the earth. This opinion of Professor Gregory's qualifications for the position of scientific leader of an Antarctic expedition is, I know, widely held among British scientific men. In their wide combination, and united as they are to tried capacity as a leader, they are unique, and

an expedition with Professor Gregory for its scientific chief, with as free a hand as English law would permit, was bound to yield great results.

The Committee deputed me to ask Professor Gregory if he would consent to be nominated. In doing so I carefully explained that he could not have the full powers of the German scientific leader. He consented to consider the offer favorably, but wished for a more definite statement of his position and powers, and for a program of the Expedition. Shortly after this he was appointed professor of geology at Melbourne, and left England. On the voyage he wrote a long letter to the Executive Committee (dated January 19, 1900), which he posted to me at Port Said. In it he said, "I have heard so many rumours as to what is wanted, that I cannot be sure whether I correctly understand the views and wishes of the Executive Committee: I therefore write mainly for the sake of correction, so that I may avoid any misstatements in communicating with the Council of Melbourne University, when the proposal from the Committee reaches me." The plan drafted by Professor Gregory in this letter included the provision of a landing party with house, observing huts, dog-stable, etc., and he argued that its organization should be placed 'in the hands of the scientific staff,' but that, under any circumstances, the Scientific Leader should have the opportunity of controlling a small independent party on land. This letter was read by all the members of the Executive Committee, and, on June 15th, at the close of the meeting, the Secretary despatched a cable to Professor Gregory containing the information "Your letter of January 19 has been received and approved." As soon as Professor Gregory received this he sent a decoded copy to Sir Clements Markham, who did not correct it. Indeed, at this period Sir Clements Markham frequently

expressed opinions which implied that he contemplated the establishment of a landing party independent of the ship. Professor Gregory applied for and received from the Council of Melbourne University permission to take the appointment on the lines of his letter of January 19th.

Professor Gregory's name was very warmly received by the Joint Committee and he was appointed Scientific Head on February 14, 1900; the words "Formally appointed, wire when fully able to decide," being cabled to him a few days later by Sir Clements Markham.

Lieutenant Robert F. Scott, Torpedo Lieutenant of H. M. S. *Majestic*, was appointed Commander of the Expedition by the Joint Committee, on May 25, 1900.

In June, 1900, my attention was called to a statement in the *Press* describing Professor Gregory as 'Head of the Civilian Scientific Staff.' Feeling confident that the word 'civilian' was not employed in the resolution accepted by the Joint Committee I wrote to Sir Clements Markham on the subject. In his absence the Secretary replied, "The words 'Head of the Civilian Scientific Staff' are the exact words of the resolution passed by the Joint Committee appointing Professor Gregory, and I know Sir Clements himself was very anxious to have the word 'civilian' in, so that no difficulty might arise between Professor Gregory and the Commander of the Expedition, since the civilians would not be the only scientific men on board." The word 'civilian' does certainly occur in the minutes of the meeting. On the other hand, Sir Clements Markham was not present on that occasion (February 14, 1900); the word 'civilian' did not occur in the instructions issued to the Executive Committee, and was not used in my letter to Sir Clements (February 15th) describing the result of the meeting and asking him to cable.



The words I used, 'leader of Scientific Staff,' were not commented upon in his reply (February 16th), stating that the cable should be sent. The word 'civilian' was not used by Dr. W. E. Blanford, writing to convey the unanimous recommendation of the Geological Sub-Committee that Professor Gregory should be 'chief of the Scientific Staff of the Expedition.' Professor Herdman, who seconded the resolution on February 14th, and I, who proposed it, both remember the words 'Scientific Leader of the Expedition.' I have not been able to recover a copy of the notice convening the meeting, in which the agenda were put down. It would, however, have been unreasonable for the Joint Committee, to have accepted the word 'civilian' when it had no information before it which justified the expectation that naval officers would be lent by the Admiralty.

At the meeting of the British Association at Bradford, I explained the situation to Professor Rücker, who agreed with me that it was full of danger, on account of the reasons alleged for the use of the word 'civilian,' viz., in order to discriminate between the science under Professor Gregory and that under the Commander. He agreed with me that the coordination of all the science of the expedition ought to be in the hands of the scientific chief who had been selected, because his reputation was a guarantee that all interests would be properly looked after. Sir Michael Foster, to whom I mentioned the matter at a later date, quite agreed with this opinion, but was unwilling to contest the use of the term 'civilian.' Furthermore, when I raised the question at a meeting of the representatives of the Royal Society on the Joint Committee, it appeared that the term was actually preferred by certain influential naval authorities who were present, so that it was impossible to resist it without dividing those who desired to give Professor

Gregory such a measure of freedom of action as he was prepared to accept.

At the meeting (November 20, 1900) of the Joint Committee, following the conversations with Professor Rücker and Sir Michael Foster, a report from the Executive Committee and submission and estimate from Captain Scott were read and received, with certain modifications. I indicated to the Secretaries of the Royal Society, who were sitting opposite to me, that this was a favorable opportunity to raise the question of the powers of the Scientific Director over the whole of the science of the Expedition. They were, however, unwilling to do so, hoping, I believe, that all difficulties would be smoothed away by personal negotiations between Captain Scott and Professor Gregory, who was expected home in a fortnight.

For nearly two months these negotiations proceeded between Professor Gregory on the one side and Captain Scott and Sir Clements Markham on the other, and between Sir Clements Markham and me.

The principles held were irreconcilable, and it only remained to appeal to the Joint Committee for a decision.

On January 9, 1901, Professor Gregory wrote to Professor Rücker, explaining the failure of the negotiations, and on January 28th he addressed a letter to the Royal Society's representatives on the Joint Committee, from which I select the following paragraphs:

I landed at Liverpool on December 5, and went straight to Dundee to meet Captain Scott, and showed him a copy of my letter of January 19 [1900]. As he returned it to me next day without comment, I believed that he understood and accepted the general conditions therein stated. On January 7, in order to settle the exact terms of our mutual relations, I submitted to Captain Scott a draft of the instructions I expected to receive from the Joint Committee, and which I had previously shown to Professor Poulton. To my surprise Sir Clements Markham and Captain Scott expressed disapproval of these instructions, practically on the ground that there could be only

one leader of the Expedition, and that that leader must be Captain Scott.

My colleagues and myself were characterized as civilian scientific experts, accompanying the expedition to undertake investigations in those branches of science with which the ship's officers were unfamiliar, and it was proposed that, to maintain Captain Scott's complete control, all the scientific men should be required to sign articles.

According to this theory, the position of the scientific staff is accessory and subordinate. The contentions of Sir Clements Markham and Captain Scott would completely alter the position which I was invited to take and which alone I am prepared to accept. Were I to accompany the expedition on those terms there would be no guarantee to prevent the scientific work from being subordinated to naval adventure, an object admirable in itself, but not the one for which I understood this expedition to be organized.

The Executive Committee met on January 30th and drafted instructions on lines approved by Sir Clements Markham. They were opposed by my colleague Captain Tizard, but in my absence through illness were passed by two votes to one.

A few days later the draft instructions were considered by the Royal Society's representatives, who appointed Sir Joseph Hooker, Sir William Wharton and Sir Archibald Geikie to suggest amendments. They carefully considered the draft and suggested several alterations, the most important of these being the instructions to the commander, (1) not to winter in the ice, (2) to establish between two named points on the coast a landing party with three year's stores, under the control of Professor Gregory.

The Royal Society's representatives again met and unanimously approved these amendments, which were submitted together with the draft instructions to the meeting of the Joint Committee on February 8th. The representatives of the Royal Geographical Society objected that they had not had the same opportunity of considering the instructions at a separate meeting, and that the amendments were sprung upon them. The meeting was accordingly ad-

journed until February 12th, the very day before Professor Gregory sailed. During the prolonged discussion which took place, the authorities on magnetism were unanimous in affirming that a station on land was essential in order to obtain the full value of the observations made on the ship.

Sir Clements Markham threatened that the Council of the R. G. S. would not accept the amended instructions, whereupon Sir Michael Foster drew attention to the letter which Sir Clements had written at the time when the Joint Committee was proposed.

The amendments were finally approved by 16 votes to 6, and Sir Archibald Geikie and I were deputed to explain to Professor Gregory, who was in attendance, that he was to be landed in control of a small party, if a safe and suitable place could be found, and to ask if he would accept these conditions. We reported his consent to the meeting, which was then adjourned for the consideration of other details.

Two of the representatives of the R. G. S., Sir Anthony Hoskins and Sir Vesey Hamilton, resigned shortly afterwards, explaining that they could not agree with the action of the Committee. The R. G. S. had, however, the right, which it subsequently exercised, of appointing new members.

At the adjourned meeting, on February 19th, the question of the ship wintering was discussed at length. Those who had practical experience of the Antarctic urged us strongly not to take the responsibility of permitting the ship to winter in the ice. Sir Joseph Hooker's statement of the danger was especially impressive, and the meeting decided in accordance with his opinion.

At the same meeting Major L. Darwin proposed to modify the conditions accepted by Professor Gregory, by adding to them the additional consideration that he should only be landed if the time of the ship should not be too greatly diverted from

geographical exploration. I protested strongly against any modification at this stage. Sir Michael Foster opposed me, and, after the close of the meeting, there was a somewhat sharp though friendly expression of conflicting opinions, he maintaining that there should be 'give and take,' I that we were already pledged to Professor Gregory, that the arrangement was as it stood a compromise—the minimum Professor Gregory would accept—by no means the one which scientific men, not belonging to the navy, would have preferred.

At that meeting Major Darwin did not succeed, but his suggestion in somewhat different words was again brought forward at the next meeting on March 5th. Just before the meeting Sir Archibald Geikie told me that he intended to support the proposed changes 'in the interests of peace,' and that Mr. Teall, and Mr. George Murray, Professor Gregory's representative, also approved them. Resistance was hopeless; I could only protest against any alteration of the conditions offered and accepted, requesting that my name and the names of those who agreed with me (Mr. J. Y. Buchanan and Captain Tizard) should be recorded.

I wrote to Professor Gregory a full account of what had happened, carefully explaining that his representative and many of his friends supported the changes, that I had confidence that the proposal was made to enable the Geographical Society to accept the instructions and that it was not intended to prevent, and, I believed, would not prevent, his being landed.

In spite of the incorporation of Major Darwin's changes the R. G. S. Council refused to accept the instructions, but addressed a letter signed by their President, dated March 18th, to the members of the Joint Committee stating that they were compelled, "as trustees for the money subscribed through their Society and for the funds

voted by their Society, to regard the above scientific objects [viz., those to be carried out by a landing party] as subsidiary to the two primary objects of the Expedition—namely, exploration and magnetic observations." In view of the unanimous witness of all experts that the landing party was *essential* for full success in the magnetic work this statement is sufficiently remarkable.

The letter went on to inform us that the President, Sir Leopold McClintock, and Sir George Goldie had interviewed the officers of the Royal Society and had reported to the R. G. S. Council which now suggested that the Joint Committee should recommend a small committee of six, three to be appointed by each Council, to deal finally with the instructions. The Council of the R. G. S. agreed to accept the decision of this committee provided the Council of the Royal Society agreed to do the same.

It has been stated in various directions that the Geographical Society produced new evidence (based upon the experience of Borchgrevink and the intentions of the German leader) which had not been laid before the Joint Committee, and thus induced the officers of the Royal Society to agree to a new committee. To this it may be replied that these sources of information had been open to the Joint Committee, and that, if anything new had arisen, it was reasonable to refer it to the old committee rather than to a new one appointed *ad hoc*. Furthermore, the letter of the Royal Geographical Society, referred to above, clearly indicated that the real intention was to escape from the conditions proposed to and accepted by the Scientific Leader.

The Joint Committee met on April 26th, and was addressed in favor of the course proposed by the R. G. S. Council by Sir George Goldie. Nothing was said which could diminish the conviction that the R. G. S. Council and that of the R. S. in weakly

consenting to nominate a fresh committee had struck a disastrous blow at all future cooperation between scientific bodies in this country.

What reply could the officers make if they were asked to advise the Council of the Royal Society to cooperate with that of the Royal Geographical Society on any future occasion?

I felt justified in asking what guarantee was there that the Council of the Royal Geographical Society would accept the finding of the committee of six, when it had refused to accept that of a committee which included all the officers and almost every expert in Arctic and Antarctic exploration from both societies. In reply Sir Michael Foster, in spite of the promise of firmness held out by his attitude on February 12th, when Sir Clements Markham threatened that his council would repudiate the finding of the Joint Committee, maintained that they had only acted within their rights, and that the Royal Society Council claimed the right to do the same if it had not agreed with the decision.

At this point it will be convenient to give a list of the representatives of the Royal Society on the Joint Antarctic Committee, the representatives of the Royal Geographical Society being equally significant in relation to the council of their own society. They are the President, the Treasurer, the Senior Secretary, the Junior Secretary, Mr. A. Buchan, Mr. J. Y. Buchanan, Captain Creak, Sir J. Evans, Sir A. Geikie, Professor Herdman, Sir J. D. Hooker, Professor Poulton, Mr. P. L. Sclater, Mr. J. J. H. Teall, Captain Tizard, and Admiral Sir W. J. L. Wharton.

If the reports of Joint Committees of such magnitude and weight are to be thrown over with the approval of the councils of both societies because a majority of one council does not agree with the conclusions, men will rightly hesitate before consenting

to devote an immense amount of time and trouble to the work of the Society, and the efficiency of the Royal Society will be greatly diminished.

The considerations set forth above indicate the future injuries which are likely to be inflicted on our Society by this surrender. At the meeting on April 26th, I was more concerned with the immediate and pressing injury, and therefore urged that the Royal Society was a trustee for the interests of science and that we had pledged ourselves to secure certain powers to the Scientific Director, that it was better the expedition should not start (a contingency contemplated as possible by Sir George Goldie, but not a serious danger, I believe, even though the Royal Society had stood firm and appealed to the Government, not on the subject-matter in dispute, but on the refusal of the Royal Geographical Society to work with the recognized methods of cooperation) than that the Royal Society should betray its trust, that the fellows of the Society would not support the officers in thus yielding to the Royal Geographical Society, and that I should feel bound to explain my position to the Society: Sir Archibald Geikie and Mr. J. Y. Buchanan also strongly objected to the surrender, which was then confirmed by a large majority of those present.

We were told by Sir George Goldie that the three representatives of the Royal Geographical Society on the new committee would be Sir Leopold McClintock, Mr. Mackenzie, and Sir George himself; by Sir Michael Foster that the Royal Society Council would appoint three non-experts, viz.: Lord Lister, Lord Lindley and the Treasurer, who could pronounce without bias upon the whole of the evidence. My colleague, Captain Tizard, with whom I had worked with the most complete sympathy and agreement through the whole course of the negotiations, supported the

formation of the new committee, because of Sir Michael's assurance that all evidence would be sifted and because of his faith in the validity of the evidence he had to give. Others probably voted in the affirmative for the same reason.

Without asking for evidence from Sir Joseph Hooker, Sir W. Wharton, Sir George Nares, Sir A. Geikie, Captain Creak, Captain Tizard or Mr. Buchanan, the new committee proceeded to cable to Melbourne the modifications which have led Professor Gregory to resign.

In bringing a condensed account of the negotiations before the Fellows of the Royal Society I desire to call attention to certain special difficulties which the Society has had to encounter in the struggle.

- (1) The fact that nearly the whole of the money voluntarily subscribed was obtained through members of the Geographical Society and from its funds.
- (2) The fact that Sir Clements Markham, President of the Royal Geographical Society, a man of remarkable energy, resource and resolution, was the chief antagonist of the amendments passed by the Joint Committee.
- (3) The fact that the Junior Secretary and Sir John Evans were absent from England during the most critical period.
- (4) Professor Gregory's appointment to the Chair at Melbourne, involving his absence from England during a large part of the negotiations.

Making all allowance for these difficulties, I believe that the majority of the fellows will consider that the claims of the scientific chief in an expedition undertaken to do scientific work have not received from the Royal Society that unflinching, undivided and resolute support which they would have expected and desired.

EDWARD B. POULTON.

OXFORD, May 15, 1901.

*FIRST REPORT OF THE LIMNOLOGICAL COMMISSION OF THE AMERICAN MICROSCOPICAL SOCIETY.*

THE initial report of a body so recently organized as this can hardly be more than

preliminary in character, all the more so that the field entrusted to it is as extensive as untried. When, by the action of this Society a year ago, the Limnological Commission was organized and its members asked to assume the duties laid upon them in connection therewith, they accepted, not without some hesitancy at the extent of the work before them. The study of fresh-water bodies is indeed a great field, barely touched upon at one or two points in this country, and nowhere in the world even superficially covered as yet. Nevertheless it was the original field of biologic study; it was and is accessible to public and private workers practically everywhere, and affords opportunities for extended or limited work in any particular department of biologic research towards which the student may be drawn. Furthermore, to this work attaches an undoubted interest for all who come within its territory, while its problems have not only great biologic importance, but are also of economic value as well as of decidedly practical character, touching as they do upon the important questions connected with fish culture, municipal water supply and sewage disposal.

In this first report it will not be possible to do more than outline succinctly what has developed from our correspondence and discussion thus far regarding the object of the work, to make a brief survey of the field under discussion, of the ends to be reached and of some of the means for attaining them, and finally to invite propositions concerning the methods and problems under consideration and cooperation in proceeding toward their solution.

It may be fitting at the outset to state briefly the outlook before the Commission. Such a venture as this is not entirely unheard of and consequently venturesome. A similar body was appointed some years ago by the Swiss National Society of Natural Sciences. As a Swiss investigator,

Professor Forel, of Geneva, was the pioneer in the study of fresh-water lakes, and, as the investigators of this beautiful mountain republic have retained their supremacy in this field of research through more than thirty years, so also Switzerland was the leader in organized effort towards the development of limnological investigation. The plan of the Swiss Limnological Commission in assigning work in various regions to different students has met with such success as to inspire those who follow in its footsteps with hope for the outcome of their efforts, and as to hold up a high standard for their attainment. Similar results cannot be expected in a brief period of time, but we hope that they may be reached here eventually.

The study of limnologic questions affords abundant opportunities for workers of every type and of every grade; but if the results of such varied activity are to be of permanent value or of general import they must be correlated and unified. There with gaps in the records will become apparent and new problems will be suggested, so that the lines of work will be extended and at the same time joined together into a symmetrical system. The fundamental objects then of this Limnological Commission we believe to be:

To coordinate the results obtained by different investigators into a united whole, to enlist new workers and to encourage new work along lines already marked out, to suggest new lines of work and methods of research, and to aim at uniformity of procedure, so that the results may be compared and correlated.

For convenience in discussion and in the organization of the work, the field of limnologic study has been cut up into a number of main divisions and some of the chief subdivisions under each indicated. These are as follows:

1. Bibliography: A general historical re-

view of limnological studies to date; periodic summaries of work done in the world at intervals thereafter.

2. Physiography: The inanimate environment, including the physical and chemical study of water bodies; types of such bodies, distribution; temperature, color, circulation; lake areas; composition of water, etc.

3. Biology, (*a*) Taxonomy of water organisms: Systematic tables, description and sketch of each on cards to form eventually a faunal catalog for the United States. (*b*) Morphology of organisms: Anatomy, histology, embryology of individual forms. (*c*) Distribution of organisms: Geographic; regional; littoral, limnetic, bathybic species; quantitative: General, numerical, proportional. (*d*) Physiology, experimental studies. (*e*) Ecology.

4. Applied limnology: Water supply, sewage, fish culture.

After this preliminary statement, the Limnological Commission has the following recommendations to make for the purpose of advancing this work:

First, it is expedient that as soon as suitable persons can be found who are willing to undertake the work, there should be added to the Commission a physicist, a chemist and a bacteriologist, in order that these phases of the environment may be adequately studied.

Second, the influence of the Society should be directed towards the production and publication of accurate systematic accounts of the fresh-water organisms to the end that the various workers on limnologic questions may have at hand taxonomic summaries of the organisms with which they come in contact. It is not too much to say that such treatises are non-existent for American forms and inaccessible to the majority, even for the few groups which have been partially worked out. This must be the first step in the inauguration of the proposed movement. The publication of a series of

catalog cards, each devoted to a single species, appears as a desirable method of putting such data into accessible form and keeping them in shape for frequent emendation or addition.

Third, in the interest of a complete knowledge of the distribution of fresh-water organisms, the Commission plans the keeping of careful faunal records. It is proposed to appoint one or two investigators for each group, who shall undertake to enter and collate all faunal records of this group which may be sent them and conversely to furnish workers with information concerning the distribution of such organisms. This plan will ultimately yield data for the discussion of the geographical distribution of fresh-water genera and species. It will also enable the elimination of such data as are common, leaving for publication by the student those facts which are important for one reason or another.

Fourth, the Commission is of the opinion that an occasional summary of progress in the field of limnology will serve to keep students in touch with the subject by giving them knowledge of the work of the world in general. This is that subdivision of the field which stands first in the outline given above. It has been covered sufficiently for the present by the summary and review printed in the *Transactions of the American Microscopical Society*, Vol. XX., bringing the subject up to January, 1899.

Fifth, the Commission would most strongly advise that individual work should be limited to a single body of water or to a definite problem studied with reference to a series of such water bodies. The results will be most useful for all purposes when they bear upon the thorough treatment of a single phase of the subject rather than more indefinitely upon a wider field.

There is naturally involved in the effort to carry out such plans as have been outlined some expenditure of money, even if

the services of various investigators are freely and gratuitously placed at the disposal of the Commission. Accordingly, an appeal is made herewith to the generosity of those interested in the movement and in the development of biological study in our country for contributions, large or small, for the prosecution of this work.

In conclusion, all students interested in this subject are invited to participate in the work. It is by general and generous cooperation that success will be attained. The student who is working alone cannot advance far, unless brought in touch with others in the same field. It may be noted that the opportunity is peculiarly advantageous for those teachers in smaller colleges who can make use of a corps, even of untrained assistants, in the collection of various data: We feel it a privilege to invite kindly criticism of this report and suggestions as to the best means for carrying out the aims in view and for securing the cooperation of the largest number of workers.

(Signed) A. E. BIRGE, *Chairman*.  
C. H. EIGENMANN,  
C. A. KOFOID,  
G. C. WHIPPLE,  
H. B. WARD, *Secretary*.

NORTH CAROLINA SECTION OF THE AMERICAN CHEMICAL SOCIETY.

THE regular meeting of the North Carolina Section of the American Chemical Society was held in the State chemist's office, Agricultural Building, Raleigh, on April 27, 1901, at 11 A. M., with Professor Kilgore in the chair. Twenty-seven members and visitors were present.

The annual election of officers for the ensuing year were:

W. A. Withers, President; W. J. Martin, Jr., Vice-President; C. B. Williams, Secretary-Treasurer; Charles Baskerville, Representative in Council of the American Chem-

ical Society; Executive Committee, W. A. Withers, W. J. Martin, Jr., and C. B. Williams.

The following program was presented and discussed:

'Basis of Scientific Thought,' by CHARLES BASKERVILLE.

'The Chemical Composition of Cotton Seed Meal,' by W. A. WITHERS and G. S. FRAPS.

The authors found that the average amount of betain and cholin in seven samples of cotton-seed meal was 0.28 per cent., the ratios being (the average of two samples) betain : cholin :: 78.5 : 21.5. Gossypin if present is in minute quantity. Of the nitrogen-free extract 29.2 is pentosans, and 47.4 per cent. raffinose.

The pentosans of the meal are insoluble in diastase and are contained entirely in the nitrogen-free extract, unless an unusually large amount of hulls is present.

Cotton seed meal contains no starch and no appreciable quantities of sucrose or of reducing sugars. The average of five samples gave 0.48 per cent. of organic acids.

'The Recent Advances in Physiological Chemistry,' by A. S. WHEELER.

'Alcohol as an Antidote for Carbolic Acid,' by E. V. HOWELL.

1. In this paper attention was called to the fact that experiments by the author, beginning early in 1899, show that alcohol removes the escharotic effect of carbolic acid on the arm and in the mouth. 2. That, on account of the alarming increase in its use for suicidal purposes and the large number of accidents because of its general use as a disinfectant, carbolic acid should be scheduled as a poison in the poison laws of the various States and its sale restricted. 3. That alcohol is on record as an antidote and the results demand a thorough investigation. It must act most probably in one of three ways: (a) As a simple addition to

counteracting the escharotic effect; (b) as a chemical antidote, forming an inactive or less active compound; (c) as a physiological antagonistic, its stimulating effect combating the depressant effect of the phenol. In investigations being carried on, so far no chemical reaction between carbolic acid and alcohol, or carbolic acid and camphor (which also removes the escharotic effect) has been observed.

'The Presence and Detection of Arsenic in Beer,' by W. GRIMES HAYWOOD.

This paper was a review of the recent cases of poisoning in England, due to the presence of arsenic in beer, and a comparison of the methods for the determination of that element.

'A New Meteoric Iron from Davidson county, North Carolina,' by JOSEPH HYDE PRATT.

This iron was found on a hillside rising just east of Lexington—Troy road, about a half-mile south of Cid P. O., Davidson County. The iron originally weighed 13 lbs. 14 oz., and was somewhat oblong in shape and its surface more or less pitted. Testing the polished surface failed to reveal either the Widemannstättian figures or the Neumann lines; but the etched surface presents a granular or stippled appearance overlain with a network of fine lines, and the fractured surface shows traces of what is apparently an octohedral cleavage. This etched surface, while being different from the other meteorites, is also different from any of the manufactured irons that have been tested. An analysis by Dr. Baskerville gave: iron, 93.89; manganese, .92; nickel, .30; cobalt, .34; silicon, .62; carbon, 3.88; but sulphur, phosphorus, titanium, aluminum and copper were absent. Dr. Pratt claims that the presence of nickel and cobalt and the absence of sulphur, phosphorus, etc., together with its structure and the more or less isolated country in which it was found, lead to the belief that this iron is of me-



teoric origin. The name proposed for it is the Cid Iron.

'Ulsch-Street Method modified to include Organic Nitrogen in Samples containing Nitrates and Chlorides,' by W. M. ALLEN.

The author recommends the following: Place 0.7 gram sample in 250 cc. Kjeldahl digesting flask. Add about 1 gram of reduced iron, 30 cc. water and 10 cc. dilute sulphuric acid (1 to 1). Shake well and let stand 15 or 20 minutes. Heat slowly, so that solution will boil gently for 10 or 15 minutes, then briskly, until two-thirds of water has boiled off. Cool slightly, add 25 cc. sulphuric acid and 0.7 gram mercuric oxide. Digest and distill, as in Kjeldahl method. In samples of pure nitrate, add 0.5 gram of ferric chloride to the water to dissolve first nitric oxide set free, and digest only for the nitric nitrogen. The presence of large amounts of iron salts must be guarded against or else violent bumping will give trouble in distillation.

'The Nature of Pentosoids and their Determination,' by G. S. FRAPS.

The author divides pentosoids into water-soluble, acid-soluble, soluble in cold caustic soda solution ('wood gum') and difficultly soluble. Members of the first three classes have been hydrolyzed to pentose, and are called pentosans. The last class includes lignocelluloses, oxycelluloses, etc., and have not been hydrolyzed to pentoses. The crude furfural from vegetable materials obtained in the pentosan determination was found to contain a body which is precipitated by phloroglucol and destroyed by distillation with hydrochloric acid. Its occurrence, distribution and digestibility were discussed and the effect of its presence on the pentosan determination.

'An Automatic Filter-Washer,' by J. M. PICKEL.

This apparatus consists of (1) a reservoir for water with which to wash; (2) a rubber tube, provided with thumb-screw

clamps, leading from the reservoir to the (3) delivery vessel, which, by means of a small siphon, delivers the water intermittently on to the filter; (4) a funnel containing the filter and, set in this funnel, a smaller inverted funnel; (5) means for disposing of the washings. When once set going the apparatus needs no further attention, and is especially applicable in determining water-soluble nitrogen in fertilizers and also water-soluble phosphoric acid (although not yet in use for this latter purpose).

'Notes on the Latent Heat of Vaporization of Liquids,' by J. E. MILLS.

'Notes on the Determination of Insoluble Phosphoric Acid,' by C. D. HARRIS.

Mr. Harris exhibited an arrangement which had proved, in his hands, very satisfactory in filtering and washing citrate-insoluble phosphoric acid. He substitutes a carbon filter in the bottom of which is a porcelain disc covered with asbestos, for the slow and hazardous method of using a funnel and hardened filter paper.

'Contribution to the Chemistry of Thorium; Evidence pointing to the Existence of a New Element, Carolinium,' by CHAS. BASKERVILLE.

The author has obtained thorium salts from five different sources and purified them. By the action of sulphur dioxide on the neutral chlorides and by fractionating the citrates, oxides are eventually obtained which indicate the complexity of thorium. The pure oxide has a specific gravity of 9.8, according to some authorities, and 10.2, according to others. The purified oxide mentioned had a specific gravity of 10.1; after fractionating, one had a specific gravity of 9.4 and the other 10.37; intermediate fractions gave 9.6 and 10.4. Although atomic weight determinations have not been made, there is much evidence in favor of the existence of a new element, which the author would name 'Carolinium.' To avoid criticism the author stated his ex-

cuse for presenting the paper before the work was completed. Having made these observations quite four years ago, in the interim he has been engaged in securing direct from monazite sufficient quantity of pure thorium salts. Five thousand liters of solution have been worked up. The author's supply of the element has been much augmented through the kindness of Dr. Waldron Shopleigh, of the Welsbach Light Company, who presented him with two kilograms of his purest thorium oxalate. Last fall the author wrote Professor Bohnslar Brauner, of Prague, who had made the most recent atomic weight determinations of thorium, about his experiments. Not hearing from Dr. Brauner, the author was surprised to see in the *Proceedings of the London Chemical Society*, April 10, 1901, an article on 'Contributions to the Chemistry of Thorium' by Dr. Brauner, in which he states that he had fractioned thorium by hydrolysis of the oxalate into two bodies which he terms  $Th_{\alpha}$  and  $Th_{\beta}$ . Brauner's work as reported was by no means complete. While the author insists that he holds the very highest opinion of Professor Brauner, and while neither his work nor the motives prompting Professor Brauner in making this preliminary publication are called into question, in justice of the author's work along these lines, it was not deemed unscientific to present the results of incomplete observations.

'The Systematic Investigation of Soils,' by B. W. KILGORE.

After the transaction of some miscellaneous business the Section adjourned to meet in the summer.

C. B. WILLIAMS,  
Secretary.

THE AMERICAN ASSOCIATION FOR THE  
ADVANCEMENT OF SCIENCE.

WE publish below a list of those who have been elected members in the Associa-

tion and have completed their membership during the month of May.

- Albree, Chester B., Mechanical Engineer, 14-30 Market Street, Allegheny, Pa.  
Allan, Chas. F., Newburgh, N. Y.  
Baldwin, Hon. Simeon E., Associate Judge of Supreme Court of Errors, New Haven, Conn.  
Beach, Harry W., Manufacturer, Montrose, Pa.  
Bethel, Ellsworth, Director, Department of Botany, Academy of Science, 271 Grant Ave., Denver, Colo  
Booth, Edward, Instructor of Chemistry, 1214 Harrison St., Oakland, Cal.  
Brasfield, Prof. Stanley E., Professor of Mathematics, 327 Centre St., Easton, Pa.  
Braunnagel, Dr. Jules L. A., Physician and Surgeon, P. O. Box 925, San Antonio, Texas.  
Brown, Elisha R., President Stafford Savings and National Banks, 50 Silver St., Dover, N. H.  
Bush-Brown, Henry K., Sculptor, Newburgh, N. Y.  
Capp, John A., Mechanical Engineer, Schenectady, N. Y.  
Carnegie, Thomas Morrison, Trustee of Carnegie Institute, Dungeness, Fernandina, Fla.  
Chauvenet, Wm. M., Mining Engineer, 620 Chestnut St., St. Louis, Mo.  
Clapp, D. C., Steel Manufacturer, 718 Amberson Ave., Pittsburg, Pa.  
Clark, John J., Dean of Faculty, International Correspondence Schools, P. O. Box 534, Scranton, Pa.  
Cleaver, Albert N., Manufacturer, South Bethlehem, Pa.  
Clerc, Frank L., Professor of Metallurgy and Assaying, Colo. State School of Mines, Hotel Metropole, Denver, Colo.  
Coit, Joseph H., St. Paul's School, Concord, N. H.  
Cooper, James C., Tax Commissioner C. K. I. & S. P. R. R. Co., Room 5, Veale Block, Topeka, Kansas.  
Cox, Prof. Ulysses O., Professor of Biology, State Normal School, Mankato, Minn.  
Cummins, G. Wyckoff, Practicing Physician, Belvidere, N. J.  
Currier, Mrs. Moody, Myrtle & Ash Sts., Manchester, N. H.  
Dempster, Alexander, Engineering, Stanton & Enclid Aves., Pittsburg, Pa.  
DuBois, Howard W., 4526 Regent St., Philadelphia, Pa.  
Engler, Dr. Edmund A., President-elect Worcester Polytechnic Institute, Washington University, St. Louis.

- Farquhar, Miss Helen, Teacher of Geometry, Algebra and Physics, Moravian Seminary, Bethlehem, Pa.
- Frost, George H., Editor of *Engineering News*, 220 Broadway, New York City.
- Galbraith, Prof. John, School of Practical Science, Toronto, Canada.
- Graham, James C., Chemist, Phillips Academy, Andover, Mass.
- Granville, Dr. Wm. A., Instructor in Mathematics, Yale University, 7½ Elm St., New Haven, Conn.
- Grimes, Prof. James S., 122 Wesley Ave., Evanston, Ill.
- Gold, Rev. Dr. James Douglas, Covington, Miami Co., Ohio.
- Hall, Robert W., Biology, 2 Hillhouse Ave., New Haven, Conn.
- Halsted, William Stewart, 1201 Eutaw Place, Baltimore, Md.
- Hamaker, Prof. John I., Professor of Geology and Biology, Trinity College, Durham, N. C.
- Harrison, Dr. Robert Henry, Practising Physician, Columbus, Colorado Co., Texas.
- Henrich, Carl, Mining Engineer, Care of Union Copper Mining Co., Gold Hill, N. C.
- Herr, Hiero B., Civil and Mining Engineer, 1246 Marquette Building, Chicago, Ill.
- Herschberg, Hon. Michael H., Judge of Supreme Court, State of New York, Newburgh, N. Y.
- Hill, Ebenezer, Treasurer, Norwalk Iron Works, South Norwalk, Conn.
- Hillkowitz, Dr. Wm., Physician, 704 Race St., Cincinnati, Ohio.
- Holmes, Frederic Harper, Instructor in Physics, Geography and Mathematics, State Normal School, Hyannis, Mass.
- Hoobler, Bert R., Botanist and Zoologist, Wabash College, Crawfordsville, Ind.
- Hooker, Donald R., Chemist, 436 Orange St., New Haven, Conn.
- Hooper, Alcaeus, 710 Merchant's Bank, Baltimore, Md.
- Hotchkiss, Henry S., Geologist, 55 Hillhouse Ave., New Haven, Conn.
- Howland, Howard N., Lake Forest, Ill.
- Keller, Edward, Ph.D., Box 724, Baltimore, Md.
- Kelly, William, Mining Engineer, Gen. Mgr. Penn. Iron Mining Co., Vulcan, Mich.
- Kendall, Hugh F., Mining Engineer, Care of Pittsburgh & Lake Angeline Iron Co., Ishpeming, Mich.
- Kindle, Dr. Edward M., Geologist, 109 Elm St., New Haven, Conn.
- Kops, Julian de B., Civil Engineer, Savannah, Ga.
- La Fetra, Dr. Linnaeus E., Physician, 58 West 58th St., New York City.
- La Rue, Wm. G., Mining, North Freedom, Sauk Co., Wis.
- Lauder, George, 7403 Penn Ave., Pittsburg, Pa.
- Lockwood, Cornelius U., Teacher of Science, P. O. Box 15, Middle Hope, Orange Co., N. Y.
- Maëbeth, Geo. A., 717 Amberson Ave., Pittsburg, Pa.
- Macdonald, Benjamin J., 296 Grand St., Newburgh, N. Y.
- Marble, Milton M., Instructor in Physics, Hillhouse High School, New Haven, Conn.
- Marvin, Walter T., Philosophy and Psychology, 39 Knox St., Cleveland, Ohio.
- McKelvy, Dr. Wm. H., President Board of Education, 420 6th Ave., Pittsburg, Pa.
- Morton, James F., Andover, N. H.
- Negley, Henry H., Botanist, 600 N. Negley Ave., Pittsburg, Pa.
- Ness, Prof. Helge, Botanist, A. & M. College, College Station, Texas.
- Nicola, Frank F., Engineering, Cor. Wood & 6th Aves., Pittsburg, Pa.
- Palmer, Dr. Charles S., Professor of Chemistry, University of Colorado, 1224 Pine St., Boulder, Colo.
- Perkins, Albert S., Teacher of Chemistry, 75 Milton Ave., Hyde Park, Mass.
- Platt, Dr. Walter B., Physician, 802 Cathedral St., Baltimore, Md.
- Porter, Henry K., Trustee of Carnegie Institute, 541 Wood St., Pittsburg, Pa.
- Rice, John A., Mining Engineer, Bland, Bernalille Co., New Mexico.
- Richards, Alfred N., 45 West 60th St., New York City.
- Richards, Prof. Charles R., Professor of Mechanical Engineering, Univ. of Nebraska, Lincoln, Nebr.
- Roe, Edward Drake, Jr., Associate Professor of Mathematics, Syracuse Univ., 105 Anna St., Syracuse, N. Y.
- Schweinitz, E. A. de, M.D., U. S. Dept. Agriculture, Washington, D. C.
- Scott, William, Attorney-at-Law, 450 4th Ave., Pittsburg, Pa.
- Sedgwick, Prof. Wm. T., Mass. Inst. Technology, Boston, Mass.
- Shaw, Wilson A., Cashier Merchants' and Manufacturers' National Bank, Norwood Ave., cor. Forbes Ave., Pittsburg, Pa.

- Sherman, Dr. Lewis, Physician, 448 Jackson St., Milwaukee, Wis.
- Sherman, Franklin, Jr., State Entomologist, Raleigh, N. C.
- Shropshire, Dr. Walter, Physician, Yoakum, DeWitt Co., Texas.
- Silvester, Richard W., President, Maryland Agricultural College, College Park, Md.
- Smith, Arthur, Lawyer, 152 Broadway, New York City.
- Smith, Henry L., President, Davidson College, Davidson, N. C.
- Smith, Miss Jennie M., 803 Arch St., Allegheny City, Pa.
- Smith, Miss Matilda H., 803 Arch St., Allegheny City, Pa.
- Smith, Miss Sara Winthrop, Botanist and Anthropologist, Nantucket, Mass.
- Smith, T. Guilford, Civil Engineer, Regent University State of New York, P. O. Drawer, Buffalo, N. Y.
- Snedaker, James A., Mining Engineer, 721-722 Equitable Bldg., Denver Colo.
- Stevens, Edwin A., Mining Engineer, Victor, Colo.
- Stevens, Geo. T., 33 West 33d St., New York City.
- Stewart, Douglas, Mineralogist, Carnegie Museum, Pittsburg, Pa.
- Stokes, Anson Phelps, 47 Cedar St., New York City.
- Taylor, Edward B., Engineering, Pittsburg, Pa.
- Thaw, Benjamin, President Hecla Coke Co., Morewood Place, Pittsburg, Pa.
- Thomas, Dr. George T., Physician, Rogers, Texas.
- Thompson, William, Mining, Metallurgical and Mechanical Engineer, care of Rossland Great Western Mines, Ltd., Rossland, B. C.
- Thorner, John J., Botanist, 1217 Third Ave., Nebraska City, Nebr.
- Vaile, Joel F., Lawyer, Denver, Colo.
- Van Ornum, Prof. John Lane, Professor of Civil Engineering, Washington University, St. Louis, Mo.
- Veeder, Curtis H., Mechanical Engineer, 40 Willard Street, Hartford, Conn.
- Waterhouse, Prof. James S., Professor of Chemistry and Natural Science, Cumberland University, Lebanon, Tenn.
- Weston, Wilbur H., Newburgh, N. Y.
- Wilcox, William W., Inventor and Manufacturer, 187 South Main St., Middletown, Conn.
- Williams, Dr. J. Whitridge, Professor of Obstetrics, Johns Hopkins University, 1128 Cathedral St., Baltimore, Md.
- Wills, J. Lainson, F.C.S., Chief of Laboratories, National Brewers Academy, 133 Midwood St., Brooklyn, N. Y.
- Woodworth, C. W., Assistant Professor of Entomology, Univ. of California, Berkeley, Cal.
- York, Lewis E., Supt. Public Schools, Kingsville, Ohio.

SCIENTIFIC BOOKS.

THE MESOZOIC FLORA OF THE UNITED STATES.\*

THE great activity in paleobotanical research which characterizes the work of the U. S. Geological Survey finds renewed expression in the recently issued 'Status of the Mesozoic Floras of the United States,' by Professor Ward, with the collaboration of Professor W. M. Fontaine, Mr. Atreus Wanner and Dr. F. H. Knowlton. Without attempting a republication of results which have already appeared, the author aims to present a 'succinct account of the progress thus far made in the direction of developing the Mesozoic Floras of the United States,' enumerating for the several formations, geographical areas and special localities the fossil plants that have been found, and also giving a complete bibliography of the work accomplished, with special reference to correlation. Questions of expediency have necessitated a division of the work into two parts. The first of these to which our attention is now directed discusses the Older Mesozoic, while the second part will deal with the Younger Mesozoic or Cretaceous.

The Triassic flora is represented by a description of seventy-six species or forms, of which nineteen are recorded for the first time, and among these latter is to be noted the name of a new genus—*Yorkia*—which has been given by Mr. Wanner and provisionally adopted by Professor Ward to identify a possible grass which is not very clearly defined as such by the figures given, although the latter are very suggestive of a plant of Monocotyledonous type which serves to recall the *Poacites* of Saporta.

The incompleteness of the paleobotanical

\* Ward, Lester F., Status of the Mesozoic Floras of the United States. The Older Mesozoic. Second Annual Report of the U. S. Geol. Surv., 1898-99. Washington, 1900. Pp. 215-430. Plates XXI-CLXXXIX.

record, especially with respect to the earlier periods, and the uncertainty which exists relative to precise limitations as defined by the vegetation, lead the author to treat the American Trias as a geographical unit, between which and any of the recognized European series it has as yet been impossible to establish exact correlation, but it is worthy of remark that not only are the plants of the European Trias most numerous in the uppermost number of the series, *i. e.*, in the transition beds or the Rhetic, but that all the fossil plants of the American Trias have their nearest affinities in Europe, with those of the latter formation.

The principal plant-bearing deposits of the American Trias are to be found in the Connecticut Valley, near Richmond, Virginia, and in North Carolina. They are also extensive in New Mexico and Arizona, extending into Utah, Nevada and Colorado, and probably also into the Indian Territory and Texas. They also appear in California in the well-known beds at Oroville. The Pennsylvania area was very carefully studied by Mr. Wanner, whose material was revised by Professor Fontaine, and for a total of thirty-one species shows Filices 10, Equisetaceæ 1, Cycadaceæ 10, Bennettitaceæ 1, Ginkgoales 1, Coniferæ 7 and Monocotyledons (?) 1.

In the Virginia area the work of Professor Fontaine led Dr. Stur, of the Austrian Geological Survey, to identify many of the species with plants from the European Keuper, whence he concludes that the Trias of Virginia and that of Lunz are of the same age.

The most complete and noteworthy collection of plants from the older Mesozoic is that of Dr. Emmons from North Carolina, deposited in the museum of Williams College, where they were subsequently studied by Professor Fontaine with the result that it was found to contain Filices 10, Equisetaceæ 2, Cycadaceæ 14, Bennettitaceæ 1, Ginkgoales 1, Coniferæ 6 and of doubtful affinity 4, in a total of thirty-eight forms. Comparing this list with that obtained from Pennsylvania, a remarkable correspondence between the representatives of the different families is here noted.

One of the most notable features of the southwestern area is to be found in the very

abundant remains of trees which have become silicified and form the well-known 'Petrified Forest of Arizona.' These remarkably well preserved remains have already been fully described in a special memoir by Professor Ward, and they are now dealt with only so far as is necessary to connect them with the special subject under discussion. The wood has been identified by Knowlton as that of *Arancorioxylon Arizonaicum*.

The Jurassic flora embraces a description of fifty-two species, of which three only are recorded for the first time. About half of these species are embraced in the Oroville flora of California and include Filices 13, Cycadaceæ 10, Ginkgoales 1, Coniferæ 3 and unknown 1; while the remaining twenty-four from the Jurassic of Wyoming represent Cycadaceæ 22, Coniferæ 2.

Of the 28 species in the Oroville flora, only 12 are to be regarded as of definite value in the determination of geological age. Of these *Cladophlebis spectabilis*, *C. argulata*, *C. whitbiensis tenuis* var. *a*; *Thyrsopteris Maakiana*, *Podozamites lanceolatus*, *P. lanceolatus latifolius* and *Pinus Nordenskioldi* were determined by Heer to be characteristic of the Jurassic in a horizon equivalent to the Lower Oolite of Scarborough, whence it becomes of special interest to observe that Seward\* refers to the occurrence of *Cladophlebis whitbiensis*, *Thyrsopteris Maakiana* and *Podozamites lanceolatus*. *Cladophlebis whitbiensis* he now recognizes as properly identical with *Todites Williamsoni* of Brongniart, a species of wide distribution in the Jurassic of Europe, Greenland and Siberia and characteristic of the Yorkshire Oolite. *Thyrsopteris Maakiana* he identifies with *Coniopsis hymenophylloides*, which occurs in the Jurassic of Siberia and also constitutes one of the most characteristic species in the Oolite of the Yorkshire Coast. *Podozamites lanceolatus* has an exceptionally world-wide distribution, and is especially characteristic of the Jurassic strata. The *Pagiophyllum* type of conifer which is highly characteristic of the Jurassic, is represented in the Oroville series by *P. Williamsoni* as the only conifer of importance; while in Europe and China, as also in the

\* 'Catalogue of Mesozoic Plants,' British Museum, 1900.

Yorkshire flora, it is a characteristic element of the lower Oolite.

*Sagenopteris Nilsoniana*, while found in the Oroville flora, is most characteristic of the Rhetie, and it does not occur in the Yorkshire Oolite, where its nearest representative is *S. Phillipsi* of Brongniart. Its reference to the Oroville horizon is regarded by Ward with some doubt, hence it can not be held to have much weight as a factor in determining age.

The author concludes his valuable contribution by a tabular view of the distribution of 188 separate forms of Lower Mesozoic plants, showing their relation to the various North American areas both of the Triassic and Jurassic formations. He thereby gives emphasis to the fact that remarkably few species (three) are common to both formations, while even the majority of these are open to question. A comparison of the flora of the Yorkshire Oolite with the Jurassic of North America shows that with respect to the Filices and the Conifere there is a close correspondence in relative number of representatives, but that in the North American Jurassic there is a pronounced preponderance of the Cycadaceæ. In the latter flora also, both Bryophyta and Equisetales appear to be wanting.

	Inferior Oolite of Yorkshire.	North American Jurassic.
Bryophyta,	1	0
Equisetales,	2	0
Filices,	20	15
Cycadales	23	30
Conifere,	9	7

D. P. PENHALLOW.

MONTREAL, May, 1901.

*Steam-boiler Economy.* A Treatise on the Theory and Practice of Fuel Economy in the Operation of Steam-Boilers. By WILLIAM KENT, A.M., M.E. New York and London, John Wiley & Sons and Chapman & Hall. 1901. Svo. Pp. xiv + 458. Price, \$4.00.

This is a work, by an authority in its field, devoted to the study, theoretical, practical and experimental, of steam-boiler economics. Its author has had a long and varied experience of the most valuable kind in this department of mechanical engineering and in related fields of work, study and research. To this peculiarly

happy practical and theoretical acquaintance with this subject he has added a singularly exceptional talent for the work and an unusually thorough technical preparation for its prosecution. Large experience, as an author and as an editor, and in the preparation of professional reports as expert in this and related matters, has given him the ability to digest, to formulate and to logically plan and execute a piece of technical work of high grade. The outcome of his endeavor is an exceptionally condensed, complete and exact treatise. The author has also confined himself very closely to his restricted title, and the reader will find there precisely what he seeks.

The book is not only well constructed, but it adds to existing knowledge, as presented in the text-books and special treatises as commonly written, some very valuable novelties which have peculiar interest to the professional man and the student. For example, maps are given of the coal-fields of the country and the distribution of the fossil fuels is exhibited clearly; while accompanying tables of composition, very full and officially endorsed, show what variations of quality occur as we pass from the graphitic anthracites of Rhode Island and Massachusetts, across the Pennsylvania beds over the remarkable deposits of West Virginia and into the Alabamian district, or across Ohio, Indiana and Illinois, Tennessee and Kentucky deposits into the regions of the friable fuels of the Rocky Mountains and to the Pacific Coast, with its extensive distribution of lean coals and lignites.

Mr. Kent has constructed some remarkably valuable as well as novel graphic illustrations of the laws connecting composition with efficiency with varying intensities of draught and variations of air-supply, and has done much to reconcile the widely differing conclusions of investigators in this department of scientific research, who are now coming to be numerous and industrious, commensurately with a growing recognition of the importance of the subject. He has given us a larger addition to our systematized knowledge, and has added to our obligations by introducing well-established and new and useful formulas and diagrams, expressing the relations of conditions bearing upon and

determining efficiency. The discussion of 'temperature and fire' is extended and good; that of the problem of smoke prevention, the account of the automatic stoker and the full elaboration of useful algebraic formulas are points of excellence deserving of special mention. The revelation of the effect of varying air-supply with variations of the rate of combustion is new and important as here presented, and the exposition of the value of flue-gas analysis is effected in an excellent fashion.

For a first edition, this seems exceptionally free from typographical or other errors, and it may be taken for granted that later editions will follow from which even these minor defects will be completely pruned.

The book-making is good, and the maps are printed upon a fine grade of paper to insure clearness. Many of the illustrations and nearly all the diagrams are new, and the whole constitutes a work which is likely to have extensive sale among professionals and professional schools. The mathematical work and the discussions of results of boiler-tests, of which the records are presented very fully, will find constant use.

R. H. THURSTON.

*A Reader in Physical Geography.* By RICHARD E. DODGE. New York, Longmans Green & Co. 1900. 12mo. Pp. viii + 237. Price, 70 cents.

It is gratifying to see the new point of view in physical geography coming into our education and our literature. The application of the theory of evolution to all branches of the subject has taken it bodily from the static condition in which it was conceived by our fathers, and reestablished it as a dynamic science, live and growing. There are no longer any 'everlasting hills,' but mountains and vales wax and wane, and record the histories of their mutations in the landscape so legibly that he who runs may read. And man comes on the scene, molded inevitably by the geographic environment in which his lot is cast, and in turn reacts upon that environment in many important ways. This is the outlook Professor Dodge has in his little volume. He has written it for beginners, and his fine quality as an instructor

is in evidence on almost every page. He is very happy in his ability to interpret the principles of land sculpture in the most homely similes. The beginner not only may, he must, relate the new knowledge to what is already well known to him.

The topics treated are, The Continents, The Industries of Men, The Origin of Land Forms, The Great Land Forms, Climate and other important physical features influencing man.

The book is intended as auxiliary reading for beginners in physiography, but it will also make good reading for the laity in other lines, who wish to know the way in which a physiographer looks at his problems.

J. PAUL GOODE.

*Air, Water and Food.* By ELLEN H. RICHARDS and ALPHEUS G. WOODMAN. New York, John Wiley & Sons. Pp. 230. Price \$2.00.

The first portion of the book covers the composition and impurities of air and their relation to human life. The problem of ventilation is dwelt upon, and very proper reference is made to the faulty argument so often advanced that, because carbon dioxide is heavier than air, that therefore the proper method of securing its removal from living rooms is to provide exits for it near the floor. The public forget that the gas, as the sanitarian meets it, is warm, not cold; and that, moreover, the principle of gaseous diffusion has caused a more or less complete mixture of all the gases present in the room.

Chapter IV. gives well stated methods for air analysis.

Some eighty pages are given to the subject of water, its source, properties, relation to health and the methods employed for its examination.

Following the directions for the 'determination' of each item in water analysis, there is found a paragraph entitled 'Notes,' wherein are given in a very acceptable form the sundry hints and cautions so necessary for the guidance of the beginner. An excellent statement is found on page 81, to wit: "The value of a water analysis is in direct proportion to the knowledge and experience of the one who interprets it."

Again, on page 66, "The conclusions are not infallible, but there are enough unavoidable

risks in human life without taking unnecessary ones.'

This is very true. The analyst should ever stand between the public and a questionable supply, and the consumer, rather than the water purveyor, should be given the benefit of any doubt.

The book closes with a consideration of the adulteration and examination of milk, butter, cereals and fermented liquors.

The authors have had so large and varied an experience with the subjects upon which they write, that the excellence of the present contribution to sanitary literature was to have been expected.

WILLIAM P. MASON.

#### BOOKS RECEIVED.

*Qualitative Chemical Analysis.* ALBERT B. PRESCOTT and OTIS C. JOHNSON. New York, D. van Nostrand Co. 1901. Pp. xi + 420.

*Tierleben der Tiefsee.* OSWALD SEELIGER. Leipzig, Wilhelm, Engelmann. 1901. Pp. 49. Mk. 2.

*Monographien aus der Geschichte der Chemie.* Vol. VI. Pt. 2. Christian Friedrich Schönbein, 1799-1868. GEORGE W. A. KAHLBAUM and ED. SCHAER. Leipzig, Barth. 1901. Pp. xii + 331. \$9.30.

*The Induction Motor.* B. A. BEHREND. New York, Electrical World and Engineer. 1901. Pp. 105.

#### SCIENTIFIC JOURNALS AND ARTICLES.

*The Journal of Physical Chemistry*, April. 'On an Improved Method of determining Latent Heat of Evaporation and on the Latent Heat of Evaporation of Pyridin, Acetonitril, Benzozonitril,' by Louis Kahlenberg. Description of an improvement on the Berthelot apparatus for determining the latent heat of evaporation, in which the liquid is boiled by an electrically heated platinum spiral, and the results obtained by its use. 'A Class of Relations between Thermal and Dynamic Coefficients,' by George H. Burrows. 'Minimum Boiling-Points and Vapor Composition, II,' by Morris R. Ebersole. A study of acetone-benzene solution, with a classification of all mixtures of two solvents which have been studied, according to vapor-pressures and boiling points. 'On Clapeyron's Equation,' by Paul Saurel. 'Note on the Fundamental Equations of Multiple Points,' by J. E. Trevor.

In the *American Geologist* for March, S. W. McCauley presents a discussion on the 'Trap Dykes of Georgia.' He states that they are all of the same age, and vary from an inch to two hundred feet in width and extend from a few rods to many miles. The 'Plan of the Earth and its Causes,' by J. W. Gregory, is continued from the February number, in which the writer concludes that the plan of the earth may be attributed to the unceasing shrinkage of its internal mass. Professor E. W. Claypole contributes some interesting notes on 'Petroleum in California.' 'Some Salient Features in the Geology of Arizona' is discussed by William P. Blake. This is followed by 'The Lake Systems of Southern Patagonia.' The author of this article divides the lakes into three classes—residual or salt lakes, glacial and tectonic. The April number contains a valuable contribution to the geology of 'The Piedmont Plateau of Georgia,' by Thomas L. Watson. The rocks of the region are divided into three different kinds, viz., the even-grained, massive granites, the porphyritic granites and the granite-gneisses. Of the even-grained granites, all but two possess biotite as a principal element, while hornblende is entirely wanting; the porphyritic granites are, with one exception, massive, with a composition somewhat similar to the massive granites, and in some places showing a gradation from one to the other; the granite-gneisses form extensive areas of schistose rock, similar in composition to the other two, and are believed to be metamorphosed eruptive granites. The author, after furnishing considerable proof, concludes that the region consists of eruptive granite which has been subject to the action of metamorphism and weathering, thus differentiating into the other two kinds of metamorphic rock. The age of the area is supposed to be Archæan, but it is crossed by numerous dykes of a later origin. Mr. Oscar H. Hershey contributes a paper entitled 'California Metamorphic Formations,' in which he describes the formations of the Klamath mountain region. He concludes that the schists of the upper region are somewhere between the Archæan and Devonian in age, and favors the earlier rather than the later date. This is followed by a paper, 'Fossils near Montreal,'



by Charles Schuchert, in which he describes the fauna of Saint Helena as from the Helderberg and the middle Devonian ages.

#### SOCIETIES AND ACADEMIES.

##### BIOLOGICAL SOCIETY OF WASHINGTON.

THE 340th meeting was held on Saturday evening, May 4th.

T. H. Kearney presented a paper on 'Loeb's Investigations into the Action of Ions upon Animal Structures, as supplemented by Studies with Seedling Plants,' quoting from Loeb's published papers at some length, special stress being laid upon their value as illustrating the theory of the rôle of ion-proteid compounds in vital phenomena. In experiments with animals it was the action of mixed solutions of two or more salts, as compared with that of each salt in a pure solution, which led to the development of this theory. The result of numerous experiments with seedling plants, as to the limit of concentration of solution which permitted the maintenance of vitality, agreed in many important points with the results obtained by Loeb in experiments with animals. In both cases salt solution was found to be highly toxic, while the addition of a second salt in many cases largely neutralized this poisonous effect and notably increased the degree of concentration of the more toxic salt in which root tips could survive during a twenty-four hours' culture.

Experiments were made with salts of magnesium (sulphate, chloride), of sodium (carbonate, sulphate, chloride and bicarbonate) and calcium chloride, all of which are important components of 'alkali' soils in the western United States. In pure solution they proved toxic in the order named, the limit of endurance for magnesium sulphate being approximately a  $\frac{1}{1000}$  normal solution, that of calcium chloride a  $\frac{1}{4}$  normal. Mixtures were made of equal volumes of definite concentration of each two of these readily soluble salts, and of each of them with the comparatively insoluble magnesium carbonate, calcium carbonate and calcium sulphate, which are likewise abundant in the alkali soils.

In several cases addition of a sodium to a

magnesium salt considerably raised the limit of concentration of the latter endurable by the roots of the white lupine (*Lupinus albus*), but the most striking results were obtained by the addition of calcium, either as chloride or sulphate, to magnesium and sodium salt solutions. Calcium sulphate, added in simple excess of the powdered salt, proved extraordinarily efficacious in neutralizing the toxic effects of other bases, increasing the maximum endurable concentration for sodium sulphate from  $\frac{1}{1000}$  to  $\frac{1}{2}$  normal, and for magnesium sulphate from  $\frac{1}{1000}$  to  $\frac{1}{3}$  normal.

In a  $\frac{2}{3}$  or  $\frac{3}{4}$  pure solution of magnesium sulphate the root cells were strongly plasmolyzed, while in a corresponding solution plus an excess of calcium sulphate no trace of the plasmolyzing action could be detected. The effect of calcium sulphate upon the corresponding chlorides was much less marked. Hence, while in some cases the effects of mixtures could be ascribed to the cations (basic radicle) alone, in others it seems clear that the anions are also able to make their influence felt. Hydroxyl ions, dissociated in very dilute solutions of sodium carbonate ( $\text{Na}_2\text{CO}_3$ ), and sodium bicarbonate ( $\text{NaHCO}_3$ ), markedly stimulated the growth of the roots, just as Loeb found them to stimulate the gastrocnemius of frogs, to absorption of water from, and rhythmical contraction in, a sodium-chloride solution.

The results of this investigation, which was undertaken at the request of the Chief of the Bureau of Soils of the Department of Agriculture, are to be described in a forthcoming bulletin of the Division of Vegetable Pathology of that Department. They are believed to have considerable economic significance, apart from their bearing upon the question of the influence of ions upon organisms.

Under the title 'A Kinetic Theory of Evolution,' Mr. O. F. Cook suggested, on the basis of studies in the Diplopoda and other groups, that evolution be interpreted as a kinetic phenomenon or process of gradual and spontaneous accumulation of variation instead of a reaction to external conditions. It was also held that the differentiation of species is a process quite distinct from evolutionary progress, and that selection and isolation may conduce to the

former while retarding the latter. In this view evolution would be favored by interbreeding rather than by segregation, and natural selection would be an incident rather than a cause of evolution. Diversity was shown not to be conditioned upon segregation, but to be distinctly favored in the economy of species. Under a kinetic theory the origination and inheritance of characters represent but different statements of the same facts, and the predication of a 'hereditary mechanism' is unnecessary. Evolution is not confined or directly connected with any one type of cells or method of reproduction; it is not only a cellular or cytoplasmic, but a supracellular or organic, process; evolutionary theories must accommodate both unicellular and compound individuals, and even treat as evolutionary units the colonies of the social insects.

F. A. LUCAS.

#### CHEMICAL SOCIETY OF WASHINGTON.

AN adjourned meeting was held in Hopkins Hall, Johns Hopkins University, Baltimore, Md., on April 27th, when the following program was presented: 'The Lowering of the Freezing Point of Aqueous Hydrogen Dioxide,' by H. C. Jones. The author stated that an attempt was made to measure the dissociating power of hydrogen dioxide by means of the conductivity method. This method was abandoned, since all the metals used as electrodes decomposed the dioxides, even at zero degrees. The lowering of the freezing point of aqueous hydrogen dioxide by certain salts was measured and was found to be less than the lowering of the freezing point of water, under the same conditions.

'The Preparation of Semi-Permeable Membranes for the Demonstration of Osmotic Pressure,' by Professor H. N. Morse. The author referred to the difficulties encountered in the preparation of osmotic cells by the method of Pfeffer, and stated the results of some preliminary experiments, undertaken in cooperation with Dr. D. W. Horn, in attempting to overcome these difficulties. Instead of expelling the air from the walls of the cups by immersion in water and exhaustion with an air-pump, as is done in the method of Pfeffer, electrical endo-

mose was employed, the cup being immersed nearly to the top and filled with a dilute solution of potassium sulphate, then surrounded by a cylindrical electrode and another one placed inside. A one-ampere current was passed through the solution for 15 minutes, from the outer to the inner electrode, causing a rapid passage of liquid through the walls of the cup and freeing them from air. The cup was then removed, emptied, rinsed and placed in water until used for the formation of membrane. The method described by the author was as follows: A cup whose walls had been freed from air and filled with water was placed in a solution of a copper salt and filled with a solution of ferrocyanide. A current was passed from the outside inward, the copper and ferrocyanogen ions being driven into the walls from opposite directions; a membrane was built up wherever they met. The results were very satisfactory. The method of construction of the electrodes was described and the resistance of the cups stated. On breaking the cup, the membrane was found as a reddish brown line, usually in the middle of the wall, though deviating more or less to one side or the other.

'Molecular Rearrangement of Sulphamine Acids,' by Dr. Ira Remsen.

'On a Reduction Process for Tin at Comparative Low Temperatures, and Recovery from Waste Products,' by Chas. Glaser. This paper gave a description of a process invented by John C. Toliaferro for the recovery of tin from waste products. The refuse from tin-plate works consists of the remnants of the fatty acids used to protect the black plates from reoxidation after cleaning with acid, and more or less oxidized tin, which often contains some free metal or mixed oxides of tin and lead. The refuse from the oils often contains oxides of the two metals, which are usually recovered by burning off the oil and collecting the residue and metallic fumes. The united dross is reduced to metal in a suitable furnace. Mr. Toliaferro observed that under certain conditions he obtained metallic tin from the refuse fatty acids by heating them to incipient decomposition. Certain experiments were made showing that at a temperature a little above the melting point of tin, stannous soaps are reduced to metallic tin,

gaseous products and some carbon. From these observations the following reduction process was evolved: A large iron pot is heated from below, so that a piece of tin dropped at the bottom will melt. The pot is then filled with refuse fatty acids and the heat increased until they commence to give off vapors. Stannic dross is then introduced with stirring. This may be continued at pleasure or until the fatty acid is almost used up. The reduced tin is removed at convenient intervals.

'On Dr. Theodore Meyer's Tangent System of Sulphuric Acid Chambers,' by Chas. Glaser. The author described a modification of the construction and working of lead chambers used in the manufacture of sulphuric acid. The modification relates to the shape of the chambers and the motion of the gases. Ordinarily the chambers are square and the gases introduced in such a way that they traverse the chambers but once, get only moderate mixing, except where they fall upon the chamber curtains and where they are forced through relatively narrow connecting pipes between chambers. In the modification described, the chambers are round or polygonal, the gases are introduced near the ceiling in the direction of a tangent, and are removed through the center of the bottom by suitably constructed pipes. Experiments show that the gases move first along the sides of the chamber, drifting towards the center in such a way that the whole content gets into rotation. Cooling and draught bring the whirlpool in the center to the exit pipe. When introduced into the second chamber, the gases retain the revolving motion derived from the first, to which is added the motion of the second, so that an epicycloid motion is produced. The gases traverse the chambers a good many times, increasing largely the amount of work performed. It has been demonstrated that by this method the necessary chamber space for one pound of sulphur in twenty-four hours, is reduced to below ten cubic feet as against twenty in the old system. The author stated that the cost of producing sulphuric acid, so far as labor and lead chambers are concerned, is reduced to fifty per cent. of what it was by the old method.

'The Solubility of Gypsum in Aqueous Solu-

tion of certain Electrolytes,' by Frank K. Cameron and Atherton Seidell.

This paper gave a description of the complete solubility curves for gypsum in aqueous solutions of sodium chloride, magnesium chloride, calcium chloride, sodium sulphate and a mixture of sodium chloride and calcium hydrogen carbonate at 25° C. With sodium chloride and magnesium chloride the curves show maximum points. The formation of complex ions the authors believe to be possible and probable, but the deviations from the *mass law* are more likely to be due to a condensation of the solvent itself.

With sodium sulphate it was shown that the solubility of the gypsum first decreased and then increased, with increasing concentration of the more soluble salt, until it became greater than in pure water. It is believed that a double salt was formed in the solutions, possibly identical with the mineral glauberite. It did not separate from the solutions on evaporation, however, at ordinary temperatures. Here again the authors think the condensation of the solvent probably plays an important rôle and, under such circumstances, it is probable that the sodium sulphate dissociates to a large extent or completely as a di-ionic electrolyte. The composition of the solid phase, containing both calcium sulphate and sodium sulphate, did not apparently affect the composition of the solution in contact with it. This is regarded as of sufficient interest to merit further investigation. In solutions of calcium chloride the solubility of the gypsum decreases quite rapidly at first, and then very slowly but steadily as the concentration of the more soluble salt increases.

When calcium carbonate in the solid phase was also in contact with solutions of sodium chloride, and was brought to equilibrium with ordinary air, it was found that up to concentrations of about 80 grams per liter of sodium chloride, the gypsum dissolved in very nearly the same quantities as though the calcium carbonate were not present. From this point on, however, the curve makes a sudden drop and then the solubility of the gypsum slowly decreases.

Applications of the results to geological and technical studies were indicated, and a theoretic-

cal discussion accompanied the description of the experiments.

'The Solubility of Calcium Carbonate in Aqueous Solutions of certain Electrolytes and in Equilibrium with Air,' by Frank K. Cameron and Atherton Seidell :

Since the solubility of the calcium carbonate is dependent upon the amount of carbon dioxide in the gas phase in contact with the solution, the solutions were brought to equilibrium with air, previously washed in dilute sulphuric acid, and bubbled through the solutions by means of an aspirator. It was found that the curve for sodium chloride presented a well-marked maximum point. No normal carbonates were in the solution, the calcium dissolving entirely as the hydrogen carbon.

In sodium sulphate solutions, the major part of the calcium dissolved as the hydrogen carbonate, though at the higher concentrations normal carbonates were also found. The curve for this pair of electrolytes showed no maximum point. Curiously, it was found that calcium carbonate was much more soluble in solutions of sodium sulphate than in solutions of sodium chloride, at all concentrations.

The presence of solid gypsum was found to produce an effect on the solubility of calcium carbonate in sodium chloride solutions, greater in amount but similar in nature to that produced by calcium carbonate on the solubility of the gypsum in sodium chloride solutions, and described in the preceding paper. Practical applications of the work were pointed out and a theoretical discussion of the results obtained was given.

L. S. MUNSON,  
*Secretary.*

#### TORREY BOTANICAL CLUB.

AT the meeting of the Club on March 27, 1901, the first paper of the evening was by Dr. John K. Small on 'The North American Genera of Mimosaceæ.' Dr. Small exhibited a uniform series of diagrammatic drawings, illustrating the flowers and fruit of each of these genera, and explained his proposed classification, replacing the previous artificial grouping. The variability of the fruit in valves, margins and cross-partitions was commented on. Dis-

ussion of the common sensitive plant followed, in which it was remarked that the sensitiveness to shock is so delicate as to be stimulated by holding a burning-glass near, or by drops of rain-water on first falling, or by holding a sponge of ammonia or of chloroform near. The utility seems unknown, except as the hot sun setting the leaves on edge prevents injury from intense sunlight. Sachs's suggestion was that the depression of the leaves served as a protection from hail; but it now appears that the native center of the plant is chiefly in the Orinoco regions where hailstorms are unknown. Much energy is exhausted by folding, and it is well known that the greenhouse sensitive-plants are frequently worked to death by repeated irritation.

The second paper, by Dr. Rydberg, soon to be printed, was on 'The Oaks of the Rocky Mountains,' in which region eleven species were described in Sargent's 'Silva,' a number now increased by Dr. Rydberg to twenty-eight.

E. S. BURGESS,  
*Secretary.*

#### THE ONONDAGA ACADEMY OF SCIENCE.

THE 47th regular meeting was held in the Historical rooms, Friday P. M., May 17, 1901.

The first paper was by Dr. John Van Duyn, entitled, 'The Terrestrial Life of Porto Rico.' Dr. Van Duyn spoke entertainingly concerning many facts and observations made during his recent visit, as the deep blue of the ocean, the appearance of different constellations, the character of the rocks and their probable formation, the differences in wind and climate of the northern and southern shores of the island, the animal and plant forms, and the inhabitants. The latter are a mixture of Spaniard, negro and native Indian. Although it has been maintained by high authority that the Indian types have been entirely lost, Dr. Van Duyn was positive that this was not so. He believes that the race possesses vast capabilities for development.

A second paper, entitled 'The Marine Life of Porto Rico,' was given by Dr. C. W. Hargitt, of Syracuse University. He briefly narrated the early work in the natural history of Porto Rico and then told of the recent expedition of the *Fish Hawk* to those waters, and of the

material thus collected. The fishes have already been described in the Report of the U. S. Fish Commission just published; and of the other forms which were sent to the various universities for examination and study, Dr. Hargitt reported on the material received here. The collection comprises the 'Alcyonaria,' and among the forms were several genera new to American waters, and six species new to science. The descriptions of all these will be published in the Reports of the Fish Commission during the present summer.

PHILIP F. SCHNEIDER.

#### DISCUSSION AND CORRESPONDENCE.

##### THE LARYNX AS AN INSTRUMENT OF MUSIC.

In the *American Journal of Science* for April, 1901, Vol. XI., p. 302, an account was given of some speech curves that confirm the view that vowels are usually produced by intermittent puffs of air and not by vibrations of the form generally supposed. The following conclusions were reached: (1) The movement of the air in the mouth cavity is a free vibration and not a forced one; (2) the impulses from the larynx in making vowels are of the nature of explosive openings or sharp puffs of air. It was shown that the characteristic mouth tones in vowels are generally inharmonic to the larynx tone. The elaborate vowel tracings of Professor Hermann (Königsberg) and the late ones of Dr. Pipping (Helsingfors) had already proved that in song the mouth does not reinforce an overtone of the cord; my curves showed the same condition for ordinary speech. Similar results have been obtained by Boeke (Alkmaar), Bevier (New Brunswick), Donders (Utrecht), Merritt (Cornell), Samojloff (Moscow), and others, and can be seen in plates published by Nichols and Merritt (Cornell). The proof is on all sides complete and incontestable that Willis's theory ('Camb. Philos. Trans.,' 1830) of vowel formation is the correct one and that the theory of Wheatstone ('Lond. and Westm. Rev.,' 1837) is erroneous. Although the adoption of the Wheatstone theory led to numerous investigations and secondary hypotheses by Grassmann, Helmholtz and others, its phonetic difficulties were never overcome.

It was also pointed out that the structure of the larynx practically forbids any consideration of the vocal bands as membranous reeds. The accompanying figure is an outline section of the



vocal muscles (*aa*) whose vibrations produce the tone in song and speech. They bear no resemblance in structure or action to membranous reeds. When they are brought together by the action of the arytenoid cartilages, they close the passage of the larynx until forced apart by the air pressure. When this occurs a puff of air is emitted and they close again. The sharpness or smoothness of the puff is regulated by the contraction of the various portions of the thyro-arytenoid muscles which compose the vocal bands. The puffs in their physical forms resemble those that can be produced by a siren disk with differently shaped openings (Seebeck).

Structures of the nature of the vocal bands yield to the air pressure and vibrate wholly or mainly by a side movement, and not by the flap or lateral movement of membranous reeds. Professor Ewald (Strassburg) has illustrated their action by constructing cushion pipes. That the vibratory movement affects the bands through most of their depth is shown by the nodal lines seen with the laryngo-stroboscope of Oertel (Munich). Helmholtz's statement: "Im Kehlkofe spielen die elastischen Stimmbänder die Rolle membranöser Zungen. Sie sind von vorn nach hinten gespannt, ähnlich den Kautschukbänderu \* \* \*," was based on the anatomical and physiological knowledge of the time at which he wrote the first edition of the 'Tonempfindungen.'

Professor Le Conte (California) in *SCIENCE* for May 17, N. S., Vol. XIII., p. 790, points out that he had already said that the larynx 'cannot be likened to a stringed instrument nor

to a reed-pipe,' and suggests the resemblance between the vocal band action and the lip action in blowing a horn. Whether the lips in blowing a horn vibrate laterally as reeds or by compression as cushions, I am unable to say; they may quite possibly vibrate in a manner different from that assumed by Helmholtz.\*

E. W. SCRIPTURE.

YALE UNIVERSITY,  
NEW HAVEN, CONN.

#### PHYSIOLOGY IN THE SCHOOLS.

TO THE EDITOR OF SCIENCE: Judging from the letter of S. W. Williston in your issue of May 24th, people must acquire their mental growth much more rapidly in Kansas than they do in the East. If I were confronted in an examination for the degree of doctor of philosophy with the question 'Why does the human body cease to grow about the twenty-fifth year?' I should think there were strong grounds for suspecting the examiner of endeavoring to show what I did not know, even at the price of asking questions whose answers I could not know. Yet we are told that this question has been asked of candidates for the State teacher's certificate. The theory of accelerated mental development is furthermore strongly supported by the apparent fact that children are expected, by the time they finish with the grammar school, to know about pleurisy, the respiratory center, residual air, appendicitis, *meatus auditorius* and the *motores oculi*.

If mental development is anywhere as rapid as these facts would suggest, there can, of course, be no criticism with regard to the con-

\* Misunderstanding the point under discussion and supposing that Professor Le Conte was speaking of lateral vibrations of the lips and vocal cords, Professor Webster (Clark Univ.), replies to him in SCIENCE for May 24, N. S., Vol. XIII, p. 827, that the action of the lips and the vocal cords had already been explained by Helmholtz and that his description of 1862 'has never needed any improvement or correction.' Professor Webster asserts that he regards the simple model of a membranous reed pipe with a sheet of rubber in lateral vibration as 'a very convincing demonstration of the mode of action of the larynx.' He also classifies elastic cushions as 'reeds.'

sideration of these questions in physiology at the time indicated.

If, however, children generally show about the same rate of mental development as I have observed in the East, the writer would like to suggest that if less time were consumed in the contemplation of useless details of anatomy, relieved by worse than useless rambles into pathology, and more in the plain, common sense, practical study of the conditions of healthy living, teachers would no longer learn in examination papers that 'the body should be bathed frequently, should be bathed at least once a year.' There is, in fact, a horrible suspicion in the mind of the writer that something else than the text-book is at fault.

THEODORE HOUGH.

MASSACHUSETTS INSTITUTE OF TECHNOLOGY,  
May 25, 1901.

#### SHORTER ARTICLES.

##### THE GENERAL EQUATIONS OF ROTATION OF A RIGID BODY.

AFTER writing my brief note on the top,\* it occurred to me that the same method might be

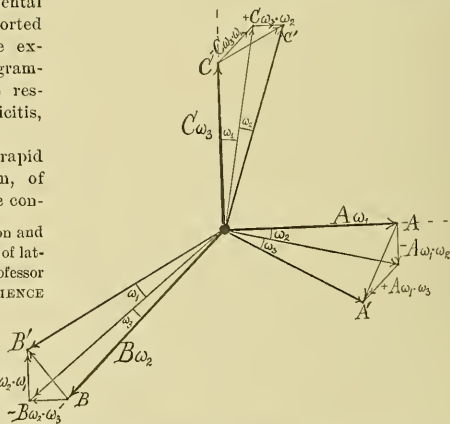

used to derive the Eulerian equations of rotation briefly and at once, in a way almost pic-

\* This Journal, May 31, 1901.

torially lucid as to the meaning of the terms involved.

Let  $A, B, C$ , be the principal axes of inertia and  $\omega_1, \omega_2, \omega_3$ , the angular velocities of the rigid body around them. All this is kinematic.

Let  $A', B', C'$ , be the positions of these axes a unit of time later. Lay off the angular momenta,  $A\omega_1, B\omega_2, C\omega_3$ , along these axes in order, as shown. Then will  $AA', BB', CC'$ , be the corresponding per second changes of angular momentum.

Resolve each of these into components parallel to the original axes, and bring those belonging to the same axis together, viz.,

$$\begin{array}{ccc} -B\omega_2\omega_3, & -C\omega_3\omega_1, & -A\omega_1\omega_2, \\ +C\omega_3\omega_2, & +A\omega_1\omega_3, & +B\omega_2\omega_1, \end{array}$$

remembering that as each axis rotates about the other two, the component displacements per second will be

$$\omega_2, \omega_3; \omega_3, \omega_1; \omega_1, \omega_2.$$

Add to the component changes of momentum found, the direct per second changes of angular momentum around the respective axes, viz.,

$$+A\dot{\omega}_1, \quad +B\dot{\omega}_2, \quad +C\dot{\omega}_3.$$

Let  $L, M, N$ , be the torques around the three axes in order, and equate these to the total per second change of angular momentum corresponding to the same axes. In other words, after adding each of the three columns,

$$\begin{aligned} L &= A\dot{\omega}_1 - (B-C)\omega_2\omega_3, \\ M &= B\dot{\omega}_2 - (C-A)\omega_3\omega_1, \\ N &= C\dot{\omega}_3 - (A-B)\omega_1\omega_2. \end{aligned}$$

C. BARUS.

#### ON A CRINOIDAL HORIZON IN THE UPPER CARBONIFEROUS.

FOR more than half a century the Lower Carboniferous limestones of the Mississippi valley have been justly celebrated for their enormous wealth of crinoidal remains. On this account, they have become widely designated as Encrinital limestones, a title which has long since assumed a distinctive value.

The crinoidal element in the faunas of the Lower Carboniferous has been further emphasized by the apparent extreme paucity or entire absence of crinoid remains in all other parts of the Carboniferous section of the region. The

few species described were few in number, from widely separated localities and from very fragmentary material.

Unusual interest was, therefore, aroused a few years ago by the discovery, in the Upper Carboniferous rocks of the Missouri river, of a formation so rich in fossil crinoids as to merit the title Encrinital as appropriately as any terrane of the Lower Carboniferous. Species were not only new and numerous, but individuals occurred in the utmost profusion, their stems and long, slender, beautifully pinnulated arms intertwining as intricately as the richest of flowing arabesques. Moreover, the state of preservation was wondrously perfect. From a morphological standpoint the discovery was one of the most important ever made.

The geological position of this rich crinoid fauna is a short distance above what is called the Lower Coal Measures. It is in the terrane now known as the Thayer shales, the base of which is a stratigraphic level not much over 600 feet above the Lower Carboniferous limestones. The Thayer shales are in the lower part of the Missourian series. They are dark-blue in color, and lithologically are indistinguishable from the Crawfordsville Shales of Indiana, which have been so prolific in crinoids in fine state of preservation.

The biological peculiarities of the crinoids from the Thayer shales as compared with those of the nearest forms from the Lower Carboniferous are noteworthy features. For two faunas so closely conjoined in space the differences are so profound when apposed to the resemblances as to be almost inexplicable.

But a satisfactory solution of the remarkable problem has been lately supplied from a source other than the biotic. The recently worked-out stratigraphy of the region throws light upon it in an unsuspected manner. The actual position of the Thayer shales, instead of being removed only 600 feet from the Lower Carboniferous limestones, are, stratigraphically, thousands of feet away.

While the lower coal measures have long been known to rest unconformably upon the underlying rocks, the stratigraphic break has been regarded as merely local in nature. Of late, the real significance of this hiatus has been

adjudged. A depositional equivalent has been found in a neighboring State. In central Arkansas, the unconformity is now discovered to be represented by no less than 20,000 feet of sediments. The real values of the new relationships of the horizons are better shown by a rectified general geological section of the Carboniferous of the region.

## WESTERN INTERIOR SECTION.

Series.	Terrane.	Thickness.
Oklahoman.	Not here differentiated.	1,500
	Cottonwood limestone.	10
	Atchison shales.	500
	Forbes limestones.	25
	Platte shales.	105
Missourian.	Plattsburgh limestones.	30
	Lawrence shales.	265
	Stanton limestones.	35
	Parkville shales.	75
	Iola limestone.	30
	Thayer shales.	50
	Bethany limestones.	75
Des Moines.	Marais des Cygnes shales.	250
	Henrietta limestones.	50
	Cherokee shales.	200
Arkansan.	Not here differentiated.	20,000
Mississippian.	Not here differentiated.	1,500

Of these five series of the Carboniferous system, the Oklahoman represents the so-called Permian; the next three the coal measures; and the Mississippian the Lower Carboniferous. Measured in sediments, the horizon of the Thayer crinoids is far up in the Carboniferous, instead of being near the base. At Kansas City, where the crinoids were found, the Arkansan is represented by the hiatus—a period of vast erosion in that locality.

CHARLES R. KEYES.

## THE PROCESS OF FREEZING IN PLANTS.

IN text-books on plant physiology, and in original articles upon the effects of freezing in plants, or on allied subjects, so far as is known to the writer, there is no working explanation of the process. The matter is referred to by Detmer and Moor, Vines, Haberlandt, Sorauer, Sachs and many others, but without detailed explanation.

The cells bounding the intercellular spaces (in leaves) are always moist on the side in con-

tact with the air. As cooling goes on, all the tissue, contents of the cells and all, are contracting; but when a temperature of about 4° C. is reached, the water content of the cell begins to expand, while the wall goes on contracting. This forces more moisture into the intercellular spaces. When the freezing point for water is reached, ice crystals begin to form outside of the cell in the intercellular spaces. The ice crystals will form first here, because water has a higher freezing point than the solution within the cell. As cooling goes on, and further crystallization takes place, the freezing water gives off its latent heat which tends to keep, for a considerable time, the cell contents from freezing. The crystallizing water without the cell extracts water from the cell by an inherent attractive force which the molecules of the mother crystal have for its liquid. This force is the cause of further water being drawn from the cell to build up the crystal of ice, and this attractive force is a similar one to that which causes plasmolysis in the case of the common experiment with cells of *Spirogyra* and a solution of sodium chloride. The ice forms first in the intercellular spaces and continues to form there until the cell contents become frozen.

If a leaf so frozen be subjected to a higher temperature, water will be formed in the intercellular spaces, resulting in a translucent, 'water-logged' appearance of the tissue of the leaf. If, however, the temperature be raised very gradually, the cells will probably resorb the extracted water as rapidly as it is formed, resulting in no permanent injury to the leaf. Sachs found that the leaves of the beet and the cabbage frozen at from -4° C. to -6° C., and thawed in air at 2 to 3° C., were killed, while when thawed slowly in water at 0° C. they survived.

If the temperature be low enough and be continued long enough a permanent injury would result, for then the cell contents would become solidified.

In the case of the experiment with a beet partially scooped out and subjected to a freezing temperature, the formation of ice in the cavity is brought about in exactly the same way as it is in the intercellular spaces in leaves of plants, excepting on a larger scale. If the



freezing of the beet be brought about slowly, water may be drawn into the cavity from a considerable distance from cell to cell within the tissue.

Certain strong non-poisonous solutions, when applied to the cut ends of the petioles of leaves, produce a similar translucent effect in the tissue of the blades of leaves, as is shown by the writer in a paper now in process of publication.

JAMES B. DANDENO.

BOTANICAL MUSEUM OF HARVARD UNIVERSITY, May 22, 1901.

#### THE AMERICAN MATHEMATICAL SOCIETY.

A PRELIMINARY circular, which has just appeared, describes the arrangements which have been made for the summer session of the American Mathematical Society to be held at Cornell University, Ithaca, N. Y., during the week beginning on August 19th. The meeting proper, for the transaction of business and the presentation of papers, will take place on the first two days, while the remainder of the week will be occupied by a colloquium. Two courses of lectures by Professor Oskar Bolza, of the University of Chicago, and Professor E. W. Brown, of Haverford College, are announced as the basis for this colloquium, which will be the third organized by the society in connection with its summer meetings. Professor Bolza's subject is 'The calculus of variations, in particular Weierstrass's discoveries.' The principal object of the course is to give a detailed account of the solution of the simplest type of problems, in its historical development, with special emphasis upon the contributions of Weierstrass and his followers. A summary review of the peculiar features of the more general problems is also intended. Professor Brown will lecture on 'Modern methods of treating dynamical problems and in particular the problem of three bodies.' The object of this course is to set forth some of the later attempts to introduce more rigor into the methods of solving dynamical problems, mainly the researches of Poincaré. The course will be chiefly descriptive, in showing the principles of the methods, the mathematical difficulties which arise, and the results which have been obtained. Among the subjects treated will be the following: the

various forms of the differential equations of dynamics, the existence of integrals, solutions by infinite series, periodic solutions, stability and instability. In neither course will special knowledge of the subject be presupposed.

#### SCIENTIFIC NOTES AND NEWS.

DR. IRA REMSEN, professor of chemistry in the Johns Hopkins University since its foundation in 1876, has been elected president of the University.

A COMMITTEE, consisting of Professors Ira Remsen, J. S. Ames and W. H. Welch, has been appointed at the Johns Hopkins University to arrange a memorial to the late Professor Henry A. Rowland.

M. LAVERAN, the French army surgeon who discovered the malaria parasite, has been elected a member of the Paris Academy of Sciences in the section of medicine, filling the vacancy caused by the death of M. Potain. In the third ballot M. Laveran received forty, and M. Ch. Richet twenty-six, votes.

At a recent meeting of the National Geographic Society, the by-laws were so changed as to merge into the single class of 'members' the two classes hitherto designated 'resident members' and 'non resident members,' and also to increase the board of managers from 18 to 24, including six not resident in the District of Columbia. The board has now been completed by the election of the following non-resident members: Professor William M. Davis, Cambridge; Mr. Russell Hinman, New York; Professor Angelo Heilprin, Philadelphia; Dr. Daniel C. Gilman, Baltimore; Professor Rollin D. Salisbury, Chicago, and Professor George Davidson, San Francisco.

DR. G. A. HANSEN, of Bergen, the discoverer of the bacillus of leprosy, will celebrate his sixtieth birthday in July, and it is proposed to present him with an international testimonial made up of small subscriptions. These may be sent to Dr. Sandberg, Bergen.

PROFESSOR EDWARD F. MORLEY, of Adelbert College, has been appointed a delegate from the United States to the International Conference of Weights and Measures, which is to be held in Paris during September.

DR. WARREN P. LOMBARD, professor of physiology in the University of Michigan, will spend the summer abroad and will attend the International Physiological Congress to be held in Turin in September.

DR. FRANZ BOAS, professor of anthropology in Columbia University and curator of ethnology in the American Museum of Natural History, has been appointed philologist in the Bureau of American Ethnology. The appointment is an honorary one, and Dr. Boas will direct the work from New York City.

PROFESSOR WILLIAM JAMES offers a course next year at Harvard University on 'The Psychological Elements of Religious Life,' based on the Gifford lectures now being given at Edinburgh.

DR. T. C. HOPKINS, professor of geology at Syracuse University, will work on the geological survey of Indiana during the summer vacation. An attempt will be made to complete the work for a new edition of the geological map of Indiana.

The Carnegie Museum has despatched Mr. W. E. C. Todd, custodian of the collections in ornithology, Dr. D. A. Atkinson and Mr. George Mellor to the Maritime Provinces and Newfoundland to make natural history collections for the museum during the coming summer. Professor J. B. Hatcher is engaged in taking up fossils at Cañon City, Colorado, Mr. O. A. Peterson is continuing the work begun by Professor Hatcher in western Nebraska last year, and the quarry at Camp Carnegie, on Sheep Creek, Wyoming will be worked during the coming summer by a party under Mr. C. W. Gilmore.

PROFESSOR C. L. BRISTOL, of New York University, left New York on June 1 to direct the Biological Station at Bermuda.

THE house boat *Megalops* of the Zoological Survey of Minnesota, under the direction of Professor Nachtrieb, has been hauled ashore near the head of Lake Pepin, a few miles below Red Wing, where it will be used as station headquarters. A gasoline launch has been purchased for this station, and, in line with the plan begun with the rowboat *Zosa*, has been called *Callinectes*. There is also to be constructed a boat

specially adapted for dredging and similar work. This boat will be called *Branchippus*. Professor Nachtrieb will send a party of four into the Lake Vermillion region and the N.E. corner of Minnesota. A party of two will conduct special investigations in the Lake of the Woods, and another will carry on work at the Lake Pepin station.

SIR COURTENAY BOYLE, permanent secretary of the Board of Trade, died in London on May 19. Sir Courtenay had in various official positions contributed much to the applications of science especially as supervised by the government.

MR. E. W. PARSONÉ died in London on May 20. He was interested in submarine telegraphy and had done scientific work in connection with the transit of Venus and in other directions.

MR. ANTHONY WILKIN died at Cairo on May 17. Although only twenty-four years of age, he had accomplished good work in several scientific expeditions. He was a member of the Cambridge anthropological expedition to Torres Straits, and had carried on archeological work in Egypt with Professor Flinders Petrie.

IT is announced that Mr. John D. Rockefeller has given \$200,000 for the foundation of an institute for medical research, and it is understood that this fund will be increased as needed. We lack in America an institution corresponding to the Pasteur Institute in Paris or the institution in London recently endowed by Lord Iveagh. It appears that this need will be met by Mr. Rockefeller's gift, though the exact scope of the institution is still under consideration.

It is said that Mr. Alfred Harmsworth has subscribed \$50,000 toward an institute in London for the cure of lupus by exposure to light.

THE U. S. Civil Service Commission announces that owing to lack of applicants the examination, announced to be held on June 3, for the position of secretary of the National Bureau of Standards, Treasury Department, has been postponed to June 22, and will be held in any city in the United States where postal free delivery has been established. The duties of this position are those of general sec-

retary to a scientific or technical bureau and include the handling of the general correspondence of the Bureau and the editing of bulletins and reports. The occupant of this position will also act as purchasing agent and have charge of the official records, apparatus and equipment, and will be executive officer of the Bureau. The examination will consist of the subjects mentioned below which will be weighted as follows:

1. Stenography and typewriting..... 20
2. Editing and proofreading (practical tests)..... 10
3. Education and training..... 20
4. General experience in editorial and executive or business capacities..... 50

The test in typewriting will comprise practical work in tabulating and copying and spacing. Some knowledge of stenography will be required. Applicants for this position should possess a knowledge of elementary physics, chemistry and mathematics, such as prescribed in the general science course of any college or technical school. No person will be examined who has not had a liberal college education or its equivalent. From the eligibles resulting from this examination it is expected that certification will be made to the position of secretary of the National Bureau of Standards, Treasury Department, at a salary of \$2,000 per annum.

A CIVIL service examination will be held on July 2d and 3d to fill the position of photographer in the Division of Forestry, U. S. Department of Agriculture, with a salary of \$1,200. The examination is on photographic methods, and does not require a knowledge of botany or of forestry.

THE American Academy of Medicine and the American Medical Association are meeting at St. Paul during the present week.

THE American Forestry Association will hold its meeting in affiliation with the American Association at Denver on August 27, 28 and 29.

THE Royal Geographical Society held its anniversary meeting on May 20. Sir Clements Markham, the president, in his address, laid special stress on the British Antarctic Expedition. He said that toward sending a special

ship in November, 1902, the sum of £5,500 had been subscribed toward the £15,000 required. The medals were conferred in accordance with the announcements we have already made, Dr. A. Donaldson Smith being present to receive the patron's medal. It was announced that the total number of fellows is 3,997, and the income last year was over £10,000.

THE British Institution of Mechanical Engineers held its annual conversazione on May 17. The annual meeting of the institution will be held at Barrow in Furness during the last week in July.

Owing to an accident connected with the apparatus for adjusting the propeller, the steamship *Discovery*, of the British National Antarctic Expedition has been unable to leave Dundee for London at the time expected.

PROFESSOR H. H. GIGLIOLI, of the Royal Zoological Museum, Florence, writes to *Nature* that on April 13th the second annual meeting of the Zoological Union of Italy concluded its work at Naples. This Union was formed at Pavia last year and in the following September it held its first general meeting at Bologna, which proved to be quite a success as to the work performed and the large attendance. It became evident that the Union, the scope of which is to collect the scattered forces of students of zoology and to prepare the way for the foundation of a zoological journal worthy of Italian science, has responded to a wish generally felt in Italy. The Union now counts amongst its members nearly all the Italian professors of zoology and anatomy and many other students of those sciences. The meeting at Naples was even more numerous than that at Bologna, and many interesting communications were read. Bologna greeted the assembled zoologists with the memories of its old masters—Aldrovandi, Malpighi, Alessandrino and others; at Naples they were *féted* by that great center of zoological investigations, the Zoological Station, whose steam-launch, which bears the glorious name of *Johannes Müller*, gave the visitors practical examples of pelagic trawling and dredging, as the war steamer *Ercole* bore them to Capri. Rome has been chosen for the third Congress, in 1902, 'when,' remarks Professor Giglioli, 'we shall be proud

and happy to welcome any of our foreign colleagues who should choose to honor us with their presence.'

#### UNIVERSITY AND EDUCATIONAL NEWS.

HAMLIN UNIVERSITY, at St. Paul, Minn., has received a fund of \$100,000 of which \$50,000 is from Mr. James J. Hill and \$30,000 from Mr. M. G. Norton.

AN Edinburgh correspondent telegraphs to the London *Times* that the details of the scheme already announced of Mr. Andrew Carnegie's great benefaction to his native land appear to have been only partial, and much misconception has been created and adverse criticism made owing to the absence of the full facts. It appears that an understanding was come to by those to whom Mr. Carnegie has already sketched an outline of his scheme that no communication should be made regarding it until the matter had assumed definite shape. This understanding has been violated, and the unfortunate result is that a very misleading, because partial, account of the scope of Mr. Carnegie's munificent gift has been published. Mr. Carnegie has in view a much wider scheme of benefiting Scottish education than that of making education free to Scottish university students. In a few days Scotland will be in possession of the full facts. In the meantime the outline published has given much needless alarm as regards the extra-mural schools. The scheme will amply provide for extra-mural schools, and every boy and every girl who enters a Board school will, if the ability be shown, rise to the highest seat of learning without the payment of a single farthing in fees. Not only will the amplest provision be found to be made to open the gates of knowledge, but also to raise the universities of Scotland to the foremost rank.

It will be remembered that Yale University has recently abolished required studies in the Sophomore year, and that students may now choose either five or six of twelve subjects that are offered. The elections for next year are as follows: English, 253; history, 216; physics, 194; chemistry, 194; German, 162; French, 155; Latin, 131; mathematics, 112; Greek, 110; mental science, 45; philosophy, 7; analytical geometry, 6.

AT the recent commencement of the Medical Department of the Western University of Pennsylvania, seventy-five diplomas were granted to men who had completed the course of four years in medicine which is required. The Medical Department is engaged in a struggle to resist the encroachment of purely political influence in the appointment of the surgeons and physicians on the staff of the Western Pennsylvania hospital with which the college stands related. The contest is awakening general interest throughout the State.

THE Japanese university for women in the suburbs of Tokio was opened with appropriate ceremonies on April 21.

THE council of the University of Birmingham is prepared to appoint a professor in the proposed faculty of commerce with a salary of £750.

REV. JAMES G. K. McCLURE, D.D., for the last four years president of Lake Forest University, has handed his resignation to the board of trustees, and Rev. Richard D. Harlau, of Rochester, N. Y., has been elected to the presidency. Dr. McClure only intended to hold the presidency for a short period and had retained the pastorate of the Lake Forest Presbyterian Church.

AT Bryn Mawr College, Dr. Elinor P. Kohler has been promoted to be professor of chemistry and Dr. Allerton Seward Cushman has resigned the associateship in chemistry. Miss Harriet Brooks has been appointed resident fellow in physics and Miss Marie Reimer resident fellow in chemistry.

H. C. HASLAM, M.A., M.B., B.C., of Gonville and Caius College, has been elected to a John Lucas Walker studentship in pathology at Cambridge University. Dr. Sladen, who received permission to leave his work in Cambridge to join his mobilized militia battalion for service in Ashanti, and who has now returned, has been reinstated as a second student.

PROFESSOR ALFRED NEWTON, who holds the chair of zoology and comparative anatomy at Cambridge University, has been excused from delivering lectures during the coming year. His place will be in part supplied by Mr. W. Bateson.

# SCIENCE

A WEEKLY JOURNAL DEVOTED TO THE ADVANCEMENT OF SCIENCE, PUBLISHING THE OFFICIAL NOTICES AND PROCEEDINGS OF THE AMERICAN ASSOCIATION FOR THE ADVANCEMENT OF SCIENCE.

EDITORIAL COMMITTEE: S. NEWCOMB, Mathematics; R. S. WOODWARD, Mechanics; E. C. PICKERING, Astronomy; T. C. MENDENHALL, Physics; R. H. THURSTON, Engineering; IRA REMSEN, Chemistry; JOSEPH LE CONTE, Geology; W. M. DAVIS, Physiography; HENRY F. OSBORN, Paleontology; W. K. BROOKS, C. HART MERRIAM, Zoology; S. H. SCUDDER, Entomology; C. E. BESSEY, N. I. BRITTON, Botany; C. S. MINOT, Embryology, Histology; H. P. BOWDITCH, Physiology; J. S. BILLINGS, Hygiene; WILLIAM H. WELCH, Pathology; J. MCKEEN CATTELL, Psychology; J. W. POWELL, Anthropology.

FRIDAY, JUNE 14, 1901.

## CONTENTS:

<i>Washington Memorial Institution for Post-graduate Study and Research in Washington</i> .....	921
<i>Address of the President of the American Medical Association: DR. CHARLES A. L. REED</i> .....	924
<i>Variations in the Apical Plates of Arbacia Punctulata from Wood's Holl, Mass: PROFESSOR HENRY LESLIE OSBORN</i> .....	938
<i>Inorganic Ferments: PROFESSOR HARRY C. JONES</i> .....	940
<i>Scientific Books:—</i>	
<i>Crocker on Electric Lighting: PROFESSOR ELIHU THOMSON. Chemical Technology: PROFESSOR A. H. GILL. Lang's Lehrbuch der Vergleichenden Anatomie der Wirbellosen Thiere: DR. W. H. DALL. Ries on the Clays of New York: PROFESSOR J. F. KEMP</i> .....	943
<i>Scientific Journals and Articles</i> .....	947
<i>Societies and Academies:—</i>	
<i>The New York Section of the American Chemical Society: DR. DURAND WOODMAN</i> .....	948
<i>Discussion and Correspondence:—</i>	
<i>The Motion of a Top: PROFESSOR A. HALL. Modulus of Constant Cross Section: PROFESSOR THOMAS GRAY. Note on the Genus Hollandia of Karsch: DR. THEO. GILL</i> .....	948
<i>Current Notes on Physiography:—</i>	
<i>U. S. Geological Fossils; Rivers of East Yorkshire; The Vogtland: PROFESSOR W. M. DAVIS</i> .....	950
<i>Notes on Oceanography:—</i>	
<i>An Oceanographical Museum; Marine Currents and River Deflection. DR. R. A. DALY</i> .....	951
<i>The New Mexico Biological Station: PROFESSOR T. D. A. COCKERELL</i> .....	954
<i>The Geological Society of America: PROFESSOR HERMAN LEROY FAIRCHILD</i> .....	954
<i>Scientific Notes and News</i> .....	955
<i>University and Educational News</i> .....	959

## WASHINGTON MEMORIAL INSTITUTION FOR POST-GRADUATE STUDY AND RESEARCH IN WASHINGTON.

DURING the past winter and spring there has been in Washington an active movement having for its object the founding of an institution to facilitate the utilization of the various scientific and other resources of the Government for purposes of research. The aim is cooperation with universities, colleges and individuals in rendering available to men and women the practical post-graduate training which cannot be obtained elsewhere in the United States and which is now available in Washington to a limited degree only.

The movement originated in the Washington Academy of Sciences, which appointed a committee to take charge of the matter. This committee consisted of the president of the Academy, Hon. Charles D. Walcott (chairman); Hon. Carroll D. Wright, Commissioner of Labor; Dr. C. Hart Merriam, of the Department of Agriculture, and Mr. Marcus Baker, of the Geological Survey. Communication was at once established with the board of trustees of the George Washington Memorial Association, who appointed a committee to cooperate with the committee of the Washington Academy, consisting of Mrs. Archibald Hopkins, president of the Association, Mrs. Phoebe A. Hearst and Mrs. L. M. D. Sweat. These

MSS. intended for publication and books, etc., intended for review should be sent to the responsible editor, Professor J. McKeen Cattell, Garrison-on-Hudson, N. Y.

two committees formulated and submitted a plan of agreement, which was approved by the board of managers of the Washington Academy on February 26, 1901, and by the board of trustees of the Memorial Association on March 13, 1901. This plan provided for the founding in the city of Washington of an institution to be known as the *Washington Memorial Institution*.

The objects of the George Washington Memorial Association are, first, as implied in its name, the creation of a memorial to George Washington; and second, as stated in its amended act of incorporation, the increase in the city of Washington of opportunities and facilities for higher education, as recommended by George Washington in his various annual messages to Congress, notably the first—*i. e.*, 'the promotion of science and literature' substantially as set forth in his last will, and by and through such other plans and methods as may be necessary or suitable. The object of the Washington Academy of Sciences, the federated head of the scientific societies of Washington, is the promotion of science, the term 'science' being used in its general sense—'knowledge; comprehension of facts and principles.'

The two organizations agreed, first, that although American universities have so developed since George Washington's time that they fulfill many of the objects of the national university outlined by him as desirable for the youth of the United States, there is still need of an organization in the city of Washington which shall facilitate the utilization of the various scientific and other resources of the Government for purposes of research, thus cooperating with all universities, colleges and individuals in giving men and women the practical post-graduate training which cannot be obtained elsewhere in the United States and which is now available only to a limited degree in the city of Washing-

ton; and second, that the best method of securing the objects for which both organizations stand is the establishment, within the District selected by Washington as a site for the permanent seat of government of the United States, of an institution whose object shall be the realization of Washington's repeatedly expressed wish and recommendation that provision be made for the *promotion of science and literature*.

In the further carrying out of cooperation, it was agreed that the George Washington Memorial Association would undertake to secure a suitable site and erect thereon a substantial, dignified building sacred to the memory of George Washington; and that the Washington Academy of Sciences would undertake to provide for the maintenance and conduct of the institution in the interest of science and literature; and that there may be joined with it in this work the National Educational Association, the Association of American Universities, and the Association of Agricultural Colleges and Experiment Stations.

The Washington Academy at once undertook to secure the passage of a law authorizing the utilization of the resources of the Government Departments for post-graduate study and research. Such an act of Congress was approved March 3, 1901, and reads as follows:

That facilities for study and research in the Government Departments, the Library of Congress, the National Museum, the Zoological Park, the Bureau of Ethnology, the Fish Commission, the Botanic Gardens, and similar institutions hereafter established shall be afforded to scientific investigators and to duly qualified individuals, students, and graduates of institutions of learning in the several States and Territories, as well as in the District of Columbia, under such rules and restrictions as the heads of the Departments and Bureaus mentioned may prescribe.

The plan of organization next agreed upon by the two committees was essentially as follows:

1. *Organization.*—A private foundation independent of Government support or control.

2. *Objects.*—(a) To facilitate the use of the scientific and other resources of the Government for research.

(b) To cooperate with universities, colleges and individuals in securing to properly qualified persons opportunities for advanced study and research now obtainable only to a limited extent in Washington and not at all elsewhere.

3. *Government.*—The policy, control and management to vest in a board of fifteen trustees, and in addition there shall be an *advisory committee* composed chiefly of the heads of Executive Departments, Bureaus, etc.

The two committees drew up articles of incorporation, which were filed May 20, 1901.

On May 27, 1901, the incorporators met and elected the following board of trustees:

1. Dr. Edwin A. Alderman, President, Tulane University.
2. Prof. A. Graham Bell, Regent, Smithsonian Institution.
3. Dr. Nicholas Murray Butler, Professor of Philosophy and Education, Columbia University.
4. Dr. C. W. Dabney, President, University of Tennessee.
5. Dr. D. C. Gilman, President, Johns Hopkins University.
6. Dr. A. T. Hadley, President, Yale University.
7. Dr. Wm. R. Harper, President, University of Chicago.
8. Mrs. Phoebe A. Hearst, Regent, University of California.
9. Mrs. Archibald Hopkins, President, George Washington Memorial Association.
10. Dr. C. Hart Merriam, U. S. Department of Agriculture.
11. Dr. Cyrus Northrop, President, University of Minnesota.
12. Dr. H. S. Pritchett, President, Massachusetts Institute of Technology.
13. Dr. George M. Sternberg, Surgeon-General, U. S. A.
14. Hon. Charles D. Walcott, President, Washington Academy of Sciences, and Director, U. S. Geological Survey.
15. Hon. Carroll D. Wright, U. S. Commissioner Labor.

On June 3 the trustees met and elected the following officers:

Dr. D. C. Gilman, President, Johns Hopkins University, Director.

Hon. Charles D. Walcott, Director, U. S. Geological Survey, President Board of Trustees.

Dr. Nicholas Murray Butler, Columbia University, Secretary Board of Trustees.

Mr. C. J. Bell, President, Washington Security and Trust Co., Treasurer.

ADVISORY BOARD.

- President of the United States.
- Chief Justice of the United States.
- Secretary of State.
- Secretary of the Treasury.
- Secretary of War.
- Secretary of the Navy.
- Secretary of the Interior.
- Secretary of Agriculture.
- Postmaster-General.
- Attorney-General.
- Secretary of the Smithsonian Institution.
- Commissioner of Education.
- Librarian of Congress.
- Commissioner of Labor.
- Commissioner of Fish and Fisheries.
- President of the Civil Service Commission.
- President of the National Academy of Sciences.
- President of the National Educational Association.
- President of the Association of American Universities.
- President of the Association of Agricultural Colleges and Experiment Stations.
- Dr. Charles W. Eliot.

TRUSTEES.

1903.	1904.	1905.
A. G. Bell,	E. A. Alderman,	N. M. Butler,
C. W. Dabney,	C. H. Merriam,	A. T. Hadley,
D. C. Gilman,	C. Northrop,	W. R. Harper,
P. A. Hearst,	H. S. Pritchett,	C. E. Hopkins,
C. D. Walcott.	G. M. Sternberg.	C. D. Wright.

The new institution will attain substantially the objects desired by the advocates of a National University, without being subject to the objectionable features of a university sustained by the Government in competition with the existing universities.

The committee of the Association of Agricultural Colleges and Experiment Stations on post-graduate study and research in Washington met and approved of the organization of the Washington Memorial

Institution; and it is understood that the committee of the National Educational Association on the question of establishing a National University in Washington approves the plan and purposes of the Washington Memorial Institution. The Washington Academy of Sciences, having turned over to the new organization the conduct and maintenance of the Washington Memorial Institution, will now cooperate with the George Washington Memorial Association in the erection and maintenance of a memorial building to be dedicated to science, literature and the liberal arts.

ADDRESS OF THE PRESIDENT OF THE  
AMERICAN MEDICAL ASSOCIATION.\*

IN approaching the discharge of my duties as presiding officer of the fifty-second session of the American Medical Association, I beg to express my appreciation of the generous suffrages by which I have been called to a position of such conspicuous honor. This appreciation becomes all the more pronounced when I reflect upon the magnitude and achievements of this great national body and upon the luster of the distinguished men who have presided over its deliberations. This thought brings me to the first duty of the occasion, and that is officially to bring to your attention the fact that since our last reunion three of my most illustrious predecessors have been called from their worldly activities to the realm of rewards. Alfred Stillé, Lewis A. Sayre and Hunter McGuire, each a former president of the Association, died within a single week. Their lives were known of men, their records are ornaments of our annals, and their achievements are their eulogies. They labored zealously and with beneficent results, not alone in the scientific field, but in behalf of an organized national profession; and to guard zealously

\*Delivered before the Fifty-second Annual Session at Saint Paul, Minn., June 4, 1901.

the splendid legacy which they, among others, have left us, must be one object of our labors upon this auspicious occasion. The hope is indulged that steps may be taken to procure suitable portraits of these and of other deceased presidents of the Association, to be placed in some safe gallery until such time as the Association may be able to transfer them to its own Temple of Fame. I recommend that suitable formal action be taken on this occasion relative to the life, distinguished services and the death of these lamented confreres.

FOREIGN RELATIONS OF THE AMERICAN  
MEDICAL ASSOCIATION.

The American Medical Association accredited delegates during the last year to several foreign medical conventions, notably the International Medical Congress at Paris, the Dominion Medical Association of Canada, the Mexican National Association and the Pan-American Medical Congress at Havana. To each of these organizations the American Medical Association sustains relations of peculiar intimacy. As one of the great scientific nations of the earth, the United States is naturally an integral part of the International Medical Congress. This Association, by a resolution presented by your present executive officer, took the initiative in 1891, in organizing the Pan-American Medical Congress. The first reunion of that Congress was held in Washington in 1893, under the presidency of the late lamented Dr. William Pepper. The second was held in the City of Mexico in 1896 under the presidency of Dr. Carmona y Valle, while the third has been held during the last few months in the City of Havana under the distinguished presidency of Dr. Juan Santos Fernandez. This movement has for its object the establishment of closer relations between the medical profession of the different countries of the Western Hemisphere. It has already



borne excellent fruit in the increased patronage of our medical schools from the far south, in the improved status of American medical practitioners in Latin America, in a better understanding of quarantine questions in the different countries, and in the development of a concert in the investigation of the medicinal flora of the Western Hemisphere. Our relations with the medical profession of Canada must be of increasing intimacy, and I indulge the hope that, while maintaining the national limitations of our Association for delegate and legislative purposes, its membership, with the privilege of participating in all scientific matters, may be freely opened to our brethren who live beyond our immediate borders.

#### FISCAL AFFAIRS AND THE JOURNAL.

It has passed into unwritten law, born of the gradually developing features of our organization, that your president shall restrict his annual address to a discussion of the affairs of the Association and to the great object to which, by the terms of its Constitution, it stands consecrated—'the common interests of the medical profession in every part of the United States.' In compliance with this rule, and realizing that I am leaving scientific questions to be presented by orators appointed for the purpose, I have pleasure in calling your attention to the satisfactory condition of the affairs of the Association, as indicated by the consolidated report of the Treasurer and of the Board of Trustees. From it you will observe that under the judicious management of your Board of Trustees you had a cash balance at the end of the last fiscal year of \$31,004.67, being an excess of \$3,696.66 over the preceding year. Your plant has been increased in value to the amount of nearly \$10,000.00, and the net profits of the *Journal* amounted to nearly \$14,000.00. You will be gratified to realize that, in ad-

dition, you have safely invested as part of a fund with which to buy a home for the *Journal* and for the Association, the respectable sum of \$25,000.00. If, however, you have occasion to feel satisfied with the normal condition of your finances, you must contemplate with pride the rapid increase of your *Journal*, in quality, size, circulation and influence. The average weekly circulation grew, during the last fiscal year, from 13,672 to 17,446, and I have added pleasure in informing you that, since the period covered by the report, the weekly circulation has grown to 22,000 copies. For the accomplishment of these splendid results, I feel that you will join me in hearty acknowledgment, not only of the sagacious management by the Board of Trustees, but the tireless industry and the discreet direction of our accomplished editor, Dr. George H. Simmons.

I feel that it is important, however, to call your attention to the fact that it would have been impossible for your Board of Trustees to have accomplished these results if, through its action, the Association had not become incorporated. Leases were to be executed, purchases were to be made, contracts were to be entered into, money was to be loaned and bonds were to be exacted, to do all of which it was necessary that the Association should become a legally organized corporation. This was effected, *ad interim*, by the action of your Board of Trustees, which procured articles of incorporation under the laws of Illinois, bearing date of April 14, 1897. I am not aware that this fact, attested by the document which I have laid before the Executive Committee, has ever been confirmed by the vote of the Association. I recommend, therefore, that such action be taken at the present session.

If, however, the condition of the Association, and particularly of the *Journal*, is, on the whole, occasion for much satisfaction,

certain facts revealed by the report are food for thought. Thus, the *Journal* has an aggregate circulation two and one-half times greater than the aggregate membership of the Association. It would seem, therefore, that while the profession at large prizes the *Journal*, it places relatively less than half as much value upon membership in the Association. This fact becomes strikingly significant when it is remembered that membership can be acquired by those who are eligible at no additional expense and with but trifling inconvenience. Does the *Journal* fulfill all the wants of the profession arising in connection with the Association? Are there no additional advantages to be derived from membership? Is there a lack of *esprit du corps*—a lack of the sense of unity in the profession? Is the existing basis of our national organization distasteful to the majority of the practitioners? Do our subscribers embrace a considerable number of practitioners, who, under existing rules, cannot become members, and whose influence, therefore, cannot be secured in behalf of the Association? These are questions that I am at liberty to ask, and that you are at liberty to answer.

Another thought suggested by the report relates to the disposition of the accumulating surplus. Shall the present policy for creating a fund for the purchase of property be carried out? Shall a larger proportion of the money be expended in still further exploiting the *Journal*? Shall the members receive a direct advantage from the earnings of the property which they have created, by reducing the annual dues, or shall a certain proportion of our surplus be expended in conducting original scientific investigations on subjects of universal interest to the profession? I cannot resist the temptation in this connection to venture replies to these questions far enough to say that, in my opinion, a reserve should be held in hand large enough to meet any pos-

sible contingencies that might occur by fire or other disaster in connection with the *Journal*; that the present generous policy in promoting the welfare of the *Journal* should be continued; that the dues of the Association should not be decreased; and that the question of establishing and defraying the expenses of certain commissions for special scientific investigators should be taken under serious consideration. The question of tuberculosis is not yet a closed chapter. The causation of cancer is yet a sealed mystery. The problems of tenement-house reform are not yet solved. The prevention of various endemic diseases has not yet been made practicable. The systematic investigation of the American medicinal flora, begun under the auspices of this Association more than forty years ago, remains an uncompleted task. These are a few among the many objects of a specific character which demand and should receive the fostering care of the Association.

I feel, however, that at the present moment, and under the existing features of our organization, it would be almost impossible to determine, judiciously, either of these very important questions, and I now bring them before the Association only for the purpose of directing attention to them, with the hope that they may be taken up subsequently, and under more auspicious circumstances.

#### SCIENTIFIC WORK OF THE ASSOCIATION.

The Association began its career with general meetings, devoted chiefly to questions of medical education and professional conduct and to lengthy reports from various standing committees. In 1860 it divided itself into a few sections, each with a certain autonomy, and each devoted to a particular part of our great scientific work. This change was followed by the establishment of the Judicial Council, by which means controversial questions, many of

them of a personal character, were eliminated from the general meetings. The subsequent creation of the Executive Committee still further relieved the general meetings of annoying details. Thus relieved, both the general meetings and the sections have grown in scientific importance, emphasizing the persistence of our devotion to what must ever be recognized as the essential, fundamental object of our organization—the cultivation of the medical sciences. It must be acknowledged, however, that great as has been the progress in this particular, too much of the time of our general sessions is yet devoted to the consideration of matters which might, with propriety, be relegated for final action to a smaller body. It would redound largely to the interest of our annual session if the general membership could be entertained and instructed at our general meetings by exercises of a more purely scientific character, of such broad nature that they should not be restricted to any of the sections. A reform in this particular will be a long step in the direction of progress. The sections, in consequence of the faithful labors of their officers, offer strikingly attractive programs for the present session. In several of the lists will be found the names of invited guests who, through fortuitous circumstances, are not members of the Association, but who are, nevertheless, active workers in the scientific field, and whose participation in our labors will enrich the value of our proceedings and enhance the felicities of the occasion. I bespeak for them your cordial welcome. While the officers of sections and your president have exercised the prerogative of inviting guests, who come as guests, and not as members of any class, as specified by the Constitution, such invitations have been extended solely with the object of advancing the interests of the Association. I look upon this privilege, which has been exer-

cised by all of my predecessors and by previous officers of sections, as one of extreme importance, and one which should be continued under any plan of reorganization which may be adopted. It is my conviction, however, that the privilege should be hedged about by certain limitations, one of the most important of which should be that an invitation should not be extended a second time to any person residing within the United States whose professional qualifications may entitle him to membership. With reference to the invitation of persons identified with the allied sciences, the matter should be left absolutely to the discretion of the president of the Association and with the officers of sections.

#### CONGRESSIONAL AND STATE LEGISLATIVE AFFAIRS.

The American Medical Association, during the first fifty years of its existence, exerted relatively little influence upon legislation, either State or national. Since the standing Committee on National Legislation and the National Legislative Council of delegates from the State Societies have been established, and have become cooperative, there is some evidence that the voice of the profession is headed at Washington. The experience of the splendid committee of this Association, acting in concert with the National Legislative Council during the last year, has, however, shown the serious necessity for more thorough organization in protecting the interests of the profession and the interests of society, as represented through the profession. The inefficiency of our present organization for influence upon Congress was shown in the inability of your committee, notwithstanding its strong personnel and the influences at its command, to prevent the degradation of the army medical service. This was accomplished by the passage of a bill under the cham-

pionship of Senator Hawley, by the terms of which the medical corps of the army is subjected to unfair and humiliating discrimination. This law grades the medical department for rank, promotion, and, in consequence, for pay, below every other department and special corps of the army, and, with the exception of second lieutenants, it is graded below the line. In accordance with its provisions, a medical officer, to obtain a colonelcy, must pass through three times as many files as an officer of either the Quartermaster's, the Subsistence or the Pay Departments; more than twice as many as an officer of Engineers or of Ordinance, and nearly twice as many as an officer of the Signal Corps. The effect of this discrimination is not only to lower the rank and pay of medical officers, but must result in lessening the efficiency of the corps by repelling men of spirit and worth.

In every war known to history the deaths from preventable diseases have exceeded those due to battle. At no time has hygienic science been so resourceful as at present in preventing disease. A law which fails to give to armies, either in peace or in war, the fullest protection by the application of the latest scientific developments at the hands of specially trained medical men is unjust to the soldier, to society and to the medical profession. In view of these facts, the army reorganization law of the last Congress was inexplicable and inexcusable. It, however, forces itself upon your consideration from another standpoint. Physicians are citizens of the Republic. As such they are intellectually, socially, politically and officially the equals of any other element of the body politic. There is no station to which they may not attain; there is no distinction of which they may not be the recipients. Their rights are of manhood origin, and their prerogatives are inherent. They are,

in very fact, peers of the realm, and the peers of any peers of any realm. When the status of any number of physicians in their representative relationship to society is lowered, the status of the medical profession in general is menaced in corresponding degree. When the Congress, by the enactment of a law, degrades, relatively, the status of an important body of medical men engaged in the public service, it strikes at the status of every physician in the country. It becomes, therefore, the duty of every member of the medical profession, jealous of his rights, his prerogatives and the fair name he may leave his children to resent, as personal between himself and every member of the Congress who voted for this law, the action which cast a stigma upon our profession.

It has been the conviction of many enlightened members of the medical profession that the means employed by the general government for the protection and promotion of the public health are capable of improvement. These duties have devolved upon the Marine Hospital Service, which was originally designed to give succor to unfortunate people, without other domicile, who were employed upon our rivers, lakes and the high seas. With the growth of sanitary science this service, being the only established agency available by the government for this purpose, has been largely diverted from its original object. As a result, under the present wise administration of its Surgeon-General, its representatives are abroad investigating the sanitary condition of foreign cities, its agents are at our ports beating back threatened epidemics, while valuable investigations are being conducted in its laboratories. In the exercise of its quarantine functions, however, it comes in conflict with the police power that is guaranteed by the Constitution to the different States. The friction thus engendered has been especially marked

in the seaboard States. While this is true, the Marine Hospital Service, in scope and design, does not fulfill in highest degree the objects of a central coordinating agency for the protection of the public health. It was thought to create a Department of Public Health, with its executive officer in the cabinet, but this idea yielded to that of a bureau in charge of a large Advisory Council, composed of representatives from various States. Resolutions have been adopted and memorials have been sent to the Congress, committees have been appointed, money has been appropriated by this Association, bills have been introduced, and hearings have been had in committee, with the result that the conditions to-day are precisely the same that they were ten years ago, when the agitation was inaugurated in the session of this Association held at Washington.

Secretary Wilson, of the Department of Agriculture, in his Report for 1899, recommended that the Congress appropriate money to defray the expense of a systematic investigation of the medicinal flora of the United States and of experiments upon the neutralization of medicinal plants indigenous to other countries. This recommendation was based upon the fact that the United States is the only great country which either has not conducted or is not conducting such experiments, and upon the fact that the proposed measure, touching the avenues of industry, manufacture, commerce and the public health, was one of national concern. This measure, however, with its manifest importance, was denied even courteous consideration, while its friends were denied a hearing by the committees of the Congress.

The cause of failure on the part of this Association to procure legislation by the Congress—and, with the exception of preventing the passage of the anti-vivisection bill last year and securing the enactment of

the quarantine bill this year, our recent efforts must be recognized as failures—I say the causes of our failure are properly subjects for careful consideration. I have examined the records of the Association from the date of its organization, and have been profoundly impressed with the fact that memorials, resolutions, or even more definite propositions addressed to the Congress have, for the most part, represented the views, or rather the impressions, of the individual members proposing them. They have generally been presented in the general meeting and have been endorsed without the deliberation essential for wise action; but a deliberation which is simply impossible in the limited time available in our general meetings. In certain instances memorials to the Congress have been presented at one session of the Association, have been referred to committees and reported back for action, either at a later meeting of the same session or at the succeeding annual session of the Association. But it becomes evident that this course lessens the evil but a trifle, for the reason that the committees to which such matters were referred have been constituted either under the leadership of the member proposing the measure or of members of a standing committee who had no interest in or understanding of the proposed measure. Such memorials, resolutions or propositions, when acted upon affirmatively by the general meeting of the Association, have, possibly, been mailed to some member of Congress or of a Legislature, but were not followed by effective work in the rank and file of the profession or among their patrons. When such bills have been presented to the Congress, and have received a certain amount of support from representatives of this Association, they have, as a rule, attained only that degree of importance that have made them valuable to their ostensible champions, as

something to trade in the game and barter of legislation for something which would please a larger number of constituents and command a larger number of votes. In view of the fact that after all the argument of votes is the only one which appeals effectively to the average Congressman, it behooves this Association, in its efforts to conserve the interests of the profession and of society, to put itself in a position to influence the largest number of votes. Every physician, therefore, should, in a perfectly respectable sense, become an active working politician. This subject, however, is of such breadth and of such depth that it may be well for us to pause at this juncture long enough to consider, from the standpoint of fundamental facts, the relationship of physicians to each other, and of the medical profession in the aggregate as an integral factor in society.

#### THE PROFESSION, THE ASSOCIATION AND THE COMMONWEALTH.

In approaching a study, however brief, of the relation of the medical profession to the state or, as I prefer to call it, the commonwealth, I feel that I am inviting your attention to an eminently practical theme; one which may enable us to understand the influences by which we have arrived at our present estate, and the means by which we may advance to even greater achievements. As we approach this theme—this eminently practical theme—we discover that the status of the medical profession, like that of every other element of that complex whole which we call society, is a perfectly natural one. Whatever it may be, it has been attained in the process of evolution and has been and is determined by laws as immutable as those which govern the commingling of atoms or the sidereal strides of the planets. It is not the result of conventions or of resolutions or of statutory enactments; but these are to be interpreted rather as in-

dicia, for the time being, of the position of the profession in the body politic. They are, indeed, consequences rather than causes, and as such they are subjects for careful inquiry. It is by a study of them that we are enabled in part to determine those laws, those natural laws, our harmony with which is essential not alone for the present usefulness and continued progress of the profession, but for the ability of the medical profession to conserve the welfare and promote the happiness of society at large.

But I have said that the position of the medical profession is a natural one. The truth of this declaration is apparent when we go back to the beginnings of society—when we examine the evidences presented by primitive peoples. We are familiar with the classic example so frequently utilized as a starting point in the discussion of sociologic phenomena—the example of the two aborigines, one of whom makes better arrows, and the other, better mats, than his companion, when, presently, one confines himself to arrows, the other to mats, each trading his own for the other's products. Here is an example of the beginning of what the scientists call 'specialization of function in the social organism.' It is an interesting process, which, based upon varying necessities and diverse aptitudes, results in multiplication of handicraft until somebody is hurt. This is a new necessity, and it is met by a new aptitude, and the possessor of that aptitude—the medicine man, our honored progenitor—steps upon the scene. His companions, appreciating his services, reward him with their arrows and mats; and he, finding the life to his liking, restricts himself to his new-found vocation—and the medical profession is established! As the necessity for his services, whether of charm or incantation, becomes more apparent, the esteem of his fellows becomes more pronounced. As events pro-

gress he is accorded certain rights, given certain prerogatives and hedged about by certain limitations, all calculated to increase his efficiency in promoting the common welfare—and thus is the practice of medicine regulated. He is spared from the battle that he may serve his companions, and he stays away from the chase that he may delve into the great mysteries—and thus is medical education inaugurated. He is the exponent not only of his professional knowledge, but of at least the average intelligence of his people. He is, in short, an integral part of the primitive social fabric. As such he shares the manners, the customs, the aims, the ambitions of his companions; and he, with them, is controlled by the forces which determine the common state and the common destiny. His status is, therefore, determined by the very laws which control the growth and development of society itself. So true is this that, from the dawn of history until the present day, and in every stage of sociologic development, the civilization of a people may be infallibly determined by the intelligence, the efficiency and the influence of its medical profession.

THE MEDICAL PROFESSION AND SOCIETY FIFTY YEARS AGO.

It would not be to our present purpose to follow the evolution of society as exemplified in any of the civilized peoples, or, as the scientists say, 'distinct ethnic entities of the world,' in which the present complexity has been attained by an orderly succession of events. And it would be equally unnecessary to show, what everybody knows, that the medical profession, the heritor, in common with others, of antecedent influences, has been propelled by the same forces and by equally orderly events to precisely the same standard of civilization. The lesson before us is that of the relation of the medical profession to a society, which,

but a few decades ago, was the most diverse in origin and the most heterogeneous in constitution known to modern history; but a society, which at the dawn of the twentieth century is one of the largest, richest and most intelligent of the world, a society, well amalgamated, and which, by common consent of even adverse critics, is moving in harmony with the most advanced influences of civilization. I fancy I should suddenly find myself unpopular with the audience, if I were to intimate that you, who comprise it—that you, the representatives of the medical profession—have failed to contribute your full quota to the great progress which that society in general has achieved, or that you do not reflect in intelligence and morality the highest type of civilized man. I hasten to allay your apprehension, for I have no such intention. On the contrary, I ask you to indulge with me in a retrospect of American society during the last half dozen decades that we may the better understand the important part that you, and the profession that you represent, have played in the attainment of present results.

As I have already stated, the middle of the nineteenth century found diverse conditions of society in the United States. The older cities of the seaboard were the centers of an advanced civilization. The remoter counties of the same States, however, were then, in the absence of railroads, the telegraph and modern mail facilities, more remote from the centers of American influence than is St. Paul to-day from St. Petersburg. The great tide of emigration that had already poured and was yet pouring over the mountains and spreading in lonely habitations or widely separated communities over the vast valley of the Mississippi from the lakes to the gulf was busily engaged with the serious problems of existence. The forest was to be felled and the prairie was to be subjugated, habitations were to be

built and crops were to be raised. In the midst of these exactions, institutions of higher learning were established, and to an extent patronized, and some strong men were produced. But it must be recognized as true that society in general had but little time and less money to devote either to schooling or to the amenities of life. The medical profession, under these circumstances, was precisely like the community of which it was a part. There were but few medical colleges, and they, for the most part, were but meagerly equipped. Many doctors became such while going from one town to another. Ignorant inventors of alleged systems of cure hawked their wares in the highways and the byways. Dogmatism that was destructive to intelligence was rampant, while schism was fostered by the baneful commercialism that too generally pervaded the heterogeneous mass of forty thousand people that comprised the medical profession. In eight of the twenty-six then existing States, no laws affecting medical practice had ever been enacted; in eleven, laws previously enacted had been repealed; in three only were there any restrictive laws, and these proved inefficient; while the facts could not be ascertained relative to the remaining four States.

#### THE ERA OF ATTEMPTED VOLUNTARY REGULATION OF MEDICAL PRACTICE.

To remedy these evils, and actuated by the love of science, the promptings of self-interest, and by devotion to the interests of humanity, representatives of the various State medical societies met in convention over half a century ago and organized the American Medical Association, with the avowed object of having its members represent and take cognizance of 'the common interests of the medical profession in every part of the United States.' It sought to cultivate medical knowledge among its members, to elevate the standard of medi-

cal education, to promote the honor and influence and interests of the medical profession and to enlighten the public concerning the relation between the medical profession and society. Emulation and concert of action in the profession and friendly intercourse among those engaged in it were additional aims of the founders of this great body of representative American medical practitioners. A constitution, by-laws and certain rules of conduct were adopted. The constitution provided for a delegate body, delegates being accredited from recognized medical societies, medical schools and eleemosynary institutions. The rules of conduct prescribed in detail the deportment of a physician, the deportment of the patient, interdicted the licensure of sectarian physicians, and proscribed from consultation those whose practice was based upon an exclusive dogma. The influence of the new Association was extended chiefly through the avenues of the various State societies, many of which adopted the rules of conduct that had been prescribed by the newly formed national body as the basis of affiliation. Several of the State societies, notably those of Massachusetts, Rhode Island and Mississippi, finding either that the prescribed rules of conduct were not suitable to their respective local conditions, or feeling that they were sufficiently in touch with the ordinary forces of civilization to require no such formulæ, never adopted the rules of conduct prescribed by the national body. The medical association of Alabama adopted the rules with rather a naive proviso that somebody be appointed to call attention to such of the special teachings of these rules 'as may seem to require elucidation in view of special circumstances and conditions.' Other State societies adopted more or less modifying resolutions, but the general spirit of ostracism and aloofness was maintained during the succeeding three decades. The



result of this movement was immediately salutary; it developed an *esprit du corps* in the great body of the profession; it gave an authoritative definition to medical education and it created a strong and influential national body within the profession. At the same time, however, it became apparent that the organization did not possess the necessary inherent strength to accomplish its avowed object to regulate the practice of medicine. As time passed schismatic medicine grew apace, its colleges multiplied, its practitioners appeared all over the country, exemplifying that law that always makes the blood of the martyrs the seed of the church. Quackery of the most flagrant character was found everywhere, and society was unprotected from its ravages, while the inability of a voluntary unchartered organization to enact and to execute plenary laws was reduced to a demonstration. The medical profession, as an organized body, discovered that its relation to the commonwealth was, as the result of its own proscriptive policy, scarcely more intimate or more influential than at the beginning of the thirty years hopeless experiment.

#### THE ERA OF EFFECTIVE LEGISLATIVE CONTROL OF MEDICAL PRACTICE.

The era of effective legislative control of medical practice came as the natural reaction from the demonstrated failure to accomplish the same result through voluntary organization; but it came as the result of the sentiment which had been propagated largely through the influence of this Association. The representatives of progressive medicine, turning from the National Association, invoked the aid of their respective State societies in taking up the question with their respective legislatures. The profession in each State, however, recognizing its own local conditions, proceeded in its own way to attend to its

own business. The very earliest attempts to secure State legislation revealed the fact that the so-called irregular practitioners, under the stimulus of ostracism and the fostering care of public sympathy thereby induced, had become so numerous and so influential that, in the majority of States, nothing could be done without their cooperation. It was no longer a theory, but a condition, with which the real reformers were confronted—and they met it. California, in 1876, through its regular medical society, took the initiative. After conferences with the representatives of the sectarian societies, and after securing their cooperation, a law was procured creating a licensing board composed of representatives of both the regular and sectarian schools of practice. Illinois, confronted by precisely the same condition, took precisely the same course. Alabama, always progressive, but the happy possessor of other conditions, was able to place the regulation of medical practice for the time being under the control of its incomparable State medical association. Colorado created a mixed board. New York, confronted by conditions even more complicated than those in other States, took up the same task. The profession of that State, acting through its organized body, containing among its members many of the most honored and illustrious names in American medicine, found it doubly necessary to enter into treaty with the denominational physicians. It realized, however, that the rules of conduct to which it had always conformed contained, among other provisions, one which made it unlawful to ‘\* \* \* examine or sign diplomas or certificates of proficiency for, or otherwise be especially concerned with the graduation of persons whom they have good reason to believe intend to support and practice any exclusive and irregular system of medicine.’

As the thing expressly interdicted by this

rule was the very thing which it was proposed to do, and which had been done in other States, and which it was very necessary to do in New York, the medical society of that State amended the rules of conduct, so that it or its members might, at discretion, enter into professional relations with any or all persons whom the law of the State at that time recognized to be practitioners of medicine. When this action was brought to the attention of this national body, it resulted, not, as might have been expected, in the amendment or the abrogation of the rule which had grown obsolete in the march of events, but in its tacit reaffirmation and in the opprobrious excommunication, for the time being, of the entire profession of the great Empire State. This action, viewed impartially after the lapse of nearly twenty years, becomes the more extraordinary when it is observed that similar action was never taken with regard to Massachusetts or Rhode Island or Mississippi, the societies of none of which had ever adopted the prescribed rules of conduct; nor with regard to California or Illinois or Colorado, each of which had, by overt act, if not by open declaration, so far as this rule is concerned, taken an equally non-conformist position. It is not surprising that, with such an example before the State societies, the experiment in consistency has not been repeated. But the movement of effective regulative legislation, once inaugurated, happily spread with great rapidity. Mixed boards of licensure are now to be found in the majority of the States of the Union, and in the majority of such boards are to be found members of the American Medical Association engaged in issuing licenses to practitioners of exclusive dogmas, and sitting in consultation with sectarian physicians, not over a dose of medicine, but over the vastly more vital question of the qualifications of those who are to care for the sick of our Republic.

THE MEDICAL PROFESSION AND SOCIETY AT  
THE BEGINNING OF THE TWENTIETH  
CENTURY.

The result of the twenty-five years of statutory regulation of medical practice are in striking contrast with the results of the quarter of a century of attempted regulations by methods of proscription. At the conclusion of that humiliating experiment, as at the beginning of it, there was not a single effective medical practice law on the statute books of a single State of the Union. To-day there are forty-eight State or territorial licensing boards, most of them being composed of representatives of both the regular and the sectarian schools of practice. The laws of the different States are of varying efficiency, the one procured by the Medical Society of the State of New York, at the price of yet-maintained excommunication from this body, standing to-day as the model of excellence for the entire country. Under the influence of these laws, instigated by members of the American Medical Association, and which, after all, are but expressions of the sentiments of the medical profession confirmed by society at large, many substantial reforms have been accomplished. The medical schools, which in this country have labored bravely and efficiently under adverse conditions, have been stimulated to increased efficiency. One of the first changes accomplished was the practical standardization of requirements to enter practice; and one of the first features of this standardization was to secure for the student 'the aids actually furnished by anatomy, physiology, pathology and organic chemistry'—the four cardinal studies which, strange-sounding as it seems, it was necessary solemnly and specifically to insist upon a half-century ago. It follows, therefore, that with broadened and increasingly uniform curricula, it cannot be said that schools, even of sectarian an-

tecedents, entirely 'reject the accumulated experience of the profession,' nor can it be said that, in a sectarian sense, they any longer possess an excuse for existence. Their graduates, or such of them as do not base practice on an exclusive dogma, are, in many instances, met in formal consultation by even conservative regular physicians, and, in more than one instance, are made members of medical societies that are in affiliation with the American Medical Association.

The Illinois State Medical Society, which has always been among the foremost in reform movements within the profession, at its recent annual session, unanimously

*"Resolved,* That the school of graduation shall be no bar to membership in the Illinois State Medical Society, providing such physician is recognized by the local societies as qualified and not claiming to practice any exclusive system of medicine."

The Ohio State Medical Society, by precedent, if not by formal action, established the same rule.

We thus see that the proscriptive rule which, during the more than twenty-five years of its dominance, propagated the very evils it was intended to correct, is rapidly expiring by limitation in the face of new conditions that have been induced, in spite of it, by beneficent and catholic legislation. In the State of New York alone the annual registration of sectarian physicians has diminished nearly ninety per cent. under the operation of its present laws. In the State of Ohio many physicians who are graduates of sectarian schools are making application to have their classification on the register changed to 'regular,' while equal reactionary movements are observable in other States. Thus we observe the passing of homeopathy and eclecticism, just as did the calm scientists of Rome witness the passing of the 'humoralism,' the 'Methodism,' the 'eclectic,' and the 'pneumatic school' of that

period; and just as passed the 'chemicalism,' the 'iatro-physical school,' the 'iatro-chemical school,' and the 'brunonianism' and the dozen other 'isms' of later epochs, each leaving its little modicum of truth as the memento of its existence. And let us felicitate ourselves that, with the passing of the particular sectarianism of the last century, there is also the passing of its concomitant evils, such as existed in even greater degree in the time of Galen, who 'found the medical profession of his time split up into a number of sects, medical science confounded under a multitude of dogmatic systems,' and, as if relating the effect of the cause, the historian continues, 'the social status and the moral integrity of the physician degraded.' The further results of this new order of things, however, are observable, not alone in the modified curricula of the medical schools, but in the changed organic relations of the institutions themselves. Under the pressure of legal requirements the weight falls with almost fatal force upon the small, private and poorly equipped institutions. These institutions, in the interest of self-preservation and to protect a respectable alumni, are forced either to expand their enterprises or to seek relations with universities which are deeply founded in the community; or else actually to go out of existence. The majority of the schools seek connection with the universities, by which step alone they become logical objects for endowment, and it is to be hoped that this movement will continue until in this great country medical education shall be as firmly established as it is to-day in any of the transatlantic nations.

Another of the new conditions which has developed within the last quarter of a century, as the result of an increasing professional unity, is the efficient sanitary regulations, national, State and municipal, that now afford protection to the people from

diseases that were formerly devastating in their effects. It is not necessary in this audience to mention smallpox, cholera, typhoid fever, diphtheria, anthrax, leprosy and the bubonic plague, each of which has been brought under relatively effective control, but I do feel that it is necessary to emphasize the fact that there are many unsolved problems relating to the prevention of disease that stand as a challenge to the industry, the ingenuity and the courage of the profession. While these various changes have taken place, others of almost equal importance are observable in the relations of physicians to society. While the community, instigated by the medical profession, has given to that profession a legal status, definite and increasingly influential, and has given it certain prerogatives and certain exemptions, it has, likewise, hedged it about with certain limitations and imposed upon it certain liabilities. There are numerous laws, both common and statutory—*lex non scripta* and *lex scripta*—that admonish the physician that his conduct carries with it a liability not defined by self-imposed rules, and the numerous courts of our land proclaim that there are tribunals, 'other than his own conscience, to adjudge penalties for carelessness or neglect' on the part of the physician. So numerous, so unjust and so disastrous are actions before such tribunals that they have caused the development of a new, legitimate and beneficent enterprise in the development of a company to insure physicians against malpractice. It may be true that in certain States and localities these laws are unjust, and that there is a grave error in their administration by judges created under our wretched elective system; but if so, the facts only emphasize anew the necessity for more complete organization of the profession and for the more active exertion of its influence upon elections.

## THE REORGANIZATION OF THE ASSOCIATION.

This brings us again to a realization of the fact that the results that can be achieved only by the unification of our national profession can not be attained under the present organization of our Association. The disproportionately rapid growth of the *Journal* as compared with that of the Association can have no other significance. The weakness of the Committee on Legislation, at Washington, was a question neither of personnel nor of industry, but arose purely from the fact that there was no efficient organization in the rank and file of the profession by which speedy and effective influence could be brought to bear upon members and senators. Equal difficulty has been encountered in several States where organization has been similarly defective. The demand for more effective organization of the Association has come from all over the country and resulted in the adoption of a motion, at Atlantic City, authorizing the appointment of a committee of three to report a plan of reorganization at this session. Another motion was adopted authorizing the creation of a supplementary committee of one from each State and territory, entitled a Committee on Organization, which has been filled by appointing for the most part the retiring presidents of State societies for the current year. The committee on reorganization, consisting of Dr. J. N. McCormick, Kentucky, Dr. Geo. H. Simmons, of Illinois, and Dr. P. Maxwell Foshay, of Ohio, has given to the important question entrusted to it a most careful and painstaking consideration. It has laid before you the results of its deliberation. In doing so it has emphasized the principle that this Association has its origin in the organized profession of the respective States. It emphasizes the fact that the delegate body should be so small that it can remain in prolonged session and give to the various subjects under consideration that deliberate

attention which has not been possible under the existing scheme of organization during the last forty years. It recognizes the paramount importance of the scientific feature of our work by relieving the general meetings and the sections alike of the troublesome details that now consume the limited and valuable time of the sessions. It remedies the glaring and serious defects in the present constitution. It prepares the Association, by perfecting the organization, to meet important and pressing questions. These considerations, together with the fact that the existing constitutional provision, relative to delay of action on pending amendments, has been met by the appointment, a year ago, of a committee for the avowed and published purpose of reorganization, and by the action of the committee in laying the results of its work before every member of the Association—I say these considerations and these facts prompt me to advise the adoption of the proposed Constitution and By-Laws in their entirety at the present annual session of the Association.

The Committee on Reorganization, under the restrictions of the resolution creating it, has, very properly, left undisturbed the existing rules of conduct. These, if construed to have a fundamental importance, and if vigorously enforced as they now stand, would disintegrate the Association in a single day. This reason, and others already given, confirm me in the conviction that such rules should be either amended or abrogated, or, if reaffirmed, it should be by general resolution endorsing their underlying principles, but disclaiming the present applicability of their details. There are, however, various views entertained upon this subject, and that the matter may be approached in a spirit of tolerance, that it may be discussed coolly and impartially, that a consensus may be reached, and that harmony may be attained, I recommend

that the general questions of the revision of the rules of conduct be referred to a special committee on ethics, consisting of three members, with instructions to report to the legislative body at the next annual session of the Association.

#### THE NEW SCHOOL OF MEDICINE.

The changes which I have advocated are essential for the attainment of the purposes of the Association and for the fulfillment of the high destiny of our national profession. They are demanded by the changes that have taken place during the last fifty years. The legislative functions have passed from voluntary organizations to the Congress and the Legislatures where they belong; but it still devolves upon the profession in the organized capacity to stimulate, to restrain, or otherwise to control the law-making power. The responsibility of the profession is increased, rather than diminished. Science has come to have a clearer meaning. He who now proclaims a dogma cries alone in the night, while the world sleeps. They who demand a creed may read its varying terms only in the progressive revelation of natural laws. Practice has changed. The depletions, the gross medications, the absurd attenuations, the ridiculous anti-mineralism have given away to a refined pharmacy and to a more rational therapy. Sacrificial surgery has yielded to the spirit of conservatism. Prevention is given precedence over cure. Education implies research and discovery, and all may delve. I proclaim, events proclaim, the existence of a new school of medicine. It is as distinct from the schools of fifty years ago as is the Christian dispensation from its pagan antecedents. It is the product of convergent influences, of diverse antecedent origin. It acknowledges no distinctive title, it heralds no shibboleth. It is a school of human tolerance, of personal independence, of scientific honesty. It is

the slave of neither prejudice nor preconception and abandons the accepted truth of yesterday if only it be the demonstrated error of to-day. It places no premium upon personal prerogative, and extends no recognition to individual authority. It makes no proclamation of completeness, no pretension to sufficiency. It recognizes that truth is undergoing progressive revelation, not ending to-day, but continuing through the ages. It yields its plaudits to achievement, and recognizes that he is the greatest among men who reveals the most of truth unto men. It greets as a friend him who thinks, though he think error, for, thinking, he may think truth and thereby add to the common fund. It heeds all things, examines all things, judges all things.

To you, the exponents of this new school, of this new generation, of this new century; to you, representatives of the Democracy of Science; to you, citizens of the Republic of Letters, I extend greetings; and here, in our parliament assembled, here, where our will is supreme, I this day invoke upon our deliberations the spirit of liberty, the spirit of courage, the spirit of progress, the spirit of truth.

CHARLES A. L. REED.

VARIATIONS IN THE APICAL PLATES  
OF *ARBACIA PUNCTULATA* FROM  
WOOD'S HOLL, MASS.

THE object of this note is to call the attention of naturalists to three points of variation in the apical system of the common eastern sea-urchin, *Arbacia punctulata*. The variations may be already known, but I had not noticed them till a year ago, and have never seen any mention of them in print. The observations are based on the study of sixty-three dry specimens sent me for class use from Wood's Holl, Massachusetts, by Mr. F. W. Walmsley. The different plates can be seen very readily if, after removing the spines, the surface be

washed and gently brushed with a weak solution of caustic potash and then dried. Great care is necessary in handling the anal plates or they will fall out. The drawings were all made under a camera lucida, magnified four diameters and then reduced one-third. The views are all placed in a similar position, *i. e.*, the anterior radius (as defined by Lang's 'Text-Book of Comparative Anatomy') is with the madreporic plate in the right anterior inter-radius. The views are arranged so that all those having four anal plates are in the center and those with three or five are below or above. This figure is a view of the

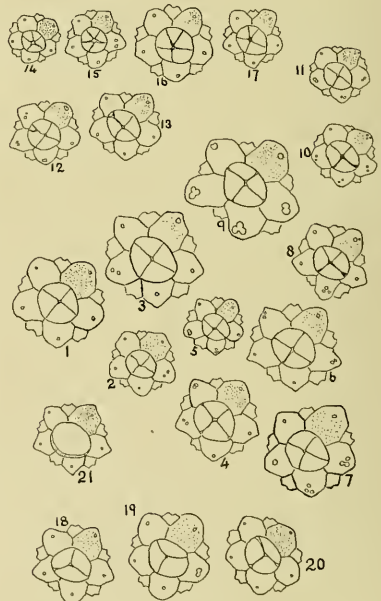

arrangement of apical plates most frequently found, the 'mode,' as it is called by recent writers on variation. It was selected to represent forty-five cases with

respect to the number of anal plates and genital pores. The other figures all represent different cases, none of them exactly duplicated in the whole collection of sixty-five. In No. 1, the mode, we recognize four anal plates an anterior, a posterior, a right and a left. Five genital plates, meeting by a considerable distance and totally excluding the ocular plates from the border of the anal ring. Each genital plate is perforated by a single genital pore. A study of the cases shows that none of these points are constant.

First, as to the number of anal plates, we find variation between three and five with four as the mode. In the case of those with five plates, two have the fifth very small, barely distinct, and the position of each one of the four large ones is similar to that of the mode. It is interesting to find that the fifth in both of the two cases is introduced at the same point, viz., near the left anterior radius. The position of the plates is nearly constant in the specimens with four, though there is a little shifting usually toward the right. Thus in No. 4, the centers of the anterior and posterior plates are strictly in the axial line, but in No. 7 they are not. In the cases with three plates, the anterior seems to have been the one to disappear, the posterior being present and showing the same tendency to shift as just noted. In the cases with five equal plates, Nos. 14-17, the plates show a tendency to be all of them radial in position, *i. e.*, alternate with the genital plates.

The number of pores in the genital plates is also subject to variation, which occurs in a greater percentage of cases than the preceding. In the mode, No. 1, there is a single genital pore in each genital plate. In No. 2, the right posterior genital plate has two pores, one being smaller. In No. 3, there are two large pores well separated. In No. 19, there is in the right posterior genital plate

a pore imperfectly divided into two; it is the least deviation from the mode in the collection. No. 5 is an interesting case in which in one plate there are two pores nearly separate and in another three, one distinct and the other two fused. In No. 8, one plate has two pores and another three. Three pores is the maximum number that I have found in one plate. In some cases all three pores are united as in No. 9, or one is distinct and two are united as in 7, or all are distinct as in 7, 8, 10. The maximum number of genital plates in one individual thus furnished with extra pores is four (Nos. 10 and 11 and, possibly, 9); in no case are all the genital plates thus varied. As to frequencies, I notice that it is more often that we find two pores than three. No one of the five genital plates is wholly exempt from this division of the genital pore, but the madreporic plate is least frequently variable. I have found two cases in sixty-five in which it had two pores, and one case with three.

Summarizing the facts as to the number of genital pores, we get the following table, in which the number of pores for each plate is shown; thus the upper and left block of figures shows that the left anterior genital plate has one pore in seven cases, two pores in five cases and three in no case, and so on for the remaining four plates:

1111111=7	11111111=9
22222 =5	22 =2
= =0	3 =1
11111 =5	1111 =4
222222 =6	2222222=7
3 =1	3 =1
	11111=5
	222 =3
	3333 =4

The three posterior plates are thus shown to be more variable than the two anterior plates, and the posterior plates show a stronger tendency to having three pores than any of the others. It is interesting to note that in the subcarboniferous sea-

urchin *Melonites* (Lang, '96, ii, p. 291, Macmillan edition; and Dana, '95, Manual of Geology, p. 641) there are four, or in some genital plates five, pores, instead of one, as regularly in modern genera.

The positions of the ocular plates with reference to the border of the anal ring are subject to variation. The facts in the case are these: In a majority of the 65 *Arbacia*s observed the plates are located exactly as shown in Fig. 1, where the madreporic plate meets its two neighbors by a long joint, thus pushing the ocular plate far away from the border of the anal opening, as compared with the left posterior ocular plate, which is only slightly distant from the border. The right posterior ocular and the right anterior are also less separated than the remaining two. This is the mode. The variations from it are on the part of the left posterior ocular chiefly and, in addition, of the right posterior, and less of the left anterior ocular plates. The extreme case of this variation is shown in No. 5, where the left posterior ocular plate participates in the formation of the border of the anal ring, as the right posterior also does, though in a less degree. In No. 21, the same variation is to be seen. Cases in which this form of variation takes place, but in a less extreme degree, are frequently met. No. 17 is such a case; here the left posterior ocular plate barely touches the margin; this is also seen in No. 3. In No. 10 this ocular does not quite reach the margin. The left posterior ocular thus shows a strong tendency to push itself into the anal ring, a tendency shown, too, but in a less degree, by the right posterior ocular and slightly by the left anterior ocular plate. The specimen of *Arbacia*, figured by Brooks in his 'Invertebrate Zoology' ('82, p. 86), which came from Southern waters, shows this same variation as to the left posterior ocular plate. The specimen of *Echinocidaris (Arbacia) pustulosa*,

figured in Lang ('96, Macmillan, Comp. Anat., II., p. 232), shows the two posterior and the left anterior oculars all bordering the ring.

In some sea-urchins (*e. g.*, *Diadema*) all the oculars take a part equally in forming the boundary of the anal ring. In *Salenia*, believed to be a very primitive genus, none of them touch it. In *Strongylocentrotus* there is a condition between these two extremes; in that form the left posterior ocular and the right posterior ocular regularly form a part of the border of the anal ring, and occasionally the left anterior ocular reaches it. In *Arbacia* the corresponding ocular plates vary in the direction of an arrangement which is the mode in *Strongylocentrotus*. A somewhat extended study of the apical systems of *Arbacia* from widely separated localities, together with a similar study of that of some of the other sea-urchins, would probably be of considerable interest to students of variation.

HENRY LESLIE OSBORN.

BIOLOGICAL LABORATORY,  
HAMLINE UNIVERSITY,  
January 22, 1901.

#### INORGANIC FERMENTS.

AN article on this subject appeared somewhat more than a year ago in the *Zeitschrift für physikalische Chemie* by Bredig and Müller von Berneck. Quite recently a monograph has been published by Bredig, under this title, containing an account of the experimental work which he has done with others and also an introductory chapter on colloidal solutions, method of preparation, etc.

The monograph begins with a discussion of the general properties of colloidal solutions. Graham found that colloids diffuse very slowly in comparison with crystalloids. Pfeffer showed that colloids exert very small osmotic pressures, and Tamman demonstrated that colloids lower the



vapor-tension of water to only a slight extent.

These facts can be accounted for in two ways, either by assuming that the colloids in solution have very large molecular weights or that colloidal solutions are not true solutions at all, but mechanical mixtures, in which the colloid is in a very fine state of subdivision. The latter view is now generally held for a large number of reasons, and for the metals, at least, seems to be made very probable by the method employed in the preparation of such solutions.

The work of Bredig and his pupils has to do with colloidal solutions of the metals, and the method employed in preparing such solutions is very interesting. Two bars of the metal in question are thrown into the circuit of a suitable electric current, and the lower ends of these poles are immersed in pure water, as shown in the figure. The

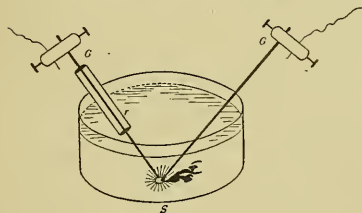

ends of the bars of metals, *g*, *g*, are brought sufficiently near that an arc is established between them beneath the water. The metal is torn off from the bars in such a fine state of division that it forms in the water a colloidal solution.

In such solutions the metal is so finely divided that it cannot be seen under the most powerful microscope, the solution appearing homogeneous under such conditions.

By the above method colloidal solutions of platinum, palladium, iridium, silver, gold and cadmium were prepared. These

solutions had the properties of colloidal solutions in general, and it is quite evident that such solutions are but mechanical mixtures of the very finely divided metals with the solvent, water.

Such solutions of the metals have some quite remarkable properties, and one of these has been studied extensively by Bredig and his pupils.

It was found that colloidal solutions of platinum have the property of decomposing hydrogen dioxide catalytically. A catalyzer is a substance which, in relatively small quantity, can effect a large transformation. The solution of metallic platinum fulfilled this condition, a small amount of the solution decomposing a large amount of hydrogen dioxide. Bredig states that a gram, atomic weight of platinum in 70,000,000 litres of water can appreciably accelerate the velocity of the decomposition of hydrogen dioxide.

Further, in order that a substance may act catalytically, it must apparently not take part in the reaction which it produces, and must remain in an unaltered condition after the reaction is over. The colloidal solution of platinum also fulfilled this condition. Bredig has shown from a study of the velocity of the reaction, by a well-known method, that the decomposition of hydrogen dioxide by the finely divided platinum is a monomolecular reaction; *i. e.*, only one substance—the hydrogen dioxide—takes part in the reaction. The metallic platinum, therefore, does not enter into the reaction at all, but remains unchanged in the solution.

We now come to the most important part of the paper. The author sees an *analogy between the catalytic action of the colloidal platinum and the action of organic ferments*. They point out that recent work has shown that there are many reactions which are effected by both unorganized and organized ferments, and also by the contact

action of many metals and oxides of the metals. A few such reactions will be given :

Alcohol is oxidized to acetic acid by the oxygen of the air, both by the ferment *mycoderma aceti*, and by finely divided platinum. Calcium formate is decomposed into calcium carbonate, carbon dioxide and hydrogen, not only by certain bacteria, but also by finely divided iridium, rhodium and ruthenium. Dilute solutions of oxalic acid are decomposed by palladium platinum and silver sponge, and also by certain fungi, and the list of such reactions could be very greatly extended. From this it is obvious that analogies between the action of finely divided metals and organic ferments were not entirely wanting when the work under review was begun.

Bredig then attempted to determine how close these apparent analogies really are, by studying very carefully and thoroughly the decomposition of hydrogen dioxide by finely divided platinum.

It has already been pointed out that a very small amount of platinum can decompose a large amount of hydrogen dioxide, just as a small amount of a ferment can effect a large amount of chemical transformation.

It has also been shown that the finely divided platinum does not enter into the reaction, just as a ferment does not enter as such into the reaction.

The presence of electrolytes affects the colloidal condition of the platinum, and, consequently, its activity. They have the same influence on ferments.

But the most striking analogy between the action of these colloidal solutions of the metals and organic ferments is to be found in their conduct in the presence of certain poisonous substances.

Bredig and Reinders showed that hydrogen sulphide in very small quantity, can diminish the catalytic action of the finely divided metal. An alkaline solution, con-

taining one gram-atomic weight of sulphur in *ten million litres* of water, can produce an appreciable diminution in the catalytic action of the metal. Schönbein has shown that small quantities of hydrogen sulphide can appreciably diminish the action of organic ferments on hydrogen dioxide.

Bredig and von Berneck have shown that hydrocyanic acid has a remarkable influence on the catalytic action of platinum. Thus, one gram-molecular weight of hydrocyanic acid in *twenty million litres* of water diminishes to one-half the velocity of the decomposition of hydrogen dioxide by colloidal platinum. This again is strikingly analogous to the action of hydrocyanic acid on organic ferments. Schönbein showed that very small quantities of hydrocyanic acid very materially lessen the action of all organic substances which decompose hydrogen dioxide catalytically; and quite recently Buchner has shown that hydrocyanic acid diminishes the action of the 'pressed juice' of yeast on hydrogen dioxide and on other substances.

The 'poisonous' action of a number of other substances, such as bromine, iodine, aniline, arsene, arsenious acid, phosphene, phosphorus, carbon monoxide, oxalic acid, mercuric chloride, etc., on the colloidal platinum and on organic ferments was studied, with the result that a general analogy between the two was undoubtedly shown to exist.

The conclusion reached by Bredig as the result of this work can best be stated in his own words :

"All these facts point to an unmistakable analogy between the contact actions in the inorganic world, and the actions of ferments in the organic world. As, in the case of my colloidal catalyzers, we are dealing with reactions in which enormously developed surfaces are involved, so is it probable that the same condition obtains in the actions of ferments, enzymes,

blood corpuscles, and oxidizing and catalyzing organic substances. We see, therefore, that the organism develops its enormous surfaces in the tissues and colloidal ferments not only because it requires osmotic processes, but on account of the very great catalytic activity of such surfaces. If, as Boltzmann says, the war for existence which living matter must wage is a war about free energy, certainly, of all the forms of free energy the *free energy of surface* is the most important for the organism.

"In conclusion, I need scarcely state that I do not maintain that there is any mysterious identity between the metals and the enzymes. But, without exaggerating the overwhelmingly large number of analogies, we are compelled to regard the colloidal solutions of the metals, in many relations at least, as *inorganic models of the organic enzymes*."

HARRY C. JONES.

#### SCIENTIFIC BOOKS.

*Electric Lighting.* By FRANCIS B. CROCKER, E.M., PH.D., Professor of Electrical Engineering in Columbia University, N. Y., and Past President of the American Institute of Electrical Engineers. New York, D. Van Nostrand Co.; London, E. & F. N. Spon.

This book is the second volume of a work, the earlier of which appeared in 1896. The complete work is intended to be a practical treatise on electric lighting for engineers, students and others. The prior volume dealt mainly with the establishment and equipment of electric lighting stations, including locations, buildings, power, dynamos, accumulators, switchboards, measuring instruments, lightning arresters, etc. The present volume, on the other hand, is devoted to that part of an electric light installation which includes the distribution of current and its utilization in various forms of lamps for light. As the author points out in his preface, the space available would not permit the more abstruse consideration of the several divisions of the subject, and this may well be admitted. A glance shows, in-

deed, that the volume has no waste space; the descriptions are brief, and the data compact and apparently quite accurate. In these respects it is excellent.

The book is eminently practical, but does not neglect the full consideration of principles necessary to a full understanding of the topics treated. It will be valuable as a reference book for engineers on account of the inclusion within its pages of many useful tables and examples.

Beginning with a chapter upon the physical properties of conductors, which includes the application, under limitations and modifications, of the so-called Kelvin's law, and the maximum carrying capacity, there follows a thoroughly adequate treatment of the various systems of electrical distribution in several succeeding chapters. The series systems, parallel systems, three-wire and five-wire distribution, direct current transformer systems and networks of electrical conductors, share the space allotted, in accordance with their importance in actual practice.

Chapters VII. and VIII. contain brief, but very lucid, expositions of the principles of alternating currents and polyphase currents respectively, after which follows a chapter devoted to a similar treatment of that very important adjunct, the alternating current transformer. The two succeeding chapters relate to alternating current systems of distribution and the calculation of such circuits. The matter appears to be well put together, and is amply elucidated by diagrams. The part of the work devoted to the distribution of delivery of energy to the place desired is concluded by a full and judicious consideration of overhead and underground conductors. Here may be found ample details of line construction, conduits, etc., as exemplified in the most recent construction, particularly in America.

The remaining portion of the volume proper is devoted to the utilization of the energy for lighting, as in arc lamps and in incandescent lamps, in addition to the accompanying interior wiring, and electric meters. The work concludes with appendices, one of which contains the National Electric Code of the Board of Fire Underwriters, and the report of the Committee

of the American Institute of Electrical Engineers on Standardization. The inclusion of this matter is certainly to be commended, and it increases the value of an already valuable technical treatise.

The chapters on electric arcs and arc lamps will be found to embody the later knowledge and developments, such as have only appeared in separate scientific papers or technical publications. Likewise the section on incandescent lamps is fully modern, as could not fail to be the case, as it has been revised by Mr. John W. Howell, whose authority on the subject is beyond dispute.

The work has so much calling for commendation that it would be surprising if a few slips of the pen did not occur. In dealing with such a large amount of technical matter it is difficult to avoid occasional use of phrases a little crude, but if the meaning is clear no harm is done. Exception may be taken to some things stated as facts, which are still undetermined. For example, on page 322, 'the retention of the heat by the bulb' in inclosed arcs is involved to save this type of arc from inefficiency as compared with the open air arc. Also, just following, it is stated that "Evidently a large bulb will be less efficient than a small one and will also tend to produce a carbon deposit by chilling the vapor on its cooler surface." This involves the inadmissible idea that carbon vapor can exist away from the arc flame as such, when in fact carbon would be condensed as soot unless burned before leaving the arc flame. If we deprive the inclosed arc too completely of air a small bulb is more rapidly rendered opaque by soot deposits than a large one.

There is a manifest inconsistency seen in comparing paragraph headed 'Current and Voltage,' page 312, with paragraph 'Efficiency,' page 325. Here the inclosed arc is made to appear by tests accredited to Freedman, at least as efficient as the open air arc, in contradiction to the opening sentence under 'Efficiency,' page 322. The fact is that there are other measurements of arcs extant which are far less favorable to the inclosed arc than those used in the book, and the former are probably nearer the truth.

The author has, in several instances, wisely

availed himself of publications issued by the manufacturing companies, and many chapters are followed by references to papers and publications which have been consulted, though the chapters dealing with arcs and arc lamps are an exception. This brings to notice what may appear to some as a defect of the work. It is evidently not intended to be historical, yet names and sometimes dates are used, but there appears throughout no consistent policy in that respect. Names occur sometimes in connection with relatively unimportant suggestions, though in other more important connections they are omitted. Credit is even given, sometimes, to the same worker for certain things and withheld at other times, though the objects in the latter case may be of the greater practical value. Few instances appear to exist in which the credit given is misplaced, as with the transformer figured on page 174. Notwithstanding this, the work gives ample evidence of the ability and industry of its author, and must be welcomed as a valuable addition to electrical literature. It is well printed, admirably illustrated, and the figures are clear and well chosen.

ELIHU THOMSON.

*Chemical Technology.* Edited by E. CHARLES GROVES and WILLIAM THORP. Vol. III. *Gas Lighting*, by CHARLES HUNT. Published by P. Blakiston's Son & Co., Philadelphia. Large 8vo. Pp. 312. Price \$3.50.

This work deals very fully and satisfactorily with the manufacture of gas for the purposes of illumination, the various forms of retorts, settings, condensers, scrubbers, governors, etc., being carefully and minutely considered. The methods of chemically testing and measuring the gas are clearly and concisely explained.

More than one-eighth of the book is devoted to oil and water gas, nearly every important process for their manufacture being detailed. The treatise closes with an excellent chapter on burners, all the principal ones being described; no mention is made of the 'bec Feron,' a French mantle burner of high power using a mixture of gas and air under pressure.

In view of the extended use of inclined retorts, the reviewer considers the treatment of this subject too brief; this remark applies also

with even more force to the topic of acetylene. Strangely enough, no directions are given for the photometric testing of gas (save for street testing), so that for this important measurement recourse must be had to another book. From a typographical standpoint too, the book leaves something to be desired; several of the cuts, for example, Figs. 43, 204, 207 and 211, are not clear.

The work in the main is excellent and should be in the library of every one interested in the subject of gas.

AUGUSTUS H. GILL.

*Lehrbuch der vergleichenden Anatomie der Wirbellosen Thiere.* Von ARNOLD LANG. 2te aufl. 1ste lief. bearbeitet von DR. KARL HESCHELER. Jena, Gustav Fischer. 1900. Pp. viii + 509, mit 410 abb.

In this volume is included the molluscan part of Lang's well-known and useful work, enlarged, revised and additionally illustrated.

The difference between the original or the excellent translation of Bernard (Macmillan, 1896, pp. 233, ills. 222) is not so great as the figures seem to imply, and is largely accounted for by the increased size of the type and the addition of 188 new cuts. A brief summary of the chief additions may be useful.

In the 'systematic review' we find the sequence of the orders changed in the Gastropods, and, in the Pelecypods, a number of suborders introduced; while the unnatural and illogical orders of the Pelseneerian classification, and his jumbled-up collocations of families under them, are still retained, though a synopsis of later views is included. In the review of 'superficial organization' the Amphineura are recognized as a class and a short chapter on the Cephalopod shell is added.

Under 'pallial complex,' reference is made to the discovery of gills in certain fresh-water pulmonates which is further enlarged on under 'Respiration,' and the characters of the Janelidae, not referred to in the first edition, are discussed. The chapter on respiration is enlarged and a general summary appended.

A few remarks on *Spirula* are added under 'Musculature,' and under 'Asymmetry' new information is added and the author's theory

discussed in the light thus thrown on the subject, with a reference to the bibliography for the opinions of others on this topic.

The phosphorescent organs form the subject of an appendix to the 'sensory organs,' and, under 'alimentary canal,' additional information is given on the proboscis in *Conus*, *Terebra*, *Cassia*, *Dolium* and *Pyrala*.

The general discussion on the intestinal region, stomach and hepatic glands is somewhat enlarged. The asserted absence of endothelial investment in the alimentary canal and digestive glands is alluded to, and the general discussion of the nephridia has been enlarged.

Under 'Reproductive Organs' we find additional matter in the general discussion, and also relating to the Ascoglossa and Holohepatica, among the Nudibranchs, and the Stylommatophora among the pulmonates.

The chapter on the 'Parasitic Gastropods' has been expanded and notes on *Thyca* and *Mucronalia* added.

Under 'Ontogeny' we note additions in connection with *Ischnochiton*, *Vivipara*, *Limax*, *Dreissensia*, *Yoldia* and *Loligo*, and the entire portion relating to Cephalopoda seems to have undergone amplification and revision. Much-improved indices and enlarged bibliography are subjects for gratitude.

The summary of facts in relation to molluscan anatomy included in this work is rich, and may be consulted with profit by those interested, though entering less into detail than the work of Simroth in the new edition of Bronn's 'Tierreichs' which is not yet complete.

Whether the training which most anatomists get is of a kind which impairs their faculties for generalization is a question difficult to answer; but it is certain that most of the younger contributors to anatomy in mollusks have not much advanced the science by their simultaneous hypotheses bearing on classification. The cause seems to be that they do not realize the vastness of the untrodden field in the molluscan subkingdom and generalize on too limited data. Furthermore, other animals are often so much easier to handle and require so much less labor in investigation to afford tangible results, that it is not remarkable that most instructors turn to animals of smaller size and simpler organi-

zation to obtain subjects for their pupils; and consequently the neglect of the mollusca continues.

The work of Lang might have advantageously been supplemented by a chapter calling attention to the gaps in our knowledge and emphasizing the need of research and the rewards which will undoubtedly fall to the lot of him who decides to investigate patiently in a field where not one in a thousand species is anatomically known, and where a careful embryological study, as of the development of the gills in Pelecypods, will produce the most far-reaching results, if carried out with thoroughness.

When this student appears, he will find in the work of Lang a storehouse of facts and a record of hypotheses which cannot fail to be of the greatest service in his studies.

W. H. DALL.

*Clays of New York, their Properties and Uses.*

By HEINRICH RIES. Bulletin of the N. Y. State Museum, No. 35. Vol. 7. 1900. Pp. 450. Plates, 140.

Somewhat over ten years ago, the author of the work before us took up the study of the clays of the Hudson River region and the industries based upon them. The venture had all the charm of novelty, because up to that time it had not occurred to anyone to investigate these humble resources, which had apparently impressed all observers as possessing little of interest or of importance. And yet the investigation proved that the clays of the state were the raw material of the most important of all its mineral industries, and they had evidently been passed by, because of their ordinary and simple nature, because they did not appeal to the imagination. The experience is not unique, as will be seen from the following incident. While the writer was recently discussing the subject with a Russian friend, the latter remarked that he had discovered on the steppes, extensive deposits of china-clay, which, when worked up and sold, would bring \$150.00 per ton. He had great difficulty in arousing interest, and yet had he found in any such quantity, gold ore worth \$5.00 or \$10.00 per ton the greatest excitement would have immediately broken out.

Ten years ago in America, scientific interest in clays was chiefly limited to those which supplied refractory materials. Our literature was small. The New Jersey Geological Survey prepared a valuable report in 1878, and in the later eighties the Geological Survey of Ohio published an important contribution, both reports being issued by States where the fire-brick industry was and is important, but except for these two contributions almost no attention had been elsewhere paid to clays by official scientific bodies. Conditions have greatly changed since then; the vitrified brick industry has sprung up; shales, once the most despised and neglected of rocks, are now utilized in enormous quantity; clays are purified and washed, and the ceramic arts have made great strides. It is but just to Dr. Ries to say that his writings have contributed in no small degree to the result and have brought within the reach of workers and readers alike, the possibilities of this invaluable raw material.

The present work is his most extensive contribution. To estimate it properly, it must be appreciated that it is intended as much for the practical workers as for the libraries and laboratories of institutions of learning. The balancing of theoretical investigations with descriptive matter has therefore been necessarily considered with care by the author, but it has been performed with discretion and in a way to attain the most useful result. The scientific reader, however, will be glad to know that all the author's results in the investigation of the physical properties of clays have not yet been published and that further contributions may be expected.

The work opens with the generalities of clays; their origin; mineralogy; properties; analysis; classification; geologic distribution in New York and in the United States.

The methods of digging clay and the geologic features of the deposits are then described, after which the brickmaking industry receives detailed description. This is followed by terra cotta, roofing tile, sewer pipe, hollow brick, etc.; floor tile, decorative tile, fire clays and pottery; each of which topics is treated at length. The properties and uses of shales are next taken up and with them feldspar is placed

as a sub-topic, somewhat illogically as it would seem.

Many minor uses of clays, as in cements, paints, paper-filling, road-materials, etc., are next reviewed, and then the various tests of different clay products are described as an aid to the practical worker. An extensive compilation of clay analyses, an excellent bibliography and a directory of clay workers in New York State conclude the bulletin.

The book is encyclopedic in treatment and will prove a valuable work of reference not only within but without the State.

J. F. KEMP.

COLUMBIA UNIVERSITY.

#### SCIENTIFIC JOURNALS AND ARTICLES.

THE first number has been issued of *Kirchhoff's Technische Blätter*, a weekly periodical not intended for popular reading, but having for its purpose the accurate rendition of scientific and technical matter. The idea of its editor and publisher is to supply these 'leaves' not only to individual subscribers but, and principally, to the subscribers to the newspapers, as supplements to regular issues. By this plan the newspaper is able to offer its readers popular but scientifically correct accounts of current progress and advances in technical departments, written by scientific men of recognized standing and often without appreciable additional expense. The list of already promised contributions includes articles by a large proportion of the leading scientific men of Germany and many in other countries. The first number contains, for example, articles on the Berlin-Cologne electric railway by Arthur Kirchhoff, on metallurgical work by Dr. Wedding, on his flying machine by Hofmann, on the steam-turbine by Professor Kubler, and a variety of other interesting matter, well condensed as also well selected. The enterprise is a novel one and deserves success. One would think that such a plan would prove practicable in the United States, more than in Europe; since many of our newspapers, notably the *New York Sun* and the *Times*, have long owed something of their reputation to their interest in, and accuracy of statement

regarding, scientific and technical matters. Like the new German periodical, they have secured their information from experts familiar with the subjects discussed and competent not only to present a clear and concise account of a scientific or technical advance, but also to advise regarding the importance of the matter and the advisability of giving it space. Fads and frauds and follies are thus avoided.

R. H. T.

*The American Naturalist* for May begins with an account of 'Two New Myrmecophilous Genera of A aberrant Phoridae from Texas,' by Charles T. Bruce, these being wingless Diptera of a family before unknown in America. L. B. Walton discusses 'The Metathoracic Pterygota of the Hexapoda and their Relation to the Wings,' concluding that the typical thoracic segment possesses the components of both pterygoidum and wing, and Vernon L. Kellogg considers 'Phagocytosis in the Postembryonic Development of the Diptera.' H. S. Jennings has a paper 'On the Significance of the Spiral Swimming of Organisms,' considering that by means of this many creatures, even those not symmetrical, are enabled to pursue what in the main is a straight course. The 'Synopsis of North American Invertebrates' contains the second part of the *Hydromedusæ*, by Chas. W. Hargitt. The 'Reviews of Recent Literature' are unusually numerous, occupying nearly 40 pages.

*The Plant World* for May contains the final part of 'Hints on Herborizing,' by A. H. Curtiss; 'The Asparagus Rust,' by Byron D. Halstead, and many briefer articles, notes on current literature and reviews. In the 'Families of Flowering Plants,' Charles L. Pollard treats a number of families of the Rosales.

*The Journal of the Boston Society of Medical Sciences* for April 23, contains 'A Contribution to the Normal Histology and Pathology of the Hemolymph Glands,' by A. S. Warthin; a second paper on 'The Relation between Physique and Mental Work,' by Henry G. Beyer, in which additional evidence is adduced to show that, as a rule, physical and mental ability go hand in hand, and an article on 'Typhoid

Cholecytitis with Observations on Gall Stone Formation,' by J. H. Pratt.

The *Popular Science Monthly* for June opens with a timely article on 'Our Forest Reservations,' by J. W. Toumey, in which the subject is discussed from various points of view. David Starr Jordan presents the second instalment of 'The Blood of the Nation,' showing how the slaughter of the flower of the nation in war contributes to the survival of the unfit, and Robert H. Thurston gives the concluding portion of his paper on 'Progress and Tendency of Mechanical Engineering in the Nineteenth Century.' Jas. Lewis Howe discusses 'The Periodic Law,' and Henry A. Rowland's 'A Plea for Pure Science,' is republished as a tribute to his memory, while Gary N. Calkins treats at some length of 'The Malaria Germ and Allied Forms of Sporozoa.' Francis H. Herrick has a well-illustrated article on 'The Wild Bird at Arm's Length; A New Method of Bird Study,' this consisting in removing the branch to which a nest with young birds is attached to some accessible spot near by a green tent, from which the birds are observed and photographed at a short distance. The final article is the sixth portion of 'A Study of British Genius,' by Havelock Ellis, this being devoted to marriage and family.

*Bird-Lore* for May-June opens with an article by John Burroughs on 'A Bewildered Phoebe,' followed by 'Bird-Nesting with Burroughs,' by Frank M. Chapman, well illustrated from photographs. Annie Trumbull Slosson contributes 'A Sudden Friendship,' showing how tame wild birds may suddenly become. The fourth series of 'Birds and Seasons' treats of the forms to be observed from Boston to Stockton, Cal., incidentally including the statement that Dr. W. L. Ralph is to continue the 'Life Histories of North American Birds' which was begun by the late Major Bendire. Among the various articles in the different 'departments' is one of special interest entitled 'A Connecticut Game Preserve,' by Willard G. Van Name, which hints at a successful method of increasing the birds by making a reservation where they are protected at all seasons and fed during winter and whence they spread into adjacent territory.

#### SOCIETIES AND ACADEMIES.

##### THE NEW YORK SECTION OF THE AMERICAN CHEMICAL SOCIETY.

THE regular meeting of the New York Section of the American Chemical Society was held May 10th, at the Chemists' Club, 108 West 55th Street, Dr. C. A. Doremus presiding.

The following papers were read:

'The Quantitative Determination of Cadmium,' by E. H. Miller and R. W. Page.

'On the Relation of Chemical Constitution to the Physiological Action of Certain Modern Anæsthetics,' by W. E. Dreyfus.

'Alloys of Titanium and Titanium Steel' by A. J. Rossi.

(a) 'Chemical Nature of the Enzymes,' (b) 'Note on Nucleic Acid,' by P. A. Levene, read by Dr. S. Bookman.

'Analysis of Garden Sage, with Notes on the Determination of Essential Oils,' by L. L. Watters.

Each of the papers received some discussion.

A communication was read from the chairman of the New York Section of Chemical Industry, relative to the appointment by that body of a committee to secure 'uniformity in technical analysis'; and stating that a sub-committee had been appointed to investigate the analysis of Portland Cement. Also that work on this line had commenced and that members of the New York Section of the American Chemical Society were invited to cooperate.

It was moved and seconded that the matters be brought before the council with the recommendation that a committee be appointed to cooperate with the committee of the Society of Chemical Industry.

It was also voted that the chairman of the New York Section be returned as a local delegate to the council of the Society, provided he be not already a member of the council as delegate-at-large.

DURAND WOODMAN,  
Secretary.

#### DISCUSSION AND CORRESPONDENCE.

##### THE MOTION OF A TOP.

THE elementary explanations of this motion generally labor under the difficulty which attended the explanations of the late Professor Pliny Earle Chase, that is, they need an ex-



planation. Such a result might be expected when we consider the difficulties of the question. The student should understand that he must face the difficulties, and that he can not overcome them without serious study. A good analytical exposition will be found in the 'Mecanique' of Poisson. But the most satisfactory investigation of such motions is given by Poincot, by means of the theory of couples. An interesting example is that of the precession and nutation of the equinoxes. If we form the couples around the earth's axis of rotation, around the line of equinoxes, and around the line in the earth's equator, directed toward the solstice; we find that the couple around the axis of rotation is zero; the couple around the line of equinoxes gives the precession; and the couple around the other axis produces the nutation. By substituting the force arising from the action of the sun, expanding by the binomial theorem, and retaining only the first terms, the solar precession comes out  $15''.6$  in a year. The calculation for the moon is not so easy because the moon does not move in the ecliptic; but, since we can compound couples like forces, there is no difficulty except the length of the work. The precession produced by the moon is  $34''.8$ ; hence the sum, or the luni-solar precession is  $50''.4$ . Observation gives  $50''.35$ ; this simple method therefore gives a good approximation to the true value.

The mass of the earth disappears when we compound the couples, and the precession would be the same if the earth were a shell of the same figure. The precession has a secular character, since when we integrate we find a constant factor multiplied by the time. Again, since the precession is negative, the dynamical result shows that the earth is flattened at the poles, and not elongated as Cassini thought.

The nutation can be found in the same way from the couple around the third axis, but it has a periodical character, and changes sign with the longitude of the moon. The computed value agrees well with observation.

Poincot's work is a remarkable example of what can be done by the careful study and examination of the geometrical conditions of a question.

A. HALL.

CAMBRIDGE, May 31, 1901.

#### MODULUS OF CONSTANT CROSS SECTION.

TO THE EDITOR OF SCIENCE: In the last number of SCIENCE there appears a short article with the above heading, in which the author says he can find no mention anywhere of a modulus of constant cross section. The modulus here referred to will be found in a number of treatises on elasticity, among others the article 'Elasticity,' in 'Encyclopædia Britannica,' Vol. VII., p. 807, and Rankine's 'Applied Mechanics,' p. 279, where a numerical value is quoted for brass. If  $k$  be the volume modulus and  $n$  the rigidity modulus the modulus for constant cross section is  $k + \frac{2}{3}n$ .

The author may profit by the study of the thermodynamics of elasticity as given in the 'Britannica' article.

THOMAS GRAY.

ROSE POLYTECHNIC INSTITUTE,

May 27, 1901.

#### NOTE ON THE GENUS HOLLANDIA OF KARSCH.

IN reading over the sixth volume of the Cambridge Natural History (Insects) by Dr. David Sharp, p. 396, the writer notes the following statement: "The tropical African Arbelidae are considered by Karsch to be a distinct family, Hollandiidae."

Upon looking up the matter I discover that Dr. F. Karsch, in the twenty-second volume of the 'Entomologische Nachrichten' (1896), p. 137, erected a genus in honor of Dr. W. J. Holland, of Pittsburgh, calling it *Hollandia*, and selecting as the type of the genus the species named and described by him as *Hollandia togoica*. He further made this genus the type of a new family, the *Hollandiidae*, to which he referred the genera *Hollandia* Karsch, *Arbelodes* Karsch, *Lebedodes* Holland, and *Metarbela* Holland.

Dr. Karsch unfortunately overlooked the fact that in the *Annals and Magazine of Natural History* for October, 1892 (p. 295), Dr. Arthur G. Butler had already described a genus of African moths, naming it *Hollandia*, in honor of the same gentleman, whom Dr. Karsch states it to be his wish to recognize. Dr. Karsch's name, therefore, falls into the list of synonyms together with the family name, which he has proposed.

The writer suggests for the genus described

by Karsch the name *Hollandella*. I am, like Dr. Sharp, unable to recognize characters of family value, and the distinction between the group, typified by the genus in question, and the generally recognized constituents of the family Arbelidæ appears to me to be of not more than subfamily importance. From this standpoint the nomenclature would be as follows: Family Arbelidæ, subfamily *Hollandellinæ*, genus *Hollandella*, etc.

I imagine that the change which I propose will not be displeasing either to Dr. Karsch, the learned custodian of the Royal Museum of Natural History in Berlin, or to my friend the Director of the Carnegie Museum.

THEO. GILL.

WASHINGTON, May, 1901.

#### CURRENT NOTES ON PHYSIOGRAPHY.

U. S. GEOLOGIC FOLIOS.

THE folios of the Geologic Atlas of the United States continue to furnish an unrivaled source of physiographic as well as of geologic information. Among the more recent, the following may be noted: The Monterey folio (Va., W. Va., Darton) exhibits the crowded Appalachians bordering the Allegheny plateau, a district of strongly corrugated strata now reduced to ridges and valleys of anticlinal, synclinal and monoclinal structure. Bristol (Va., Tenn., Campbell) includes a monoclinal belt with many overthrust faults, characteristic of the Appalachians in Tennessee; the mountains here are nearly rectilinear, in contrast to the sharp-turning zigzags further northeast. Between the mountains is an open country with many low ridges, once a lowland, but now dissected after a gently slanting uplift. Standingstone (Tenn., Campbell) presents a portion of the Cumberland plateau, with its ragged western escarpment descending to the 'highlands,' themselves dissected by streams that go to the lowlands next west. Uvalde (Tex., Vaughan) contains a part of the Rio Grande plain bordering the Edwards plateau whose dissected escarpment appears on the north. The plateau has yielded sand and silt with which the broad valleys of the plain are washed; here the streams frequently disappear and reappear, the Nueces river being an unusually large example

of this kind. Elmore (Col., Hills) shows the broad Plains that front the Rocky mountains near Trinidad to be surfaces of denudation, remnants of the removed strata being preserved under the lavas of Raton mesa; the Plains are now somewhat trenched by the streams. Fort Benton (Mont., Weed) gives another illustration of the great denudation by which the Plains have been formed, as testified to by the isolation of the Highwood mountains, an embossed body of dissected lavas and dikes; the larger river valleys of to-day are here sharply sunk beneath the Plains. Little Belt (Mont., Weed) affords an excellent illustration of the topographic consequences of the Neocene warping, for the modern deposits of Smith river basin (described as lacustrine, although consisting of irregularly bedded sands and loose conglomerates) overlap unconformably upon both the denuded central and marginal rocks of the greater Laramie deformation. Like the Highwood mountains, south of Fort Benton, the Crazy mountains, a network of dikes, here testify to the great erosion of the Plains that they overlook. Absaroka (Wyo., Hague) is characterized by the superb dissection of a high plateau of lavas and volcanic breccias; the whole region has been glaciated, and some of the valleys heading in great cirques seem to show glacial scouring in their smooth-sided, trough-like forms. Tacoma (Wash., Willis and Smith) includes examples of channels of ancient glaciers between uplands largely composed of drift; the channels now being invaded by the sea from without and by alluvium from within; the sounds are thus explained by retreat of the ice and not by depression of the land. Mother-Lode (Cal., Ransome) exhibits parts of the uplifted and dissected peneplain of the Sierra Nevada: it was strewn with gravels and flooded with lavas and volcanic conglomerates before uplift; it is now trenched by canyon-valleys. A few eminences surmount the uplands; several lava-capped table mountains standing up with long even-crested tops between the valleys.

#### RIVERS OF EAST YORKSHIRE.

THE subject of the Sedgwick essay announced by Cambridge University for 1900 was on the dependence of water-courses upon geological

structure, with the stipulation that the area studied should be British. The prize for the best essay was awarded to F. R. Cowper Reed, of Trinity College, who wrote on 'The Geological History of the Rivers of East Yorkshire' (London, Clay and Sons, 1901, 103 pp., map, 8 cuts). Thirty pages are given to a geological history of the region. River development began with the post-Cretaceous uplift and continued through a first cycle with important adjustments till an extensive peneplain had been formed. Near the close of Oligocene time came another uplift, affecting the British Isles and Western Europe. The rivers of the peneplain were thus revived and set to work sculpturing the existent topography; and at this time it is believed that a flat anticline was formed along the axis of the moorland north of the vale of Pickering, producing important changes in certain stream courses. A depression of moderate amount occurred near the end of the Pliocene; the area of greatest sinking then came to be occupied by the North sea, whose extent has since been increased by wave work along the shore. Then came the glacial period and its changes of level, when many valleys were clogged with till and many streams were reversed by ice blockades. Since the ice retreated, a small uplift and a small depression have occurred. The development of river courses is followed through these various land movements, special attention being given to the changes caused by the growth of subsequent branches along belts of weak strata, and by till and ice barriers. The essay is easily the most detailed and successful study of the rivers of northern England that has yet appeared.

#### THE VOGTLAND.

A DISTRICT of uplands and valleys, drained chiefly by the Elster, roughly located as in the southwest corner of Saxony, and known as the Vogtland, has been described by Wohlrab ('Das Vogtland als geographisches Individuum,' *Forsch. deut. Landes u. Volkeskunde*, XII, 1899, 101-185, map and plates). The essay is interesting as a partial recognition of the necessity of treating geographical forms with respect to their origin, yet it is hampered by the retention of certain traditional empirical methods and

by the incomplete adoption of more modern rational methods. The gently undulating uplands of schists, surmounted by low ridges and knobs of harder rocks, are properly presented as a worn-down old-mountain surface; but the descriptions of its landscapes thus considered are all quoted, as if the author wished to leave to others the responsibility of so venturesome an explanation. No explicit mention is made of the slanting uplift of the region, whereby its streams were enabled to incise their modern valleys. Indeed, the occurrence of bold and rocky valley sides beneath the milder scenery of the rolling uplands is presented as if it were somewhat out of the order of nature, worthy of being looked on as a curiosity, instead of the well-understood and commonplace accompaniment of dissection recently revived by uplift after a long period of relative quiescence. The details of valley form are incompletely described, though incidental mention is made of the incipient flood plains on the convex banks of the meandering streams, opposite the steep valley slopes over the concave banks. Many arithmetical details are given concerning the form of ridges and valleys: for example, the mean slopes of many valleys are calculated; although when the upper course of a valley is shallow and broad, slightly depressed beneath the uplands, while the lower course is sharply incised, relatively narrow and steep-sided, it is as inappropriate to measure its mean slope as it would be to average the price of old scrap iron and new steel rails. All these details have a certain value, but their value would be greatly increased if a more thorough scheme of physiographic description served as the basis of the work.

W. M. DAVIS.

#### NOTES ON OCEANOGRAPHY.

AN OCEANOGRAPHICAL MUSEUM.

IN connection with the exhibit of the collections made by the Prince of Monaco at the Paris Exposition, a convenient summary of his scientific work has been published by Richard (Les Campagnes Scientifiques de S. A. S. le Prince Albert Ier de Monaco, 1900). Brief descriptions of the different vessels and types of apparatus employed during the voyages, and a more

detailed résumé of the results, are given. Of particular interest in the contents of the pamphlet is the account of the magnificent building which is now nearing completion on the rock of Monaco, and intended to contain the great zoological and other collections of the Prince. The foundation stone was laid on April 25, 1899, by the Emperor of Germany. An idea of the size of the structure may be had from the fact that the façade will have the length of one hundred meters. While the greater part of the exhibits will relate to the biological sciences, there will be considerable space given to the illustration of apparatus, of the physical conditions of life in the sea, and of the areal and bathymetric distribution of organisms, by means of charts, diagrams, photographs, water-color sketches, etc. Appended to Richard's work is a valuable bibliography of the publications of the Prince and of his collaborators on the collections of the 'Hirondelle' and the 'Princesse Alice.'

#### MARINE CURRENTS AND RIVER DEFLECTION.

THE cause of the strong left-hand deflection of the Mississippi River below Baton Rouge has long been a matter of discussion (Fig. 1). The decided asymmetry of the delta both above and below sea level is an associated problem. Wind



FIG. 1. The delta of the Mississippi. Cross-hatching indicates older land. The arrow shows the general direction of the marine current prevailing at the river mouth.

direction, the influence of the Red River and crustal warping have been in turn appealed to in explanation of the facts. The formerly credited clockwise movement of the Gulf Stream in the Gulf of Mexico has likewise been held responsible. It is now generally agreed, however,

that the prevailing direction of current movement is really westward past the mouths of the river. Haskell proved this by the use of the current meter on board the *Blake*. Lindenkohl's chart of densities plainly shows a transference of Mississippi water toward the west as it spreads out over the Gulf. The cause of the current is indicated in the prevailing easterly winds, as charted, for example, in the new Meteorological Atlas of Bartholomew. Corbell has noted a maximum speed of three knots for the west-flowing current.

In view of such strong and accumulating evidence for the current, it becomes of interest to inquire as to its influence on the form of the delta. The presentation of the case may suffice to call attention to a possible kind of interaction between river current and ocean current in the development of a very definite type of form.

Outside the river-bars, aggradation of the sea floor is progressing more rapidly on the west than on the east of the delta. The striking asymmetry of the delta is thus in part explained. The deeper water on the east will particularly facilitate the yearly advance of the bars on that side. But the direction of advance will be affected by a more positive cause. It is well known that the bar at each pass is breached during the flood season, and beyond the lower end of the new channel the delta is pushed forward for the remainder of the season. While the bar thus built in a new position is left essentially undisturbed by the river itself during the following half-year of low water, the transverse Gulf current (which is aided in the work by westward drift in the line of breakers on the bar) may be conceived as modifying the form of the bar during same period. The bar will be weakened on the left-hand extremity where the impact of the current is first felt, and strengthened on the right by the accretion of the silt traveling under the impulse of the current thus along the axis of the bar. The right-hand extremity of the bar will also tend to grow the faster in height and breadth, because of the sedimentation occurring in the low water season, since the river water over the bar is then borne upon the back of a west-flowing salt water wedge. The left-hand extremity

ity of the bar, weak on account of the relative lack of deposition, and weakened by the transverse scour of the Gulf current, will invite the strengthening river-current of the next flood-time to break through the bar at that end. In this way, there will be a transference of the river axis, year by year, toward the left. In the meantime the delta has necessarily grown most rapidly to the right of the river-mouth.

The same phenomenon appears to be represented in the Rhône and the Ebro (Figs. 2 and 3).



FIG. 2. The delta of the Rhône. Symbols as in Fig. 1.

In each there are a pronounced leftward deflection of the river axis and a corresponding asymmetry of delta, coupled with a prevailing marine current sweeping past the river mouth from left to right. In all three cases, we have departures from the usual scheme of deflection, where the axis of the river is directed down stream with respect to the marine current. The conditions for this exceptional behavior are: (1) a powerful river characterized by a stable channel, and a delta growing so rapidly as to preserve one or more distributing arms; (2) a nearly tideless receiving water-body with a relatively steady current transverse to the river axis; (3) a volume of river sediment greater than that of the shore-waste migrating toward the delta under the impulse of the littoral current.

The shape of the bottom, the feeble tidal currents and the influence of mud-lumps probably have a small effect on the shape of the delta as a whole, but no other explanation is doubtless so weighty as that found in the force

of the earth's rotation. In the northern hemisphere, it tends to produce left-hand deflection of an *aggrading* river. It is true that the rel-

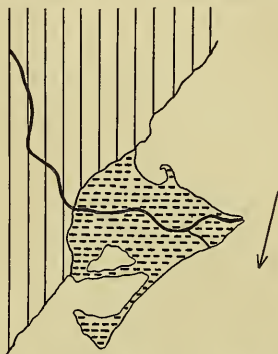

FIG. 3. The delta of the Ebro. Cross-lining indicates older land. Broken lines indicate alluvium. The arrow shows the general direction of the marine current prevailing at the river mouth.

ative straightness of river distributaries would permit of but a small proportion of the deflective force of rotation as affecting a meandering stream; but, small as it is, this force may be competent to produce strong asymmetry of a delta, since the friction of water against water is of a low order. It happens that in the three cases above noted, the marine current runs in a direction which would control the delta-building in the same sense as that expected from the influence of the earth's rotation. What is needed, among other tests of the current hypothesis, is a set of examples where the deflection of the river and delta is in appropriate relation to the corresponding currents, but in a sense opposed to that expected as a result of the earth's rotation. One purpose in outlining the hypothesis here in its present brief form is to invite observation on this point. Another obvious test is experiment. Some rough trials with artificial deltas, made on the tidal flats of the Annapolis Basin, Nova Scotia, seemed to confirm the hypothesis, but other and more thorough experiments are needed. Whatever be the explanation finally arrived at, it seems highly probable that this repeated occurrence

of deltas, possessing similar and rather highly specialized features, cannot be referred to merely accidental conditions governing the forward growth of the deltas.

R. A. DALY.

HARVARD UNIVERSITY.

#### THE NEW MEXICO BIOLOGICAL STATION.

THE Biological Station was founded as an independent institution at Mesilla in 1896. In 1899 it was moved to Las Vegas, and held a successful summer session in the New Mexico Normal University. A brief session was also held in 1900. The students in attendance have been mostly public school teachers. The results of the research work have been published in the *Annals and Magazine of Natural History*.

The Station will now be conducted as a part of the work of the biological department of the Normal University. The session of 1901 commenced on the 1st of June. A course in nature study is offered to public school teachers, and opportunities are afforded for research work along a number of different lines.

Las Vegas offers excellent opportunities for biological work. The summer climate is very good, and at no time is the heat excessive, as it is at lower altitudes in New Mexico and other parts of the Southwest. The altitude is about 6,400 feet, with mountains close by, rising above 11,000 feet.

Four distinct life-zones, the Upper Austral, the Transition, the Canadian and Hudsonian can be studied within 35 miles of Las Vegas. It results from this that the local fauna and flora are extremely rich in species; in the Hudsonian zone are forms of circumpolar distribution and others ranging to Alaska, though not to Asia or Europe; in the Canadian zone we find types identical with those of the mountains of the Northern States and of Colorado; in the Transition a varied assemblage typical, in part, of the foothill region of the Rocky Mountain range; in the upper Austral many species characteristic of the arid southwest, some ranging far southward and westward. With all this comes a certain percentage of local or endemic types, just how numerous further research must determine. Such are the snail *Ashmunella thomsoniana porteri* and the magnificent butter-

fly *Argynnis nitocris nigrocærulea*, both found in Sapello Cañon.

The Gallinas River, flowing through Las Vegas, contains a crayfish (*Cambarus gallinus*), described as new last year, some interesting fishes (*Leuciscus* and *Rhinichthys*), and a variety of aquatic insects, algæ, etc. The Hot Springs, six miles away, contain some peculiar organisms, which have not yet been sufficiently examined.

In the Arroyo Pecos, and elsewhere in the immediate vicinity of the town, is an immense alluvial deposit of Pleistocene age, containing innumerable remains of mollusca and occasional mammalian fragments. Special facilities are offered to students of wild bees (*Apoidea*), the available collections and literature being very extensive. Facilities are also offered for the study of *Coccidæ* and other groups of insects. Students should, if possible, bring their own microscopes, slides, forceps and other accessories.

T. D. A. COCKERELL.

#### ANNOUNCEMENT CONCERNING THE THIRTEENTH SUMMER MEETING OF THE GEOLOGICAL SOCIETY OF AMERICA.

*Sessions.*—The thirteenth summer meeting of the Society will be held in Denver on Tuesday, August 27th, in the East Denver High School building. The Council will meet on Monday evening at the hotel headquarters. The Society will be called to order by the President, Mr. Charles D. Walcott, on Tuesday morning, immediately following the general session of the American Association for the Advancement of Science.

*Program.*—The preliminary list of papers will be mailed about August 1st, and no supplementary list will be sent. The Fellows are requested to send their abstracts on the printed form as promptly as possible, and not later than July 15th. By the rule of the Council abstracts are required. Papers offered for printing should be fully described on the blank forms, extra copies of which will be promptly sent on request.

*Hotel Headquarters.*—The Brown Palace Hotel has been selected by the local committee, A. A. A. S., as headquarters. The regular

rates at the hotel, are \$1.50 per day and upwards on European plan, and \$3.00 to \$5.00 per day, American plan. Reduced rates will doubtless be made for the meeting.

*Transportation.*—The Western Passenger Association, covering the territory west of Chicago and St. Louis, has made a rate of one fare plus \$2.00 for the round trip, in their territory, to Denver, Colorado Springs and Pueblo. The tickets may be bought from July 10th to August 31st, and are good for return up to October 31st. At this rate the fare from Chicago to Denver and return will be \$31.50. The Pullman fare is \$6.00 extra, each way.

Further details will be found in the A. A. A. S. circular, which will be issued soon.

*Geological Excursions.*—A circular has been sent to all Fellows, describing an extended excursion through Colorado planned by Professor C. R. Van Hise, Chairman of Section E, for the ten days (Aug. 17–27) preceding the meeting. For information concerning this trip request should be made to Professor Van Hise, Madison, Wis.

The Secretary of the Denver Local Committee writes as follows:

“Geological excursions which are likely to be arranged by the local committee are as follows, but subject to change: An all-day railroad excursion to Mt. Alto and Ward; one to the mesas at Golden; one to Morrison, to the Garden of the Titans, to study the magnificent exposure from the red beds of the Triassic to the uppermost beds of the Denver formation; to the classic ground where were obtained the first *Atlantosaurus* and *Stegasaurus*; to the Pleistocene deposits near Denver. At Colorado Springs excursions will be taken to the Garden of the Gods; to the mineral springs at Manitou; and to the top of Pike’s Peak. The greatest gold camps of the world, Victor and Cripple Creek, will also be visited.”

The preliminary circular of the A. A. A. S. will be sent to Fellows of the Geological Society, who are not members of the Association, upon request to the secretary of the local committee, Mr. Arthur Williams, Denver Chamber of Commerce. All arrangements described in the association circular, relating to entertainment, transportation, etc., apply to the Geological

Society and other societies which meet in conjunction with the Association. Details will be found in that circular which cannot be given here.

*Express and Mail.*—Matter for use at the meeting should be sent in care of the janitor, East Denver High School building. It should bear the shipper’s address and be fully prepaid.

HERMAN LE ROY FAIRCHILD,

*Secretary.*

ROCHESTER, N. Y.,

June 7, 1901.

#### SCIENTIFIC NOTES AND NEWS.

AN official announcement has now been made in regard to the Rockefeller Institute for Medical Research, toward the establishment of which Mr. John D. Rockefeller has recently given \$200,000. The directors are: William H. Welch, M.D., Baltimore, President; T. Mitchell Prudden, M.D., New York, Vice-President; L. Emmett Holt, M.D., New York, Secretary; C. A. Herter, M.D., New York, Treasurer; Theobald Smith, M.D., Boston; Simon Flexner, M.D., Philadelphia; H. M. Biggs, M.D., New York. The purpose of the foundation, as the name implies, is to furnish facilities for original investigation, particularly in such problems in medicine and hygiene as have a practical bearing upon the prevention and treatment of disease. The sum of money mentioned above is not an endowment, but may be used for current expenses. The Institute will be situated in New York City. A building will not, however, be erected at present, but research will be conducted in existing laboratories under the auspices of the directors.

PRESIDENT DAVID STARR JORDAN and Dr. Barton W. Evermann sailed from San Francisco on May 30th to conduct the investigation on the fishes of the Hawaiian Islands to which we have called attention.

PROFESSOR ASAPH HALL has resigned the lectureship in celestial mechanics at Harvard University, and will spend the next year or two abroad.

PROFESSOR HENRY F. OSBORN, of Columbia University and the American Museum

of Natural History, is at present in the Bad Lands of South Dakota, planning the work to be carried on this summer by the American Museum and the U. S. Geological Survey.

DR. A. SMITH WOODWARD, of the British Museum, has, since the beginning of April, been carrying on excavations at Pikermi, near Athens, where many interesting vertebrate fossils have been found.

PROFESSOR STEWART CULIN, of the University of Pennsylvania, is at present on a visit to Cuba and Porto Rico. On his return he will visit the Indian tribes of the Northwest in the interest of the museum.

PRESIDENT JAMES LOUDON, of the University of Toronto, is at present attending the celebration of the University of Glasgow, and will later visit the universities of England and the Continent to obtain information for use in erecting the new science building of the university. During his absence Professor R. Ramsay Wright, of the chair of biology, is acting president. Principal John Galbraith, of the School of Practical Science, has been visiting the scientific schools in the United States, also with a view to the new building at Toronto.

AT the last annual meeting of the American Academy of Arts and Sciences, \$145 was appropriated from the C. M. Warren Research Fund to Dr. Charles H. Herty, University of Georgia, for purchase of material to be used in an investigation of the constitution of complex platinum compounds.

ONE of the Carnegie Research Fellowships of the Iron and Steel Institute of Great Britain has been awarded to Mr. John A. Matthews, who at present holds the Columbia University Barnard Fellowship.

THE Soemmering prize of the Senckenburger Natural History Society, of Frankfort, has been awarded to Professor Franz Nissl, of Heidelberg, for his researches on the minute anatomy of the nerve cell.

THE Director-General of the British Army Medical Service, Surgeon-General J. Jameson, C.B., retired on June 1.

THE seventh Robert Boyle lecture at Cambridge University was delivered by Professor

Sylvanus P. Thompson on June 6, his subject being 'Magnetism and Growth.'

PROFESSOR VOLNEY G. BARBOUR, for thirty-one years professor of civil engineering in the University of Vermont, died in Minneapolis on June 4.

THE eminent paleontologist, Professor Gustaf Lindström, keeper of the department of fossil animals in the Royal Museum, Stockholm, Sweden, died on May 16, last, at the age of 72 years. Dr. Lindström, who in 1876 was appointed successor of Professor N. Angelin in the Royal Museum, was well known among paleozoic investigators all over the world. He was an eminent scholar, and his works on paleontology and archeology are distinguished by their accuracy and thoroughness.

DR. KARL ZELLER, docent in theoretical astronomy in the German Technical Institute at Brünn, died on March 13, at the age of 46 years.

THE following is a translation by Professor J. C. Branner, of Stanford University, of a decree issued at Pará, Brazil, by the Governor of that State in regard to the Natural History Museum, hitherto known as the Museu Paraense: "In view of the valuable services rendered by Dr. Emilio Augusto Goeldi, director of the Museu Paraense, in the organization of that important establishment, adapting it to the scientific purposes for which it was founded and enriching it by his efforts with valuable materials which have brought it to its present degree of prosperity; and considering that this distinguished official has dedicated himself with praiseworthy devotion to those subjects which bear upon the progress and improvement of this State, effectively contributing to its good name abroad; and considering that he brought to bear the valuable help of his scientific knowledge in the study and comprehension of our rights in the question of boundary with French Guyana: It is resolved, as a testimony of the gratitude of the State to the said official, to give to the Museu Paraense the name of the *Museu Goeldi*."

PROFESSOR C. S. SARGENT, of Harvard University, acknowledges the receipt of \$126,485 for an addition to the endowment fund of the Arnold Arboretum.



MR. J. PIERPONT MORGAN has given to the Cooper Union Museum a collection of textile fabrics, the value of which is estimated at over \$50,000. The collection, including the Bodia collection of Barcelona, the Rivas collection of Madrid and the Baron collection of Paris, very completely illustrates the history of weaving through the middle ages to the end of the seventeenth century.

ENGLISH journals report that the national collection of Lepidoptera in the Natural History Museum at South Kensington has recently been greatly enriched by the addition of the almost unique collection of butterflies from Europe, and Central and Eastern Asia, together with the collection of European moths, formed by the late Mr. John Henry Leech, of Hurdcotehouse, Salisbury. Arrangements had been made during Mr. Leech's lifetime under which the museum became possessed of his eastern Asian moths, and now the same public institution has acquired the still more important accessions adverted to, through the munificence of his mother, Mrs. Leech, of Kensington Palace gardens. It is understood that the museum authorities will publish a catalogue of the butterfly collection. Of Rhopalocera there are rather more than 18,000 specimens, representing some 1,100 species, among which are over 400 male and female types of species described by Mr. Leech. This collection of Palearctic butterflies is very rich in Chinese and Japanese species, and in local forms and aberrations of European species. The European Heterocera number about 23,000 specimens, including some fine aberrations and extensive series of the variable species. The collection of eastern Asian moths, from which the museum had already made a selection, comprised nearly 3,000 species, of which about 800 were made known to science by Mr. Leech.

A MEETING was held in Dublin on May 17 for the purpose of advocating a pathological institute for Dublin. Delegates were present from various institutions, and plans were adopted for a laboratory intended primarily for research work.

As a return for the courtesies extended to members of the American Institute of Electrical

Engineers during their visit to London last year, an illuminated address was prepared and was presented to the British Institution of Electrical Engineers on May 30.

THE American Medical Association, which met at St. Paul last week under the presidency of Dr. C. A. L. Reed, decided to meet next year at Saratoga. Dr. John A. Wyeth, of New York, was elected president.

THE third quinquennial Congress of Medical Men and Naturalists of the Czech and Slav nations was held at Prague on May 25 to 29, under the presidency of Dr. Jaroslav Hlava, professor of morbid anatomy in the Bohemian University at Prague. More than nine hundred members were in attendance.

THE Department of State has received a note from the minister of the Netherlands, dated Washington, May 22, 1901, stating that the Fifth International Congress of Criminal Anthropology will be held in Amsterdam from September 9-14, 1901. The principal questions to be discussed are: First, anatomical and physiological characters of criminals, descriptive studies; second, criminal psychology and psychopathology, criminals and lunatics, theoretical considerations and practical measures; third, criminal anthropology in its legal and administrative application, principles to be followed, preventive measures, protective measures, penalties; fourth, criminal sociology, economic causes of crime, criminality and socialism; fifth, criminal anthropology and ethnology compared. Special questions, such as alcoholism, sexuality, juvenile criminality, senile criminality, hypnotism, criminal psychology in literature, etc., will also be considered.

THE Geological Survey of South Dakota was treated more liberally by the last Legislature than in former years. It is therefore planned to prepare and publish soon a bulletin on the mineral resources of the State, giving the production for the year 1900, and, later, another on the water supplies, treating particularly of the Artesian areas. A reconnaissance is purposed for the coming summer into the region of the Moreau and Grand rivers. The persistent rumors of the occurrence of coal there will be investigated. As it is a region less known and

less settled than others, special attention will be given to the native plants and animals. The prevalent formations there are the Fox Hills of Hayden and the Laramie. The original localities of the former will be visited and collections made. The personnel of the Survey at present is as follows:

J. E. Todd, A.M., professor of geology, State University, Vermillion, *State Geologist*.

C. C. O'Harra, Ph.D., professor of geology, State School of Mines, Rapid City, *Assistant Geologist*.

C. P. Lommen, B.S., professor of biology, State University, Vermillion, *Assistant in Zoology*.

D. A. Saunders, A.M., professor of botany, State Agricultural College, Brookings, *Assistant in Botany*.

MR. D. I. BUSHNELL is about to undertake a trip of reconnaissance to southwestern Missouri and northwestern Arkansas to examine caves in the White river region which is practically unknown to the archeologist.

WE learn from the London *Times* that the Department of Agriculture and Technical Instruction for Ireland has, with the concurrence of the Agricultural Board and the Board of Technical Instruction, allocated a sum of £5,000 to the purposes of the Cork Exhibition, 1902, to be applied on condition that the general scheme of the exhibition is approved by the department. A portion of this sum will be devoted to the organization by the department of an exhibit of products, appliances, and processes relating to industries which are capable of being introduced into Ireland, or, where already established, of being developed on the most modern lines.

THERE was held last month in the Paris Jardin des Plantes, the first exhibition of useful plants cultivated in the colonies.

THE French Jesuits of the Shanghai Mission have for some time maintained a meteorological observatory at Zi-Ka-Wee, and they have now established an astronomical observatory on the summit of a hill about twenty miles distant. The two institutions are to be connected by wireless telegraphy. Father Chevallier is to have charge of the new observatory.

THE mirror, being made by Mr. John A. Brashear for the reflecting telescope of Lick Observatory, was accidentally broken on June 5. It is feared that this will delay the ex-

pedition from the observatory to the Southern Hemisphere, as glass for a new mirror must be imported from France.

THE New York *Evening Post* states that the Mexican government has refused to allow a collection of antiquities gathered there by Marshall H. Saville, assistant curator of the American Museum of Natural History, to be shipped out of the country. Mr. Saville returned about six weeks ago from a six months' trip in Mexico, and will go back to that country in September, when he expects to have the dispute adjusted. The Mexican law forbids the export of antiquities, but the Museum has a contract with that government by which it is empowered to take duplicates of specimens.

THE government has decided to exclude immigrants suffering from tuberculosis.

BEGINNING with the present year Spain has adopted Greenwich time, which is 14 min. 46 sec. in advance of that of the meridian of Madrid which had previously been used.

It is planned to have an extensive exhibit of Röntgen ray apparatus at the meeting of German Scientific Men and Physicians which is this year held at Hamburg beginning on September 22.

ACCORDING to the census taken on March 31, the population of England and Wales was 32,525,716, being an increase of 12.15 per cent. in ten years. The increase in the preceding de-cennium was 11.65. The percentage increase of London was only 7.3 per cent., its population now being 4,536,034. There has, however, been a large increase in the surrounding country, the population of Middlesex having nearly doubled. The population of Ireland is 4,456,546 and of Scotland 4,471,957. The change in the population of Ireland and of Scotland in the past sixty years is remarkable:

Year.	Ireland.	Scotland.
1841 .....	8,197,000	2,620,000
1851 .....	6,574,271	2,888,742
1861 .....	5,798,967	3,062,294
1871 .....	5,412,377	3,360,018
1881 .....	5,174,836	3,735,573
1891 .....	4,704,750	4,025,647
1901 .....	4,456,546	4,471,957

THE number of applications for patents in Great Britain last year was 23,922, as compared

with 25,800 in 1899. The highest point was reached in 1897 with 30,952. It is somewhat interesting to note that, while there has been a falling off in the number of patents granted to citizens in the United Kingdom and also to citizens of Germany and France, the number of applications from the United States increased from 3,002 in 1899 to 3,189 in 1900.

THE English papers state that a complete installation of Marconi's wireless telegraphy, specially suitable for signalling purposes as used in the navy, has been fitted on board the Elder, Dempster Beaver liner, Lake Champlain. This installation is the first which has been fitted on any of the Atlantic liners sailing from Liverpool. The Lake Champlain left the Mersey for Halifax on May 21, with over 1,000 passengers, and arrangements were made to establish communication between the vessel and the Marconi wireless telegraph station at Holyhead. At 9:37 P. M., when off the Skerries, contact was obtained with the Holyhead station, the vessel being then 13 miles distant. Numerous telegrams were then forwarded from passengers to friends in all parts of the United Kingdom, each message being acknowledged by the receiving operator. Constant communication with the station was continued until 1 A. M., the vessel being then 37 miles distant. Communication was established with the Marconi station at Rosslare, and at 4:30 A. M., a fresh batch of telegrams was forwarded, notifying the vessel's arrival off the Tuskar Light to the owners, Messrs. Elder, Dempster & Co.

ACCORDING to Reuter's Agency the ice-breaker *Yermak* will leave Kronstadt on May 29 for Newcastle, and, after coaling there, will proceed to Tromsø to cooperate in the fresh phase of the Spitzbergen expedition for the measurement of the terrestrial meridian. It is expected that by the end of June next she will be able to return to Tromsø and take on board Vice Admiral Makaroff, who is to direct the projected Arctic expedition. In the course of this expedition she will coast round Novaya Zemlya in order to determine precisely the outlines of that island. The *Yermak* will next inspect the state of the ice on the channel leading to the Yenisei River, in order to ascertain the correctness of the widely held theory that the

passage to the Siberian rivers to the north of Novaya Zemlya is better than that by the Yugor Strait. Lieutenant Isliamoff, the astronomer, M. Weber, the geologist, and M. Vukuloff, the chemist, will take part in the Arctic expedition.

#### UNIVERSITY AND EDUCATIONAL NEWS.

MR. ANDREW CARNEGIE has transferred \$10,000,000 to trustees for university education in Scotland. The trustees include Lord Rosebery, Lord Kelvin, Mr. John Morley and other eminent Scottish citizens. It is expressly stated in the deed of gift that the fund is intended to improve and extend the opportunities for scientific research in the universities of Scotland and to facilitate attendance by paying the fees of students; and it is understood that the income will be divided equally between these two objects. The departments to be strengthened are science, medicine, modern languages, English literature and history.

IN view of Mr. Carnegie's great gift for Scottish universities, the following statistics regarding attendance and fees, published in a British parliamentary paper, are of interest. It will be noted that one-half of the income of the fund would pay all fees. The summer sessions, attended by 431 students, are not included.

Winter Session, 1899-1900.

	Men.	Women.	Total.	Fees.
St. Andrews.....	264	114	378	£2,934 4 6
Glasgow.....	1,604	329	1,933	13,597 10 0
Aberdeen.....	661	107	768	5,169 13 6
Edinburgh.....	2,427	250	2,677	19,889 18 7
Total.....	4,956	800	5,756	£41,591 6 7

THE University of Glasgow has received subscriptions amounting to £38,000 toward an increased endowment. This sum includes an anonymous gift of £5,000 for the department of physiology. Among the donors of subscriptions of £1,000 are Lord Kelvin, Lord Rosebery and Mr. J. S. Kennedy, of New York.

COLUMBIA UNIVERSITY has received an anonymous gift of \$20,000, of which \$10,000 is for the purchase of books, \$5,000 for a historical reading room and \$5,000 for general purposes. Barnard College has received \$1,500 for fitting up the zoological laboratory. Teachers Col-

lege has received an endowment for three fellowships of the annual value of \$500 from Mr. John D. Rockefeller, and one from Mr. John Crosby Brown. These fellowships are to permit southern teachers to carry on advanced work.

MRS. PHILIP D. ARMOUR and Mr. J. Ogden Armour have added \$250,000 to the \$1,000,000 recently given by them to the Armour Institute, Chicago. A building for the Armour Memorial School of Engineering will be erected at once.

CARSON-NEWMAN COLLEGE, a Baptist institution, of Tennessee, has collected an endowment fund of \$60,000, of which Mr. J. D. Rockefeller gave \$45,000.

A BUILDING for the scientific department of the U. S. Grant University, at Chattanooga, Tennessee, will be erected at a cost of \$23,000. Of this sum the Hon. W. M. Banefield has given \$5,000.

ELABORATE ceremonies are this week in progress at Glasgow in connection with the ninth jubilee of the university. Among the events of special scientific interest are an address by Lord Kelvin on James Watt, who carried on his work at the old college, and an address by Professor John Young on William Hunter. The new botanical laboratories were to have been opened by Sir Joseph Hooker on the 13th. Delegates have been sent from the English universities and societies and from a number of American and foreign institutions.

At the annual commencement exercises of the University of Colorado, held in Boulder, Colo., June 6, 1901, seventy-four degrees were conferred as follows: 11 B.A., 17 B.Ph., 14 B.S., 1 B.L., 4 M.A., 2 M.S., 8 M.D., 12 LL.B., 2 B.S. (C.E.), 3 B.S. (E.E.).

THE School of Pedagogy, of the New York University, has been reorganized. The Chancellor of University, Dr. H. M. McCracken, will act for the present as dean. Dr. J. P. Gordy, professor of education in the Ohio State University, has been called to the chair of the history of education and Dr. Robert MacDougall, of Harvard University, to the chair of experimental psychology. A number of professors of the University have been added to the

faculty of the School of Pedagogy, including Professors J. J. Stevenson (natural history), D. W. Herring (physics), Morris Loeb (chemistry) and C. L. Bristol (biology).

MR. M. N. FENNEMAN has been appointed professor of geology in the University of Colorado. He will begin his work in January next, at which time he will receive the Ph.D. degree from the University of Chicago.

AT Harvard University, J. G. Love has been promoted to an assistant professorship of mathematics, and Albert Sauvour to an assistant professorship of metallurgy.

DR. W. R. STOKES, city bacteriologist at Baltimore, has been elected professor of pathology in the College of Physicians and Surgeons of that city.

DR. FRANCIS H. SNOW has resigned the chancellorship of the University of Kansas, but will retain the chair of natural history.

S. GIST GEE, professor of natural science of the Columbia (S. C.) Female College, has accepted a position in the Chinese University at Soochow.

MR. HAROLD B. HARTLEY has been elected to a science fellowship at Balliol College, Oxford.

M. DÉJERINE has been appointed professor of the history of medicine in the University of Paris. There is some complaint because this chair is used as a stepping stone to other professorships. It is said that M. Déjerine will soon be transferred to a chair of nervous pathology and will be succeeded by M. Ballet who has undertaken to devote himself permanently to the history of medicine.

DR. WILHELM SALOMON, associate professor of mineralogy at the University of Heidelberg, has been appointed director of the Institute of Paleontology and Stratigraphy and his title has been changed to associate professor of paleontology and stratigraphy. Dr. V. Hepperger has been promoted to a full professorship in astronomy in the University at Vienna. Dr. Wolf Müller has qualified as docent in chemistry in the University at Freiburg, i. B.; Dr. Jordis, in inorganic chemistry in the University at Erlangen, and Dr. Kallmann, in electricity in the Technical Institute at Berlin.

# SCIENCE

A WEEKLY JOURNAL DEVOTED TO THE ADVANCEMENT OF SCIENCE, PUBLISHING THE OFFICIAL NOTICES AND PROCEEDINGS OF THE AMERICAN ASSOCIATION FOR THE ADVANCEMENT OF SCIENCE.

EDITORIAL COMMITTEE: S. NEWCOMB, Mathematics; R. S. WOODWARD, Mechanics; E. C. PICKERING, Astronomy; T. C. MENDENHALL, Physics; R. H. THURSTON, Engineering; IRA REMSEN, Chemistry; JOSEPH LE CONTE, Geology; W. M. DAVIS, Physiography; HENRY F. OSBORN, Paleontology; W. K. BROOKS, C. HART MERRIAM, Zoology; S. H. SCUDDER, Entomology; C. E. BESSEY, N. L. BRITTON, Botany; C. S. MINOT, Embryology, Histology; H. P. BOWDITCH, Physiology; J. S. BILLINGS, Hygiene; WILLIAM H. WELCH, Pathology; J. MCKEEN CATTELL, Psychology; J. W. POWELL, Anthropology.

FRIDAY, JUNE 21, 1901.

THE AMERICAN ASSOCIATION FOR THE ADVANCEMENT OF SCIENCE.

## CONTENTS:

<i>The American Association for the Advancement of Science</i> .....	961
<i>A Kinetic Theory of Evolution</i> : O. F. COOK.....	969
<i>Miles Rock</i> : WILLIAM EIMBECK .....	978
<i>Otto Luggar</i> : DR. L. O. HOWARD.....	980
<i>Scientific Books</i> :—	
<i>Pound and Clements on the Phytogeography of Nebraska</i> : PROFESSOR ARTHUR HOLLICK.	
<i>Simpson's Synopsis of the Naiades</i> : PROFESSOR T. D. A. COCKERELL.....	981
<i>Scientific Journals and Articles</i> .....	984
<i>Societies and Academies</i> :—	
<i>Philosophical Society of Washington</i> : CHARLES K. WEAD. <i>Torrey Botanical Club</i> : MARSHALL A. HOWE. <i>The Academy of Science of St. Louis</i> : PROFESSOR WILLIAM TRELEASE.....	985
<i>Discussion and Correspondence</i> :—	
<i>Remarkable Discoveries. An Earthwork Discovered in Michigan</i> : HARLAN I. SMITH. <i>Physiology in the Schools</i> : PROFESSOR S. W. WILLISTON .....	987
<i>Shorter Articles</i> :—	
<i>What is Life?</i> PROFESSOR JOSEPH LE CONTE. <i>A 'Sand Bow'</i> : PROFESSOR JAMES E. TALMAGE.....	991
<i>Notes on Inorganic Chemistry</i> :—	
<i>Platinum in Antiquity</i> ; <i>Lead in Pottery Glazes</i> ; <i>Osmic Diffusion of Vanadium</i> : J. L. H.....	993
<i>Current Notes on Meteorology</i> :—	
<i>Annals of the Mont Blanc Observatory</i> ; <i>The Moon and the Weather</i> ; <i>Notes</i> : R. DE C. WARD.....	993
<i>Scientific Positions Under the Government</i> ..	994
<i>The American Association</i> .....	995
<i>Convocation Week</i> .....	996
<i>Scientific Notes and News</i> .....	996
<i>University and Educational News</i> .....	999

A NATIONAL association for the advancement of science occupies at the beginning of the twentieth century a dominant position. The greatest achievement of the nineteenth century was the progress of science; its most definite tendency was towards the voluntary organization of individuals for the accomplishment of certain ends. The advance of science, the movement that is of the greatest importance for civilization, requires for its guidance the strongest association of individuals. Such an association will certainly arise, and will develop from existing institutions.

The organization of science in America has progressed parallel to the advance of science. Local societies concerned with the whole field of knowledge, and especially with its utilitarian aspects, were first established in Philadelphia, in Boston and in other cities. These societies were modeled on the similar institutions of Europe; the Philosophical Society of Philadelphia following the Royal Society of London, and the Academy of Arts and Sciences of Boston, the Paris Academy of Sciences. As centers of scientific activity increased in number,

as the postoffice and railways developed, as general scientific journals were established—*The American Journal of Science* began publication in 1818—the need of a national organization was felt, and here again the older nations had established the precedent. The meetings of German scientific men and physicians began in 1828, and the British Association for the Advancement of Science was established in 1831. An Association of American Geologists and Naturalists was organized in 1840, and became the American Association for the Advancement of Science in 1848.

Fifty years ago the sciences were comparatively undifferentiated. Special societies and special journals were not required. It was possible for students of science and friends of science to meet together and take a common and intelligent interest in the scientific progress of the day. Somewhat later, however, the need became apparent for a more select national society. The local academies in the European capitals had become national institutions in a way that was not possible for the similar societies in the United States, owing to the lack of centralization. Our National Academy of Sciences was organized in 1863 with a membership at first limited to fifty, and still under one hundred. The Academy was intended to be the adviser of the Government in scientific matters, and has to a certain extent fulfilled this function. At first, when there were but few scientific men in the United States and their interests were more or less common, the National Academy was an organization fitted to its environment. But it has scarcely adjusted itself to the growth

and specialization in science of the past twenty-five years.

The organization of science that was adequate for the third quarter of the century did not suffice for the fourth quarter. About twenty-five years ago it became necessary to meet the specialization becoming inevitable for scientific advance. Special societies and special journals were organized. The American Society of Naturalists, organized in 1883, and the *American Naturalist*, established in 1867, covered a limited, but still wide, field. SCIENCE, a weekly journal, was established in 1883 to keep the sciences in touch with each other and men of science in touch with the general public. The American Chemical Society was organized in 1876, The American Ornithologists' Union in 1883, The Geological Society of America and the present American Mathematical Society in 1888, and there are now national societies for almost every science. Special journals were established during the same period—*The Bulletin of the Torrey Botanical Club* (1870), *The Botanical Gazette* (1876), *The American Journal of Mathematics* (1878), *The American Chemical Journal* (1887), *The American Journal of Morphology* (1887), *The American Journal of Psychology* (1887), *The American Geologist* (1888), *The National Geographic Magazine* (1888), *The American Anthropologist* (1888) and so on, in increasing numbers, to the present time. A similar movement toward specialization is evident in the development of elective courses in our colleges, of advanced work in our universities, and in many other directions.

The American Association for the Advancement of Science did not fail to adjust

its organization to the growth and differentiation of science. In 1875 a formal division was made into two sections, one for the exact and one for the natural sciences, and in 1882 nine sections were established. At this time, when the Association had fitted itself to existing conditions, it enjoyed a most prosperous period in its history, the meetings being large and fruitful. Thus the attendance at Boston in 1880 was 997; at Montreal in 1882 it was 937, and at Philadelphia in 1884 it was 1261. But with the organization and growth of the special societies and journals referred to above, the Association did not maintain its commanding position. The American Society of Naturalists, with a more compact membership, chose midwinter as its time of meeting, and other societies became affiliated with it. The special societies, consisting of groups of experts, appealed to the loyalty of their members more directly than did the larger and more amorphous Association. There was lack of sympathy between these societies and the Association. The attendance at the meetings became smaller, and the total membership decreased. Many eminent men of science and many younger workers were not regularly in attendance at the meetings and were perhaps not even members of the Association. The programs of the sections became heterogeneous and sometimes did not reach a very high standard. The amateur and picnic elements were rather prominent, while at the same time they were mediocre. Many men of science regarded the Association as a survival that had outlived its usefulness.

But to-day no one acquainted with the most recent work of the Association will deny that it has entered on a new period of its history. This began with a change of attitude toward the special societies, replacing rivalry with cooperation. There was much opposition to the plan of letting the American Chemical Society meet in affiliation with the Association, but when this was accomplished chemistry at once became its strongest section. So it has been in other cases, where special societies have met in affiliation with the Association. At the recent New York meeting there were sixteen such societies, including practically all national societies that hold summer meetings. Other improvements in the organization of the Association have been effected. The council has been strengthened and made a truly legislative and executive body. The permanent funds have been increased, and appropriations for research have been granted to committees. Care has been exercised in the election of fellows, and in the admission of titles to the programs. This Journal is sent free of charge to all members, thus increasing and consolidating interest in the Association and in the advancement of science, giving even those unable to attend the annual meetings an adequate return for membership, and tending to unite all men of science and those interested in science in the Association and in the ends that it represents. The last three meetings, held at Boston, Columbus and New York, were all excellent, representing different types adjusted to the occasion and place. The meeting at Denver this year will be equally typical and

equally successful. The membership of the Association is now larger than it ever was before, over eight hundred new members having been elected within the past year.

There is every reason for satisfaction at the present condition and outlook of the Association. But this does not mean that we need not be on the alert to increase its usefulness under the circumstances confronting us at the beginning of the twentieth century. Evolution occurs by natural selection, but with boundless waste, regardless of time and careless of the individual. Human development must henceforth be guided by forethought and reason. It is the object of this article to make some definite suggestions regarding the organization of science in America under the auspices of the Association. They have been carefully considered by some of those most interested in the Association and, though they may not meet with universal approval, they are thought to be worth careful consideration.

The objects of the Association are said in its constitution to be "by periodical and migratory meetings, to promote intercourse between those who are cultivating science in different parts of America, to give a stronger and more general impulse and more systematic direction to scientific research, and to procure for the labors of scientific men, increased facilities and a wider usefulness." This statement may be somewhat systematized and amplified. The legitimate objects of the Association may be said to be (1) the presentation and discussion of research work in the different sciences and the publication of such research. (2) The promotion of re-

search by grants of money and by providing the means for cooperation. (3) The encouragement of addresses, reports and publications on the progress of different departments of science, sometimes of value to the specialist, but more especially important in keeping the sciences in touch with each other. Joint meetings, discussions and publications should be arranged on subjects common to different sciences, relating the pure and applied sciences or concerned with science as a whole. (4) The presentation of such addresses, reports, discussions and publications in a form that will so far as possible keep the general public informed on the advances of science, interest them in the opportunities of scientific work and its needs, and impress on them the dignity and supreme importance of science. Here should be included whatever will secure recruits to scientific workers and the money and support that scientific work requires. (5) Offering an opportunity for men of science in different departments to become acquainted personally and by publication, and encouraging sympathy and loyalty to their common interests, and performing, so far as possible, the same function for scientific men and the intelligent public. (6) The guidance of scientific organization in America, which includes the coordination, establishment and arrangement for the meetings, etc., of special scientific societies; the publication and circulation of scientific books and journals; the place of science in education and all external means for the advancement and diffusion of science; the direction of public opinion and legislation



on science, more especially when connected with the national government, and the different states and municipalities; the promotion of conditions required by science and of reforms recommended by science—in general, whatever will promote the advancement, diffusion and usefulness of science.

1. The first of these functions has in large measure been assumed by the special societies and journals, and this is in accordance with necessary conditions. Special research must be presented before, and discussed by, small groups of experts and must be published in journals that are of interest only to specialists. The special societies have compact organizations; they are most competent to select their membership, to arrange their programs and to conduct their publications. It seems inevitable that the Association must relinquish its function of providing sections for the presentation of special papers, except in the rare case that a special society does not exist and may be formed by the aid of the Association. In a joint meeting of a special society and the corresponding section all the valuable papers will be presented both before the society and the section, and only such papers will be presented to the section alone as the society will not admit. There is, however, no reason why the present general organization should not be maintained, and the papers read before the affiliated societies be made part of the proceedings of the Association. The Association may, however, render important assistance to the special societies in the ways indicated below.

2. The promotion of research by grants

of money and by providing the means for cooperation is a function that should be undertaken both by the special societies and by the general Association. The latter is, as a matter of fact, more likely to secure funds for this purpose by bequests and gifts, owing to its national character, its long history and its permanence. It can to special advantage further researches in which more than one science is concerned and in which independent societies might fail to cooperate. Efforts should be made to increase the number of patrons of the Association and to secure bequests and gifts, in order that the American Association may not be behind the British and French Associations, which appropriate annually \$5,000 or more for the direct encouragement of research. Invested funds yielding an income for this purpose would add greatly to the stability, influence and usefulness of the Association, and to the interest of the meetings at which the grants are made and the reports of the work accomplished are presented.

3. The special societies may with advantage present addresses and reports on the progress of a science, and, when the societies meet at the same time and place, their value is increased by the opportunity afforded for a larger group to be present. In this direction the Association has, however, an important work. The address of the president, the most eminent man of science in America who has not yet held this office, should be an event of national importance. It should be worth publication, and should be published in full in all the important daily newspapers, as actually happens in

England in the case of the president of the British Association. The addresses of the vice-presidents should be as nearly as may be of the same importance and interest. These should not be addresses such as are presented before the special societies, but should be intelligible and interesting to all men of science and to the great mass of men and women who have had a college education or an equivalent training in affairs. The afternoons through the week might with advantage begin with these addresses, not more than two being given simultaneously, and these might be followed with reports or discussions of problems of general interest. The sectional committees and the council should pay special attention well in advance to the arrangement of a program. Care should be taken, if necessary by invitation to those not members of the Association, to secure the adequate presentation of subjects in which the Association needs strengthening. Thus applied science should be given more prominence than hitherto. Those eminent in public life, in educational work and the like, and distinguished foreign men of science, might be invited to address the Association or to take part in its discussions. Funds should be available to defray at least the traveling expenses of such invited guests.

4. The addresses, reports and discussions should, in part at least, be of such interest as to attract the general public, securing a large local attendance and being reported widely by the press. It is not possible, least of all in a democratic country, for science to isolate itself from common life. There must be special research that

can be appreciated only by the expert, but as quickly as possible the progress of science should be made a part of the world's common stock of knowledge. The American Association should be one of the chief factors in the diffusion of science, and its annual meetings should be looked forward to by the general public as the occasion when for its benefit the year's progress in science and the contemporary state of science are exhibited in their outlines and in correct perspective. The meetings should typify the dignity and weight of science, so as to impress these on the minds of all. The sympathy and support of all the people are absolutely essential for science. Only so can recruits for scientific work be secured; only so can endowments and material support be obtained; only so can scientific work under the government be placed on a secure and permanent basis. We have in these needs not only the justification, but the absolute necessity of an Association with a large membership—it should be at least ten thousand—drawn from the intelligent people of the whole country.

5. The social intercourse and personal contact of scientific societies and meetings are among their most important functions. Men in isolation become selfish and incompetent. Even a great genius does not work in solitude, and certainly the ordinary man requires the interest and enthusiasm that is only evoked in the give and take of personal acquaintance and conversation. Eating together, drinking together, smoking together, may have physiological drawbacks, but the psychological stimulus has war-

ranted the origin and survival of these practices. Those studying similar problems, and those working in diverse directions; the university professor, the school teacher and the government officer; those who call their science pure and those who seek to make it useful; the beginners and the old benchers, all should be thrown together, ready to learn and help, to agree and differ. Each should be prepared to profit much, and if need be to sacrifice a little for the common good. The meetings of the Association do, of necessity, accomplish a great deal in bringing men together, but perhaps not all that could be desired. The cultivation of personal acquaintance between professional men of science and the amateur and outsider is also important, but more difficult to manage. The social features of the British Association seem to be more successful than our own. A thousand or more of the leading citizens of the place become temporary members for each meeting, and freely offer entertainments of one sort or another. The social conditions are, of course, different in America, but it seems that the entertainments and excursions might be made more pleasant and profitable in the future.

6. Of all the important functions of a national scientific association, the most essential is the general organization of science. The science of the country absolutely requires a central legislative body. Such bodies exist in other nations, having varying degrees of usefulness, and there is more need of an active and efficient representation of scientific interests in the United States than in any other country. London, Paris and the other European capitals, with

their societies, clubs, etc., bring together all the scientific men of the country, whereas here they are widely scattered, and will become still more so as the East loses its intellectual precedence. Washington will doubtless be our chief center for scientific research, but under our system of State governments and with our privately endowed institutions, it is not likely that it will occupy the position of European capitals. The great development of scientific work under the national government, the numerous smaller centers under the State governments at their capitals and universities, the municipalities with their increasing tendency to support museums, libraries, etc., and to undertake functions requiring scientific experts, the great incorporated universities developing special research, the applications of science in industries, transportation, etc.—all these represent an extraordinary activity, and, at the same time, a dispersion of tendencies and interests that require here more than in any country some unifying and centralizing organization. The functions of such a body are only limited by its efficiency. Our government recognizes a division into executive, legislative and judicial functions, but does not recognize the coordinate importance of expert opinion. As the judicatory interprets the laws made by the legislature, so the legislature requires impartial advice and scientific knowledge as the basis of its enactments.

The question now arises as to what body or bodies should perform the functions thus outlined. In the first place, it is evident that we need numerous and partly inde-

pendent institutions. Each university, museum, survey, observatory, botanical garden, laboratory and the like is a unit, requiring its special organization. Each city should have a local academy, or alliance of societies, which in its field should perform most of the functions that we have been considering. Similar academies, or groups of societies, are needed for a State or region. National societies are required for each science. But what should be the national organization that will bring all the local and special societies together, and accomplish for the nation and for science as a whole what these institutions and societies do for a locality or a single science? We have at present the National Academy of Sciences and the American Association for the Advancement of Science, both of which have to a certain extent filled these requirements, but only in a partial and imperfect way. The Academy is legally the adviser of the government, the Association has brought into its organization a majority of the scientific men and many of the scientific societies of the country; but it seems probable that neither a small self-perpetuating body of eminent men nor a plebiscite of all scientific men will perform the duties required. Representative government, in spite of its partial failures, is the kind of government under which we should live and must live. We find this most nearly embodied in the council of the American Association. This council might be made the representative body for science in America.

If it be asked what the American Association and its council should do to assume

the position assigned to them, the reply may fortunately be made: Let them continue the work that they have already begun. The whole matter is one of attitude and spirit, rather than of constitution and by-laws. Let all scientific men be fellows of the Association, make the members representative of the intelligence of the country, unite all scientific societies and institutions in the organization of the Association, make the meetings important and interesting, let the council assume and deserve authority.

While the position of the Association must depend chiefly on natural fitness and development and on the spirit and character of its members, there are certain changes in organization that deserve consideration. We shall suggest some modifications which appear to be either desirable at present or objects to be kept in view.

Affiliated societies should be represented on the council, and all scientific societies, whether national or local, should be affiliated with the Association. The number of representatives allowed from each society should be proportional to the number of members of the society among the fellows of the Association. For example, each institution having ten fellows might be allowed a representative and an additional representative for each additional twenty-five fellows. This plan includes the representation of local academies, universities, government departments, etc., on the council, but might begin with the societies meeting with the Association, in accordance with an amendment to the constitution now pending. It might be well for the

council to elect each year three additional members to serve for a term of three years. Those so elected would probably be among the most efficient members of the council. The council would thus be considerably enlarged, but its authority would be greatly increased. It is of course understood that the real work of legislative bodies is done by committees, and the committees of the council should be organized with special care.

The executive officer of the Association is the permanent secretary, and his influence should be very great. He should either be paid a reasonable salary, say \$5,000, and devote his whole time to the Association and the organization of science in America, or should be, as our present secretary, a man of unusual executive ability, having under him one or two assistant secretaries who should devote themselves to the work. The secretaries of the sections should be among the most efficient members of the sections, and should be elected for a term of three years and reeligible.

The meetings should be more thoroughly organized in advance, more authority being vested in the permanent secretary and council. As suggested above, public lectures and discussions on the important advances and current problems of general interest should be arranged. For example, this year there should be reports on the relation of mosquitoes to disease, on the newly established Bureau of Standards, on the conduct of a national observatory, on the natural history and resources of the West Indies and the Philippines, and, in view of the place of meeting, on mining and irrigation.

The time of meeting has always interfered with success. Men of science will not and can not come together at midsummer. If a week can be set aside at the beginning of the year, it is probable that the scientific character and weight of the meetings will be greatly forwarded. The importance of obtaining a convocation week in midwinter has been emphasized in a recent editorial (April 26, 1901), and we are now able to report that, of the fourteen universities comprising the Association of American Universities, all but two either already have no exercises at the time or have altered their calendars in the direction of setting aside the week in which New Year's Day falls for the meetings of scientific and learned societies. It might, however, be well to have, say once in three years, a summer meeting in which the social and excursion elements should be emphasized. It must be remembered that the National Educational Association can bring together 10,000 members in this way. Or perhaps, it will be found with experience that the winter meeting is so advantageous that the summer meetings can be omitted altogether. Meanwhile there might be suggested a special meeting at Chicago next year at Christmas time in conjunction with the Naturalists and affiliated societies, the usual meeting at Pittsburg in midsummer, and a meeting of unusual importance at Washington at the end of the year.

*A KINETIC THEORY OF EVOLUTION.\**

IN 1895† the opinion was expressed that the differentiation existing in certain fami-

\* Read before the Biological Society of Washington, May 4, 1901.

† *Proc. U. S. Nat. Museum*, 1895, 18 : 64.

lies of Chilopoda represents the results of variation accumulated without the interference of natural selection. In the next year\* the same proposition was applied to the class Diplopoda, and studies in other groups, such as the termites, fungi, hepaticæ, mosses, ferns and flowering plants have led to the belief that there is little ground for the supposed stability of organic form and structure which furnished the basis of the doctrine of the separate creation of species, and which still figures as an important postulate in theories of evolution through natural selection. The Diplopoda are one of the many classes of animals and plants in which ecologic relations are essentially different from those of the mammals, birds, and other highly specialized groups upon which evolutionary studies have largely been based. Among the Diplopoda are to be found very few of the adaptations so numerous among the true insects; Diplopoda do not eat each other, and are not eaten by other animals; † their food requirements are not specialized, and decaying vegetable matter is generally abundant far in excess of their needs. There is seldom a suggestion of a struggle for existence or of other conditions indicating an active principle of selection. At the same time there is no lack of morphological differences, and while the present or past absence of selective influence in any particular character cannot, of course, be demonstrated, the phylogenetic, biologic and ecologic unity of the group, when contrasted with its structural and evolutionary diversity, seems to justify the opinion that in this class, at least, evolution is a kinetic phenomenon or active process of organic change, instead of the result of a passive subjection to external interference in otherwise stable conditions.

\* *American Naturalist*, 1896, 30 : 682.

† SCIENCE, N. S., Vol. XII., October 5, 1900, p. 518.

#### EVOLUTION BY INTEGRATION.

Examples of groups of characters which it seems impossible to look upon as of selective origin have been noticed in another place.\* Moreover, it is scarcely necessary to detail particular instances, since for a proposition partaking of the nature of a general law every biologist should find ample supporting evidence inside the field of his own specialty. Kinetic evolution is, indeed, nothing new, and requires for its formal recognition little beyond the most obvious facts of natural history; doubtless it would have been appreciated and accepted years ago had not makers of static theories protected themselves against so simple an inference by inventing the so-called principle of panmixia, under which it is argued that spontaneous progressive change is impossible in a large group of individuals, because fortuitous variations occurring simultaneously in all directions are brought back to a stable average by intercrossing.

In reality, however, this proposition is worthy of little of the deference due to a mathematical axiom; biologically it rests on unproved and apparently unprovable assumptions. We have by no means ascertained that the individuals of a species tend to vary equally in all directions with respect to all their characters; on the contrary, some variations are much more common than others. We have not ascertained that the crossing of individuals showing different variations always results in average offspring; we know instead that the next generation often exceeds both its parents in the accentuation of some new characteristic. In its logical development panmixia, if true, would constitute a demonstration that individual variation acting through heredity cannot contribute to the evolutionary progress of a species; it is as

\* 'The Diplopod Family Oxydesmidae,' a paper prepared for the Proceedings of the U. S. National Museum.

though individual influence were a wave raised by a pebble, and not a permanent elevation of level. Individual differences could in this view affect the evolution of species only when interbreeding is prevented by some form of isolation, a supposition which has received apparent support from the finding of many distinct species in small islands or other circumscribed localities. That isolation tends to the rapid *differentiation of specific types* affords, however, no proof that *progressive change* is due to isolation, geographical or selectional. That a certain peculiarity is manifest in all the individuals of an insular or strictly circumscribed species may mean, not that all the individuals are descended from a single peculiar ancestor, but that the change tendencies which have originated in this locality have been confined to it, and have not been able to propagate themselves beyond the natural barriers.\* In the absence of such limits specific differentiation might not have taken place, but evolutionary progress might have been greater by reason of access to more varied developmental tendencies. Specific differentiation thus affords but little indication of the rate or nature of evolutionary progress, which often appears not to be the result of isolation at all, but rather of the aggregation and integration of individual variations welcome to the organic constitution. In this aspect of the subject isolation may be viewed as the absence, rather than as the result, of selection.

\* The stability or fixity of type which has been ascribed to small segregations of plants and animals is only relative, even under careful artificial selection, and from the standpoint of biological history is to be interpreted as uniformity rather than as permanence. Among the molluscs, which have been supposed to furnish examples of great permanence, very diverse animals are now known to inhabit shells of extreme similarity. Evidently the external skeleton is not an adequate index of evolutionary status: in some families variation seems to have principally affected the shells, in others the softer parts.

Species, which have been thought to support the opinion that selection brings about evolution by inducing various degrees and kinds of isolation, can often be much more rationally interpreted as instances of the manifestation of spontaneous developmental tendencies. Groups like the Diplopoda illustrate the infinity of combinations of characters possible without the assistance of any of the influences commonly invoked to explain the specializations of the more adaptive organisms, and thus permit us to realize that evolution is one of the causes, instead of a result, of biological isolation, the effects of which are probably limited to specific differentiation.

To have confidence in organic evolution accomplished by selection and isolation in the presence of an efficient panmixia would require at least double the credulity needed to equip the earth from the original pairs of the Garden of Eden or of Noah's Ark, since the ancient accounts provided two parents for each species while the modern begins with one, the offspring of which must be placed under such conditions that they are prevented from mixing with the parental type, either by means of geographical separation or through circumstances which give the variety immediate and exclusive advantage over the older forms. The only alternative would involve the origin of species from sports so extremely divergent that their offspring would remain distinct after considerable dilution with the parent form. The maintenance of such differences through the prepotency of new types, in accordance with the kinetic view, could not, of course, be invoked under theories accepting panmixia.

Moreover, it should not be forgotten that all segregations of small numbers of individuals involve the necessity of close breeding, which has been found in domesticated animals and plants to lead in many instances directly toward abnormal and

even pathological characteristics, and which is also commonly recognized as weakening vitality and vegetative strength. Thus many high-bred varieties of plants are nearly or quite seedless, while in others the germinating power of the seed is very low, facts that afford a strong indication that general evolutionary progress has not been greatly favored by segregation.

Although the breeding of domestic animals and plants has generally been directed toward the accentuation of some one feature or limited group of characteristics desirable for economic reasons, it should be remembered that, in nature, evolutionary progress must carry with it improvement in total organic efficiency, which in turn depends upon almost an infinity of morphological and physiological coordinations, the perfection of which would be assisted rather than hindered by the access to a great variety of evolutionary tendencies or suggestions.

From the evolutionary standpoint a species is not a definition or a complex of characters, more or less important, but a group of organic individuals which stand in a definite biological relation of reproductive accessibility. Species do not arise and are not separated in nature primarily by the degree or amount of difference which may exist between individuals; in some groups species contain greater diversities than appear elsewhere between genera, families or orders. Interbreeding prevents the subdivision of species, but at the same time conduces to variety instead of maintaining stability. Species become distinct in nature not only when the component individuals are separated by geographical or other forms of isolation, but accumulated variations may themselves bring about isolation when evolutionary tendencies become so divergent that further coordination is difficult, and interbreeding ceases. Evolution is thus a process of integration rather than

of segregation, and organic progress, like intellectual and social advancement, is not an individual phenomenon, but the accumulated result of individual contributions which are not lost, but saved, by interbreeding or communication to others. Isolation permits the accentuation of individual peculiarities, but does not on that account conduce to intellectual or social development; selection may encourage specialization, but it often limits the field of subsequent changes and adaptations necessary for the perpetuation and continued welfare of the species.

The various forms of selection and isolation represent, as it were, the outside of evolution, the points at which it is affected by external accidents. Organic development is not, however, a passive, but an intensely active process; selection and isolation have not caused evolution, but are among the conditions under which it sometimes proceeds.

The crossing of geographically distinct species often results, not merely in the production of intermediate forms, but in new types having characters not represented in either of the parents, and since the same result often follows the crossing of divergent forms of the same species, we have a further reason for believing that progressive change is not dependent upon, but may even be impeded by, selection and isolation, and that interbreeding rather than segregation is favorable to evolutionary progress. Static theories have thus reversed the true functions and effects of panmixia and isolation.

#### DARWINISM AS A STATIC THEORY.

Phylogeny and ecology were combined by Darwin as different sides of the same phenomenon, and environment was held at once to cause variation and to produce indefinitely extensive changes by means of it—a theory here described as static because



it predicates the normal stability of organic series.\*

The configuration of a valley may determine the banks of a river which flows through it, but the valley does not cause

\* "But let the external conditions of a country alter \* \* \* the original inhabitants must cease to be as perfectly adapted to the changed conditions as they were originally \* \* \* such changes of external conditions would, from their acting on the reproductive system, probably cause the organization of those beings which are most affected to become, as under domestication, plastic. Now, can it be doubted, from the struggle each individual has to obtain subsistence, that any minute variation in structure, habits or instincts, adapting that individual better to the new conditions, would tell upon its vigor and health? \* \* \* Each new variety or species, when formed, will generally take the place of, and thus exterminate, its less well fitted parent. This I believe to be the origin of the classification and affinities of organic beings at all times; for organic beings always seem to branch and sub-branch like the limbs of a tree from a common trunk, the flourishing and diverging twigs destroying the less vigorous, the dead and lost branches rudely representing extinct genera and families."

Quite as definitely did Wallace state the same proposition in countervailing the somewhat more narrowly static idea that the variations of species are limited, as it were, to fixed points beyond which they cannot go in nature, or to which they must return if differentiated from the wild type by artificial selection.

"But \* \* \* there is a general principle in nature which will cause many varieties to survive the parent species, and to give rise to successive variations departing further and further from the original type, and which also produces in domesticated animals the tendency of varieties to return to the parent form. \* \* \* Granted, therefore, a 'tendency' to reproduce the original type of the species, still the variety must ever remain preponderant in numbers, and under adverse physical conditions *again alone survive*. But this new, improved, and populous race might itself, in course of time, give rise to new varieties, exhibiting several diverging modifications of form, any one of which, tending to increase the facilities for preserving existence, must, by the same general law, in their turn become predominant. Here, then, we have *progression and continued divergence* deduced from the general laws which regulate the existence of animals in a state of nature, and from the undisputed fact that varieties do frequently occur."

the water to run down hill. In the absence of this property of water valleys would be quite powerless to 'give rise' to rivers. Similarly, it is true that environment influences organic evolution; it may accelerate or retard, deflect or even set absolute barriers to change, but these facts afford no reason for believing that selection represents a biological force. The vital river, when unconfined, is in motion; change is a law of organic succession; evolution is a property of protoplasm.

Some rivers have direct courses, deep channels and swift currents; the water reaches the sea without much loss of time; with such streams is comparable the evolution of the organic groups which an active selection has kept well within the lines of utility, whose functional organization is so perfect that a useless structure or an unprotective color is looked upon as an anomaly requiring special explanation. There are, however, other rivers the waters of which give no suggestion of haste: they meet innumerable turns, eddies and backsets, they are divided by islands, and often overflow the land. With such rivers may be compared the evolution of groups like the Diplopoda, not confined by too exact requirements of utility, and hence the better able to manifest the natural tendency to indefinite change.

Darwin and Wallace recognized the fact that a species does not constitute a single morphological point, but that the projection of its characters requires a surface of appreciable area. And assuming that there is a tendency or law by which such an area remains even approximately constant in size, they found that it could be given a progressive motion by taking away from one side while permitting the other to grow out. Thus it appeared possible by predicating external causes to explain evolutionary progress with but a slight readjustment of the traditional static view of organic

life, a view which thus persisted and is still generally held.

Subsequently, both Darwin and Wallace admitted progressive variation without natural selection, which was considered to be but one of several factors contributing to evolution. The original statement, however, continues to represent Darwinism in the scientific world, and, as has been well said,\* "The biologist of to-day is more Darwinian than Darwin, and explains on the Darwinian hypothesis even those cases which had presented difficulties to Darwin's own mind." This tendency signifies that the inadequacy of all other explanations has become more and more thoroughly realized, thus causing a return to Darwin as the author of the only real contribution to the study of biological causes. The static or selective theory of evolution has, however, attained its present popularity, not because it has been shown to have any universal application in nature, but because it has remained the only suggested explanation which seemed to be supported by definite and particularized phenomena.

#### VARIATION AND CONJUGATION AS KINETIC PHENOMENA.

It is probable that in the study of biological motion it will be found desirable to distinguish at least four types of variation or kinds of differences between closely related organisms. Some modifications may be described as mere chemical or physical reactions to definite substances, forces or conditions; † some are more clearly patho-

logical and are the result of inherent weakness or derangement of the organism; while others are normal vibrations or fluctuations of form, size, color or other characteristics having, perhaps, no very definite single cause, nor any pronounced tendency to repeat themselves. Essentially different, though often confused with one or the other of the above, are the peculiarities which represent lines of change or divergence, upon which the organic series if unhindered may proceed with no diminution, but rather with an increase of structural and physiological efficiency, and often with persistence and rapidity. To this class belong the 'sports' which come true to seed and yet show no signs of debility, and which, though crossed with the parental type, impress their characters upon a large majority of the offspring. In other words, variations of this kind are prepotent because they open avenues of advance and adjustment welcome to the organism and necessary to the maintenance of the efficiency of protoplasmic structure and function.

Variation and conjugation may thus be supposed to minister to the same requirement of the protoplasmic organization. There is little or no warrant for the current belief that variation and heredity are phenomena essentially connected with sexual reproduction, and thus explainable through a knowledge of the structure and mechanism of conjugating cells. In final analysis reproduction is not a sexual but a vegetative process. Because in some groups the conjugation of nuclei is an indispensable preliminary to reproduction,\* the most

neither of these alternatives, but merely that the skin of *Proteus* is capable of the photic reaction which generally influences the formation of pigment.

\*SCIENCE, N. S., 1900, XII., pp. 940-946. In this presentation of Professor Hertwig's views the issue is still obscured by a residue of the former terminology. Thus on page 943 we read that "the sexual reproduction of Metazoa is a continuation of the method of reproduction in the Protozoa, while the budding and

\* Haycraft, 'Darwinism and Race Progress,' London, 1900, 28.

† According to Professor Osborne: "When the pale *Proteus* is taken from the Austrian caves, placed in the sunlight, and in the course of a month becomes darkly pigmented, there are two interpretations of this pigmentation; either that we have revived a latent character, or that we have created a new character." *American Naturalist*, May, 1899, p. 431. It would seem, however, that this experiment may prove

intimate of causal relations have been inferred, in spite of the existence of many forms of reproduction not so preceded. From the morphological standpoint there is every gradation from parthenogenesis or the development without fertilization of cells which are normally fertilized, to the simplest case of plants multiplied by branching root-stocks. From the evolutionary standpoint such differences are of comparatively little moment; all organisms seem to be variable, whatever their methods of reproduction. There is, however, a general law that the more specialized the organism and its reproductive processes the smaller are the probabilities that conjugation can be dispensed with. It is as though complexity of organization required a higher tension of the protoplasmic structure which could not be maintained without conjugation, rest or change. Thus among animals of high organization there are but two conspicuous instances of normal parthenogenesis, the bees and the plant-lice, and in both of these the generations, sexes or castes produced without conjugation are inferior, specialized and unable to maintain the existence of the species. The rela-

fission of Metazoa are adjustments having only an outward resemblance to the budding and fission of Protozoa." While processes, like organisms, must have a common origin if genuine homologies are to be established, it seems obvious that on the plane of Professor Hertwig's discussion conjugation and reproduction are directly comparable throughout organic nature. Current errors are not so much in the direction of mistaking the nature of the processes, as in failing to observe that what is termed 'asexual reproduction' in simple organisms is generally called 'growth' in the more complex. From the cytological standpoint there are two sets of phenomena in both plants and animals, conjugation or fertilization and fission or growth by cell multiplication. The association and specialization of cells in compound organisms (Metazoa and Metaphyta) have given rise to a great variety of independently acquired reproductive adaptations superposed upon conjugation and fission, but different in category, and having neither phylogeny nor homology with those processes.

tive frequency with which parthenogenesis and asexual reproduction are maintained among the lower animals and plants, in connection with parasitic or saprophytic habits suggests the further possibility that protoplasmic compounds of high complexity may be utilized as partial or complete substitutes for conjugation. Cytologists might thus find it worth while to ascertain, if possible, the exact nature of the protoplasmic relations between parasite and host.

#### CHEMICAL AND MECHANICAL THEORIES.

Chemical theory has advanced to the point where different qualities of compounds are explained by reference to positional relations between the component atoms, but behind this lies the question of the nature and qualities of the elemental substances themselves. By common consent the molecular constitution of protoplasm is admitted to be almost unimaginably complex and still utterly inaccessible and intractable from the chemical side. Nevertheless, we recognize that the qualitative or potential differences of protoplasm extend not only to species, but actually to individuals, and yet some biologists are attempting to grasp these ultimate differences before solving the problem of the physical and the chemical groundwork of protoplasmic structure.

A solution of evolutionary problems on this basis can be expected only by those who remain regardless of the fact that the already insurmountable physical and chemical difficulties would be, as it were, multiplied by infinity under theories which imply that not only the complexities of the organic constitution, but also the endless details of individual difference, are symbolized, materialized or predetermined by positional or other relations of atoms, to say nothing of the chromosomes or granules which some have taken to be the actual organs of protoplasmic foreordination. Similar theories invented by theologians

have been set aside by biologists as crudely anthropomorphic. In reality the immediate causes or mechanisms of evolution are as completely unknown as those of the other spontaneous or active properties of protoplasm. Until more light can be shed upon the physical and chemical how and why of assimilation, growth, irritability, motility and reproduction, we can scarcely expect to attain an adequate comprehension of the process which represents a continuous summary of these organic activities.

The center of activity or citadel of the protoplasm of cells is located, evidently, in the nucleus, and there are also reasons for believing that the number, position or other relations of the chromatin bands have important functions in the processes of cell division, and possibly also in determining the relative preponderance of the parental influences. But such facts are very far from proving that either heredity, variation or the resultant evolutionary motion is controlled by purely cytological processes, or that there is any such thing as a 'hereditary mechanism.'\* Developed to their logical conclusions, theories of determinants coincide with Nüegeli's attempted deduction of the organic universe from the chemical and physical structure of protoplasm, in ignoring the fact that even in the highest organisms cells are still cells, and that from the cytological standpoint they are not improved, but degraded by specialization. A complex organism is more than the component cells, and evolution is not only a cytological, but a social and supercellular

\*The well-known phenomena of asexual reproduction, parthenogenesis and replacement of lost parts should have saved us from theories of localized and mechanical heredity, but if further proof is needed it is now available in the experiments of Loeb in artificial parthenogenesis, those of Delage and others with enucleated fragments of eggs, and those of Mr. A. J. Pieters in growing normal plants from pieces of cotyledons.

process. Life itself is the 'unknown factor,' or neglected cause, which vitiates the theories of those who expect a complete expression of organic phenomena in terms of current conceptions of matter and molecular and atomic forces.

Under cytological or intracellular theories the evolution of unicellular organisms must involve principles fundamentally distinct from those required in multicellular groups, with a similar gap intervening when compound individuals and social units are being dealt with. But if we look upon evolution as a normal property of protoplasm no such complications need be met, higher acquirements being added by gradual superposition. In nature, moreover, there are no breaks in the chain which connects simple and complex types of individuality. Beginning with the absolute individuality of some unicellular organisms where each cell may compete directly with every other cell, we have all grades of association and adhesion; also when the individual compacted of similar and equivalent cells is traced to the point where it begins to manifest increasing differentiation of parts into special tissues and organs. Equally perfect is the series of social adaptations and instincts, through simple aggregations or flocks, to the complex caste differentiations of the highly organized colonies of the social hymenoptera and termites.

A general law of biological evolution must embrace the morphology, physiology, ecology, psychology, ethnology and sociology of the entire organic series, to say nothing of still more general or philosophical applications. But while any process of gradual change and readjustment would bear the teleological interpretation of natural selection, that theory does not furnish an adequate explanation or supply causal connection for the succession of phenomena encountered in any department of biological study.

## COROLLARIES AND CONCLUSIONS.

It will readily be understood that the center of gravity of evolutionary theories will appear to change on admitting the correctness of a kinetic view, and this not only in strictly biological, but in other related lines of thought. Time and space are alike wanting for the canvass of such readjustments; it is possible in the way of summary and conclusion only to notice in a brief and disconnected manner a few of the corollaries and subsidiary theories accommodated or suggested by the belief that evolution is a general property of protoplasm, and not the function of a special mechanism or a reaction to external stimuli.

The differentiation of species is a phenomenon distinct from evolutionary progress; isolation may conduce to the former while retarding the latter.

Selection, acting through isolation, affects evolution by influencing the direction and rate of progress with respect to particular characters; that species may originate through natural selection does not, however, prove that selection is a cause of organic change or of evolution.

Variation furnishes the differentials of which evolution is the integration; selection and isolation may affect the equation either as positive or as negative quantities. Specific differentiation is a direct function of selection and isolation, but evolutionary progress is often an inverse function.

Groups having large, complex and variable species, or numerous closely related species, are in a state of active evolution, while those in which species and genera are few, small and uniform have passed the zenith of their evolutionary history. Thus the compositae and hymenoptera are prosperous, while the cycads and diplopods are on the decline. Primitive characters are to be sought in insular or circumscribed species rather than among related continental or

widely distributed types. Static theories would compel contrary inferences.

In large and widely extended species uniformity or diversity of characters depends upon relative facility of distribution; the more rapidly new characters can be disseminated the greater the uniformity of the species. Such uniformity should not, however, be interpreted as stability, which may be relatively greater in locally diversified species.

That diversity is not conditioned upon segregation, but is distinctly favored inside the limits of species, also seems obvious from the differentiations of sex, caste, dimorphism and other similar specializations. Moreover, these phenomena do not represent a single device or adaptation, but have appeared independently in many natural groups.

The relative importance of natural selection has differed greatly in the evolution of the various natural groups; in a general way it may be thought of as proportional to ecological diversity.

Evolution is not a special process or function, but appears in all types of individuals from the unicellular through the various grades of polycellular and compound organisms to the caste-differentiated colonies of the social insects; it accompanies both sexual and asexual methods of reproduction, seedless plants and insects derived from unfertilized eggs continuing to vary and differentiate.

Evolution is both cellular or cytologic and supercellular or organic; the former appears in simple types and in the component cells of higher groups; the latter is a social phenomenon having no obvious or necessary connection with cytological processes.

In some groups it has been ascertained that evolutionary characters or conditions which first appeared in the adult are subsequently passed back into preliminary or

embryonic stages; such facts do not, however, establish a general law of retrogression or recapitulation, since the metamorphoses of insects and other similar phenomena show that evolutionary deviations and adaptations may occur at any stage in the life histories of organisms.

The adaptability of an organism is in general inversely proportional to the degree of ecological specialization already attained. Accordingly, highly specialized types tend to become restricted and to disappear, while the more primitive may persist and give repeated demonstrations of the evolutionary tendencies or variational possibilities of the group.

Parallel evolution is thus not necessarily adaptive or mimetic, and may often be interpreted as an indication that a tendency to a particular variation may outlive specific differentiation and become similarly accentuated, even in groups in which long separation has permitted the accumulation of many differences in other characters.

From the standpoint of a kinetic theory the inheritance of acquired characters becomes a purely formal question; indeed, it may be said that the origination and inheritance of characters are but different statements of the same fact, since characters originate and are extended because of the same inherent tendency to change.

The continued differentiation of vestigial organs and structures shows that there is no essential connection between evolution and use. The vast majority of variations, and specific differences are also obviously non useful; they arise, are prepotent and are perpetuated because they are different and new, rather than through any external influence or necessity.

All hereditary characters are acquired, but not all acquired characters are hereditary. There is no reason to believe that any are hereditary which have not been acquired through the assistance of normal

variation. Mere mutilations or reactions to external conditions are not hereditary. Evolution is essentially a process of acquiring characters, but no direct nexus between environment and heredity has been demonstrated, and none is necessary under a kinetic theory.

A kinetic theory enables us, in short, to recognize the varied facts of evolution without doing violence to any of them. While holding that all evolutionary changes are essentially the same in having an internal and spontaneous origin, we are still not compelled to deny that adaptations have been influenced by external agencies. Selection represents, however, not the causes, but the external incidents of evolution. Persistent variation should be compared with the main spring, selection to the balance-wheel, of an organic creation which progresses because new characters and powers are welcome, rather than because old types are exterminated.

O. F. COOK.

WASHINGTON, D. C.

#### THE LATE MILES ROCK.

MILES ROCK, a notable scientist, born at Ephrata, Lancaster county, Pennsylvania, October 10, 1840, died on January 29, 1901, in his sixty-first year.

During boyhood he attended the public schools of Ephrata, and later the Lancaster High School, fitting himself for Franklin and Marshall College. At the outbreak of the Civil War he was pursuing his studies at this college; but love of country and the trend of public spirit at the time prompted him to join the Pennsylvania Volunteers and proceed to the seat of war. He remained a soldier at the front until the close of the war; and it is significant of his character that he carried in his knapsack a copy of Gray's 'Manual of Botany,' and employed his leisure in collecting and analyzing the plants observed in the campaign.

At the close of hostilities he entered Lehigh University, which Asa Packer, the philanthropist of Lehigh Valley, had just founded and established at South Bethlehem; he graduated as Civil Engineer with the first class of Lehigh in 1869. Of the three young men who entered Lehigh in 1866 and formed the first graduating class of this now famous institution of learning, two are gone—J. H. Hind Corbin, and now Miles Rock; the third, C. E. Ronaldson, a mining engineer, of Philadelphia, survives. Mr. Rock's graduating thesis was on 'Forest Trees'; and he treated the theme in physical, moral and scientific aspects, evincing thorough familiarity with the subject, and such originality and breadth of thought as to gain the hearty approbation of his fellow-students, with whom he was highly popular. Immediately after graduation, he became instructor in mineralogy and geology at the University.

In 1870 Mr. Rock married Miss Susan Clarkson, and subsequently accepted a position as astronomical assistant to Dr. B. A. Gould, director of the Cordoba Observatory, Argentine Republic. This he retained until 1873, participating in the *Durchmusterung* or Zone work, undertaken by Dr. Gould, and in mapping the multitude of star observations of the southern heavens. The results of his astronomical work at Cordoba are embodied in 'Uranometria Argentina,' published in Buenos Ayres in 1879.

In the autumn of 1874, Mr. Rock co-operated with Commander F. M. Green, of the U. S. Navy, in determining latitudes and longitudes, by means of submarine cables, in the West Indies and Central America, for the use of the Hydrographic Office. He was occupied in this work until 1877. During the two years immediately following he served as a field astronomer in the U. S. Geographical and Geological Surveys west of the 100th merid-

ian under Lieutenant George M. Wheeler, of the U. S. Engineers, and determined latitudes and telegraphic longitudes in several of the western states and territories. On July 1, 1880, he was appointed assistant astronomer at the U. S. Naval Observatory, and served acceptably in that capacity at the transit circle under the immediate direction of Professor John R. Eastman, U. S. Navy. In 1882 he was detailed to aid Professor Lewis Boss in the observation of the transit of Venus at Santiago de Chile in December of the same year.

On the recommendation of the U. S. Government, Mr. Rock was appointed astronomical engineer for Guatemala in 1883; and for fifteen years he served as Chief of the Guatemala Boundary Commission, charged with the duty of determining and locating the disputed frontier between Guatemala and Mexico. To his technical knowledge, diplomatic skill, strong sense of justice, and invincible courage, Guatemala unquestionably owes the retention of her rights in certain valuable lands in the district of Peten, which had been claimed by Mexico, even to the point of threatened hostilities.

As a Commissioner Mr. Rock was highly regarded by the Guatemalan authorities, especially as he seldom failed to evince a ready and deep interest in the people, and in the development of the resources of the republic. During his incumbency he also served as the delegate of the Guatemalan Government to the International Congress at Washington in October, 1894, which adopted for the nations represented the uniform zero-meridian of Greenwich for maritime purposes.

On the completion of his official work for the Guatemalan Government, in 1898, Mr. Rock remained in the country, devoting himself to private interests.

Mr. Rock never ceased to take a keen interest in the affairs of his *alma mater*;

and on the formation of a Lehigh alumni association at Philadelphia in 1870 he was chosen its first president, and a few years later was appointed an honorary alumni trustee. He last visited Lehigh on the occasion of a reunion of the alumni in 1897, when he delivered an address. He was a frequent contributor to the collections of the several scientific departments of the University, and many of his collections are preserved in the University Museum. A nominal resident of, and frequent visitor to, Washington, he took a prominent part in the scientific activities of the Capital. He was one of the founders of the Anthropological Society of Washington, and of the Cosmos Club; he was also a member of the Washington Academy of Sciences and of the National Geographic Society.

Mr. Rock's death was sudden, resulting from acute gastritis followed by heart failure. The sad intelligence was reported to the State Department on the second of last February, by United States Consul-General McNally of Guatemala.

In recognition of the great worth of the services which Mr. Rock had rendered to Guatemala during the years of his official activities there, the Government of that country took charge of the funeral, and he was buried in the cemetery of Guatemala City with public honors under the personal direction of President Cabrera. In their official reports to the Department of State, the representatives of this country in Guatemala showed that Mr. Rock was universally mourned, and that no such funeral honors had ever before been accorded to anyone but the highest officials of the country. The most affecting if not the most impressive feature was the attendance of hundreds of poor natives, who had known Mr. Rock and experienced his never-failing kindness and generosity, who silently and tearfully followed him to his last resting place. Simple in their own lives and

thoughts, they paid the only tribute at their command to the man whose singleness of purpose, love of justice and warmth of heart endeared him to all who knew him. Peace be to his ashes!

Mr. Rock leaves a widow, a married daughter, Mrs. F. L. Ransome, and a son, Alfred Mayer Rock, all of whom reside in this city.

WILLIAM EIMBECK.

WASHINGTON, D. C.,  
April 22, 1901.

OTTO LUGGER.

OTTO LUGGER, State Entomologist of Minnesota, who died May 21, from pneumonia, after a very short illness, was one of the most widely known of the many Americans of German birth who have obtained high scientific reputation in this country. He was born at Hagen, Westphalia, September 16, 1844. His father was a professor of chemistry in a Prussian university. Lugger was educated in Hagen, and in 1864 became a lieutenant of cavalry in the Prussian army. In 1865 he came with his parents to the United States and secured a position with the engineer corps of the army, and for two years was engaged in the survey of the Great Lakes. He had always been interested in entomology, and collected specimens while engaged in his engineering work. He became acquainted with the late C. V. Riley, who at that time was occupied in newspaper work in Chicago, and, when in 1868 Riley was appointed State Entomologist of Missouri, Lugger went with him as his assistant. During the years 1868 to 1875, when Riley established his great reputation as economic entomologist and published eight of the nine annual reports which brought him lasting fame, Lugger remained his quiet, unassuming, self-sacrificing and devoted helper. In 1875 he married Lina Krokmaun and went to Baltimore, where he became the curator of the



Maryland Academy of Sciences and naturalist of the city parks. In 1885 he was appointed assistant in the Division of Entomology of the U. S. Department of Agriculture, remaining in Washington until 1888, when he was appointed entomologist to the State Agricultural Experiment Station of Minnesota, publishing his first bulletin in this new office July 3, 1888.

His first entomological experience in the State of Minnesota was one of great interest and importance, and his vigorous and intelligent action in the face of a great emergency fixed his standing as a most useful officer firmly in the minds of the Minnesota farmers. An enormous swarm of the Rocky Mountain locust or western migratory grasshopper had settled down in Ottertail County. By Lugger's advice and energetic field work, backed as he was by a public-spirited and intelligent governor (Hon. W. R. Merriam, now director of the U. S. Census) who personally guaranteed the funds necessary for the campaign, the hordes of destructive insects were annihilated and great damage was averted.

From that time to the time of his death, nearly thirteen years, Lugger's work was most active; his publications were frequent, and he gained the profound respect of his constituents and of the scientific men of the country. His bibliography, covering about thirty titles of record, comprises almost exclusively articles on economic entomology, but he was by no means a one-sided naturalist. He was a good botanist and published several papers concerning plant diseases, notably his article on the black rust or summer rust (Bulletin 64, Univ. Minn. Agric. Exp. Station).

Some years ago he began the publication of a series of large papers which when brought together would have formed an elaborate treatise on the entomology of Minnesota. The parts which had been published were an extensive paper on the

parasites of man and domestic animals (Bul. 48, 1896, Minn. Agric. Exp. Sta., pp. 72-270, figs. 187, plates 16), the Orthoptera of Minnesota (Bul. 55, 1897, pp. 91-386, figs. 187), the Lepidoptera of Minnesota (Bul. 61, 1898, pp. 55-334, figs. 237, plates 24), the Coleoptera of Minnesota (Bul. 66, 1899, pp. 85-331, figs. 249, plates 6), and the Hemiptera of Minnesota (Bul. 69, 1900, pp. 1-259, figs. 200, plates 15). It is a great pity that Lugger did not live to complete this series, since the elaborate numbers were profusely illustrated and were prepared with great care and written in a most interesting style. At the time of his death he was preparing the part on Diptera, in which he intended possibly to include the Neuropteroids. It is greatly to be hoped that his manuscript was sufficiently advanced to permit its publication.

Aside from his scientific ability, Lugger was a man of admirable qualities. His wide information, his agreeable personality and his keen sense of humor made him one of the most delightful companions I have ever known. Many of his stories and humorous sayings are current among entomologists all over the United States, and his loss will be felt for many years to come. He leaves a widow and two children—a daughter, Mrs. Linnea Clarke, and a son, Humboldt Lugger, the latter now living in Kentucky.

L. O. HOWARD.

#### SCIENTIFIC BOOKS.

*The Phytogeography of Nebraska.* I. General Survey. 2d Ed. ROSCOE POUND and FREDK. E. CLEMENTS. Published by the Botanical Seminar, University of Nebraska, Lincoln, Neb. 1900. Svo. Cloth. Pp. 442 and 4 maps.

To those who have not paid special attention to this branch of investigation this volume will prove to be both a revelation and an incentive to learn. It is a revision of the first edition, issued some three years ago, with additional material

acquired since that time, the larger part of the first edition having been destroyed by fire in the building of the publishers.

In its broadest conception the subject is happily defined as 'the study of vegetation,' or in other words, the study of the floral covering of any area in the aggregate. It deals with the plant groups rather than with individuals, and with the interrelations of species rather than with the species themselves, and discusses the reasons why certain plants have become established in certain areas, the effects of environment, etc.

The treatment of the subject begins with an historical review of the investigations which have been made in the flora of Nebraska, commencing with the expedition of Lewis and Clarke during the years 1803-1806, and continues through what may be called the era of exploration, to about 1870, up to which time the study of botany was merely incidental, in connection with general surveys and explorations. Botany as a distinct subject of investigation did not receive attention until 1871, and it was not until 1884 that it was prosecuted in earnest, under the direction of Dr. C. E. Bessey, who was elected to the then newly created chair of botany in the University of Nebraska. The botanical seminar of the University was organized, and for the first time a systematic investigation of the flora of the State was begun.

The preliminary work of cataloging the flora of the state was accomplished and then was commenced the study of the vegetation as a whole, in connection with topography, geology, meteorology, etc.

Four phytogeographical 'regions' are recognized, as follows:

- I. Wooded-bluff and Meadow-land.
- II. Prairie.
- III. Sandhill.
- IV. Foothill.

Regional limits, within a relatively small and artificially limited area such as the State of Nebraska, are primarily dependent upon physiography. Vegetation 'zones' and 'realms' are only applicable to more extended areas, with natural boundaries based on geographic or climatic conditions.

Following the system of Drude, the phyto-

geographic regions of Nebraska would all be included within the Middle North American Realm of the Northern Zone, and by a division of this realm into 'provinces' (Allegheny, Prairie, Rocky Mountain, Great Basin and California) the greater portion of the State would fall within the second of these, with a small strip along the eastern edge representing the first.

Lists of species peculiar to each region, those that are common to two of the regions, and those that are common to three or more of the regions, are given. The distribution of any species, or in other words the area over which it occurs, is of course a mere matter of more or less careful observation, but the abundance of a species can only be determined by careful investigation and calculation, the method of which is described, together with the formulæ adopted.

The terms employed are somewhat bewildering in their number and the fineness of their distinctions, and doubtless many who are not directly interested in the subject may become impatient at the necessity for mastering the differences between 'abundant,' 'frequent,' 'sub-frequent,' 'infrequent,' 'sparse,' 'rare,' 'solitary,' 'copious,' 'gregarious,' 'gregario-copious,' etc.

In the division of the plants into 'vegetation-forms' will be found another series of terms, popular and scientific, such as woody plants ('trees,' 'shrubs,' 'under-shrubs,' 'climbers and twiners'), half shrubs, herbs ('rosettes,' 'mats,' 'succulents,' 'sod-formers,' 'rootstock-plants,' etc.), water plants ('floating,' 'submerged' and 'amphibian'), saprophytes, parasites, mosses, fungi, algæ, etc., with discussion of habitat, foliage, protective devices, period of flowering, methods of dissemination, etc.

The factors concerned in the phenomena of phyto-geography are both physical and biological. They are connected with environment (topography, temperature, moisture, mechanical and chemical composition of the soil, etc.), and with the influence of animals, including man, as well as with the influence of plants upon each other, and each natural group of plants may be affected differently by the same factor or factors. In this connection each natural group is discussed in sequence.

The final part of the work deals with what is denominated 'plant formations,' and a plant formation is defined as 'a piece of the floral covering, the extent of which is determined by a characteristic correlation or association of vegetable organisms, *i. e.*, it is a stretch of land the limits of which are biological and not physiographical.' They may or may not, therefore, be coextensive with the regional distribution of the plants which compose them.

With respect to their origin they may be either primitive or recent. Primitive origin is necessarily more or less conjectural. It involves the study of the extinct flora of the region and the geologic changes which finally led up to the establishment of existing conditions. Recent formations may arise either from nascence or by modification. If by nascence they must originate upon areas previously destitute of any floral covering, while in the second case they are formed by the elaboration or modification of existing formations, often by the intrusion of foreign elements. Abandoned cultivated patches may represent the first, timber claims the second. Formations often disappear through the agency of fires, floods, mankind, etc., in which cases new formations may arise by nascence.

As an example of the latter is quoted the establishment of *Botrydium granulatum* or *Vaucheria sessilis*, with the cup fungi *Humaria* and *Scutellinia*, on muddy flats, formerly occupied by water plants, but subsequently exposed by the drying up of ponds or streams. A carpet-like layer may then supervene, composed of *Riccia glauca*, *Funaria hygrometrica*, etc., which in turn may be replaced by low-growing flowering plants, such as *Portulacca oleracea*, *Lepidium intermedium*, etc., and this in turn may yield to taller growing *Chenopodiums*, *Amaranths*, etc.

In the origination of formations by modification two sets of factors may be distinguished—natural and artificial. The first are either biological or physical, the second are due to the influence of man or other animals. An unusually wet season in the sandhill region or a dry one in the lowland will often modify the floral covering in a striking way, and modification through the agency of man is too obvious to require more than passing mention.

The various plant formations recognized are finally considered in detail and discussed under headings and sub-headings, physiographical and biological. For example, under the forest formations may be found the river-bluff formation, including (1) the red oak-hickory formation, (2) the bur oak-elm-walnut formation, etc.; under prairie formations, (1) prairie grass, (2) buffalo grass; under foothill formations, (1) under-shrub, (2) mat and rosette, (3) grass, etc., and many others.

The work as a whole is exceedingly valuable for the wealth of facts recorded, irrespective of any conclusions which may be deduced from them, and no one can fail to appreciate the immense amount of conscientious labor which it shows.

ARTHUR HOLLICK.

*Synopsis of the Naiades, or Pearly Fresh-water Mussels.* By C. T. SIMPSON. Proc. U. S. National Museum, XXII. 1900. Pp. 501-1044.

Some people think that the preparation of zoological catalogues and synopses is a low grade of work, which should be turned over to those who are not capable of doing anything better. Certainly one occasionally meets with examples of zoological bibliography bad enough to have been compiled by the most incompetent, but it is to be remarked that the authors of these works are often really skilled in anatomy or some other branch of the science. The fact is that the preparation of such a work as we have before us, with its orderly arrangement of innumerable references, requires not merely a high grade of intelligence, but a special kind of ability, which is none too common. We may therefore begin by thanking Mr. Simpson for a work which no other living man was equally competent to produce, and which will be invaluable to all students of the naiades. But to regard the work as merely a piece of good bibliography, would be extremely erroneous. Mr. Simpson has carefully studied a considerable majority of the species, and the arrangement of them is original with him. He has, by an examination of the soft anatomy, been able to show that the genus *Unio* of authors is in reality a heterogeneous mass of distinct genera, which

he duly describes. In all, 72 genera are recognized, of which 25 were first named by Mr. Simpson, while many others, credited to various authors, were first properly defined by the same writer. All this amounts to a revolution in naiadology, comparable with that produced by Pilsbry in the study of the Helicidæ.

Of interest to general biologists will be the map given showing the distribution of the naiades. In the Old World the regions of Sclater and Wallace are respected by the freshwater mussels, except that New Guinea goes with the Oriental region, as also do Japan, Corea and Manchuria. In America the neotropical region is valid for naiades, but North America is divided into three primary regions, the Atlantic, the Mississippi and the Pacific, but the last is considered a part of the Palearctic! In all about 1,117 species are recognized, many having long lists of synonyms. Concerning the innumerable so-called species described from France by the followers of Bourguignat, Mr. Simpson says: "Life is too short and valuable to be wasted in any attempt at deciphering such nonsense, and I have not even cumbered the pages of this work with a list of these new species." It is indeed unfortunate that the interesting character of the European fauna should be obscured by the treatment it has received at the hands of its students. The freshwater mollusca, in particular, exhibit a wonderful polymorphism, which in the highest degree merits the attention of the evolutionist; but when every varying phase is designated a species the result is mere chaos. When I lived in England, I knew of a number of ponds producing special forms of *Limnæa* (particularly *L. stagnalis*), which were so different that they could be recognized at a glance; one of the most distinct of these varieties abounded in a pond no bigger than a large rug, and was found nowhere else. The same sort of thing is true of the European naiades, and a careful comparative study of all the forms called species by the Bourguignat school, with an account of the several conditions under which they exist, would be an extremely valuable contribution to biology.

As is inevitable in so great a work, a few errors of nomenclature occur. The new genus

*Dromus* will be considered by some too similar in name to *Dromius*, Bon., but I think it should be allowed to stand. The genus *Nodularia* Conrad, 1853, is preoccupied by *Nodularia* Oken, 1815. This will apparently oblige us to call the genus *Lanceolaria* Conrad, with *Lanceolaria grayana* (Lea) as the type, while the section of *L. douglasie* (Gray) can be called *Nodularidia* n.n. On p. 851, *Ptychorhynchus incertus* should be *P. murinus* (Heude), and on p. 897, *Spatha tristis* should be *S. rochebrunei* Jousseaume.

T. D. A. COCKERELL.

EAST LAS VEGAS, N. M., May 12, 1901.

#### SCIENTIFIC JOURNALS AND ARTICLES.

THE leading article of the *Botanical Gazette* for May is the 'Genetic Development of Forests of Northern Michigan, a study in Physiographic Ecology,' by H. N. Whitford. The factors that influence tree growth are divided into three groups—climatic, ecologic and historical. Favorable climatic factors make possible a forest formation; ecologic factors bring about the plant society condition; and the historical factors, by changing the physiographic features, change the plant societies. The life histories of five series of plant societies are discussed, *viz.*, sand, clay, rock, swamp and clearing societies. In four cases there is a gradual progression from xerophytic societies to a mesophytic forest. In the case of the swamp the progress is from hydrophytic societies to a mesophytic forest. The article is illustrated with eighteen half-tone reproductions of photographs. E. W. D. Holway contributes his third paper on 'Mexican Fungi,' in connection with Dr. Dietel, describing thirty-one new species of Uredinæ. Mr. G. M. Holferty gives the results of his study of the ovule and embryo of *Potamogeton natans*, clearing up a number of gaps in our knowledge of this primitive monocotyledonous type. The paper is illustrated by two excellent plates. Mr. Charles T. Drury, of London, writes upon 'Fern Variation in Great Britain,' and calls the attention of American students to the great scientific value of looking after fern 'sports.' Mr. D. G. Fairchild, agricultural explorer of the U. S. De-

partment of Agriculture, contributes his fourth 'Notes of Travels,' dealing with 'Coffee growing in Brazil and the giant Jequitibá trees.' The usual Book Reviews, Minor Notices, Notes for Students, Open Letters, and News Items close the number.

*Terrestrial Magnetism and Atmospheric Electricity* for May contains the following articles:

'Summary of the Results of Recent Investigations in Atmospheric Electricity' (Concluded): F. EXNER.

'The Physical Decomposition of the Earth's Permanent Magnetic Field—No II.:' 'The Composition and Characteristics of the Uniform Magnetic Field': L. A. BAUER.

'Résumé of Magnetic Work at Bombay Observatory in 1897.'

'The Magnetic Work of the Norwegian North Polar Expedition, 1893-1896': D. L. HAZARD.

'Summary of Results of Recent Comparisons of Magnetic Instruments': L. A. BAUER.

'Schuster's Researches on the Solar Rotation and the Lunar Period in the Earth's Magnetism.'

'Biographical Sketch of William Ellis' (with portrait).

The number of *Popular Astronomy* for the months of June and July has for its frontispiece the orbit of the new comet discovered by Halls, of Cape Colony; the elements and ephemeris as computed by Dr. Kreutz accompanies a brief article upon the comet. Among the other short articles is one by E. C. Pickering on the 'Variability of Light of Eros.' From the *British Journal of Photography* there is reprinted an article on the scientific value of photography for astronomical investigations. The recent eclipse is still too near us to have obtained full knowledge of the results, but a discussion of 'What Eclipses Teach Us,' comes from the pen of David P. Todd, who went out with the Amherst party to Sumatra. Miss Mary Clark Traylor gives an explanation of the method of computing an ephemeris of a planet or comet, of interest to the amateur astronomer. Spectroscopic notes, planet notes and the usual planet tables are included in the number.

THE Museums Association of Great Britain will commence in July the publication of a monthly journal devoted to the interests of museums in general. Besides the proceedings of the Museums Association it will contain

current news of museums and art galleries, illustrated descriptive articles, reports of museums, reviews of books and brief notes. Mr. F. A. Lucas, of the U. S. National Museum, will act as the American correspondent of the journal, and he will be glad to receive any articles, no matter how brief, pertaining to the work of museums in the United States, or they may be sent directly to the editor, Mr. E. Howarth, of the Sheffield Museum, England.

#### SOCIETIES AND ACADEMIES.

##### PHILOSOPHICAL SOCIETY OF WASHINGTON.

THE 536th regular meeting was held May 11, 1901. The special order of business was to consider the question of incorporating the Society under the general laws of the United States for the District of Columbia. After discussion it was unanimously

*Resolved*, That the Philosophical Society adopt the recommendation of the General Committee to incorporate the Philosophical Society of Washington, and that the carrying into effect of the foregoing resolution be entrusted to the General Committee.

The 537th meeting was held May 25, 1901. The Chairman, V. P. Rathbun, stated that pursuant to the instructions of the Society at the last meeting the General Committee had filed Articles of Incorporation on May 20, 1901, said Articles being signed by three of the founders of the Society and 23 past presidents and other officers of the Society. He also stated that at a meeting of the incorporators just held all the members of the Society had been elected to the incorporated society.

A code of by-laws was adopted, and the former officers were elected to corresponding positions in the new Society.

President Walcott then took the chair. In response to a question, and after discussion, he ruled that the organization was to be continuous, and that the present meeting did not begin a new series.

The first regular paper was by Dr. G. M. Sternberg on the 'Transmission of Yellow Fever by Mosquitoes.' (This paper will appear in *The Popular Science Monthly*.)

Mr. J. W. Frolej then described some 'Appliances for describing Oval and Circular Arcs of very large radius.' The principal one depended on the fact that a uniform elastic bar, bent by equal oppositely directed forces takes the form of a circular arc. The presentation was too mathematical to be condensed here.

The Society then adjourned till October.

CHARLES K. WEAD,  
Secretary.

#### TORREY BOTANICAL CLUB.

At the meeting of April 9, 1901, the scientific program consisted of a 'Report on a Recent Visit to the Royal Gardens at Kew, England,' by Mr. George V. Nash. Mr. Nash was absent about six weeks, nearly the entire time on the other side being spent at the Royal Gardens, Kew, securing specimens of living plants for the New York Botanical Garden. The collections were carefully inspected under the guidance of the officers of the institution, and such duplicate material picked out as was desired. In this way much valuable material was secured, both for the outside and conservatory collections. Many of these were procurable only at a botanical garden, and a number of them were not obtainable elsewhere than at Kew. Of the large number of plants selected, over 1,000 species have already been received and incorporated in our collections. These include about 550 species of herbaceous plants, 350 shrubs and trees, and 150 succulents. The remainder of the material will follow as fast as the authorities at Kew can select it.

Dr. Britton remarked that the favor accorded by Sir William Dyer in permitting Mr. Nash to select duplicates of living plants from the rich collections at Kew would be most gratefully appreciated not alone by the managers and members of the New York Botanical Garden, but by all American botanists.

Dr. Britton presented a communication on a tree new to the American continent, a white birch from the Alaska region, collected by Mr. R. S. Williams and Mr. Tarleton and represented in the U. S. National Herbarium also by two specimens collected by Miss E. Taylor.

At the meeting of April 24th a paper by Professor Francis E. Lloyd, entitled, 'The

Genus *Lycopodium*: A Criticism,' in the absence of the author, was read by the secretary pro tem. This was a review and criticism of the treatment of the genus *Lycopodium* by Pritzel in the recently published part of Engler and Prantl's 'Die natürlichen Pflanzenfamilien' dealing with the Lycopodiaceae. The paper will be published in full in an early number of *Torreyia*.

Professor Underwood remarked on segregations in the *Selaginella rupestris* group, stating that Dr. Hieronymus, of Berlin, had recently recognized twenty-seven species in this group, some of them American, outside of those recently proposed in this country.

MARSHALL A. HOWE,  
Secretary pro tem.

#### THE ACADEMY OF SCIENCE OF ST. LOUIS.

At the meeting of May 20, twenty-six persons present, Professor George Lefevre presented a comprehensive address on the advance made in the science of zoology during the nineteenth century.

Professor F. E. Nipher presented a paper determining the specific heat of a nebula, in process of gravitational contraction. It is found to be equal to the constant for the gas, provided by the mechanical equivalent of heat. This is also equal to the difference between the specific heats, at constant pressure and at constant volume. The relation between pressure and volume of the gaseous mass during contraction is determined in terms of the fundamental constants, the gravitation constant, the constant of the gas and the mass of the contracting nebula. In the same way, the relation of pressure to temperature and of volume to temperature are determined. It is a matter of profound significance that a cosmical gaseous mass can apparently pull itself together, and at the same time become warmer, as it might if compressed by some external force. It raises the question whether the mass does really contract itself when it gravitates into a smaller volume, or is gravitation, after all, a force acting from without and upon the two bodies which seem to attract each other?

One person was elected to active membership.

WILLIAM TRELEASE,  
Recording Secretary.

## DISCUSSION AND CORRESPONDENCE.

## REMARKABLE DISCOVERIES.

IN *McClure's Magazine* for June there appears an article, entitled 'Geology and the Deluge: Remarkable Geological Discoveries in Central Asia and Southern Russia, showing that the Noachian Flood is a Scientific Possibility,' by Dr. Frederick G. Wright, Professor of the Harmony of Science and Revelation in Oberlin College.

The first of these 'discoveries' is entitled 'No Glacial Period in Asia.' It is set forth in the following words:

"For many years I have been collecting facts concerning the glacial period in North America and Europe, and in 1900 I went to Siberia to determine conditions in that country in the same period. As Asia, like North America, stretches toward the North Pole and faces a great sea on the east, I naturally expected to find there evidences of a glacial period similar to that in this country. But, contrary to all my expectations, I found no sign in Central Asia and Southern Siberia of glacial work. On the contrary, the geological conditions I found were such as are only to be explained by an extensive submergence of the region where the Scriptures and tradition locate the Flood which destroyed the whole human race, excepting Noah and his family. The evidences of such a deluge are not one, but several, and extend from Mongolia to the western borders of Russia."

The state of previous knowledge may be inferred from the following quotations from well-known works, to which others might be added:

"It is a familiar fact that there are no traces of glaciation in Northern Asia, but on the contrary there is the most complete and consistent evidence that no such traces are to be found either on the flat tundras or on the higher ground. Murchison long ago showed that there are no marks of ancient glaciation on the Urals, which it must be remembered rise in places to a height of 1,525 metres, and are in many places covered with snow for eight months in the year. Repeated visitors have tried in vain to find old glacial traces in the Altai Mountains. Lastly, traveller after traveller across Northern Asia speaks of the absence of all

boulders, rounded rocks, etc., in Siberia from one end to the other." [The Glacial Nightmare and the Flood,' by Sir Henry Howorth, Vol. I., pp. 510, 511, 1893.]

"These [certain mountainous and plateau tracts], as far as I can learn, are the only regions in Asia which have yielded certain traces of glaciation. (See Plate XIV.)" [The plate shows no general glaciation in Siberia or Central Asia.] ('The Great Ice Age,' by James Geikie, third edition, p. 697, 1894.)

"East of the Urals in Northern Asia there is no evidence of moving ice upon the land during the Glacial period." ('Man and the Glacial Period,' by G. Frederick Wright, p. 190, 1892.)

The second 'discovery' relates to the general prevalence of loess in the region named. This is set forth as follows:

"Evidences of a great sea around Mt. Ararat.—On the contrary, throughout this entire region we were confronted with the evidence of a great subsidence of the land which had taken place in recent geological time, and which, in date, would correspond roughly with that of the glacial period in North America. For several hundred miles, while driving through the region south of Lake Balkash and the Aral Sea, we were evidently upon a terrace of the fine loam which is called loess, about 2,500 feet above sea-level. Indeed, at different elevations this loess extends continuously in a broad shelf along the base of the mountains, from the Irtysh River to the Caspian Sea, and is found in extensive areas over various portions of the Caucasus and Northern Persia around the base of Mount Ararat; while the so-called 'black earth' of Southern Russia is a deposit of the same material, and probably of the same age, 100 or more feet in thickness. The distribution of this loess is the key to the whole situation" (p. 135). [The map accompanying the article 'showing the country through which Dr. Wright traveled, and where he found evidences, not of glaciers, but of a flood,' and on which the itinerary is marked, indicates that Dr. Wright did not visit Mt. Ararat or the Biblical lands.]

The degree of originality of this 'discovery' of the distribution of the loess may be inferred

from the following quotation from Geikie's 'Ice Age' in the chapter on Asia:

"Immense sheets and terraces of loess fringe the alpine lands and sweep outwards upon the low grounds of Turkestan and Siberia, but do not seem to go much farther north than 54° N. L. These, as Kropotkin shows, present the same character as the similar accumulations of Europe, and have yielded remains of mammoth, rhinoceros, etc., and land shells. In Northern China the same accumulation is developed on a yet grander scale—covering enormous areas, and occurring at all altitudes from a few feet to upwards of 8,000 feet above the sea. The distribution of the Asiatic loess, its general character, and the nature of its organic remains hardly allow us to doubt that it has been formed under the same conditions as the similar deposits in Europe. Its materials, we may believe, are largely of fluvio-glacial origin, and represent in great measure the flood-loams swept down from the mountains and plateaus when these supported extensive snow fields and glaciers. But, as Baron Richthofen in his great work on China has demonstrated, the loess, as we now see it, owes its structure and heaping-up to the action of the wind, and is even now forming and accumulating in many regions of Asia. It is, in short, a true steppe formation." (Geikie's 'Great Ice Age,' p. 699.)

In discussing the origin of the loess, Dr. Wright omits all direct reference to the familiar interpretation sketched by Geikie and held by many geologists on both continents, and thus adroitly creates the impression that the question of its deposition lies solely between the work of the wind and the work of the sea. The following extract embraces the essential part of the statement:

"Twenty-five or thirty years ago Baron Richthofen endeavored to make out that the loess was a wind deposit; and certainly he found much in Northeastern China to support this theory. Upon returning from our trip to the Mongolian frontier, we were inclined to accept it, for we had seen and experienced, in the dust-storms encountered, enough to make us attribute almost anything to the power of wind. For a whole day we once rode in a cloud of dust so dense that it was impossible

to see objects twenty feet away; while everywhere in the mountain valleys we saw instances where this loess had drifted into protected places, as snow does in winter. But there were constantly appearing other things which were difficult to explain by the action of wind. For example, the loess was occasionally spread out, even at high levels, in broad, lakelike basins, as if deposited by water. Also the material now most blown about by the wind is coarse sand, which is piled up in dunes quite unlike the ordinary loess deposits. In one instance we found high walls of a large Chinese city completely buried on one side by a wind deposit; but this was coarse sand, and not loess. In many cases, also, we found long lines of gravel and pebbles interstratified with loess. Thus the difficulties of explaining everything by wind so increased that they became well-nigh insuperable.

"But, on coming around to the northwestern side of the great Asiatic plateau, in Turkestan, which is almost the exact center of the continent, the wind hypothesis became entirely incredible, and the evidence accumulated that the land had lately been depressed to such an extent that the water of the ocean reached the base of the bordering mountains, rising to a height, certainly, of about 3,000 feet; for, at this level, south and southwest of Lake Balkash, we found the loess spread out in such an extensive terrace that the wind would be entirely incompetent to produce the results. \* \*

"In confirmation of this theory of a recent extensive depression of Central Asia, a number of other most interesting facts present themselves, prominent among which are those concerning Lake Baikal. \* \* \* A most curious fact, long known to scientific men, is that this lake is occupied by a species of seal almost identical with those found in the Arctic Ocean. The same species with slight variations are also found in the Caspian Sea, but not anywhere else along the 3,000 or 4,000 miles which separate these bodies of water. The most probable explanation of this fact, and the one usually accepted by scientific men, is, that these species of seal were thus widely distributed during a continental subsidence in which all the waters of the Arctic Ocean



covered all of Northwestern Siberia, and extended up to the base of the great Asiatic plateau which we followed for such a long distance on elevated shore lines in Turkestan. When this depressed area emerged from the sea, it left the seal isolated in the two great bodies of water which still remain on its former margin. So lately has this taken place, that there has not been time for any great changes to be effected in the characteristics of these animals" (p. 136).

Certain high-level deposits at Trebizond and Dariel Pass are cited as the work of the sea and as evidence of subsidence of the land, but no fossils are mentioned (p. 137).

Singularly enough, the comparative *freshness* of the waters of the Caspian and Aral seas made the basis for the inference that "this region has lately emerged from below sea level and, in consequence, rapidly passed through climatic changes which have transformed it from a recently well-watered region to one that is now a desert" (p. 137).

This is the entire evidence upon which the marine origin of the loess is postulated. The direct evidence of the fossil content of the loess is ignored. The public are not even informed of the existence of this class of evidence, nor of such widely current deductions from it as those voiced by Dr. James Geikie in the paragraph previously quoted and by Sir Archibald Geikie in the following extract from his well-known 'Text-Book':

"Though on the whole not rich in fossils, the loess has yielded a peculiar fauna, which singularly confirms Richthofen's view that the deposit was a subaerial one. In the first place, the shells found in it are almost without exception of terrestrial species. \* \* \* It is worthy of note that *Helices* and *Succineas* abound at present in the steppe regions of central Asia, and that many of the species of loess mollusks are now living in east Russia, southwest Siberia, and on the prairies of the Little Missouri in North America.

"From various parts of the European loess, Dr. Nehring has described a remarkable assemblage of animals, which included a jerboa (*Alactaga jaculus*), marmots (*Spermophilus*, several species), *Arctomys bobac*, tailless hare (*Lag-*

*omys pusillus*), numerous species of *Arvicola*, *Cricetus frumentarius*, *C. phceus*, porcupine (*Hystrix hirsutirostris*), wild horses, and antelopes (*Antilope saiga*). This fauna, excepting some extinct or extirpated species, is identical with that which now lives in the southeast European and southwest Siberian steppes. Besides these distinctively steppe animals the loess contains numerous remains of the mammoth and woolly rhinoceros, likewise bones of the musk-sheep, hare, wolf, stoat, etc. It has also yielded flint implements of Palæolithic types. The bones of man himself were claimed many years ago by Ami Boué to have been found in the loess, and his opinion has been in some measure strengthened by more recent observations." ('Text-Book of Geology,' by Archibald Geikie, pp. 1059, 1060.)

The readers of *McClure's Magazine* are not invited to consider the overwhelming force of this class of evidence; nor are they frankly told of the absence of marine fossils from the loess; nor are they informed that the association of Palæolithic implements with the loess is familiar text-book knowledge; but in lieu of such prosy science, they are inspired by the following eloquent climax:

"The crowning point of interest is reached in the discovery by Professor Armashvsky at Kief of flint implements and burnt stones in connection with the bones of extinct animals fifty-seven feet below the undisturbed surface of this soil. The discovery was made in the bluff of loess bordering the river Dnieper, whose general surface is 633 feet above the sea and 340 feet above the present stream, and totally unconnected with any deposits that may have been made by it. In this discovery we have the link connecting the recent geological changes in the East with those in the West. The flint implements of glacial man found in France, England, and the United States indicate the same stage of culture as that attained by the men who were overwhelmed in the great subsidence of Central Asia and Southeastern Russia, and of the region about the base of Mt. Ararat" (p. 138).

This remarkable article closes with 'The Relation of These Discoveries to the Bible Story of the Deluge,' and 'Harmony of Biblical Story and the Geological Facts.'

“ \* \* \* What the recent discoveries have shown is, that during, and subsequent to, the glacial period, and since the advent of man, there has existed such an instability of the earth's crust that the present cannot be made a measure of the past. Man has certainly witnessed catastrophes by flood which are quite analogous to the one described in Genesis. But it is important, in conclusion, to obtain correct ideas of what we are required by the narrative to believe. \* \* \*

“ 1. The biblical account of the flood does not imply, as many seem to assume, that the waters of the earth increased to such a degree that it swelled the circumference of the globe to the extent of the tops of the highest mountains. \* \* \* (p. 138.)

“ 2. Nor is it necessary, except for the purpose of effecting the destruction of the human race, to suppose that the flood was, in the strict sense of the word, universal. We may well believe that the end in view, namely, the destruction of the human race, with the exception of Noah and his family, was accomplished without the destruction of all forms of animal life whose existence was unconnected with the general moral reasons for the flood. \* \* \* The objects of the flood were all satisfied if the destruction of the human race was fully accomplished, so that history could make a new start with a selected family. \* \* \* (p. 138.)

“ Some time during the prevalence of glacial ice over Northern America and Northwestern Europe, man came into existence in Central Asia, where the climate was still congenial. From this point he spread as far west as the Atlantic seaboard in Europe, and eastward to the Pacific Coast, whence he succeeded in reaching, by way of the Bering Sea and Alaska, the western coast of North America, and thence migrated to the Atlantic Coast, where his remains are found in the glacial gravels of Trenton, New Jersey. But the extreme and rapid changes incident to the closing stages of the glacial period naturally, and very likely, exterminated man in company with many of the animals accompanying him both in America and in Europe. The destruction of many of the species of animals accompanying man at the close of the glacial period is a well-known

fact. It also seems probable, from scientific evidence, that man shared largely in the destruction. There is everywhere a sharp line of distinction between Paleolithic and Neolithic man, *i. e.*, between the men who were limited to the use of flaked or rough stone implements and those who used smoothed stone implements. It is Paleolithic implements only which are found in the glacial gravels of America and Northwestern Europe, and beneath the loess at Kiev and at three or four other localities in Southern Russia. The Paleolithic man of science may well be the antediluvian man of Genesis” (p. 139).

From this it appears, a little darkly and vaguely, that the public are to understand from these ‘recent’ and ‘remarkable discoveries’ that Paleolithic man, scattered over Asia, Europe and America (and Africa?), was destroyed by the flood, where there was a flood, and by ‘the extreme and rapid changes incident to the closing stages of the glacial period,’ and that this gave rise to the ‘sharp line of distinction between Paleolithic and Neolithic man,’ and hence, by implication, that Neolithic man was the descendant of Noah and that the line of cultural evolution was from ark-building to ‘smoothed stone implements.’

One is led to wonder how far respect for the Scriptures is fostered by ‘remarkable discoveries’ of this sort and by the much-trumpeted stage-play that preceded and accompanied them. \* \* \*

#### THE MONGOOSE IN JAMAICA.

It seems to be almost impossible for writers of text-books to give a correct account of the mongoose in the island of Jamaica, and its effect upon the native fauna. In *Nature*, February 7, 1901, I took occasion to point out a peculiar error in the account of the animal in an excellent text-book of zoology; to-day I open Mr. J. W. Redway's *Elementary Physical Geography* (1900) and read that the mongoose ‘did not lessen the number of cane-rats,’ but ‘exterminated one or two species of ground-bird.’ As in the former note just mentioned, I must beg those who wish to discuss this subject to read Dr. J. E. Duerden's article in *Journal of the Institute of Jamaica*, July, 1896, p. 288.

Here the facts actually known are duly set forth, and among other things it is shown that the rats were destroyed in great numbers, while it seems doubtful whether the 'ground-birds' were actually exterminated in any instance.

T. D. A. COCKERELL.

EAST LAS VEGAS, N. M.,

May 16, 1901.

#### AN EARTHWORK DISCOVERED IN MICHIGAN.

MR. G. N. HAUPTMAN, of Saginaw, Michigan, in a letter dated May, 1901, reports that 'there is on section 34, T. 21, N., R. 1 E., Ogemaw county, Mich., an earthwork [of horse-shoe shape]. The trench \* \* \* is three feet' deep, and in it stand forest trees.

If any notice of this has ever been printed I should be glad to receive references to the same. I believe no note of this earthwork has previously been made, although four earthworks in the same county are well known and are recorded in the literature of archeology.

HARLAN I. SMITH.

#### PHYSIOLOGY IN THE SCHOOLS.

TO THE EDITOR OF SCIENCE: The writer has a 'horrible suspicion' that T. Hough imputes the physiological questions, to which he demurs, to him. He did not propound them. The high-school questions were taken from the text-book which the pupils had used, and if the text was legitimate, the questions were.

It is the writer's conviction that public school teachers are not generally qualified to teach physiology; that physiology proper is too abstruse for the grammar grades; and that the teacher in every grade should be expected to have a better knowledge of his subject than can be obtained from the elementary text placed in the hands of his pupils. Finally he may venture to express his fear that a little elementary knowledge of the reasons for the non-increase in stature of the human skeleton throughout life might not be amiss to his learned critic even.

S. W. WILLISTON.

#### SHORTER ARTICLES.

##### WHAT IS LIFE?

SOME thoughts, started by reading an article with the above title in *Nature*, Vol. 57, p. 138,

1898, by Horace Brown, and jotted down at that time, but laid aside, I have thought might perhaps interest the readers of SCIENCE, especially as the subject continues to be agitated.\*

Heretofore in cases of dormant life, as in seeds kept for years, perhaps for centuries, or in desiccated infusoria, etc., in which under favorable conditions active life is revived, it has been supposed that very slow metabolic changes still go on during the state of dormancy—life is supposed to be feeble, but not extinct. The same was supposed to be the case in seeds or bacteria exposed to intense cold of  $-180^{\circ}$  to  $-200^{\circ}$  C. by Pictet or even  $-250^{\circ}$  by Dewar.

But it is now proved that at this temperature chemical affinity is destroyed and all chemical changes arrested, and therefore the chemical changes characteristic of life—metabolism—also must cease. But with the return of heat they revive. Therefore, in this case, life seems to spring spontaneously from dead matter. Must we then revive the old doctrine of spontaneous generation? If not we must change or greatly modify our conceptions of life.

From such experiments it is evident that, although life is, indeed, a distinct *form of energy*, yet its nearest alliance is with chemism. For as chemism is completely destroyed by extreme cold and again revived by heat, so life may be completely arrested by cold and again revived by heat—if the *molecular structure characteristic of living protoplasm* (whatever that may be) remains unchanged.

What then is the necessary condition of life—or, to put it clearly, what is the difference between *dead* protoplasm and *living* protoplasm, or rather protoplasm *capable of life*? Evidently it is not a difference in chemical composition, for no change in this regard takes place in the act of death. It is, I suppose, a difference in *molecular arrangement*—a difference in *allotropic condition*. As the necessary condition of chemical properties is a certain equivalent composition: so the necessary condition of vital properties is, in addition, a certain molecular constitution. But as equivalent composition may

\**Nature*, Vol. 61, p. 67, 1899; Vol. 63, p. 420, 1901. *Revue Scientifique*, Vol. 15, p. 201, 1901, and SCIENCE, Vol. 12, p. 774, 1900.

remain, even though chemical activity be absent, so also the peculiar molecular constitution, characteristic of life may remain even though life—*i. e.*, active life—be absent. As chemism may be completely destroyed by cold and revived by heat, if the necessary condition, *viz.*, a certain equivalent composition, remains: so life may be completely destroyed by cold, and again revived by heat if so be the necessary condition—a certain molecular constitution remains.

Again, Mr. Brown, in the article referred to, says that Spencer's definition of life, *viz.*, 'a continuous adjustment of internal to external conditions' must be revised, since it applies only to *active* life and not to suspended life. I think not. Life in the true sense, *i. e.*, *actual* life must be active—the essential nature of life, as of all energy, is *activity*; but there is a necessary underlying condition, *i. e.*, a peculiar molecular constitution, which may be called *potential* life. As equivalent composition is potential chemism, which may under certain conditions become actual chemism, so a peculiar molecular constitution of protoplasm is potential life, which may under certain conditions become actual life. *Death* is not merely an *extinction* of life, *i. e.*, actual life, but also the *destruction* of the necessary condition of life, *i. e.*, the characteristic molecular structure of protoplasm. Extinction of life, therefore, is not necessarily *death*. There are therefore three conditions of protoplasm, *viz.*: (1) *living*, a condition in which life is actual; (2) *potentially living*, in which the necessary molecular constitution or vital constitution is present; and (3) *dead*, in which the vital constitution also is wanting.\*

JOSEPH LE CONTE.

BERKELEY, CAL., May 24, 1901.

A 'SAND-BOW'—AN UNUSUAL OPTICAL PHENOMENON.

THE following description, based on personal observation, is presented without discussion of the optical principles involved.

\* Similar views on the molecular constitution of living protoplasms were brought out by me, in January, 1892 in a lecture before the Philosophical Society of Washington. *Bulletin*, Vol. XII, p. 29, 1892.

On the evening of May 16, the writer was crossing the main ridge of Antelope Island—the largest land body within the area of the Great Salt Lake. As he began the descent on the eastern slope, there appeared between the island and the mainland what seemed at first glance to be segment of a brilliant rainbow of unusual width. It was evident, however, that no rain was falling in that direction. Clouds were gathering in the south and west, but the sun was yet unobscured. A wind setting toward the mainland had lifted from the dry flats large quantities of the 'oolitic sand,' with which the lake bottom and the recently dried patches on this side of the island are covered to a depth varying from a few inches to several feet. This so-called 'sand' consists of calcareous spherules, fairly uniform in size between the limits of No. 8 and No. 10 shot. The oolitic bodies are polished and exhibit a pearly luster.

It would seem that the outer spherical surfaces reflected the light in such a manner as to produce the bow. The colored column appeared almost to touch the lake bed, and its ends subtended with the observer an angle of about 40°. The prismatic colors were distinct, the red being outside, *i. e.*, away from the sun. In apparent width the column was fully double that of the ordinary rainbow. A fainter secondary bow was plainly visible beyond the primary, with the colors in reverse order. The phenomenon was so brilliant as to attract the attention of all members of the party, and it remained visible for over five minutes, then, as the sun sank lower, it rapidly died away.

The production of a color bow by reflection from the outer surfaces of opaque spherules is a new phenomenon to the writer. It is inexplicable on the principle of refraction and total reflection from the interior of transparent spheroids, according to which the rainbow is generally explained.

If phenomena similar or analogous to the foregoing have been observed, reports of the same would doubtless be of instructive interest.

JAMES E. TALMAGE.

UNIVERSITY OF UTAH,  
SALT LAKE CITY, May 20, 1901.

## NOTES ON INORGANIC CHEMISTRY.

## PLATINUM IN ANTIQUITY.

PROFESSOR BERTHELOT reports in a recent number of the *Comptes Rendus* that on a metallic box from Egypt, covered with inscriptions, he found a portion of one of the characters made of platinum. The mass was too small for a complete analysis, but from its behavior toward aqua regia, it appeared to be native platinum. The date of the box was about 700 B. C. From two standpoints this discovery is of more than passing interest. It has been a much disputed question whether platinum was known to the ancients. Passages from the classics have been quoted which appear to some to be references to platinum, but this application is in every case very doubtful. A much stronger argument against the probability of platinum being known more than a few centuries ago, is, that until this discovery of Berthelot's, no trace of the metal has been found in any ancient remains. Had platinum been known, it is hardly conceivable that specimens of it should fail to be found somewhere among the multitudinous remains of antiquity. This present discovery really emphasizes the argument, for it would seem from the description given by Berthelot that this specimen of platinum was used by the workman unwittingly, resembling as it does some of the pale gold of Egypt. A second interesting point is that if Berthelot's conjecture be true that this is native platinum, obtained from the alluvial deposits of Nubia or the upper regions of the Nile valley, it is the first recorded occurrence of platinum in Africa, with the single exception of an observation of Aimé, in 1838, that some of the galena from Algeria contains a trace of platinum.

## LEAD IN POTTERY GLAZES.

THERE has been much discussion in England the last few years regarding the use of lead in pottery glazes, with reference both to the health of the potters and to the dangers attending the use of lead-glazed vessels in culinary operations.

In continental potteries a lead glaze is in frequent use which seems to be far more resistant to the action of solvents than those in use in England. The subject was recently brought

before the Chemical Society by Professor T. E. Thorpe and C. Simmonds, and an abstract of their work and of the discussion of their paper is found in the *Proceedings* of the Society. Examining a large number of glazes, they find that many of them are attacked by dilute acids, comparable with the acids found in the human system, such as the hydrochloric acid of the gastric juice. They find that the resistance depends upon the ratio of base to silica in the glaze. Provided that the ratio falls within certain limits, the amount of lead extracted under the prescribed conditions is always small, though the actual quantity of lead in the glaze may vary from zero to 50 or even 55 per cent. The amount of the other bases, such as alumina, lime and alkalis, may vary considerably and the silica may be replaced to some extent by other acids, as boric acid. It is to be hoped that American potters, as well as the English, may profit by these investigations, which after all only serve to bring out what has long been in practice in the potteries of Germany.

## COSMIC DIFFUSION OF VANADIUM.

IN 1897 Hasselberg called attention to the occurrence of vanadium in many specimens of rutile, as had indeed been noticed by Sainte-Claire Deville as early as 1859. Hasselberg has now turned his attention to the examination of meteorites, and finds the presence of vanadium in all those examined of the stony type, while in metallic meteorites it is absent, save in a single specimen in which a very small quantity was found. He has gone over the work of Lockyer on the meteoric iron from Nejed and Obernkirchen, and finds that his observation that vanadium is present in these irons is erroneous. From these investigations he deduces the conclusion that a different origin is indicated for stony and for metallic meteorites.

J. L. H.

## CURRENT NOTES ON METEOROLOGY.

## ANNALS OF THE MONT BLANC OBSERVATORY.

VOL. IV. of the *Annales de l'Observatoire météorologique, physique et glaciaire du Mont Blanc* (altitude 4,353 m.), publiées sous la Direction de J. Vallot, contains several interesting

papers. A study, entitled 'Influence de la Pression Barométrique sur l'Action chimique de la Lumière directe du Soleil,' by Dr. M. Andresen, deals briefly with the work of Bunsen and Roscoe, and other investigators, and presents results obtained by the author at the Mont Blanc Observatory. A short paper by M. and Mme. Vallot deals with 'Expériences sur la Vitesse de la Circulation de l'Eau dans les Torrents et sous les Glaciers.' The most important contribution is one by M. Vallot, entitled 'Expériences sur la Marche et les Variations de la Mer de Glace.' This is an elaborate study, setting forth the results of observations made by the author on the Mer de Glace during the nine years 1891-1899. The observations included variations in level, variations in velocity, and variations in velocity in relation to variations in level. The paper is illustrated by means of a series of 61 plates, published in Vol. V. of the *Annales*, and deserves attention on the part of all who are interested in glacial problems. These two volumes are further evidence that M. Vallot's Observatory is doing effective scientific work.

#### THE MOON AND THE WEATHER.

A NEW journal, *Climat*, printed in four languages under the editorship of M. Demschinsky, of Torbino, Russia, and devoted to the publication of articles on the relation of the moon and meteorological phenomena, has recently been widely advertised. So far, three numbers of this magazine have been received. M. Demschinsky published, in Nos. 1 and 2 of *Climat*, a series of curves showing the probable course of the barometer and thermometer during the month of April at a large number of stations. The only comparison of the predictions with the facts of observed weather conditions that has thus far been given publicly is discussed by Dr. H. R. Mill, in *Symons's Monthly Meteorological Magazine* for May. Dr. Mill has made a careful comparison of the predicted conditions and of the actual weather observed in the cases of Aberdeen and of Valencia. The conclusion reached is, as might have been expected, that 'practically the forecasts as a whole appear to be valueless,' so far as these two stations are concerned.

#### NOTES.

IN the *National Geographic Magazine* for May an article by Gannett, on 'The General Geography of Alaska' (pp. 180-196), gives a good general account of the climate of that territory. This article forms one of the chapters of the volume dealing with the Harriman Expedition. The writer is inclined to believe "that if any part of Alaska can become of agricultural importance it is the interior rather than the Pacific coast. But it is doubtful whether even this region will admit of profitable farming. \*\*\* However, as the higher rate of freight to the interior will have the effect of a protective tariff on home products, it may be possible to raise grain and vegetables at a profit under conditions which would be prohibitory on the coast."

The *Meteorological Observations for 1900*, as contained in the 13th Annual Report of the Colorado Agricultural Experiment Station, at Fort Collins, Colo., show that the mean annual evaporation at that station is 41.16 inches (10 years). This is the amount evaporated from a water surface in a tank 3 x 3 x 3 feet, flush with the ground.

Part VII. of the *Report of the Chief of the Weather Bureau for 1899-1900* contains the 'Meteorological Observations of the Second Wellman Expedition,' by Evelyn B. Baldwin, the leader of the present Baldwin-Ziegler Expedition.

R. DEC. WARD.

#### SCIENTIFIC POSITIONS UNDER THE GOVERNMENT.

THE U. S. Civil Service Commission announces that it is desired to establish an eligible register for the position of laboratory assistant in physics, National Bureau of Standards, Treasury Department. It will not be necessary for applicants to appear at any place for examination. The examination will consist of the following subjects:

Education and training.....	30
Original investigations.....	30
Experience.....	20
Thesis .....	20
Total.....	100

From the eligibles resulting from this examination it is expected that certification will

be made to two positions as laboratory assistant in physics, National Bureau of Standards, Treasury Department, one at a salary of \$1,200 and the other at a salary of \$1,400 per annum.

On the same day an examination, which also will not require attendance, will be held for two assistant agronomists in the U. S. Department of Agriculture, with salaries respectively of \$1,600 and \$1,400 per annum. The Department states that the positions for which this examination is held require thorough training and practical experience in subjects pertaining to grasses and forage plants and animal foods, and the management of grass lands and forage crops in the field. The subjects and weights are:

Training and experience with special reference to :	
(a) Theory and practice in agriculture.....	25
(b) Teaching or scientific research.....	10
(c) Publications and editorial work.....	15
	50
Thesis.....	30
Plan (to be devised by the applicant) for experiments to solve any forage problem .....	20
Total.....	100

On the same day there will, further, be an examination, not requiring attendance, for the position of scientific aid with a knowledge of statistics in the Department of Agriculture.

This examination will consist of the following subjects:

College course (with bachelor's degree) or its equivalent .....	40
Post-graduate work and special qualifications.....	30
Thesis or other literature.....	30
	100

Applications will not be received from other than graduates of colleges receiving benefits from grants of land or money from the United States, unless it is shown that the applicants have pursued courses of instruction having an economic bearing which will qualify them for the work of the Department of Agriculture. Applicants must show the scope of the studies pursued and the length of time devoted to them, the standing in such studies, especially with regard to the subject of statistics, and the special qualifications which they have for work

upon this subject. They must also submit a thesis upon the subjects of statistics, or in lieu thereof such other literature on the subject as may have been published over their own signature. The salary of the position is \$40 per month and no person will be permitted to serve as a scientific aid for more than two years. Scientific aids who pass in an open competitive supplementary examination in some technical or scientific subject or subjects which may be held will be eligible to certification from such supplementary register to higher positions within the classified service, regardless of their services as scientific aids.

THE AMERICAN ASSOCIATION.

SECTION A. MATHEMATICS AND ASTRONOMY.

THE officers of the section, Professor James McMahon, chairman, and Professor George A. Miller, secretary, have received the following titles for presentation at the Denver meeting. They have not, however, yet been approved by the Sectional Committee:

'A Summary of the Salient Effects due to the Secular Cooling of the Earth': Professor R. S. WOODWARD, Columbia University.

'The Energy of Condensation of Stellar Bodies': Professor R. S. WOODWARD.

'Supplementary Report on Non-Euclidean Geometry': Professor GEORGE BRUCE HALSTED, University of Texas.

'On the Application of the Fundamental Laws of Algebra to Infinite Series': Professor FLORIAN CAJORI, Colorado College.

'Conditionally Convergent Series whose Product is Absolutely Convergent': Professor FLORIAN CAJORI.

'Report on Continuous groups': Professor H. B. NEWSON, Kansas University.

'The Great Meteor of December 7, 1900': Professor H. A. HOWE, University of Denver.

'Note on a Direct Solution of Kepler's Problem': Professor H. A. HOWE.

'The Next Appearance of Eros': Professor H. A. HOWE.

'On Systems of Isothermal Curves': Professor L. E. DICKSON, University of Chicago.

'On the Modular Function Associated with the Irrationality  $s^3 = z(z-1)(z-x)(z-y)$ ': Dr. J. I. HUTCHINSON, Cornell University.

'The Physical Bases of Long-Range Seasonal Forecasts': Professor CLEVELAND ABBE, U. S. Dept. of Agriculture, Weather Bureau.

'Philosophy of Mathematics': Professor W. J. KERR, Agricultural College of Utah.

'Astronomy in the High Schools': MISS MARY PROCTOR, New York City.

'Concerning (a) the Concept of  $n$ -Dimensional Space and (b) Self-Reciprocal Geometries': C. J. KEYSER, Columbia University.

'On the Probable Densities of the Satellites of the Solar System': Professor T. J. J. SEE, U. S. Naval Observatory.

'Photometric Observations of Eros': HENRY M. PARKHURST, New York City.

'The History of Several Fundamental Theorems in the Theory of Groups of Finite Order': Dr. G. A. MILLER, Cornell University.

#### SECTION F. ZOOLOGY.

Professor Henry B. Ward, secretary, has sent the following circular letter to members of the section:

The next meeting of the A. A. A. S. will be held in Denver, Colorado, August 24th to 31st, 1901. The opportunity is good for bringing together a large number of zoologists and making the meeting particularly interesting.

A provisional program of papers to be read before Section F will be printed within a short time and all members are urged to send titles as soon as practicable.

Permit me to call your attention to Article 28 of the constitution which designates how the sectional committee shall complete the final program from abstracts of papers presented. Kindly conform to the conditions as given there. I enclose blanks for titles and abstracts of papers.

The work of section F would be much strengthened if a larger number of the morphologists of the country were enrolled in its membership. Now that each member of the association receives gratis the official journal, *SCIENCE*, it is certainly true that no one can afford to be without membership in the organization.

Will not each present member assist in the work of enlarging the membership roll?

#### CONVOCAION WEEK.

It will be remembered that, at the instance of a committee of the American Association for the Advancement of Science, the Association of American Universities recently took action recommending that a convocation week be set aside for the meetings of scientific and learned societies. Columbia University, Cor-

nell University, the Catholic University of America, Clark University and Johns Hopkins University have altered their calendars, so that exercises will not be held during the week in which January 1 falls. The schedules of California, Leland Stanford Junior, Michigan and Yale are already such that no exercises fall in this week. Pennsylvania and Princeton have arranged to permit all instructors who wish to attend the meetings held during convocation week to do so, and it is expected that they will alter their official calendars next year. The faculty of the University of Wisconsin has voted to lengthen the Christmas holidays so that convocation week will be left free till 1905; this action will doubtless be confirmed by the regents and made permanent. The only members of the Association of American Universities, whose sessions begin during the week above mentioned and which has not yet taken action are Harvard and Chicago. It is to be hoped, may we not say expected, that all the institutions of the United States and Canada will give their support to this important movement.

#### SCIENTIFIC NOTES AND NEWS.

THE HON. CHARLES D. WALCOTT, director of the U. S. Geological Survey, gave an address before the University of Chicago on June 17, his subject being 'The Relations of the National Government to Higher Education and Research.' We hope to publish this address next week.

DR. PAUL C. FREER, professor of general chemistry in the University of Michigan, has been granted leave of absence for one year to go to Manila on an important scientific commission on behalf of the Philippine Commissioners.

DR. WILLIAM Z. RIPLEY, of the Massachusetts Institute of Technology, has been invited to deliver the Second Huxley Memorial Lecture before the Anthropological Institute of Great Britain. The first lecture was given last year by Lord Avebury.



PROFESSOR BASHFORD DEAN, who is now working at the Misaki Marine Station of the Imperial University of Tokio, has presented a yacht, with a complete outfit for marine zoological work, to the institution.

THE Society of Arts, London, has awarded the Albert medal to King Edward, who for thirty-eight years has acted as president of the society.

COLUMBIA UNIVERSITY at its recent commencement exercises conferred its newly established D.Sc. on Mr. Arnold Hague, of the U. S. Geological Survey. The degree of LL.D. was conferred on Dr. W. H. Maxwell, superintendent of the New York schools, and the degree of M.S. on the Rev. Frank D. Gamewell, professor of physics at the University of Pekin, and on Dr. G. M. Leferts, clinical professor of laryngology in the College of Physicians and Surgeons of the University.

THE valuable contributions to entomology made by William H. Ashmead, of the U. S. National Museum, were recognized by the Florida Agricultural College and Experimental Station in Lake City, Fla., at its recent commencement by the conferment of the honorary degree of A.M.

DUBLIN UNIVERSITY will confer its D.Sc. on W. Burnside, professor of mathematics, Royal Naval College, Greenwich; W. E. Wilson, F.R.S., and Francis Joseph Edward Spring, C.I.E.

PROFESSOR H. S. CARHART has been appointed a delegate to the International Engineering Congress in Glasgow by the American Institute of Electrical Engineers. He has also been nominated as an honorary member of the Congress. He sails on August 13, and will attend both the Engineering Congress and the meeting of the British Association in Glasgow.

MR. F. W. HODGE has recently been appointed assistant in charge of office in the Smithsonian Institution, and to accept that appointment has resigned his position as ethnologist in the Bureau of American Ethnology. He continues as managing editor of the *American Anthropologist*.

DR. VICTOR C. VAUGHAN, of the University of Michigan, was elected president of the

American Academy of Medicine at the annual meeting held in St. Paul, Minn., the first week in June.

DR. FREDERICK BEDELL, of Cornell University, will spend the coming year in Europe.

PROFESSOR J. CULVER HARTZELL, of the Illinois Wesleyan University, will be engaged during the summer in tracing certain partings in Indiana for the Indiana Geological Survey.

PROFESSOR W. RAMSAY will lecture on the 'Inert Constituents of the Atmosphere,' and Professor Francis Darwin on 'The Movements of Plants,' at the approaching Glasgow meeting of the British Association.

PROFESSOR JAMES DEWAR gave the Bakerian Lecture before the Royal Society on June 13, his subject being 'The Nadir of Temperature and Allied Problems.'

THE William T. Lusk Memorial Science Prize has been awarded by the faculty of the University and Bellevue Hospital Medical College to S. S. Goldwater, for a paper entitled 'Notes on Blood Pressure in Man.' This prize is awarded to the member of the senior class presenting the best thesis which is the product of personal original research.

A MEMORIAL tablet to the late J. C. Porter, the botanist, was unveiled at Lafayette College in connection with the commencement exercises.

WE regret to announce the death of Professor Truman Heury Safford, which occurred at Williamstown, on June 13. Born at Royalton, Vt., in 1836, he had since 1876 occupied the chair of astronomy in Williams College.

DR. ARTHUR HAZELIUS, of Stockholm, the enthusiastic inspirer of the Northern Museum in that town, and the reviver of old Swedish customs, dances and costumes in the beautiful open-air museum known as Skausen, died on Whitmonday, mourned by all his countrymen.

M. MARES, known for his contributions to scientific agriculture, died at Montpelier, on May 9; Professor W. H. Heineke, for thirty-three years professor of surgery at Erlangen, has died at the age of sixty-six years.

JOHN VIRIAMU JONES, principal of, and professor of physics in, the University College of South Wales at Cardiff, died at Geneva on June

2. An obituary notice in the London *Times* states that he was born at Pontreporth, near Swansea, in 1856, he matriculated at London University in 1872, and won a University scholarship in geology, a subject in which he graduated as B.Sc. with first-class honors in 1875. In the preceding year he was elected Brackenbury scholar in natural science at Balliol College, Oxford; and in due course he was placed in the first class in mathematical moderations (1877), the final school of mathematics (1879), and the final natural science school (1880). For a short time he was demonstrator in the Clarendon Laboratory under Professor Clifton; but in 1881 he left Oxford to become principal of, and professor of mathematics and physics in, Firth College, Sheffield. Two years later, on the establishment of the University College of South Wales, he was appointed its first principal, also acting as professor of physics; and this position he retained up to his death. In 1894 he was chosen a fellow of the Royal Society, and in 1897 was elected a fellow of Jesus College, Oxford. His scientific work was mainly concerned with the measurement of electrical resistance, and he was a member of the committee of the British Association on that subject. In particular he was deeply interested in the determination of the standard ohm by the Lorenz method in absolute measure, *i. e.*, conditioned only by the units of length and time and the properties of the ether; he constructed a Lorenz apparatus for his laboratory at Cardiff, and took a prominent part in designing and testing another that was made in London for the McGill University. The cause of technical and scientific education in Wales owed much to his powers of organization, and he was vice-chairman of the Welsh Central Board for Intermediate Education, besides being the first Vice-chancellor of the University of Wales.

DR. R. A. DALY, of Harvard University, has given up the plan of conducting a geological expedition to the North this summer.

MAJOR RONALD ROSS, of the Liverpool School of Tropical Medicine, expected to leave for Sierra Leone on June 8, in charge of the fifth malarial expedition from the school.

ALVISO B. STEVENS, assistant professor of

pharmacy, in the University of Michigan, will spend a portion of the coming summer in New York City gathering old mortars, jars, shelf fixtures, etc., which will be made the nucleus of a collection illustrating the history of pharmacy.

A CORRESPONDENT of the London *Times* states that Dr. Stein, writing from Khotan on April 22, reports the latest results of his excavations in northern Chinese Turkestan. He has unearthed a large number of fine stucco sculptures closely resembling the Greco-Buddhist relics of the northwestern Punjab, probably belonging to the first century of the Christian era. Great difficulty is being experienced in excavating the colossal Buddhas, but valuable photographs have been taken of them, while the smaller pieces have been removed. Dr. Stein has now a fine illustration of what the big Stupa with its chapel and court was like in Khotan at the time of the Han dynasty.

PROFESSOR WILLIAM PATTEN, of Dartmouth College, has been granted leave of absence for the first semester of the next academic year. He will attend the International Congress of Zoologists in Berlin and afterwards explore the coast of the Baltic in Russia in search of specimens of *Cephalaspis* and other Ostracoderms. The United States Government, through its Geological Survey, has generously offered financial support in the undertaking. Dr. Patten's courses at Dartmouth will be given during his absence by Dr. J. H. Gerould.

DR. FRANK RUSSELL has recently reported to the Bureau of American Ethnology a successful archeological trip through southeastern Arizona, in the course of which a number of hitherto unknown ruins were discovered and reconnoitered.

PROFESSOR W. H. HOLMES recently returned from a visit to the South Carolina State College, at Columbia, where he supervised the arrangement and installation of the Babcock collection of stone implements. This collection, which represents the findings of the late Dr. Babcock during thirty years' residence in the district formerly occupied by the Catawba Indians, recently passed into the possession of the State; and it is now available for inspection, as well as for systematic study.

THE U. S. Biological Survey, Department of Agriculture, has sent an expedition to Athabasca and Great Slave Lakes. The chief object is the collection of information and specimens illustrating the geographic distribution of mammals, birds, trees and shrubs in the region. The expedition is in charge of Edward A. Preble. Last year Mr. Preble was sent to Hudson Bay on a similar mission.

REUTER'S correspondent in Berlin, telegraphing on June 1, says: The evening papers state that the international negotiations which have been proceeding with reference to the international protection of birds have now been concluded, and that the imperial chancellor has forwarded the draft of the international convention on this subject to the federal council with a recommendation that Germany should subscribe to it.

THE Chamber of Commerce of Cambridge-shire, has unanimously passed a resolution declaring that it is desirable for the British government to establish an official seed-testing station.

THE Antarctic exploring vessel *Discovery* left Dundee for London on June 3. A successor to Professor Gregory as leader of the scientific staff has not, we understand, yet been appointed.

THE Rockefeller Institute for Medical Research was incorporated in New York State on June 13. The directors for the first year, as we have already stated, are: William H. Welch, of Baltimore, T. Mitchell Prudden, C. A. Herter, L. Emmett Holt, and Hermann W. Biggs, of New York; Simon Flexner, of Philadelphia, and Theobald Smith, of Boston.

A COMMISSION, consisting of Sir T. Lauder Brunton, Dr. T. Stevenson, Mr. A. G. Salamon, Dr. A. P. Luff, Dr. Samuel Buckley and Mr. Fletcher Moulton, K.C., M.P., appointed by the Manchester Brewer's Central Association to investigate the causes of the beer poisoning that has recently occurred in Great Britain has made its report. The Commissioners say: "It is clear that the most frequent source of arsenical contamination in beer is the use of malt which has been kiln-dried or malted with improper fuel containing arsenic. At the same

time the experience of the late outbreak has shown that precautions must be taken against the presence of arsenic in brewing sugars and other materials (except, perhaps, malt adjuncts) on account of the serious consequences of any carelessness in manufacture which might introduce arsenic. Accordingly, we have considered what steps should in future be taken by brewers to protect themselves from any repetition of the recent disasters. We recommend that brewers should make it a rule to require a written guarantee of freedom from arsenic with all purchases of brewing materials of every kind. In addition to this we recommend that brewers should from time to time test the purity of their beer in respect of arsenic. The fact that yeast has a special affinity for arsenic affords an excellent method of demonstrating the purity of the materials used. If the yeast be tested for arsenic, it will readily show whether the wort is contaminated, for it will be many times richer in arsenic than the wort itself. It thus forms an excellent indicator of the presence of arsenic. In addition to frequent testing of the yeast, it would be advisable for the brewers to take control tests from time to time of their brewing sugars, finings and other materials."

#### UNIVERSITY AND EDUCATIONAL NEWS.

THE bills in the Michigan Legislature to reduce the quarter-mill tax levied for the benefit of the university have been defeated. The annual income from this tax is now approximately \$275,000, an increase over last year of \$50,000.

THE alumni of the Massachusetts Institute of Technology have subscribed \$100,000 for a gymnasium, to be erected as a memorial to the late President Walker. Over 15,000 former and present students have sent subscriptions.

COLUMBIA UNIVERSITY has received an anonymous gift of \$100,000 for the establishment of a department for the study of Chinese institutions, language and history.

PRESIDENT PATTON announced at the commencement exercises of Princeton University that the authorities of the university had received \$50,000 for an endowment fund for the library and \$10,000 to establish a fellow-

ship in rhetoric. He also said that \$150,000 of the \$200,000 necessary for the erection of a new gymnasium had been insured by the alumni.

THE University of Chicago has received \$8,000 by the will of Marie J. Mergier to establish a scholarship in physiology.

MRS. CAROLINE STANNARD TILTON, of New Orleans, has given \$50,000 for a Tilton Memorial Library Building at Tulane University.

It has now become known that Mr. and Mrs. James Speyer are the donors of the \$100,000 for the experimental school of Teachers College, Columbia University. A site has been purchased near Amsterdam Avenue and 128th Street, and plans for the building, prepared by Mr. A. E. Josselyn, have been accepted.

LINCOLN COLLEGE and Decatur Industrial College have united, and will hereafter be called Milliken University, in recognition of a gift of \$150,000 from Mr. James Milliken. Mr. A. R. Taylor has resigned the presidency of the State Normal College at Emporia, to become president of this institution.

THE faculty of the University of South Dakota decided, by practically a unanimous vote, several months ago, that there should hereafter be but one degree granted for all courses of work, *viz.*, the Bachelor of Arts. Heretofore there have been three degrees granted, Bachelor of Arts, Bachelor of Science and Bachelor of Philosophy. This step was taken independently of the similar action by the Universities of Michigan and Minnesota which we recently reported.

THE Yale Forest School has thirty-five applications for its summer session, which will be held next month at Milford, Pa.

A. D. COLE, professor of physics and chemistry in Denison University, has been called to a chair of physics in the Ohio State University. His position at Denison has been filled by the appointment of Professor Clark Chamberlin, of Colby College, Me.

W. G. TIGHT, professor of geology for thirteen years in Denison University, and editor of the *Bulletin of the Scientific Laboratories*, has been elected to the presidency and professorship of geology in the University of New Mexico.

H. C. MORENE, a fellow at Clark University, has been appointed assistant professor of mathematics in Leland Stanford University.

PROFESSOR F. C. FRENCH has resigned the chair of philosophy at Vassar College, and Dr. H. Heath Bawden has been appointed associate professor of philosophy in the institution.

FREDERICK E. BOLTON, PH.D. (Clark) has been promoted to the head of the department of pedagogy in the State University of Iowa, succeeding Professor J. J. McCounell who has resigned to accept the superintendency of schools at Cedar Rapids, Iowa.

PROFESSOR EUGENE HAANEL has resigned the chair of physics in Syracuse University to accept an appointment as superintendent of mines of Canada.

DR. SHEPHERD IVORY FRANZ, assistant in physiology in the Harvard Medical School, has been appointed instructor in physiology at Dartmouth College. He will give courses both in the Academic Department and in the Medical College.

DR. MARGARET FLOY WASHBURN, warden of Sage College, has been appointed to a lectureship in psychology in Cornell University.

PAUL GOODE, who has been head of the department of Geography at the Normal School, Charleston, Ill., since its foundation, has recently received the degree of Ph.D. from the University of Pennsylvania and has been appointed instructor in geography in the same institution.

DR. HERMAN C. COOPER, now of Lincoln, Nebraska, has been elected instructor in the department of chemistry of Syracuse University.

SANFORD BELL, a Clark University student, will be temporary instructor in psychology and pedagogy at Mount Holyoke College next year.

THE newly created third chair of zoology at the Imperial University of Tokio has been placed under the charge of Professor S. Watasé.

M. TH. RIBOT, professor of experimental and comparative psychology at the Collège de France and editor of the *Revue Philosophique*, will retire from his chair on a pension at the end of the present academic year.

# SCIENCE

A WEEKLY JOURNAL DEVOTED TO THE ADVANCEMENT OF SCIENCE, PUBLISHING THE OFFICIAL NOTICES AND PROCEEDINGS OF THE AMERICAN ASSOCIATION FOR THE ADVANCEMENT OF SCIENCE.

EDITORIAL COMMITTEE: S. NEWCOMB, Mathematics; R. S. WOODWARD, Mechanics; E. C. PICKERING, Astronomy; T. C. MENDENHALL, Physics; R. H. THURSTON, Engineering; IRA REMSEN, Chemistry; JOSEPH LE CONTE, Geology; W. M. DAVIS, Physiography; HENRY F. OSBORN, Paleontology; W. K. BROOKS, C. HART MERRIAM, Zoology; S. H. SCUDDER, Entomology; C. E. BESSEY, N. L. BRITTON, Botany; C. S. MINOT, Embryology, Histology; H. P. BOWDITCH, Physiology; J. S. BILLINGS, Hygiene; WILLIAM H. WELCH, Pathology; J. MCKEEN CATTELL, Psychology; J. W. POWELL, Anthropology.

FRIDAY, JUNE 28, 1901.

RELATIONS OF THE NATIONAL GOVERNMENT TO HIGHER EDUCATION AND RESEARCH.\*

## CONTENTS:

<i>Relations of the National Government to higher Education and Research:</i> DR. CHARLES D. WALKOTT.....	1001
<i>The Royal Society of Canada:</i> DR. H. M. AMI.....	1015
<i>Science and the London University</i> .....	1021
<i>Scientific Books:—</i>	
<i>Oppel's Lehrbuch der vergleichenden mikroskopischen Anatomie der Wirbelthiere.</i> DR. B. F. KINGSBURY. <i>River Profiles</i> .....	1024
<i>Societies and Academies:—</i>	
<i>Zoological Club of the University of Chicago:</i> DR. C. M. CHILD. <i>Torrey Botanical Club:</i> DR. M. A. HOWE. <i>The Minnesota Academy of Natural Sciences:</i> F. G. WARVELLE.....	1026
<i>Discussion and Correspondence:—</i>	
<i>Geology of China:</i> PROFESSOR G. FREDERICK WRIGHT. <i>The Larynx as an Instrument of Music:</i> DR. JONATHAN WRIGHT.....	1029
<i>Shorter Articles:—</i>	
<i>Predetermined Root-hair cells in Azolla and other Plants:</i> R. G. LEAVITT.....	1030
<i>Quotations:—</i>	
<i>Science at a Wesleyan University. Mr. Carnegie's Gift to Scottish Universities</i> .....	1031
<i>Current Notes on Physiography:—</i>	
<i>The South Coast of England; The Origin of Floods; Views of the Colorado Cañon; Kabo Volcano, Sumatra:</i> PROFESSOR W. M. DAVIS.....	1032
<i>Current Notes on Meteorology:—</i>	
<i>Weather and Crops in Saxony; Rainfall and Forests in India; Periodicity of Severe Winters in England; Notes:</i> R. DEC. WARD.....	1034
<i>Columbia University Biological Lectures:</i> J. H. MCG.....	1035
<i>The British National Physical Laboratory</i> .....	1036
<i>Scientific Notes and News</i> .....	1037
<i>University and Educational News</i> .....	1039

WHEN one considers the relations of the General Government to higher education and research, probably the first question to arise is, What, within the limitations imposed by the Constitution, can the Government do? Other pertinent inquiries are: What has been done? What is the present policy of the Government? How are its educational resources being utilized? What can be done that is not already being well done by our universities, colleges and technical institutions?

Many of our wisest and best statesmen and jurists believe that the General Government has no power, under the Constitution, to appropriate money for educational purposes, that important function having been left to the States. A glance backward over the history of colonial and national discussion and legislation is interesting and instructive.

## HISTORY OF COLONIAL AND NATIONAL DISCUSSION.

In colonial times Oxford, Cambridge and Edinburgh were to American youth the centers of learning and higher education. These famous universities furnished all that

\*MSS. intended for publication and books, etc., intended for review should be sent to the responsible editor, Professor J. McKeen Cattell, Garrison-on-Hudson, N. Y.

\*Substance of address before the University of Chicago, delivered June 17, 1901.

was needed by the well-to-do student, and local colleges were given little attention and scant support. The founders of our college system were obliged to meet adverse conditions which developed the same qualities that led their compatriots to the conquest of the continent.

Early in the seventeenth century (1619) the Virginia Company granted ten thousand acres of land 'for the foundation of a seminary of learning for the English in Virginia.' At the suggestion of the King, the bishops of England, in the same year, raised fifteen hundred pounds to aid in the education of the Indians in connection with the proposed grant of land for the seminary. A portion of the land was occupied and the seminary was started under the direction of George Thorpe, a man of high standing in England. But the institution was short-lived. It, with its inmates and founder, perished in the Indian massacre of 1622.

In 1624 an island in the Susquehanna river was granted for the founding and maintenance of a university, but the undertaking lapsed with the death of its projector and of James I. and the fall of the Virginia Company.

For a time the movement for higher education was delayed, but in 1636 Harvard was founded; then William and Mary, in 1660; Yale, in 1701; the College of New Jersey, in 1746; the University of Pennsylvania, in 1751; Columbia, in 1754; Brown, in 1764; Dartmouth, in 1769; the University of Maryland, in 1784; the University of North Carolina, in 1789-'95; the University of Vermont, in 1791, and Bowdoin, in 1794.

The university spirit was well developed when the Constitutional Convention met in 1787. Madison, who was a member of the convention, acting in harmony with the known wishes of Washington, proposed to give the National Legislature power—

To establish a university.

To encourage, by premiums and provisions, the advancement of useful knowledge and the discussion of science.

Charles Pinckney also earnestly advocated a plan for the establishment of a national university, and Mr. Wilson supported the motion; but the matter was dropped, on the ground that Congress already had sufficient power to enact laws for the support of national education.

John Adams, who agreed with Washington in believing that 'scientific institutions are the best lasting protection of a popular government,' was always a strong advocate of the promotion of intelligence among the people. He secured the insertion in the constitution of Massachusetts of a provision recognizing the obligation of a State to pursue a higher and broader policy than the mere protection of the temporal interests and political rights of the individual. This provision read as follows:

It shall be the duty of legislatures and magistrates in all future periods of this Commonwealth, to cherish the interests of literature and the sciences \* \* \* to encourage private societies, and public institutions, rewards and immunities for the promotion of agriculture, arts, sciences, commerce, trades, manufactures, and a natural history of the country.\*

Washington sought to impress on Congress and the people his earnest conviction that the Government should establish and support a great national university. To this end he made a bequest in his will, and if Congress had treated it as the Legislature of Virginia treated his bequest for the endowment of Washington College, there would be to-day a fund sufficient to give adequate support to a great institution for investigation and original research in the capital city. In his will Washington expressed the fears he entertained as to the effect of foreign education on the youth of America, and the desirability of having an American university. His language was as follows:

\* Massachusetts Public Statutes, 1882, p. 34.

That as it has always been a source of serious regret with me to see the youth of these United States sent to foreign countries for the purpose of education, often before their minds are formed, or they have imbibed any adequate ideas of the happiness of their own, contracting too frequently not only habits of dissipation and extravagance, but principles unfriendly to republican government, and to the true and genuine liberties of mankind, which thereafter are rarely overcome. For these reasons it has been my ardent wish to see a plan devised on a liberal scale which would have a tendency to spread systematic ideas through all parts of this rising empire, thereby to do away with local attachments and State prejudices, as far as the nature of things would, or indeed, ought to admit, from our national councils. Looking anxiously forward to the accomplishment of so desirable an object as this is (in my estimation), my mind has not been able to contemplate any plan more likely to effect the measure than the establishment of a university in a central part of the United States, to which the youth of fortune and talents from all parts thereof might be sent for the completion of their education in all the branches of polite literature, in arts, and sciences, in acquiring knowledge in the principles of politics and good government, and (as a matter of infinite importance, in my judgment), by associating with each other, and forming friendships in juvenile years, be enabled to free themselves in a proper degree from those local prejudices and habitual jealousies which have just been mentioned, and which when carried to excess are never-failing sources of disquietude to the public mind, and pregnant of mischievous consequences to this country.

Madison, though defeated in his effort to secure the approval of the Constitutional Convention in respect to the establishment of a national university, did not fail, when President, to call the attention of Congress to the subject. In his second annual message he said :

I cannot presume it to be unreasonable to invite your attention to the advantages of superadding to the means of education provided by the several States a seminary of learning instituted by the national legislature, within the limits of their exclusive jurisdiction, the expense of which might be defrayed or reimbursed out of the vacant grounds which have accrued to the nation within those limits. (Annals of Congress, 1810, '11, '13.)\*

\* 'The History of Federal and State Aid to Higher Education in the United States,' by Frank W. Black-

mar, Ph.D. : Bureau of Education, Contributions to American Educational History, edited by Herbert B. Adams, No. 9, 1890, p. 32.

Various other attempts have been made from time to time to establish a national university. Blackmar says :

In 1796 a proposition was before Congress in the form of a memorial praying for the foundation of a university. (Ex. Doc., 4th Congress, 2d session.)

Again, in 1811 a committee was appointed by Congress to report on the question of the establishment of a seminary of learning by the National Legislature. The committee reported unfavorably, deeming it unconstitutional for the Government to found, endow and control the proposed seminary. (Ex. Doc., 11th Congress, 3d session.)

In 1816 another committee was appointed to consider the same subject, and again the scheme failed. (Ex. Doc., 14th Congress, 2d session.)\*

When the disposition of the Smithsonian fund was under consideration (1838-1846), the subject of founding a national university was fully and freely discussed, and the plan was rejected by Congress.

Again in 1873 the matter was revived by the Hon. J. W. Hoyt, who from that time onward never ceased to labor diligently for a national university. Largely owing to his zeal and activity a committee of 100 was formed, various bills were introduced in Congress and a Senate Committee was created to establish a national university. But Congress always looked on the scheme with suspicion and not one of the various bills offered was ever acted upon by the Senate or House of Representatives.

The trend of opinion has been and is that the Government should not found a national university in the sense suggested by Washington and his followers. The Congress has, however, generously aided technical and higher education by grants of land to States and Territories for educational purposes.

The policy was inaugurated under the general authority of the famous Ordinance of July 13, 1787. Conformably thereto a

mar, Ph.D. : Bureau of Education, Contributions to American Educational History, edited by Herbert B. Adams, No. 9, 1890, p. 32.

\* Op. cit., pp. 39, 40.

contract was entered into between the Ohio Company and the Board of Treasury of the United States, on the 27th of July, 1787, whereby lot 16 in every township was given for the maintenance of public schools and not more than two complete townships were given perpetually for the purpose of a university, the land to be applied to the purpose by the legislature of the State.\*

The most important act, after that of 1787, was that of 1862, granting land for the endowment of colleges for teaching agriculture and the mechanical arts. It is to be noted that by this act the responsibility was thrown entirely upon the States, and that, so far as the administration of the fund was concerned, it was State, not national, education.

The total grants of lands aggregate about 13,000,000 acres, or 20,000 square miles. Of this 2,500,000 acres, or 4,000 square miles, were for the establishment of higher institutions of learning. This land, divided among thirty States and Territories, gives an average of a little more than 80,000 acres, or about 130 square miles. For technical schools, called 'Colleges for the benefit of agriculture and the mechanical arts,' Congress has granted to forty-five States 10,500,000 acres, or about 16,000 square miles. This is an average of 230,000 acres, or about 360 square miles. Congress now grants annually to each of the forty-five States \$25,000, † a total of more than a million dollars, all of which is expended under the direction of State boards.

The Government maintains, and has maintained since 1802, an academy for training its army officers; also, since 1845,

\* Bancroft, 'History of the Constitution,' N. Y., 1882, Vol. II., pp. 435, 436. Also Geo. B. Germann, 'National Legislation concerning Education,' New York, 1899, pp. 19, 20.

† Act approved August 30, 1890. Statutes at Large, Vol. 26, p. 417.

an academy for training its naval officers. The Government does not maintain and never has maintained any institution for training its civil officers.

The policy of the Government, as gathered from its acts, has been to relegate the direct control of education to the States, aiding them in this work by grants of land, and in the case of technical education by grants of money also.

#### PRESENT POLICY OF THE GOVERNMENT.

Turning, now, to the question, What is the present policy of the Government? we have just seen that aid is given by grants of land, and in the case of the experiment stations by grants of money. As to the use of its literary and scientific collections by students its policy was defined by a public resolution of Congress approved April 12, 1892, which reads as follows:

Whereas large collections illustrative of the various arts and sciences and facilitating literary and scientific research have been accumulated by the action of Congress through a series of years at the national capital; and

Whereas it was the original purpose of the Government thereby to promote research and the diffusion of knowledge, and it is now the settled policy and present practice of those charged with the care of these collections specially to encourage students who devote their time to the investigation and study of any branch of knowledge by allowing to them all proper use thereof; and

Whereas it is represented that the enumeration of these facilities and the formal statement of this policy will encourage the establishment and endowment of institutions of learning at the seat of Government, and promote the work of education by attracting students to avail themselves of the advantages aforesaid under the direction of competent instructors: Therefore,

*Resolved, by the Senate and House of Representatives of the United States of America, in Congress assembled, That the facilities for research and illustration in the following and any other Governmental collections now existing or hereafter to be established in the city of Washington for the promotion of knowledge shall be accessible, under such rules and restrictions as the officers in charge of each collection may prescribe, subject to such authority as is now or may hereafter*



be permitted by law, to the scientific investigators and to students of any institution of higher education now incorporated or hereafter to be incorporated under the laws of Congress or the District of Columbia, to wit :

- One. Of the Library of Congress.
- Two. Of the National Museum.
- Three. Of the Patent Office.
- Four. Of the Bureau of Education.
- Five. Of the Bureau of Ethnology.
- Six. Of the Army Medical Museum.
- Seven. Of the Department of Agriculture.
- Eight. Of the Fish Commission.
- Nine. Of the Botanic Gardens.
- Ten. Of the Coast and Geodetic Survey.
- Eleven. Of the Geological Survey.
- Twelve. Of the Naval Observatory.

The privileges of this act, it will be noted, are limited to scientific investigators and students of institutions incorporated under the laws of Congress or the District of Columbia. This limitation was removed by an act approved March 3, 1901, which reads as follows :

Joint resolution to facilitate the utilization of the Government Departments for the purposes of research, in extension of the policy enunciated by Congress in the joint resolution approved April 12, 1892.

WHEREAS \* \* \*

*Resolved*, That facilities for study and research in the Government departments, the Library of Congress, the National Museum, the Zoological Park, the Bureau of Ethnology, the Fish Commission, the Botanic Gardens and similar institutions hereafter established shall be afforded to scientific investigators and to duly qualified individual students, and graduates of institutions of learning in the several States and Territories, as well as in the District of Columbia, under such rules and restrictions as the heads of the departments and bureaus mentioned may prescribe.

#### DISCUSSION AND ACTION IN RECENT YEARS.

Dr. Daniel C. Gilman, in 1897, summarized the situation in relation to the establishment of a national university, as follows :\*

*First*, there is a strong desire, not only among the residents of the Federal city, but among the lovers and promoters of learning throughout the country, that the libraries, collections, instruments, and appa-

ratus belonging to the Government should be opened to students, not as a favor, nor by exception, nor as a passing entertainment, but for study and experiment, according to suitable regulations, and especially under the guidance of such able teachers as may be already engaged in the service of the Government, or may be enlisted hereafter for the particular offices of education. So far as this there would be a unanimous, or nearly unanimous, assent.

*Second*, the universities existing in Washington and near to it, including those of New England, would regard with disfavor, and probably with distrust, an effort to establish, by congressional action, the University of the United States. In some places there would be positive opposition. \* \* \*

*Third*, outside of academic circles, as well as inside, there is a great distrust of the principle that Congress should provide for and direct university education. The fears may be foolish. It is easy to laugh at them. Apprehensions may be pronounced groundless; nevertheless it will be difficult to get rid of them. There will be an ever-present expectation of political interference, first in the governing body, then in the faculty, and finally in the subjects and methods of instruction. It is true that partisan entanglement may be avoided, but it will be difficult indeed to escape the thralldom.

In the same article it is suggested that the Smithsonian Institution take charge, so that—

The literary and scientific institutions of Washington may be associated and correlated so far, and so far only, as relates to the instruction and assistance, under proper restrictions, of qualified students. \* \* \* Such a learned society may be developed more readily around the Smithsonian Institution, with less friction, less expense, less peril, and with the prospect of more permanent and widespread advantages to the country, than by a dozen denominational seminaries or one colossal University of the United States.

In February, 1899, Dr. William H. Dall, of the Geological Survey, outlined very clearly the conditions and possibilities for post-graduate work in Washington, and urged that if any organization was attempted it should be free from Government control.\*

Little, if any, advantage was taken of the congressional resolution of 1892, which restricted opportunities for study and re-

\* *Century Magazine*, November, 1897.

\* *American Naturalist*, Vol. 33, pp. 97-107.

search to the educational organizations of the District of Columbia, but with the recent rapid growth of the Department of Agriculture, a considerable number of students have been given opportunity for study and practical training. Secretary Wilson has taken the lead in actually bringing qualified students into the laboratories of a Government department and setting them to work. He has inaugurated a new class, called 'student assistants,' and has demonstrated its practical value. In his report for 1898 he says :\*

George Washington, by his will, left property to be devoted to university education in the District of Columbia. There is no university in the land where the young farmer may pursue post-graduate studies in all the sciences relating to production. The scientific divisions of the Department of Agriculture can, to some extent, provide post-graduate facilities. Our chiefs of division are very proficient in their lines; our apparatus the best obtainable; our libraries the most complete of any in the nation. We can direct the studies of a few bright young people in each division, and when the department requires help, as it often does, these young scientists will be obtainable.

They should be graduates of agricultural colleges and come to the Department of Agriculture through a system of examination that would bring the best and be fair to all applicants. The capacity of the department is limited, but something can be done that will indicate to Congress the value of the plan. The department often needs assistants to take the place of those who are tempted to accept higher salaries in State institutions. The opening of our laboratories to post-graduate work would provide an eligible list from which to fill vacancies as they occur, supply temporary agents, and be a source from which State institutions might get assistance in scientific lines.

The Department of Agriculture naturally turns to the professedly agricultural colleges for its student assistants, but if other institutions gave their students such instruction as would qualify them for the work of that department, there seems to be no good reason why they should be discriminated against.

\* 'Yearbook of the Department of Agriculture,' 1898, pp. 18, 19.

As the development of the work progressed in the scientific bureaus, it became impossible to find men qualified for the permanent positions open to them. Graduate students were obtainable, but they were without practical training for the work. The Civil Service Commission was called on, but it had no eligibles on its lists. The only way out of the difficulty seemed to be for the heads of the scientific bureaus to select bright, well-educated young men and train them; this they have been doing for several years. In the Geological Survey graduate students, being the best men available for temporary field assistants in both geologic and topographic work, are given preference. The Survey cooperates with such institutions of learning as are willing to give the advanced instruction necessary to fit students to engage in the several special lines of investigation. This cooperation consists mainly in the employment of graduate students and instructors. A high standard is maintained by the character of the examinations held for selecting temporary employes. For example, in the examination for temporary geologic assistants held April 23 and 24, 1901, the applicants were obliged to meet the following requirements:

First. To write an essay of more than a thousand words, setting forth either the course and results of an original geologic investigation by the applicant or the main features of the geology of some State.

Second. To answer satisfactorily seven questions, so selected as to test the applicant's knowledge of the science of geology in general.

Third. To select one of the five specialties, stratigraphy, petrography, paleontology, physiography, and glaciology, and make clear the possession of an adequate knowledge thereof.

The weight given to the various subjects was as follows:

Geological essay, including composition and drawing.....	30 per cent.
General geology.....	15 per cent.
Special geology.....	25 per cent.
Education and experience.....	30 per cent.

Fifty-two persons took this examination, and of these forty-six made an average of more than 70 per cent. The successful applicants have received degrees for academic and graduate study from the following institutions of learning :

Harvard University.....	13
Johns Hopkins University.....	6
University of Chicago.....	6
Yale University.....	5
Cornell University.....	4
University of Wisconsin.....	2
University of California.....	2
University of Kansas.....	2
Stanford University.....	2
Iowa State College.....	2
Amherst College.....	2
Munich.....	2
Alfred University.....	1
Beloit College.....	1
Columbia University.....	1
Columbian University.....	1
Cornell College, Iowa.....	1
Denison University.....	1
Gates College.....	1
German Wallace College.....	1
Hamilton College.....	1
Heidelberg College, Ohio.....	1
Heidelberg, Germany.....	1
Indiana State University.....	1
Lafayette College.....	1
Lawrence Scientific School.....	1
Moore's Hill College.....	1
Ohio Wesleyan University.....	1
University of Illinois.....	1
University of Minnesota.....	1
University of Missouri.....	1
University of Nebraska.....	1
University of the City of New York.....	1
University of Oregon.....	1
University of South Carolina.....	1
Williams College.....	1

The total of forty-six successful applicants divides by State residence as follows :

Massachusetts.....	9
Illinois.....	7
New York.....	7
Iowa.....	3
Connecticut.....	2
Indiana.....	2
Missouri.....	2
Pennsylvania.....	2
South Carolina.....	2

California.....	1
Colorado.....	1
Kansas.....	1
Kentucky.....	1
New Jersey.....	1
Ohio.....	1
Oregon.....	1
Tennessee.....	1
Wisconsin.....	1
Wyoming.....	1

Of those who passed, forty have received appointments to temporary positions. It is probable that 50 per cent. of the number will become permanent members of the Survey; 38 per cent. already hold or will obtain positions as instructors in educational institutions, and the others will enter State surveys and private employment.

Of the temporary geologic force of the Survey other than those mentioned, and who receive pay only when actually employed, the majority are connected with institutions of learning, as follows :

Harvard University.....	4
University of Chicago.....	4
University of Wisconsin.....	3
Columbia University.....	2
Stanford University.....	2
Yale University.....	2
Amherst College.....	1
Clark University.....	1
Colby University.....	1
Johns Hopkins University.....	1
Ohio State University.....	1
University of Michigan.....	1
University of California.....	1
University of Virginia.....	1
University of West Virginia.....	1
University of South Dakota.....	1
Vanderbilt University.....	1
Williams College.....	1

The preceding statements illustrate the intimate relation existing between one division of one bureau of one department of the Government and the higher educational interests of the country. A close analysis of the personnel of other bureaus will doubtless show that the Government is thus indirectly doing a great work in fostering higher education and research, and it will

at the same time be seen that the educational institutions of the country are training men and women for the highest scientific and technical positions in the Government service.

The Association of Agricultural Colleges and Experiment Stations several years ago realized the importance of giving its students the training which would enable them to meet the conditions prevailing in Washington. A committee of graduate study in Washington was appointed in July, 1897.\* In the following April this committee met in Washington to study the conditions under which work might be undertaken. In a report made in November, 1898, the committee said in part:

After long deliberation and full discussion your committee are unanimously of the opinion that the time is ripe for expeditious action.

The inquiries and investigations so far made lead the committee to the conclusion that it is entirely practicable to provide for the use of the Library of Congress and the collections of the Smithsonian Institution, the National Museum, and of the various scientific and other bureaus in the several departments of the general government, by graduate students of the land grant and other colleges, for study and research, and that it is also practicable to organize, coordinate, and direct such work so as to make it eminently effective.

\* *Resolved*, That a committee of five be appointed by the President to investigate, consider, and, if practicable, devise a plan whereby graduate students of the land grant and other colleges may have access to and the use of the Congressional Library and the collections in the Smithsonian Institution, the National Museum, and the scientific bureaus of the various departments at Washington of the United States Government for the purposes of study and research, said plan to include suggestions as to the manner in which such work may be organized, coordinated, and directed to the best advantage; the composition and organization of such a staff as may be necessary to properly coordinate and direct such work, and also an outline of such legislation as may be necessary to effect the general purposes of this resolution. (Proc. Twelfth Annual Convention of the Assn. Amer. Agricultural Colleges and Experiment Stations, held at Wash., D. C., Nov. 15-17, 1898, being Bull. 65, Dept. Agriculture, p. 58.)

The committee has been greatly desirous that some existing agency be found to undertake such work of organization, coordination, and direction, and have naturally turned to the Smithsonian Institution as the one best fitted for the purpose.

The committee is unable, at the present time, to present a complete outline of the legislation necessary to effect the general purposes of the resolution. It submits tentatively, however, that Congress might be asked to provide for the establishment of an administrative office in Washington, preferably in the Smithsonian Institution, in which graduate students of the institutions we represent, and others as well, might be enrolled and directed to the appropriate departments (Bull. 65, Dept. Agriculture, pp. 61, 62).

In a report by the subcommittee of the committee of the National Educational Association on the establishment of a national university, we find that the active cooperation of the Smithsonian Institution is contemplated in the conduct of the proposed school or bureau, but that the committee of the regents of the Smithsonian Institution feel that the powers of the institution, as at present organized, are insufficient to embrace the work proposed.\*

At a meeting of the Smithsonian regents held on January 24, 1900, Dr. Alexander Graham Bell introduced a resolution to the effect that Congress be asked to provide for an assistant secretary of the Smithsonian Institution in charge of research in the Government departments, etc. The resolution was referred to a committee, which, on January 23, 1901, reported a modified form of the original resolution. This modified form was adopted by the board of regents. It reads as follows:

In order to facilitate the utilization of the Government departments for the purpose of research, in extension of the policy enunciated by Congress in the Joint Resolution approved April 12, 1892:

*Resolved*, That it is the sense of the board that it is desirable that Congress extend this resolution so as to afford facilities for study to all properly qualified students or graduates of universities, other than those mentioned in the resolution, and provide for the appointment of an officer whose duty it shall be to as-

\* SCIENCE, N. S., Vol. XI, March 16, 1900, pp. 410-414.

certain and make known what facilities for research exist in the Government departments, and arrange with the heads of the departments, and with the officers in charge of the Government collections, on terms satisfactory to them, rules and regulations under which suitably qualified persons might have access to these collections for the purpose of research with due regard to the needs and requirements of the work of the Government; and that it should also be his duty to direct, in a manner satisfactory to the heads of such departments and officers in charge, the researches of such persons into lines which will promote the interests of the Government and the development of the natural resources, agriculture, manufactures and commerce of the country, and (generally) promote the progress of science and the useful arts, and the increase and diffusion of knowledge among men.

This resolution referred the matter to Congress. Many members of both Houses doubt whether Congress has power under the Constitution to appropriate money raised by taxation for purposes of education, and nothing was done by Congress, as the resolution was not officially brought before it.

#### ORGANIZATION OF THE WASHINGTON MEMORIAL INSTITUTION.

At this point the Washington Academy of Sciences undertook to give the proposition to utilize the resources of the Government for higher education and research a practical form, independent of direct Government support or control. For several months the Academy had been conferring with the George Washington Memorial Association relative to erecting in Washington a memorial building to be dedicated to science, literature and the liberal arts. The president of the Academy suggested to the Memorial Association that it should so amend its act of incorporation that it could cooperate with the Academy in carrying out the objects common to both organizations. The suggested amendments were made, and an agreement was entered into substantially as follows:

The objects of the George Washington Memorial Association are, first, as implied

in its name, the creation of a memorial to George Washington; and second, as stated in its amended act of incorporation, the increase in the city of Washington of opportunities and facilities for higher education, as recommended by George Washington in his various annual messages to Congress, notably the first—*i. e.*, 'the promotion of science and literature,' substantially as set forth in his last will, and by and through such other plans and methods as may be necessary or suitable. The object of the Washington Academy of Sciences, the federated head of the scientific societies of Washington, is the promotion of science, the term 'science' being used in its general sense—'knowledge, comprehension of facts and principles.'

The two organizations agreed, first, that, although American universities have so developed since George Washington's time that they fulfill many of the objects of the national university outlined by him as desirable for the youth of the United States, there is still need of an organization in the city of Washington which shall facilitate the utilization of the various scientific and other resources of the Government for purposes of research, thus cooperating with all universities, colleges and individuals in giving to men and women the practical post-graduate training which cannot be obtained elsewhere in the United States and which is now available only to a limited degree in the city of Washington, and, second, that the best method of securing the objects for which both organizations stand is the establishment, within the district selected by Washington as a site for the permanent seat of Government of the United States, of an institution whose object shall be the realization of Washington's repeatedly expressed wish and recommendation that provision be made for the *promotion of science and literature.*

The membership of the Academy in-

cludes most of the leading scientific men of Washington and the country at large. The Academy, familiar with conditions in Washington and with the efforts of the committees of the Association of Agricultural Colleges and Experiment Stations and the National Educational Association, and knowing that the Smithsonian Institution would not, under its limitations, take an active part, realized that the time was opportune for a new organization. Its committee drafted and secured the passage of the act of Congress approved March 3, 1901. The committee next drafted a plan of organization, which was accepted by the Academy and Memorial Association. The plan was, in brief, as follows :

1. *Organization.*—A private foundation independent of Government support or control.

2. *Objects.*—(a) To facilitate the use of the scientific and other resources of the Government for research.

(b) To cooperate with universities, colleges and individuals in securing to properly qualified persons opportunities for advanced study and research.

3. *Government.*—The policy, control and management to vest in a board of fifteen trustees, and in addition there shall be an advisory board composed chiefly of heads of executive departments, bureaus, etc.

Articles of incorporation were then drawn up and executed, and were filed on May 20, 1901. They read as follows :

*Articles of Incorporation, Washington Memorial Institution.*

*We, the undersigned, persons of full age and citizens of the United States, and a majority of whom are citizens of the District of Columbia, being desirous to establish and maintain, in the city of Washington, an institution in memory of George Washington, for promoting science and literature, do hereby associate ourselves as a body corporate, for said purpose, under the general incorporation acts of the Congress of the United States enacted for the District of Columbia ; and we do hereby certify in pursuance of said act as follows :*

*First.* The name or title by which such institution shall be known in law is the Washington Memorial Institution.

*Second.* The term for which said institution is organized is nine hundred and ninety-nine years.

*Third.* The particular *business and objects* of the institution are : to create a memorial to George Washington, to promote science and literature, to provide opportunities and facilities for higher learning, and to facilitate the utilization of the scientific and other resources of the Government for purposes of research and higher education.

*Fourth.* The number of its trustees for the first year of its existence shall be fifteen.

In testimony whereof we have hereto set our names and affixed our seals, at the city of Washington, in the District of Columbia, on the 16th day of May, 1901.

DANIEL C. GILMAN.	[SEAL.]
CHARLOTTE EVERETT HOPKINS.	[SEAL.]
C. HART MERRIAM.	[SEAL.]
GEORGE M. STERNBERG.	[SEAL.]
CHAS. D. WALCOTT.	[SEAL.]
CARROLL D. WRIGHT.	[SEAL.]

DISTRICT OF COLUMBIA, ss :

Be it remembered that on this 16th day of May, A. D. 1901, before the subscriber personally appeared the above-named Daniel C. Gilman, Charlotte Everett Hopkins, C. Hart Merriam, Geo. M. Sternberg, Chas. D. Walcott, and Carroll D. Wright, to me personally known and known to me to be the persons whose names are subscribed to the foregoing instrument of writing, and severally and personally acknowledged the same to be their act and deed for the uses and purposes therein set forth.

Given under my hand and official seal the day and year above written.

[SEAL.] (Signed) HERBERT W. GILL,  
Notary Public.

On May 27 fifteen trustees were elected, and on June 3 the officers for the first year were chosen. Lists of these are given herewith :

*Board of Trustees, Washington Memorial Institution.*

1. Dr. Edwin A. Alderman, President Tulane University.
2. Dr. A. Graham Bell, Regent Smithsonian Institution.
3. Dr. Nicholas Murray Butler, Professor of Philosophy and Education, Columbia University.
4. Dr. C. W. Dabney, President University of Tennessee.
5. Dr. D. C. Gilman, President Johns Hopkins University.
6. Dr. A. T. Hadley, President Yale University.

7. Dr. William R. Harper, President University of Chicago.

8. Mrs. Phoebe A. Hearst, Regent University of California.

9. Mrs. Archibald Hopkins, President George Washington Memorial Association.

10. Dr. C. Hart Merriam, Chief United States Biological Survey.

11. Dr. Cyrus Northrop, President University of Minnesota.

12. Dr. H. S. Pritchett, President Massachusetts Institute of Technology.

13. Dr. George M. Sternberg, Surgeon-General United States Army.

14. Hon. Charles D. Walcott, President Washington Academy of Sciences, and Director United States Geological Survey.

15. Hon. Carroll D. Wright, Commissioner of Labor.

*Officers of Washington Memorial Institution.*

Daniel C. Gilman, director.

Charles D. Walcott, president board of trustees.

Nicholas Murray Butler, secretary board of trustees.

C. J. Bell, treasurer.

An advisory board also was selected, as follows :

President of the United States.

Chief Justice of the United States.

Secretary of State.

Secretary of the Treasury.

Secretary of War.

Secretary of the Navy.

Secretary of the Interior.

Secretary of Agriculture.

Postmaster-General.

Attorney-General.

Secretary of the Smithsonian Institution.

Commissioner of Education.

Librarian of Congress.

Commissioner of Labor.

Commissioner of Fish and Fisheries.

President of the Civil Service Commission.

President of the National Academy of Sciences.

President of the National Educational Association.

President of the Association of American Universities.

President of the Association of Agricultural Colleges and Experiment Stations.

Dr. Charles W. Eliot.

The duties of the director, as defined in the by-laws are as follows :

The director shall be the chief executive of the institution, and, under the guidance and control of the

executive committee, shall conduct its affairs. He shall make all arrangements for cooperation between the institution, on the one hand, and the Government, universities, colleges, learned societies, and individuals on the other, subject to the approval of the executive committee.

EXISTING FACILITIES FOR STUDY AND RESEARCH.

The policy of the Government, as expressed, is to aid in higher education and research by granting the use of such facilities as are at its command in the District of Columbia. The direct control of higher education has been relegated to the States, the Government aiding by grants of land, and in the case of technical education at agricultural experiment stations by grants of money.

The Government has carried on original research for its own purposes in the District of Columbia through grants of money to its various scientific and technical bureaus, notably those of the Department of Agriculture, the Coast and Geodetic Survey, the Geological Survey, the National Museum, the Bureau of Ethnology, the Fish Commission, the Bureau of Education, the Library of Congress, etc.

Of the total sum appropriated for the fiscal year 1901, at least 25 per cent., or \$2,020,000, may be regarded as expendable for scientific and research work and in the interest of higher education. The appropriations for the year are as follows :

Department of Agriculture :		
Weather Bureau .....	\$1,168,320	
Bureau of Animal Industry .....	1,154,030	
"    " Plant Industry .....	204,680	
"    " Forestry .....	185,440	
"    " Chemistry .....	55,800	
"    " Soils .....	102,140	
Division of Entomology .....	36,200	
"    " Biological Survey .....	32,800	
Agricultural Experiment Stations.....	789,000	
Miscellaneous .....	222,000	
		\$3,937,410.00
War Department :		
Army Medical Museum and Library .....		25,000.00
Navy Department :		
Hydrographic Office.....	\$136,518.00	
Naval Observatory.....	226,461.08	
Nautical Almanac .....	15,900.00	
		378,879.08

Interior Department :		
Geological Survey .....	\$1,023,423.11	
Bureau of Education .....	59,370.00	
	1,082,793.11	
Treasury Department :		
Coast and Geodetic Survey .....	\$830,345	
Bureau of Standards .....	167,140	
Marine Hospital .....	71,100	
	1,068,585.00	
Smithsonian Institution :		
National Museum .....	\$289,400	
Bureau of American Ethnology .....	50,000	
National Zoological Park .....	80,000	
Astrophysical Observatory .....	12,000	
International Exchanges .....	24,000	
	455,400.00	
Commission of Fish and Fisheries .....	543,120.00	
Botanic Gardens .....	24,333.75	
Library of Congress .....	565,345.00	
Total .....	\$8,080,925.94	

This is about ten cents per capita for the entire population.

Great collections of books, specimens, statuary, paintings, instruments, apparatus, etc., have been assembled in Washington.

*Libraries.*—Statistics of the principal libraries reveal the presence of a large number of books, maps and pamphlets, many collections of which are exceptionally complete in special lines of research, notably those of the Departments of State and Agriculture, the Geological Survey, the Naval Observatory, the Surgeon-General's Office, the Bureau of Education, the Museum of Hygiene, the Patent Office, the National Museum, and special collections in the Library of Congress. The principal libraries are here listed :

	Books.	Pam- phlets.	Maps.
Library of Congress .....	1,000,000*		55,700
" " Smithsonian Institution .....	250,000†		
" " U. S. Supreme Court .....	80,000†		
" " Army Medical Museum .....	135,058	229,546	
" " Dept. of Agriculture .....	68,000		
" " Bureau of Education .....	81,872	140,004	
" " Patent Office .....	74,140		
" " Department of State .....	63,000	2,500	
" " Geological Survey .....	47,600	77,027	29,185
" " National Museum .....	25,000	30,000	
" " Coast and Geodetic Sur. ....	16,405	6,178	25,000
" " Weather Bureau .....	18,000	5,000	
" " Museum of Hygiene .....	11,969		

\* Books and pamphlets.

† These figures are included in the 1,000,000 assigned to the Library of Congress.

Library of Hydrographic Office .....	3,000	
" " Bureau of Ethnology .....	12,000	4,000
" " Bureau of Statistics .....	6,000	5,000
" " Department of Justice .....	30,000	
" " Department of Labor .....	7,051	4,454
" " Corcoran Gallery of Art .....	2,500	
" " Treasury Department .....	22,000	3,000
" " War Department .....	49,000	2,000
" " Navy Department .....	33,635	
" " Interior Department .....	15,000	
" " Post Office Department .....	12,000	
" " Light-House Board .....	5,000	
" " War Records Office .....	2,000	
" " Naval Observatory .....	20,000	4,000
" " Naut. Almanac Office .....	2,200	2,500
	2,092,430	515,209 109,855

Other libraries in the District bring the grand total to more than 2,500,000 volumes, 570,000 pamphlets, and 110,000 maps, assembled in large part by specialists in every field. All the libraries are accessible and are maintained at a high standard of efficiency.

*Collections.*—The collections of the National Museum, though inadequately housed and with insufficient laboratories for the work of the regular museum force, are, nevertheless, of such character and are so arranged for exhibition and study that they will be of great service to all who may wish to use them. Under the present organization of the museum there are three departments: Anthropology, Biology and Geology. All the exhibits are systematically classified and placed in immediate charge of specialists acquainted with the results of man's activity in almost every form in which such results admit of study and representative exhibition. As provided by statute, the collections made by the Geological and other surveys are deposited in the National Museum after they have been used by the organization which collected them. This has resulted in an immense accumulation of material, much of which has not yet been fully studied, and upon which, when sufficient laboratory space is provided, students can be employed under the oversight of the specialists in charge.



The collections of the Army Medical Museum have a world-wide reputation and contain a great quantity of unique and valuable material. There are large collections of living animals at the Zoological Park; and there is a fine series, illustrating fish culture, at the Fish Commission building. The museum of the Agricultural Department contains valuable material, especially the working collections of the different divisions, and the Botanic Gardens are capable of great development under scientific direction. To the student interested in the development of American inventive genius and the industries represented by patents the collection of models and drawings in the Patent Office offers exceptional opportunities. Mention should also be made of the collections of apparatus of various kinds in Government laboratories, and of the illustrations of the evolution of apparatus in the National Museum and Smithsonian Institution.

In art, while the collections are not so large as in other lines, yet there is a collection of excellent quality in the Corcoran Gallery of Art, which maintains a free school. In this school day and night classes are taught the arts of drawing and painting, free of tuition fees or charge of any kind. Up to the close of 1899, 844 pupils had received instruction in the day school and 1,483 in the night school.

The Naval Observatory has a good equipment, including a chart and a chronometer depot, an extensive collection of instruments used in taking astronomic photographs, a fine telescope and transit instruments used in carrying on its routine work.

The newly created National Bureau of Standards is to have buildings and a fine equipment of all necessary apparatus. When fully developed it will be second to none in the character and value of its scientific and practical work. The functions of

this bureau are defined in the organic act as follows:

The functions of the bureau shall consist in the custody of the standards; the comparison of the standards used in scientific investigations, engineering, manufacturing, commerce and educational institutions with the standards adopted or recognized by the Government; the construction, when necessary, of standards, their multiples and subdivisions; the testing and calibration of standard measuring apparatus; the solutions of problems which arise in connection with standards; the determination of physical constants and the properties of materials, when such data are of great importance to scientific or manufacturing interests and are not to be obtained of sufficient accuracy elsewhere.

*Law and Diplomacy.*—The State Department has accumulated a valuable library relating to international law. The law library of Congress contains more than 50,000 volumes exclusively legal in character, and accommodations are provided for students who wish to use it. The School of Diplomacy of Columbian University is one of the unique features of the educational organizations of Washington. The Supreme Court of the United States and the Court of Claims bring together the foremost American lawyers. There is also the Supreme Court of the District of Columbia, which has the common-law, equity, and probate jurisdiction of State courts, besides that of the circuit and district courts of the United States.

There are, of course, unequalled opportunities for studying the development of legislation and for meeting the leading statesmen and public men of the country.

*Medicine.*—The Army Medical Museum has one of the finest collections in existence of recent pathologic specimens. These, taken with the library of the Surgeon-General's Office, in the same building, afford a rare opportunity for the medical student. In the adjoining National Museum there is a most complete collection illustrating the *materia medica* of the United States and of foreign countries. There are also several

hospitals, at each of which clinical instruction is given.

Congress has enacted that these vast collections and resources shall be available for higher education and research, but it has not provided the machinery for making them practically available. As in the case of the grants of land to colleges, Congress provides facilities and indirectly the means, but it leaves to other agencies the task of devising ways and means to make them practically useful.

The Government is obliged to train most of its specialists. Opportunities for post-graduate study and research exist at a few of the strongest universities, colleges and technical schools of the country, but at best the training given, except in a few branches, is of a preparatory character. Most American youth who are ambitious to pursue higher study and research have little opportunity, owing largely to the fact that the instructor's duties leave him scarcely any time for research and practical work with the student. Post-graduate students seek instructors distinguished for research, even to the extent of undergoing many privations and leaving their country. In the city of Washington the Government has assembled the largest body of original investigators to be found in any one place in the world. Most of these investigators are willing to train suitably qualified students, because of the assistance the students can give them in the work they have in charge, the method being to have the students do actual, practical work, and not to instruct them in the ordinary sense of the word. An unofficial inquiry indicates the following as a possible number of instructors and students in the various departments and bureaus at Washington :

4. Statistics .....	2	5
5. Magnetism .....	1	2
6. Meteorology.....	5	15
7. Tides .....	1	2
8. National Standards (Bureau of).....	.....	.....
9. Astronomy .....	3	8
10. Physics.....	2	3
11. Hydrography .....	5	10
12. Cartography, etc.....	2	5
13. Topography .....	10	20
14. Chemistry .....	6	10
15. Mineral resources.....	1	5
16. Geology.....	10	17
17. Paleontology.....	5	7
18. Animal industry.....	10	25
19. Anthropology and ethnology.....	4	13
20. Zoology .....	34	50
21. Botany .....	11	25
22. Forestry.....	10	20
	133	272

With the development of a well-considered plan, just alike to the student and to the officers of the Government, the number of students—or, more strictly speaking, student assistants—would increase from year to year. Most of the students would naturally come from institutions of learning ; in all such cases the student should be certified to the director of the Washington Memorial Institution, and finally certified back to the parent institution after completing his work, such certificate to be based on the work done and the proficiency made. In the case of individual students not connected with any institution, let each prove his capacity to profit by the opportunities, and then accredit him to the special officer who has charge of the field of work in which he may wish to study ; on satisfactory completion of the work undertaken, the certificate of the Washington Memorial Institution might be addressed '*To whomsoever it may concern.*' Students working in Government laboratories, museums and libraries would be subject to the rules obtaining therein.

It is the belief of many acquainted with the educational system of the country that

	<i>Instructors.</i>	<i>Students.</i>
1. History and diplomacy.....	1	5
2. Historical research.....	5	10
3. Library administration and methods	5	15

the policy above outlined will result in a body of trained students, ready for expert work, many of whom will undoubtedly enter the government service, while others will become instructors in institutions of learning or be engaged as experts in private capacity. This will avoid competition with other institutions, will give most valuable training and practical experience to students, and will be especially helpful to instructors in educational institutions, who might wisely be sent for six months or a year to Washington, as at present some are sent abroad. There should be no thought of providing a general or liberal course of education. Coming as student assistants, there should be opportunities and encouragement only on clearly defined lines of study and investigation. There are many large and small problems to be worked out by the officers of the Washington Memorial Institution, but with the skilled educator and organizer now at its head as director their successful solution is only a matter of time. It is anticipated that the Washington Memorial Institution will, under the direction of Dr. Gilman, begin its work by November 1, 1901.

The Government's part in the work, when once under successful headway, will be to enlarge the quarters of the various bureaus concerned. This will be necessary eventually even if no student assistants are provided for. The Government has done its part nobly so far. It is now for the educational institutions of the country to come forward and assist by setting a high standard of scholarship for admission to the privilege of becoming a student assistant in the Government bureaus. Only students of the type of those who win fellowships or excel in ability should be certified or accepted.

The Washington Memorial Institution should, and I believe will, maintain a standard that will meet the approval of our

colleges and universities. It should occupy a most important place in the great educational work of the country. With the hearty cooperation of our collegiate institutions and of the officers of the Government, there is little question that it will ultimately become the federated head and clearing-house of all the higher educational interests of the country.

The relations of the National Government to higher education and research are intimate and complex; but the complexities are already partially resolved, the present is auspicious, and the future outlook is most promising. Long ago the nation recognized its obligation 'to promote a higher and more extended policy than is embraced in the protection of the temporal interests and political rights of the individual.' The action of Congress in the present year in opening the Government bureaus at Washington for study and research is a long stride forward, and, if carried out in good faith must result in another and higher standard for American endeavor.

CHARLES D. WALCOTT.

U. S. GEOLOGICAL SURVEY.

#### THE ROYAL SOCIETY OF CANADA.

THE twentieth general meeting of the Royal Society of Canada was held in Ottawa, May 21, 22 and 23, 1901. This is essentially a national institution. It was founded in 1882 by the Marquis of Lorne, now His Grace the Duke of Argyll. The Society is divided into *four* sections:

- I. French Literature, History and allied subjects.
- II. English Literature, History and allied subjects.
- III. Mathematical, Physical and Chemical Sciences.
- IV. Geological and Biological Sciences.

The Society met this year under the presidency of Dr. Louis Honoré Fréchet, C.M.G., who delivered his inaugural address, 'Race and Language Problem in

Canada, on the evening of Tuesday, May 21, before a large audience. The various sections met for the transaction of business and reading of papers. Delegates from affiliated literary, scientific and historical societies throughout Canada presented their reports and many of them took part in the deliberations of the Society.

The report of Council for 1901, presented by the Honorary Secretary, Sir John George Bourinot, K.C.M.G., historian, besides containing an account of the business affairs of the Society regarding the election of four new fellows, the diplomas of fellowship, the death of the Queen and the accession of King Edward VII., the associated societies and the proposed meeting in Toronto in 1902, dealt a heavy blow upon the circulation of 'yellow' journals of the United States and in general. The question of establishing public libraries, the care of the Dominion archives, the Canadian Marine Biological Station, Nova Scotian and New Brunswick archives, tidal investigations, together with the question of publishing historical memoirs and diaries received attention as well as the question of preservation of places of scenic and historic interest, including the site of Louisbourg and the Plains of Abraham. The report also contained biographical sketches of the late fellows, Hon. F. X. Marchand and Dr. George Mercer Dawson.

In accordance with a suggestion contained in the honorary secretary's report of last year, to prepare a record of Canadian publications embraced under the several sections of the Royal Society, the following committee of Section IV., which was appointed in May, 1900, reported, viz: For geology and paleontology, Dr. H. M. Ami; for general zoology, exclusive of entomology, Dr. J. F. Whiteaves; entomology, Dr. C. J. S. Bethune; botany, Dr. A. H. Mackay. By a resolution of the Section the same committee was reappointed for the year 1901.

Inasmuch as Sections I. and II. are literary and historical and Sections III. and IV. deal with the *sciences* mathematical, physical, chemical and natural, the following abstracts of papers read before the last two named sections will be given for the benefit of the readers of SCIENCE:

SECTION III.—MATHEMATICAL, PHYSICAL  
AND CHEMICAL SCIENCES.

Presidential Address: *A Century of Progress in Acoustics*: PRESIDENT LOUDON, of the University of Toronto.

*The Principles at the Base of Quaternion Analysis*: Professor ALFRED BAKER, M.A., of the University of Toronto.

*Note on the Basic Chlorides of Lead, Antimony and Copper*: Professor W. LASH MILLER, PH.D., of the University of Toronto, and Mr. F. B. KENRICK, PH.D.

A method of ascertaining whether the precipitate produced in a salt solution by potash or ammonia is a single chemical compound, a mixture, or a 'solid solution,' with results of experiments.

*The Synchronism of Arctic and Antarctic Auroræ*: Mr. ARTHUR HARVEY.

Auroral observations of the Belgian Antarctic expedition of 1898. Construction of a table and an auroral curve therefrom; identification of this curve with those for Canada and the United States. Enquiry from Arctowski, meteorologist of the *Belgica*, if other concordances are traceable between Auroræ Australes and Boreales. He entrusts the examination to Canada. Detailed scrutiny of the records of these countries shows the distribution of auroræ to be local and that their character varies at various points. Negative answers must be returned to the questions asked, but close examinations of auroræ in Canada must be made during the several Antarctic expeditions soon to set out.

*The Human Machine, the Most Marvelous (as set forth by Dr. Lardner in his Animal Physics, 40 years ago)*: MR. C. BAILLARGÉ, C.E., M.A.

*On the Occurrence of Free Ammonia in Saline Waters*: FRANK T. SHUTT, M.A., F.I.C., F.C.S.

*The New Gas from Radium*: Professor E. RUTHERFORD B.A. (Cantab.), of McGill University, and Miss H. T. BROOKS.

*Discharge of Electricity from Glowing Bodies*: Professor E. RUTHERFORD, of McGill University.

#### SECTION IV.—GEOLOGICAL AND BIOLOGICAL SCIENCES.

*Observations on Phenological Records*: Presidential Address before the Section by Dr. A. H. MACKAY, Superintendent of Education in Nova Scotia.

In this paper Dr. MacKay referred to the different stations established in Nova Scotia and other portions of Canada where phenological observations were being recorded. The records of the average phenocron of certain well-known species of flowering plants were also discussed, and the best methods of eliminating errors in records.

*Sir John W. Dawson—In Memoriam*: Professor FRANK D. ADAMS, M.E., Ph.D., (by request of the Royal Society at its meeting in 1900).

This memorial of the first president of the Royal Society of Canada was read by title and ordered to be printed *in extenso* together with Dr. Ami's completed 'List of Writings of Sir William Dawson.'

*The Carboniferous Basin in New Brunswick*: R. W. ELLS, LL.D., of the Geological Survey of Canada.

The Carboniferous rocks in New Brunswick embrace an area of not far from 12,000 square miles. They occur in a roughly triangular-shaped basin, which extends from the Gulf of St. Lawrence on the east as a

base, nearly to the southwest boundary of the province. At a number of points beds of coal are found, but these, in so far as yet examined, are thin, ranging from a very few inches to about two feet in thickness. Borings have been made from time to time for over sixty years to ascertain the presence of thicker or more workable beds, but owing to various causes such attempts have not yet been successful. The greater portion of the area, however, has not yet been proved. The paper will briefly state some of the principal conclusions arrived at regarding the structure of this basin during the last thirty years, and will indicate the relations of the Carboniferous sediments to the rocks of the underlying formations. In the discussion which followed, Dr. Bailey pointed out that the Legislature of New Brunswick had granted a subsidy for the purpose of developing the coal-bearing areas of the Grand Lake District. Dr. Matthew maintained that there was considerable chance of discovering suitable coal seams in New Brunswick, and argued that something should be done to ascertain their possible existence. Dr. Ami stated that within the Carboniferous Basin of New Brunswick he would include the strata called 'fern-ledges,' Lancaster formation or 'Little River Group,' which held a flora and fauna of Carboniferous age.

*Notes on Some of the Silurian and Devonian Formations of Eastern Canada, and their Faunas and Floras*: H. M. AMI, M.A., D.Sc., F.G.S.

From recent studies carried on by the author, the succession of the sedimentary formations of both the Silurian and the Devonian Systems in Eastern Canada needs revision and elucidation. There are several distinct geological horizons which constitute as many distinct formations that are as yet unplaced and unnamed in the Canadian succession, and a discussion of the relations which exist between the different

formations or members of these systems in different portions of Canada was presented. The subdivision of the Silurian succession at Arisaig, in Antigonish County, Nova Scotia, those of Gaspé, Anticosti and Ontario are included, and are based upon the faunas determined by the late Mr. Billings and Professor Hall, as well as from material in the hands of the author for some years past. The subdivisions of typical Devonian formations are also given. These will form a basis for the classification of the terranes in eastern Canada, according to latest and most approved methods.

*Aerothyra and Hyolithes—a comparison. With a description of a new species of Hyolithes*: G. F. MATTHEW, LL.D.

The comparison was made for the purpose of seeing how far the muscular system of one genus corresponds to that of the other. The ventral valve of *Aerothyra* was compared with the tube of *Hyolithes*, and the dorsal valve of the former genus with the operculum of the latter. The *Hyolithes* described is a slender species from the base of the *Paradoxides* bed at St. John.

*On some Modes of Occurrence of the Mineral Albertite*: Professor L. W. BAILEY, LL.D., of New Brunswick University.

Since the closing of the celebrated Albert Mines, in Albert county, New Brunswick, the ownership of which for a time hinged upon the determination of whether the mineral which thence derived its name should be regarded as coal or asphalt—a number of interesting observations have been accumulating which have a direct bearing upon this question. The present paper narrates and discusses some of these observations, and is accompanied by specimens illustrating the occurrence of the mineral with widely different associations, and in rocks of quite different geological horizons, *e. g.*, in Pre-Cambrian slates, in calcareo-bituminous shales, in gray Car-

boniferous sandstones, in snow alabaster, in admixtures of calcite and pyrite, and cementing crystals of selenite. The vein-like nature of the mineral and its originally fluid or semi-fluid condition are strongly emphasized. In the discussion which followed, Dr. Ells, Dr. Ami and Mr. Poole took part. Dr. Ells places the Albert shales in the Devonian System. Dr. Ami argued for the Eo-Carboniferous age as shown by fish remains and plants.

*Jacques-Philippe Cornuti. Notes pour servir à l'histoire des sciences au Canada*: Par MGR. LAFLAMME.

Cornuti a publié à Paris, en 1635, un volume qui renferme la description d'un bon nombre de plantes canadiennes. Il n'est jamais venu au Canada; ses études ont été faites d'après des échantillons vivant dans le jardin des Robins, à Paris. Le but de cette note est d'abord de rechercher par qui les plantes canadiennes avaient été transportées à Paris, si tôt après la fondation de Québec, et ensuite, d'examiner toutes ces descriptions et de déterminer la synonymie entre la nomenclature de Cornuti et la nomenclature actuelle.

*On some Geological Correlations in New Brunswick*: Professor BAILEY, LL.D., of New Brunswick University.

While the geological age of the rock formations in New Brunswick has in most instances been determined upon satisfactory evidence, much uncertainty has existed regarding certain groups of strata and especially those which, consisting largely of slaty rocks, border the great central granite axis which traverses the central part of the province, in the counties of York, Carleton, Northumberland and Gloucester. For, though regarded originally as Cambrian by Gesner, Robb, Logan, Hind and others, and subsequently colored and described, though only provisionally in the maps and reports of the Geological Survey, as Cambro-

Silurian, the only fossils found therein, at widely separated points, were, with a single exception, where an Ordovician fauna occurs, such as to indicate a much more recent (Silurian or Devonian) horizon. In the investigation of the problems arising from this fact, and in the effort to determine, upon behalf of the Geological Survey, more exact knowledge as to what systems were actually present and their relative limits, the author of this paper was, during the past summer, fortunate in being able to obtain evidence in the discovery of certain graptolitic strata, tending to confirm the original view that large portions of the belts in question are really of Cambrian age, with a probability that other large areas are still older, representing either the Etcheminian formation, so called, of Matthew or the Huronian of other writers. The facts relating to these observations, which have a bearing upon questions of a far-reaching character in relation to Acadian geology, are in this paper briefly summarized and discussed.

*On the Subdivisions of the Cambrian System in Canada:* H. M. AMI, M.A., D.Sc., F.G.S., of the Geological Survey of Canada.

This paper discusses the various geological formations which naturally fall under the Cambrian system in British North America. An attempt is made to present a systematic table giving the succession of the different faunas of this system and the different formations under which each falls. The main object of this paper is to bring the nomenclature of this system to date with a view of classifying the organic remains comprised within its limits, with a brief discussion as to these limits.

*A Backward Step in Paleobotany:* G. F. MATTHEW, LL.D.

This is a review of the attempt made to claim the plant beds in the Little River Group and their flora, and so the whole

terrane, as Carboniferous. This claim is made on Paleobotanical grounds by Messrs. D. White, R. Kidston and H. M. Ami.

The article recites the stratigraphical and physical objections to this view, and in this connection two sections near St. John are given, showing the relation of this terrane to the lower Carboniferous. The fauna of the plant beds is reviewed, and it is suggested that even from this point of view there is not sufficient evidence to overthrow the result arrived at by those who had previously studied the flora and the stratigraphy. Dr. Bailey, Dr. Eells, Mr. H. S. Poole and Dr. Ami took part in the discussion which followed the reading of this paper. The first three gentlemen brought forth all the arguments possible bearing on the Devonian age of the plant beds in question. Dr. Ami pointed out the synchronism existing between these beds and the Carboniferous strata of other parts of North America and Europe.

*Notes on Some Butterflies from Western Canada:* Dr. JAMES FLETCHER, Dominion Entomologist.

This paper described interesting captures made in the northwest Territories and the Rocky Mountain region of Canada.

*The Avifauna of the Province of Quebec:* Sir JAMES M. LEMOINE, Knt. F.R.S.C.

This forms an interesting check-list of the birds of the Province of Quebec.

*A Dual Classification required in the Nomenclature of the Geological Formations in Different Systems in Canada:* H. M. AMI, of the Geological Survey of Canada.

This paper brings forward the result of special work carried on by the writer during the past fifteen years in the classification of numerous geological formations throughout the Paleozoic Period in Eastern Canada. It has become necessary, in the light of recent investigation, to introduce two parallel columns at least, in the suc-

cession of the geological formations of Ordovician, Silurian, Devonian and even Carboniferous Systems. Tables giving the natural order of succession of the different formations falling under this dual classification accompany the paper.

*The Value of Nature Study in Practical Education:* Dr. JAMES FLETCHER, Dominion Entomologist at the Central Experimental Station at Ottawa.

In his opening remarks Dr. Fletcher said that he was thankful that the educators of the youth in every province of Canada have shown that they keenly appreciate the value of natural history studies as an integral and effective part of a practical education. He would appeal more especially, now, to the educated classes of Canada, amongst whom it must be acknowledged there is an appalling and unnecessary ignorance upon many useful branches of knowledge, some information upon which would make them far better citizens and more efficient competitors in whatever branch of work they may have adopted as the means of obtaining a livelihood. There is no profession, trade or occupation, in which definite or exact knowledge is not daily required with regard to subjects, the consideration of which comes within the scope of some branch of natural science. The last half-decade has seen a bright awakening to the realization of the value of nature studies as a means of cultivating the faculties of the youth of every land where progress is made. To teach the child the beginnings of things, the elements of knowledge through the common things about us, will lead it to want to see, to know and understand, and hence think carefully with a view of drawing right conclusions. The flowers, birds and insects furnish as many and useful objects for the grandest, the simplest and best lessons in educating the youth of our land. Whether they are beneficial or injurious, and why so, will

lead the observing student to find out their uses and recognize whether they have or have not as yet been recognized. Sympathy and kindness are the outcome of nature studies, likewise healthful enjoyment. Principles of perfection appear wherever nature has not been interfered with. A perfect method and system is revealed, and well may those entrusted with the education of others turn to these natural models to inculcate those principles so necessary to develop the mind.

Amongst the interesting exhibits shown during the meetings of the Royal Society was a plan of the new museum, known as the 'Victoria Memorial Museum,' to be erected in Ottawa at once. Through the kindness and courtesy of the Honorable Mr. Tarte, Minister of Public Works, the plans were placed on exhibition in the Normal School building where the Royal Society was holding its meetings. The building has a frontage of 322 feet, and is 188 feet deep, with a tower dome in the center. It is intended to accommodate the collections at present stored in the unsafe building occupied by the Geological Survey Department on Sussex Street, Ottawa, comprising minerals, ores, fossils, plants, trees and other natural history objects as specimens illustrating the natural resources of Canada, also the Fishery exhibit now on O'Connor Street, and the paintings in the Art Gallery. A resolution, passed by the Royal Society of Canada and transmitted to the Government of Canada congratulated the latter on its wise action.

On May 22 a resolution was passed approving and supporting Capt. F. Bernier, of Quebec City, who is taking charge of the expedition to the North Pole. An interesting discussion followed in which many Fellows took part, including G. H. Parkin, C.M.G., Sir Sandford Fleming Dr. R. Bell,



F.R.S. and Capt. Bernier himself. It will be remembered that in 1900 the last-named gentleman described his proposed route of travel after having pointed the courses taken by all the previous important expeditions to the North Pole, including Fridtjof Nansen's important last voyage.

The following officers were elected :

President: Principal J. London, LL.D., of Toronto University, Toronto.

Vice-President: Sir James A. Grant, K.C.M.G., M.D., etc., Ottawa.

Hon. Secretary: Sir John G. Bourinot, K.C.M.G., LL.D.

Hon. Treasurer: Dr. James Fletcher, F.L.S.

The following officers of Section IV. (Geology and Biology) were elected for the ensuing year :

President: Professor Frank D. Adams, M.Sc., Ph.D.

Vice-President: Professor T. Wesley Mills, M.D., etc.

Secretary: Mr. G. U. Hay, Ph.B. (St. John, N.B.).

H. M. AMI.

OTTAWA, May 27, 1901.

---

SCIENCE AND THE LONDON UNIVERSITY.\*

I.

By the University of London Act, 1898, and the statutes and regulations framed in pursuance thereof, the long-standing controversy as to the form and organization of the London University was finally disposed of. The various colleges and other institutions doing university work within the metropolitan area have been coordinated under a strong and representative senate, which is charged with the duty of providing, for the six millions of inhabitants within a radius of 30 miles from the University building, every kind of instruction of university type. To enable the reorganized London University to cope with this gigantic task, the Chancellor of the Exchequer frankly

confesses his inability to do more than provide the office expenses. If London wants a teaching university, London, says the Chancellor, must pay for it. In the special financial circumstances of the moment this appeal to public-spirited Londoners can scarcely be considered unreasonable.

The task of equipping and endowing a University can never be a small one, and the extent and variety of the needs of London might daunt the munificence even of an American millionaire. Fortunately, we do not have to start quite from the beginning. The organization and constitutional framework are completed and stand ready to start. A large part of the materials for a University worthy even of the capital of the Empire only await the hand of the master builder. What is wanted is, first, a comprehensive survey of the field and an appreciation of the amount and variety of the work to be done. Upon this must follow the motive power of money.

The new university is organized in eight faculties, namely, theology, arts, music, law, medicine, science, engineering and 'economics and political science (including commerce and industry).' But, though provision is thus made for all branches of University study, old and new, it is already clear that London University will have a character of its own. The distinctive note of the University is evidently destined to be that of applied science, or the concrete application to every branch of industrial and social life of the discoveries and laws of the various sciences. It is this side of university organization that we must therefore first consider.

In physical science the London University holds an honorable tradition, as having been the first to create a science degree. At present the University includes three 'schools' of science for men, and two more (Bedford and Halloway) for women only. Of these, the Royal College of Science, fully

\* From the London Times.

staffed and equipped at the Government expense, is confined practically to science teachers, drawn by scholarships from all parts of the country, and to the mining and metallurgical students of what was formerly the Royal School of Mines. The science schools at University and King's Colleges, directed by able professors, are severely handicapped by inadequate accommodation and limited funds, whilst the high fees necessitated by the absence of endowment exclude all but a small number of students. The total number of undergraduate science students in these five schools may be estimated at six or seven hundred. Cheaper science-teaching at more convenient centers, open in the evening as well as in the daytime, is supplied not only at the admirably organized Finsbury Technical College of the City and Guilds Institute, but also by the dozen so-called 'polytechnics.' These latter have been greatly improved during the last few years. By the aid of large grants from the London County Council, their laboratories and scientific equipment have been brought up to a high university standard, whilst the professional staff has been strengthened by the appointment of men of excellent scientific attainments. A large proportion of London candidates for science degrees are now trained in the polytechnic laboratories, which may probably include, in the aggregate, between two and three hundred science students above matriculation standard. The total number of science students of undergraduate status in the whole six million of people apparently does not reach one thousand. Additional centers of science instruction for undergraduates are required in north west London, Hackney and Hammersmith, whilst in the outer suburbs the existing institutions at Croydon, Tottenham and West Ham need developing up to university standard. With additional professors and enlarged laboratories at these twenty-five science centers,

all parts of London would be fairly well served, so far as science instruction up to the B.Sc. degree is concerned; and the number of undergraduate students in the faculty might reasonably be expected to rise to at least 2,000.

But the most serious deficiency in the London faculty of science is not the inadequacy of the instruction for the science degree, but the lack of anything like adequate provision for chemical, physical and biological technology, or the application of science to industrial processes. The munificence of Mr. Ludwig Mond has provided a well-equipped laboratory at the Royal Institution, in which a few highly qualified scientists find the opportunity for pursuing special researches. But of public provision for instruction in scientific technology there is practically none. The same national neglect which lost us the great industry of coal-tar products—positively a British discovery that we failed to utilize and abandoned to Germany—now bids fair to lose us one branch of applied chemistry after another. At the present moment perhaps the most promising outlook in the scientific field is presented by electro-chemistry, including both electrolysis and the multifarious operations of the electric furnace. This new science has already transformed the commercial production of copper and aluminum, and given us such new products as carbide of calcium (for the economical production of acetylene) and carborundum. It bids fair, moreover, to revolutionize the whole alkali industry. Yet beyond certain small experiments, due to personal initiative of two or three professors, London offers no means and no opportunities for instruction and research in the subject. If electro-chemistry is destined to transform the world's industry, it is to Germany, and not to England, that the advantage of the first start seems at present likely to accrue. There is no more press-

ing need in London's University equipment than a special school of electro-chemistry, fully equipped with its necessary expensive apparatus, and provided with an endowed and not overworked staff of professors, able to inspire and direct the studies and researches of a selected band of graduate students. The same deficiency is found in other branches of technology. Mining and metallurgy are provided for on what must be called a small scale at the Royal College of Science, and mineralogy also in two or three small classes elsewhere. But nothing that can be called adequate exists for the technical education, at convenient centers and hours, at low fees, of the swarm of mining and metallurgical engineers that London ought to be sending out to every part of the Empire. It deserves the attention of those who are interested in the great mining enterprises of South and West Africa, America and Australasia, whether the time has not come for the establishment of a distinct school of metallurgy and mining, with special reference, not to coal and iron and the conditions of Great Britain, but to the products and needs of other climes. In applied chemistry, too, beyond the praiseworthy attempt at the Herold's Institute (Bermondsey) to deal with leather dyeing and tanning, practically nothing in the nature of a school of chemical technology exists in the metropolis. London transcends every other city in the magnitude and variety of the local industries depending on one chemical process or another. Besides its large interest in every branch of the clothing trade, in all the materials for construction, and in such specialties as the use of india rubber, London is the greatest center for all the applications of photography and the various lithographic processes still most incompletely taught and studied. It is, moreover, the largest center of gas manufacture, and hence the most extensive producer of coal-tar. At

present the valuable by-products of London's gas works are for the most part only so far dealt with on the spot as to reduce the cost of their freight to other parts. Practically all the skilled and remunerative treatment of coal-tar products is left to Germany, to which country we export what is virtually the raw material of a most valuable trade, from sheer lack of scientific knowledge of how to make the most of it. Apparently we are contented with this state of things, seeing that London has to this day no center of instruction in gas manufacture and the treatment of its by-products; nor any provision for systematic research into their possible developments. Even the immemorial London industry of tanning is falling behind. Hides are positively beginning to be exported from England to New York to be tanned in the United States by new processes and sent back as leather to Leicester and Northampton. It is probable that few, if any, investments would, in the largest sense, pay better than the establishment—possibly in east or south London—of a great school of chemical technology; and, if we turn from physics and chemistry to biology, we must notice that, whilst the Institute of Preventive Medicine studies bacteriology from the pathological standpoint, London has as yet no provision for instruction and research in its industrial side. One of the largest and most profitable of London industries depends on the bacteriological process of fermentation. The whole future of London's food supply—to say nothing of its sewage disposal—is involved in the same question; and refrigeration, to name only one out of many applications, is already the nucleus of a great industry. The most economical means of lowering temperature on a large scale, under commercial conditions, has become literally a matter of life or death in certain industries. This knowledge can hardly be 'picked up' at the works or in the office.

Yet there is no institution teaching it. We need to expand our few and scanty classes in zoology and physiology into an organized school of instruction and research into all the biological processes that are or can be applied to industry. We pass to another range of science in mathematics and astronomy; but it is one in which London has a special interest. It seems almost incredible that in the greatest port of the world, providing its own large quota to our mercantile marine, absolutely no public provision exists for instruction in the art of navigation, or in the application of mathematics and astronomy on which the art depends. There is urgent need for the establishment, in connection with the University, preferably in East London, of a school of nautical astronomy and navigation, including the applications of magnetism and meteorology to the sailor's art.

The Science Faculty seems thus to require:

1. Increase in staff of professors and instructors at existing centers—say, £15,000 a year (£500,000).

2. Extensions at existing centers in buildings and equipment to accommodate additional students—say, £80,000.

3. New centers—building, equipment, and endowment of science departments at, say, three at £40,000 (£120,000).

4. New subjects—provision for buildings, equipment, and endowment of centers for electro-chemistry (£100,000), mining and metallurgy (£100,000), technological chemistry (£100,000), bacteriology and biology in its industrial relations (£100,000), nautical astronomy and navigation (£100,000), etc.—total for science, £1,200,000.

#### SCIENTIFIC BOOKS.

*Lehrbuch der vergleichenden mikroskopischen Anatomie der Wirbelthiere.* By DR. ALBERT OPPEL. Dritter Theil. Mundhöhle, Bauschspeicheldrüse und Leber. Jena, Fischer. 1900.

With this volume is completed the discussion of the digestive system. Volume I. comprised the stomach and included 543 pages; Volume II., the esophagus and intestine, in 682 pages. The present volume consists of 1180 pages, with XI. plates and 679 figures in the text, therefore exceeding considerably the preceding volumes in size in accordance with the greater complexity of the parts considered.

The work follows closely the plan of the preceding volumes. Each subdivision is discussed in historical sequence, the statements of the author being included between oblique lines, // . In accordance with the plan, the greatest pains have been taken to show the present state of knowledge of the structure of each part in the different forms, and to this end the search in the literature has been made exhaustive, and references to all papers, however trivial, have been sought out. No prejudice has influenced the writer in favor of continental investigators to the exclusion of others; indeed, the recognition of American work seems to be greater than that accorded by many American writers. The quotation of each author is followed by his name and the year of publication. The complete title is given in a bibliography in the end of the volume.

Where there are differences of interpretation (as, *e.g.*, as to the nature of the demiluees in the mucous salivary glands), the different theories are propounded, weighed and (where possible) some choice is indicated.

The text is followed by a table of animal forms, giving a key to the position of the species considered in the text and an arrangement of their families in systematic order. This is followed by the bibliography of 50 pages, and finally, author and subject indices.

In the body of the work the oral cavity with its adnexa, pancreas and liver are taken up successively. In connection with the oral cavity are discussed: the structure of the mucous membrane in the different classes; the pharynx of mammals; the lymphoid tissue of the oral cavity; the tongue; nerves and sense-organs; and finally, the oral (salivary) glands. The teeth, which on many accounts might seem to be properly included, are omitted to be discussed with the skeletal system in a subsequent volume.

In each of the subdivisions the subject is taken up systematically and in detail. For example: the lymphoid tissue in the oral cavity is discussed (1) as to its significance, (2) the migration of the leucocytes through the epithelium, (3) the structure of the lymphatic nodules, (4) the tonsils (lingual, palatine and pharyngeal), and finally (5) the development of the tonsils. In summarizing the subdivision dealing with the tongue, Oppel arrives at the conclusion that the mammalian tongue is to be derived from the entire tongue of the lower vertebrates and not merely from the back portion of it (as Gegenbaur believed).

Especially in the case of the oral (salivary) glands has there been felt the need of a summarization of knowledge, and Oppel has furnished it admirably. The classification of the mammalian oral glands, their occurrence and structure in the different animals, have been made the subject of varied interpretations—Lavdowsky's, Klein's, Nadler's, Stöhr's and Ranvier's are given.

The interpretation of the demilunes of Giannuzzi of the mucous glands receives full discussion. The three views of the substitution theory, phase theory and special function theory are each presented and criticised. Oppel rejects the first two and considers the third as the one to be accepted in the light of recent work (Krause, Solger, Müller, *et al.*).

The pancreas seems to be of universal occurrence in the vertebrates; wherever it has been sought for it has been found. Comparison with the salivary glands to see whether it can be regarded as an 'abdominal salivary gland' (the German name) shows that there are certain specific structural differences that distinguish it.

The pancreas is discussed from the point of view of the finer structure of the gland cells, including a consideration of the so-called paraneucleus, the activity of the cells, the form of the tubules, centro-acinar cells, the terminal ducts and the structure of the pancreatic ducts in the classes of vertebrates, the connective tissue of the gland. The interesting areas of Langerhans are next discussed, and in regard to their occurrence and significance, Oppel says that they have been demonstrated in most vertebrates (doubtfully in the *Selachia*). He

regards them as permanent structures and not transitory (as developing acini) and considers them of epithelial (entodermal) origin. On the other hand, whether or not they elaborate an internal secretion, he dares not decide, but should this be found to be the case, it does not, he thinks, militate against the view that they were originally part of the gland proper giving (possibly) a clue to the structure of the primitive gland. Blood vessels and nerves are considered next. The question of the occurrence of an accessory pancreas is then discussed. The development of the pancreas in the various vertebrate forms closes the chapter and is supplemented by a helpful table showing and comparing the mode of development in the different vertebrates as ascertained by the different workers.

In dealing with the various structures no attempt is made to discuss the gross anatomy as beyond the scope of the work, save in so far as necessary, though often—as in the case of the liver—references are given to the sources whence such information may be gained. It is likewise in accordance with the plan of the work to present the discussion in historical sequence, so that the liver is considered from the standpoint of (a) the liver lobule, and (b) the liver cell and gall capillaries, despite the fact that liver lobules are peculiar to mammals.

In the consideration of the remaining structural features of the liver, bile-duct and gall bladder are taken up, followed by a discussion of the liver in the different vertebrates. The development of the organ constitutes the closing division. Few original observations or generalizations are made in this portion of the work.

The comparison of the liver with other typical glands receives considerable attention, together with the question of the anastomosis of the gall-capillaries, and the conclusion is reached that a net-like arrangement of the gall capillaries occurs in the lower vertebrates, and in the higher forms at least in early development. Under the subdivision dealing with the functional activity of liver cells, the glycogen, pigment and fat content are discussed. Most investigators agree that there are two kinds of

liver cells, but there is no answer to the meaning of the differences.

The work as a whole is a valuable treasure-house of knowledge that will save both investigator and student much time and labor. The author does not state which system will form the subject of the next volume, nor when we may expect it to appear. At the same rapid rate of work it will be due in 1902, and we feel sure that the same excellence will be maintained.

B. F. KINGSBURY.

#### RIVER PROFILES.

AN interesting and valuable publication of the Department of Hydrography of the U. S. Geological Survey on the profiles of rivers in the United States, by Henry Gannett, has just been published and is now available for distribution. It embodies within a hundred pages the leading facts of about one hundred and fifty of the most important rivers and streams of the country, noting their length, drainage area, the location of water power in their courses, their peculiarities of flow and the nature of their drainage basins.

The rivers selected are those which are the largest in size and bear most directly upon the varied interests of the country such as the Connecticut, Hudson, Susquehanna, Ohio, Potomac, Mississippi, Missouri, Platte, Colorado, Sacramento, Columbia and others. The figures for the table showing the height above sea-level and fall per mile were collected from various sources. Some were obtained from the report of the chief engineer of the U. S. Army, some from railroad companies when their lines cross the streams and some from the atlas sheets of the U. S. Geological Survey. In the case of such rivers as the Connecticut, Susquehanna, Mississippi and Colorado, where the surrounding country is in part or whole of peculiar physiographic interest, very excellent and vivid descriptions of its leading physical characteristics are given, which add to the interest, and render it valuable from an educational standpoint in geographic and physiographic instruction. The pamphlet is the result of much careful work and is the first attempt to collect and compile this information in its present form.

#### SOCIETIES AND ACADEMIES.

ZOOLOGICAL CLUB, UNIVERSITY OF CHICAGO.  
WINTER QUARTER, 1901.

#### I.

THE first meeting of the quarter on Jan. 9 was devoted to a paper by Professor F. R. Lillie, entitled 'A Comparison of the Power of Regeneration in Three Genera of Planarians, viz., *Planaria*, *Phagocata* and *Dendrocoelum*.' The following is an abstract of the paper:

"The greater part of the large volume of recent work on regeneration of planarians has been carried out on a single genus, *Planaria*. Attention should be called to the importance of the comparative method in studies of this kind. This may be illustrated by some results of observations on two other genera, *Phagocata* and *Dendrocoelum*. These three genera are found living together in a single pond in Falmouth, Mass. *Planaria* is especially abundant in this pond, in some parts of which as many as twenty or thirty individuals may be found on the under surface of a single large stone. Scattered about among these individuals one finds usually from one-half to one-third this number of individuals of *Phagocata* and two or three specimens of *Dendrocoelum*. *Planaria* is thus much more abundant than *Phagocata* and the latter than *Dendrocoelum*. The last is more abundant relatively in portions of the pond where there is a large amount of vegetation growing on the bottom. The habits of life of the three genera in question are, however, very similar.

"*Phagocata* was found to resemble *Planaria* very closely both in the modes of, and capacity for, regeneration. *Dendrocoelum*, however, offers the greatest contrast to both *Planaria* and *Phagocata*. The first experiment was to cut a single specimen in half through the pharynx. The cut surfaces healed and the farther fate of the parts was as follows: The posterior part formed no new tissues, although it lived for some days; from the anterior part, on the other hand, there grew out a pointed piece, which acquired the characters of a tail. Two weeks after the operation this piece also died without any extensive remodeling of the whole having taken place. I afterwards repeated the ex-

periment several times with a similar result. Thinking that the failure to regenerate a head might be due to the presence of the pharyngeal pouch, I then cut fourteen specimens transversely behind the pharynx. Two days after the operation an interesting difference in the reactions of the anterior and posterior parts was noticeable. While the former reacted in all respects like normal individuals, the latter showed no definite reactions of any sort but remained scattered over the bottom, some with the ventral surface up. In six days all the posterior pieces were dead without having shown any signs of regeneration, while all the anterior pieces, kept in the same dish, were living and regenerating new tails. This experiment was afterwards repeated with similar results, and I soon became convinced that, in this form, while a tail might regenerate at any place from the pharynx back, a new head could not be formed in this region of the body.

"The question was now, could a new head be regenerated in front of the pharynx? So specimens were cut in two immediately in front of the pharynx. The result of these experiments was that, while a very narrow border of new tissue might be formed at the cut border of the posterior piece, there was never any regeneration of even the semblance of a head. The anterior pieces, on the other hand, regenerated a new tail as before, and also a new pharynx.

"In the next experiment the heads of five individuals were removed by a transverse cut just behind the eyes. The heads did not regenerate, but in five days it was apparent that the decapitated pieces were regenerating new heads; in one piece the eyes could already be seen. On the next day eyes had appeared in all. The capacity for regeneration of a head was thus demonstrated.

"Two questions now remained: Was the regeneration of a new head due to the size of the piece, or to the position of the cut? and how far back does the capacity for regeneration of a head extend? The first question received a very simple answer; the head was first cut off just back of the eyes, and then from the anterior end of the major piece a small transverse

piece was cut. In six days a rudimentary head with eyes developed on the front end of the small piece in one of three specimens.

"How far back does the capacity for regeneration of a head extend? We have seen that it cannot be formed from tissue just in front of the pharynx, but that it can be formed just back of the eyes. Twelve specimens were cut transversely about half way between the front end of the pharynx and the anterior end of the body. The reactions of both parts were perfectly normal, though the headless parts reacted much less rapidly than the parts with heads. In seven days both parts were rapidly regenerating and eyes had appeared in the headless parts; in the head-bearing parts the new pharynx was regenerating in the new tail. Both kinds of parts then completed the regeneration rapidly, though even after nineteen days the normal proportions were not restored.

"Thus in *Dendrocelum* new tissue may grow out in the form of a tail at any transverse level of the body, excepting only the most anterior part to a very short distance back of the eyes; the capacity for regeneration of a head, however, is limited to the anterior third or fourth of the body. I do not mean to assert that the formation of a new head back of this level is completely impossible. Some one may at any time demonstrate, by taking suitable precautions, that a new head may be formed back of this level. But it is shown very clearly by these experiments that the power of regenerating a new head is largely, if not entirely, confined to the prepharyngeal part of the body in *Dendrocelum*, and that it is always greater at any more anterior transverse level.

"Thus it is demonstrated that in *Dendrocelum*: (1) The power of regenerating a head is limited to a small part of the body. (2) That a new tail may be generated at any transverse level. (3) That the capacity for remolding degenerating parts into normal proportions is very limited. (Limitation of 'morpholaxis,' Morgan.) (4) That there is a relation between the power of regeneration in this form and the power of performing the usual coordinated movements, the latter power always being slight in parts incapable of regeneration. This

last fact leads me to think that the nervous system plays an important part in regeneration of planarians. A paper, soon to appear, will deal more fully with these facts and the interpretation of them."

At the second session of the Club, held on January 23, Miss Elizabeth Meek gave the results of a statistical study of variation in the mandibles of the stony-beetle. An abstract of this paper has already appeared in Vol. XIII. of SCIENCE.

C. M. CHILD,

Secretary.

#### TORREY BOTANICAL CLUB.

At the meeting of the Club on May 14, 1901, the scientific program was as follows: Professor Underwood spoke on 'The Genus *Pteridium*,' the type of which is the widely distributed and well known *Pteris aquilina* of Linnaeus. It was separated from the genus *Pteris* by Gleditsch in 1751, followed by Scopoli in 1760. The principal generic character as distinguished from *Pteris* is the presence of a double indusium. Specimens of various species, varieties, and forms were shown, including extremely large specimens of *Pteridium aquilinum* collected by the speaker in southern France. Three species may be recognized in North America. The first of these is the common and variable *Pteridium aquilinum*, of which the recently described variety *pseudocaudatum* Clute is more or less common from New Jersey southward. The second species is *Pt. caudatum*, found in the extreme tropical of Florida. The third, which occurs in the West Indies, seems to be identical with a species originally described from Brazil, though it has been confused with a species from the Society Islands. Species from South Africa, India, and the Hawaiian Islands were also mentioned.

Dr. D. T. MacDougal gave an account of 'Carpotropic Movements of Flowers,' taking his illustrations from plants in bloom at the time. The two classes of movements of flowers are the induced or protective and the developmental or automatic. Of the former, the wild carrot furnishes a good example, its umbels being erect during the day and pendent or inverted at night. The segments of the perianth

of the tulip also furnish a good illustration of movements induced by changing conditions of temperature.

Developmental movements, *i. e.*, those due to forces which originate within the plant, are well shown in the inflorescence of *Allium Neapolitanum*. The inflorescence here is nodding when in the bud, but the development of the flowers sends a stimulus to the curved portion of the peduncle, causing it to straighten. In addition, the plant is provided against accident by the fact that each pedicel has the power of independent movement. Each pedicel will bend so as to erect the flower if the peduncle is prevented from straightening. Under normal conditions the pedicels take positions separating the flowers equally. In *Claytonia Virginica* the buds are nodding, the flowers erect. After fertilization, there is another curvature, more abrupt and nearer the base of the pedicel. In *Streptocarpus*, the flower-stalk is curved and somewhat coiled in the bud, while the open flower is horizontal, bending the stalk at a right angle, and after fertilization the maturing fruit becomes erect. The movements of the fruit, in many cases at least, are for the better dissemination of the seeds, and the movements of the flower are commonly connected with methods of fertilization. Dr. MacDougal referred also to the curious development of the cotyledons in *Streptocarpus*. One of the cotyledons ceases to grow after a time, while the other elongates very much. In one species, this cotyledon remains the only foliage of the plant.

Dr. N. L. Britton gave an account of 'An Undescribed Species of *Stachys*.' He remarked that many North American species were until a few years ago referred to the *Stachys palustris* of Europe, but have more recently been recognized as distinct. A plant which grows on the sand hills along the beach near New Dorp, Staten Island, is really very different from the European *S. palustris*, and may safely be considered a new species. It has been collected in Michigan by Mr. Farwell and a specimen from Illinois is in the Chapman Herbarium. The species is apparently confined to sandy shores.

M. A. HOWE,

Secretary pro tem.



THE MINNESOTA ACADEMY OF NATURAL  
SCIENCES.

THE April meeting of the Academy, which proved to be a very interesting one, was addressed by Mr. F. K. Butters, who spoke on the 'Fungus Flora of Minnesota.' The more fundamental relationships of the fungi were illustrated by slides, taken from Engler and Prantl's 'Pflanzenfamilien,' and also by original microphotographs of common minute Phycomycetes and Ascomycetes, as well as by a large number of photographs of the fleshy fungi of the locality, taken in the field to show their natural conditions of growth.

The speaker pointed out that the fungi are to be considered as one of the most successful groups of the plants, showed by their diversity of form, the great variety of conditions under which they will grow and their numerical importance. In Minnesota the number of species is probably in excess of the flowering plants. The diverse conditions under which fungi will grow, *e. g.*, in water, upon living plants and animals, on decaying organic substances, in humus and in sand containing a minimum amount of organic matter was illustrated. Attention was called to the fact that on account of the great number of spores produced wherever there is suitable environment there also will be numbers of plants. The diverse forms of fungi are modifications of a few types to be regarded as distinct phylla and parallel lines of development sometimes exist in different groups.

The lecture was productive of a very general discussion of local fungi and was greatly enjoyed by the large audience present.

F. G. WARVELLE.

DISCUSSION AND CORRESPONDENCE.

GEOLOGY OF CHINA.

TO THE EDITOR OF SCIENCE: In the discussion in the last number of SCIENCE of my article in *McClure's Magazine*, there are some things which deserve attention in order to get the facts fairly before the public.

1. It is proper for me to state that the title of the paper and the headlines were put in by the editors; so that I was in no sense responsible

for them. I think that in the article itself there are no offensive claims to original discovery.

2. The quotation from Geikie's 'Great Ice Age' (p. 699) is unfortunate for my critic, since it was that very quotation which misled me during a considerable portion of my trip. In this quotation Geikie says, "Its materials [those of the loess], we may believe, are largely of *fluvio-glacial* origin, and represent in great measure the flood-loams swept down from the mountains and plateaux when these supported extensive snow-fields and glaciers. But, as Baron Richthofen in his great book on China has demonstrated, the loess, as we now see it, owes its structure and heaping up to the action of the wind, and is even now forming and accumulating in many regions of Asia. It is, in short, a true steppe-formation." On page 697 Geikie had said, "According to Przewalski, undoubted traces of former glaciation are seen in the Suma-Hada range, west of Kalgan in China." My first point was to visit this mountainous region west of Kalgan supposed both by the Russian and by Geikie to be the source of the loess in Eastern China. But we found no indications of glaciation in that region, and pursued our investigations sufficiently to convince us that there were none; so that Geikie's theory of the 'fluvio-glacial origin' of the loess falls to the ground in that region. That came pretty near being a discovery.

3. On the same page Geikie says, "Kropotkin's researches have led him to conclude that the whole of the upper plateau of Asia and its border-ridges were under a mighty ice-cap." Assuming the truth of these statements, Geikie says upon the next page, "The mountain-valleys everywhere contain wide and thick sheets of rounded blocks, and coarse and fine gravel, which are in every respect comparable to the fluvio-glacial gravels of the Alps. But in none of the descriptions of these which I have read is there any clear indication as to whether the deposits occur in successive terraces like the high- and low-level terrace gravels of the Alpine lands of Europe. Something like this arrangement seems to be present in the valleys of the Thian Shan, and may possibly refer to recurrent phases of glaciation." In accordance

with this view, the glacial map of Asia which precedes the chapter is covered with extensive glaciated areas over the regions which I have specifically visited. All of which shows the confusion of mind which has widely prevailed up to the present time concerning the glacial conditions of Southern Siberia and Central Asia, and goes to justify the editor in naming my article.

4. I am not aware that Kropotkin had any personal knowledge of the southeastern border of West Turkestan. But it is significant that Geikie, on his authority, speaks of 'immense sheets and terraces of loess' fringing the base of its mountainous border. The writer in SCIENCE assumes, as I believe unwarrantably, that the only indication of a former sea-level is the occurrence of sea shells. On the contrary, in the broader studies of physical geography that are now current, sea-levels may be determined in many places by terraces where shells are not present.

5. With reference to the occurrence of the bones of land animals and of terrestrial mollusks in the loess, I need only to say, that the great uncertainty concerning the situation of these remains with reference to the original deposit largely, if it does not entirely, breaks the force of the argument which is drawn from it. No one will deny that the wind has in many instances redeposited vast amounts of loess, nor that subsequent streams have done the same. But to go no farther than our own country, it is difficult for any one who is familiar with the situation of the loess over Northern Missouri, for instance, or in the center of the Mississippi Valley at Vicksburg, to believe that it has been deposited either by the wind or by flowing streams of water when the land stood at its present level.

In due time I hope to bring the facts in fuller detail before the public. But this much I may confidently say, that the whole problem of the loess has not yet been fully comprehended, much less has it been solved. If the renewed discussion elicited by my report shall contribute to an understanding of the subject, a great point will be gained. But I am sure that the as yet little understood facts of Central Asia will contribute much toward a solution of what

has been one of the most perplexing of all the geological problems.

G. FREDERICK WRIGHT.

'THE LARYNX AS AN INSTRUMENT OF MUSIC.'

TO THE EDITOR OF SCIENCE: Noting in your issue of May 24, a communication from Arthur Gordon Webster quoting Professor Le Conte's reference to the larynx, comparing it in its function to a horn and citing a passage from Helmholtz containing the same comparison, I am tempted to refer your readers to a much earlier example of the same conception. I quote the following from some notes of mine: "In 1700 Dodart ('Memoire sur les causes de la voix de l'homme,' par M. Dodart, *Memoire de l'Academie des Sciences*, 1700, p. 238) insisted that the trachea only furnishes the material of the voice, *i. e.*, the expired air. The glottis is the only organ of the voice. All the effects of the glottis for tones depend on the tension of its lips, and of its various internal structures. The concavity of the mouth has no part in the production of the voice, but it is a modifier of it, and still more is this true of the nose. He showed that Galen's comparison to a flute could not be accepted if one were to go into details. He spoke of the vibration of the ligaments, of the dilatations and contractions of the glottis. He asserted that the trachea is elongated in high notes and shortened in low ones. He likened the vocal organ rather to a horn or trumpet. According to him the glottis is the place which corresponds to the lips of the musician; the body of the instrument extends from the glottis to the external orifice of the vocal canal, that is to say the mouth."

JONATHAN WRIGHT.

#### SHORTER ARTICLES.

##### PREDETERMINED ROOT-HAIR CELLS IN AZOLLA AND OTHER PLANTS.

ORDINARY root-hairs arise in acropetal succession in the zone where the surface tissue is becoming fixed; that is to say, in a region at some distance from the root apex, where the cells have ceased to divide and have reached, or are reaching, full elongation. They come from any or all of the superficial cells indif-

ferently. "Only in *Lycopodium*," says De Bary (*Comparative Anatomy*, p. 60), "can special hair-cells be distinguished from the other epidermal cells of the root."

Special hair-cells are, however, to be found in a considerable range of plants, in which they form a rather striking anatomical character of the epibema. In all the cases which I have studied, root-hairs arise from cells differentiated for the purpose at a very early stage of the epibema, and from no other cells. The hair-cells are short, often very short, sometimes wedge-shaped, possess peculiarly dense and deep-staining cell contents, and are distributed in a manner determined by the mode of origin. They originate from the division of cells near the root apex. Of each cell pair formed, one becomes a hair-cell and very shortly shows distinctive characters; while the other either becomes a single ordinary, much elongated surface cell, or divides to form several such (hairless) cells. In most cases the cutting off of hair-cells seems to be a matter of stimulus. At times the roots are wholly devoid of hairs and hair mother-cells; at other times the growing conditions—as it would seem—call out these structures.

I find such special hair-cells in *Azolla*, *Isoetes*, *Selaginella*, *Equisetum*, certain Alismales and certain Nymphaeaceæ.

In *Azolla pinnata* (the only species examined by me) the root shows several points of interest. The root-cap (as we may call the structure derived from the original segment cut from the outer face of the apical cell) consists of two cell layers, except at the apex, where the inner layer finally undergoes an extra periclinal division. The inner layer for a time coheres closely to the root-trunk, which is thus clothed with a true epidermis. At the same time the outer layer is separated from the inner except at the apex, and forms a distinct root-cap proper. The inner layer is finally pushed away from the root-trunk by the growth of hairs arising from the outer layer of the cortex, so that at maturity, and even before, the main body of the root is quite destitute of an epidermal covering.

The hairs arise in close proximity to the apex. Exterior cortical cells divide by a wall oblique

to the external surface. The lower of the two cells so formed in each case almost immediately gives rise to a hair, while the other divides transversely to form two, four or eight hairless cells. At first the hairs stand in regular zones, but ultimately these zones often become more or less broken by the unequal multiplication of the intervening cells in the different vertical rows.

In several species of *Nymphaea* examined the hair mother-cells or the hairs themselves were found as apparently constant characters of the epibema, alternating very regularly with ordinary cells. In *Nymphaea*, it will be recalled, the root is without epidermis (except root-cap), the epibema being merely the outermost layer of cortex, the Nymphaeaceæ in this respect agreeing with Monocotyledons and certain Pteridophytes. The hair-cells may develop in such a way as to give root-hairs, or they may be—under most conditions they commonly are—suppressed by the closing together, above them, of the ordinary elongated cells. Whenever hairs are found they proceed from short, specialized cells, early distinguishable not far from the growing point. An essentially similar condition is found in *Brasenia*, *Cabomba*, and *Nuphar*.

In some Alismales—*Sagittaria*, *Limnocharis*, *Aponogeton*—essentially the same phenomenon, the production of root-hairs solely from predetermined hair-cells, obtains. This is interesting in view of the recent discovery of the monocotyledonous character of one of the Nymphaeaceæ.

I purpose in the near future to describe at length these and other like cases of root-hair formation.

R. G. LEAVITT.

THE AMES BOTANICAL LABORATORY,  
NORTH EASTON, MASS.

#### QUOTATIONS.

SCIENCE AT A WESLEYAN UNIVERSITY.

THE dismissal of Professor Frank D. Tubbs from the chair of natural sciences in Wesleyan University, at Salina, Kansas, throws an interesting light upon the standards of orthodoxy in that State. Professor Tubbs is laboring under the grave charge of believing in evolu-

tion, a theory which the people described as 'the older and more orthodox Methodist ministers' so abominate that they will not even give Professor Tubbs a hearing. Apparently the general issue of academic freedom is not involved here, for the school professes to be a sectarian institution; that is, it subordinates the independent investigation of the truth to the propagation of certain doctrines. Professor Tubbs himself admits that his standing as a scientist, his success as a teacher and administrator, and his character as a man were not the only things considered in his appointment, for he says: "Bishop Vincent fully questioned my beliefs, approved them, and appointed me to the seminary." The only question is whether an evolutionist can be an orthodox Methodist in central Kansas. The trustees of the school say no. The decision may cause Professor Tubbs temporary inconvenience; but if belief in evolution is his only fault, he can comfort himself with the reflection that he is far better off than the 'university' at Salina.—The N. Y. *Evening Post*.

#### MR. CARNEGIE'S GIFT TO SCOTTISH UNIVERSITIES.

AT the time when Mr. Carnegie's gift was first announced, and when nothing had been made known except its magnitude and the fact that it was intended to defray the cost of University education for Scottish students, we felt it necessary to point out, while cordially expressing our admiration of the munificence of the donor, that the very magnitude of the fund would render its wise administration a matter of some difficulty, and to call attention to circumstances which might interfere with the practical realization of the intended benefits. The conditions of the trust, as now disclosed, appear to meet, in almost every particular, the considerations which we mentioned. The application of half the income for the purpose of improving the apparatus of education and for establishing what can hardly fail to become world-renowned laboratories in every department of science which falls within the province of a university will at once lift those of Scotland to the very highest level of academic importance, and will be likely to place the coun-

try in the very forefront of practical scientific teaching and investigation. Medical science is specially mentioned in the trust, and, to take only a single example, it will be within the power of the trustees to enable any Scottish University to equip an expedition for inquiring into the life histories of fever-carrying mosquitoes or other insects, and thus to accomplish, perhaps in the course of a few months, more than could be accomplished by private enterprise, aided only by small and laboriously collected donations, even in the course of years. The problems of organic chemistry, again, are daily becoming of more and more importance in relation to health and to disease; as are those of inorganic chemistry in relation to a large number of manufacturing processes or industries. In respect of these and many kindred matters the great hindrance to scientific work in Great Britain has been simply want of means; and this want once removed, a very important step will have been taken towards assisting us to hold our own in the great industrial contests which the future can hardly fail to have in store for us, and in which scientific knowledge will certainly be one of the most important elements of success. We cannot but think that this section of the trust is likely, as time goes on, to prove itself infinitely the more important of the two, and that in the future, under the elastic terms and liberal powers of the deed, it may even come to swallow up or supersede the general payment of fees which, after all, are not so large as to place a serious impediment in the way of any young man who is not absolutely destitute, and who is determined to push his way to the front of any calling in which it may be his purpose to engage.—The *London Times*.

#### CURRENT NOTES ON PHYSIOGRAPHY.

##### THE SOUTH COAST OF ENGLAND.

THE mid-southern coast of England is bordered by a narrow anticline of mesozoic strata, greatly eroded. The largest remnant of the anticline is the Isle of Wight, while further west a nearly isolated portion is called by the anticipatory name of the Isle of Purbeck. The physical features of the latter, with those of

the associated anticline of Weymouth, are treated in a chapter by Strahan ('The Geology of the Isle of Purbeck and Weymouth,' *Mem. Geol. Sur. England*, 1898, pp. 230-235). Next inland lies the unsymmetrical Hampshire synclinal basin of Tertiary strata, broadening eastward, and thus analogous to the London Tertiary basin. Each basin gave rise to an east-flowing axial consequent river, the lower Thames and the Frome; but while the valley of the Thames is still well preserved, the southern side of the original Frome valley has been greatly consumed by the sea. Lateral consequents of good size still come from the north, and one of them, the Stour, rises back of the chalk cuesta; but nearly all the consequents on the south have been shorn off; yet two small ones still remain, one on the Isle of Wight, one on the Isle of Purbeck, and each of these streams, like the Stour, heads back of the chalk, which on the south forms a monoclinical ridge of nearly vertical structure. Much of the original axial consequent has been destroyed; the river now called Frome being only the upper 30 miles of a stream that may originally have had a length of over 100 miles. The Solent estuary, separating the Isle of Wight from the mainland, is taken to be a middle part of the axial consequent, as described by Strahan in an earlier memoir (1896).

The Isle of Portland, south of Weymouth, is a smaller fragment of the devastated anticline, west of the other remnants. It is now connected with the mainland by the famous Chesil bank (*Ibid.*, pp. 203-209), a superb reef of pebbles and sand, 18 miles long, enclosing a shallow lagoon called the Fleet (from Saxon, meaning shallow water) for 12 miles. The exposed (southwest) face of the reef is a steep beach, beched with long, even terraces (locally called 'curbs'), the temporary records of the maxima in an irregular but generally decreasing series of wave efforts; the highest crest of the reef being the work of the master storm of the decade or century. The reef rests on clays which are sometimes exposed on the beach face after storms. Pebbles are abundantly thrown over the crest of the reef during on-shore winter gales; the windows of the nearest houses in Chiswell (where the reef joins the Isle of Port-

land) must then be boarded up, even though the crest is there 42 feet 9 inches above high-water mark. The reef as a whole must be marching slowly inland (northeast). It may have been formed originally several miles to seaward of its present position. The pebbles are largest at the southeastern end, where the reef is attached to the wasting and beachless cliffs of the Isle of Portland, and finest towards the northwest end, where it approaches but does not reach the Chalk uplands of Brixport; yet the commonest pebbles are not derived from the Portland sandstones, but consist of well-rounded chalk flints; and there are occasional Triassic pebbles, although no Triassic rocks are exposed for some 30 miles to the west. An earlier writer suggested that the movement of pebbles on the beach is from the northwest, and that the largest ones are now at the southeast end because they are most readily carried by storm waves and drift; but this is difficult to believe. Prestwich thought that the movement is to the northwest. Strahan seems to accept the earlier opinion, but concludes that the more persistent movement is only inward (northeast); and that the materials of the reef represent the most durable sweepings of the land area that has hereabouts been destroyed by the sea. Thus explained, it seems probable that the chalk flints and the Triassic pebbles were derived from exposures of these formations somewhere along the original position of the reef, a district now occupied by the northwestern part of the English channel.

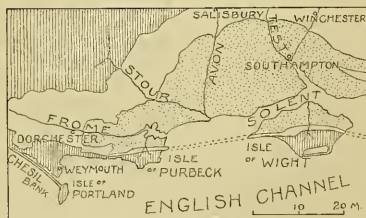

Part of southern England, representing the Hampshire syncline and fragments of the adjoining anticline. Chalk, blank; older formations, lined; Tertiary, dotted.

## THE ORIGIN OF FIORDS.

O. NORDENSKIÖLD contributes some 'Topographisch-geologische Studien in Fjordgebeiten' (*Bull. Geol. Inst. Univ. Upsala*, IV., 1899, pp. 157-226, 1 pl., 14 fig.), based on observations of fiords and on representations of their form by maps, soundings, etc. He finds normal or radial fiords (West Greenland, New Zealand), parallel fiords (Alaska, Patagonia), and combined forms (Norway). Fiords always occur in groups or systems. Their bottom is uneven, with deep basins and shallow swells. They are from 5 to 40 times longer than broad; they are enclosed by steep and high walls of strong rock. Their distribution shows that they stand in some relation to glaciers: glacial erosion of preglacial valleys best accounts for most features.

This inductive study furnishes many excellent descriptions of typical examples and a series of well-supported conclusions as to the prevalent features of fiords. In attempting explanation, the inductive method seems insufficient; a fuller consideration of what might be expected from long-lasting, vigorous glacial erosion is desirable; for unless the forms reasonably deduced from such a consideration match the observed forms, the theory of the glacial origin of fiords would be seriously at fault. It is perhaps because of the greater emphasis here given to the inductive than to the deductive part of the investigation that the discordant depths of confluent fiords are insufficiently explained, and that the important subject of hanging valleys, recently discussed by several observers, here receives no sufficient mention.

## VIEWS OF THE COLORADO CAÑON.

'GLIMPSES of the Grand Cañon of the Colorado,' is the title of a portfolio of 13 colored plates published by Thayer, of Denver, Colo. It may be 'a fact that under certain conditions the cañon presents the marvelous colorings herein reproduced,' but such conditions are altogether exceptional; and the actual colorings under ordinary conditions are so strong and fine that there is no warrant for a resort in all the views to the exaggerated effects of a rare sunset. Not only are the reds too vivid, but the greens are those of a pluvial, not of an arid

climate. The colored views of the cañon published by the Detroit Photographic Company from photographs by Jackson are on the whole to be preferred, not only from being more faithful and delicate but as well from being free from the distraction of more or less irrelevant poetical quotations with which the Thayer views are prefaced.

## KABA VOLCANO, SUMATRA.

AN entertaining account of the ascent of Kaba, a volcano in Sumatra, is given by Hagen ('Eine Besteigung des Vulkans Kaba auf Sumatra,' *Globus*, LXXIX., 1901, 245-250, 267-273). The illustrations from original photographs are remarkably well reproduced and exhibit the crater forms with unusual success. As in the 'curbs' or storm lines on a beach, so here, the existing craters represent the successive weakening maxima in irregular series of eruptions, all the minima being destroyed except the last.

W. M. DAVIS.

## CURRENT NOTES ON METEOROLOGY.

## WEATHER AND CROPS IN SAXONY.

AN elaborate investigation into the relation of weather conditions and crop yield in Saxony, based on data for the period 1864-1897, leads to rather unsatisfactory results (Grohmann: 'Die phänologischen Beobachtungen der Jahre 1864 bis 1897, und die Ernteerträge im Königreich Sachsen in ihrer Abhängigkeit von den Witterungsverhältnissen,' Chemnitz, 1901). The various districts of Saxony are divided into three groups, and the results for these groups show striking agreement in comparatively few cases only. On the whole, it appears that there is a larger yield of winter grain in warm and dry than in cold and wet years. An influence of weather conditions upon the yield of summer grain cannot be demonstrated in many districts, and the only fact which does come out clearly is that a greater amount of moisture is necessary in order to produce a large crop of summer grain than a large crop of winter grain. In some cases an influence of higher spring temperatures upon the summer crop is indicated. Potatoes succeed best in years with warm summers and normal

precipitation. The smallest crops of beets and cabbages are usually obtained in dry, warm years. The largest crops of clover and grass come in years with excessive precipitation and high temperatures.

#### RAINFALL AND FORESTS IN INDIA.

AN important publication on Indian forestry has recently been issued, in which certain conclusions as to the climatic influence of forests are set forth. The book is entitled 'Forestry in British India,' and is by Berthold Ribbentrop, late Inspector-General of Forests to the Government of India (Calcutta, 1900). From a recent review of this volume (*Nature*, April 18, pp. 597-601) it appears that while the author does not distinctly maintain that by afforestation the climate might be improved as far as to stop the recurrence of droughts, it is evident that he is rather inclined to that opinion. He does say that "in a warm climate the denudation of a country diminishes its moisture and consequently its fertility." The regulation of surface drainage by forests is clearly pointed out.

#### PERIODICITY OF SEVERE WINTERS IN ENGLAND.

IN the *Quarterly Journal of the Royal Meteorological Society* for April is a paper by A. E. Watson, entitled 'A Review of Past Severe Winters in England, with Deductions therefrom.' From an examination of the records of the severe winters of the last 300 years, the writer comes to the conclusion that such winters are most frequent in the years with the numbers 0-1 and 4-5. He is also of opinion that the severe winter in the middle of each decade is generally a late one (Jan.-Mar.), while that at the beginning or end of each decade is generally an early one (Nov.-Jan.).

#### NOTES.

IN 'Hints to Travelers, Scientific and General,' edited for the Council of the Royal Geographical Society by John Coles (8th edition, London, 1901), there is an article by Dr. H. R. Mill on 'Meteorology and Climate,' the object of which is to supply the traveler with instructions to enable him to make use of meteorological instruments, 'and to obtain evidences of the climate of the region which he

is passing through by noticing the effects produced on the land, vegetation, etc.'

MCADIE, of San Francisco, contributes a fourth paper on 'Fog Studies on Mount Tamalpais' to the March number of the *Monthly Weather Review*. In this he considers the refraction of sound waves by fog surfaces and the dissipation of fog. Two excellent half-tones accompany the paper.

BEGINNING with 1901 the Royal Observatory of Belgium will issue an *Annuaire météorologique*. Hitherto the *Annuaire* has been concerned with both astronomical and meteorological matters, but in the future the astronomical and meteorological divisions of the Observatory will have separate annual publications. The *Annuaire météorologique* for 1901 contains, among other matters, a sketch of the history of meteorology in Belgium and a review of two old meteorological journals, by J. Vincent; tables of monthly and annual means of the principal meteorological elements at Brussels and at Uccle, based at the former station on observations from 1833 to 1890, and at the latter from 1891 to 1899; and a paper on 'Le Climat de l'Ardenne,' by Lancaster.

R. DEC. WARD.

#### COLUMBIA UNIVERSITY BIOLOGICAL LECTURES.

FOR some years it has been the custom in Columbia University to have an annual course of public lectures on some biological topic. This year's series, recently completed, consisted of seven lectures on the Protozoa by Dr. Gary N. Calkins, of Columbia University.

The Protozoa, on account of their unicellular character, are of great importance in relation to many questions of general biology and especially physiology. The seven lectures by Dr. Calkins treated not merely the structure of the Protozoa, but their physiology, relations to more complex forms and the economic importance of certain types. The first lecture was a general sketch of the various discoveries which have gradually led to the recognition of the true relationship of Protozoa to Metazoa. This was followed by lectures on the four main types of Protozoa, in which physiology and

ecology of each were discussed as well as the morphology. The lecture on Sporozoa, which included a résumé of the life history of the malaria germ and other disease-producing Protozoa, was of unusual popular interest. In the sixth lecture Dr. Calkins discussed the renewal of vitality through conjugation, and the relation of conjugation to sexual reproduction of the Metazoa. The last lecture was devoted to a study of the Protozoan as a physiological machine, and was based largely upon the experimental work of recent years which has thrown so much light on the so-called 'vital' phenomena.

A point worthy of mention in connection with Dr. Calkins's lectures, since it contributed not a little to the value of the series, was the mode of illustration. For this purpose the stereopticon with microscope attachment was used, and photographic lantern slides, stained preparations and living Protozoa were thrown on the screen. Living Protozoa have often been thus projected, but in this case the highly perfected apparatus used rendered possible their projection on an unusual scale. *Amœba proteus*, for example, appeared five feet long, *Paramecium aurelia* nearly four feet, so that many structures, nuclei, contractile vacuoles, etc., became plainly visible to a large audience. The stereopticon method proved especially valuable in demonstrating to large audiences the various 'tropisms' the positive and negative reactions, of certain Protozoa to chemical, electrical and other stimuli. By means of a specially devised electrical apparatus the lecturer was enabled to focus the projecting microscope from the lecture table.

Though the subject was a very special one, the mode of presentation and illustration was such as to render it highly interesting to the non-specialist, as was clearly shown by the large attendance at all the lectures.

J. H. MCG.

THE BRITISH NATIONAL PHYSICAL LABORATORY.

THE Friday evening discourse at the Royal Institution, on May 24 was devoted to an account of the aims of the National Physical

Laboratory, by Mr. R. T. Glazebrook, its principal. According to the London *Times*, Mr. Glazebrook remarked that the idea of a physical laboratory, in which problems bearing at once on science and industry might be solved, was comparatively new; perhaps the first was the Physikalisch-Technische Reichsanstalt, founded in Berlin by the joint labors of Werner von Siemens and von Helmholtz, during the years 1853-87. It was less than ten years ago that Dr. Lodge outlined the scheme of work for such an institution in England, and in 1895 the late Sir Douglas Galton called attention to the question. A petition to Lord Salisbury followed, and as a consequence a Treasury Committee with Lord Rayleigh in the chair was appointed to consider the desirability of establishing a national physical laboratory. This committee examined over 30 witnesses and then reported unanimously, 'That a public institution should be founded for standardizing and verifying instruments, for testing materials and for the determination of physical constants.' It was now realized at any rate by the more enlightened of our leaders of industry that science could help them. This fact, however, had been grasped by too few in England, though our rivals in Germany and America knew it well; and the first aim of the laboratory was to bring its truth home to all, to assist in promoting a union which was certainly necessary if England was to maintain her supremacy in trade and manufacture, to make the forces of science available for the nation, to break down by every possible means the barrier between theory and practice, and to point out plainly the plan which must be followed unless we were prepared to see our rivals take our place. The effect of the close connection between science and industry on German trade might be illustrated, if illustration were wanted, by the history of the aniline dye manufacture and artificial indigo, and by the German scientific apparatus industry, the growth of which had been expressly attributed to the influence of the Reichsanstalt. Mr. Glazebrook proceeded to describe the means at disposal for realizing the aims of the laboratory. It was to be located at Bushey-house, Teddington, Kew Observatory remaining as the



observatory department. Bushey-house, in spite of its aristocratic history, would make an admirable laboratory. The building was very solid and substantial, and there was a good basement under the main central block with a roof of brick groining which afforded a very steady support for the floors above. The lecturer illustrated its plan with a number of slides, and compared it with the Reichsanstalt, which had an available space seven or eight times greater. But size alone was not an un-mixed advantage, and personally he would prefer to begin in a small way if only he was in a position to do the work thoroughly. But there was a danger of starvation. Even with all the help the committee got in freedom from rent and taxes, outside repairs, and maintenance, the sum at its disposal was too small; £14,000 would not build and equip the laboratory, and £4,000 a year would not maintain it as it ought to be maintained. In America the Bill for the establishment of a laboratory which had just been passed authorized an outlay of £60,000 on buildings and site and an annual expenditure of £9,000. Was there no one who, realizing the importance of the alliance between science and industry, would come forward with more ample funds to start the laboratory with a fair prospect of success? Was there no statesman who could grasp the position and see that with double the income the chances of doing a great work would increase a hundred-fold? Give the institution means to employ the best men and it would answer the difficult problems it had to solve; starve it, and then quote its failure showing the usefulness of science applied to industry. In the concluding part of his lecture Mr. Glazebrook gave an account first of some problems of industry which had already been solved by the application of science, *e. g.*, glass for optical purposes, and then of some others which still remained unsolved and which the laboratory hoped to attack, *e. g.*, alloys, wind-pressure on bridges and similar structures, the exact determination of the relations between the scales of the mercury, hydrogen, and electrical resistance thermometers, and the magnetic testing of specimens of iron and steel, besides the standardization and calibration of various scientific instruments.

## SCIENTIFIC NOTES AND NEWS.

AT the convocation exercises of the University of Chicago last week, a departure was made, in celebration of the tenth anniversary of the University, from the usual custom of not conferring honorary degrees. The LL.D. degree was conferred on ten men of eminence, including in the sciences, J. H. van't Hoff, professor of physical chemistry in the University of Berlin; Dr. A. Kovalevski, professor of zoology in the University of St. Petersburg; Dr. E. C. Pickering, director of the Harvard College Observatory; Dr. Charles D. Walcott, director of the U. S. Geological Survey, and Dr. E. B. Wilson, professor of zoology in Columbia University.

PROFESSOR A. S. PACKARD, who has held since 1878 the chair of zoology and geology at Brown University, has been elected a foreign member of the Linnean Society of London. The other American members of the society are: Alexander Agassiz, emeritus director of the Museum of Comparative Zoology, Harvard University; W. G. Farlow, professor of cryptogamic botany, Harvard University; D. H. Campbell, professor of botany, Stanford University, and C. O. Whitman, professor of zoology, University of Chicago.

AT its recent commencement Cornell College, Iowa, conferred the degree of LL.D. upon Mr. W. J. McGee, ethnologist in charge of the Bureau of American Ethnology, Washington. Dr. McGee is of Iowa birth and education, and one of his most important works, a classic in glacial geology, is 'The Pleistocene History of Northeastern Iowa.' The honor thus comes with special propriety from an Iowa school.

M. BERTHELOT (Paris) was elected an honorary member of the Vienna Academy of Sciences on June 1, and the following corresponding members were at the same time elected: Professors Schlegel (Leyden), Oppert (Paris), Linde (Munich), Retzius (Stockholm) and Kovalevski (St. Petersburg).

AT the recent meeting of the Royal Society of Canada, Professor A. B. Macallum, of the University of Toronto, and Mr. Lawrence M. Lamb, of the Geological Survey of Canada,

were elected fellows of Section IV. (Biological and Geological Division).

SIR ROBERT STAWELL BALL, Lowidean professor of astronomy at Cambridge University, will present an address from the University at the bicentennial of Yale University.

DR. HENRY S. PRITCHETT, president of the Massachusetts Institute of Technology, has been invited to serve as superintendent of awards at the Pan-American Exposition.

PROFESSORS CHARLES O. TOWNSEND and H. P. Gould have resigned from the Maryland Agricultural College, to accept positions in the Bureau of Plant Industry, Department of Agriculture.

PROFESSOR E. F. EMERY has been appointed special agent of the Bureau of Animal Industry to study the dairy interests in China, Japan and the Philippines.

DR. P. A. RYDBERG, assistant curator at the New York Botanical Gardens, has been given a short leave of absence for a trip in Europe. He will visit the herbaria at Kew, British Museum, Christiania and elsewhere for the purpose of completing some critical studies of the genera in which he is interested, and of arranging for exchanges.

DR. E. S. RIGGS, of the Field Columbian Museum, is now engaged in exploring the fossil beds of Wyoming.

WE regret to learn that Professor B. O. Peirce, professor of mathematics and natural philosophy at Harvard University, is still suffering from ill-health, and will probably be unable to resume his university work next year.

DR. N. S. SHALER, professor of geology at Harvard University and dean of the Lawrence Scientific School, gave the annual address at the commencement exercises of the Worcester Polytechnic Institute.

THE Pharmaceutical Society of Great Britain has presented its gold medal to Dr. George Watt, reporter on economic products for the Government of India.

THE New York State Pharmaceutical Association has passed a resolution favoring the building of a State laboratory of pharmacy in

memory of William Proctor, formerly professor in the Philadelphia College of Pharmacy.

A TABLET in memory of Dr. Jesse William Lazear, who lost his life in the study of yellow fever in Cuba, was unveiled at Trinity Hall Military School, Washington, Pa., at its commencement exercises last week.

THE Paris correspondent of the London *Times* telegraphs as follows: I have to announce with profound regret the death of one of the most eminent professors of the University of Nancy, M. Bleicher, who has been for six months at the head of the school of pharmacy in that city, after 20 years' service as professor of natural history at the same school. He was murdered by M. Raymond Four, a chemist, a sample of whose cinchona had been seized for analysis at the school, and who, dreading the results of prosecution for fraud, decided to hold the director of the school responsible for his humiliation and mischance. He called yesterday upon M. Bleicher and after a long interview shot him dead and then committed suicide. This monstrous crime has deprived France of one of the scholars who have done most to reveal to the world the geological interest of the frontier provinces of France. M. Bleicher's 'Les Vosges, Le Sol et ses habitants' is a classical treatise which every traveller in Alsace-Lorraine should always carry with him. Every year Professor Bleicher spent his holidays on one or other of the slopes of the Vosges studying the stratifications, the rocks, the glacial marks, all the features, in a word, of this interesting region, upon which he had published a large number of memoirs. He had begun life as Médecin-Major in the French-African army, but left his work there in 1877 to become professor at Nancy, where he was very popular, often conducting students' scientific expeditions. No one so learned was ever more unassuming.

WE regret to record the death of T. C. Clarke, which occurred in New York on June 15. Born in 1827, he graduated from Harvard University in 1848, and has been one of the most eminent American engineers, having designed and constructed many American bridges. He had been president of the American Society of

Civil Engineers and had received the Telford Medal of the London Institute of Civil Engineers.

THE death is announced of Mr. William Walton, formerly lecturer in mathematics in Cambridge University and the author of various text-books, at the age of seventy-seven years.

THE first award of the Mackinnon Research Studentship will be made by the Royal Society soon after the first of July. The value of the studentship is £150, and it will this year be awarded in one of the biological sciences.

THE position of aid in the Coast and Geodetic Survey, at a salary of \$720 per annum, will be filled by civil service examination on July 23.

AN assistant in entomology in the State Museum at Albany will be selected by civil service examination on or about July 13. The salary, after October 1, will be \$720 per annum.

THE New York City Board of Estimate and Apportionment has awarded the contract for completing the New York Public Library building to Norcross Brothers at a cost of \$2,865,705.

A SOCIETY has been established in Germany for the study of medicine and the natural sciences, and will hold its first annual meeting at the close of the approaching meeting of German Men of Science and Physicians.

THE Royal Meteorological Society has collected a fund amounting to over £700 as a memorial to the late Mr. G. J. Symons. With this fund a gold medal will be established to be awarded once in two years for distinguished work in meteorology, irrespective of nationality.

THE Peary Arctic Club will send the steamer *Erik* to the North about the middle of July. Mr. Herbert L. Bridgeman will be in charge and Dr. F. A. Cook has accepted the post of surgeon.

PLANS are being made for the establishment of an institute of colonial medicine in Paris, for which about 250,000 francs have been subscribed.

THE Austrian Fishery Association will hold an international fishery exhibition at Vienna during the latter part of September, 1902, a subsidy for this purpose having been granted by the Imperial Department of Agriculture.

AN International Exposition of Hygiene Maritime Security and Fishery will be held at Ostende, Belgium, during August and September. An international congress will be organized in connection with the exposition for the discussion of questions of maritime hygiene and maritime and colonial security.

#### UNIVERSITY AND EDUCATIONAL NEWS.

MR. JOHN D. ROCKEFELLER has given \$250,000 to Cornell University, on condition that an equal amount be contributed by others.

PRESIDENT HENRY MORTON, of the Stevens Institute of Technology, at Hoboken, N. J., has made a further gift of \$50,000 for the new chemical building of the institute.

DR. D. K. PEARSONS has made the following conditional gifts: Illinois College, Jacksonville, \$50,000; Fargo College, Fargo, N. D., \$50,000; Whitman College, Walla Walla, Wash., \$50,000; McKendree College, Lebanon Ill., \$50,000; Bethany College, Lindsborg, Kans., \$25,000; Fairmount College, Wichita, Kans., \$25,000; Drury College, Springfield, Mo., \$25,000.

AT the recent commencement at Smith College, President Seelye announced a conditional gift of \$100,000, one-half for endowment and one-half for the building fund. The condition is that an equal sum must be raised within a year.

MR. J. V. THOMPSON, of Uniontown, Pa., has given \$100,000 for the endowment of the president's chair of Washington and Jefferson College.

THE *Experiment Station Record* summarizes the appropriations made recently by State legislatures, according to which it appears that of the exceptionally large appropriations made by Missouri—\$467,400 for two years—\$40,000 is provided for a horticultural building and the same amount for a dairy and live-stock building. Kansas has appropriated over \$200,000 for the biennial period for its agricultural college and station, including \$70,000 for a new physics and chemistry building. Minnesota has appropriated \$25,000 for a new chemical building and the same amount for a new veterinary building. Washington has appropriated \$25,000 for a chemical laboratory. New Hamp-

shire has appropriated \$30,000 for an agricultural building.

AMONG other recent bequests and gifts we note the following: By the will of the late John Sweetser, of Boston, Radcliffe College will ultimately receive \$25,000. Mr. George A. Gardner has given \$10,000 towards building a laboratory of electrical engineering for the Massachusetts Institute of Technology. Mrs. Maule, of Philadelphia, has given \$10,000 to Princeton University to endow a fellowship in biology in memory of her son, F. Hinton Maule. Mr. Irwin Rew, a graduate of the Sheffield Scientific School of Yale University, has made a gift of \$10,000 to the school. Mr. G. F. Peabody, of New York, has given to the Georgia State Normal School \$3,000 to maintain a department of physiology for two years; he has also made a conditional donation of \$10,000 to the school. Dr. Alexander Agassiz has given the School Department of Newport, R. I., \$5,000, to be used to equip the biological, chemical and physical laboratories of the Cole School of Science. The trustees of the Mary Hemenway estate have appropriated \$500 for an anthropological fellowship in Columbia University.

Two of the three positions offered by the Harvard Medical School to properly qualified men desirous of training in physiological research and in the management of large laboratory classes in experimental physiology are not yet filled for the next collegiate year. Holders of these positions give more than half the day to research. The remaining time is spent during the first four months of the collegiate year in learning laboratory methods and during the last four months in directing the laboratory work of the medical students, about two hundred of whom work from two to three hours daily for sixteen weeks in experimental physiology. The fundamental experiments in physiology done by so many men working at one time present every variety of results and impart a training not to be acquired in other ways. Much too may be learned by association with the large staff engaged in research in the laboratories of anatomy, histology, pathology, pharmacology, hygiene, physiology and

physiological chemistry, all of which have their laboratories in the Medical School building. No charge of any kind is made either for the training in physiological research and in teaching or for the use of animals and other material. In addition to these opportunities each assistant receives four hundred dollars. Applications for these positions should be sent to Professor W. T. Porter, Harvard Medical School, 688 Boylston Street, Boston, Massachusetts.

PROFESSOR WINSLOW UPTON, director of the Ladd Observatory, of Brown University, has tendered his resignation as dean, owing to ill-health.

W. D. TAYLOR, formerly head of the department of physics and engineering at the Louisiana State University, has been elected professor of engineering at the University of Wisconsin to succeed the late Professor N. O. Whitney.

DR. CHARLES H. JUDD will have charge of the department of psychology and pedagogy in the summer school of the University of Cincinnati.

PROFESSOR BRUCE FINK, of Upper Iowa University, has been elected professor of geology and botany at Drake University, Iowa.

FELLOWSHIPS in the sciences at Princeton University have been awarded as follows: Mathematics, Oliver D. Kellogg, James C. Moorhead and Adam M. Hildebeitl; biology, Earl Douglass, Adam M. Miller; astronomy, John M. Poor; mental science, John K. Mackie; experimental science, Claude S. Hudson.

At the University of Wisconsin the following fellowship appointments have been made: Physics, E. R. Walcott; chemistry, H. E. Patten; pharmaceutical chemistry, I. W. Brandell; civil engineering, A. H. Blanchard.

PROFESSOR J. G. MACGREGOR, last year elected professor of physics in the University College, Liverpool, and prior to that professor of Dalhousie College, Halifax, has been appointed professor of natural philosophy at Edinburgh.

DR. C. V. KUPFFER, professor of anatomy and director of the Anatomical Institute of the University at Munich, has retired.

# SCIENCE

NEW SERIES.  
VOL. XIII. No. 314.

FRIDAY, JANUARY 4, 1901.

SINGLE COPIES, 15 CTS.  
ANNUAL SUBSCRIPTION, \$5.00.

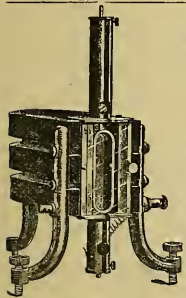

## WM. GAERTNER & CO.

**Astronomical and  
Physical Apparatus**

5347 AND 5349 LAKE AVE., CHICAGO

### SPECIALTIES

STANDARD APPARATUS OF NEW AND IMPROVED DESIGNS	READING MICROSCOPES AND TELESCOPES
ASTRONOMICAL TELESCOPES	DIVIDING ENGINES,
SPECTROSCOPES	COMPARATORS
MICHELSON INTERFEROMETERS	GENERAL LABORATORY APPARATUS
BOLOMETERS	UNIVERSAL LABORATORY SUPPORTS
HELIOSTATS	

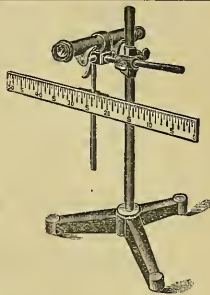

### THE STANDARD MEDICAL REFERENCE BOOK

## The Illustrated Dictionary of Medicine, Biology and Allied Sciences

By **GEORGE M. GOULD, A.M., M.D.**

*Editor "Philadelphia Medical Journal"; President, 1893-94, American Academy of Medicine.*

Including the Pronunciation, Accentuation, Derivation, and Definition of the Terms Used in Medicine, and those Sciences Collateral to it: Biology (Zoology and Botany), Chemistry, Dentistry, Pharmacology, Microscopy, etc. With Many Useful Tables and numerous Fine Illustrations. Large, Square Octavo. 1633 pages. Fifth Edition, now ready.

Half Morocco, \$10.00; with Thumb Index, \$11.00; Half Russia, Thumb Index, \$12.00 net

\*.\* Descriptive Circular with sample pages and Illustrations free.

**P. BLAKISTON'S SON & CO., MEDICAL AND SCIENTIFIC BOOKS, 1012 Walnut Street, Philadelphia**

**TRILOBITES:** We have just purchased one of the finest collections of **ASAPHUS GIGAS** ever made at Trenton Falls. Some magnificent specimens are among them. Prices on application.

Also lately received several specimens of the trilobite *Triarthrus becki*, showing legs and antennules; prices \$1.25 to \$10.00.

**WARD'S NATURAL SCIENCE ESTABLISHMENT, 30 to 40 College Ave., Rochester, N.Y.**

## The Rowland D'Arsonval Galvanometer

is a thoroughly proved instrument. For several years it has been used in Universities, Colleges, Technical, Normal and High Schools—for the individual use of laboratory students.

Unless otherwise ordered, each instrument is provided with reading telescope and scale.

Illustrated pamphlet, 340, describes the galvanometers in detail. Write for a copy.

Special prices for lots of 12 or more.

Are you interested in low-priced but accurate laboratory Resistance Boxes?

**JAMES G. BIDDLE**

1024 Stephen Girard Building, Philadelphia

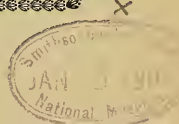

VOLS. I. AND II. NOW READY

# CYCLOPEDIA OF AMERICAN HORTICULTURE

By L. H. BAILEY, Cornell University, assisted by WILLIAM MILLER, and Many Expert Cultivators and Botanists

DESCRIPTIONS OF ALL THE SPECIES OF FRUITS, VEGETABLES, FLOWERS, AND ORNAMENTAL PLANTS IN THE MARKET IN AMERICA AND CANADA.

Over 2000 Original Illustrations. Sold on Subscription for the complete set only—in four volumes. Super-royal 8vo. Vols. I. and II. Each, Cloth, \$5.00 net.

DIRECTIONS FOR THE CULTIVATION OF ALL KINDS OF HORTICULTURAL CROPS AND OBSERVATIONS ON MARKETING, ETC., BY PRACTICAL CULTIVATORS.

Specialists of eminence contribute to the work fully 5000 signed articles

"This really monumental performance is to be completed in four volumes, and judging from the first of these it will take rank as a standard in its class . . . it is as scholarly as it is practical. Recognizing its importance, the publishers have given it faultless form."—THE NEW YORK TRIBUNE.

"We have here a work which every ambitious gardener will wish to place on his shelf besides his Nicholson and his Loudon, and for such users of it . . . In range, treatment and editing, the Cyclopaedia appears to be emphatically useful: . . . a work worthy of ranking by the side of the Century Dictionary."

—The Nation.

NOT ONLY ADEQUATE BUT INDISPENSABLE

"The information given is precisely what the horticulturist and general reader is desirous of knowing."

—Scientific American.

"The only work with which it can be at all compared is Nicholson's Dictionary of Gardening, but for American conditions and American horticulturists, Professor Bailey's work is far more reliable, useful and complete . . . It is an honor to its author and his assistant, its publishers, and American horticulturists as well."

—American Agriculturist.

"More comprehensive and ambitious than anything Professor Bailey has yet undertaken. Essentially American, wholly alive; . . . of inestimable value."—Chicago Tribune.

IF YOU ARE TO HAVE A GARDEN NEXT YEAR READ THIS WINTER

THE AMATEUR'S  
PRACTICAL  
GARDEN-BOOK

Profusely illustrated, simple directions for making the most of one's garden; in every direction. Each, \$1.00

GARDEN-MAKING:

Both are by

L. H. BAILEY, Cornell Univ.

"The little book is simply packed with information, all extremely practical . . . A more useful book of its sort we have never seen, or one more indispensable to the amateur gardener."—The Dial.

"A pleasure to the eye, a comfort to the hand, and inspiration to the mind; exactly what a city man with a suburban home has long been waiting for, and now . . . absolutely must have."—Boston Advertiser.

THE MACMILLAN COMPANY, Publishers, New York

# SCIENCE

NEW SERIES.  
VOL. XIII. No. 315.

FRIDAY, JANUARY 11, 1901.

SINGLE COPIES, 15 CTS.  
ANNUAL SUBSCRIPTION, \$5.00.

## Queen X-Ray Apparatus

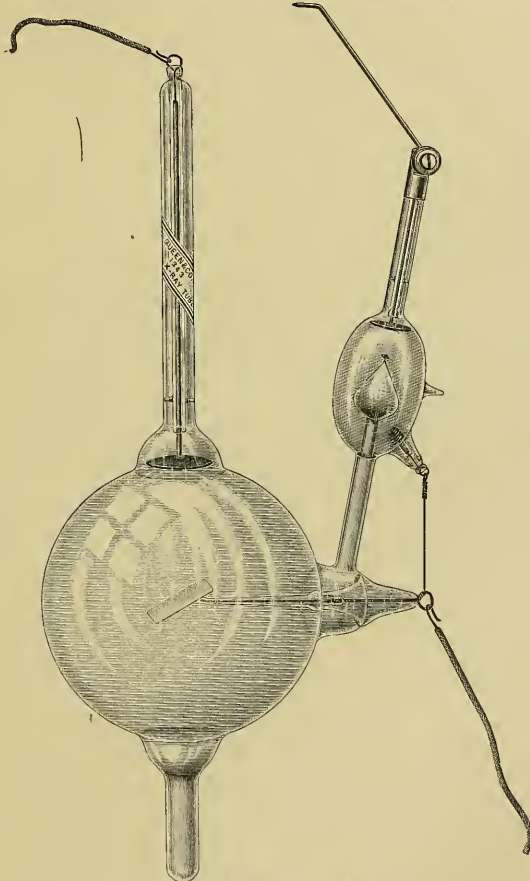

Queen Self-Regulating X-Ray Tube

### QUEEN & CO., Inc.

59 Fifth Avenue, New York  
480 Monon Bldg., Chicago

J. G. GRAY, President

PHILADELPHIA

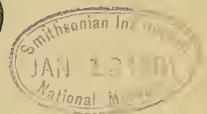

VOLS. I. AND II. NOW READY

## CYCLOPEDIA OF AMERICAN HORTICULTURE

By L. H. BAILEY, Cornell University, assisted by WILLIAM MILLER, and Many Expert Cultivators and Botanists

DESCRIPTIONS OF ALL THE SPECIES OF FRUITS, VEGETABLES, FLOWERS, AND ORNAMENTAL PLANTS IN THE MARKET IN AMERICA AND CANADA.

Over 2000 Original Illustrations. Sold on Subscription for the complete set only— in four volumes. Super-royal 8vo. Vols. I. and II. Each, Cloth, \$5.00 net.

DIRECTIONS FOR THE CULTIVATION OF ALL KINDS OF HORTICULTURAL CROPS AND OBSERVATIONS ON MARKETING, ETC., BY PRACTICAL CULTIVATORS.

Specialists of eminence contribute to the work fully 5000 signed articles

"This really monumental performance is to be completed in four volumes, and judging from the first of these it will take rank as a standard in its class . . . it is as scholarly as it is practical. Recognizing its importance, the publishers have given it faultless form."—THE NEW YORK TRIBUNE.

"We have here a work which every ambitious gardener will wish to place on his shelf besides his Nicholson and his Loudon, and for such users of it . . . In range, treatment and editing, the Cyclopaedia appears to be emphatically useful: . . . a work worthy of ranking by the side of the Century Dictionary."

—The Nation.

NOT ONLY ADEQUATE BUT INDISPENSABLE

"The information given is precisely what the horticulturist and general reader is desirous of knowing."

—Scientific American.

"The only work with which it can be at all compared is Nicholson's Dictionary of Gardening, but for American conditions and American horticulturists, Professor Bailey's work is far more reliable, useful and complete . . . It is an honor to its author and his assistant, its publishers, and American horticulturists as well."

—American Agriculturist.

"More comprehensive and ambitious than anything Professor Bailey has yet undertaken. Essentially American, wholly alive; . . . of inestimable value."—Chicago Tribune.

IF YOU ARE TO HAVE A GARDEN NEXT YEAR READ THIS WINTER

THE AMATEUR'S  
PRACTICAL  
GARDEN-BOOK

Profusely illustrated, simple directions for making the most of one's garden, in every direction. Each, \$1.00

GARDEN-MAKING:

Both are by

L. H. BAILEY, Cornell Univ.

"The little book is simply packed with information, all extremely practical . . . A more useful book of its sort we have never seen, or one more indispensable to the amateur gardener."—The Dial.

"A pleasure to the eye, a comfort to the hand, and inspiration to the mind; exactly what a city man with a suburban home has long been waiting for, and now . . . absolutely must have."—Boston Advertiser.

THE MACMILLAN COMPANY, Publishers, New York



# SCIENCE

NEW SERIES.  
VOL. XIII. No. 316.

FRIDAY, JANUARY 18, 1901.

SINGLE COPIES, 15 CTS.  
ANNUAL SUBSCRIPTION, \$5.00.

## Chemicals and Chemical Apparatus

SELLING AGENTS FOR  
**CARL ZEISS'S MICROSCOPES AND ACCESSORIES**

Used extensively in the Laboratories of the U.S. Government

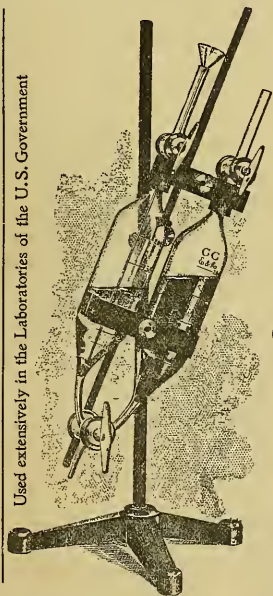

These are Specimens  
of the  
**High-Grade**  
Scientific  
**Glass Blowing**  
Done on Our  
Premises

No. 5192 A

**BOILING POINT APPARATUS** according to Dr. B. H. HITE

A thermometer **READING TO ONE THOUSANDTH OF A DEGREE**, SHOWS NO VARIATION  
in the temperature of a liquid in the tube

No. 8828 A. **PIPETTE** according to ROTHE, for the rapid estimation of IRON by means of ETHER

**EIMER & AMEND**, 18TH STREET and  
THIRD AVENUE, New York

SOLE AGENTS FOR U. S. A. AND CANADA FOR  
**FRANZ SCHMIDT & HAENSCH'S POLARISCOPES**

Their Triple Field of Vision adopted by the U. S. Government as Standard

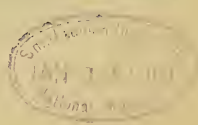
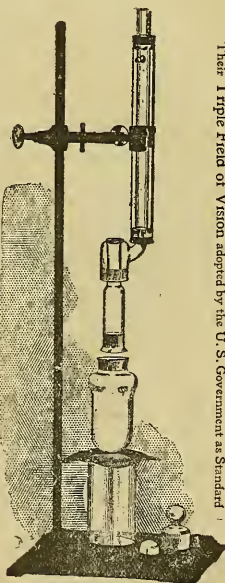

VOLS. I. AND II. NOW READY

# CYCLOPEDIA OF AMERICAN HORTICULTURE

By L. H. BAILEY, Cornell University, assisted by WILLIAM MILLER, and Many Expert Cultivators and Botanists

DESCRIPTIONS OF ALL THE SPECIES OF FRUITS, VEGETABLES, FLOWERS, AND ORNAMENTAL PLANTS IN THE MARKET IN AMERICA AND CANADA.

Over 2000 Original Illustrations. Sold on Subscription for the complete set only—in four volumes. Super-royal 8vo. Vols. I. and II. Each, Cloth, \$5.00 net.

DIRECTIONS FOR THE CULTIVATION OF ALL KINDS OF HORTICULTURAL CROPS AND OBSERVATIONS ON MARKETING, ETC., BY PRACTICAL CULTIVATORS.

Specialists of eminence contribute to the work fully 5000 signed articles

"This really monumental performance is to be completed in four volumes, and judging from the first of these it will take rank as a standard in its class . . . it is as scholarly as it is practical. Recognizing its importance, the publishers have given it faultless form."—THE NEW YORK TRIBUNE.

"We have here a work which every ambitious gardener will wish to place on his shelf besides his Nicholson and his Loudon, and for such users of it . . . In range, treatment and editing, the Cyclopaedia appears to be emphatically useful: . . . a work worthy of ranking by the side of the Century Dictionary."

—The Nation.

NOT ONLY ADEQUATE BUT INDISPENSABLE

"The information given is precisely what the horticulturist and general reader is desirous of knowing."

—Scientific American.

"The only work with which it can be at all compared is Nicholson's Dictionary of Gardening, but for American conditions and American horticulturists, Professor Bailey's work is far more reliable, useful and complete . . . It is an honor to its author and his assistant, its publishers, and American horticulturists as well."

—American Agriculturist.

"More comprehensive and ambitious than anything Professor Bailey has yet undertaken. Essentially American, wholly alive; . . . of inestimable value."—Chicago Tribune.

IF YOU ARE TO HAVE A GARDEN NEXT YEAR READ THIS WINTER

THE AMATEUR'S  
PRACTICAL  
GARDEN-BOOK

Profusely illustrated, simple directions for making the most of one's garden, in every direction. Each, \$1.00

GARDEN-MAKING:

Both are by

L. H. BAILEY, Cornell Univ.

"The little book is simply packed with information, all extremely practical . . . A more useful book of its sort we have never seen, or one more indispensable to the amateur gardener."—The Dial.

"A pleasure to the eye, a comfort to the hand, and inspiration to the mind; exactly what a city man with a suburban home has long been waiting for, and now . . . absolutely must have."—Boston Advertiser.

THE MACMILLAN COMPANY, Publishers, New York

# SCIENCE

NEW SERIES.  
VOL. XIII. No. 317.

FRIDAY, JANUARY 25, 1901.

SINGLE COPIES, 15 CTS.  
ANNUAL SUBSCRIPTION, \$5.00

## THREE ELEMENTS OF OUR SUCCESS

Have been the three LENSES with which  
our most popular Microscopes are equipped

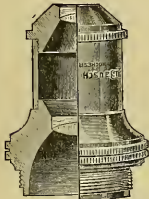

$\frac{2}{3}$  inch Objective

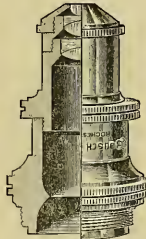

$\frac{1}{6}$  inch Objective.

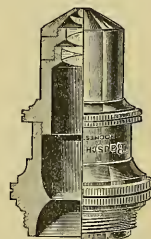

$\frac{1}{12}$  inch Oil Immersion Objective.

The **2-3 inch Objective** possesses the large field, depth of focus, and high resolving power which make a low-power lens desirable.

The **1-6** has remarkable working distance, making it especially adapted to general laboratory work, and at the same time resolving, magnifying, and illuminating power equal to the best.

The **1-12 inch Oil Immersion** has so many excellent features that only a trial can demonstrate them. Unusually long working distance, extreme flatness of field, high resolving power, and absolute permanency of the materials of construction are a few of the good qualities. Our method of mounting the delicate hemispherical front lens secures the greatest possible permanency and the least liability to leakage.

---

## Bausch & Lomb Optical Co.

Branches:  
NEW YORK and CHICAGO

N. St. Paul Street, ROCHESTER, N. Y.

# Miscellaneous Recent Scientific Publications

By THE MACMILLAN COMPANY

## ZOOLOGY

IN TWO VOLUMES, ILLUSTRATED. CLOTH, CROWN OCTAVO, \$5.00

## STUDIES SCIENTIFIC AND SOCIAL

The Collected Essays of ALFRED RUSSEL WALLACE, LL.D., D.C.L., F.R.S., Etc.

Author of "The Malay Archipelago," "Natural Selection and Tropical Nature," "Darwinism," etc.

Brief statements in untechnical form of the positions reached during recent years by the foremost exponent of what is known as the Darwinian theory. The papers in the first volume are grouped by their subjects as on Earth Studies, Plant and Animal Distribution, Anthropology, etc. The second contains Educational, Political, Ethical and Sociological Papers.

Illustrated. 2 volumes, cr. 8vo, \$5.00.  
"His unpretending style is very attractive in its clearness and simplicity and for orderliness and compactness his arrangement of argument and examples could hardly be excelled. Finally his tone is admirable."—BOSTON ADVERTISER.

"It is needless to say that Mr. WALLACE is a naturalist of the very first rank, and that his reasonings do not lack for facts and illustrations to enforce them."—POPULAR SCIENCE MONTHLY.

Send for a circular giving titles of the different Essays in full.

Just Ready. A TEXT-BOOK OF THE EMBRYOLOGY Part IV.

**Of Invertebrates.** By DR. E. KORSHELT, in the University of Marburg, and DR. K. HEIDER, in the University of Berlin. Part I. translated by EDWARD L. MARK, Ph.D., and W. M. M. WOODWORTH, Ph.D., Harvard University. Parts II. to IV. translated by MATHILDA BERNARD. Revised and edited by MARTIN F. WOODWARD, London. Fully illustrated. Part I., \$4.00 net. Part II., \$3.00 net. Part III., \$3.25 net. Part IV., \$4.00 net.

**Of Man and Mammals.** By DR. OSCAR HERTWIG, of the University of Berlin. Translated from the Third German Edition by EDWARD L. MARK, Ph.D., Harvard University. Second Edition, \$5.25 net.

"A general text-book of vertebrate embryology. As such a text-book it is of the greatest value to a student."—SCIENCE.

## A TREATISE ON ZOOLOGY

Edited with an Introduction by

E. RAY LANKESTER, LL.D., F.R.S., Director of the Natural History Departments of the British Museum.

Part II. **The Porifera and Cœlentera.** By E. A. MINCHIN, G. HERBERT FOWLER, Ph.D., and GILBERT C. BOURNE. 8vo. Cloth. \$5.50 net.

Previously issued: Vol. III. **Echinoderma.** Cloth. 8vo. \$5.25 net.

## ASTRONOMY

## THE ELEMENTS OF ASTRONOMY

By the author of "Starland," "Atlas of Astronomy," "The Story of the Sun," etc., etc.

By SIR ROBERT BALL, LL.D., Professor of Astronomy and Geometry in the University of Cambridge. Cloth, illustrated, 80 cents net.

## ANTHROPOLOGY

## THE HUMAN EAR: ITS IDENTIFICATION AND PHYSIOGNOMY

A volume to be classed perhaps with Dalton's Finger Prints, etc.

By MIRIAM ANNE ELLIS. With Illustrations from Photographs chiefly from Nature-prints. 12mo. Cloth. Pp. x. + 225. Price, \$1 75.

## BOTANY

## HANDBOOK OF PRACTICAL BOTANY

FOR THE BOTANICAL LABORATORY AND PRIVATE STUDENT.

By D. E. STRASBURGER, University of Bonn. Translated and edited by W. WILLHOUSE, University of Birmingham. 5th Edition, rewritten and enlarged. With 159 original and a few additional illustrations. Cloth. 8vo. \$2.60 net

## BOTANY. AN ELEMENTARY TEXT FOR SCHOOLS

By Prof. L. H. BAILEY, Cornell University, Author of "Lessons, with Plants, etc." Illustrated. Half leather. \$1.10 net.

THE MACMILLAN COMPANY, 66 Fifth Avenue, N. Y.

# SCIENCE

NEW SERIES,  
VOL. XIII. No. 318.

FRIDAY, FEBRUARY 1, 1901.

SINGLE COPIES, 15 CTS.  
ANNUAL SUBSCRIPTION, \$5.00.

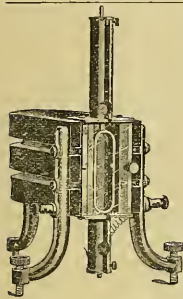

## WM. GAERTNER & CO.

Astronomical and  
Physical Apparatus

5347 AND 5349 LAKE AVE., CHICAGO

### SPECIALTIES

STANDARD APPARATUS OF NEW AND IMPROVED DESIGNS  
READING MICROSCOPES AND TELESCOPES  
ASTRONOMICAL TELESCOPES DIVIDING ENGINES,  
SPECTROSCOPES COMPARATORS  
MICHELSON INTERFEROMETERS GENERAL LABORATORY AP-  
PARATUS  
BOLOMETERS UNIVERSAL LABORATORY  
HELIOSTATS SUPPORTS

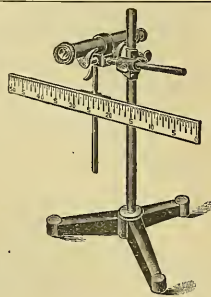

JUST READY

## Laboratory Instructions in General Chemistry

By ERNEST A. CONGDON, PH.B., F.C.S.,

*Professor of Chemistry in the Drexel Institute, Philadelphia; Member American Chemical Society; Fellow of the London Chemical Society, etc.*

With 56 Illustrations and Useful Tables. Octavo, Interleaved, Cloth net \$1.00.

\* \* \* This handbook contains several unique and practical features that will prove helpful to the teacher. It may be used in connection with any general text-book on chemistry.

P. BLAKISTON'S SON & CO., Publishers, 1012 Walnut Street, Philadelphia

**TRILOBITES:** We have just purchased one of the finest collections of **ASAPHUS GIGAS** ever made at Trenton Falls. Some magnificent specimens are among them. Prices on application.

Also lately received several specimens of the trilobite *Triarthrus becki*, showing legs and antennules; prices \$1.25 to \$10.00.

WARD'S NATURAL SCIENCE ESTABLISHMENT, 30 to 40 College Ave., Rochester, N.Y.

Only One

Authorized Agent

in the

United States

## The English Edition

of the 1900 Catalogue issued by the *Société Gènevoise* is now ready for distribution. It is free to any college professor who is interested in high-grade

### Physical Laboratory Apparatus

"Duty Free" Importations a Specialty.

**JAMES G. BIDDLE**

Sole U. S. Agent for *Société Gènevoise*

1024 Stephen Girard Building

PHILADELPHIA

# Scientific Reference and Text-Books

Vols. I. and II. Ready now. Vol. III. Early in February. Each \$5.00 net.

"Essentially American—wholly alive . . . of inestimable value."—CHICAGO TRIBUNE.

## Cyclopedia of American Horticulture

Edited by L. H. BAILEY, Professor of Horticulture, Cornell University,  
Assisted by WILLIAM MILLER, and Many Expert Cultivators and Botanists

Vol. III. Ready  
Early in February.  
Cloth, Royal 8vo.

Vol. I. and II.  
Each \$5.00 net.

By the Same Author:

"The information given is precisely  
what the horticulturist and general reader  
is desirous of knowing."

—SCIENTIFIC AMERICAN.

In range, treatment and editing, the Cyclo-  
pedia appears to be emphatically useful: . . .  
a work worthy of ranking by the side of  
the Century Dictionary."—THE NATION.

DESCRIPTIONS OF ALL THE  
SPECIES OF FRUITS, VEGETA-  
BLES, FLOWERS, AND ORNA-  
MENTAL PLANTS IN THE  
MARKET IN AMERICA AND  
CANADA. DIRECTIONS FOR  
THE CULTIVATION OF ALL  
KINDS OF CROPS, OBSERVA-  
TIONS ON MARKETING, ETC.

### BOTANY. AN ELEMENTARY TEXT FOR SCHOOLS

By Prof. L. H. BAILEY, Cornell University, Author of "Lessons, with Plants, etc." Illustrated.

Half leather. \$1.10 net.

## ZOOLOGY

### STUDIES SCIENTIFIC AND SOCIAL

The Collected Essays of ALFRED RUSSEL WALLACE, LL.D., D.C.L., F.R.S., Etc.

Author of "The Malay Archipelago," "Natural Selection and Tropical Nature," "Darwinism," etc.

The papers Vol. I.:—Earth Studies, Plant and Animal Distribution, Anthropology, etc.; Vol. II.:—Educa-  
tional, Political, Ethical and Sociological Papers. Illustrated. 2 vols., cr. 8vo, \$5.00.

### Just Ready. A TEXT-BOOK OF THE EMBRYOLOGY Part IV.

**Of Invertebrates.** By Dr. E. KORSCHÉL, in the University of Marburg, and Dr. K. HEIDER, in the Univer-  
Part I., \$4.00 net. sity of Berlin. Part I. translated by EDWARD L. MARK, Ph.D., and W. M. M.  
Part II., \$3.00 net. WOODWORTH, Ph.D., Harvard University. Parts II. to IV. translated by MATHILDA  
Part III., \$3.25 net. BERNARD. Revised and edited by MARTIN F. WOODWARD, London. Fully illus-  
Part IV., \$4.00 net. trated.

**Of Man and Mammals.** By Dr. OSCAR HERTWIG, of the University of Berlin. Translated from the Third  
German Edition by EDWARD L. MARK, Ph.D., Harvard University. Second Edition, \$5.25 net.

"A general text-book of vertebrate embryology. As such a text-book it is of the greatest value to a student."—SCIENCE.

### A TREATISE ON ZOOLOGY

Previously Issued Edited with an Introduction by E. RAY LANKESTER, LL.D., Director Natural History  
III. Echinoderma Depts. British Museum. Part II. The Porifera and Celentera. By E. A. MIN-  
Cloth, \$5.25 net. CHIN, G. HERBERT FOWLER, Ph.D., and GILBERT C. BOURNE. 8vo. Cloth. \$5.50 net.

## ASTRONOMY THE ELEMENTS OF ASTRONOMY

By the author of "Star-  
land," "Atlas of Astron-  
omy," etc., etc.

By SIR ROBERT BALL, LL.D., Professor of Astronomy and Geometry in the Univer-  
sity of Cambridge. Cloth, illustrated, 80 cents net.

## ANTHROPOLOGY THE HUMAN EAR:

A volume to be classed  
perhaps with Dalton's  
Finger Prints, etc.

ITS IDENTIFICATION AND PHYSIOGNOMY. By MIRIAM ANNE ELLIS.  
With Illustrations from Photographs chiefly from Nature-prints.

12mo. Cloth. Pp. x. + 225. Price, \$1.75.

THE MACMILLAN COMPANY, 66 Fifth Avenue, N. Y.

# SCIENCE

NEW SERIES.  
VOL. XIII. No. 319.

FRIDAY, FEBRUARY 8, 1901.

SINGLE COPIES, 15 CTS.  
ANNUAL SUBSCRIPTION, \$5.00.

## Queen Instruments

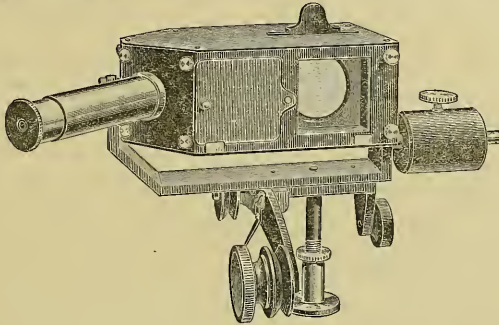

### Lummer Brodhun Photometer Screen

An indispensable accessory when accurate photometric work is done.

The **QUEEN** form excels all others in :

**REVERSIBILITY**  
**ACCURACY OF ADJUSTMENT**  
**SIMPLICITY OF CONSTRUCTION**  
**GENERAL FINISH**

We are the only makers who guarantee their Lummer Brodhun Screens to reverse within 3 mm.

**INDUCTION COILS                      PHOTOMETERS                      X-RAY TUBES**  
**PHYSICAL AND ELECTRICAL APPARATUS**

## QUEEN & CO., Inc.

J. G. GRAY, President

1010 CHESTNUT STREET,  
PHILADELPHIA

59 Fifth Avenue, New York  
480 Monon Bldg., Chicago

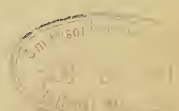

## AN "INDISPENSABLE" REFERENCE BOOK.

The Third Volume will be ready in February uniform with Volumes I. and II. issued last year.

# Cyclopedia of American Horticulture

Edited by L. H. BAILEY, Professor of Horticulture, Cornell University,  
Assisted by WILLIAM MILLER, and Many Expert Cultivators and Botanists

Vol. III. *To be Ready in February.*  
Cloth, Royal 8vo.

Vol. I. and II.  
Each \$5.00 net.

"The information given is precisely what the horticulturist and general reader is desirous of knowing."

—SCIENTIFIC AMERICAN.

... In range, treatment and editing, the Cyclopedia appears to be **emphatically useful**: ... a work worthy of ranking by the side of the Century Dictionary."—THE NATION.

DESCRIPTIONS OF ALL THE SPECIES OF FRUITS, VEGETABLES, FLOWERS, AND ORNAMENTAL PLANTS IN THE MARKET IN AMERICA AND CANADA. DIRECTIONS FOR THE CULTIVATION OF ALL KINDS OF CROPS, OBSERVATIONS ON MARKETING, ETC.

SOLD ON SUBSCRIPTION ONLY.

"A mass of most valuable information, bringing together as it does, into available and properly edited form, the immense contributions of facts from horticulturists to the whole evolutionary doctrine. . . . In short, to such an one [interested in horticulture] the Cyclopedia would seem to be a *sine qua non*."—*The Dial*, Chicago.

Before you make your garden this spring consult Professor BAILEY'S GARDEN-MAKING and AMATEUR'S PRACTICAL GARDEN BOOK—or the special books on Vegetable or Fruit Gardening in THE RURAL SCIENCE SERIES or GARDEN CRAFT SERIES—of which circulars will be sent on application to his publishers.

The latest issue is by Prof. L. H. BAILEY, *Just Ready*, 458 pages, well illustrated.

Cloth, \$1.25.

## THE PRINCIPLES OF VEGETABLE GARDENING

The newest and completest book on the subject, and the first to state principles.

### BOTANY

## An Elementary Text-Book for Schools

Half leather.  
Illustrated profusely.  
\$1.10 net.

By L. H. BAILEY, Professor of Horticulture, Cornell University, Editor-in-Chief of "The Cyclopedia of American Horticulture," Author of "Lessons from Plants," etc., etc.

"Should be in the hands of every student of Botany. . . . it is marked by a thoroughness and completeness that make it especially valuable."—BOSTON TRANSCRIPT.

"It would be hard to find a better manual for schools or for individual use."—THE OUTLOOK.

"Thoroughly attractive."—THE NATION.

## Handbook of Practical Botany

FOR THE BOTANICAL LABORATORY AND PRIVATE STUDENT. By D. E. STRASBURGER, University of Bonn. Translated and edited by W. HILLHOUSE, University of Birmingham. \$2.60 net.

Fifth Edition  
rewritten, enlarged.  
Fully illustrated.  
Cloth. \$2.60 net.

"The whole appearance of the work is attractive. . . . Two features are impressed on every chapter of the book (1) definiteness and lucidity of statement, and (2) caution in holding the statements within defensible limits."—EVENING POST, N. Y.

THE MACMILLAN COMPANY, 66 Fifth Avenue, N. Y.



# SCIENCE

NEW SERIES.  
VOL. XIII. No. 320.

FRIDAY, FEBRUARY 15, 1901.

SINGLE COPIES, 15 CTS.  
ANNUAL SUBSCRIPTION, \$5.00.

## CHEMICALS AND CHEMICAL, PHYSICAL AND SCIENTIFIC APPARATUS

Carl Zeiss's Microscopes  
and Accessories

Carl Schleicher & Schull's  
C. P. Filters

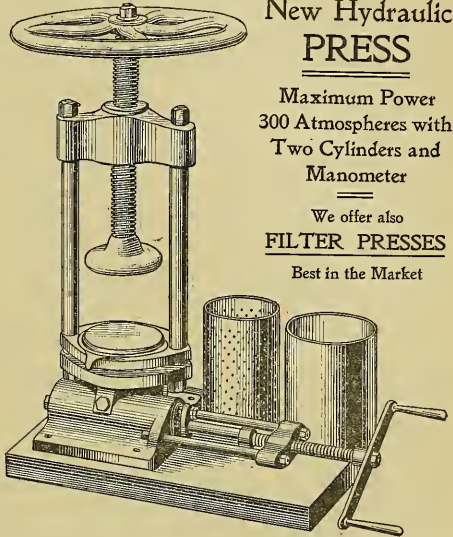
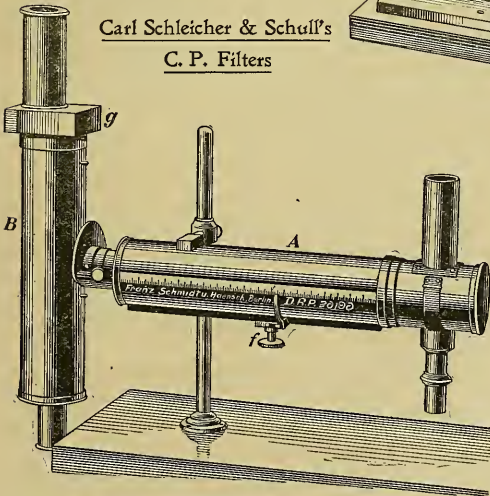

## New Hydraulic PRESS

Maximum Power  
300 Atmospheres with  
Two Cylinders and  
Manometer

We offer also  
FILTER PRESSES

Best in the Market

## PHOTOMETER

WEBER'S FOLDING

Extensively  
used by Gas Companies in the  
United States

AND

## POLARISCOPES

FRANZ SCHMIDT and  
HAENSCH' MAKE

Sole Agents for U. S. A. and Canada  
are

EIMER & AMEND, 18TH STREET and THIRD AVENUE, New York

## AN "INDISPENSABLE" REFERENCE BOOK.

Vol. III. will be ready very shortly uniform with

Vol. I. and II. SOLD ON SUBSCRIPTION ONLY.

**Cyclopedia of American Horticulture**

Edited by L. H. BAILEY, Professor of Horticulture, Cornell University,  
Assisted by WILLIAM MILLER, and Many Expert Cultivators and Botanists

Vol. III.

To be Ready very soon.

Cloth, Royal 8vo.

Vol. I. and II.

Each \$5.00 net.

"The information given is precisely  
what the horticulturist and general reader  
is desirous of knowing."

—SCIENTIFIC AMERICAN.

... In range, treatment and editing, the Cyclo-  
pædia appears to be emphatically useful: . . .  
a work worthy of ranking by the side of  
the Century Dictionary."—THE NATION.

DESCRIPTIONS OF ALL THE  
SPECIES OF FRUITS, VEGETABLES,  
FLOWERS, AND ORNAMENTAL PLANTS IN THE  
MARKET IN AMERICA AND CANADA. DIRECTIONS FOR  
THE CULTIVATION OF ALL  
KINDS OF CROPS, OBSERVATIONS  
ON MARKETING, ETC.

"A mass of most valuable information, bringing together as it does, into available and properly edited form, the immense contributions of facts from horticulturists to the whole evolutionary doctrine. . . . In short, to such an one [interested in horticulture] the Cyclopedia would seem to be a *sine qua non*."—*The Dial*, Chicago.

Before you make your garden this spring consult Professor BAILEY'S GARDEN-MAKING and AMATEUR'S PRACTICAL GARDEN BOOK—or the special books on Vegetable or Fruit Gardening in THE RURAL SCIENCE SERIES or GARDEN CRAFT SERIES—of which circulars will be sent on application to his publishers.

## IN THE RURAL SCIENCE SERIES

The latest is by Prof. L. H. BAILEY, of Cornell University. 458 pages, illustrated, indexed for ready reference.

**THE PRINCIPLES OF VEGETABLE GARDENING**

Just Ready, \$1.25. The newest and completest book on the subject, and the first to state principles.

PART I.—A general view,—discusses the lay-out, glass houses, etc.,—the soil, tools, seeds, etc.

PART II.—Crops,—takes up root, tuber, bulb, cole, pot-herb, and salad crops; and beans, tomatoes, melons, corn, and others, closing with perennials, such as asparagus and rhubarb. Thorough, but practical.

**BOTANY****AN ELEMENTARY TEXT-BOOK FOR SCHOOLS**

Half leather.

Illustrated profusely.

\$1.10 net.

By L. H. BAILEY, Professor of Horticulture, Cornell University, Editor-in-Chief of "The Cyclopedia of American Horticulture," Author of "Lessons from Plants," etc., etc.

"Should be in the hands of every student of Botany.

. . . it is marked by a thoroughness and completeness

that make it especially valuable.—BOSTON TRANSCRIPT.

"It would be hard to find a better manual for schools

or for individual use."—THE OUTLOOK.

"Thoroughly attractive."—THE NATION.

**HANDBOOK OF PRACTICAL BOTANY**

FOR THE BOTANICAL LABORATORY AND PRIVATE STUDENT. By D. E. STRASBURGER, University of Bonn.

Translated and edited by W. HILLHOUSE, University of Birmingham.

\$2.60 net.

Fifth Edition

rewritten, enlarged.

Fully illustrated.

Cloth. \$2.60 net.

"The whole appearance of the work is attractive . . . Two features are impressed on

every chapter of the book (1) definiteness and lucidity of statement, and (2) cau-

tion in holding the statements within defensible limits."—EVENING POST, N. Y.

THE MACMILLAN COMPANY, 66 Fifth Ave., New York

# SCIENCE

NEW SERIES,  
VOL. XIII. No. 321.

FRIDAY, FEBRUARY 22, 1901.

SINGLE COPIES, 15 CTS.  
ANNUAL SUBSCRIPTION, \$5.00.

## NEW Ground Label Reagent Bottles



WE HAVE recently perfected a process by which we are able to label any kind or size of bottle with any combination of letters or figures at a very moderate cost, and any variety of inscription is as easily and quickly done as a duplication of a single name. The label appears on the bottle as a smoothly ground area with the letters and figures in polished glass. Thus, whether the bottle is

filled with a light or a dark fluid, the label is always easily legible and the appearance is much neater than that of raised letters or of labels cemented to the bottle. The containers are kept clean much easier and there is a great saving in the cost. The bottles on which prices are quoted are extra fine quality and extra clear glass.

Sample bottle, showing label, will be sent free to laboratories.

GLASS STOPPERS—Tincture or Narrow Mouth.					
Contents CC.....	125	250	500	1000	2000
Price per 10.....	\$1.50	2.00	2.75	3.75	5.00
GLASS STOPPERS—Salt or Wide Mouth.					
Contents CC.....	125	250	500	1000	
Price per 10.....	\$1.75	2.25	3.00	4.00	

Above prices are for bottles labeled to order, and are subject to usual discount. Packing and transportation extra.

## Bausch & Lomb Optical Co.

Rochester, N. Y.

## AN "INDISPENSABLE" REFERENCE BOOK.

Vol. III. will be ready very shortly uniform with  
Vol. I. and II. SOLD ON SUBSCRIPTION ONLY.

## Cyclopedia of American Horticulture

Edited by L. H. BAILEY, Professor of Horticulture, Cornell University,  
Assisted by WILLIAM MILLER, and Many Expert Cultivators and Botanists

Vol. III.  
To be Ready very soon.  
Cloth, Royal 8vo.

"The information given is precisely  
what the horticulturist and general reader  
is desirous of knowing."

—SCIENTIFIC AMERICAN.

Vol. I. and II.  
Each \$5.00 net.

. . . In range, treatment and editing, the Cyclo-  
pedia appears to be emphatically useful: . . .  
a work worthy of ranking by the side of  
the Century Dictionary."—THE NATION.

DESCRIPTIONS OF ALL THE  
SPECIES OF FRUITS, VEGETABLES,  
FLOWERS, AND ORNAMENTAL PLANTS IN THE  
MARKET IN AMERICA AND  
CANADA. DIRECTIONS FOR  
THE CULTIVATION OF ALL  
KINDS OF CROPS, OBSERVA-  
TIONS ON MARKETING, ETC.

"A mass of most valuable information, bringing together as it does, into available and properly edited form, the immense contributions of facts from horticulturists to the whole evolutionary doctrine. . . . In short, to such an one [interested in horticulture] the Cyclopedia would seem to be a *sine qua non*."—*The Dial*, Chicago.

Before you make your garden this spring consult Professor BAILEY'S GARDEN-MAKING and AMATEUR'S PRACTICAL GARDEN BOOK—or the special books on Vegetable or Fruit Gardening in THE RURAL SCIENCE SERIES or GARDEN CRAFT SERIES—of which circulars will be sent on application to his publishers.

The latest is by Prof. L. H. BAILEY, of Cornell University. 458 pages Illustrated. Just Ready, \$1.25.

## THE PRINCIPLES OF VEGETABLE GARDENING

*Rural Science Series.* The newest and completest book on the subject, and the first to state principles.

PART I.—A general view,—discusses the lay-out, glass houses, etc.,—the soil, tools, seeds, etc.

PART II.—Crops,—takes up root, tuber, bulb, cole, pot-herb, and salad crops; and beans, tomatoes, melons, corn, and others, closing with perennials, such as asparagus and rhubarb. Thorough, but practical.

**BOTANY**

## AN ELEMENTARY TEXT-BOOK FOR SCHOOLS

Half leather. By L. H. BAILEY, Professor of Horticulture, Cornell University, Editor-in-Chief of "The  
Illustrated profusely. Cyclopedia of American Horticulture," Author of "Lessons from Plants," etc., etc.  
\$1.10 net.

"Should be in the hands of every student of Botany. . . . it is marked by a thoroughness and completeness that make it especially valuable."—BOSTON TRANSCRIPT.

"It would be hard to find a better manual for schools or for individual use."—THE OUTLOOK.

"Thoroughly attractive."—THE NATION.

## HANDBOOK OF PRACTICAL BOTANY

FOR THE BOTANICAL LABORATORY AND PRIVATE STUDENT. By D. E. STRASBURGER, University of Bonn.  
Translated and edited by W. HILLHOUSE, University of Birmingham. \$2.60 net.

Fifth Edition  
rewritten, enlarged,  
Fully illustrated.  
Cloth. \$2.60 net.

"The whole appearance of the work is attractive. . . . Two features are impressed on every chapter of the book (1) definiteness and lucidity of statement, and (2) caution in holding the statements within defensible limits."—EVENING POST, N. Y.

THE MACMILLAN COMPANY, 66 Fifth Ave., New York

# SCIENCE

NEW SERIES.  
VOL. XIII. No. 322.

FRIDAY, MARCH 1, 1901.

SINGLE COPIES, 15 CTS.  
ANNUAL SUBSCRIPTION, \$5.00.

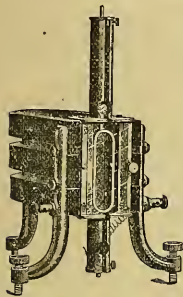

## WM. GAERTNER & CO.

Astronomical and  
Physical Apparatus

5347 AND 5349 LAKE AVE., CHICAGO

### SPECIALTIES

STANDARD APPARATUS OF NEW AND IMPROVED DESIGNS  
READING MICROSCOPES AND TELESCOPES  
ASTRONOMICAL TELESCOPES DIVIDING ENGINES,  
SPECTROSCOPES COMPARATORS  
MICHELSON INTERFEROMETERS GENERAL LABORATORY AP-  
PARATUS  
BOLOMETERS UNIVERSAL LABORATORY  
HELIOSTATS SUPPORTS

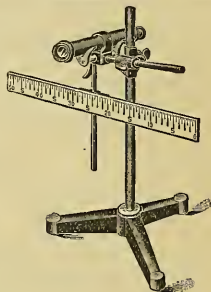

JUST READY

## Laboratory Instructions in General Chemistry

By ERNEST A. CONGDON, PH.B., F.C.S.,

*Professor of Chemistry in the Drexel Institute, Philadelphia; Member American Chemical Society; Fellow of the London Chemical Society, etc.*

With 56 Illustrations and Useful Tables. Octavo, Interleaved, Cloth net \$1.00.

\*\*This handbook contains several unique and practical features that will prove helpful to the teacher. It may be used in connection with any general text-book on chemistry.

P. BLAKISTON'S SON & CO., Publishers, 1012 Walnut Street, Philadelphia

## PHYSIOGRAPHICAL MODELS,

physical geography or geology.

We issue a series of models and photographs, gotten up by Professors Shaler, Davis, and Harris, which are equally effective for illustrations of

*Write for Illustrated Circular.*

The best thing on the market!

WARD'S NATURAL SCIENCE ESTABLISHMENT, 30 to 40 College Ave., Rochester, N.Y.

Accurate

Resistance Boxes

at very

little cost

B 5226 Wheatstone Bridge and Rheostat, . . . \$40.00  
Sixteen rheostat coils aggregating 11,110 ohms. Bridge arms 1, 10, 100 and 10, 100, 1,000 ohms, with reversing device. Theoretical range .001 to 11,110,000 ohms. Rheostat coils accurate within  $\frac{1}{2}$  of 1%; Bridge coils accurate within  $\frac{1}{3}$  of 1%.

B 5228 Resistance Box, . . . \$27.50  
Sixteen coils aggregating 11,110 ohms. Accurate within  $\frac{1}{2}$  of 1%.

B 5230 Resistance Box, . . . \$20.00  
Twelve coils aggregating 1,110 ohms. Accurate within  $\frac{1}{2}$  of 1%.  
*These are merely examples. College Discount and full particulars upon request.*

JAMES G. BIDDLE

1024 Stephen Girard Building PHILADELPHIA



## AN "INDISPENSABLE" REFERENCE BOOK.

Vol. III. will be ready very shortly uniform with  
Vol. I. and II. SOLD ON SUBSCRIPTION ONLY.

## Cyclopedia of American Horticulture

Edited by L. H. BAILEY, Professor of Horticulture, Cornell University,  
Assisted by WILLIAM MILLER, and Many Expert Cultivators and Botanists

Vol. III.  
To be Ready very soon.  
Cloth, Royal 8vo.

"The information given is precisely  
what the horticulturist and general reader  
is desirous of knowing."

—SCIENTIFIC AMERICAN.

Vol. I. and II.  
Each \$5.00 net.

. . . . In range, treatment and editing, the Cyclo-  
pedia appears to be **emphatically useful**: . . .  
a work worthy of ranking by the side of  
the Century Dictionary."—THE NATION.

DESCRIPTIONS OF ALL THE  
SPECIES OF FRUITS, VEGETABLES,  
FLOWERS, AND ORNAMENTAL PLANTS IN THE  
MARKET IN AMERICA AND  
CANADA. DIRECTIONS FOR  
THE CULTIVATION OF ALL  
KINDS OF CROPS, OBSERVA-  
TIONS ON MARKETING, ETC.

"A mass of most valuable information, bringing together as it does, into available and properly edited form, the immense contributions of facts from horticulturists to the whole evolutionary doctrine. . . . In short, to such an one [interested in horticulture] the Cyclopedia would seem to be a *sine qua non*."—*The Dial*, Chicago.

*Before you make your garden this spring consult Professor BAILEY'S GARDEN-MAKING and AMATEUR'S PRACTICAL GARDEN BOOK—or the special books on Vegetable or Fruit Gardening in THE RURAL SCIENCE SERIES or GARDEN CRAFT SERIES—of which circulars will be sent on application to his publishers.*

The latest is by Prof. L. H. BAILEY, of Cornell University. 458 pages Illustrated. *Just Ready, \$1.25.*

## THE PRINCIPLES OF VEGETABLE GARDENING

*Rural Science Series.* The newest and completest book on the subject, and the first to state principles.

PART I.—A general view,—discusses the lay-out, glass houses, etc.,—the soil, tools, seeds, etc.

PART II.—Crops,—takes up root, tuber, bulb, cole, pot-herb, and salad crops; and beans, tomatoes, melons, corn, and others, closing with perennials, such as asparagus and rhubarb. Thorough, but practical.

BOTANY

## AN ELEMENTARY TEXT-BOOK FOR SCHOOLS

Half leather.  
Illustrated profusely.  
\$1.10 net.

By L. H. BAILEY, Professor of Horticulture, Cornell University, Editor-in-Chief of "The Cyclopedia of American Horticulture," Author of "Lessons from Plants," etc., etc.

"Should be in the hands of every student of Botany.  
. . . it is marked by a thoroughness and completeness  
that make it especially valuable."—BOSTON TRANSCRIPT.

"It would be hard to find a better manual for schools  
or for individual use."—THE OUTLOOK.  
"Thoroughly attractive."—THE NATION.

## HANDBOOK OF PRACTICAL BOTANY

FOR THE BOTANICAL LABORATORY AND PRIVATE STUDENT. By D. E. STRASBURGER, University of Bonn.  
Translated and edited by W. HILLHOUSE, University of Birmingham. \$2.60 net.

Fifth Edition  
rewritten, enlarged.  
Fully illustrated.  
Cloth. \$2.60 net.

"The whole appearance of the work is attractive. . . . Two features are impressed on every chapter of the book (1) definiteness and lucidity of statement, and (2) caution in holding the statements within defensible limits."—EVENING POST, N. Y.

THE MACMILLAN COMPANY, 66 Fifth Ave., New York

# SCIENCE

NEW SERIES.  
Vol. XIII. No. 323.

FRIDAY, MARCH 8, 1901.

SINGLE COPIES, 15 CTS.  
ANNUAL SUBSCRIPTION, \$5.00.

## QUEEN INSTRUMENTS



New  
Queen Wall Pattern  
Galvanometer

The Moving Coil in this Galvanometer is of small diameter and light weight. It can be made dead beat and will then give readings with much greater rapidity than other forms on the market. When arranged for Ballistic work the period of swing can be made as desired.

Circular 500 describes this and a number of other new instruments in detail.

PHYSICAL APPARATUS    INDUCTION COILS    ELECTRICAL TESTING INSTRUMENTS

### QUEEN & CO., Inc.

J. G. GRAY, President

ELECTRICAL AND SCIENTIFIC INSTRUMENTS

59 Fifth Avenue, New York  
480 Monon Bldg., Chicago

1010 Chestnut St., Philadelphia, Pa.

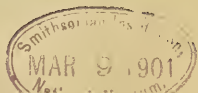

## AN "INDISPENSABLE" REFERENCE BOOK.

Vol. III. will be ready very shortly uniform with  
Vol. I. and II. SOLD ON SUBSCRIPTION ONLY.

## Cyclopedia of American Horticulture

Edited by L. H. BAILEY, Professor of Horticulture, Cornell University,  
Assisted by WILLIAM MILLER, and Many Expert Cultivators and Botanists

Vol. III.  
To be Ready very soon.  
Cloth, Royal 8vo.

"The information given is precisely  
what the horticulturist and general reader  
is desirous of knowing."

—SCIENTIFIC AMERICAN.

Vol. I. and II.  
Each \$5.00 net.

In range, treatment and editing, the Cyclo-  
pedia appears to be emphatically useful: . . .  
a work worthy of ranking by the side of  
the Century Dictionary."—THE NATION.

DESCRIPTIONS OF ALL THE  
SPECIES OF FRUITS, VEGETABLES,  
FLOWERS, AND ORNAMENTAL PLANTS IN THE  
MARKET IN AMERICA AND  
CANADA. DIRECTIONS FOR  
THE CULTIVATION OF ALL  
KINDS OF CROPS, OBSERVA-  
TIONS ON MARKETING, ETC.

"A mass of most valuable information, bringing together as it does, into available and properly edited form, the immense contributions of facts from horticulturists to the whole evolutionary doctrine. . . . In short, to such an one [interested in horticulture] the Cyclopedia would seem to be a *sine qua non*."—*The Dial*, Chicago.

Before you make your garden this spring consult Professor BAILEY'S GARDEN-MAKING and AMATEUR'S PRACTICAL GARDEN BOOK—or the special books on Vegetable or Fruit Gardening in THE RURAL SCIENCE SERIES or GARDEN CRAFT SERIES—of which circulars will be sent on application to his publishers.

The latest is by Prof. L. H. BAILEY, of Cornell University. 458 pages Illustrated. Just Ready, \$1.25.

## THE PRINCIPLES OF VEGETABLE GARDENING

*Rural Science Series.* The newest and completest book on the subject, and the first to state principles.

PART I.—A general view,—discusses the lay-out, glass houses, etc.,—the soil, tools, seeds, etc.

PART II.—Crops,—takes up root, tuber, bulb, cole, pot-herb, and salad crops; and beans, tomatoes, melons, corn, and others, closing with perennials, such as asparagus and rhubarb. Thorough, but practical.

A Circular of a practical book on VEGETABLE GARDENING will be sent on request.

## BOTANY

## AN ELEMENTARY TEXT-BOOK FOR SCHOOLS

Half leather.  
Illustrated profusely.

\$1.10 net.

By L. H. BAILEY, Professor of Horticulture, Cornell University, Editor-in-Chief of "The Cyclopedia of American Horticulture," Author of "Lessons from Plants," etc., etc.

"Should be in the hands of every student of Botany. . . . it is marked by a thoroughness and completeness that make it especially valuable.—BOSTON TRANSCRIPT.

"It would be hard to find a better manual for schools or for individual use."—THE OUTLOOK.

"Thoroughly attractive."—THE NATION.

## HANDBOOK OF PRACTICAL BOTANY

FOR THE BOTANICAL LABORATORY AND PRIVATE STUDENT. By D. E. STRASBURGER, University of Bonn. Translated and edited by W. HILLHOUSE, University of Birmingham. \$2.60 net.

Fifth Edition  
rewritten, enlarged,  
Fully illustrated.  
Cloth. \$2.60 net.

"The whole appearance of the work is attractive. . . . Two features are impressed on every chapter of the book (1) definiteness and lucidity of statement, and (2) caution in holding the statements within defensible limits."—EVENING POST, N. Y.

THE MACMILLAN COMPANY, 66 Fifth Ave., New York



# SCIENCE

NEW SERIES.  
VOL. XIII. No. 324.

FRIDAY, MARCH 15, 1901.

SINGLE COPIES, 15 CTS.  
ANNUAL SUBSCRIPTION, \$5.00

## Chemicals and Chemical Apparatus

Sole Agents for  
**Carl Schleicher & Schuell's C. P. Filterpapers**  
Schott & Genossen's Famous Jena Laboratory Glassware

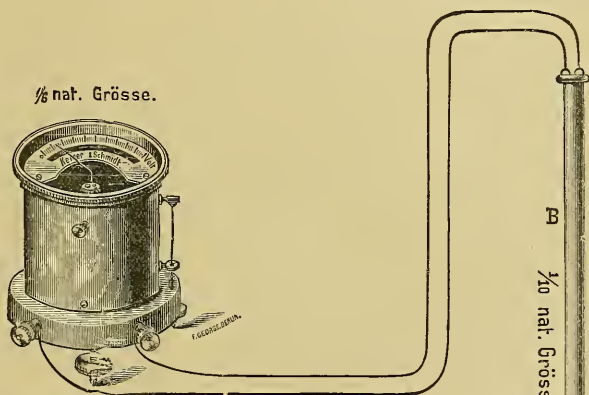

Selling Agents for  
**Royal Berlin and Royal Meissen Porcelainware**  
Des Mottis' Pure Hammered Platinumware

### NEW PLATINUM-RHODIUM PYROMETER

With German Government and Weston's Certificate  
of Correctness

Furnishing for the first time a pyrometer with *officially*  
attested corrected indications

ALL KINDS OF **HEAT TESTING INSTRUMENTS**  
For **TECHNICAL** and **SCIENTIFIC PURPOSES**

**EIMER & AMEND,** 18TH STREET and THIRD AVENUE **New York**

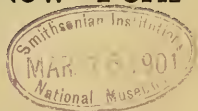

## AN "INDISPENSABLE" REFERENCE BOOK.

Vol. III. will be ready very shortly uniform with  
Vol. I. and II. SOLD ON SUBSCRIPTION ONLY.

## Cyclopedia of American Horticulture

Edited by L. H. BAILEY, Professor of Horticulture, Cornell University,  
Assisted by WILLIAM MILLER, and Many Expert Cultivators and Botanists

Vol. III.  
*To be Ready very soon.*  
Cloth, Royal 8vo.

"The information given is precisely  
what the horticulturist and general reader  
is desirous of knowing."

—SCIENTIFIC AMERICAN.

Vol. I. and II.  
Each \$5.00 net.

... In range, treatment and editing, the Cyclo-  
pedia appears to be **emphatically useful**: ...  
a work worthy of ranking by the side of  
the Century Dictionary."—THE NATION.

DESCRIPTIONS OF ALL THE  
SPECIES OF FRUITS, VEGETABLES,  
FLOWERS, AND ORNAMENTAL PLANTS IN THE  
MARKET IN AMERICA AND  
CANADA. DIRECTIONS FOR  
THE CULTIVATION OF ALL  
KINDS OF CROPS, OBSERVA-  
TIONS ON MARKETING, ETC.

"A mass of most valuable information, bringing together as it does, into available and properly edited form, the immense contributions of facts from horticulturists to the whole evolutionary doctrine. . . . In short, to such an one [interested in horticulture] the Cyclopedia would seem to be a *sine qua non*."—*The Dial*, Chicago.

*Before you make your garden this spring consult Professor BAILEY'S GARDEN-MAKING and AMATEUR'S PRACTICAL GARDEN BOOK—or the special books on Vegetable or Fruit Gardening in THE RURAL SCIENCE SERIES or GARDEN CRAFT SERIES—of which circulars will be sent on application to his publishers.*

The latest is by Prof. L. H. BAILEY, of Cornell University. 458 pages. Illustrated. *Just Ready, \$1.25.*

## THE PRINCIPLES OF VEGETABLE GARDENING

*Rural Science Series.* The newest and completest book on the subject, and the first to state principles.

PART I.—A general view,—discusses the lay-out, glass houses, etc.,—the soil, tools, seeds, etc.

PART II.—Crops,—takes up root, tuber, bulb, cole, pot-herb, and salad crops; and beans, tomatoes, melons, corn, and others, closing with perennials, such as asparagus and rhubarb. Thorough, but practical.

*A Circular of a practical book on VEGETABLE GARDENING will be sent on request.*

BOTANY

## AN ELEMENTARY TEXT-BOOK FOR SCHOOLS

Half leather. By L. H. BAILEY, Professor of Horticulture, Cornell University, Editor-in-Chief of "The Illustrated profusely. Cyclopedia of American Horticulture," Author of "Lessons from Plants," etc., etc.  
\$1.10 net.

"Should be in the hands of every student of Botany.  
... it is marked by a thoroughness and completeness  
that make it especially valuable.—BOSTON TRANSCRIPT.

"It would be hard to find a better manual for schools  
or for individual use."—THE OUTLOOK.  
"Thoroughly attractive."—THE NATION.

## HANDBOOK OF PRACTICAL BOTANY

FOR THE BOTANICAL LABORATORY AND PRIVATE STUDENT. By D. E. STRASBURGER, University of Bonn.  
Translated and edited by W. HILLHOUSE, University of Birmingham. \$2.60 net.

Fifth Edition  
rewritten, enlarged.  
Fully illustrated.  
Cloth. \$2.60 net.

"The whole appearance of the work is attractive. . . . Two features are impressed on every chapter of the book (1) definiteness and lucidity of statement, and (2) caution in holding the statements within defensible limits."—EVENING POST, N. Y.

THE MACMILLAN COMPANY, 66 Fifth Ave., New York

# SCIENCE

NEW SERIES.  
VOL. XIII. No. 325.

FRIDAY, MARCH 22, 1901.

SINGLE COPIES, 15 CTS.  
ANNUAL SUBSCRIPTION, \$5.00.

# SYNTHOL

(ABSOLUTE)

A chemically pure synthetic substitute for absolute ALCOHOL

PURER      STRONGER      MORE STABLE      CHEAPER

**S**YNTHOL may be used for every purpose for which alcohol is used, except for internal consumption. Being chemically pure it does not have as much odor as absolute alcohol from grain or wood. It is perfectly free from color, is non-irritant to eyes or skin and has from ten to fifteen per cent. more solvent power than ordinary alcohol.

## PRICES:

1 pint, net	\$ .40
1 gallon, net	2.50
1 bbl. of 50 gallons, per gallon, net,	2.25

As a killing, fixing, or hardening agent it is in every respect equal to the best absolute alcohol and can be used as a substitute for it in the preparation of stains, reagents, etc. We offer a special low price on Synthol in barrel lots FOR MUSEUM PURPOSES. As a preservative it is superior to any alcohol. Alcohol becomes tinged with color on exposure to light. Synthol retains its absolute colorlessness under all conditions. Sample supplied free to laboratories.

MANUFACTURED EXCLUSIVELY FOR

## BAUSCH & LOMB OPTICAL CO.

CHICAGO

ROCHESTER, N. Y.

NEW YORK

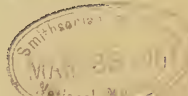

## AN "INDISPENSABLE" REFERENCE BOOK.

Vol. III. will be ready very shortly uniform with  
Vol. I. and II. SOLD ON SUBSCRIPTION ONLY.

## Cyclopedia of American Horticulture

Edited by L. H. BAILEY, Professor of Horticulture, Cornell University,  
Assisted by WILLIAM MILLER, and Many Expert Cultivators and Botanists

Vol. III.  
*To be Ready very soon.*  
Cloth, Royal 8vo.

"The information given is precisely  
what the horticulturist and general reader  
is desirous of knowing."

—SCIENTIFIC AMERICAN.

Vol. I. and II.  
Each \$5.00 net.

... In range, treatment and editing, the Cyclo-  
pedia appears to be **emphatically useful**: . . .  
a work worthy of ranking by the side of  
the Century Dictionary."—THE NATION.

DESCRIPTIONS OF ALL THE  
SPECIES OF FRUITS, VEGETABLES,  
FLOWERS, AND ORNAMENTAL PLANTS IN THE  
MARKET IN AMERICA AND  
CANADA. DIRECTIONS FOR  
THE CULTIVATION OF ALL  
KINDS OF CROPS, OBSER-  
VATIONS ON MARKETING, ETC.

"A mass of most valuable information, bringing together as it does, into available and properly edited form, the immense contributions of facts from horticulturists to the whole evolutionary doctrine. . . . In short, to such an one [interested in horticulture] the Cyclopedia would seem to be a *sine qua non*."—*The Dial*, Chicago.

*Before you make your garden this spring consult Professor BAILEY'S GARDEN-MAKING and AMATEUR'S PRACTICAL GARDEN BOOK—or the special books on Vegetable or Fruit Gardening in THE RURAL SCIENCE SERIES or GARDEN CRAFT SERIES—of which circulars will be sent on application to his publishers.*

The latest is by Prof. L. H. BAILEY, of Cornell University. 458 pages. Illustrated. *Just Ready*, \$1.25.

## THE PRINCIPLES OF VEGETABLE GARDENING

*Rural Science Series.* The newest and completest book on the subject, and the first to state principles.

PART I.—A general view,—discusses the lay-out, glass houses, etc.,—the soil, tools, seeds, etc.

PART II.—Crops,—takes up root, tuber, bulb, cole, pot-herb, and salad crops; and beans, tomatoes, melons, corn, and others, closing with perennials, such as asparagus and rhubarb. Thorough, but practical.

*A Circular of a practical book on VEGETABLE GARDENING will be sent on request.*

**BOTANY**

## AN ELEMENTARY TEXT-BOOK FOR SCHOOLS

Half leather.  
Illustrated profusely.  
\$1.10 net.

By L. H. BAILEY, Professor of Horticulture, Cornell University, Editor-in-Chief of "The Cyclopedia of American Horticulture," Author of "Lessons from Plants," etc., etc.

"Should be in the hands of every student of Botany.  
. . . it is marked by a thoroughness and completeness  
that make it especially valuable.—BOSTON TRANSCRIPT.

"It would be hard to find a better manual for schools  
or for individual use."—THE OUTLOOK.

"Thoroughly attractive."—THE NATION.

## HANDBOOK OF PRACTICAL BOTANY

FOR THE BOTANICAL LABORATORY AND PRIVATE STUDENT. By D. E. STRASBURGER, University of Bonn.  
Translated and edited by W. HILLHOUSE, University of Birmingham. \$2.60 net.

Fifth Edition  
rewritten, enlarged.  
Fully illustrated.  
Cloth. \$2.60 net.

"The whole appearance of the work is attractive . . . Two features are impressed on every chapter of the book (1) definiteness and lucidity of statement, and (2) caution in holding the statements within defensible limits."—EVENING POST, N. Y.

THE MACMILLAN COMPANY, 66 Fifth Ave., New York

# SCIENCE

NEW SERIES.  
VOL. XIII. No. 326.

FRIDAY, MARCH 29, 1901.

SINGLE COPIES, 15 CTS.  
ANNUAL SUBSCRIPTION, \$5.00.

Estate  
GUSTAV E. STECHERT

**G. E. STECHERT**

ALFRED HAFNER

9 East 16th Street, New York

**BOOKS and PERIODICALS**      **NEW and SECOND-HAND**

*SUBSCRIPTIONS TAKEN FOR ALL PERIODICALS.*

**WHOLE LIBRARIES OR SMALL LOTS OF BOOKS PURCHASED**

**Large Stock of Complete Sets of Scientific Periodicals.**

*SEND FOR CATALOGUE.*

*MONTHLY LIST of new publications in various languages sent to customers gratis upon request.*

All important German and French books on hand as soon as published. Books in any language not in stock, imported at shortest notice either in our regular weekly shipments or if necessary by post.

**ATTENTION IS DIRECTED TO THE FOLLOWING RECENT PUBLICATIONS:**

- KOENIG, Dr. J., Die Verunreinigung der Gewaesser, deren schaedliche Folgen sowie die Reinigung von Trink und Schmutzwasser, 2 vols. with 256 illustrations and 7 lithographic plates, bound in cloth, 1899. \$7.10**
- TSCHIRCH, A., Die Harze und die Harzbehalter. Historisch-Kritische und Experimentelle in Gemeinschaft mit Zahlreichen Mitarbeitern Ausgefuehrte Untersuchungen. With 6 plates, 1900. ½ mor. \$5.00**
- WEBER, HEINRICH, Die Partiellen Differential-Gleichungen der Mathematischen Physik. Nach Riemann's Vorlesungen. Vol. I., 1900. ¼ mor. \$2.90**
- WEINSTEIN, Prof. Dr. B., Thermodynamik und Kinetik der Koeper. Vol. I.: Allgemeine Thermodynamik und Kinetik und Theorie der Idealen und Wirklichen Gase und Daempfe. 1901. ½ mor. \$3.60**
- VIVAREZ, H., Les Phénomènes Électriques et Leurs Applications ; Étude historique technique et économique des Transformations de l'Énergie électrique. 1901. Cloth, net, \$3.00**
- BINET, Alfred, La Suggestibilité. With 32 illustrations and 2 plates. 1900. Cloth, net, \$2.40 (A volume of the Bibliothèque de Pédagogie et de Psychologie.)**

We have on hand among other sets of periodicals the following which are extremely rare:

**LONDON, EDINBURGH & DUBLIN PHILOSOPHICAL MAGAZINE** from its commencement in 1798 to 1900, 216 vols. newly bound in ½ green morocco, uniform, \$875.

**THE QUARTERLY JOURNAL OF MICROSCOPICAL SCIENCE** edited by Lankester, Busk, Dyer, Klein, Moseley and Sedgwick. First Series 3 vols. and New Series 29 vols. London 1853-1889, 37 vols. in uniform ½ calf binding, \$325.

The years from 1890 to date can all be obtained new from the publishers and we can complete the set as far as it should be wanted.

**ANNALS AND MAGAZINE OF NATURAL HISTORY** consisting of the **MAGAZINE OF ZOOLOGY AND BOTANY**, edited by Jardine, Selden & Johnston, 2 vols. 1837-38, and **ANNALS AND MAGAZINE OF NATURAL HISTORY** edited by Jardine, Selby & Hooker, Series 1-5 and Series 6, vols. 1-4, complete from beginning 1838 to 1889, together 106 vols. in uniform ½ morocco binding, \$300.

Any of the years from 1890 to date can be supplied promptly in the same binding.

We shall shortly issue a catalogue of our large stock of second-hand books on Natural History, including Astronomy, Geology, Mathematics, etc. If you are not already receiving our catalogues please to send us your name that we may send you the above catalogue as soon as it is ready.

**G. E. STECHERT, 9 East 16th St., New York**

## AN "INDISPENSABLE" REFERENCE BOOK.

Vol. III. will be ready very shortly uniform with  
Vol. I. and II. SOLD ON SUBSCRIPTION ONLY.

## Cyclopedia of American Horticulture

Edited by L. H. BAILEY, Professor of Horticulture, Cornell University,  
Assisted by WILLIAM MILLER, and Many Expert Cultivators and Botanists

Vol. III.  
*To be Ready very soon.*  
Cloth, Royal 8vo.

"The information given is precisely  
what the horticulturist and general reader  
is desirous of knowing."

—SCIENTIFIC AMERICAN.

Vol. I. and II.  
Each \$5.00 net.

... In range, treatment and editing, the Cyclo-  
pedia appears to be **emphatically useful**: . . .  
a work worthy of ranking by the side of  
the Century Dictionary."—THE NATION.

DESCRIPTIONS OF ALL THE  
SPECIES OF FRUITS, VEGETABLES,  
FLOWERS, AND ORNAMENTAL PLANTS IN THE  
MARKET IN AMERICA AND  
CANADA. DIRECTIONS FOR  
THE CULTIVATION OF ALL  
KINDS OF CROPS, OBSERVA-  
TIONS ON MARKETING, ETC.

"A mass of most valuable information, bringing together as it does, into available and properly edited form, the immense contributions of facts from horticulturists to the whole evolutionary doctrine. . . . In short, to such an one [interested in horticulture] the Cyclopedia would seem to be a *sine qua non*."—*The Dial*, Chicago.

*Before you make your garden this spring consult Professor BAILEY'S GARDEN-MAKING and AMATEUR'S PRACTICAL GARDEN BOOK—or the special books on Vegetable or Fruit Gardening in THE RURAL SCIENCE SERIES or GARDEN CRAFT SERIES—of which circulars will be sent on application to his publishers.*

The latest is by Prof. L. H. BAILEY, of Cornell University. 458 pages. Illustrated. *Just Ready*, \$1.25.

## THE PRINCIPLES OF VEGETABLE GARDENING

*Rural Science Series.* The newest and completest book on the subject, and the first to state principles.

PART I.—A general view,—discusses the lay-out, glass houses, etc.,—the soil, tools, seeds, etc.

PART II.—Crops,—takes up root, tuber, bulb, cole, pot-herb, and salad crops; and beans, tomatoes, melons, corn, and others, closing with perennials, such as asparagus and rhubarb. Thorough, but practical.

*A Circular of this practical book on VEGETABLE GARDENING will be sent on request.*

**BOTANY**

## AN ELEMENTARY TEXT-BOOK FOR SCHOOLS

Half leather.  
Illustrated profusely.  
\$1.10 net.

By L. H. BAILEY, Professor of Horticulture, Cornell University, Editor-in-Chief of "The Cyclopedia of American Horticulture," Author of "Lessons from Plants," etc., etc.

"Should be in the hands of every student of Botany.  
. . . it is marked by a thoroughness and completeness  
that make it especially valuable."—BOSTON TRANSCRIPT.

"It would be hard to find a better manual for schools  
or for individual use."—THE OUTLOOK.

"Thoroughly attractive."—THE NATION.

## HANDBOOK OF PRACTICAL BOTANY

FOR THE BOTANICAL LABORATORY AND PRIVATE STUDENT. By D. E. STRASBURGER, University of Bonn.  
Translated and edited by W. HILLHOUSE, University of Birmingham. \$2.60 net.

Fifth Edition  
rewritten, enlarged.  
Fully illustrated.  
Cloth. \$2.60 net.

"The whole appearance of the work is attractive. . . . Two features are impressed on every chapter of the book (1) definiteness and lucidity of statement, and (2) caution in holding the statements within defensible limits."—EVENING POST, N. Y.

THE MACMILLAN COMPANY, 66 Fifth Ave., New York

# SCIENCE

NEW SERIES.  
VOL. XIII. No. 327.

FRIDAY, APRIL 5, 1901.

SINGLE COPIES, 15 CTS.  
ANNUAL SUBSCRIPTION, \$5.00.

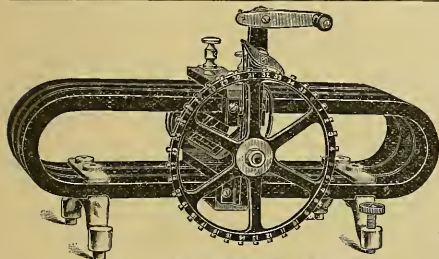

"DYNAMO ANALYSIS APPARATUS."

## WM. GAERTNER & CO.

Astronomical and  
Physical Apparatus

5347 and 5349 LAKE AVE., CHICAGO

### SPECIALTIES

Standard Apparatus of New and Improved Designs  
Reading Microscopes and Telescopes  
Astronomical Telescopes Dividing Engines  
Spectroscopes Comparators  
Michelson Interferometers General Laboratory Apparatus  
Bolometers Heliostats  
Universal Laboratory Supports

## THE TEMPLE CYCLOPÆDIC PRIMERS

Scientific Volumes.

### SCIENCE

Cloth, 18mo, 40 Cents *net* Each.

#### THE HUMAN FRAME AND THE LAWS OF HEALTH

By Drs. REBMANN and SEILER, Professors in the University of Lausanne. Translated from the German by F. W. KEEBLE.

*Illustrated.*

"Logical and concise . . . Cannot but be useful."—*JOUR. OF EDUC.*

#### AN INTRODUCTION TO SCIENCE

By Dr. ALEXANDER HILL, Cambridge University. *Illustrated.*

"Distinctly the best thing of its kind which has recently appeared."

—*HARTFORD COURANT.*

#### THE CHILD: HIS NATURE AND NURTURE. By W. B. DRUMMOND. With Frontispiece.

#### THE RACES OF MANKIND

By Dr. MICHAEL HABERLANDT, Curator of the Ethnological Museum, Vienna. *Illustrated.*

"Wonderfully concise, but none the less interesting."—*BOSTON TRANSCRIPT.*

#### PLANT LIFE AND STRUCTURE

By Dr. E. DENNERT. *Illustrated.*

THE MACMILLAN COMPANY, 66 Fifth Ave., New York

## PHYSIOGRAPHICAL MODELS.

physical geography or geology.

We issue a series of models and photographs, gotten up by Professors Shaler, Davis, and Harris, which are equally effective for illustrations of

*Write for Illustrated Circular.*

The best thing on the market !

WARD'S NATURAL SCIENCE ESTABLISHMENT, 30 to 40 College Ave., Rochester, N.Y.

1901 Type  
Induction Coils  
made by  
Leeds & Co.

These new style Induction Coils give a heavy secondary discharge and are fully guaranteed.

Each one is equipped with adjustable condenser, independent variable speed vibrator, interlocking reversing switch and fuse block.

For X-Ray Work and for Laboratory Experiments our apparatus is widely used and highly endorsed.

*Prices and further particulars upon request.*

JAMES G. BIDDLE

Sole Agent for Leeds & Co.

1024 Stephen Girard Building PHILADELPHIA

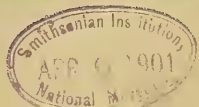

## AN "INDISPENSABLE" REFERENCE BOOK.

Vol. III. will be ready very shortly uniform with  
Vol. I. and II. SOLD ON SUBSCRIPTION ONLY.

## Cyclopedia of American Horticulture

Edited by L. H. BAILEY, Professor of Horticulture, Cornell University,  
Assisted by WILLIAM MILLER, and Many Expert Cultivators and Botanists.

Vol. III.  
*To be Ready very soon.*  
Cloth, Royal 8vo.

"The information given is precisely  
what the horticulturist and general reader  
is desirous of knowing."

—SCIENTIFIC AMERICAN.

Vol. I. and II.  
Each \$5.00 net.

... In range, treatment and editing, the Cyclo-  
pedia appears to be **emphatically useful**: . . .  
a work worthy of ranking by the side of  
the Century Dictionary."—THE NATION.

DESCRIPTIONS OF ALL THE  
SPECIES OF FRUITS, VEGE-  
TABLES, FLOWERS, AND ORN-  
AMENTAL PLANTS IN THE  
MARKET IN AMERICA AND  
CANADA. DIRECTIONS FOR  
THE CULTIVATION OF ALL  
KINDS OF CROPS, OBSERVA-  
TIONS ON MARKETING, ETC.

"A mass of most valuable information, bringing together as it does, into available and properly edited form, the immense contributions of facts from horticulturists to the whole evolutionary doctrine. . . . In short, to such an one [interested in horticulture] the Cyclopedia would seem to be a *sine qua non*."—*The Dial*, Chicago.

*Before you make your garden this spring consult Professor BAILEY'S GARDEN-MAKING and AMATEUR'S PRACTICAL GARDEN BOOK—or the special books on Vegetable or Fruit Gardening in THE RURAL SCIENCE SERIES or GARDEN CRAFT SERIES—of which circulars will be sent on application to his publishers.*

The latest is by Prof. L. H. BAILEY, of Cornell University. 458 pages. Illustrated. *Just Ready, \$1.25.*

## THE PRINCIPLES OF VEGETABLE GARDENING

*Rural Science Series.* The newest and completest book on the subject, and the first to state principles.

PART I.—A general view,—discusses the lay-out, glass houses, etc.,—the soil, tools, seeds, etc.

PART II.—Crops,—takes up root, tuber, bulb, cole, pot-herb, and salad crops; and beans, tomatoes, melons, corn, and others, closing with perennials, such as asparagus and rhubarb. Thorough, but practical.

*A Circular of this practical book on VEGETABLE GARDENING will be sent on request.*

**BOTANY**

## AN ELEMENTARY TEXT-BOOK FOR SCHOOLS

Half leather.  
Illustrated profusely.  
\$1.10 net.

By L. H. BAILEY, Professor of Horticulture, Cornell University, Editor-in-Chief of "The Cyclopedia of American Horticulture," Author of "Lessons from Plants," etc., etc.

"Should be in the hands of every student of Botany.  
. . . it is marked by a thoroughness and completeness  
that make it especially valuable.—BOSTON TRANSCRIPT.

"It would be hard to find a better manual for schools  
or for individual use."—THE OUTLOOK.

"Thoroughly attractive."—THE NATION.

## HANDBOOK OF PRACTICAL BOTANY

FOR THE BOTANICAL LABORATORY AND PRIVATE STUDENT. By D. E. STRASBURGER, University of Bonn.

Translated and edited by W. HILLHOUSE, University of Birmingham. \$2.60 net.

Fifth Edition  
rewritten, enlarged.  
Fully illustrated.  
Cloth. \$2.60 net.

"The whole appearance of the work is attractive. . . . Two features are impressed on every chapter of the book (1) definiteness and lucidity of statement, and (2) caution in holding the statements within defensible limits."—EVENING POST, N. Y.

THE MACMILLAN COMPANY, 66 Fifth Ave., New York



# SCIENCE

NEW SERIES.  
VOL. XIII. No. 328.

FRIDAY, APRIL 12, 1901.

SINGLE COPIES, 15 CTS.  
ANNUAL SUBSCRIPTION, \$5.00.

## QUEEN INSTRUMENTS

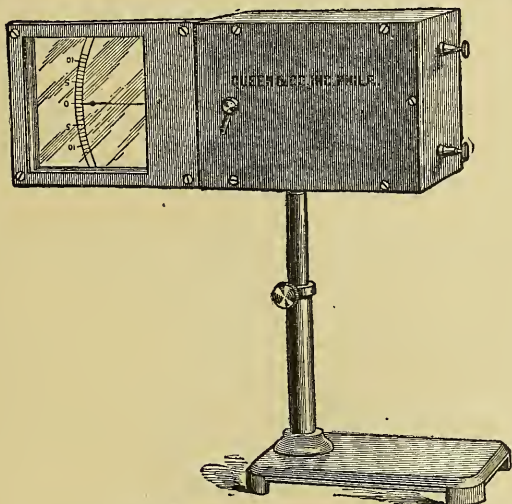

QUEEN PROJECTION GALVANOMETER

An Instrument designed for **Lecture Table** and **Lantern Work**. Scale frame fits the ordinary projection Lantern and deflections can be shown on screen.

The **Galvanometer** is of the **D'Arsonval** type, sufficiently sensitive to show **Induction** and **Thermo** effects. The current produced by one volt through 500,000 ohms will produce a deflection of one scale division. Resistance about 600 ohms. With key (not shown in cut) mounted on Galvanometer the motion is dead-beat.

**PHOTOMETERS—INDUCTION COILS—PHYSICAL APPARATUS**

Apparatus Imported from any Foreign Maker

## QUEEN & CO., Inc.

J. G. GRAY, President

**ELECTRICAL AND SCIENTIFIC INSTRUMENTS**

59 Fifth Avenue, New York  
480 Monon Bldg., Chicago

1010 Chestnut St., Philadelphia, Pa.

## AN "INDISPENSABLE" REFERENCE BOOK.

Vol. III. will be ready very shortly uniform with  
Vol. I. and II. SOLD ON SUBSCRIPTION ONLY.

## Cyclopedia of American Horticulture

Edited by L. H. BAILEY, Professor of Horticulture, Cornell University,  
Assisted by WILLIAM MILLER, and Many Expert Cultivators and Botanists.

## Vol. III.

To be Ready very soon.  
Cloth, Royal 8vo.

"The information given is precisely  
what the horticulturist and general reader  
is desirous of knowing."

—SCIENTIFIC AMERICAN.

## Vol. I. and II.

Each \$5.00 net.

. . . In range, treatment and editing, the Cyclo-  
pedia appears to be emphatically useful: . . .  
a work worthy of ranking by the side of  
the Century Dictionary."—THE NATION.

DESCRIPTIONS OF ALL THE  
SPECIES OF FRUITS, VEGETABLES,  
FLOWERS, AND ORNAMENTAL PLANTS IN THE  
MARKET IN AMERICA AND  
CANADA. DIRECTIONS FOR  
THE CULTIVATION OF ALL  
KINDS OF CROPS, OBSERVA-  
TIONS ON MARKETING, ETC.

"A mass of most valuable information, bringing together as it does, into available and properly edited form, the immense contributions of facts from horticulturists to the whole evolutionary doctrine. . . . In short, to such an one [interested in horticulture] the Cyclopedia would seem to be a *sine qua non*."—*The Dial*, Chicago.

Before you make your garden this spring consult Professor BAILEY'S GARDEN-MAKING and AMATEUR'S PRACTICAL GARDEN BOOK—or the special books on Vegetable or Fruit Gardening in THE RURAL SCIENCE SERIES or GARDEN CRAFT SERIES—of which circulars will be sent on application to his publishers.

The latest is by Prof. L. H. BAILEY, of Cornell University. 458 pages. Illustrated. Just Ready, \$1.25.

## THE PRINCIPLES OF VEGETABLE GARDENING

*Rural Science Series.* The newest and completest book on the subject, and the first to state principles.

PART I.—A general view,—discusses the lay-out, glass houses, etc.,—the soil, tools, seeds, etc.

PART II.—Crops,—takes up root, tuber, bulb, cole, pot-herb, and salad crops; and beans, tomatoes, melons, corn, and others, closing with perennials, such as asparagus and rhubarb. Thorough, but practical.

A Circular of this practical book on VEGETABLE GARDENING will be sent on request.

BOTANY

## AN ELEMENTARY TEXT-BOOK FOR SCHOOLS

Half leather.  
Illustrated profusely.  
\$1.10 net.

By L. H. BAILEY, Professor of Horticulture, Cornell University, Editor-in-Chief of "The Cyclopedia of American Horticulture," Author of "Lessons from Plants," etc., etc.

"Should be in the hands of every student of Botany. . . . it is marked by a thoroughness and completeness that make it especially valuable."—BOSTON TRANSCRIPT.

"It would be hard to find a better manual for schools or for individual use."—THE OUTLOOK.

"Thoroughly attractive."—THE NATION.

## HANDBOOK OF PRACTICAL BOTANY

FOR THE BOTANICAL LABORATORY AND PRIVATE STUDENT. By D. E. STRASBURGER, University of Bonn. Translated and edited by W. HILLHOUSE, University of Birmingham. \$2.60 net.

Fifth Edition  
rewritten, enlarged.  
Fully illustrated.  
Cloth. \$2.60 net.

"The whole appearance of the work is attractive. . . . Two features are impressed on every chapter of the book (1) definiteness and lucidity of statement, and (2) caution in holding the statements within defensible limits."—EVENING POST, N. Y.

THE MACMILLAN COMPANY, 66 Fifth Ave., New York

# SCIENCE

NEW SERIES.  
VOL. XIII. No. 329.

FRIDAY, APRIL 19, 1901.

SINGLE COPIES, 15 CTS.  
ANNUAL SUBSCRIPTION, \$5.00.

## Chemicals and Chemical Apparatus

Sole Agents for  
Max Kohl's World-Renowned Physical Apparatus  
Franz Schmidt & Haensch' Polariscopes, etc.  
Carl Schleicher & Schull's C. P. Filterpapers

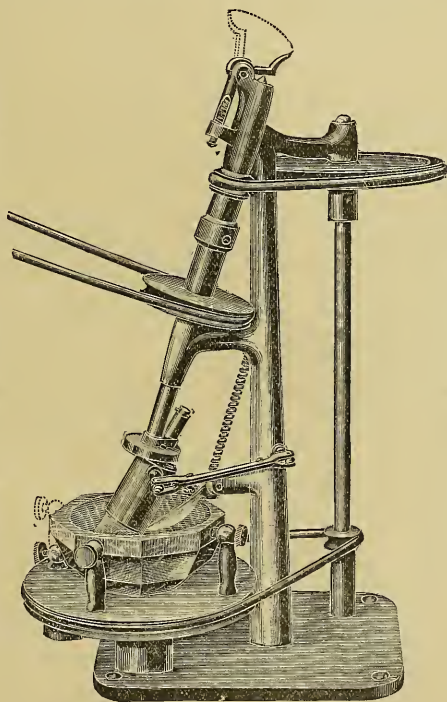

Sole Agents for  
Schott & Gen. Jena Laboratory Glassware  
The very best Glass for Laboratory use.  
Kahlbaum's C. P. Chemicals and Reagents  
Kavalier's Bohemian, Greiner & Friedrich's German Glassware,  
CARL ZEISS' MICROSCOPES, ETC.

## NEW AUTOMATIC AGATE MORTAR GRINDER

Very useful and practical for Grinding Minerals, Chemicals, etc., to finest powder for Analytical purposes.

EIMER & AMEND, 18TH STREET and  
THIRD AVENUE New York

## AN "INDISPENSABLE" REFERENCE BOOK.

Vol. III. will be ready very shortly uniform with  
Vol. I. and II. SOLD ON SUBSCRIPTION ONLY.

## Cyclopedia of American Horticulture

Edited by L. H. BAILEY, Professor of Horticulture, Cornell University,  
Assisted by WILLIAM MILLER, and Many Expert Cultivators and Botanists.

Vol. III.  
To be Ready very soon.  
Cloth, Royal 8vo.

"The information given is precisely  
what the horticulturist and general reader  
is desirous of knowing."  
—SCIENTIFIC AMERICAN.

Vol. I. and II.  
Each \$5.00 net.

. . . In range, treatment and editing, the Cyclo-  
pedia appears to be **emphatically useful**: . . .  
a work worthy of ranking by the side of  
the Century Dictionary."—THE NATION.

DESCRIPTIONS OF ALL THE  
SPECIES OF FRUITS, VEGET-  
TABLES, FLOWERS, AND OR-  
NAMENTAL PLANTS IN THE  
MARKET IN AMERICA AND  
CANADA. DIRECTIONS FOR  
THE CULTIVATION OF ALL  
KINDS OF CROPS, OBSERVA-  
TIONS ON MARKETING, ETC.

"A mass of most valuable information, bringing together as it does, into available and properly edited form, the immense contributions of facts from horticulturists to the whole evolutionary doctrine. . . . In short, to such an one [interested in horticulture] the Cyclopedia would seem to be a *sine qua non*."—*The Dial*, Chicago.

Before you make your garden this spring consult Professor BAILEY'S GAR-  
DEN-MAKING and AMATEUR'S PRACTICAL GARDEN BOOK—or the special books on  
Vegetable or Fruit Gardening in THE RURAL SCIENCE SERIES or GARDEN  
CRAFT SERIES—of which circulars will be sent on application to his publishers.

The latest is by Prof. L. H. BAILEY, of Cornell University: 458 pages. Illustrated. Just Ready, \$1.25.

## THE PRINCIPLES OF VEGETABLE GARDENING

*Rural Science Series.* The newest and completest book on the subject, and the first to state principles.

PART I.—A general view,—discusses the lay-out, glass houses, etc.,—the soil, tools, seeds, etc.

PART II.—Crops,—takes up root, tuber, bulb, cole, pot-herb, and salad crops; and beans, tomatoes, melons,  
corn, and others, closing with perennials, such as asparagus and rhubarb. Thorough, but practical.

A Circular of this practical book on VEGETABLE GARDENING will be sent on request.

BOTANY

## AN ELEMENTARY TEXT-BOOK FOR SCHOOLS

Half leather.  
Illustrated profusely.  
\$1.10 net.

By L. H. BAILEY, Professor of Horticulture, Cornell University, Editor-in-Chief of "The  
Cyclopedia of American Horticulture," Author of "Lessons from Plants," etc., etc.

"Should be in the hands of every student of Botany.  
. . . it is marked by a thoroughness and completeness  
that make it especially valuable."—BOSTON TRANSCRIPT.

"It would be hard to find a better manual for schools  
or for individual use."—THE OUTLOOK.  
"Thoroughly attractive."—THE NATION.

## HANDBOOK OF PRACTICAL BOTANY

FOR THE BOTANICAL LABORATORY AND PRIVATE STUDENT. By D. E. STREASBURGER, University of Bonn.  
Translated and edited by W. HILLHOUSE, University of Birmingham. \$2.60 net.

Fifth Edition  
rewritten, enlarged.  
Fully illustrated.  
Cloth. \$2.60 net.

"The whole appearance of the work is attractive. . . . Two features are impressed on  
every chapter of the book (1) definiteness and lucidity of statement, and (2) cau-  
tion in holding the statements within defensible limits."—EVENING POST, N. Y.

THE MACMILLAN COMPANY, 66 Fifth Ave., New York

# SCIENCE

NEW SERIES.  
VOL. XIII. No. 330.

FRIDAY, APRIL 26, 1901.

SINGLE COPIES, 15 CTS.  
ANNUAL SUBSCRIPTION, \$5.00.

# SYNTHOL

(ABSOLUTE)

A chemically pure synthetic substitute for absolute ALCOHOL. ❁❁

PURER      STRONGER      MORE STABLE      CHEAPER

**S**YNTHOL may be used for every purpose for which alcohol is used, except for internal consumption. Being chemically pure it does not have as much odor as absolute alcohol from grain or wood. It is perfectly free from color, is non-irritant to eyes or skin and has from ten to fifteen per cent. more solvent power than ordinary alcohol.

### PRICES :

1 pint, net . . . . .	\$ .40
1 gallon, net . . . . .	2.50
1 bbl. of 50 gallons, per gallon, net,	2.25

As a killing, fixing, or hardening agent it is in every respect equal to the best absolute alcohol and can be used as a substitute for it in the preparation of stains, reagents, etc. We offer a special low price on Synthol in barrel lots FOR MUSEUM PURPOSES. As a preservative it is superior to any alcohol. Alcohol becomes tinged with color on exposure to light. Synthol retains its absolute colorlessness under all conditions. Sample supplied free to laboratories. . . . .

MANUFACTURED EXCLUSIVELY FOR

## BAUSCH & LOMB OPTICAL CO.

CHICAGO

ROCHESTER, N. Y.

NEW YORK

## AN "INDISPENSABLE" REFERENCE BOOK.

Vol. III. will be ready very shortly uniform with  
Vol. I. and II. SOLD ON SUBSCRIPTION ONLY.

## Cyclopedia of American Horticulture

Edited by L. H. BAILEY, Professor of Horticulture, Cornell University,  
Assisted by WILLIAM MILLER, and Many Expert Cultivators and Botanists.

Vol. III.  
To be Ready very soon.  
Cloth, Royal 8vo.

"The information given is precisely  
what the horticulturist and general reader  
is desirous of knowing."

—SCIENTIFIC AMERICAN.

Vol. I. and II.  
Each \$5.00 net.

. . . In range, treatment and editing, the Cyclo-  
pedia appears to be emphatically useful: . . .  
a work worthy of ranking by the side of  
the Century Dictionary."—THE NATION.

DESCRIPTIONS OF ALL THE  
SPECIES OF FRUITS, VEGETABLES,  
FLOWERS, AND ORNAMENTAL PLANTS IN THE  
MARKET IN AMERICA AND  
CANADA. DIRECTIONS FOR  
THE CULTIVATION OF ALL  
KINDS OF CROPS, OBSERVA-  
TIONS ON MARKETING, ETC.

"A mass of most valuable information, bringing together as it does, into available and properly edited form, the immense contributions of facts from horticulturists to the whole evolutionary doctrine. . . . In short, to such an one [interested in horticulture] the Cyclopedia would seem to be a *sine qua non*."—*The Dial*, Chicago.

Before you make your garden this spring consult Professor BAILEY'S GARDEN-MAKING and AMATEUR'S PRACTICAL GARDEN BOOK—or the special books on Vegetable or Fruit Gardening in THE RURAL SCIENCE SERIES or GARDEN CRAFT SERIES—of which circulars will be sent on application to his publishers.

The latest is by Prof. L. H. BAILEY, of Cornell University. 458 pages. Illustrated. Just Ready, \$1.25.

## THE PRINCIPLES OF VEGETABLE GARDENING

*Rural Science Series.* The newest and completest book on the subject, and the first to state principles.

PART I.—A general view,—discusses the lay-out, glass houses, etc.,—the soil, tools, seeds, etc.

PART II.—Crops,—takes up root, tuber, bulb, cole, pot-herb, and salad crops; and beans, tomatoes, melons, corn, and others, closing with perennials, such as asparagus and rhubarb. Thorough, but practical.

A Circular of this practical book on **VEGETABLE GARDENING** will be sent on request.

**BOTANY**

## AN ELEMENTARY TEXT-BOOK FOR SCHOOLS

Half leather.  
Illustrated profusely.  
\$1.10 net.

By L. H. BAILEY, Professor of Horticulture, Cornell University, Editor-in-Chief of "The Cyclopedia of American Horticulture," Author of "Lessons from Plants," etc., etc.

"Should be in the hands of every student of Botany. . . . it is marked by a thoroughness and completeness that make it especially valuable."—BOSTON TRANSCRIPT.

"It would be hard to find a better manual for schools or for individual use."—THE OUTLOOK.

"Thoroughly attractive."—THE NATION.

## HANDBOOK OF PRACTICAL BOTANY

FOR THE BOTANICAL LABORATORY AND PRIVATE STUDENT. By D. E. STRASBURGER, University of Bonn.  
Translated and edited by W. HILLHOUSE, University of Birmingham. \$2.60 net.

Fifth Edition  
rewritten, enlarged.  
Fully illustrated.  
Cloth. \$2.60 net.

"The whole appearance of the work is attractive. . . . Two features are impressed on every chapter of the book (1) definiteness and lucidity of statement, and (2) caution in holding the statements within defensible limits."—EVENING POST, N. Y.

THE MACMILLAN COMPANY, 66 Fifth Ave., New York

# SCIENCE

NEW SERIES.  
VOL. XIII. No. 331.

FRIDAY, MAY 3, 1901.

SINGLE COPIES, 15 CTS.  
ANNUAL SUBSCRIPTION, \$5.00.

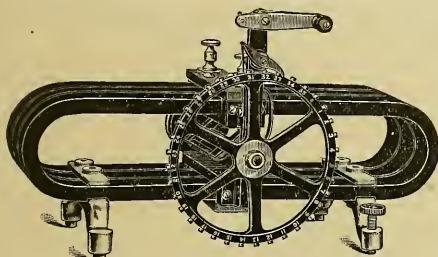

"DYNAMO ANALYSIS APPARATUS."

**WM. GAERTNER & CO.**  
Astronomical and  
Physical Apparatus  
5347 and 5349 LAKE AVE., CHICAGO

### SPECIALTIES

Standard Apparatus of New and Improved Designs  
Reading Microscopes and Telescopes  
Astronomical Telescopes      Dividing Engines  
Spectroscopes                  Comparators  
Michelson Interferometers      General Laboratory Apparatus  
Bolometers                      Heliostats  
Universal Laboratory Supports

## THE TEMPLE CYCLOPÆDIC PRIMERS

Scientific Volumes.

SCIENCE

Cloth, 18mo, 40 Cents net Each.

### THE HUMAN FRAME AND THE LAWS OF HEALTH

By Drs. REBMAN and SEILER, Professors in the University of Lausanne. Translated from the German by F. W. KEEBLE.

*Illustrated.*

"Logical and concise but be useful."—*JOUR. OF EDUC.*      Cannot

### AN INTRODUCTION TO SCIENCE

By Dr. ALEXANDER HILL, Cambridge University. *Illustrated.*

"Distinctly the best thing of its kind which has recently appeared."

—HARTFORD COURANT.

### THE CHILD: HIS NATURE AND NURTURE.

By W. B. DRUMMOND. *With Frontispiece.*

### THE RACES OF MANKIND

By Dr. MICHAEL HABERLANDT, Curator of the Ethnological Museum, Vienna. *Illustrated.*

"Wonderfully concise, but none the less interesting."—*BOSTON TRANSCRIPT.*

### PLANT LIFE AND STRUCTURE

By Dr. E. DENNERT. *Illustrated.*

**THE MACMILLAN COMPANY, 66 Fifth Ave., New York**

## PHYSIOGRAPHICAL MODELS,

physical geography or geology.

We issue a series of models and photographs, gotten up by Professors Shaler, Davis, and Harris, which are equally effective for illustrations of

*Write for Illustrated Circular.*

The best thing on the market!

**WARD'S NATURAL SCIENCE ESTABLISHMENT, 30 to 40 College Ave., Rochester, N.Y.**

1901 Type  
Induction Coils  
made by  
Leeds & Co.

These new style Induction Coils give a heavy secondary discharge and are fully guaranteed.

Each one is equipped with adjustable condenser, independent variable speed vibrator, interlocking reversing switch and fuse block.

For X-Ray Work and for Laboratory Experiments our apparatus is widely used and highly endorsed.

*Prices and further particulars upon request.*

**JAMES G. BIDDLE**

Sole Agent for Leeds & Co.

1024 Stephen Girard Building      PHILADELPHIA

A GREAT WORK NEARING COMPLETION.

# Cyclopedia of American Horticulture

EDITED BY L. H. BAILEY

ASSISTED BY

WILLIAM MILLER and many expert  
Cultivators and Botanists

---

Volumes I., II. and III. are now ready, and Volume IV., completing the work,  
is in press and will be published soon.

---

In this great Cyclopedia will be found a complete description of all species of fruits, vegetables, flowers and ornamental plants in America. Directions for the cultivation of all kinds of crops, observations on marketing, etc.

---

## Opinions of the Work.

"We do not hesitate to commend this work to our readers, whether fruit-growers, gardeners, gentlemen of leisure or of whatever profession, for it contains such information as it will take scores of books to give, and cannot fail to both interest and instruct every reader."  
—*Canadian Horticulturist.*

"The information is precisely what the horticulturist and general reader is desirous of knowing."  
—*Scientific American.*

"In range, treatment and editing emphatically useful—worthy of ranking by the side of the Century Dictionary."  
—*The Nation.*

"As showing the earnest endeavor to be quite up to date, the very complete note on Horticulture in the Hawaiian Islands may be cited; half a page and over is devoted to this item.

"Grapes, American and European, grafting, the history and principle of greenhouse construction, forcing of fruits are all ably treated."  
—*American Gardening.*

"It is a work for the gardener to gloat over, for the student of Horticulture to pore over, and for one who is neither of these to delight in possessing."  
—*Chicago Tribune.*

"While the entire work will cost \$20.00, it will be money well spent by any owner of an orchard or even a gardener. It will be to the farmer what the Century Dictionary is to the literary man."  
—*San Francisco Chronicle.*

---

The Price is \$5.00, net, for each volume, and the work is sold by subscription.

Circulars and full information will be supplied by the publishers on application.

---

Bailey's Cyclopedia of American Horticulture is published by

THE MACMILLAN COMPANY, 66 Fifth Ave., New York



# SCIENCE

NEW SERIES,  
VOL. XIII. No. 332.

FRIDAY, MAY 10, 1901.

SINGLE COPIES, 15 CTS.  
ANNUAL SUBSCRIPTION, \$5.00.

## Queen X-Ray Apparatus

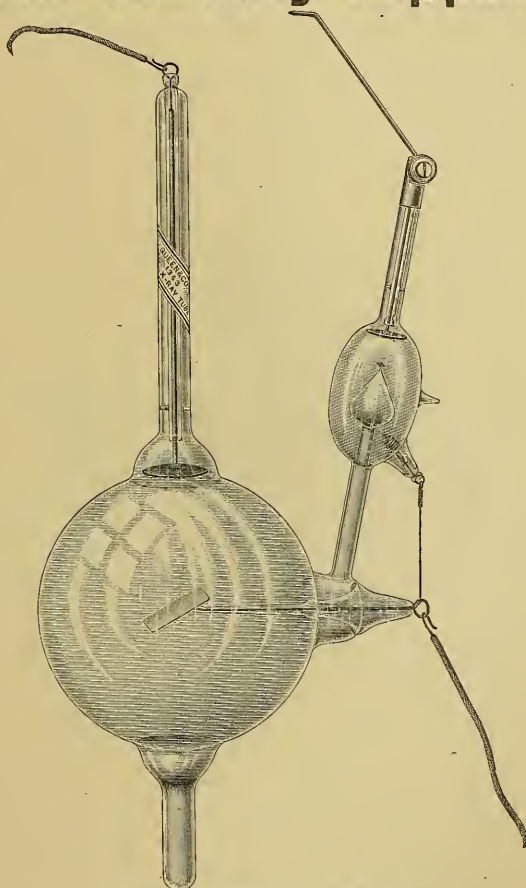

Queen Self-Regulating X-Ray Tube

**QUEEN & CO., Inc.**

J. G. GRAY, President

59 Fifth Avenue, New York  
480 Monon Bldg., Chicago

PHILADELPHIA

A GREAT WORK NEARING COMPLETION.

# Cyclopedia of American Horticulture

EDITED BY L. H. BAILEY

ASSISTED BY

WILLIAM MILLER and many expert  
Cultivators and Botanists

Volumes I., II. and III. are now ready, and Volume IV., completing the work,  
is in press and will be published soon.

In this great Cyclopedia will be found a complete description of all species of fruits, vegetables, flowers and ornamental plants in America. Directions for the cultivation of all kinds of crops, observations on marketing, etc.

## Opinions of the Work.

"We do not hesitate to commend this work to our readers, whether fruit-growers, gardeners, gentlemen of leisure or of whatever profession, for it contains such information as it will take scores of books to give, and cannot fail to both interest and instruct every reader."  
—*Canadian Horticulturist.*

"The information is precisely what the horticulturist and general reader is desirous of knowing."  
—*Scientific American.*

"In range, treatment and editing emphatically useful—worthy of ranking by the side of the Century Dictionary."  
—*The Nation.*

"As showing the earnest endeavor to be quite up to date, the very complete note on Horticulture in the Hawaiian Islands may be cited; half a page and over is devoted to this item.

"Grapes, American and European, grafting, the history and principle of greenhouse construction, forcing of fruits are all ably treated."  
—*American Gardening.*

"It is a work for the gardener to gloat over, for the student of Horticulture to pore over, and for one who is neither of these to delight in possessing."  
—*Chicago Tribune.*

"While the entire work will cost \$20.00, it will be money well spent by any owner of an orchard or even a gardener. It will be to the farmer what the Century Dictionary is to the literary man."  
—*San Francisco Chronicle.*

The Price is \$5.00, net, for each volume, and the work is sold by subscription.  
Circulars and full information will be supplied by the publishers on application.

Bailey's Cyclopedia of American Horticulture is published by

THE MACMILLAN COMPANY, 66 Fifth Ave., New York

# SCIENCE

NEW SERIES.  
VOL. XIII. No. 333.

FRIDAY, MAY 17, 1901.

SINGLE COPIES, 15 CTS.  
ANNUAL SUBSCRIPTION, \$5.00.

## Chemicals and Chemical, Physical and Bacteriological Apparatus

(See also KOHL'S Advertisement on Page 5.)

Analytical Balances and Weights  
German and Bohemian Glassware

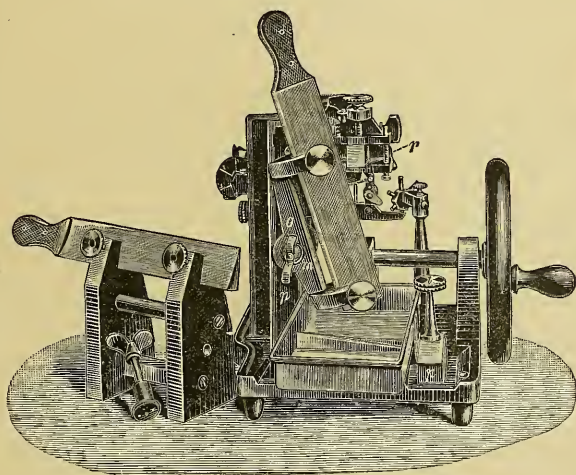

Greiner and Friedrich's Well-Known  
Graduated and Stopcock-Ware  
COMPLETE LABORATORY OUTFITS

### MICROTOME, MINOT'S IMPROVED FORM

Furnishing Sections of  $\frac{1}{2}$ -40 Microns

Incubators, Sterilizers, Laboratory Distilling Apparatus

AGENTS FOR

CARL ZEISS' MICROSCOPES, etc. (*the best European*)

SPENCER'S MICROSCOPES (*the best American*)

EIMER & AMEND, 18TH STREET and THIRD AVENUE New York



A GREAT WORK NEARING COMPLETION

# Cyclopedia of American Horticulture

EDITED BY L. H. BAILEY

ASSISTED BY

WILLIAM MILLER and many expert  
Cultivators and Botanists

Volumes I., II. and III. are now ready, and Volume IV., completing the work, is in press and will be published soon.

In this great Cyclopedia will be found a complete description of all species of fruits, vegetables, flowers and ornamental plants in America. Directions for the cultivation of all kinds of crops, observations on marketing, etc.

## Opinions of the Work.

"We do not hesitate to commend this work to our readers, whether fruit-growers, gardeners, gentlemen of leisure or of whatever profession, for it contains such information as it will take scores of books to give, and cannot fail to both interest and instruct every reader."  
—*Canadian Horticulturist.*

"The information is precisely what the horticulturist and general reader is desirous of knowing."  
—*Scientific American.*

"In range, treatment and editing emphatically useful—worthy of ranking by the side of the Century Dictionary."  
—*The Nation.*

"As showing the earnest endeavor to be quite up to date, the very complete note on Horticulture in the Hawaiian Islands may be cited; half a page and over is devoted to this item.

"Grapes, American and European, grafting, the history and principle of greenhouse construction, forcing of fruits are all ably treated."  
—*American Gardening.*

"It is a work for the gardener to gloat over, for the student of Horticulture to pore over, and for one who is neither of these to delight in possessing."  
—*Chicago Tribune.*

"While the entire work will cost \$20.00, it will be money well spent by any owner of an orchard or even a gardener. It will be to the farmer what the Century Dictionary is to the literary man."  
—*San Francisco Chronicle.*

The Price is \$5.00, net, for each volume, and the work is sold by subscription.  
Circulars and full information will be supplied by the publishers on application.

Bailey's Cyclopedia of American Horticulture is published by  
**THE MACMILLAN COMPANY, 66 Fifth Ave., New York**

# SCIENCE

NEW SERIES.  
VOL. XIII. No. 334.

FRIDAY, MAY 24, 1901.

SINGLE COPIES, 15 CTS.  
ANNUAL SUBSCRIPTION, \$5.00.

# SYNTHOL

(ABSOLUTE)

A chemically pure synthetic substitute for absolute ALCOHOL.

PURER      STRONGER      MORE STABLE      CHEAPER

**S**YNTHOL may be used for every purpose for which alcohol is used, except for internal consumption. Being chemically pure it does not have as much odor as absolute alcohol from grain or wood. It is perfectly free from color, is non-irritant to eyes or skin and has from ten to fifteen per cent. more solvent power than ordinary alcohol.

## PRICES:

1 pint, net . . . . .	\$ .40
1 gallon, net . . . . .	2.50
1 bbl. of 50 gallons, per gallon, net, . . . . .	2.25

As a killing, fixing, or hardening agent it is in every respect equal to the best absolute alcohol and can be used as a substitute for it in the preparation of stains, reagents, etc. We offer a special low price on Synthol in barrel lots FOR MUSEUM PURPOSES. As a preservative it is superior to any alcohol. Alcohol becomes tinged with color on exposure to light. Synthol retains its absolute colorlessness under all conditions. Sample supplied free to laboratories. . . . .

MANUFACTURED EXCLUSIVELY FOR

## BAUSCH & LOMB OPTICAL CO.

CHICAGO

ROCHESTER, N. Y.

NEW YORK

MAY 25 1901  
National Museum

A GREAT WORK NEARING COMPLETION

# Cyclopedia of American Horticulture

EDITED BY L. H. BAILEY

ASSISTED BY

WILHELM MILLER and many expert  
Cultivators and Botanists

---

Volumes I., II. and III. are now ready, and Volume IV., completing the work, is in press and will be published soon.

---

In this great Cyclopedia will be found a complete description of all species of fruits, vegetables, flowers and ornamental plants in America. Directions for the cultivation of all kinds of crops, observations on marketing, etc.

---

## Opinions of the Work.

"We do not hesitate to commend this work to our readers, whether fruit-growers, gardeners, gentlemen of leisure or of whatever profession, for it contains such information as it will take scores of books to give, and cannot fail to both interest and instruct every reader."  
—*Canadian Horticulturist*.

"The information is precisely what the horticulturist and general reader is desirous of knowing."  
—*Scientific American*.

"In range, treatment and editing emphatically useful—worthy of ranking by the side of the Century Dictionary."  
—*The Nation*.

"As showing the earnest endeavor to be quite up to date, the very complete note on Horticulture in the Hawaiian Islands may be cited; half a page and over is devoted to this item.

"Grapes, American and European, grafting, the history and principle of greenhouse construction, forcing of fruits are all ably treated."  
—*American Gardening*.

"It is a work for the gardener to gloat over, for the student of Horticulture to pore over, and for one who is neither of these to delight in possessing."  
—*Chicago Tribune*.

"While the entire work will cost \$20.00, it will be money well spent by any owner of an orchard or even a gardener. It will be to the farmer what the Century Dictionary is to the literary man."  
—*San Francisco Chronicle*.

---

The Price is \$5.00, net, for each volume, and the work is sold by subscription.  
Circulars and full information will be supplied by the publishers on application.

---

Bailey's Cyclopedia of American Horticulture is published by

**THE MACMILLAN COMPANY, 66 Fifth Ave., New York**

# SCIENCE

NEW SERIES.  
VOL. XIII. No. 335.

FRIDAY, MAY 31, 1901.

SINGLE COPIES, 15 CTS.  
ANNUAL SUBSCRIPTION, \$5.00

Estate  
GUSTAV E. STECHERT

## G. E. STECHERT

ALFRED HAFNER

9 East 16th Street, New York

BOOKS and PERIODICALS NEW and SECOND-HAND

SUBSCRIPTIONS TAKEN FOR ALL PERIODICALS.

WHOLE LIBRARIES OR SMALL LOTS OF BOOKS PURCHASED

Large Stock of Complete Sets of Scientific Periodicals.

SEND FOR CATALOGUE.

*MONTHLY LIST of new publications in various languages sent to customers gratis upon request.*

All important German and French books on hand as soon as published. Books in any language not in stock, imported at shortest notice either in our regular weekly shipments or if necessary by post.

ATTENTION IS DIRECTED TO THE FOLLOWING SETS WHICH WE HAVE IN STOCK:

<b>The Analyst.</b> Vol. I.—XXIII. 23 vols. London 1877—1898. Cloth .....	\$120.00
<b>Annals and Magazine of Natural History.</b> Magazine of Zoology and Botany. Lond. 1837—1838. 2 vols.— <b>Annals and Magazine of Natural History.</b> Series I.—VI. 1—4. Lond. 1838—1839. 106 vols. $\frac{1}{2}$ mor. cpl. set. Very rare .....	325.00
<b>Archiv für Anatomie und Physiologie,</b> hrsg. v. His, Braune, Du Bois-Reymond. From the beginning in 1877 to 1895, bound in 38 vols. (includ. 15 suppl.). $\frac{1}{2}$ mor. New .....	250.00
<b>Centralblatt für Bacteriologie u. Parasitenkunde.</b> Hrsg. v. O. Uhlworm. Abt. I. Vol. I.—XVIII. u. Abt. II. Vol. I. Jena 1887—1895. $\frac{1}{2}$ mor. Vol. XVIII. paper .....	65.00
<b>Jahresbericht über d. Fortschritte der Chemie, Physik und Mineralogie,</b> hrsg. v. Liebig und Kopp. 1847—1890, nebst 3 Reg.-Bdn. zu. 1847—1876. Glessen und Braunschw. 1849—1896. $\frac{1}{2}$ cloth. 4 vols. boards .....	165.00
<b>Journal of Anatomy and Physiology.</b> Conducted by Humphry, Turner, Newton, Clark, etc. Vols. I.—XVIII. Lond. 1867—1884. $\frac{1}{2}$ calf .....	85.00
<b>Sitzungsberichte der K. K. Akademie der Wissenschaften in Wien.</b> Mathemat.-naturw. Classe. Bd. 1—99 u. 13 Registerbde. zu Bd. 1—100. Wien 1855—1890. In boards .....	250.00
<b>Zeitschrift für die gesammten Naturwissenschaften.</b> Herausgeg. v. od. Naturw. Vereine für Sachsen u. Thüringen. Vols. 1—64. Halle 1853—1891. $\frac{1}{2}$ calf, rest in parts .....	60.00
<b>Zeitschrift für physikalische Chemie, Stöchiometrie u. Verwandtschaftslehre.</b> Hrsg. v. W. Ostwald & J. H. Van't Hoff. Bd. 1.—XXXI. Lpz. 1887—1899. $\frac{1}{2}$ mor. Newly bound in best. $\frac{1}{2}$ mor. 123.00	

G. E. STECHERT, 9 East 16th St., New York



H. S. D'ARSONVAL GALVANOMETER

## ELECTRICAL AND PHYSICAL LABORATORIES

The World over are using

### WILLYOUNG INSTRUMENTS

Because they are Rigidly Accurate, of Beautiful Workmanship and Finish, and Designed with Perfect Adaptation to the end desired.

Our Circulars and Catalogues are Free—Write and be put on our Mailing List.

We make a full line of Scientific Instruments of Precision, mainly electrical, including Galvanometers, Resistance and Capacity Standards, Wheatstones Bridges, Standards of Self Induction, Electrometers, Oscillographs, etc., etc.

Our X-Ray Machines and Induction Coils are unsurpassed and run on any circuit direct or alternating. Adopted by the U. S. Marine Hospital Service.

We import duty free at best rates. Let us give prices on your list. To hold our trained force together during the otherwise dull summer months WE WILL MAKE SPECIAL REDUCTIONS ON ORDERS PLACED NOW FOR FALL DELIVERY. ALSO ON REPAIRS AND RECALIBRATIONS DURING THE SAME PERIOD.

ELMER G. WILLYOUNG, NO. 11 FRANKFORT ST., N. Y. CITY, N. Y.

Subscription for The Edison  
MAY 31 1901

A GREAT WORK NEARING COMPLETION

# Cyclopedia of American Horticulture

EDITED BY L. H. BAILEY

ASSISTED BY

WILHELM MILLER and many expert  
Cultivators and Botanists

---

Volumes I., II. and III. are now ready, and Volume IV., completing the work,  
is in press and will be published soon.

---

In this great Cyclopedia will be found a complete description of all species of fruits, vegetables, flowers and ornamental plants in America. Directions for the cultivation of all kinds of crops, observations on marketing, etc.

---

## Opinions of the Work.

"We do not hesitate to commend this work to our readers, whether fruit-growers, gardeners, gentlemen of leisure or of whatever profession, for it contains such information as it will take scores of books to give, and cannot fail to both interest and instruct every reader."  
—*Canadian Horticulturist*.

"The information is precisely what the horticulturist and general reader is desirous of knowing."  
—*Scientific American*.

"In range, treatment and editing emphatically useful—worthy of ranking by the side of the Century Dictionary."  
—*The Nation*.

"As showing the earnest endeavor to be quite up to date, the very complete note on Horticulture in the Hawaiian Islands may be cited; half a page and over is devoted to this item.

"Grapes, American and European, grafting, the history and principle of greenhouse construction, forcing of fruits are all ably treated."  
—*American Gardening*.

"It is a work for the gardener to gloat over, for the student of Horticulture to pore over, and for one who is neither of these to delight in possessing."  
—*Chicago Tribune*.

"While the entire work will cost \$20.00, it will be money well spent by any owner of an orchard or even a gardener. It will be to the farmer what the Century Dictionary is to the literary man."  
—*San Francisco Chronicle*.

---

The Price is \$5.00, net, for each volume, and the work is sold by subscription.  
Circulars and full information will be supplied by the publishers on application.

---

Bailey's Cyclopedia of American Horticulture is published by  
**THE MACMILLAN COMPANY, 66 Fifth Ave., New York**



# SCIENCE

NEW SERIES.  
VOL. XIII No. 335.

FRIDAY, JUNE 7, 1901.

SINGLE COPIES, 15 CTS.  
ANNUAL SUBSCRIPTION, \$5.00.

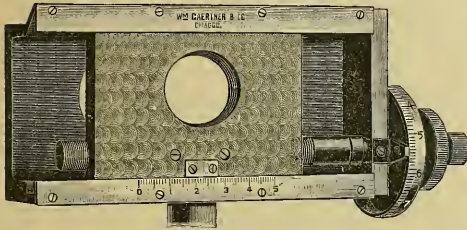

**WM. GAERTNER & CO.**  
Astronomical and  
Physical Apparatus  
5347 and 5349 LAKE AVE., CHICAGO

### SPECIALTIES

Standard Apparatus of New and Improved Designs  
Reading Microscopes and Telescopes  
Astronomical Telescopes    Dividing Engines  
Spectroscopes    Comparators  
Michelson Interferometers    General Laboratory Apparatus  
Bolometers    Heliostats  
Universal Laboratory Supports

## The Principles of Vegetable Gardening

By Prof. L. H. BAILEY, of Cornell University.

458 pages. Illustrated. \$1.25

*Rural Science Series.* The newest and completest book on the subject, and the first to state principles.

PART I.—A general view,—discusses the lay-out, glass houses, etc.,—the soil, tools, seed, etc.

PART II.—Crops,—takes up root, tuber, bulb, cole, pot-herb, and salad crops; and beans, tomatoes, melons, corn, and others, closing with perennials, such as asparagus and rhubarb. Thorough, but practical.

A Circular of this practical book on **VEGETABLE GARDENING** will be sent on request.

THE MACMILLAN COMPANY, 66 Fifth Ave., New York

**NATURAL HISTORY SPECIMENS** and Supplies of all descriptions to illustrate the study of the Natural Sciences,

Minerals, Meteorites, Rocks, Fossils, Archaeological Specimens, Relief Maps and Models, Skeletons and Paper Maché Models of Human and Comparative Anatomy, Taxidermy, Shells, Echinoderms, Corals, etc. Write for Circulars.

Ward's Natural Science Establishment, 76 to 104 College Avenue, Rochester, N. Y.

**"DUTY FREE"**

**IMPORTATIONS**

FROM

**SOCIÉTÉ  
GENEVOISE**

As sole U. S. agent for this celebrated house, the undersigned will mail free to any professor of physics, a copy of the 1900 Catalogue—printed in English.

Some of the Important Specialties are:

Dividing Engines,    Standards of Length,  
Comparators,    Spherometers,    Spectrometers,  
Goniometers,    Telescopes,    Micrometers,  
Microscopes,    Heliostats,    Chronographs,  
Spectroscopes, and General Laboratory Apparatus.

**JAMES G. BIDDLE**

1024 Stephen Girard Building

PHILADELPHIA

APPARATUS IMPORTED FROM PRACTICALLY ALL OF THE PROMINENT EUROPEAN MANUFACTURERS.

JUN 10 1901  
National Museum

A GREAT WORK NEARING COMPLETION

# Cyclopedia of American Horticulture

EDITED BY L. H. BAILEY

ASSISTED BY

WILHELM MILLER and many expert  
Cultivators and Botanists

---

Volumes I., II. and III. are now ready, and Volume IV., completing the work,  
is in press and will be published soon.

---

In this great Cyclopedia will be found a complete description of all species of fruits, vegetables, flowers and ornamental plants in America. Directions for the cultivation of all kinds of crops, observations on marketing, etc.

---

## Opinions of the Work.

"We do not hesitate to commend this work to our readers, whether fruit-growers, gardeners, gentlemen of leisure or of whatever profession, for it contains such information as it will take scores of books to give, and cannot fail to both interest and instruct every reader."  
—*Canadian Horticulturist.*

"The information is precisely what the horticulturist and general reader is desirous of knowing."  
—*Scientific American.*

"In range, treatment and editing emphatically useful—worthy of ranking by the side of the Century Dictionary."  
—*The Nation.*

"As showing the earnest endeavor to be quite up to date, the very complete note on Horticulture in the Hawaiian Islands may be cited; half a page and over is devoted to this item.

"Grapes, American and European, grafting, the history and principle of greenhouse construction, forcing of fruits are all ably treated."  
—*American Gardening.*

"It is a work for the gardener to gloat over, for the student of Horticulture to pore over, and for one who is neither of these to delight in possessing."  
—*Chicago Tribune.*

"While the entire work will cost \$20.00, it will be money well spent by any owner of an orchard or even a gardener. It will be to the farmer what the Century Dictionary is to the literary man."  
—*San Francisco Chronicle.*

---

The Price is \$5.00, net, for each volume, and the work is sold by subscription.  
Circulars and full information will be supplied by the publishers on application.

---

Bailey's Cyclopedia of American Horticulture is published by

**THE MACMILLAN COMPANY, 66 Fifth Ave., New York**

# SCIENCE

NEW SERIES.  
VOL. XIII. No. 337.

FRIDAY, JUNE 14, 1901.

SINGLE COPIES, 15 CTS.  
ANNUAL SUBSCRIPTION, \$5.00

## QUEEN INSTRUMENTS

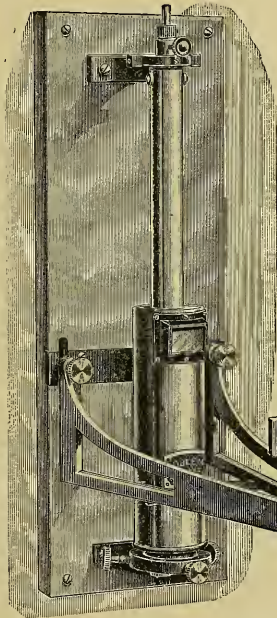

New  
Queen Wall Pattern  
Galvanometer

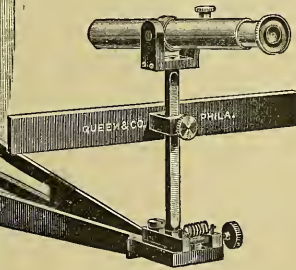

The Moving Coil in this Galvanometer is of small diameter and light weight. It can be made dead beat and will then give readings with much greater rapidity than other forms on the market. When arranged for Ballistic work the period of swing can be made as desired.

Circular 500 describes this and a number of other new instruments in detail.

PHYSICAL APPARATUS    INDUCTION COILS    ELECTRICAL TESTING INSTRUMENTS

### QUEEN & CO., Inc.

J. G. GRAY, President

ELECTRICAL AND SCIENTIFIC INSTRUMENTS

59 Fifth Avenue, New York  
480 Monon Bldg., Chicago

1010 Chestnut St., Philadelphia, Pa.

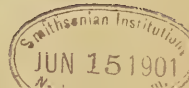

A GREAT WORK NEARING COMPLETION

# Cyclopedia of American Horticulture

EDITED BY L. H. BAILEY

ASSISTED BY

WILHELM MILLER and many expert  
Cultivators and Botanists

Volumes I., II. and III. are now ready, and Volume IV., completing the work,  
is in press and will be published soon.

In this great Cyclopedia will be found a complete description of all species of fruits, vegetables, flowers and ornamental plants in America. Directions for the cultivation of all kinds of crops, observations on marketing, etc.

## Opinions of the Work.

"We do not hesitate to commend this work to our readers, whether fruit-growers, gardeners, gentlemen of leisure or of whatever profession, for it contains such information as it will take scores of books to give, and cannot fail to both interest and instruct every reader."  
—*Canadian Horticulturist.*

"The information is precisely what the horticulturist and general reader is desirous of knowing."  
—*Scientific American.*

"In range, treatment and editing emphatically useful—worthy of ranking by the side of the Century Dictionary."  
—*The Nation.*

"As showing the earnest endeavor to be quite up to date, the very complete note on Horticulture in the Hawaiian Islands may be cited; half a page and over is devoted to this item.

"Grapes, American and European, grafting, the history and principle of greenhouse construction, forcing of fruits are all ably treated."  
—*American Gardening.*

"It is a work for the gardener to gloat over, for the student of Horticulture to pore over, and for one who is neither of these to delight in possessing."  
—*Chicago Tribune.*

"While the entire work will cost \$20.00, it will be money well spent by any owner of an orchard or even a gardener. It will be to the farmer what the Century Dictionary is to the literary man."  
—*San Francisco Chronicle.*

The Price is \$5.00, net, for each volume, and the work is sold by subscription.  
Circulars and full information will be supplied by the publishers on application.

Bailey's Cyclopedia of American Horticulture is published by

THE MACMILLAN COMPANY, 66 Fifth Ave., New York

# SCIENCE

NEW SERIES.  
VOL. XIII. No. 338.

FRIDAY, JUNE 21, 1901.

SINGLE COPIES, 15 CTS.  
ANNUAL SUBSCRIPTION, \$5.00.

## Chemicals and Chemical Apparatus

SOLE AGENTS FOR  
**SCHMIDT & HAENSCH'S POLARISCOPES**

FOR SUGAR AND URINE ANALYSIS

AND FOR

**MAX KOHL'S PHYSICAL AND SCIENTIFIC APPARATUS.**

(See also Kohl's special advertisement on page iv).

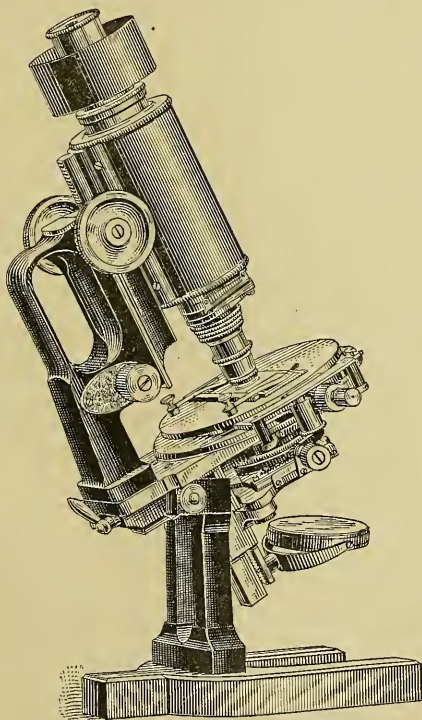

ZEISS' PHOTO-MICROGRAPHIC STAND

Always full line of Zeiss' Microscopes, Microscopic Accessories, Refractometers, etc., on hand.

SOLE AGENTS FOR  
**CARL SCHLEICHER & SCHÜLL'S Chemically Pure FILTERS**  
**SCHOTT & GENOSSENS' Jena Laboratory Glassware**  
THE BEST GLASS EVER MADE  
**C. A. F. KAHLBAUM'S C. P. Chemicals and Reagents**  
Glassblowing done on our premises  
Metalware Repair Shop right in our building

**EIMER & AMEND, 18TH STREET and THIRD AVENUE New York**

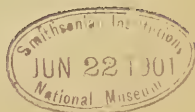

A GREAT WORK NEARING COMPLETION

# Cyclopedia of American Horticulture

EDITED BY L. H. BAILEY

ASSISTED BY

WILHELM MILLER and many expert  
Cultivators and Botanists

Volumes I., II. and III. are now ready, and Volume IV., completing the work,  
is in press and will be published soon.

In this great Cyclopedia will be found a complete description of all species of fruits, vegetables, flowers and ornamental plants in America. Directions for the cultivation of all kinds of crops, observations on marketing, etc.

## Opinions of the Work.

"We do not hesitate to commend this work to our readers, whether fruit-growers, gardeners, gentlemen of leisure or of whatever profession, for it contains such information as it will take scores of books to give, and cannot fail to both interest and instruct every reader."  
—*Canadian Horticulturist*.

"The information is precisely what the horticulturist and general reader is desirous of knowing."  
—*Scientific American*.

"In range, treatment and editing emphatically useful—worthy of ranking by the side of the Century Dictionary."  
—*The Nation*.

"As showing the earnest endeavor to be quite up to date, the very complete note on Horticulture in the Hawaiian Islands may be cited; half a page and over is devoted to this item.

"Grapes, American and European, grafting, the history and principle of greenhouse construction, forcing of fruits are all ably treated."  
—*American Gardening*.

"It is a work for the gardener to gloat over, for the student of Horticulture to pore over, and for one who is neither of these to delight in possessing."  
—*Chicago Tribune*.

"While the entire work will cost \$20.00, it will be money well spent by any owner of an orchard or even a gardener. It will be to the farmer what the Century Dictionary is to the literary man."  
—*San Francisco Chronicle*.

The Price is \$5.00, net, for each volume, and the work is sold by subscription.  
Circulars and full information will be supplied by the publishers on application.

Bailey's Cyclopedia of American Horticulture is published by  
**THE MACMILLAN COMPANY, 66 Fifth Ave., New York**

# SCIENCE

NEW SERIES.  
VOL. XIII. No. 339.

FRIDAY, JUNE 28, 1901.

SINGLE COPIES, 15 CTS.  
ANNUAL SUBSCRIPTION, \$5.00.

# SYNTHOL

(ABSOLUTE)

A chemically pure synthetic substitute for absolute ALCOHOL.

PURER      STRONGER      MORE STABLE      CHEAPER

**S**YNTHOL may be used for every purpose for which alcohol is used, except for internal consumption. Being chemically pure it does not have as much odor as absolute alcohol from grain or wood. It is perfectly free from color, is non-irritant to eyes or skin and has from ten to fifteen per cent. more solvent power than ordinary alcohol.

### PRICES:

1 pint, net . . . . .	\$ .40
1 gallon, net . . . . .	2.50
1 bbl. of 50 gallons, per gallon, net, . . . . .	2.25

As a killing, fixing, or hardening agent it is in every respect equal to the best absolute alcohol and can be used as a substitute for it in the preparation of stains, reagents, etc. We offer a special low price on Synthol in barrel lots FOR MUSEUM PURPOSES. As a preservative it is superior to any alcohol. Alcohol becomes tinged with color on exposure to light. Synthol retains its absolute colorlessness under all conditions. Sample supplied free to laboratories. . . . .

MANUFACTURED EXCLUSIVELY FOR

## BAUSCH & LOMB OPTICAL CO.

CHICAGO

ROCHESTER, N. Y.

NEW YORK

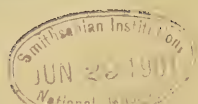

A GREAT WORK NEARING COMPLETION

# Cyclopedia of American Horticulture

EDITED BY L. H. BAILEY

ASSISTED BY

WILHELM MILLER and many expert  
Cultivators and Botanists

Volumes I., II. and III. are now ready, and Volume IV., completing the work, is in press and will be published soon.

In this great Cyclopedia will be found a complete description of all species of fruits, vegetables, flowers and ornamental plants in America. Directions for the cultivation of all kinds of crops, observations on marketing, etc.

## Opinions of the Work.

"We do not hesitate to commend this work to our readers, whether fruit-growers, gardeners, gentlemen of leisure or of whatever profession, for it contains such information as it will take scores of books to give, and cannot fail to both interest and instruct every reader."  
—*Canadian Horticulturist.*

"The information is precisely what the horticulturist and general reader is desirous of knowing."  
—*Scientific American.*

"In range, treatment and editing emphatically useful—worthy of ranking by the side of the Century Dictionary."  
—*The Nation.*

"As showing the earnest endeavor to be quite up to date, the very complete note on Horticulture in the Hawaiian Islands may be cited; half a page and over is devoted to this item.

"Grapes, American and European, grafting, the history and principle of greenhouse construction, forcing of fruits are all ably treated."  
—*American Gardening.*

"It is a work for the gardener to gloat over, for the student of Horticulture to pore over, and for one who is neither of these to delight in possessing."  
—*Chicago Tribune.*

"While the entire work will cost \$20.00, it will be money well spent by any owner of an orchard or even a gardener. It will be to the farmer what the Century Dictionary is to the literary man."  
—*San Francisco Chronicle.*

The Price is \$5.00, net, for each volume, and the work is sold by subscription.  
Circulars and full information will be supplied by the publishers on application.

Bailey's Cyclopedia of American Horticulture is published by  
**THE MACMILLAN COMPANY, 66 Fifth Ave., New York**























SMITHSONIAN INSTITUTION LIBRARIES



3 9088 01301 4279