

Unit: cm

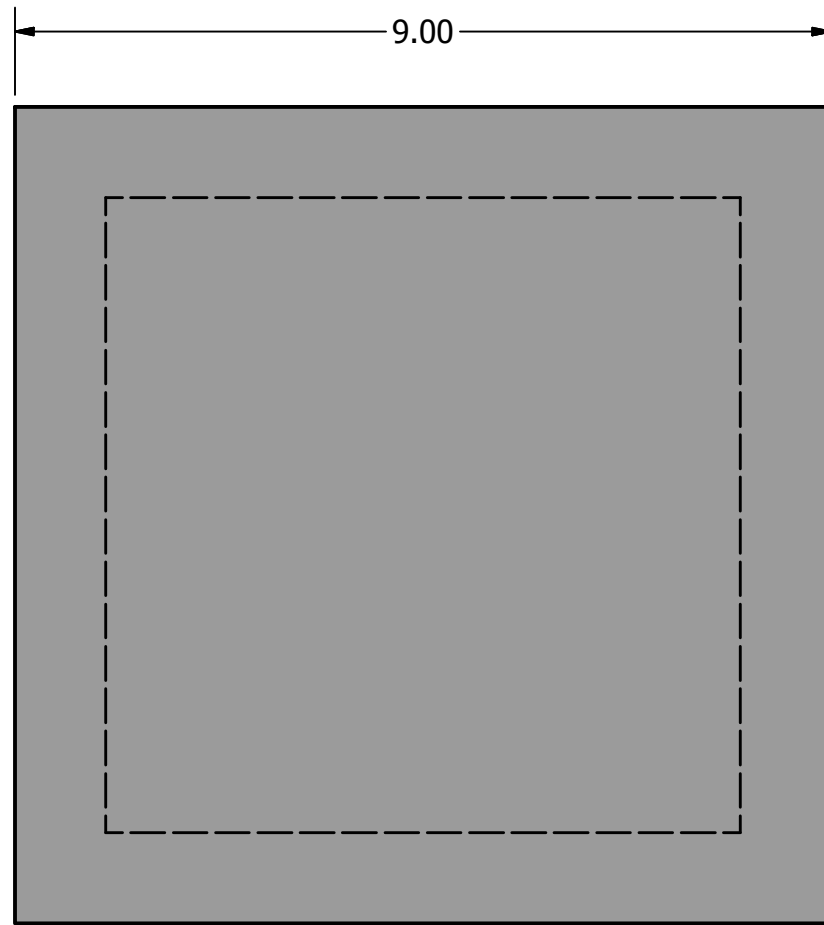
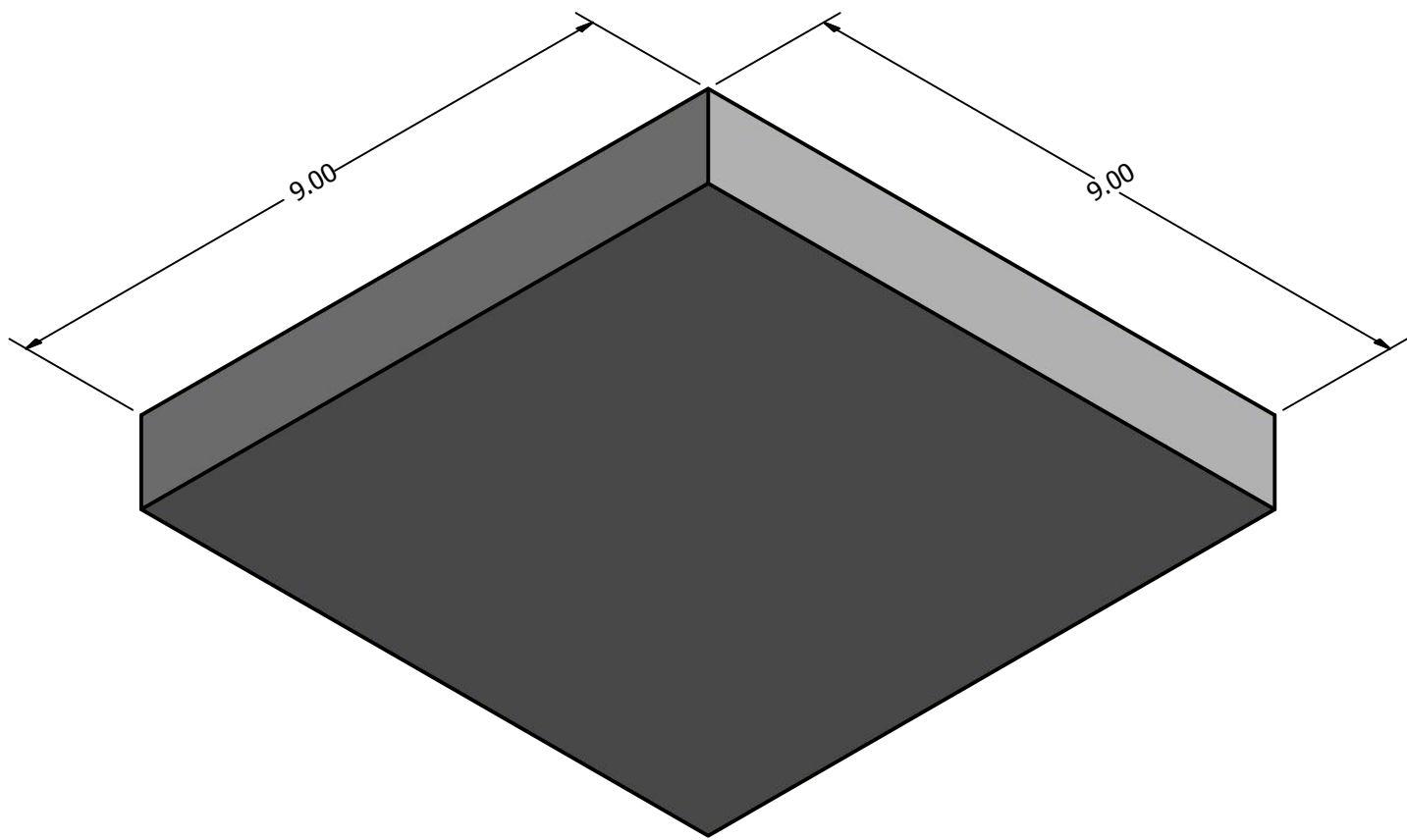
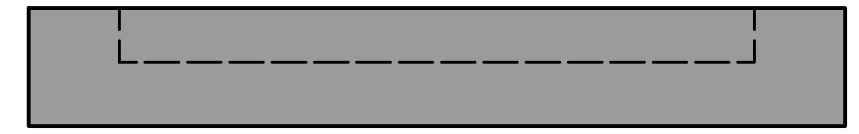
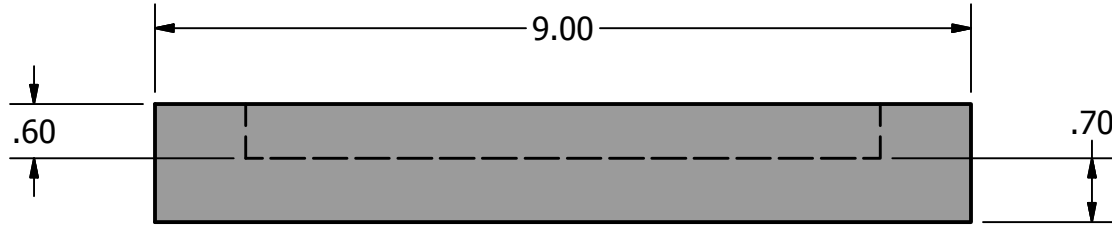
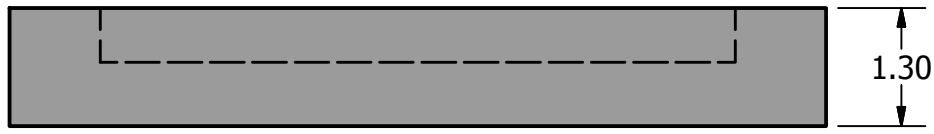
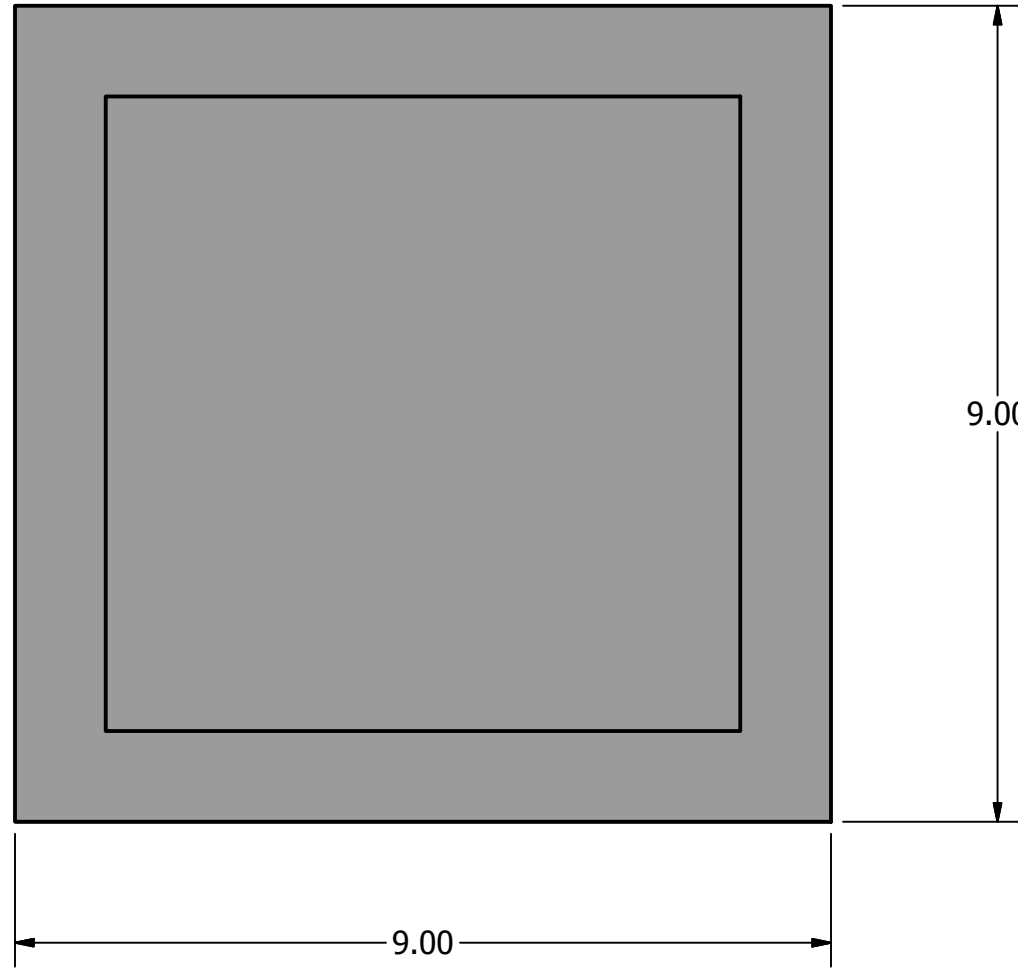
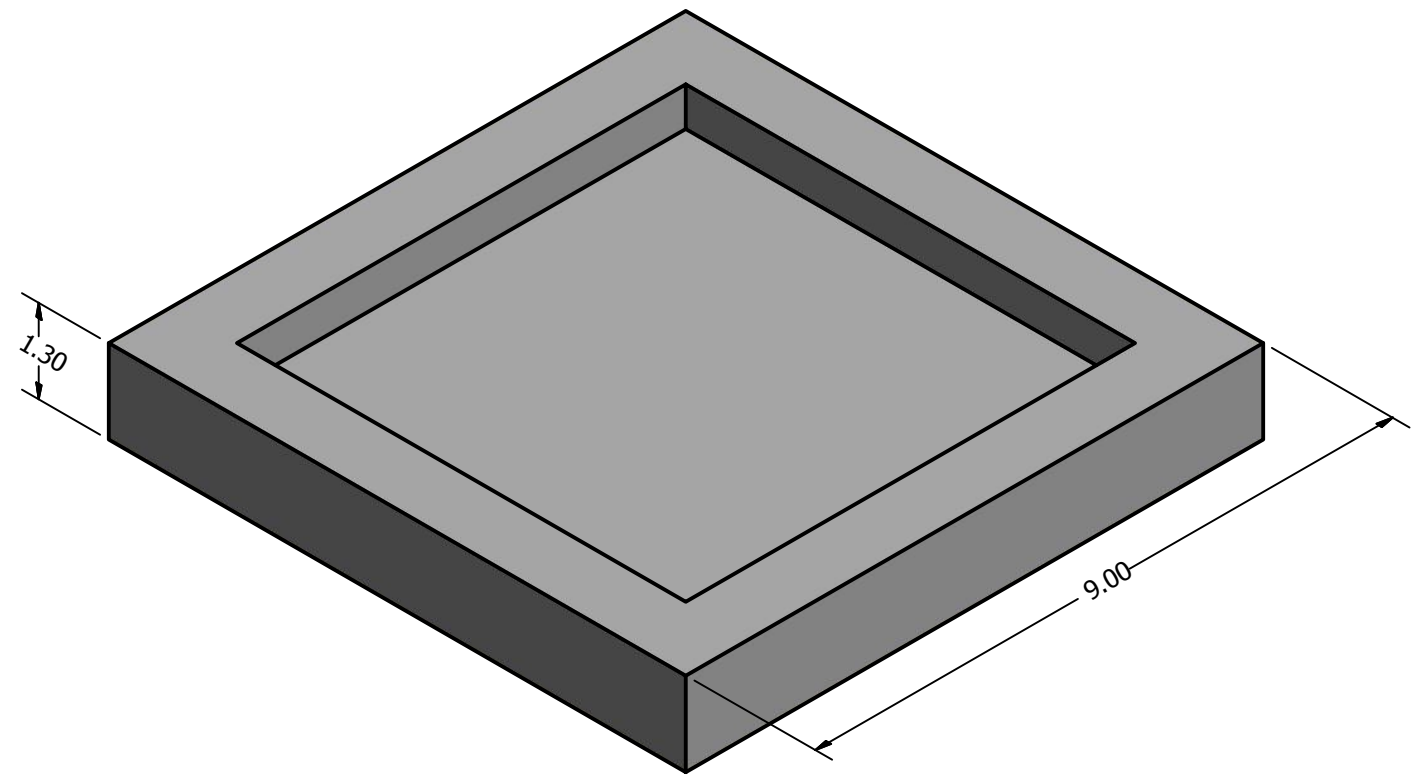

DRAWN	Student	11/19/2014		
CHECKED			TITLE	
QA				
MFG				
APPROVED				
		SIZE	DWG NO	REV
		C		
		SCALE	SHEET 1 OF 1	