

UC-NRLF



QB 440 130

CLASS BOOK OF

PRACTICAL PHYSIOLOGY.

HISTOLOGY,

CHEMICAL PHYSIOLOGY,

EXPERIMENTAL PHYSIOLOGY.

W. B. Saunders Co. Philadelphia, Pa.

GIFT OF

Association of Medical Librarians

TO THE

LIBRARY OF THE

MEDICAL DEPARTMENT

OF THE

UNIVERSITY OF CALIFORNIA

MEDICAL SCHOOL
LIBRARY

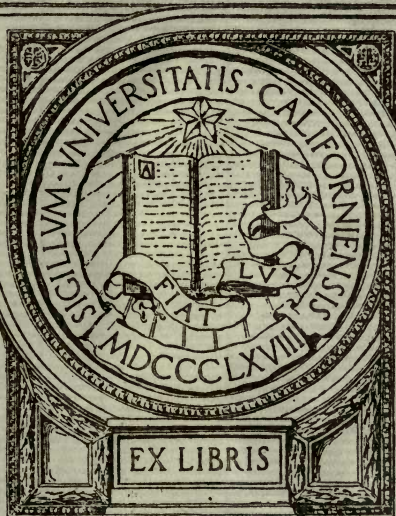

EX LIBRIS

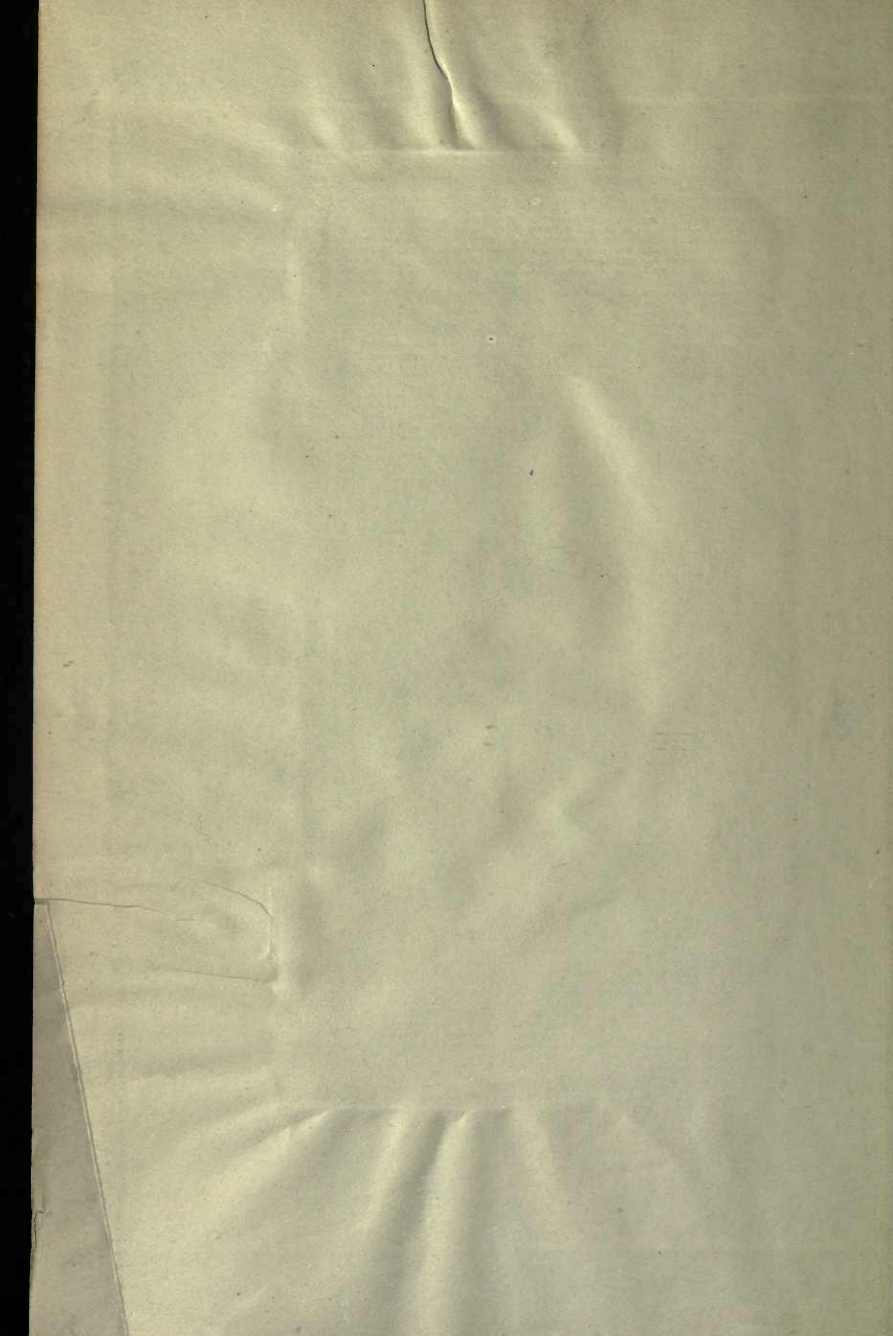

A CLASS BOOK

OF

(ELEMENTARY)

PRACTICAL PHYSIOLOGY

INCLUDING

HISTOLOGY, CHEMICAL AND EXPERIMENTAL
PHYSIOLOGY.

BY

DE BURGH BIRCH, M.D., C.M., F.R.S.E.,

PROFESSOR OF PHYSIOLOGY IN THE YORKSHIRE COLLEGE OF THE VICTORIA
UNIVERSITY; EXAMINER IN VICTORIA UNIVERSITY; ADDITIONAL
EXAMINER IN EDINBURGH UNIVERSITY.

PHILADELPHIA

P. BLAKISTON'S SON & CO

1012, WALNUT STREET

1899

Printed in Great Britain.

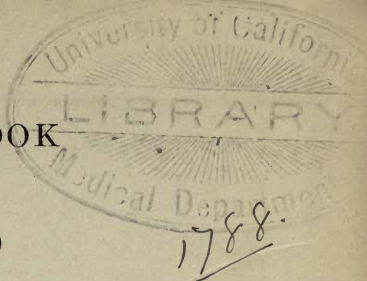

CHORLEY & PICKERSGILL, THE ELECTRIC PRESS, LEEDS.

W. & A. PICKERSGILL
LEEDS

PREFACE.

THIS volume represents in a more formal setting the notes which the author has been in the habit of issuing to students attending the ordinary course of Practical Physiology in this College.

The aim has been to supply the student with concise directions for performing the work which he has to do with his own hands in class.

The choice of methods has been necessarily governed by their adaptability to class purposes, and as much as possible also by their simplicity.

In order that the student may read beforehand the work that is to engage his attention at the next meeting of the class, the subject matter has been divided into lessons, which are indicated by marginal numbers.

Illustrations have been omitted from the section on Histology, as it is essential that the student should systematically practice drawing from the preparation itself uninfluenced by the suggestions of a drawing ready to his hand.

He is thus led to form his own opinion of what he himself sees, and is encouraged to cultivate and to rely upon his own powers of interpretation.

For the same reasons tracings have been omitted from the Experimental Section.

A system of abbreviated references to the Appendix has been employed in those cases in which sections of tissues are given to the class ready for mounting, by which means the methods of preparation can be found in full.

Much attention has been devoted by the author to the simplification of the instrumental appliances* in the Experimental Section, so that the student's time may not be needlessly spent in mastering details of machinery, which are not the direct objects of study but only the means to an end.

The author is indebted to his former demonstrators, W. Gough, B.Sc. Lond., and J. A. Cairns Forsyth, B.Sc. (Hon.) Vict., for repeating many of the processes in the Histological Section, and to his present demonstrator, J. W. Milroy, M.A., M.B., C.M., Edin., for some suggestions in the Chemical Section.

Existing works have been freely consulted, and acknowledgment has been made as far as possible in the context.

DE BURGH BIRCH.

YORKSHIRE COLLEGE,

LEEDS, *April, 1899.*

* Carried out mainly by A. Kershaw, East Dorrington Street, Leeds.

CONTENTS.

—
Lessons are indicated by marginal numbers in the sequence.
 —

Part I.—Histological Section.

CHAP.	LESSON	PAGE
	<i>Weights and measures</i>	3
	<i>Introduction.</i> —The microscope, focussing, care of.—The work table.—Cleaning slides and covers.—Labelling.—Finishing off preparations... ..	5
	<i>Drawing and measuring</i>	8
I.	1. <i>Introductory Exercises.</i> —Examination of the object.—Application of a cover-glass.—Irrigation.—Various fibres.—Starch	11
	2. <i>Brownian movement.</i> —Bacteria.—Milk.—Flotation.—Staining on the slide.—Mounting in balsam.—Mounting paraffin sections	12
II.	3. <i>Exercises in preparing tissues.</i> —Fixing and Hardening.—Decalcifying.—Staining in bulk.—Embedding.—Cutting sections	16
	<i>Synopsis of treatment in embedding, staining, and mounting</i>	27
III.	4. <i>Simple tissues.</i> — <i>Epithelium</i> , endothelium.—Stratified.—Mitosis	28
	5. <i>Columnar.</i> —Intestinal.—Ciliated.—Ciliary motion ...	30
	6. <i>Connective tissue.</i> —Areolar.—Tendon.—Action of reagents	33
	7. <i>Tendon, of rat's tail, of large mammal.</i> —Yellow fibrous.—Retiform	34
	8. <i>Fatty tissue.</i> — <i>Cartilage.</i> —Hyaline.—White fibro.—Elastic.—Arytenoid... ..	36

CHAP.	LESSON	PAGE
IV.	9. <i>Bone</i> , adult, dried.—Softened.—Growing, head of...	39
	10. Growing, shaft.—Ossification of head.—Marrow ...	42
V.	<i>Tooth</i> , adult.—Growing	44
VI.	11. <i>Muscle</i> .—Non-striped.—Cardiac	47
	12. Striped, crab's.—Isolated fibres.—Spindles	48
VII.	13. <i>Nerve</i> . — Medullated. — Osmic. — Silvered. — Nerve trunk.—Non-medullated	51
	14. <i>Nerve cells</i>	54
VIII.	<i>Circulatory system</i> .—Artery and vein.—Distended.—Aorta.—Sinus of Valsalva.—Ventricle of Sheep...	55
	15. <i>Blood</i> . — Amphibian and human. — Red cells.—Reagents—Leucocytes... ..	57
	16. Fixed blood. — Amœboid leucocytes. — Fibrin.—Hæmoglobin, hæmin crystals	60
	17. <i>The circulation</i> in the frog	62
IX.	<i>Respiratory system</i> . — Trachea. — Bronchus. — Lung, silvered	65
	18. Fœtal.—Injected	67
X.	<i>Alimentary canal</i> .—Tongue.—Papillæ.—Soft palate.—Œsophagus	68
	19. Stomach, cardio-œsophageal.—Cardiac.—Pyloric.—Pyloro-duodenal.—Injected.—Small intestine.—Fat absorption.—Auerbach's plexus	70
	20. Peyer's patch.—Injected.—Large intestine.—Vermiform Appendix	74
XI.	Glands, parotid.—Sub-maxillary.—Injected... ..	76
	21. Pancreas.—Liver, cells.—Capsule.—Portal tract.—Bile ducts.—Gall bladder.—Glycogen	77

CHAP.	LESSON		PAGE
XII.	22.	<i>Kidney</i> , general.—Papilla.—Boundary zone.—Injected.—Isolated tubules.—Embryonic.—Ureter.—Bladder	80
XIII.	23.	<i>Skin</i> .— <i>Scalp</i> .— <i>Nail</i>	84
XIV.		<i>Blood glands</i> , Lymph.—Injected.—Tonsil	86
	24.	Hæmolymp. — Spleen.—Thyroid.—Thymus.—Parathyroid	87
	25.	Pituitary body.—Suprarenal	89
XV.		<i>Nervous system</i> .—Cervical ganglion.—Dorsal root.—Vagus.— <i>Spinal cord</i> .—Thoracic	91
	26.	Fresh cord.—Injected.—Conus.—Lumbar.—Cervical.— <i>Bulb</i>	93
	27.	<i>Cerebellum</i> .— <i>Pons</i> .— <i>Mid-brain</i> .— <i>Cerebral cortex</i>	95
XVI.	28.	<i>Organs of generation</i> .—Testis.—Spermatogenesis.—Vas deferens.—Prostate.—Ovary.—Fallopian tube.—Uterus.—Vagina	98
	29.	Mammary gland	100
XVII.		<i>Sense organs</i> , olfactory.—Eye.—Corneo-sclerotic region.—Cornea.—Lens	101
	30.	Optic papilla.—Retina.— <i>Ear</i> , cochlea.—Semi-circular canals	103
		<i>Appendix</i> to the Histological Section.—Preserving, fixing, and hardening fluids	107
		Staining	110
		Injection with coloured gelatin masses	116

Part II.—Chemical Section.

XVIII.	1.	<i>Carbohydrates</i> .— <i>Glucoses</i> .— <i>Saccharoses</i> , cane sugar.— <i>Maltose</i> .— <i>Lactose</i>	121
	2.	<i>Amyloses</i> .— <i>Starch</i> .—Transformations.—Precipitations.— <i>Dextrin</i>	124

CHAP.	LESSON	PAGE
	3. Glycogen	126
XIX.	<i>Fats.</i> —Saponification.—Emulsification ...	127
XX.	4. <i>Proteids</i> , albumins and globulins.—Reactions ...	129
	5. Coagulation temperature.—Albuminates ...	132
	Tables for the rough recognition of proteids and carbohydrates	135
XXI.	6. <i>Some food substances.</i> Milk	136
	7. Flesh.—Wheat flour	138
XXII.	8. <i>Digestion.</i> —Gastric	140
	9. Free hydrochloric and lactic acids.—Pancreatic ...	142
XXIII.	10. <i>Blood.</i> —Serum	144
	11. Plasma, coagulation.—Sugar in blood ...	146
	12. Hæmacytometer.—Hæmoglobinometer ...	148
	13. Spectra of blood	152
XXIV.	14. Bile	155
XXV.	15. <i>Healthy urine.</i> — <i>Inorganic constituents</i> ...	157
	16. Volumetric estimation of phosphoric acid ...	160
	17. <i>Organic constituents.</i> —Urea.—Quantitative estimation	161
	18. Kjeldahl's process	164
	19. Creatinin.—Uric acid.—Urates.—Quadriurates.— Oxalates	167
XXVI.	20 Abnormal. — Albumosuria. — Hæmoglobinuria. — Mucin	170
	21. Glycosuria.—Quantitative.—Fermentation ...	172
	Urinary test table	177
	List of reagents	178

Part III.—Experimental Section.

CHAP.	LESSON	PAGE
XXVII.	1. Electrical considerations.—Galvanic cell.—Amalgamation.—Daniell.—Leclanché cell.—Leads.—Keys.—Commutator.—Hand electrodes	183
	2. Inductorium.—Extra current	188
XXVIII.	3. Dissection of the frog.—Pithing.—Dissection ...	195
XXIX.	Experiments.—Galvani.—Rheoscopic limb	198
	4. Transmission of nervous impulses.—Excitation of muscle and nerves	199
	5. Changes in the excitability of a nerve.—Unipolar stimulation	202
XXX.	6. Arrangements for recording	204
XXXI.	7. Extensibility and elasticity of muscle	212
	8. Single muscular contraction and latent period ...	213
	9. Tetanus	216
	10. Fatigue	217
	11. Influence of load on work	218
	12. Heating and cooling muscle	221
	13. Curara experiment	223
	14. Effect of Veratria	224
XXXII.	15. Experiments on nerves	226
	16. Rate of transmission of a nervous impulse... ..	228
	17. Electrotonus	231
	18. Pflüger's law	233
XXXIII.	19. Demarcation and action currents	236
XXXIV.	20. Circulatory system	240

CHAP.	LESSON	PAGE
	21. Pulse tracing.—Blood pressure.—Flow in capillaries	242
	22. The frog heart	245
	23. Effect of Atropine and Muscarine.—Heat and cold	248
	24. Stannius' ligature.—Latent period.—Cardiac tetanus	249
	25. Suprarenal extract on the circulation	250
XXXV.	26. Vision.—Field of vision	251
	27. Ophthalmoscope.—Scheiner's experiment	252
	28. Listing's diagrammatic eye.—Marriott's experiment. —Discriminative power.—Periodic stimulation of retina	256
XXXVI.	29. Cutaneous senses	259
	<i>Appendix to the Experimental Section</i>	262

LIST OF ILLUSTRATIONS.

FIG.		PAGE	FIG.	PAGE
	Scales and measures ...	3	32.	Paradoxical contraction 200
1.	Student's microscope (Leitz)*	5	33.	Work table, experimental 204
2.	Eye-piece micrometer ...	8	34.	Recording cylinder ... 205
3.	Microscopical measure- ment	9	35.	„ arm 206
4.	Ventral dissection of a frog*	16	36.	Smoking chamber... .. 207
5.	Injecting apparatus ...	17	37.	Time distribution board 208
6.	Embedding bath	21	38.	Diagram of Fig. 37 ... 208
7.	„ mould	22	39.	Varnishing table*... .. 210
8.	Microtome, horse shoe ...	23	40.	Afterload, isometric con- traction 220
9.	„ rocking	24	41.	Heating and cooling muscle... .. 221
10.	„ ether freezing 25		42.	Curara experiment ... 223
11.	Mussel	31	43.	Double electrodes 226
12.	Moist cell	32	44.	Pendulum myograph ... 229
13.	Hot stage	33	45.	Electrotonus 231
14.	Frog support	63	46.	Pflüger's law 234
15.	Hæmacytometer (Zeiss) §	148	47.	Galvanometer 238
16.	Spectroscope	152	48.	Sphygmometer (Hicks) § 243
17.	Ureameter	163	49.	Glass staff 244
18.	Kjeldahl apparatus ...	165	50.	Frog heart recorder ... 246
19.	Glass seeker	181	51.	Perimeter 251
20.	Galvanic cell	183	52.	Ophthalmoscope 253
21.	Electrical keys	186	53.	Scheiner's experiment ... 255
22.	Ways of using keys ...	186	54.	Diagrammatic eye... .. 256
23.	Pohl's commutator ...	187	55.	Æsthesiometer 259
24.	Hand electrodes	187	56.	Aly's æsthesiometer ... 260
25.	Induced currents	188	57.	Compensation method ... 263
26.	Inductorium	189	58.	Wheatstone's bridge ... 263
27.	Break extra current ...	191	59.	Paul's bridge box § ... 264
28.	Primary circuit	192	60.	Kohlrausche's method ... 264
29.	Dorsal dissection, frog*	194	61.	Resistance galvanometer and cell 265
30.	Muscle-nerve preparation	197	62.	Power distribution ... 266
31.	Electric forceps	198		

The Author is responsible for the actual drawings, excepting those marked (*) or which bear their origin in brackets (§).

ERRATA.

Pg. 13, last line, for "translucent" read "transparent." Pg. 32, 5th from bottom, for "ciliary" read "ciliary." Pg. 97, 2nd line, for "which" read "and;" 10th line, the body "of the cell." Pg. 98, last line but one, for "acina" read "acini." Pg. 100, line 10, for "spith" read "cells." Pg. 163, line 4, after "place it in B" add "nearly fill C with water."

PART I.
HISTOLOGICAL SECTION.

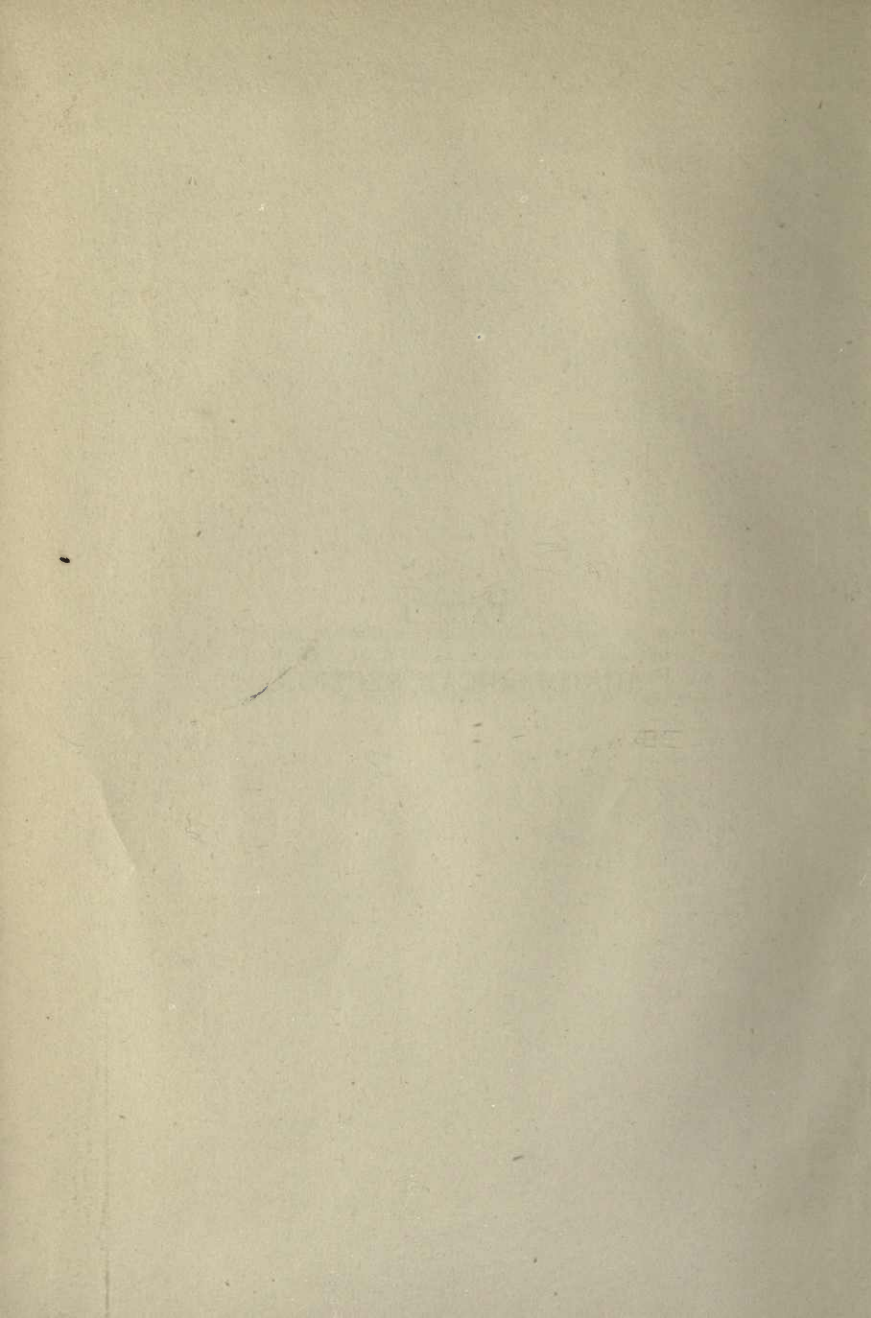

Q. 1. 55-55-1079

British and Decimal Weights and Measures, and their conversion into each other.



- 1 cubic centimetre (H_2O @ $4^\circ C$) = 1 gramme = 15.4 grains.
- 1 kilo (1,000 grammes) = 2.2 pounds avoirdupois @ 16 ounces = 35.2 ounces avoirdupois.
- 1 pound avoirdupois = 16 ounces @ 437.5 grains = 7,000 grains = 454 grammes.
- 1 litre = 1,000 cubic centimetres = 1.76 pints @ 20 ounces = 35.2 fluid ounces.

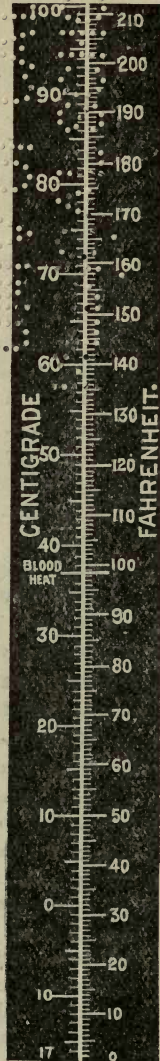

Each Student is required to provide himself with the following:—

1. **A microscope**, with a high and low power, a medium eye-piece and an eye-piece micrometer ruled in squares.
2. **Slides**, 1 in. by 3 in., $1\frac{1}{2}$ gross, of white glass not thicker than 1.5 mm ($\frac{1}{16}$ in.).
3. **Cover-glasses**. No. 2 (0.17 mm, about $\frac{1}{150}$ in.) $\frac{1}{2}$ oz. Circular, $\frac{5}{8}$ in. across. This shape is convenient if the mounting fluid necessitates ringing; the square shape, which is a little cheaper, does for balsam-mounted objects.
4. **Square labels** for specimens.
5. **Needles mounted in handles**. No. 6 "Betweens" mounted in cedarwood handles, $\frac{1}{2}$ in. of the needle projecting. The soft wood allows of the needles being removed and replaced when soiled.
6. **Two glass rods**, drawn out thinner at one end and bent to an obtuse angle. This end for use as a section lifter.
7. **Scissors**, medium size and sharp pointed.
8. **Forceps**, two pairs, one fine pointed and one of the ordinary dissecting kind.
9. **A razor** with a straight edge and a stiff back. Must not be hollow ground.
10. **Pins**, hedgehog bristles, fine linen thread and silk.
11. **Two watch glasses**. 12. **Specimen tubes**, $\frac{1}{2}$ doz., 2 in. by $\frac{5}{8}$ in., corked.
13. **Wide-mouthed bottles**. Three 3 oz., screw-capped or stoppered.
14. **Drawing Book** faintly ruled in 1 in. squares.
15. **A case** to hold specimens.
16. **Wash Leather**. A piece 4 in. square to wipe lenses.
17. **Glass cloth** for wiping slides. 18. **Absolute alcohol** 3 oz.
19. **Gold size**, $\frac{1}{2}$ oz., and small camel hair brushes for ringing preparations.

Reagents supplied on the work tables. The ordinary stains, mounting media, &c., are supplied on the tables in the reagent stands, and such others as occasion may require.

Appliances supplied on the work tables. Two tin bowls, a small bunsen burner, cut blotting paper, a tin hot stage, frog plate, zinc tray, horse shoe microtome and glass plate. On a side table ready for use are a warm chamber and appliances for embedding in paraffin, a Cambridge rocking microtome and a Williams' ether freezing microtome with foot blower.

INTRODUCTION.

The Microscope. The compound microscope consists of an eye-piece or ocular **A** and of an objective **B** placed at opposite ends of the body of the instrument. The eye-piece fits into the draw-tube, which forms part of the body, and by means of which the distance between the eye-piece and objective can be adjusted. The body **C** is carried by the pillar **D** and is moved in the direction of its axis by means of a friction tube or (FIG. 1) a rack and pinion, actuated by the milled head **F** for coarse adjustment and by the milled head **F'** for fine adjustment. Beneath is the stage **S**, and beyond this the illuminating appliance, which consists of a double mirror **M**, one side of which is plane and the other concave. Between the mirror and the stage is the adjustable sub-stage **I** which carries the diaphragm, for regulating the quantity of light admitted to the object, and for which a condenser may be easily substituted. The latter, which may be termed an inverted objective, is employed to produce a more exact and powerful concentration of light upon the object than can be obtained with the concave mirror alone, and is required with powers of less than $\frac{1}{8}$ in. or 4 mm focal distance.

The student will require for work in the histological class an instrument yielding magnifications of from 50 to 350 or 400 diameters. He will obtain this by means of a $1\frac{1}{2}$ in. Huyghenian ocular and objectives of 1 in.

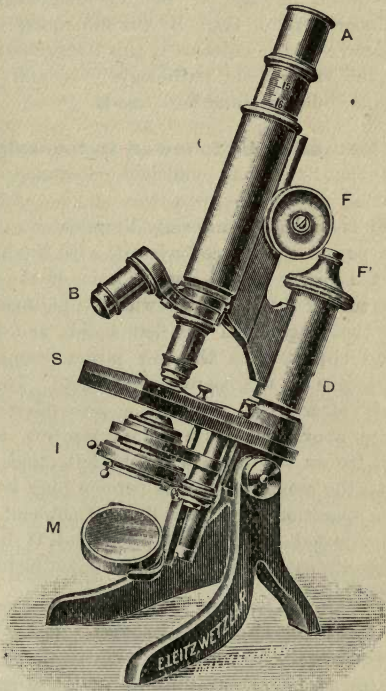

FIG. 1. Student's Microscope.

and $\frac{1}{8}$ in. focus, using the 6 in. or continental tube length (Swift, Beck, &c.). Oculars Nos. 2 and 4 with objectives a_3 and D of Zeiss. Ocular No. 3 with objectives Nos. 2 and 6 of Leitz.

The last-named maker supplies his No. II b stand (FIG. 1) with cylinder diaphragms carried in a sub-stage adjusted by a lateral screw together with the ocular and objectives mentioned, and a double nose-piece, for £6 5s. An iris diaphragm can be substituted for the cylinder form for 10s. By the subsequent addition of a Homog. immersion objective and a condenser, this instrument will fulfil all the requirements of the student in pathology. As far as my experience goes it is simple, efficient, and well made.

Method to be followed in focussing the microscope. Always see that there is sufficient clearance beneath the objective before placing an object upon the stage. Adjust the mirror so that the field is well and uniformly illuminated. Use the plane mirror with the low power and the concave one with the high power, and keep the centre of the mirror in the optical axis of the microscope. Employ a small aperture of the diaphragm with the high power. Place the slide in position on the stage with the left hand, and clamp it there with the right hand clip. With the low power bring the object sharply into view by means of the coarse adjustment. To use the high power immediately afterwards, revolve the nose-piece; the objective will come into place above but close to its position of focus. Move the slide to and fro on the stage with the left hand, and use the coarse adjustment until the moving object is perceptible; let the object rest, and complete the operation with the fine adjustment. The high power is usually so adjusted on the nose-piece that it takes up a position which only necessitates a turn of the fine adjustment to bring the object into focus.

Care of the microscope. Keep the objectives screwed to the nose-piece.

To detect the position of dirt. If defined specks, &c., are seen in the field they are on the eye-piece and will move when the latter is turned. Raise the eye-piece, partially unscrew the upper (eye-) lens, if the specks move with the lens, the latter must be cleaned, if they remain stationary clean the lower (field-) lens.

If objects focussed on the stage appear dim, the objective is soiled. Remove it and examine its front lens with an inverted eye-piece held close to it. To clean lenses gently dust them with a clean piece of wash leather kept for the purpose. If this fails moisten with water,

dry by touching with blotting paper, and complete the cleansing with wash leather. If oils or balsam are to be removed, dissolve with a little alcohol or benzene and dry.

Avoid lubricating the coarse adjustment, but rub it clean with a duster. If the fine adjustment works stiffly cleanse the screw of dust, then remove old oil with benzene and touch with a little watchmaker's oil.

Arrangement of the work table. Place all that is likely to be required ready to your hand. The microscope should stand at a convenient distance from the edge of the table and directly in front of the observer. Its body should be inclined whenever the nature of the work will allow, so as to avoid stooping the head more than is necessary. Keep the drawing book to the right of the microscope. The case for specimens, and a tray holding slides, covers, labels &c., are placed together, at the further edge of the table. This will leave the remainder clear as working space.

In the histological laboratory of the Yorkshire College the space allotted to each worker is 2 ft. 6 in. square, and between every two places are a porcelain sink, water tap (low pressure, to avoid splashing) and electric light (16 c.p.), available within 18 in. of the microscope, and shaded, so as to prevent direct illumination of the worker's eyes. Each student has also a pedestal locker.

To clean slides and cover-glasses. Wash them in soap and water or benzene to remove grease or balsam. Dry with a thin glass cloth. Thin covers, if very dirty, are placed in strong sulphuric acid, washed in water, and drained on blotting paper before wiping; the latter is accomplished either in the fold of a thin towel between the thumb and forefinger of one hand, by gently moving them upon each other, or between two flat pieces of wood tightly covered with wash leather. A stock of slides and covers, ready cleaned and protected from dust, should be kept in readiness.

Labelling preparations. Label without delay and write in ink. Use two labels, one at each end of the slide. One should bear the serial number and class designation or special point illustrated, written as large as the space will allow for ease of reference, and the name of the owner. The other should give information as to origin, method of preparation, the nature of the stain, the nature of the mounting fluid, if necessary, and the date.

Finishing off. All preparations should be laid flat. Those mounted in *balsam* until hardened. Air spaces, which may arise in the course of drying, should be filled up with balsam. Any very obtrusive balsam may be scraped off with a knife, and the slide cleaned with a rag moistened with benzene. They should not be ringed. Specimens

mounted in *glycerin*, *glycerin jelly*, or *Farrant's* solution, require ringing to preserve them, a process much simplified by taking care that at the time of mounting, only sufficient fluid is used to fill the space between the glasses. The edge of the cover and the neighbouring surface of the slide must be clean, so that the cement may hold. Overflow of the mounting medium is first removed with blotting paper moistened with water and then with alcohol. The slide is centered on a turn table, which can be borrowed in the laboratory, and a ring of thickened gold size applied with a small brush whilst the table revolves at a moderate speed. Make the ring as narrow as is consistent with complete sealing and due hold upon the glass. A second application of the same, or of Zinc white cement, will complete the ringing.

DRAWING AND MEASURING AN OBJECT.

Draw every object which you examine and append marginal notes connecting the latter with the parts noted by directing lines.

Sketches are to enable you to study later on the preparations which you have made in class. It does not matter how slight the sketch is, provided the principal features and their position in the preparation are properly noted. Draw on paper faintly ruled in squares,¹ avoid a cramped style and mere mechanical repetition of detail. When the subject is the section of an organ, draw the general outline as seen under the low power. Naked eye examination is of great help when the section exceeds the dimensions of the field. Then give high power views of those portions which the preparation is meant to illustrate. Light washes of water colour are effective additions, especially if they reproduce the colours of the stains with which the tissues are treated.

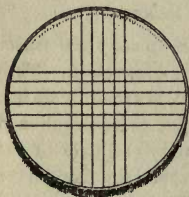

FIG. 2. Zeiss Eye-piece Cross-line Micrometer.

An **eye-piece micrometer**² is a great help as it serves both as a guide in drawing and as a scale for measurement.

Measurement of an object.—The simplest way is to standardise the eye-piece cross-line micrometer for each combination of eye-piece and objective, and to measure with it. A stage micrometer is necessary, and

¹ Suitable drawing books can be obtained from the Laboratory attendant, W. Bacon.

² Eyepiece cross-line micrometer of Zeiss, divided 5 mm into 1 mm, price 5s. This is dropped into the eye-piece, and rests upon the diaphragm, which must be adjusted by pushing it up or down until the lines of the micrometer are in the focus of the eye-glass.

can be obtained in the laboratory. This is an actual scale on glass divided into fractions of a millimetre ($\frac{1}{100}$) or fractions of an inch ($\frac{1}{100}$ and $\frac{1}{1000}$). With the ocular micrometer in the eye-piece focus the divisions of the stage micrometer.

Using the same eye-piece and the same length of tube, determine for each of your objectives the number of divisions of the stage micrometer which equal one division of the eye-piece scale, and note the results as follows:—One division of the scale in Oc. 2 with Obj. 3 is equal to say 15 divisions of the stage scale ($\frac{1}{100}$ mm) = 0.15 mm, and with Obj. 6 equals $3\frac{1}{4}$ stage divisions = 0.0325 mm. The same may be done with a stage scale giving fractions of an inch. The ocular scale is now standardised for those particular optical combinations. For example, to measure the diameter of a red-blood corpuscle substitute a dried film of human blood for the stage-scale and using Obj. 6 find how many red corpuscles in a row fill one division of the ocular scale. Assuming that it takes four, the diameter of one corpuscle is 0.0325 mm divided by 4 = 0.008 mm (8 μ). The metric standard of microscopical measurement is the micron 0.001 mm designated by the Greek μ .

In the absence of an eye-piece micrometer, proceed as follows:—Look through the microscope at the stagescale with the left eye, at the same

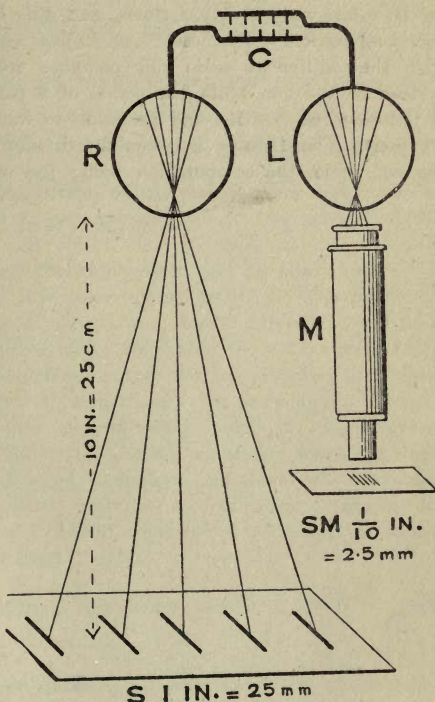

FIG. 3. Measurement, using both eyes.

R right, and L left eye. M Microscope. SM Stage micrometer. S Scale of inches. C Comparison of the two images in the brain. It is presumed that the magnification is such as to produce a retinal image in the left eye equalling that in the right eye.

time, with the right eye, look at a centimetre scale held close to the stage and at a distance of 25 cm from the eye. The two scales appear superposed upon each other. Count the stage divisions which exactly correspond to one cm. of the centimetre scale, which, with the high power we will presume to be 3,003 mm now appear equal to 10 mm and are therefore magnified 333 times, and this is the *magnifying power* of the combination. To measure an object, compare its magnified image with the millimetre scale and compute from the ascertained ratio. Instead of the mm. scale, the points of a pair of dividers may be held in the required position and be made to include a number of the stage divisions. The distance between the divider points is then read off on the cm. scale, the computation being the same as before.

INTRODUCTORY EXERCISES.

THE following substances may be accidentally included in a preparation and present subjects upon which a number of operations important in microscopy can be usefully practised.

Examination and description of an object. As a rule *examine* first with a low power (*L*) to gain an insight into the general appearance and arrangement of the object, and its apparent size under this magnification. Then employ the high power (*H*) to study detail. Do not omit to return to the low power occasionally, for the purpose of comparing appearances, and of ascertaining whether details found under the high power are discernible under the lower one. This procedure is of great importance in accustoming the eye to recognise the relative proportions and dimensions of structures. In *describing* a structure notes should be made under the following headings. *Form*, general shape, outlines, surfaces—under this the nature of any markings should be given. *Size*, long and short diameters and thickness. *Substance*, whether uniform (homogeneous), granular, or reticular. Presence of a nucleus or other contents. *Colour*. *Grouping*, tendency to cohere. *Movements*, general and internal. *Effects of reagents*.

Cotton fibre. Stretch a few fibres across a drop of water on a slide and apply a cover.

Application of a cover-glass. *Always cover the object with a cover-glass before examining it under the high power.* Hold the cover between the thumb and forefinger of the left hand, place one edge of it in contact with the mounting fluid, and resting the other on the point of a needle gradually lower the cover so that air bubbles may be carried to one side clear of the object and of the cover.

Examine with a low power (*L*), a number of fine filaments are visible, the details of which are better seen with a high power (*H*). Each fibre is a flattened tube often partially filled with air. The walls are smooth, and the fibre is frequently twisted.

Application of a reagent by irrigation. A drop of the reagent is placed on the slide close to the right edge of the cover, at the opposite edge a piece of blotting paper moistened at the tip is laid in contact with the fluid beneath the cover. Guide the reagent with a glass rod into touch with the mounting fluid, a stream will be established through the preparation towards the blotting paper. Different fluids can be successively brought to bear upon the preparation in this manner. Use small quantities of the reagent and avoid staining the stage of the microscope.

Irrigate the preparation with Iodine solution, the fibres will be stained of a slightly yellow colour.

Irrigate, in addition, with strong Sulphuric Acid, the fibres will swell and turn blue; this is the reaction for Cellulose.

Linen fibre. (H) The fibres are solid cylinders with a smooth surface.

Woollen fibre. (H) Cylindrical filaments, the surfaces of which show transverse markings which indicate their structure of imbricated scales.

Starch granules. Scrape the cut surface of a potato lightly with the edge of a scalpel and diffuse the scraping in water. (H) The oval¹ starch granules exhibit concentric contour lines around a spot placed near one end. Irrigate with Iodine and note the blue colour produced, *Iodide of Starch*.

2 Brownian movement. Rub a piece of Gamboge on a slide in a drop of water until the latter has a yellow tint, cover. (H) Fine particles of various sizes are found which exhibit *oscillatory movements*. This phenomenon is commonly exhibited by inanimate particles suspended in water.

Bacteria. (H) Examine a drop of fluid from an aqueous infusion of meat or of chopped straw which has had time to

¹ To ascertain the shape of a small object floating in a fluid, touch the cover with a needle and note any change of configuration whilst the object revolves in the field.

decompose. Numbers of minute rod-shaped bodies (*Bacteria*) appear moving through the fluid with an undulating or spiral motion. They are *propelled in a definite* direction by a flagellum at one or both ends; these flagella are only revealed by the highest powers. The bacteria are the causes of the putrefactive changes in the infusion.

Milk. A thin film (*H*) exhibits small spherical bodies (fat globules) in great numbers, floating in a colourless fluid (milk plasma). The globules are transparent and do not adhere to each other. Irrigate with *acetic acid* and note the change produced in the behaviour of the globules to each other.

Newt's moult. Squamous epithelium. Mount a piece, which has been preserved in alcohol, as follows:—

Flotation on water. Drop the object into a basin of water, the effect of alcohol in unfolding and spreading out a thin film of tissue is instantaneous, the tissue lies on the surface of the water. Pass a slide two-thirds under water in a sloping position, guide the object to its centre with a needle, and holding it there lightly, raise the slide from the basin. Then turning the slide into the vertical position so as to drain the water to one end, dry the slide with blotting paper on both sides and right up to the edge of the tissue.

Stain on the slide with hæmatoxylin,¹ by adding a small drop of the stain to an equal quantity of water on the slide and guiding it over the preparation with a glass rod. Cover and watch the development of the staining under the low power, and as soon as the nuclei are sufficiently tinged, bathe off the superfluous colouring matter with water, or float the tissue off the slide into the water and back on to the slide.

Mount in balsam which is the next step, *dehydrate* by dropping absolute alcohol, 6 or 7 drops successively, on the preparation, flowing it slowly across it so as to give the alcohol time to abstract the water. The next step is to *clear* with oil of cloves (or other essential oil) by placing a drop of the oil on the slide and guiding it to the edge of the object, it will flow beneath it, will soak up through the preparation, and will render it translucent. This indicates that the oil has taken

¹Kleinberg's solution see appendix 20.

the place of the alcohol. Observe this taking place under a low power. Should there be any trace of opacity left it is due to incomplete removal of water. Further treatment with alcohol is necessary and clearing must again be performed, and if then there are no signs of opacity, *permanent mounting in balsam* is finally performed by removing superfluous essential oil with blotting paper, adding a drop of balsam and covering.

Examine with a high power (*H*) and observe the polygonal cells joined edge to edge into a continuous sheet, each with a violet stained nucleus. Two or three layers of cells may be found superposed upon each other.

Stain another piece with **Picrocarmine** by covering it with a pool of the reagent, give the stain five minutes to penetrate, remove the excess with blotting paper, and apply **Glycerin** or **Farrant**, just enough to fill the interval between slide and cover. As the carmine effect does not develop for some time, it is necessary to leave some of the stain in the preparation, which will become more differentiated by the selective activity of the tissues in the course of a week. Picrocarmine is a double stain, the carmine colouring the nuclei and connective tissue where such is present pink, and other parts yellow.

Mounting sections of tissues cut in paraffin and which are still permeated by the paraffin in which they have been embedded.

As in the sequel the majority of the sections given out to the class will be of this nature, the student should note carefully the uses of the following alternative methods.

1. *Simple treatment.* If the section be flat, i.e., is not curled or crumpled beyond a very slight extent, and its parts do not tend to fall asunder when the support of the paraffin is removed, proceed as follows:—Place the section in the centre of the slide, warm its underside over the burner just sufficiently to melt the paraffin and wash the latter away with five or six successive drops of turpentine or toluene, giving each drop time to act. In warming over the burner care must be taken not to overheat or the tissue will be spoilt. The thickness of the slide affects the time which the heat takes to reach the film of paraffin, therefore pass the slide twice immediately over the flame and wait a few moments to see if the paraffin is going to melt, testing the temperature of the slide meanwhile on the back of the hand for future

guidance. Heat again if necessary until the melting point is reached and apply the solvent. Dry the slide with blotting paper, apply balsam and cover.

2. *If the section is to be stained*¹ remove the solvent with absolute alcohol. Any trace of paraffin remaining in the section will appear white, spicular under the microscope, and must be removed. Then having bathed the preparation with a drop of water, to be certain that it will wet uniformly, apply the staining reagent.

3. *Flattening on Oil.* *Crumpled sections* which do not require fixing to the slide are most conveniently treated as follows:—A pool of the essential oil used for clearing (cedar oil when eosin is present) sufficient to float the section is placed upon the slide and is slightly warmed. The section is floated upon it and flattens. The superfluous oil is drained off with blotting paper, additional heat is applied just sufficient to melt the paraffin, drain, add more of the oil to dissolve what remains of the paraffin, cool and if no paraffin is visible add balsam and cover.

If the sections are extremely thin and tend to fall apart when the paraffin is melted employ one of the following methods:—

4. *Shellac fixation.* *For stained sections.* Smear a very thin film of a saturated solution of white shellac in creosote with your finger on the middle of a slide, place the section in position and press it lightly into contact with the fixative with a dry finger. Melt the paraffin over the burner, being careful not to heat beyond the melting point; keep it melted for a minute, drain off and dissolve away the remaining paraffin with turpentine or toluene, apply balsam and cover.

5. *Water fixation.* *For sections which are to be stained upon the slide (Gulland.)* If the section is curled or frilled, place it on warm water, not above 40° C; it will flatten. Float on to a slide or cover-glass, and blot off the water thoroughly. Heat to the warmth of the hand for ten minutes over the bunsen flame to drive off all moisture, then heat sufficiently to melt the paraffin. The section will adhere to the slide.² Use turpentine to dissolve the paraffin, blot off the excess, add balsam, and cover. Unstained sections after being freed of turpentine or toluene by means of alcohol can be stained in position upon the slide.

¹ These operations can be performed upon a large number of sections at a time in a watch glass or porcelain capsule. Heating unnecessary provided sufficient solvents and time are given.

² 24 hours drying at the ordinary temperature and shielded from dust is more certain. The slides must be perfectly clean and free from grease. It is best to clean them with alcohol before use.

EXERCISES IN THE PREPARATION OF TISSUES.

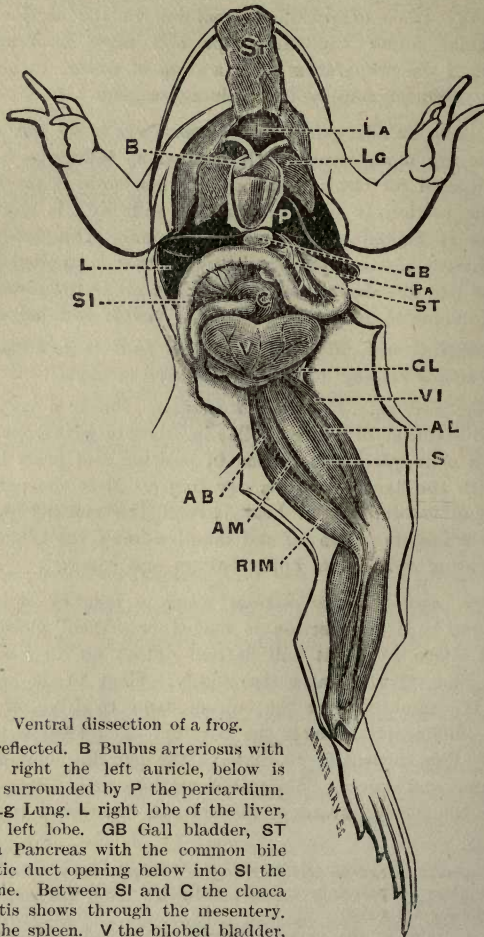

FIG. 4. Ventral dissection of a frog.

St Sternum reflected. B Bulbus arteriosus with aortæ, to its right the left auricle, below is the ventricle surrounded by P the pericardium. La Larynx. Lg Lung. L right lobe of the liver, P is on the left lobe. GB Gall bladder, ST Stomach, Pa Pancreas with the common bile and pancreatic duct opening below into SI the small intestine. Between SI and C the cloaca the right testis shows through the mesentery. Above C is the spleen. V the bilobed bladder, distended with air. Muscles of the thigh:—GL Gluteus, VI Vastus internus, AL Adductor longus, S Sartorius, AB Adductor brevis, AM Adductor magnus, RIM Rectum internus major, below it in the leg the gastrocnemius.

Injection of a frog¹ with corrosive sublimate and preparation of its tissues for microscopical examination. A frog, killed with ether, is laid on its back on a frog plate in a zinc tray. Divide the skin in the middle line from the centre of the abdomen to within half an inch of the mouth, raise the skin and note where there are large cutaneous vessels, make two transverse cuts so that the skin can be turned back freely, and open the body cavity near the middle line, avoiding the central vein in cutting through the muscles of the abdomen. Next raise the sternum by its cartilage with forceps, free it and divide the ribs on each side, and turn it upwards, thus gaining free access to the heart. Open the pericardium, hold the heart so as to put the aortæ on the stretch, and with fine forceps pass a thread under each near its origin, scraping through the confining connective tissue to do so. Form a loop on each thread ready for tightening. Next raise the heart, snip into the sinus with scissors, cut off the apex of the ventricle, and let all the blood escape. Wash away blood from the body cavity with normal saline. Tie the right aorta, and into the left introduce a fine glass cannula through the opening in the ventricle. The

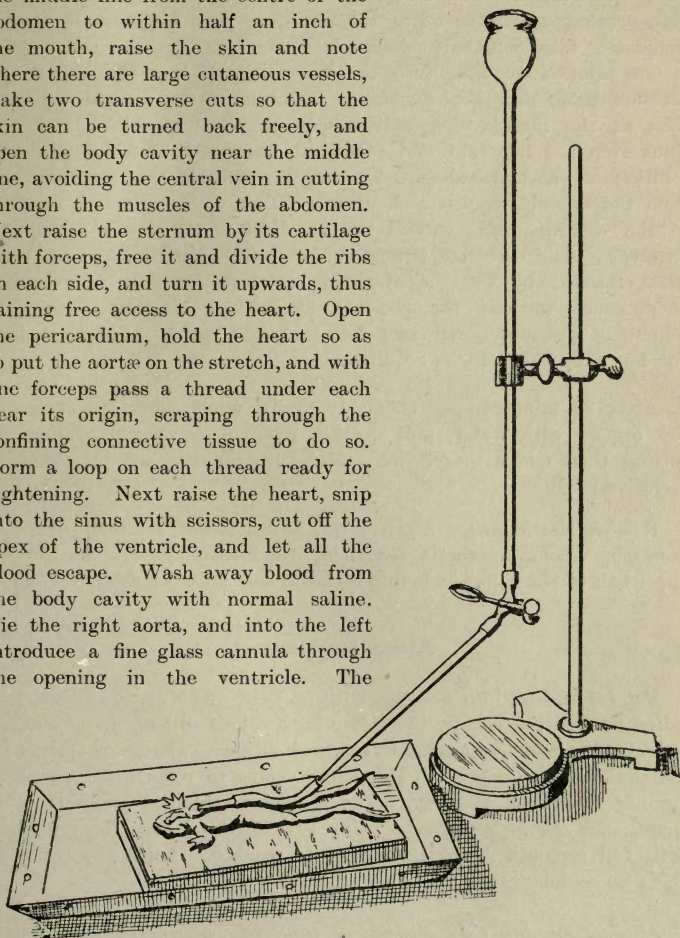

FIG. 5. Simple class appliance for fixing animal tissues by injection.

¹ The same principles will apply for injecting any small mammal, i.e., mouse, rat, small kitten or rabbit, or a separate organ.

cannula filled with salt solution is passed in as far as it will go, and is tied in by tightening the loop, secure this by a second knot. Fill the cannula completely with salt solution by means of a fine-pointed pipette to displace air bubbles, and slip the short rubber connection of the glass-pressure apparatus on to the cannula. The latter must also be completely filled with salt solution before connecting. The salt solution is now allowed to flow into the vessel by opening the clip on the pressure tube, and the remaining blood is to be washed out. As soon as the fluid comes only faintly tinged with blood from the sinus stop the injection and substitute saturated corrosive sublimate solution in normal saline. To do this detach the pressure tube from the cannula, empty and, after refilling with corrosive, re-attach to the cannula, being careful not to displace the latter during the operation. The corrosive is now run in. The tissues will turn white when reached by the reagent, and the injection will be complete. If necessary increase the pressure by raising the thistle tube. A column of pressure nearly two feet in height can be brought to bear, but less than this will be required.

After 20 minutes open the body cavity freely, rinse the surface of the organs with water, and quickly remove the parts required by cutting them out with scissors. (Metal instruments are blackened by corrosive.)

Remove the following organs :—(a) Liver, Kidneys, Small Intestine, Stomach, Vago-sympathetic Ganglion, Gastrocnemius Muscle, (b) the upper half of the femur including its head, and (c) both Eyes.

After Hardening

Put (a) and (c) into a bottle with 50 c.c. of 70 p.c. alcohol tinted with iodine to a sherry colour, the latter loses colour so long as uncombined corrosive is present and must be renewed with each change of spirit until the discoloration ceases. The iodine helps to remove the corrosive, forming iodide of mercury. The alcohol is changed every 12 or 24 hours, each 24 hour's change being 10 p.c. stronger than the preceding, until full strength methylated spirit is reached. Label the bottle for guidance as follows :—

Always employ this system of labelling when carrying out a process.

ORGANS (FROG)		NaCl.	Corr.	Inj.
May 10	-	-	-	70 ^{p.c.} Alc. + I.
„ 11	-	change to	80	„
„ 12	-	„	90	„
„ 13	-	„	Spt. Meth.	
No.		Name		

Draw your pen through each direction as the change is made. The tissues will be ready, at the earliest, in four days for embedding and cutting. Longer exposure to spirit will confer a beneficial toughness upon the tissue.

These and the remaining steps in the preparation of tissues are as far as possible spread over subsequent meetings of the class. In the intervals due attention must be given to the tissues which are in the course of preparation, i.e., changing of fluids, &c. The reagents mentioned, with the exception of absolute alcohol, are provided in the laboratory.

Decalcification of osseous tissue.

Place (*b*) in bone softening fluid (14a, see Appendix). Examine in 24 hours, [and as soon as it becomes pliant or feels soft to a needle point introduced into it, wash in changes of water until the colour is removed and after-treat with alcohol. Bones are usually best cut in frozen gum, but this specimen being small will cut well in paraffin.

Staining in bulk.

Small pieces are next to be stained in bulk, as follows: cut parallel sided slices or rectangular blocks not more than 3^{mm} thick (■■■■■), the other dimensions being governed by the nature of the organ. Put one set into a tube with 10^{cc} hæmalum solution (22) and another into a like quantity of borax carmine (17) in which they remain 48 hours or more, according to their density. The first are then thoroughly washed in water for 12 hours to remove the superfluous stain, and are then placed in 70^{p.c.} alcohol and through increasing strengths to absolute alcohol. They may be ground-stained with eosin

by tinging the last alcohol with the stain. Those treated with borax carmine are placed in acid alcohol (17) for 24 hours, this makes the red brighter, and thence are passed through increasing strengths of alcohol as in the former case.

Section Cutting.

The razor must have a keen straight edge and a stiff back, and must not be hollow ground.

Hand cutting. Holding the piece of tissue in the left hand, between the thumb and forefinger, and the razor in the right, guide the razor upon the forefinger of the left and cut thin slices by steady heel to point strokes of the razor. Keep the blade of the razor and the surface of the tissue moistened with spirit or other fluid in which the tissue happens to be preserved. The piece of tissue may be held between pieces of hardened liver or elder pith.

As tissues generally require support, owing to the delicateness of their structure, it is usual to embed them in a material which will permeate them. In order to make even and thin sections a microtome is employed. Three principal methods are in use as follows:—

Employ the prepared tissues of the frog in illustration of the following methods, thus:—

Tissues (a) and (b) are to be cut in paraffin.

“ (a)	“	“	<i>gum.</i>
“ (c)	“	“	<i>celloidin.</i>

Embedding and cutting in paraffin.¹

Transfer the pieces of tissue into fifteen times their volume of absolute alcohol for 24 hours in order to complete their dehydration. Then “clear” them by a corresponding immersion in toluene. This is for general purposes the best intermediate solvent. This step is required because alcohol will not mix with paraffin.

When cleared (24 hours) they are ready for embedding. Wipe off the surface toluene and immerse the pieces in melted paraffin (melting point 55° C.) for one hour to an hour and a half in the embedding bath.

¹ Very delicate tissues require to be guarded from the collapse of cavities which is apt to occur with this process by a more gradual transference to paraffin, this is accomplished by transferring from alcohol to chloroform, and when the latter has quite replaced the alcohol, the tissue sinks in it. Then place in a fresh quantity of the fluid and add shavings of solid paraffin until no more dissolves. Allow the fluid to thicken by evaporation, warm to the temperature of the embedding bath, and transfer to pure melted paraffin in the latter.

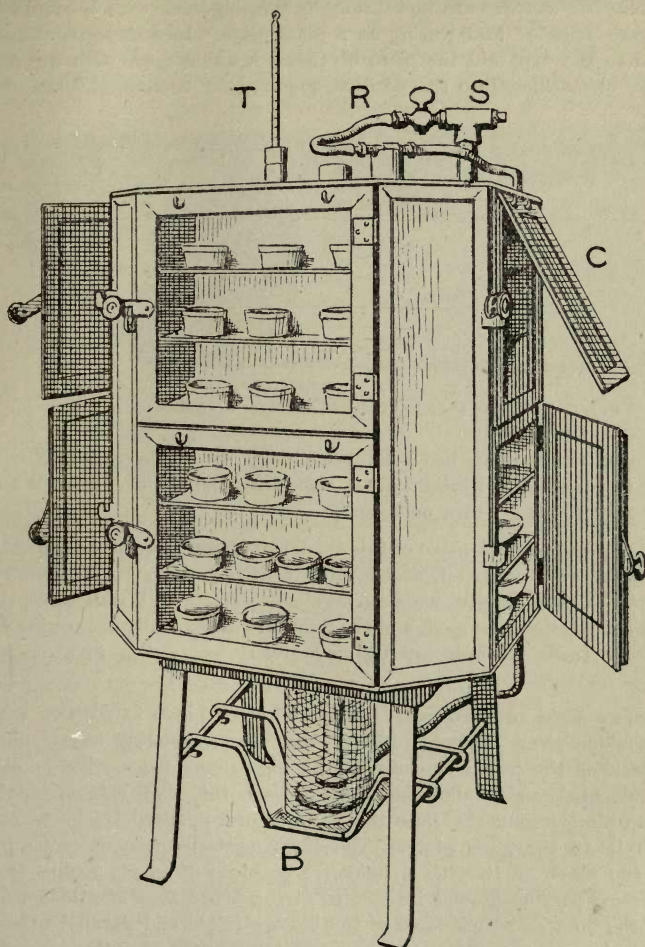

FIG. 6. Embedding Bath for the use of students in class, Yorkshire College. Around a central water cistern are six shallow closets with shelves. Each closet has a glass-panelled door, over which a non-conducting flap C hangs, removed from the front closets for clearness. R gas from S supply to regulator and thence to B, a Fletcher's safety burner; all metal piping. T thermometer. (Made to the author's directions by Messrs. Braithwaite & Co., Swinegate, Leeds.)

Blocks for cutting are now made by forming cells with a couple of L-shaped strips of lead resting on a glass plate. Into these paraffin is poured to the top, and the piece of tissue is submerged, with warmed forceps or needles, into the position required for cutting. When the

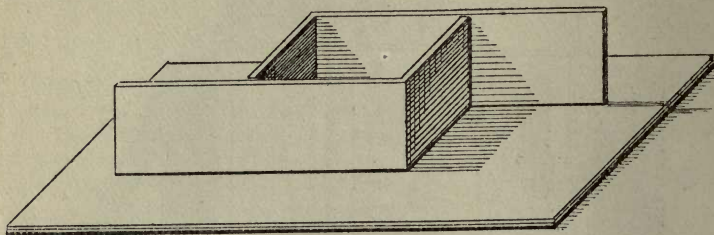

FIG. 7. Mould of L-shaped strips of metal for embedding in paraffin.

surface of the paraffin has solidified plunge the whole cell into cold water to complete the solidification, then strip the block of its cell and it is ready to attach to a microtome.

Small pieces of fresh tissue of this thickness (■■■■) may be dehydrated, penetrated with clove oil, and saturated with paraffin by 20 minutes' exposure to each reagent, assisted by slight warmth. If ten times the volume of the tissue be used, and the fluids are individually changed three successive times, a block can be made ready for cutting in about an hour.

Horse-shoe microtome. Clamp the razor blade in position with its shoulder clear of the frame. Raise the regulating screw until the back of the frame is close to the glass; the razor edge is now fully elevated above the glass plate, from this the height of the paraffin block is gauged. Pare the latter to the required thickness, and attach it to the glass plate. The glass must be free of moisture; melt the block to it with a hot wire or blade of an old scalpel, and bank some paraffin around its foot to give a broad base of attachment. Trim the front and back faces of the block straight and parallel to each other. Secure the glass plate to the table with a piece of moist blotting paper. The left hand holds the carrier, the thumb and forefinger of the right hand grasp the regulating screw, the other fingers lying on the frame as an additional guide, the wrists rest upon the table and by a simultaneous movement of both hands the frame is carried forward with a quick and even swing to which the weight of

the frame adds steadiness. As the frame is carried back for the next stroke the regulating screw is turned clockwise through a small fraction of a turn by the fingers which grasp it, this lowers the razor edge and determines the thickness of the next section. By keeping

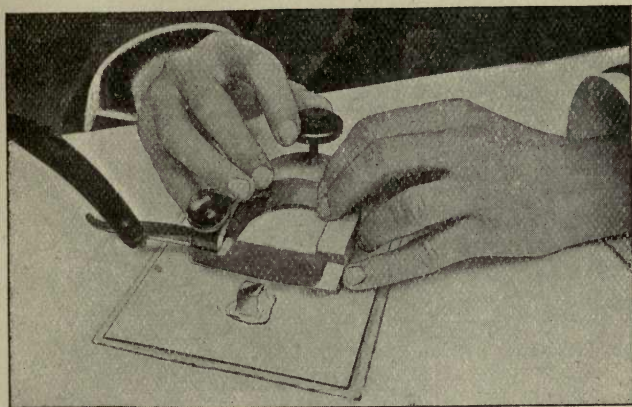

FIG. 8. Method of using the horse-shoe microtome.

the wrists firmly upon the table the same part of the razor edge is used at each successive cut, a matter of importance, as the edge is generally curved, and lateral displacement would vary the thickness. Short ribbons of six or seven sections adhering to each other may be cut.

Imperfect embedding, causing want of homogeneity, and grittiness in cutting, is due to imperfect removal of water and alcohol in the substitution processes, and can only be cured by retrograding through the successive steps to alcohol and back again to paraffin.

Blocks and sections can be preserved in pill boxes for later use.

Rocking microtome. (Cambridge Instruments Company.) This instrument cuts ribbons, i.e., successive sections adhere to each other. The block of paraffin containing the tissue which is to be cut is fastened to a brass thimble by means of a hot wire, and its front and back edges are pared straight and parallel to each other. Slip the thimble **A** into position on the end of the rocking arm **B**. From the other end of **B** a cord passes from a clamping ring over guide pulleys to the lever **C**. By the to and fro movement of **C**, **A**

is caused to make up and down strokes. The latter movement cuts the section by carrying the block across the razor edge, the spring **D** supplying the force. The block is moved forwards for each succeeding section by tilting the rest **E** razorwards. The tilting is accomplished by turning the screw **F**, which raises that end of the rest. **F** is rotated by a catch **G** on the lever **C** which engages the teeth on the large disc of **F**. The catch **G** carries a pin which projects downwards and rests against a sector **H**. The latter controls the position of the catch so that it passes clear of the disc during

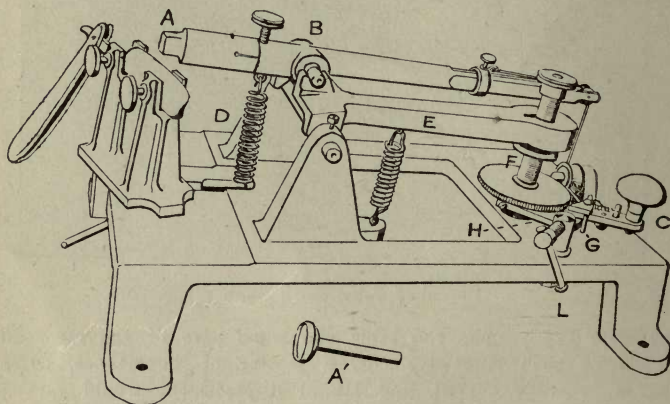

FIG. 9. Rocking Microtome (modified), see text. **A'** additional block-holder (Durham).

the cutting of the section, i.e., down stroke of the block **A**, and also during its up stroke until **A** has passed clear of the razor. The thickness of the section is fixed by the number of teeth through which the disc on **F** is moved and this again is determined by the relative position of **H** which controls the catch **G** (each tooth equals a thickness of $4\ \mu$). Adjustments are provided for regulating (1) the thickness of the section, (2) the excursions of the rocking arm, and (3) the position of the razor.

In the original form of this excellent instrument, the razor is carried in a fixed support. The movable carrier illustrated above allows, without loss of rigidity, of great freedom of orientation in two directions, whilst the third direction is obtained by turning the brass thimble itself. This modification, together with the adjusting

ring for the cord and the variable stop **L** were suggested by H. E. Durham (Proceedings Physiol. Soc., *Jl. Physiol.*, Vol. xix., p. xvi.). The movable carrier also permits different parts of the razor to be used and the ring enables one to fix the rocking arm in any position without danger of its slipping.

Freezing and cutting in gum mucilage.¹ Crystalline sugar 1 oz. in 1 fl. oz. water, gum mucilage (1 lb. gum accacia to 8 fl. oz. water) 5 oz., water 9 oz. Mix, filter, and add thymol or carbolic

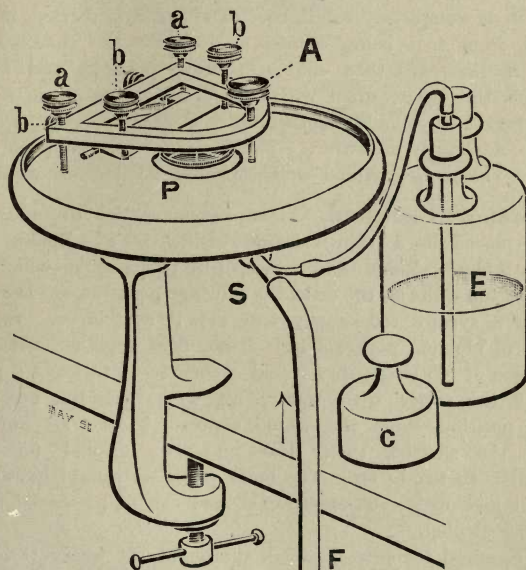

FIG. 10. Williams' Ether Freezing Microtome. (Made by Swift).

P Metal cap upon which the tissue is placed, fixed by a vulcanite collar in the glazed platform, which is supported by a pillar clamped to the table. **S** Atomiser actuated through **F** by a foot blower. **E** Ether bottle. **C** Wooden cap to cover the tissue whilst it is being frozen. The knife sledge is supported upon screws **A** for lowering the razor after each cut, **aa**, for levelling the edge of the razor. Two vertical screws **bb**, for adjusting its slope and two horizontal ones for fixing it in position.

¹ The method of freezing by means of ice and salt was introduced into histology by Prof. W. Rutherford in 1872, Dr. U. Pritchard suggesting the use of gum for embedding, to which Dr. D. J. Hamilton (then of Edinburgh) subsequently made the addition of syrup to prevent crystallisation. Mr. Bevan Lewis, West Riding Asylum, introduced ether as a means of freezing in 1876.

acid, to preserve it. The tissue must be completely freed of alcohol or chromium salts by irrigation, for 24 hours, in running water; it is then left in the gum for a like period, or longer. The more thorough the impregnation the better will the mass cut when frozen. It should then present a cheesy consistency. A microtome is necessary, such as Williams', in which the freezing is accomplished by means of ether. The block of tissue, $\frac{1}{4}$ to $\frac{3}{8}$ in. thick, is placed on the brass plate with the adherent gum, is covered with a non-conducting cap, and the ether spray is operated until the whole mass is completely solidified. The razor is carried in a tripod frame, the front foot being turned to regulate the thickness of the section. Sections are then cut as thin as possible, and are transferred from the razor, upon which they accumulate, into a bowl of water. Here they should remain until cleared of gum, which may necessitate a change of water. The sections may be kept for later use in 90 p.c. alcohol, provided well-stoppered bottles are used.

Embedding in celloidin. Tissue previously dehydrated in absolute alcohol is placed in a thin solution of Scherer's celloidin in equal parts of absolute alcohol and ether, the preparation which at first floats at the top sinks as the celloidin solution penetrates. Let the fluid thicken to a syrupy consistency and set it as follows. Construct a receptacle of blotting paper, a lidless box held together with pins, or wrap a piece of blotting paper round a cork so as to leave a projecting tube; wet the paper with water, fill with celloidin, and put the tissue in position, leave the whole exposed to the air until a film forms on the surface, then float on 70 p.c. alcohol (or place in chloroform) until firmly set. The mass when set should have a nearly transparent and opalescent appearance, and can be preserved for future use in 80 p.c. alcohol.

When required for cutting, wash thoroughly in water (1 hour), and then immerse in gum-freezing mixture for 10 to 20 minutes, and freeze on a Williams' microtome. It is not desirable that the celloidin itself be frozen, it is enough if the gum fixes the mass to the plate of the microtome, as the embedding material gives the necessary support. The block held in the hand can be cut directly with a razor moistened with alcohol. It must not be allowed to dry. The sections are placed in water, stained, and mounted. To mount in balsam, clear with origanum oil which does not dissolve celloidin.

Synopsis of Treatment for Embedding Tissues and
for Staining and Mounting Sections.

THE TISSUE IS PRESUMED TO BE IN ABSOLUTE
ALCOHOL.

To embed in gum.

To embed in paraffin.

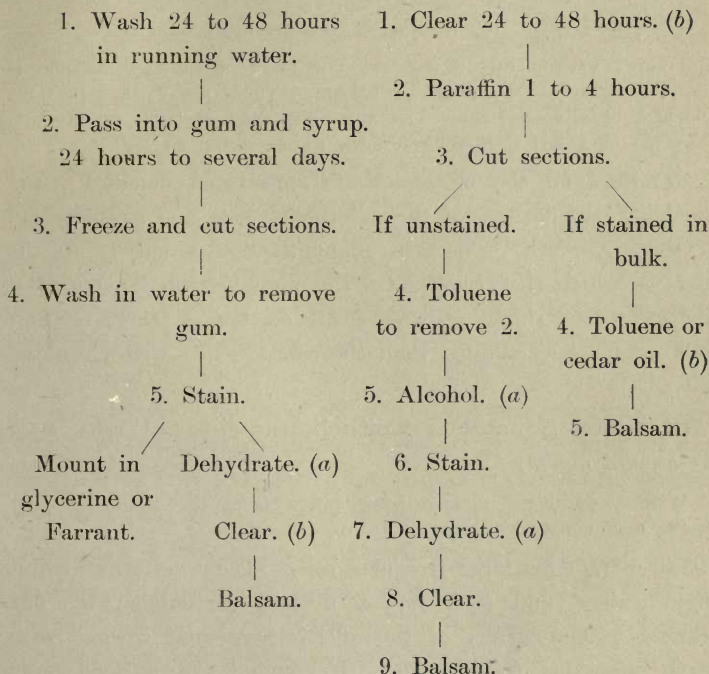

(a) Absolute alcohol.

(b) Toluene.

A piece of tissue or a section which has been allowed to dry is spoilt.

THE SIMPLE TISSUES.

The methods of preparation are indicated by the following abbreviations:—p.=Preparation. s.=Stain. c.=Method of cutting, G.=Gum, P.=Paraffin. C.=Celloidin. m.=Mounting fluid to be employed, B.=Canada balsam, F.=Farrant, Gl.=Glycerin. The numbers refer to paragraphs in the appendix.

Endothelium. *Omentum of a guinea pig.*

Treated with nitrate of silver. The piece of tissue in alcohol is placed in water. Mount it in balsam. There are thicker portions in which blood-vessels run. Cut away the thickest parts by pressing the edge of a knife where you wish to sever the tissue.

(H) Find on the more delicate fenestrated omental tissue the blackened outlines of the endothelial cells, due to the action of the silver salt. The cells adapt themselves closely to the surfaces which they cover. On the non-fenestrated portions of the membrane single cells or small clusters of three or four cells more deeply stained than the rest are met with (germinal cells).

Stratified Squamous Epithelium. *Detached cells from the human mouth.*

With your finger remove some saliva from the inside of your cheek, mount between glasses.

Search (H) for large irregular cells. Their surfaces exhibit slight ridges, and each has a nucleus surrounded by fine granules. The surface of the cells is frequently covered with coarse granules (micrococci). To render the nucleus more evident, stain with magenta or Spiller's purple by irrigation. Watch the staining taking place under a low power, and

arrest its progress when sufficiently developed by running water through until the diffuse colour is removed. Note films of precipitated mucin and also salivary corpuscles.

Human Skin. V.S. (p. 11, s. 22 & 24, c. P., m. B.)

(L) Note the epidermis resting upon and filling up the irregularities of the dermis. The epidermis consists of two main layers—the *horny layer*, externally, resting upon the *rete mucosum*, from which it is sharply defined by the thin *stratum lucidum*.

(H) In the lowest layers of the *rete mucosum* the cells are elongated (germinal cells), those above being polygonal, and the highest somewhat flattened and of a granular appearance (*stratum granulosum*). The cells composing these layers are united to each other by numerous fine filamentous bridges, hence named “*prickle cells*.” A continuous system of channels is thus left between the cells up to the stratum lucidum for the percolation of lymph (formation of a blister).

The stratum lucidum is formed by the accumulation of *eleidin* produced by the cells of the stratum granulosum. It can be detected accumulating as a thin layer between them, gradually thickening to a continuous layer in which cell outlines are lost. The cells of the horny stratum are much flattened and compressed; they are the dead remains of the malpighian cells, and do not exhibit marked differential staining. Excepting in rare instances no traces of nuclei are visible. Osmic acid blackens the inner and outer portions of the horny layer.

Mitosis. *Nuclear filaments* from the salivary cells of the chironomus larva. A common inhabitant of the mud of stagnant waters. It is about half an inch long, red in colour, and progresses by jerky unbending from a C shape.

Pull the head off with forceps, cover in normal saline, irrigate with an aqueous 2 p.c. solution of methyl green until

stained. Wash with water acidulated with acetic acid, and replace the latter by glycerin. (*H*) Find the nuclei of the large salivary gland cells, and in them the coiled and obvious nuclear filaments.

V.S. Jaw of young newt. (p. 9, s. 22, c. P., m. B.) Find amongst the lower epidemic cells nuclei, showing the *convolute* and *aster* stages, these are the most easy of recognition.

5 Columnar epithelium. V.S. *Stomach of an adult cat.* (p. 3, s. 22 & 24, c. P., m. B.) (*L*) Recognise the ducts of the gastric follicles, wide and somewhat oval recesses into which the tubular gastric glands open. (*H*) Their cavities as well as the general surface of the stomach are covered with this variety of epithelium. The cells are taller than they are broad, are enclosed in a thin cell membrane, the contents of which are clear and traversed by a delicate cytoplasmic network, the nucleus is placed near the attached end. Under certain methods of treatment intercellular bridges are seen between them (Carlier).

Epithelium of the small intestine. V.S. *Small intestine—cat, dog, or newt.* (p. 11, s. 22 & 24, c. P., m. B.)

(*L*) Find the *villi*, column-like projections of the mucosa into the cavity of the gut. On their surface (*H*) a single layer of columnar nucleated cells, with a *marginal hem* on their free surface. This is the sectional appearance of the *end plate*, which is probably composed of short prismatic rods set close together on the end of the cell. Sections of the cells showing the plates in surface view are to be sought for, they appear as polygonal areas with fine punctate markings. In the intestine of the cat, among the columnar cells, *Whatney's buds* may frequently be met with, these consist of zones of cells arranged transversely around the villi, which in sectional view appear as clusters of cells tapering towards their free ends. Whatney described

these as cells in a state of proliferation. *Chalice cells*, unicellular mucous glands, are numerous amongst the columnar cells. Some are full of a transparent secretion (mucigen), others empty and collapsed. The former are like footless wineglasses. Leucocytes occur frequently between the cells.

Ciliated Epithelium. *Trachea of a child.* T.S. (p. 8, s. 22 & 24, c. P., m. B.) (L) Find the inner layer. (H) The free surface is covered with columnar ciliated epithelium, the lower layers of cells are pear-shaped or rounded, and rest upon a well defined basement surface. The epithelium is renewed by the proliferation of the lowest cells.

Isolated ciliated cells from the pharynx of the frog (p. 24 to 48 hours in 33^{p.c.} alcohol, coloured by Picrocarmine (Ranvier) m. Gl.) (H) Irregular wedge-shaped nucleated cells, the free ends of which are tufted with *cilia implanted in a marginal zone*. *Chalice cells*, some full of granules (mucigen) stained yellow, others empty, occur in considerable numbers.

Ciliary action.¹ Open a mussel by cutting through the hinge, Fig. 11, then pass the knife between the shells to sever the adductor A and soft parts. The thick border of the mantle lies within the long side of the shell. It retracts on being touched if the mussel is alive. Lying upon the mantle in a double layer is the gill. Cut out a small piece of the gill with scissors, place it on a cover-glass in a drop of fluid from the mussel, and separate the two layers. Invert the preparation (*hanging drop*) upon a cell formed of three thicknesses of blotting paper, cut so as to fit the slide, and with a central aperture $\frac{5}{8}$ inch in diameter, and moisten with salt solution. Fig. 12.

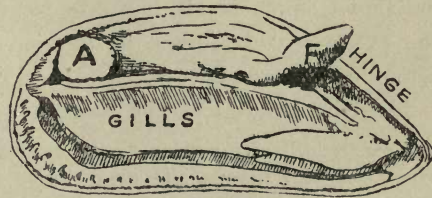

FIG. 11.

¹A scraping from the pharynx of the frog diffused in normal saline answers very well.

(L) The gills consist of bars with clubbed free ends, along their edges recognise the movements due to ciliary action. (H) On the edges of the bars the cilia are seen in full face curving towards or away from the observer, whilst at the free unbroken

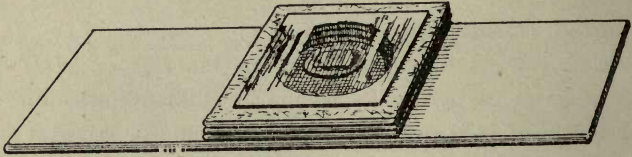

FIG. 12.

ends they are seen in side view. Note the direction of the movement and the manner in which the cilia bend. The currents produced are indicated by the movements of the floating particles in the fluid. Detached pieces of gill occur rotating under the influence of their cilia.

Effect of chloroform or ether. Raise the cover, introduce a small drop of the reagent into the cell, and replace the cover.

Watch the gradual slowing and ultimate arrest of the movement. As the movement slows observe the way in which the individual cilium bends, it curves from the tip downwards and the extension takes place in the converse direction. If the action of the reagent has not been excessive motion can be restored by removal of the reagent.

Free the cell of its gaseous contents, lift off the cover, remove the paper cell with forceps, and after rinsing the latter in water replace them in position.

The ciliary action will slowly return. This is an instance of the action of an anæsthetic upon living protoplasm.

Effect of heating. Using the same preparation and omitting the paper cell, place it on the hot stage upon the stage of the microscope. Turn the end of the tin plate which projects beyond the stage slightly upwards

and set the flame of the bunsen burner under this part. Guard against over-heating by periodically testing the plate between the stage and flame with your finger.

The ciliary movement quickens. If the temperature be sufficiently elevated the motion will cease (*heat stiffening*).

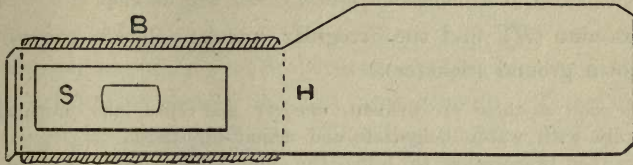

FIG. 13. Hot stage. A plate of tin insulated from the stage of the microscope by a piece of blotting paper B, S the slide through which is seen the central opening in the stage, H line along which the plate is bent up; the flame is placed under this end.

Secreting Epithelium. See digestive tract.

Connective tissue proper. *Areolar tissue.* Spread a small piece of the subcutaneous tissue of a mammal (rabbit or rat), by means of needles, on a dry slide, into as thin a film as possible (*semi desiccation*), breathing upon the tissue from time to time to obviate drying. Moisten with normal saline and cover. 6

Recognise the following: (a) *White fibres*, transparent wavy bundles exhibiting delicate longitudinal markings. (b) *Elastic fibres*, fine straight filaments, some of great tenuity with distinct though infrequent branchings, broken ends tend to curl up into irregular coils. Their higher refractive index gives them a sharp outline when in focus. (c) *Connective tissue corpuscles*, difficult to detect in the rabbit, more easily seen in the rat and guinea pig.

Effect of acetic acid. Irrigate with 1 D.C. solution.

Observe that the white fibres are rendered more transparent and that they swell. Constrictions may be made out in places where a ring-like filament encircles a fibre. The elastic fibres now appear distinct, and the corpuscles or at least their nuclei become evident.

Stain the cells. Irrigate first with water to remove the acid, and then stain with hæmalum. When the staining is completed wash with water, and after removal of the cover dehydrate, clear and m. B.

Cell spaces in areolar tissue. Treat a thicker film obtained as above with a drop of AgNO_3 sol. 1^{p.c.} and expose it to bright sunlight, in 15 to 20 minutes a brown colour will develop.

Examine (*H*), find the irregular uncoloured cell spaces on a brown ground (Schäfer).

As soon as these are evident, uncover and rinse the preparation carefully with water, dehydrate and mount in balsam.

Another preparation to bring the *elastic fibres* into view can be made by irrigating a fresh specimen with Spiller's purple, which stains them violet. (Roseanilin nitrate stains them red—"Schäfer.")

Tendon. *Fresh tendon.* Rat's tail teased in normal saline. (*L*) Consist of bundles of white fibrous tissue upon which (*H*) rows of cells are indistinctly recognisable.

Effect of acetic acid. The tissue clears and swells and the cells come into view arranged in rows, each with its nucleus. Very little elastic tissue is visible.

Stain with hæmalum as above.

Treat a fresh portion in AgNO_3 solution for cell spaces and outlines of the epithelial tendon sheath.

Fresh tendon from the frog's foot may be obtained by seizing the tip of a toe with strong forceps, and pulling a tendon out of the foot with it.

7 *Rat's tail.* T.S. (p. 14 (*b*), s. 22 & 24, c. P., m. B.) (*L*) Find the tendon bundles lying in grooves around the vertebrae. Recognise the sheaths of fibrous tissue which surround them, and (*H*) the tendon cells branched and deeply stained, which are distributed between the tendon fibres.

Rat's tail. L.S. (Prepared as above.) Note the regular arrangement of the tendon cells into rows, the position of their nuclei, and the spread of their protoplasm. The proto-

plasm often exhibits a ridge-like marking at the thickest part, which extends along the row, this is due to the moulding of the cells by neighbouring bundles, and is known as Boll's stripe.

Tendon of a large mammal. T.S. (p. formol 4^{p.c.} and acetic acid 1^{p.c.}, each 1 week, c. G., s. 19, m. F.) The tendon cells are much less numerous proportionately, than in the rat's tail, and are not so regular in their arrangement. Their number is largely a question of age. In young tendons they are much more numerous. Fine elastic fibres are present, and are to be recognised as small dots in the white fibrous substance.

Yellow fibrous or elastic tissue. *Ligamentum Nuchæ*, Ox., (p. 2 (d), s. 19, m. F.).

Tease some of this tissue digested in *acetic acid*, it is more readily dissociated than the fresh tissue, as the white fibrous tissue has been softened by the acid.

(H) The fibres branch and form a network of elongated mesh, the coarser fibres occasionally exhibiting transverse linear perforations. On the concavities of bent fibres slight transverse corrugations may be perceived, these are indicative of a surface membrane. No nuclei are visible in or immediately connected with the fibres.

Ligamentum Nuchæ (p. 2 (d), c. G., s. 19, m. F.). L.S. The Elastic tissue fibres, stained yellow by the picric acid, are surrounded by white fibrous tissue stained pink, in the latter nuclei are recognisable, but none in the yellow tissue. Observe the *branching of the fibres*.

T.S. (H) Note the yellow fibres cut across, forming *irregular clusters*, embedded in the pink white fibrous tissue as before. In the large arteries elastic tissue occurs, resembling the above, but of finer texture. See later.

Retiform or adenoid tissue. *S. of a Lymph Gland of an ox or sheep.*

Injected interstitially with a 0.25 per cent. sol. AgNO_3 , hardened in alcohol, cut by freezing in gum, and stained with Hæmatoxyline, m. B.

(L) Find the *lymph sinus* in the outer part of the section, (H) recognise the delicate branching tissue extending across the spaces, on this find endothelial outlines and the nuclei belonging to the cells. The supporting material is connective tissue (gelatinous tissue). Numerous cells, the *lymph corpuscles*, are distributed throughout the meshes of the branching material, very closely crowded in the *follicular tissue* outside the sinuses. These cells are identical with the white corpuscles of the blood and originate from the *epithelioid elements* upon the branching tissue.

Take a section of the fresh gland, cut by freezing, shake it vigorously in normal saline in a test-tube for a few minutes. Mount the fragments in Farrant's Solution, tinged with Picrocarmine. The retiform tissue, now cleared of the corpuscles, will show its finer branchings.

- 8 **Fatty Tissue.** *Epiglottis of kitten or young human skin.* V.S. (p. 3, s. 22 & 24, c. P., m. B.) (L) Find fat cells stained black by the osmic acid. (H) Trace the accumulation of fat in the cells, first as small granules in the peripheral cells, growing to mulberry-like masses in others, and ultimately to a single large globule which distends the cell uniformly. Fatty tissue will be of common occurrence in the tissues and organs studied in the sequence.

After treatment with essential oils for the purpose of embedding in paraffin the cell envelopes are usually found empty, their contents having been removed by the solvent. Fatty tissue mounted in glycerine exhibits crystals of trimargarine and tristearine, triolein only remaining fluid at ordinary temperatures.

Mucous tissue. *Umbilical cord, man.* T.S. (p. 12, c. G., s. 19, m. F.) (L) The section is rounded; in it observe three circular structures, two arteries and a vein surrounded by connective tissues of an open texture. (H) In the latter are found branching cells with delicate irregular processes lying in a transparent matrix (mucinous substance) which exhibits a good deal of fibrillation in its later stages of growth.

Cartilage. *Hyaline cartilage. Young costal.* (p. 2 (d), c. G., s. 19, m. F.) (L) Externally there is the fibrous perichondrium inside this the substance consists of matrix, apparently structureless, in which the cartilage cell-spaces, irregularly fusiform in shape, are distributed. In the hardened specimen the cells do not always completely fill the spaces in which they lie, as they are usually somewhat shrunken. Towards the periphery, close to the perichondrium, the spaces often communicate with each other. In the interior the older capsules do not show these connections. The transition of the connective tissue cells of the perichondrium into those of the cartilage should be noted.

Cartilage of cuttle fish. (p. 2 (d), c. G., s. 19, m. F.) (H) The cell spaces occur in clusters, and from these fine branching channels run outwards to communicate with other groups and establish direct communications with their spaces.

Adult costal cartilage Human. (p. 2 (d), c. G., s. 19, m. F.) The cells are in clusters immediately around which the matrix is hyaline, outside this fibrillated, and in the aged and unsoftened tissue contains lime salts.

Articular cartilage. V.S. (p. 2 (d), c. G., s. 19, m. F.) The film of cartilage which covers the articular end of bones is hyaline. Near the free surface the cells are flattened, deeper down they are oval. The matrix close to the subjacent bone is fibrillated

and in the recent state calcareous. An irregular line separates the cartilage from the subjacent bone. Shallow depressions, recesses communicating with the medullary cavity and containing blood vessels, are visible; these become filled later with boss-like deposits of bone.

White fibro-cartilage. S. *Intervertebral disc* (p. 11, c. G., s. 19, m. F.). (*L*) The arrangement into concentric layers is most distinct at the periphery. (*H*) A gelatinous, fibrous-looking material, with scattered small clusters of cells in thin envelopes. In the centre of the disc, if included in the section, is seen an agglomeration of various sized cells with distinct capsules, and little, if any, interstitial substance. This is a relic of the *notochord*, and the nearest approach to parenchymatous cartilage in the human body.

Interarticular cartilages have the same structure, but the laminar arrangement is not present, the fibres of the matrix being more interlaced.

Spongy, yellow or elastic cartilage. T.S. *Epiglottis* (p. 3, c. G., s. 19, m. F.). (*L*) Externally stratified squamous epithelium under this connective tissue, pink, in it are mucous glands. The cartilage, surrounded by fibrous perichondrium, is perforated with large apertures filled with fibrous tissue containing blood vessels. The cartilage is tinted yellow. At its edges (*H*) observe the elastic fibres passing from perichondrium to matrix, and which beginning as fine filaments quickly further in pass into a close, spongy structure enclosing the cell spaces. These contain the nucleated cartilage cells.

Arytenoid cartilage. (p. 11, c. G., s. 19, m. F.) (*L*) Fibrous nature of the tip. (*H*) The matrix of the cornu is yellow fibro-, passing into the hyaline cartilage towards the base.

BONE.

Bone. (T.S.) Dried long bone of man.

Slices cut with a saw, ground thin, polished and mounted in balsam.

(L) The matrix of adult bone consists of thin layers or *lamellæ* composed of white fibrous tissue in a *calcified ground-substance*. The fibres of alternate lamellæ are arranged at different angles, and the lamellation is most easily recognised where one set is cut transversely. The general arrangement can be made out by observing the disposition of the *lacunæ*. These are oval flattened spaces in the lamellæ, the long dimensions of which correspond to the planes of the latter, and which, in the absence of soft parts, as in this case, are filled with air, and, in consequence, appear black. (L) The outer lamellæ are set parallel to the surface of the shaft (*periosteal lamellæ*). Further in they form concentric *Haversian systems*, each of which has in its centre a *Haversian canal*, the latter usually appears opaque, through being filled with detritus.

Among the periosteal lamellæ and between the systems are found here and there irregular rounded openings, the *Haversian spaces*, which have been eroded for the deposition of new systems. Where the cavity is still empty its outline is pitted. In others lamellæ are found lining them in greater or lesser numbers, the central cavity being proportionally diminished.

On the inner surface of the shaft are the *cancellous lamellæ*, forming a spongy network of greater richness the nearer the origin of the section is to the end of the bone. (H) The Haversian canals and the lacunæ intercommunicate freely by means of fine channels, the *canaliculi*, and the latter form at the periphery of the systems closed loops "*recurrent canaliculi*." Search for well-defined lamellæ in the Haversian systems.

Shaft of long bone. L.S. Similarly prepared. (L) The Haversian canals form a longitude system of *anastomosing channels*, which open both upon the outer and inner surfaces of the bone.

(H) The grouping of the lamellæ into systems is less recognisable. The Haversian spaces may be traced in favourable positions to be expansions of Haversian canals.

Cranial bones. The plate-like bones (L) exhibit an inner and an outer layer (*table*) of dense osseous material, separated from each other by cancellous tissue (*Diploë*).

Sharpey's fibres. In the outer lamellæ of dense bone fibres occur which traverse them vertically from the surface. These are some of the more obvious fibres of periosteal origin which have become included in the lamellæ during the growth of the latter. Some of them are elastic fibres.

Softened bone. (p. 14, c. G., s. 19, m. F.) The lime salts are removed and the soft parts preserved. (L) Externally is the *periosteum*, dense in its outer (fibrous) layer, and more open in its inner (osteogenic) layer. The latter is attached to the subjacent bone itself. These subdivisions are more striking in the growing stage. (H) Observe the fusion of the periosteal fibres to the *bone matrix*, especially where the *tendons* are inserted. The lacunæ, less sharply defined, each accommodate a *bone corpuscle*. The canaliculi being filled with fluid, do

not show clearly beyond their origins in the lacunæ. The Haversian canals are incompletely filled by blood vessels, around which are *perivascular lymph spaces*. The latter usually contain some fat.

The canaliculi open into the lymph spaces, their system becoming thus continuous with that of the lymphatics. Other features recognised in the dry preparation, should be sought for.

*Head of growing long bone.*¹ V.S. Distal end of femur. Kitten or rabbit. (p. 8, s. 22 & 24, c. P., m. B.) (L) Observe the cartilaginous epiphysis (possibly with cancellous tissue in its interior), find where it is implanted in the shaft, and note that the arrangement of the cartilage corpuscles in the latter part, is in rows parallel to the length of the bone. This is the *lifting zone*. On its inner aspect, the substance of the epiphysis passes into a network-like material, the *primary cancellous tissue*, which diminishes in quantity the further into the shaft it is traced. Examine (H) the lifting zone. The outer longitudinal rows of corpuscles form the *zone of proliferation*, deeper in, the corpuscles increase in size, the intervening matrix is diminished and has a faintly granular appearance, in the unsoftened

¹The long bone is originally laid down as a cartilaginous rod. This rod is cut across by the formation of the *primary medullary cavity*, thus yielding two cartilaginous heads or *epiphyses*. These are implanted in the ends of the tubular shaft which now becomes evident. The cartilaginous heads slowly recede in an axial direction from the shaft by changes in the cartilage itself, and the shaft *lengthens* by *growth at its ends*, and thus keeps pace with the receding epiphyses. Later the cartilaginous heads themselves become eroded and replaced by cancellous tissue which first gives in them the appearance of the so-called centres of ossification. The *lifting of the heads* occurs through the changes in the inner (sub-epiphysal) portion of the cartilage, i.e., that portion which is embraced by the end of the shaft, and which may therefore be called the *lifting cartilage*. Meanwhile, the shaft is increasing in thickness by sub-periosteal deposition, and it is maintained at a proportionate thickness by the *resorption* of material from its inner surface. All bone formation is due to osteoblasts and resorption to osteoclasts, both of which are corpuscular constituents of the periosteum, or of its continuation inside the medullary cavity, the *Endosteum*. All bones prefigured in cartilage, whatever their shape, undergo similar changes, modified to suit their particular case. Bones not or only partially preceded by cartilage are developed from periosteum, i.e., cranial bones, clavicle, &c.

condition it is calcified, *zone of increase*. Further towards the medullary cavity, the cells become replaced by a vascular prolongation of the marrow, *zone of invasion*, and the intervening matrix projects bare into the medullary cavity, where it soon gains a covering of osseous material. The latter is elaborated by the *osteoblasts*, which are seen in great numbers upon its surface. The honeycomb of cartilaginous matrix thus left standing and shrouded in bone, constitutes the temporary cancellous tissue. *Resorption* of this cancellous material now occurs by the osteoclasts, large many-nucleated corpuscles, which are found upon the surface of the network, or seated in shallow depressions of their own excavation. The reduction of the cancellous tissue is thus brought about. It serves the temporary purpose of a fixed point for the pushing off of the cartilaginous head. Note the tapering edge of the shaft outside the cartilage, and the strong fibrous periosteum which surrounds it and the cartilage in this region. In the recess formed by the projection of the condyles, note that the surface of the shaft under the periosteum presents excavations in which there are osteoclasts. The osteoclasts are acting as bone resorbers (*resorption area*).

- 10 *Shaft of growing bone of a young mammal.* T.S. Shaft (kitten). (p. 8, s. 22 & 24, c. P., m. B.) (L) The two layers of the periosteum are clearly defined, and the richness in corpuscular elements of the *osteogenetic layer* is striking when compared with that of the adult structure. The bone is open in texture. Instead of small canals there are large spaces, and Haversian systems are absent. The surface of the bone is covered by a layer of *osteoblasts*, excepting in those localities in which *osteoclasts* occur. Remains of marrow on the inner surface are usually recognisable. (H) The osteogenetic layer of the periosteum presents loose strands of connective tissue, which pass from

it to the bone matrix. Where the spicular outgrowths of the shaft are taking place, these fibrous connections are evident, and numerous osteoblasts surround and lie amongst their filaments. Osteoblasts are included at regular intervals in the newly-deposited bony matrix (*bone corpuscles*). Observe the gradual inclusion of the lacunæ, and the formation of the canaliculi as the deposition of bone proceeds.

Ossification of the head takes place by a process closely resembling that which occurs in the lifting zone below. The cartilage capsules, becoming enlarged by proliferation of the cartilage corpuscles and absorption of the intervening matrix, are invaded by marrow; temporary cancellous tissue is formed, which is ultimately replaced by erosion and surface deposition of bone until only a thin layer remains upon the surface of the head as articular cartilage and between the shaft and head as the disc of lifting cartilage. The final union of the head and shaft takes place when the lifting cartilage disappears.

Marrow. Carefully break up some *red marrow* in normal saline. (II) Find the following:—(a) Marrow cells proper (Kölliker), a little larger than leucocytes and with a large round nucleus or sometimes two. (b) Erythroblasts smaller than the last, nucleated, and having a reddish tinge in the fresh state. (c) Large many-nucleated cells—giant cells (Myeloplaxes of Robin), these are in many cases osteoclasts.

Red marrow. S. (p. 3., s. 22 & 24., c. P., m. B.)¹ Good preparations will be obtained in young bones. (II) Find the myeloplaxes and the other two varieties of cells. The sections should be very thin. Notice the wide thin-walled blood vessels in its substance.

¹ Or marrow treated in Ranvier's alcohol and picocarmine and mounted in glycerin jelly. Dried film preparations treated like blood films yield good preparations.

CHAPTER V.

DEVELOPING TOOTH.

Tooth. *Adult, in the jaw of a cat.* (p. 8, c. G., s. 19, m. F.) (L)
The tooth consists mainly of *dentine*. That part which projects beyond the gum is the *crown*, and is covered with *enamel* (here removed). From the *neck* downwards the *fang* is implanted in the *alveolar cavity*, and is covered by the *crusta petrosa*, a thin layer of bone. The alveolar walls are formed by the bone of the jaw. Between the jaw and the fang is the dense fibrous *peridental* tissue. In the middle of the dentine is the *pulp cavity* which communicates with the exterior through an aperture at the apex of the fang and through which blood vessels and nerves enter. (H) The dentine is traversed by numbers of minute canals, the *dentinal tubules*. Commencing on the surface of the pulp cavity they radiate outwards, dividing occasionally. Minute secondary offshoots leave them, most numerous near to and constituting their peripheal terminations. A zone of *inter-globular spaces*, better seen in dry preparations is found in the outer part of the dentine, especially in the region of the neck. They derive their name from the characters of their outlines. The *crusta petrosa* increases in thickness towards the apex of the fang; in it are found lacunæ, the matrix being the same as that of bone. The fibres of the peridental membrane are embedded in it, and form a tendinous attachment to the alveolar wall. The *pulp*, an open connective tissue texture, contains blood vessels, lymphatics, and nerves; the *odontoblast* cover its surface and lie in contact with the dentine, from them delicate processes

Tomes fibres pass into the tubules. They are better seen in the developing tooth. Find tubules cut transversely and note the appearance of a tubular wall.

Young tooth. Early stage. T.S. *Fore part of head of embryonic rat.* (p. 14 (b), s. 22 & 24, c. P., m. B.) (L) Find the cavity of the mouth, and the epithelium with stained nuclei which lines its surface. Note in each jaw, on each side, the *dental groove* filled with epithelium, from which flask-shaped prolongations project inwards, the future *enamel organs*. Each of these has a conical recess on its inner aspect which accommodates the *dental papilla*. The latter at this stage shows only as a collection of nucleated cells.

Young tooth. Later stage. V.T.S. *Jaw of kitten.* (p. 14 (b), s. 22 & 24, c. P., m. B.) (L) The *enamel organ* developed from the flask-shaped mass of cells, is larger and exhibits epithelium on its surface only, the interior of the organ being occupied by delicate branching tissue. The surface cells are squamous in single layer, excepting over the conical recess, which fits upon the papilla; here there are several layers, the most superficial of which is columnar. These columnar cells produce the enamel prisms. The *enamel* forms a thin layer, thickest at the apex of the cone and tapering towards the edges. It consists of *enamel prisms* set side by side. Where these are detached from the columnar cells processes from the latter should be sought for, which have been wrenched out of the enamel prisms, in which they were embedded.

In immediate contact with the enamel is a layer of dentine, forming a conical cap to the papilla, the tissue of the papilla or pulp of the tooth consists of a prominent layer of odontoblasts next to the dentine from which a narrow space often appears to separate them owing to removal of uncalcified matrix by the reagent and across which the *fibres of Tomes* run from

the odontoblasts into the dentine tubules. The papillary tissue is embryonic connective tissue in which capillaries and nerves ramify. After the crown of the tooth has been completed, the fang is produced in a like manner, but without enamel.

The space required for the enlarging tooth is provided by the growth of the jaw and the concurrent removal of osseous material on the inner aspect of the alveolar cavity by the osteoclasts, a number of which are observable upon the alveolar tissue around.

The dental germ for the permanent or secondary tooth occurs as a small lateral offset from the strand of epithelial material (gubernaculum), which still connects the enamel organ with the epithelium of the gum.

MUSCLE.

Non-stripped muscle. *Small intestine of cat.* (p. 11, s. 22, m. B.) Tease a piece of the muscular coat so as to dissociate the fibres; (*H*) find isolated fibres, fusiform in shape, with elongated nuclei.

Stomach of a cat. T.S. (p. 3, s. 22 & 24, c. P., m. B.) (*L*) Find the muscular coat composed of two layers of muscular fibre, one cut longitudinally the other transversely. In the latter the fibres appear as polygonal areas united to each other by a cementing substance, across which fine bridge-like connections may sometimes be observed.

The frog's bladder (Fig. 4) should be prepared as follows, to show this kind of fibre. Excise the organ, slit it open, and spread it, peritoneal surface downwards, upon a slide; scrape the epithelium off by stroking it with the pad of the finger, the tissue will be partly dried and will adhere to the slide as a nearly transparent film. Treat with a few drops of absolute alcohol, which will turn it opaque, cover it with a pool of hæmatoxyline, and observe the staining taking place; as soon as it is deep enough rinse with water, dehydrate with alcohol, to which a small quantity of eosine should be added as a ground stain, complete the dehydration and mount in balsam.

(*L*) A network of muscular bands of various sizes forms the substance of the vesicular wall, across the meshes of which (*H*) isolated fibres, with well-marked nuclei, are encountered. Three-branched fibres are occasionally met with. Blood vessels containing distorted corpuscles (nucleated) also unremoved surface epithelial cells are to be recognised.

Cardiac muscle. *Teased of sheep.* (p. 11.) Dissociate some of the tissue in a drop of picocarmine, the tissue cannot

be teased into separate fibres for any length, as it tends to break off short. (*L*) Note the branching nature of the fibres. (*H*) The well-marked cross and faint longitudinal striation, the nucleus in the substance of the fibre, and the abrupt transverse cleavage into short segments. These segments are the tissue units.

Cardiac muscle. L.S. *Man or sheep.* (p. 2 (*d*), s. 22 & 24, c. P., m. B.) (*H*) Note the transverse *cement lines*, stained, which define the segments. Each segment possesses a nucleus. In thin sections the latter may often be cut away and a segment may thus appear to be devoid of a nucleus.

The same. T.S. Observe the oval and often irregular outlines and difference in size, the central nucleus and the separation of the substance of the fibre into sarcoplasm and muscle fibrils (forming sarcostyles, bundles of fibrils).

Cardiac muscle. Dog. L.S. Coloured injection (p. 2 (*d*), 17 or 22, c. P., m. B.) (*L*) and (*H*). There is a rich distribution of capillaries parallel to the fibres with intercommunications. The arteries and veins give off their capillary branches in fan-shaped clusters.

12 **Striped Muscle.** *Fresh muscle.* Snip a small piece from the sartorius or gastrocnemius of the frog, tease it in normal saline, place a camel's hair across the fibres, apply the cover-glass and press it down slightly to produce local crushing of the fibres, then remove the hair.

(*L*) The fibres are cylindrical and marked with shadowy cross lines, *transverse striations*, hence called striped muscle. Each fibre is enclosed in a structureless sheath, the *sarcolemma*, recognisable where the substance of the fibre is crushed and retracted, or where the membrane forms a blister-like projection. Nuclei are difficult to recognise.

Action of acetic acid. Irrigate with a drop of the reagent, the fibre becomes transparent and the nuclei are seen distinctly inside it.

Crab's muscle, fully extended. (p.) Rutherford's method. Crab's legs are fastened to pieces of wood in the positions of flexion and of extension. The flat sides of the carapaces of the proximal segments are removed. Treat as follows:—1. Fix 24 hours in formol (1 to 9 water). 2. 24 hours to some days in methylated spirit. Tease a piece of the muscle finely in a longitudinal direction, treat it for two minutes with glacial acetic acid, wash with water, stain in strong aqueous eosin two minutes, wash and mount in glycerin.

The *broad dim stripe* is stained of a deep red,¹ and consists of a number of *rodlike bodies* (sarcous elements) with a slight central swelling (position of Hensen's stripe). The *light stripe* exhibits the *narrow dim stripe* or *Dobie's line* (Krause's membrane) running across it; to each side of this find egg-shaped granules, *Flögel's elements* (Englemann's accessory disc). The distinctness of the latter will depend upon the degree to which the muscle has been stretched.

Crab's muscle contracted. (p.) *In the same manner as the above.* This shows only a system of dim stripes closer together than and intervening light stripes without any appearance of the narrow Dobie's line. The clear stripe of the uncontracted state has in reality disappeared and the present dim stripe occupies its position. What now appears as the light stripe occupies the place of Henson's stripe. The stripes are thus reversed.

To see the *broadening of contracting fibres* the living structure must be examined², such as the leg muscle of *dytiscus marginalis* or *hydrophilus pisceus*, in salt solution or white of egg.

¹Rutherford used the term "chromatin" to designate the stained portion.

² See tongue of frog, pg. 63.

Isolated muscular fibres of kitten. (p. 34, Morpurgo's method.) A dissociated fragment of a muscle is given to you upon a slide, spread a little glycerine upon it, and carefully lay the fibres apart with needles, keep the fibres quite straight. Examine (*L*) and further dissociate until complete isolation of a few fibres has been accomplished. The entire length of the fibres will be seen, cover and examine (*H*) and sketch the ends.

Muscle for muscle spindles. T.S. Sartorius of child or small animal. (p. 3, s. 22 & 24 c. P., m. B.) (*L*) In the Interfascicular tissue find small blood vessels surrounded by what appears as an unusual quantity of connective tissue. (*H*) If a muscle spindle has been hit upon, the T.S. of a few muscular fibres will be recognised accompanied by small blood vessels. These are the presumed end organs for the muscular sense.

Tongue of dog or cat. T.S. Coloured injection. Recognise muscular fibres cut in various directions, note the longitudinally seen fibres of the transversus linguæ, attached to the fibrous tissue of the central "*Raphé*" of the tongue on the one hand, and on the other to the submucous connective tissue. (*H*) Fibres in transverse section show nuclei beneath the sarcolemma and the sarcoplasmic network between the fibrillæ. This feature, not equally distinct in all fibres, is more evident in young muscle. (*L*) The blood vessels are filled with a blue coloured mass, the capillaries run parallel to the muscular fibres, and are united at intervals by cross branches.



NERVE.

Medullated Nerve. *Fresh.*¹ Tease in normal saline a piece of the sciatic or the dorsal cutaneous nerve of a frog, cover and recognise.

(L) the cylindrical fibres colourless and transparent. (H) Single out a fibre, note its smooth appearance and double outline. Find a *node of Ranvier*, a constricted interruption of the medullary sheath, which occurs at long intervals (1^{mm}) on the fibre, very soon the sheath begins to lose its smooth appearance, through the swelling of the myeline, and exhibits corrugations. Just at the commencement of this change, at short intervals, the myeline exhibits slight inflections, or actual oblique slits, indicating a subdivision into shorter segments. These are the "*incisures*." The medullary sheath appears to be made up of short segments (*Schmidt-Lantermann*), the ends of which fit into each other. The semi-fluid myeline in the living condition, does not show these planes of cleavage, and hardening reagents do not always bring them into view, or with the same appearance.

Osmic nerve. Tease in glycerin some nerve which has been in $\frac{1}{2}$ p.c. osmic acid solution for 24 hours, well washed with water, and stained in picocarmine for several days, and then placed in glycerin.

(L) The myeline of the fibres is *stained black*, and there is connective tissue between them stained pink. (H) The nerve fibres are not all of the same size, and the smaller ones, owing to the thinness of their medullary coat, appear only faintly stained. Find a node in an isolated fibre, note

¹ Nerves in a living condition. See tongue of frog, pg. 63.

the *slightly bulbous enlargement* which precedes the constriction of each end. Find a second node along the same fibre, observe also that the medullary sheath now shows the incisures distinctly, owing to slight shrinkage of its substance. The *nuclei* stained pink occupy *depressions* in this sheath, and are best seen in profile view. There is one nucleus to each internode (Ranvier). The axis cylinder may project from the broken end of a fibre.

Nerve treated with nitrate of silver. Fresh nerve is placed in 1 P.C. AgNO₃ for 20 minutes, then transferred to 30 P.C. alcohol in sunlight until darkened. Tease a piece of the nerve in glycerin.

(H) Find *Ranvier's crosses*, nodes where the brown staining exhibits the axis cylinder and nodal cement substance coloured, roughly cross-shaped. The staining may extend along the axis cylinder, and then is disposed as transverse markings (Frommann's striæ). This disposal of the stain indicates the existence, around the axis cylinder, of material corresponding to the cement at the node. Incisural outlines may be indicated.

Large nerve. T.S. *Sciatic or ulnar, man.* (p. 11, s. 22, c. P., m. B.)

(L) The large rounded areas are bundles of nerve fibres. The *perineurium* around each bounds them with a sharp outline; between and embracing them is loose connective tissue, *epineurium*. (H) The perineurium is a lamellated structure consisting of several layers, between which there are nuclei and lymph spaces. Internally to this sheath are the nerve fibres mostly seen in transverse section. Each nerve exhibits a stained axis cylinder, around which is the medullary sheath.

This sheath varies in its appearance with the method of preparation. If long hardened in Müller's fluid it is more homogeneous and shows, here and there, concentric outlines

due to the incisures. If hardened in sulpho-picric acid (15) it presents a radiating structure.

The neurilemma forms a sharp boundary to the fibre. The endoneurium supplies connective tissue septa in the interfascicular spaces of the nerve bundle, in it are found blood vessels and lymph spaces.

Osmic nerve. T.S. 48 hours in 1^{p.c.} osmic acid, 48 hours absolute alcohol. (c. P., m. B.)

(L) General features the same as in the last preparation. (H) The medullary substance being blackened, the nerve fibres appear as black rings. Observe the great difference in the sizes of the nerve fibres in the same bundle. The largest are chiefly motor (Gaskell), some are intermediate in size and others very small (visceral?).

Nerve. L.S. (p. 11, s. 22, c. P., m. B.) (L) The nerve fibres are wavy in their arrangement inside the perineurium. (H) Single out a nerve fibre which can be followed for some distance. The axis cylinder is stained, so is also to a lesser degree the neurilemma. In the space occupied by the medullary sheath funnel-shaped structures are visible (Golgi's funnels). These correspond to the incisures. The nodes can also be recognised.

Non-medullated Nerve. *Splenic Nerve.* T.S. (p. 12, s. 22 & 24, c. P., m. B.) (L) The perineurium forms a well-marked envelope to the bundle of nerve fibres. The latter exhibit little noticeable structure beyond small ill-defined transverse sections, in which occasional nuclei are seen. Scanty interfascicular connective tissue septa divide the mass, in these capillaries are present.

L.S. of the same nerve exhibits wavy fibres crowded together. Each nerve fibre is nucleated and practically corresponds to an axis cylinder.

14 Nerve Cells. *Multipolar nerve cells* of the grey matter of the Spinal Cord of a large mammal.

Remove a small piece of the anterior horn of the grey matter of the fresh cord, and compress it to a thin film between two cover-glasses, slip them off each other and stain the films with methylene blue for one minute, quickly rinse them in water and dry thoroughly in air over the bunsen flame, mount by inverting them when quite dry upon a drop of balsam on a slide.

(II) Find large cells stained blue, they are nucleated and their protoplasm shows the *chromatic* patches deeply stained, and the *fibrillar* components of the larger processes continued in a radiating manner into the protoplasm. A process, the *axon*, which does not branch is often recognisable. Other processes form rich arborescent ramifications. Note the numerous nuclei which belong to the neuroglia. Branching blood vessels are also met with.

CHAPTER VIII.

CIRCULATORY SYSTEM.

Small artery and vein. T.S. from pancreas. (p. 4, s. 22 & 24, c. P., m. B) (*L*) The artery is recognised by the greater thickness of its walls. Three tunics are recognisable. The *inner* (intima), just discernable under this power, shows the wavy internal elastic lamina, on the inner side of which nuclei may be perceived; outside this is the thicker *middle* coat (media), consisting of non-stripped muscular fibres; and externally is the *outer* coat (adventitia) of connective tissue. (*H*) The inner coat has an inner lining of *endothelium*, chiefly recognisable by the nuclei of its cells, beneath this lies the *internal elastic* membrane (fenestrated membrane of Henle), and between the two—hardly recognisable, owing to its thinness—is the *sub-endothelial connective tissue*. The media or muscular coat in an artery of this size consists entirely of muscle. The adventitia generally shows elastic fibres near the muscular coat: not marked in very small arteries. *The characteristic feature of the small artery is its purely muscular coat.*

The vein differs from the artery in having thinner walls, the same structures occur in both. The muscular coat, however, frequently contains fine elastic tissue.

Distended blood vessels. T.S. artery and vein ligatured in a distended condition (p. 3, s. 22 & 24, c. P., m. B.).

(*L*) The artery shows a perfectly smooth and unfolded internal elastic lamina, and its walls appear proportionately thinner. The same is observable of the vein.

Endothelial outlines in blood vessels. Intestine of a small mammal, injected with AgNO_3 (27) and p. in methylated spirit. Spread the opened intestine peritoneal surface downwards on the slide, and scrape away the mucous coat with the back of a scalpel, clear with clove oil, mount in balsam.

(L) A branching system of blood vessels in which the arteries are smaller than the veins, their branches being united by capillaries. (H) Endothelial outlines of the arteries are more fusiform than those of the veins. Trace the passage of the arteries into the capillaries. Observe that the cell territories in the latter are larger and somewhat jagged. Around the arteries *perivascular lymphatics* are sometimes observed. Their endothelial cells have *sinuous* outlines.

Aorta. T.S. (p. 3, s. 19, c. P., m. B.) (L) The *middle coat* is the predominant structure, and consists largely of *elastic tissue* in circularly distributed*networks interconnected in all directions. In its meshes lie muscular fibres. On the inner aspect is the thin intima, and externally is the adventitia, with the same structure as before. *The abundant elastic tissue in the middle coat is the characteristic feature in the large artery.*

Sinus of valsalva. L.S. Man (p. 11, c. G., s. 19, m. F.). (L) Recognise the aorta, trace it to its junction with the base of the ventricle, a portion of which is included in the section, the junction is effected by the intervening connective tissue of the *Tendo cordis*, stained pink. On one side of this junction there is loose connective tissue which leads into the substance of the semi-lunar valve, which consists of open connective tissue, more compact on its ventricular aspect, and covered on both sides with endothelium. The recess between the aorta and the valve is the sinus. Note that the elastic tissue of the wall of the aorta thins down, and is replaced by pink-stained connective tissue where it forms the wall of the sinus. (H) Having noted the thinning

of the elastic wall of the aorta, and the tendo cordis, recognise the cardiac muscle and its mode of attachment to the latter structure, examine the substance of the valve, observe its covering of endothelium.

Should the section pass through the corpus arantii its structure will be recognised as white fibro-cartilage.

Ventricle of Sheep. V.S. (p. 2 (d), s. 22 & 24, c. P., m. B.) (L) The *myocardium* consists of muscle, sub-divided into fasciculi, separated by thin connective tissue septa, is covered on its inner aspect by the thin *endocardium* which follows all the irregularities of the surface and upon the external aspect by the *pericardium*. The latter often contains much fat.

(H) The *endocardium* loose connective tissue, in which are a few fibres of non-striped muscle, exhibits a number of elongated oval masses, the *fibres of Purkinje*. These consist of large polygonal cells, containing one or two distinct nuclei, surrounded by undifferentiated protoplasm. The periphery of each cell is fibrillated parallel to its surface. Trace them into the myocardium and note their transition into cardiac muscle. These fibres occur in ruminants (Purkinje), not in man.

BLOOD.

15

Amphibian and human blood. Study these successively in the same manner. Obtain them as follows.

Amphibian Blood. *Frog.* Expose the heart of a pithed frog freely, draw it over the edge of a watch glass with forceps and snip into the ventricle. Collect the outflowing blood without admixture of moisture from the skin and touch the blood with covers or hold covers so that the blood may flow upon them. *Newt.* Dry the tail, snip off the end. Apply covers to the blood that collects on the stump without touching the skin.

Human. Congest the end of your finger by winding a cloth firmly round it from base to point. With a clean Glover's needle prick the skin near the root of the nail until the blood wells out freely, touch

the drop with covers. The covers are then placed upon slides or otherwise dealt with as in the sequel. There should be enough blood between the glasses to form a continuous film devoid of air bubbles.

Freshly shed blood. To retard changes draw a line of olive oil round the edge of the cover and examine at once.

(H) The formed elements, *blood corpuscles* or *cells*, floating in a transparent colourless fluid the *blood plasma*. Recognise the numerous red and scanty white cells. The latter appear bluish by contrast, and when slightly out of focus more luminous than the red.

Red blood corpuscles. Examine them (H) carefully as to shape, relative and actual size, colour, contents, and note if there be any varieties. The *normal amphibian* red cell does not exhibit its nucleus. The nucleus becomes prominent as changes supervene, and is readily extruded from the cell. It is oval, the karyoplasmic network is distinct and colourless. Do not confound escaped nuclei with white cells.

The *human* red cells tend shortly to cohere by their broad surfaces, simulating piles of coins (*rouleaux*), probably due to altered surface tension. The form of the individual cell, a biconcave disc, is recognised as it revolves and is seen on edge. On the flat their lenticular shape, i.e., the marginal biconvexity and central biconcavity causes a faint concentric shadow which moves from edge to centre, and inversely with changes of focus. Not infrequently even at first some of the cells are *crenated*, i.e., have prickly outlines.

In the course of a few minutes *clotting* of the blood may occur, when very fine filaments of fibrin will be recognisable traversing the plasma (now serum). Granules are often to be noted at the points of radiation of the filaments.

Effects of reagents. Applied by irrigation.

Water. Cells lose their distinctness and the colouring matter is dissolved. The outlines of single cells are still recognisable where they are few in number. Note any change in their shape and size.

Syrup. 20 p.c. solution Cane sugar. Note the result of exosmosis on their shape.

Tannic acid strong solution and *Boracic acid* 2 p.c. solution. Compare their effect upon the pigment, which is disseminated as granules within or without the cells.

Salicylic acid. Half saturated solution in alcohol. Compare with the actions of tannin and of boracic acid.

Acetic Acid. Watch the earliest effect of the reagent and compare its effect on amphibian and human blood and on the nucleus in the former.

Leucocytes, white or colourless blood corpuscles.

Fresh blood shielded with oil. Human blood should be received on a warmed slide, covered, and be placed on the hot stage.

Search for three varieties:—(1) Large finely granular. (2) Large coarsely granular. (3) Small round (Lymphocytes). Examine minutely their cytoplasm, the nucleus is not clearly discernible.

Amœboid movements. Find cells in active movement; note the variety to which they belong. The resting spherical form is lost, the cell becomes irregularly extended by a flowing motion, with resultant changes of shape and position. Sketch the outline every 30 seconds.

Effect of acetic acid. The red cells are cleared up and the white ones come prominently into view. The latter are rendered transparent and their nuclei distinctly visible. Note the shapes of the nuclei.

16 Preparations of fixed blood. *Dried blood film.* A cover is moistened with blood, a second cover is laid upon it, after a minute the two are slid apart and are rapidly dried in air. Invert upon a slide and fasten down with a piece of gummed label having an aperture cut in the centre.

The red cells are perfectly preserved and visible but the leucocytes are more difficult of recognition.

Stained films. *A successful result depends upon the thinness of the film.*

1. Make several blood films by rapidly drawing the edge of a square cover moistened with blood across the surface of other covers.

2. Dry them quickly by waving in the air.

3. When perfectly dry pass the covers, film uppermost, three times through the flame of the Bunsen burner.

4. Stain them for 10 seconds in a quarter saturated alcoholic solution of eosin. The stain is applied by spreading a drop of the fluid at one stroke over the film with the flat of the rod of the reagent bottle.

5. Rinse in successive drops of water until the stain ceases to discharge.

6. Stain in the same manner for 30 seconds in Löffler's methylene blue.

7. Rinse as before in water.

8. Blot off the moisture by placing the cover between the folds of a piece of filter paper.

9. Dry thoroughly in the air with final warming over the burner.

10. Invert upon a drop of balsam upon a slide.

The red cells are stained red and their nuclei, when present, blue, the leucocytes have their nuclei similarly coloured, and the *eosinophil granules* are red.

Leucocytes of the Newt fixed in amæboid extension. A drop of newt's blood on a cover is inverted on a drop of normal saline and is irrigated with the same to remove as much of the plasma as possible. The preparation is then left to itself for ten minutes to give the leucocytes, which have adhered to the glass, time to be in active movement. The cells are next fixed (instantaneously) by heat. Play a jet of steam on the cover of the preparation, which is held for two seconds close to the point of issue, from a tube fitted to a flask or large test-tube in which water is kept boiling briskly. Irrigate with 70 P.C. alcohol, followed by dilute hæmatoxylin for four minutes. Wash away the latter with 70 P.C. alcohol, then absolute alcohol tinged with eosin, followed by cedar oil and, lastly, balsam. (After Schäfer.)

(H) Find the cells and observe the varieties of shape assumed by the cytoplasm and nuclei, and the distribution of the eosinophil, i.e., eosin stained granules in the former.

Blood in Hayem's fluid.¹ Mount a preparation made as follows: Fresh blood is dropped into a considerable volume of the fluid with which it must be thoroughly mixed by gentle agitation. After standing from four to five hours the supernatant fluid is decanted off and the blood washed with three changes of water in the same manner. Small quantities are stained with picrocarmine (19) or hæmalum (22) followed by eosin and mounted in glycerin or (Stirling) glycerin jelly.

Fibrin. A thick film of blood is covered and allowed to stand ten minutes. Raise the cover, rinse the adherent film of fibrin free of colour with water, then invert on a drop of Spiller's purple on a slide until stained (H) one minute, wash in water, dry between folds of blotting paper, mount in balsam.

¹Hayem's fluid. Sodium chloride 1 g, sodium sulphate 5 g, corrosive sublimate 0.5 g, distilled water 200 cc.

(H) The clot will show delicate filaments forming a confused network of radiating and intercrossing threads often of great fineness. Clusters of granules occur frequently at the points of radiation. Blood platelets?

Hæmoglobin crystals. Rat or guinea-pig. Mix a drop of blood on a slide with the same quantity of water, cover and watch for the appearance of crystals, first near the edge of the cover. When well developed remove the cover, dry thoroughly, replace the cover and cement it with a thin edging of glycerin jelly, covered when dry with gold size.

Hæmin crystals. To a drop of your own blood on a slide add a small grain of chloride of sodium, nearly dry it, cover and add some glacial acetic acid and heat over the bunsen flame until bubbles are freely given off. Repeat the heating if the crystals do not appear. Dry the preparation completely, add balsam, and cover.

Examine (H) for crystals, which will gradually form, appearing at first as nearly black, fine, short needles, often in clusters.

17 The Circulation. May be studied in any of the following:—

Web of the frog's foot. Use a piece of cotton cloth six inches square with a hole in the centre. Wet the cloth, draw one hind leg through the hole and wrap the remainder round the frog so as to form a sack, secure the mouth with string, and place the frog upon the support. Secure with ligatures around the support and frog, one round the body and one encircling the knees. The frog will remain quiescent if it is kept moist and is not too tightly restrained by the ligatures. To the longest and one of the neighbouring toes of the foot attach soft threads, lay the frog ventrally on the support and extend the web over the triangular gap by securing the threads in the slits cut for the purpose. Cover the extended portion of the web with a triangular piece of cover-glass.

Frog's mesentery. In a pithed frog laid dorsally on the support open the abdominal cavity by a longitudinal incision below the axilla. Carefully draw out a loop of the small intestine and pin it to the semi-circular cork rim on the support. Cover.

Tongue of frog.¹ Evert the tongue of the pithed animal out of its mouth and spread it fanwise, avoiding over extension, fixing in position to the cork with short pins. Cover.

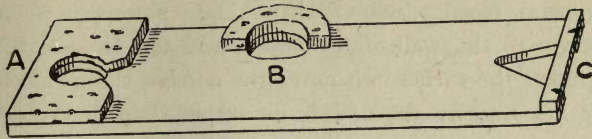

Fig. 14. Frog support for studying the circulation in A the tongue, B the mesentery, and C the web of the foot.

The foregoing offer different aspects of the subject for study. The web being covered by skin, the pigment and guanine cells, sometimes very numerous, may interfere considerably with a clear view of the vascular structures beneath. Capillaries are numerous. The mesentery being very thin shows the larger vessels well, but there are few capillaries. The tongue exhibits large tortuous (Lingual) arteries in which the expansion at the ventricular systole is particularly well seen.

Circulation in the web. Search (*L*) for an artery, the blood stream runs in it from the trunk into the branches; find a vein, in it the streams converge into the trunk. Note the relative difference in the rate of flow and in the diameter of the two vessels. Trace the blood stream from the artery into the vein through the capillaries. (*H*) Study the flow in the latter. In these the blood cells are individually visible, the red ones bending to the curves around which they travel; occasionally a red cell is caught on the edge of bifurcation of a vessel it then becomes flexed and responds to each systole, recovering its

¹In this organ living muscle and nerves can be observed. When thus extended striped muscular fibres may be readily fixed and isolated as follows:—Drop absolute alcohol upon the mucosa until bleached, scrape through it in the direction of the bands of muscle until the latter are exposed, and let the alcohol act upon them until they lose their elasticity. Remove portions and immerse them in absolute alcohol for twenty minutes. Separate by teasing and after bathing with water stain them with hæmatoxylin and mount in balsam.

Small nerve bundles accompany the blood vessels, the outlines of the fibres are sharply defined, and the double contour of the medullary sheath and Ranvier's nodes can be recognised. In the thin edges of the preparation search for single fibres of striped muscle, and observe the occasional waves of contraction.

shape on being swept back into the stream. Capillaries at times change their calibre and become too narrow for the passage of the red cells. The leucocytes are swept along by the general blood stream; they tend, however, to attach themselves to the wall of the vessel, and can be seen accumulating upon the surface whenever the current slows sufficiently. In the veins where the flow is less rapid than in the arteries the leucocytes monopolise a peripheral space in which they may be seen to be rolled along by the current as they cling to the wall of the vessel.

CHAPTER IX.

RESPIRATORY SYSTEM.

Trachea. T.S. Dog. (p. 8, s. 22^{D.C.} & 24, c. P., m. B.) (*L*) An incomplete ring of cartilage, the posterior ends of which overlap and are united by the trachealis muscle. The perichondrium passes internally into the looser submucous tissue, in which note mucous glands. The inner surface has a well-defined edge, which recognise (*H*) to consist of many layers of epithelium. The surface cells are columnar-ciliated. Examine the shapes of the cells in the different layers and the surface upon which they rest.

Large bronchus in the lung. Sheep or cat. (p. 8, s. 22 & 24, c. P., m. B.) (*L*) Find bronchi cut across, in *bronchial tracts*, surrounded by but sharply mapped off from the vesicular lung substance. The thick-walled bronchus is associated with the pulmonary artery and vein, which usually lie on opposite sides of it to form the tract, an arrangement which becomes less regular peripheralwards. (*H*) The epithelial layer of the mucosa lining the inner surface of the bronchus is wavy (sectional view of longitudinal corrugations), and perforated by the ducts of the mucous glands. Externally beneath the sharply-defined surface of attachment of the epithelium note the layer of transversely cut elastic fibres, and next a continuous band of non-striped (bronchial) muscle. Between the latter and the plates of cartilage are disposed the mucous glands, interspersed with variable quantities of adenoid tissue (lymph cords, Klein), and areolar tissue. The perichondrial extensions form a continuous fibrous covering around the

bronchus. Recognise the large pulmonary artery and vein surrounded by loose peribronchial connective tissue, and the sharp delimitation of the latter by the vesicular tissue of the lung. Search for the small *bronchial arteries* scattered around the bronchus (which convey arterial blood to its tissues) and the nerves with frequent ganglia which accompany them. Endeavour to trace in the surrounding lung substance the expansion of the bronchus into the vesicular tissue and examine the latter.

Silvered Lung of kitten or other young mammal. The freshly excised lung is filled with 0.25 p.c. solution AgNO_3 through a funnel tied into the trachea, the air driven out by gentle squeezing, then alternately emptied and refilled once with silver solution, and twice with methylated spirit. The second charge of the latter being made to distend the lung is retained by ligaturing the trachea, the whole being finally immersed in spirit. When rigid, 48 hours, cut into convenient pieces and continue the hardening 14 or more days in sunlight (c. G, s. 19, m. F. or B.).

(L) Recognise the bronchi, find an L.S. bronchiole at its infundibular expansion (H), note the cubical epithelium of the bronchiole, the absence of cartilage and thinness of its walls. Study closely how the vesicular recesses (air vesicles), multiple saccular expansions, are connected with the walls of the infundibular end of the bronchiole. The portions which remain of the latter may be recognised around the vesicular orifices by their covering of cubical epithelium. The endothelial lining of the air sacs is outlined by the action of the silver, each cell possessing a nucleus. Smaller cells stained brown occur singly or in groups of two or three between the larger clear ones, and may be regarded as *germinal cells* or as *pseudostomata* connected with the perivesicular lymphatics. Distinguish on the outer surface of the lung the pleural epithelium and connective tissue.

Foetal lung. Man. (p. 14 (b), s. 22, c. P., m. B.) (L) The subdivision of the lung into lobules attached centrally to the larger bronchi. Between the former note the loose *interlobular connective tissue* continuous with the pleural tissue on the surface of the lung. In the lobules the ramifications of the air passages are discernible. (H) The pleural and interlobular connective tissue exhibit blood vessels and numerous lymphatics. The branchings of the incompletely developed bronchi can be synthetically followed to their terminations, which may not however be sufficiently developed to present air vesicles, but merely the blind terminations of the bronchioles. Note the large amount of interstitial connective tissue. 18

Injected Lung. Mount a section of lung the blood-vessels of which have been filled with a coloured gelatin mass. (L) Find the large pulmonary vessels filled with the coloured mass and (H) recognise the injected capillaries which form a close network in the walls of the air vesicles.

CHAPTER X.

ALIMENTARY CANAL.

Tongue. T.S. Kitten. (p. 3, inj., s. 22 & 24 c. P., m. B.) (L) The dorsal surface of the organ is fringed with *papillæ*, which are absent elsewhere. The superficial stratified epithelium has beneath it fibrous tissue, these together constitute the "Mucosa," the papillæ being formed by projections of the two layers. Internally the organ is muscular and is divided symmetrically into lateral halves by a thin fibrous septum (Raphé). Note the strata of the transverse muscle alternating with those of the vertical muscle. The fibres of these are attached to the septal and mucosal fibrous tissue. The other intrinsic muscles are the dorsal and inferior linguals. Near the latter find sections of small blood vessel and nerves. (H) Examine the *conical* papillæ, observe the fibrous core and the enveloping squamous epithelium. Search the sub-mucosa for mucous glands, there will be none unless the section is taken from the hinder part of the tongue.

Tongue. V.S. Middle of dorsum, Man. for *Fungiform papillæ*. (p. 11, s. 22 & 24, c. P., m. B.) (L) and (H) The papillæ in question are shaped like button mushrooms, the surface of the fibrous core exhibits small secondary papillæ.

Tongue, V.S., base of, Man. for *circumvallate papillæ*. (p. 21, s. 22 & 24, c. P., m. B.) (L) Find a circumvallate papilla and study its structure in conjunction with that of the corresponding organ in the next preparation, the details of which are better preserved as the tissue can be fixed in a fresher condition.

Papilla foliata. T.S. of, in the root of the rabbit's tongue. (p. 3, s. 22 & 24, c. P., m. B.) The papilla projects slightly above the general level of surface of the tongue and consists of a series of vertical clefts (sulci) which indent its surface, and are lined by the superficial stratified epithelium. In this epithelium, on each side of the sulcus, the taste buds are placed. Find the secreting portions of the serous glands situated at some depth in the muscular tissue of the tongue and trace their ducts, which open into the sulci. Outside the foliate area mucous glands similarly disposed will be found, and are easily recognised by the transparent character of their epithelium. (H) Examine the taste buds. They are oval masses composed of fusiform cells arranged after the fashion of the staves of a barrel, the axis of which is set vertically to the sulcus. The pointed apex of the bud corresponds to an opening in the surface, the gustatory pore, through which the inner set of cells of the bud project as a cluster of minute short bristles. Outside the bases of the buds modified fibrous papillæ form an access for the nerves going to the buds. Compare the cells in the serous glands with those in the mucous glands and find large nerve bundles which run towards the surface.

Soft palate. V.S. Dog. (p. 3, s. 22 & 24, c. P., m. B.) (L) and (H) Recognise the mucosal surfaces covered on the nasal side by stratified ciliated, and, on the oral aspect, by stratified squamous epithelium. Between these there is striped muscle loosely arranged (*Azygos uvulæ*, &c.) and mucous glands, the ducts of which open on both surfaces.

The preparations of the remainder (tubular portion) of the alimentary canal which follow this resemble each other in the general plan of their construction. All of them have three concentric coats. (1) *Mucous*, (2) *Sub-mucous*, (3) *Muscular*, to which externally a fourth or *Serous* coat of varying extent is added in the peritoneal cavity.

The mucous coat is marked off from the sub-mucosa by a layer of non-striped muscle (*muscularis mucosæ*) which forms a continuous covering from the stomach downwards, but which is broken up into strands in the œsophagus.

The muscular coat in the intestine consists of an outer layer with longitudinally-disposed non-striped fibres and an inner one in which the distribution is circular. Between these layers is found the richly-ganglionated nervous *plexus of Auerbach*. In the stomach the arrangement is less regular. In the upper part of the œsophagus striped muscle is substituted (constrictors of the pharynx).

The sub-mucosa of loose areolar tissue allows free movement to the mucosa when the latter is thrown into folds by the contraction of the gut. Through it blood vessels, nerves and lymphatics (lacteals) run to their points of distribution. In it are found the ganglia of the *plexus of Meissner*.

Most of the following sections will in all probability require to be flattened on warm cedar oil.

Œsophagus. T.S. Dog. (p. 8, s. 17, and iodine green, c. P., m. B.) The mucosa by its large folds practically obliterates the lumen of the tube. Its free surface exhibits stratified squamous epithelium supported by fibrous tissue, which is compact where it meets the epithelium. In this tissue the bands of *muscularis mucosæ* seen in section form a definite outline. In the sub-mucosa clusters of mucous glands occur at frequent intervals and their wide ducts taper to a small aperture where they open through the epithelial covering. The muscular coat is non-striped internally and of the striped variety externally, the section having passed through the region where the transition occurs. Examine (*H*) the acini lined with secreting epithelium (green) and the muco-mucosæ.

19 **Stomach.** *Cardio-œsophageal junction.* V.L.S. Cat. (p. 3, inj., s. 22 & 24, c. P., m. B.) (*L*) Find the point of transition of the epithelium of the œsophagus into the mucosa of the stomach.

(H) The former layer tapers off suddenly to meet the single row of columnar epithelium on the gastric surface. Recognise the gastric follicles, tubular glands set side by side, the length of which determines the thickness of the membrane. Observe the muscularis mucosæ and that the muscular coat is not markedly thickened (Cardiac sphincter?).

Cardiac end of stomach. V.S. Kitten. (p. & c. the same as the preceding.) The gastric glands not being fully grown are less closely packed and therefore better seen individually than in the adult structure. (L) The mucosa is the thickest of the coats. In it find the follicles divisible into the gland proper, and a short wide duct which presents a wide opening on the surface. The duct is lined by a single layer of columnar cells, the same as that on the inner surface of the organ. The gland tubule presents two kinds of epithelial cells, the inner of which are small and clear and almost fill the cavity and are known as the *chief* cells. Outside are the *parietal* cells, oval nucleated masses of protoplasm which cause lateral projections in the outlines of the tubules. In the lower part of the mucosa find cross sections of the glands and note that the parietal cells also project inwards between the chief cells and so establish a connection with the secretory passage. The interstitial material between the glands consists of fine adenoid tissue in which blood-vessels and strands from the subjacent muscularis mucosæ should be found.

Pyloric mucosa. V.S. Kitten. (p. 3, inj., &c., as before.) The secreting portions of the glands are lined by cells similar to the chief cells; there are no *parietal cells*. In the sub-mucosa lymph nodules are frequently met with. The main mass of these lies in this layer; a portion, however, projects into the mucosa in a somewhat diffuse manner.

Pyloro duodenal junction. V.L.S. Cat. (p. 3, inj., &c., the same as the last.) (*L*) Follow the surface of the mucosa from the pyloric side, and observe that the transition to duodenum is marked by the gradual appearance of projections (*villi*) in the spaces which correspond to the intervals between the ducts of the gastric glands. The mucosa is apparently increased in thickness; this is, however, due to the compact mass of glandular tissue (Brunner's glands) in the sub-mucosa, which may at first be taken as part of the mucosa until the position of the musc. mucosæ is recognised. The villi are column-like projections from the mucosa proper. In the latter, recognise the glands of Lieberkühn, which open on the surface between the villi. They are simple tubular glands. The muscular coat of the stomach undergoes a sudden and great increase to form the pyloric ring, which diminishes as rapidly on the duodenal side and there presents two regularly disposed layers. In the duodenum lymph nodules are met with in the sub-mucosa. Their dome-like projections penetrate to the free surface of the mucosa. (See Peyer's patch later.)

(*H*) Examine:—The mucosal transition; the villi; the openings of the Lieberkühn's glands on the surface, and the epithelium which lines them; also the ducts and secreting acini of Brunner's glands, the epithelium of which resembles that in mucous glands; the muscular coat and Auerbach's plexus.

Injected stomach. V.S. Fundus of cat's stomach. (Carmine gelatin mass, p. 2 (*d*), s. 22, c. P. or G., m. F. or B.) Follow the large blood vessels from the sub-mucosa to their branchings in the mucosa. The arteries penetrate nearly to the surface before dividing, and then sub-divide into a capillary network which forms a return system through the mucous membrane around the glands to converge into a system of veins which debouch into the sub-mucosa. The arteries are terminal, e.g., have no free anastomoses.

Small Intestine. For the structure of villi. The section contains L. and T.S. mounted side by side. (p. 3, inj., s. 22 & 24, c. P., m. B.) Recognise (*H*) the single layer of columnar cells on the surface, together with their end plates. This layer rests on a well-defined surface, formed by the adenoid reticulum which constitutes the supporting framework of the villus. Internal to this find blood capillaries (probably quite invisible being collapsed) and next a zone of muscular strands from the musc. mucosæ. In the middle the central lacteal may be observed as a partially open cleft.

Small intestine for fat absorption. Frog. (The animal is fed upon a piece of bacon fat or some lard and is killed four or five hours afterwards. The intestine is cut out and small pieces are quickly placed in 1^{p.c.} osmic acid for 48 hours, p. absolute alcohol with eosin, c. P., m. B.) (*H*) Find the columnar cells loaded with small fat granules near their free ends which become larger towards the nucleus. Is there any fat to be seen in the substance of the end plate? Much fat is recognisable in the subjacent tissue of the villus.

Small intestine of rabbit, for Auerbach's plexus.

A loop of small intestine is washed out with normal saline and is then tied at one end and filled with Ranvier's boiled gold solution (28). The fluid is kept in by a second ligature and the whole is immersed in gold solution for 45 minutes. The gut is then cut into short lengths, is rinsed in distilled water, and is transferred to 20^{p.c.} formic acid for 24 hours, or longer, until the gold is reduced, which will be recognised by the uniform reddish violet colouration. Place in glycerin with a little formic acid until required.

A piece of the gut is laid open by a longitudinal incision and laid peritoneal surface downwards upon a slide. The mucosa is next scraped off with the flat of a needle so as to leave only the muscular coat, m. in glycerin containing a little formic acid.

(*L*) The plexus will be recognised as a large somewhat square meshed network lying between the layers of the muscular

tissue. (*H*) Recognise the nerve cells at the nodes. They do not show very distinctly as a rule.

20 *Peyer's patch.* V.S. Cat. (p. 3, inj., s. 22 & 24, c. P., m. B.) In the sub-mucosa find the clusters of lymph nodules; these project to the free surface of the mucosa, where they are covered by a single layer of flattened cells which (*H*) exhibit local thinnings, so that the line of separation between the cell-loaded adenoid tissue and the cavity of the gut is reduced to a thin film with possible apertures. Between the rounded heads of neighbouring nodules the villi form narrow fringes.

Injected Peyer's patch. (Blue gelatin mass. p. 2 (*d*), s. 24, c. P., m. B.; or c. G., s. 24 on the slide, m. B.) (*L*) The injected capillaries form a network in the villi close under the epithelium, and are connected with vessels in the sub-mucosa. Capillary loops, few in number, project from the surface into the lymph nodules, which, though rich in cells, are not very vascular. In this respect they resemble lymphatic glands. (See later.)

Large Intestine. V.S. Cat or Dog. (p. 3, inj., s. 22 & 24, c. P., m. B.) (*L*) There are no villi, and the only glands are of the Lieberkühn variety. Lymph nodules occur occasionally. The muscular wall is thinner than that of the small intestine. (*H*) Goblet cells are numerous in the glands amongst the other cells.

Injected large intestine. (Blue gelatin mass. p. 2 (*d*), s. 24, c. P., m. B.) The blood vessels form a rich capillary network around the glands.

Vermiform Appendix. Man. T.S. (p. 3, s. 22 & 24, c. P., m. B.) (*L*) The mucosa is scantily supplied with Lieberkühn's glands; there is much interstitial tissue in which lymph nodules are somewhat diffusely projected from the sub-mucosa. (*H*) The

latter is of comparatively dense fibrous tissue in which lymph spaces occur, the endothelial lining of these is often well seen. The muscular coat is unusually thick as compared with that of other parts of the intestine.

CHAPTER XI.

GLANDS OF THE ALIMENTARY CANAL.

Most of the sections of glands will require to be fixed to the slide by means of shellac fixative very thinly applied.

Parotid Gland (Serous) Cat. (p. 3, inj., s. 21, c. P., m. B.) (L) Small lobules separated by loose inter-lobular connective tissue. The acini are of rather uniform appearance, and can be recognised under this power. The ducts and their branchings are obvious inside and between the lobules, and are accompanied by blood-vessels. (H) The acini are filled with redundant secreting epithelial cells of the serous variety. Their nuclei are placed near the periphery of the cell, and the cytoplasm is finely reticulated. Acquaint your eye with the general appearance of these cells. Find the commencement of ducts in the acini, at first lined by flattened cells to change to cubical and even columnar forms in the larger canals.

Sub-maxillary Gland. Dog. (Mucous.) (p. 8, inj., s. 22 & 24, c. P., m. B.) (L) The lobules are more compact than in the last, the acini larger, and the ducts less numerous. (H) The secreting epithelium is larger, the cytoplasm less reticular and very transparent in appearance, and the nucleus is pressed against the attached surface of the cell. Recognise the crescentic cells or demilunes (Gianuzzi) placed outside the mucous cells, and which occasionally jut inwards between them. Their cytoplasm is delicately reticulated, resembling the substance of the serous cell, and the nucleus is rounded. The ducts are lined by cubical epithelium, the larger ones being accompanied by blood-vessels and ganglionated nerves.

Sub-maxillary Gland. Man. (Muco-serous.) (p. 3, s. 21, c. P., m. B.)

(L) The mucous acini appear like perforations amongst the more solid serous ones. In many lobules the larger ducts (columnar epith.) are surrounded by dense fibrous tissue, in which blood-vessels and nerves are also placed. (H) Observe the character of the epithelium in the two varieties of acini. In the serous, the nuclei are round and are placed near the middle of the cell.

Salivary gland injected. Kitten. (Blue gelatin mass.

p. 2 (d), s. 17, c. P., m. B.) (L) There is a rich distribution of capillaries in the lobules and in the walls of the large ducts. Note also masses of fat injected. (H) The capillary networks lie close upon the surface of the acini and around the fat cells. Paccinian corpuscles occur in the gland substance in this animal. Observe that capillaries penetrate to the interior of the corpuscle and follow the nerve to its termination.

Pancreas. Rat. (p. 4, s. 22 & 24, c. P., m. B.) (L) **21**

The lobules are frequently fusiform from mutual compression and the connective tissue between is scanty. Ducts have thin walls and are not prominent. (H) Acini are rather narrow, the epithelium is dense looking, and the cytoplasm is divided into an outer hæmatoxylin coloured layer and an inner eosin stained granular portion. These granules are characteristic (Zymogen). Find the interalveolar cell islets, irregularly shaped clusters of polygonal cells devoid of eosin stained granules. They occur in the substance, most commonly, or in the neighbourhood of the ducts. Their general appearance in stained sections is paler than that of the surrounding tissue, they can therefore be recognised under a low power. The interlobular blood-vessels are accompanied by ganglionated nerves.

Liver. *Liver cells.* A scraping from the cut surface of the fresh liver of a mammal, diffused in salt solution. (II) Sketch their shape and contents.

Liver for Glisson's capsule. Fig. (p. 3, inj., c. G., s. 19, m. F.) (L) Externally the capsule, internally the polygonal lobules separated from each other by interlobular extensions of Glisson's capsule. Find a lobule with a central vessel, note the radiating arrangement of the lobular substance. The *portal vein* is distributed in the capsular tissue and is accompanied by one or more branches of the *hepatic duct* and *artery* which together constitute a *portal tract*.

The hepatic vein springs in the centre of the lobule. Find examples of it cut across and lengthways. The latter can be traced into the capsular tissue. Two or more of them may be found converging from contiguous lobules to a larger hepatic vein (*sub-lobular vein*). (H) The free surface is covered by the capsule of dense white fibrous tissue with distinct corpuscles and numerous small lymph spaces. Study the hepatic cell substance. It forms a columnar network, usually two cells thick, interlaced with the system of capillaries. The liver cells are nucleated and have a reticulated cytoplasm often vacuolated.

Liver. Rabbit, for *portal tracts* and *cell columns*. (p. 6, s. 22 & 24, c. P., m. B.) (L) In a portal tract recognise the large thin-walled portal vein. The small, thick-walled *hepatic duct*, lined with *cubical*, or even *columnar*, epithelium, and the small hepatic artery. There is no corresponding vein, the blood return taking place through the hepatic vein. (H) Confirm the above and observe that the lobular capillaries open into the hepatic vein. The cell columns are everywhere in contact with capillaries, the endothelial covering of which is recognised by their nuclei seen in profile.

Liver. Man, stained *Golgi* for *bile ducts*. (p. 11, s. 27, c. G., m. B., uncovered, or see 11.) (*H*) Find the black, close, and angular meshed system of bile channels amongst the cells. They open into the ducts in the capsular connective tissue.

Liver. Kitten, for larger *ducts* and *gall bladder*. (p. 3, inj., s. 22 & 24, c. P., m. B.) (*L*) Find a large duct in a portal tract. The lining epithelium is cubical and thrown into folds. Externally to this observe the small sacculations lined with the same kind of epithelium, so-called mucous glands, the epithelium of which, however, does not resemble that of mucous glands elsewhere. Examine the wall of a portal vein and note that there is hardly any muscular tissue in it. The gall bladder is lined by cylindrical cells. Note the glandular sacculations. Outside this find the pronounced muscular coat containing ganglionated nerves.

Liver. Rabbit, for *glycogen*. (p. Absolute alcohol injected, c. P.) After the removal of the paraffin on the slide, stain with a strong alcoholic solution of iodine in iodide of potassium, m. B. The brown-red stain brings into view the nodular masses of the glycogen in the cytoplasm.

KIDNEY.

Kidney, of a *small mammal* for the *general arrangement* of the tubules. T.S. Rat. (p. 3, inj., s. 22 & 25, c. P., m. B.) (*L*) Externally the thin and easily detached *capsule* rests upon the *cortex*, the latter is readily distinguished from the *medullary* or central portion of the organ by its pinker stain. The medulla projects inwards as a conical *papilla*. The clear space around the latter is the sinus of the kidney, lined by the pelvic expansion of the ureter, a section of the latter will be found in the mass of fat immediately outside. The cortex nearly meets around the medullary part at this level of the organ. A little way above or below the cortex would be continuous all round. Just outside the pelvic membrane, find the *Renal arteries* and the larger thin-walled *veins*.

The *medullary rays* (pyramids of Ferrein) are clusters of renal tubules which run outwards from the medulla into the cortex, where they gradually disappear. The intervals between them are filled by the *convoluted tubes* which exhibit the pink stain, and amongst which note the bluer coloured *glomeruli*.

Kidney, for T.S. *papilla*. Rabbit. (p. 4., s. 17, c. P., m. B.) (*L*) Find the papilla and recognise near its apex large collecting tubes (ducts of Bellini), and if the section favours their openings on the surface. If cut lengthways their dichotomous divisions will be found. Between them (*H*) there is much interstitial tissue, in which the capillaries are recognisable by their thin endothelial coverings. Towards the cortex the loops of Henle's tubes are to be found.

Kidney. Dog, for *boundary zone*. (p. 12, s. 22 & 24, c. P., m. B.) (L) Between the cortex and medulla find the boundary zone, rendered distinct from either of these by the closely packed parallel tubes, chiefly ascending and descending limbs of Henle's loop. Observe the large blood-vessels on a level with this zone. (H) Find loops at different levels in this stratum, and note the character of the epithelium with which they are lined. Find a glomerulus, cut through its attachment to *Bowman's capsule*; observe that the former is compounded of clusters of capillaries, and also that its surface is covered by a layer of epithelium, the reflected part of the capsule, the nuclei of which are superficial to those of the capillaries. Search for the connection of the capsule with a convoluted tube, and inspect its epithelium. Next note the shape of the cells in the *collecting tubes* of the *medullary rays*, and compare them with those of Henle's loops in the boundary zone.

Injected Kidney of a mammal. Cat. (Blue or red gelatin mass, s. 17 or 22, c. G. or P., m. B. or F.) (L) Find the *arching arteries* and *veins* in the intermediate zone and trace their two-fold distribution. (1) Outwards to the cortex, the *interlobular arteries* give off *efferent* branches to the glomeruli, the rich cluster of capillaries which form the latter and the *efferent* vessel which leaves them to divide into a second set of capillaries, the *intertubular plexus of capillaries*. The venous return from these occurs through the *interlobular veins*, which commence on the surface of the cortex as the *stellate veins*. From the lower glomeruli the *efferent* vessel forms a leash of capillaries, *pseudo-arteriæ rectæ*, which pass into the medulla. (2) Inwards branches break up at once into parallel clusters of vessels, the *arteriæ rectæ*, which return their blood through a similar set of small vessels into the *arching veins*.

Isolated renal tubules of small rabbit. (p. slices in 30° C HCl for 2 or 3 hours. Dissociate the renal substance into wedges, and separate by agitation in water) (Stöhr). (After thorough washing stain 48 hours in 19 and dissociate in glycerin jelly; m. in the same). Find glomeruli in their Bowman's capsules connected with convoluted tubes, fragments of Henle's loops and of Collecting tubes. The character of the epithelium is not very much altered.

Embryonic Kidney, from a mammalian Fœtus, preferably human. T.S. (p. 15, s. 17 or 22, c. P., m. B.) (L) The tubules are simple and visible throughout their whole extent; they run nearly straight from the papilla, and have a crook-shaped bend close to the cortical surface, where they present a cup-shaped expansion. There is much interstitial connective tissue. (H) Examine the peripheral expansion of the tube (early stage of Bowman's capsule), recognise its crescentic form, the concavity of which is made up of tall cells, and partially embraces the future glomerulus. At this stage the glomerulus appears as a mass of cells connected with the blood-vessel. The details vary in their form with the state of the development of the individual glomerulus. In the young compound kidney (human), the individual malpighian pyramids or simple kidneys are in contact along the lateral portions of their cortices (columns of Bertin).

Ureter. Kitten or Dog. T.S. (p. 3, inj., s. 22 & 24, c. P., m. B.) (L) The mucous coat is covered with stratified epithelium of the *transitional* variety; note the flattened superficial cells. Examine the loose connective coat outside, and observe that it is vascular. External to this is the muscular coat, the strongest part of which is transversely disposed, longitudinal fibres occurring on both its inner and outer aspect. Externally to all is a loose fibrous covering.

Bladder Kitten. T.S. (p. 3, inj., s. 22 & 24, c. P., m. B.)

(L) The mucous coat resembles that of the ureter, but is thrown into greater folds. The muscular coat is thicker, and the constituent fibres are massed into two or three layers. (H) Note capillaries in the connective tissue, just outside the transitional epithelium.

SKIN AND ITS APPENDAGES.

Skin. Palmar surface of *human finger*. (p. 11, s. 22 & 24, c. P., m. B.)

(L) The *epidermis* has already been described. (See stratified epithelium.)

The *dermis* or *true skin* consists of fibrous tissue of considerable density near the surface, but looser deeper down, where also are masses of *sub-cutaneous fat* (*panculus adeposus*).

The *papillæ* are buried in the epidermis and contain *vascular loops* or *nerve endings* (touch corpuscles) sometimes in the same papilla, but usually in separate ones. These corpuscles are masses of an ovoid shape consisting of spirally wound fibrous tissue in which a nerve may be seen to end. The *sweat glands* are simple tubes, the secreting portions of which lie deep in the dermis, where each forms a convoluted mass. From these the duct runs to the surface, passing through the epidermis in a spiral course. Find on a level with the fat the *paccinian bodies*. In structure they are concentrically laminated around the nerve, of which they form the terminal coverings. Here find, also, small arteries and nerve bundles. (H) Examine the structure of the touch corpuscles. The secreting part of the sweat glands in T.S. shows externally a *hyaline* membrane, next to this a layer of longitudinally disposed *non-striped muscle*, and innermost of all secreting epithelium. The ducts are lined by low cubial cells for which the squamous variety is substituted in the epidermis.

Scalp, V.S. Human. (p. 11, s. 22 & 24, c. P., m. B.) (*L*) The *hair follicles* which are set aslant consist of a central hair (shaft and bulb) closely invested by the *inner* and *outer root sheaths* of epithelium, which are respectively continuous with the Horny layer and Rete mucosum of the surface. Trace the connection. Covering these is the thin *Dermic coat*, a surface condensation of fibrous tissue. The *sebaceous glands* form compound sacculated masses outside the follicles, into which their ducts open not far from the surface. Further down find the *Erector Pili*, a band of non-striped muscle which stretches across the obtuse angle formed by the follicle with the surface of the skin. Observe its method of attachment at both ends. (*H*) Examine the constitution of the root sheaths, and trace them to the bulb and over the *vascular papilla* situated within it. Make out the formation of the hair at its bulb from the epithelial cells of the sheaths. Examine the secreting cells of the glands; the lumen is filled with cells, which break up into *granules* of sebaceous material.

Scalp, human, horizontal S. (p. the same as the preceding.) Examine the root sheaths of the hair follicles especially, and the other features previously mentioned.

Nail. Human foetal finger. V.L.S. (p. 15, s. 22 & 24, c. P., m. B.) (*L*) On the dorsal aspect of the finger, and near its tip, find the obliquely placed invagination of epidermis in which the root of the nail is buried. At this early stage the nail appears little more than a thickening of the horny layer. A T.S. is required to show the mucosal ridges which only become marked later. Note, besides, in other parts of the skin, the developing *sweat glands*, which may only be present as columnar invaginations of the rete mucosum. Examine also the developing phalanges with their cartilaginous ends and the marrow in their interior.

CHAPTER XIV.

BLOOD GLANDS.

Lymph gland. T.S. (p. 8, s. 22 & 24, c. P., m. B.) (*L*) The organ is divided into an external denser *cortex* and a more open inner texture, the *medulla*. The latter, especially in small glands, is placed close to one side near the hylum, the place of entrance of the blood-vessels. A *capsule* covers the surface from which prolongations the *trabeculæ* run inwards nearly straight in the cortex, to become network-like in the medulla. In small glands this tissue is scanty. A narrow, clear space, the *lymph sinus*, separates them everywhere from the *follicular* portion, the substance proper of the organ. In the cortex there are frequently rounded areas rendered evident by the stain, and which bear a close resemblance to the splenic bodies. (*H*) The capsule is of fibrous tissue and contains varying quantities of non-striped muscle. The sinus is traversed by branching lymphoid tissue with scattered cells in its meshes (lymph cells). The follicular tissue is sharply marked off from the sinus, and is packed with lymph cells, the nuclei of which show frequent evidence of mytosis.

Injected lymph gland. (Blue gelatin mass, p. 2 (*d*), s. 24, c. P., m. B.) The blood-vessels enter at the hylum and ramify in the trabeculæ to be distributed in capillary loops in the follicular system. The gland is not very vascular.

Tonsil, Dog. V.S. (p. 8, s. 22 & 24, c. P., m. B.) (*L*) Find the indented oral surface covered with stratified squamous epithelium, and beneath this the lymph nodules embedded in areolar tissue.

There are also mucous glands whose ducts open superficially. (*H*) Examine the epithelium over the nodules, and note that it thins down frequently to a single cell over the lymph nodules, the cells of which may easily pass through such places.

Hæmolympth glands, from the prevertebral fat of the sheep. **24**
(p. 3, s. 22 & 24, c. P., m. B.) These structures closely resemble small lymph glands, the notable difference being that the wide sinuses, which are particularly evident in the medulla, are filled with red blood-cells instead of lymph corpuscles.

Spleen, for capsule and trabeculæ, Sheep. (p. 3, s. 22 & 24, c. P., m. B.) (*L*) The muscular capsule is thick, and sends trabeculæ into the interior of the organ. The pulp lies close to, and is in contact with them everywhere. The larger trabeculæ are tunnelled by blood-vessels. The pulp is uniform in appearance, excepting where it presents circular and more darkly stained outlines in its substance, the splenic bodies. (*H*) Examine the capsule and trabeculæ for non-striped muscle. Follow the trabeculæ into the pulp, note the vessels in their interior and then inspect the pulp. Little more can be made out beyond the fact that it is crowded with cells. The outlines of the splenic bodies present the appearance of faint concentric striations.

Spleen. Kitten. (p. 3, inj., s. 22 & 24, c. P. very thin m. B.) (*H*) Examine in the pulp for the *commencement of veins*. These will be found with careful search, as small often branching spaces with a continuous endothelial outline where the wall is complete, and elsewhere an indefinite boundary, where the cavity of the vessel merges into the spaces of the adenoid tissue. Many of the cells are loaded with coarse granules stained with eosin, which form mulberry-shaped masses. These are red blood-cells in course of disintegration.

Spleen, injected. Cat. (Blue gelatin mass. p. 2 (d), s. 24, c P., m. B.) (L) Trace the blood-vessels through the trabeculæ into the splenic bodies and observe that the arterioles penetrate to their interior, give off a few capillary branches which run to the surface of the bodies, and there discharge their contents into the general space of the pulp. The splenic bodies thus form rounded islands of almost non-vascular pulp, surrounding the terminations of the arteries. (Peri-angial lymphatic nodules?)

Thyroid. Man or Sheep. (p. 10, s. Saffranin in aqueous sol., c. P., m. B.) (L) The organ is lobulated with loose connective tissue between. The spherical vesicles which make up the substance proper of the gland are lined by cubical epithelium, the nuclei of which are visible with this power. The vesicles are filled with a structureless substance, *Colloid*. (H) Examine the epithelium and the disposal of the colloid which can be frequently traced between its cells. Detached cells in the colloid.

Thymus. Child. (p. 12, s. 22 & 24, c. P., m. B.) (L) The lobules are separated by scanty areolar tissue. The substance proper looks uniformly granular with the exception of small round islands stained pink, *Hassall's* corpuscles. (H.) The substance proper consists of delicate adenoid tissue crowned with cells. The small *Hassall's* corpuscles are nests of concentrically packed flattened cells. The larger ones exhibit the same arrangement at their periphery, whilst the interior is full of larger rounded cells, the outlines of which are not always very distinct. These bodies are regarded as hypoblastic relics.

Thyroid, parathyroid and thymus of Kitten. (p. 3, s. 22 & 24, c. P., m. B.) (L) The partially developed thyroid shows besides the vesicles masses of interstitial cells in which the gradations of vesicular formation are recognisable. Small quantities of colloid appears amongst the cells, which are gradually thrust apart and

expanded into vesicles by its accumulation. The thymus has already been described. The parathyroid, distinct from either of the two preceding structures, is situated between them at this point, and consists of closely packed columns of epithelium, which look very much like gland tubules. This body is of considerable vascularity, there being many capillaries around the tubules.

Pituitary body. Rabbit. (p. 3, s. 22 & 24, c. P., m. B.) The 25
organ is surrounded by a capsule of considerable thickness, and consists of two portions. The anterior is developed from the dorsal aspect of the pharynx, and the posterior from the ventral aspect of the brain. The anterior portion is made up of almost solid columns of cells, in which there is occasionally the appearance of a lumen. These columns are separated by loose connective tissue. Near the hinder end of this portion duct-like tubules, lined by cubical cells occur, next to which large venous spaces are found. The latter are accompanied by small lymph nodules. The posterior portion consists of fibrous material, mostly non-medullated nerve fibres, amongst which there are scattered nerve cells.

Suprarenal body. T.S. Man. (p. 11, s. 22 & 24, c. P., q.m. B.) (L) A thin fibrous capsule surrounds the organ, the interior of which is divided into *cortex* and *medulla*. The latter occupies but little of the whole organ, and is of a more open texture. (II) Recognise the vertical columns of cells of which the cortex is composed, they present a somewhat glandular appearance. In the outer part of the cortex, which is known as the glomerular zone, the columns are wider than in the inner or reticular zone, which forms the mass of the organ, and the columns of cells do not intercommunicate to the same extent.

The medullary portion presents a network of intercommunicating cell columns, the interstices of which are occupied by venous channels.

Suprarenal body. Kitten. (Injected carmine gelatin, s. 22, c. P., m. B.) (*L*) and (*H*) Note the rich capillary distribution around the cell columns and the convergence of these into the larger veins of the medulla.

CHAPTER XV.

NERVOUS SYSTEM.

Superior cervical ganglion. Man. (p. 3, s. 22 & 24, c. P., m. B.) (L.) and (H.) Superficially a thin laminated perineurial sheath internally nerve cells of various sizes, and many contain crescentic patches of pigment granules. Each cell has a nucleated capsule. There is much tissue between the cells consisting of non-medullated nerve fibres and filaments and capillaries. The entering nerves are of the non-medullated variety for the most part.

Posterior root ganglion. Man. (p. 3 or 11, s. 22 & 24, c. P., m. B.) (L.) and (H.) The structure is fusiform, and there is an entering and an emerging mass of medullated nerve fibres, The perineurial sheath is well marked. The cells are somewhat larger than in the sympathetic and of a more uniform size; their capsules are distinct, but there is less intervening tissue.

Vagus Nerve. Man or Dog, T.S. of. In the neck. (p. Osmic acid, c. P., m. B.) The perineurial coat is strong around the subdivisions of the nerve. Sketch the structure, and pay special attention to the size of the nerves in the fibres in different localities. Compare with the sciatic nerve examined earlier on.

Spinal Cord.

Cord of rabbit. T.S. upper *thoracic* region. (p. 3., s. aqueous methylene blue in bulk, c. P., m. B.)

Cord, Man, Thoracic region (p. 11, s. 19, c. G., m. F.) Examine both of these for the following points of structure. (L) The cord is closely invested by the thin fibrous *pia mater*.

Recognise the subdivision of the cord into lateral halves by the *ventral fissure* (open) and the *dorsal fissure* (filled with pia mater), which dip in as far as the *commissure* that unites the lateral halves. Within the white matter of the cord lies the *grey substance*, the outline of which forms an irregular letter H, being united across the middle line by the grey commissure. Each half of the grey matter presents a narrow *ventral horn* which terminates in a square end some distance from the free surface.

The *dorsal horn*, slight and fusiform in shape, attains to the surface, where it is met by the dorsal root of the spinal nerve. Nearly midway on the outer side of the grey substance the *lateral horn* forms a pointed projection.

The white substance is divided into three main anatomical subdivisions:—(1) The *ventral column*, between the ventral fissure and the outer strands of the ventral nerve root fibres; (2) The *lateral column*, extending from this to the dorsal root; and (3) The *dorsal column*, between the dorsal root and the corresponding fissure. The only other subdivision of the white substance is occasionally caused by a thin septum of pia, which separates the dorsal column into an inner *Goll's* (Gracile) *column* and an outer *Burdach's* (Cuneate) *column*. (H) Examine the cells of the ventral horn. Search for their axons running into the strands of the corresponding nerve root. The large nerve cells are mostly confined to this cornu. Inspect the lateral cornu, in which small nerve cells can be recognised (*Intermedio lateral tract*). Dorsally to this find the *lateral reticular formation*, a network of fibres passing into the white matter. The dorsal cornu is pointed and capped by the *gelatinous substance of Rolando*. The dorsal root enters its apex in part only, most of it making a sweep inwards to its mesial side. On the mesial aspect of the neck of the dorsal horn near the com-

missure a distinct group of cells (*Clarke's posterior vesicular column*) will be seen, if the section be low enough in the thoracic region. The cells have an oval outline.

The *grey commissure*, containing blue-stained fibres, encloses the *central canal* of the cord. This is lined by *columnar ciliated* cells, the attached ends of which are tapered, and branch into the surrounding *central gelatinous substance*. On each side of this a branch of the anterior spinal artery is frequently seen in cross section. The white substance is composed of medullated nerve fibres embedded in a spongework of special connective tissue, the *neuroglia*. This forms a continuous layer upon the surface of the cord, and from it septa pass inwards, giving off-sets in all directions. Nuclei are found in it. The nerves seen in cross section differ much in size. Forming the centre of each fibre observe the axon surrounded by the medullary sheath, which frequently exhibits concentric markings, medullary segmental junctions.

Fresh cord, for nerve fibres. Place a small fragment of the white substance upon a slide with a little normal saline, cover and compress slightly. (*H*) Note the medullated fibres, which soon exhibit regular fusiform expansions as the medullary sheath swells. This indicates the *absence of the neurilenima*.

Spinal cord of cat. (Injected blue gelatin mass, p. Formol 2 p.c., c. G., m. B.) (*L*) Find the *anterior spinal artery* entering through the ventral fissure and breaking up into branches at the commissure, from which they radiate into the grey substance. A superficial set of vessels are distributed upon the surface in the pia mater, the branches of which converge through the white substance to the grey, which they do not always reach. The arteries are terminal. (*H*) Note the rich capillary distribution in the grey matter.

The following sections of the human spinal cord are for the purpose of studying the regional differences presented by it, and are all prepared in the same way. (p. 23, s. Eosin, m. B.)

Conus medullaris. (*L*) The white substance forms a narrow margin around the central grey matter. The horns are rounded and the commissure is broad. The lateral portion of the ventral horn contains a number of large nerve cells. The dorsal root is broad at its entrance into the cord. (*H*) Find the groups of cells in the ventral horn, and note the group previously mentioned (probably a limb area, Sherrington). The cells of the central canal are usually well seen.

Lumbar cord. The whole section is larger than the last, and there is much more white substance. The ventral horns are much more bulbous and contain many large nerve cells, (*H*) chiefly in its ventral and lateral portions. The dorsal horn is also rounded and the dorsal nerve root sends strands of fibres along the mesial side of the horn to enter its substance nearer the neck. The central canal is wider transversely.

Cervical cord. The whole section is larger and somewhat more oval transversely, and there is a proportionately greater amount of white substance in the posterior columns. The grey matter is slimmer-looking than in the lumbar region though its mass is about the same. The ventral cornu is more expanded laterally, the angular recess between the ventral and lateral horns being, as in the lumbar region, filled up with cells—containing grey matter. In the upper cervical region this protuberance diminishes and the lateral cornu becomes prominent through the emergence at that point of the fibres of the spinal accessory nerve.

Bulb. T.S. Man, *below the olive.* (p., &c., the same as for the last.) The canal is still central. The ventral cornu

of the grey matter is cut off from the remainder by the *decussation* of the *pyramids*, and the dorsal cornu are twisted laterally. Two new masses of grey substance, the Gracile and Cuneate nuclei, are seen in the corresponding dorsal columns. On each side of the ventral fissure note the pyramids from which the fibres decussate into the lateral columns. On the dorso-lateral part of the section note the crescentic mass of white substance, the *restiform* body. The fibres of the twelfth nerve may be seen passing from the ventral cornu and running to the surface on the outer side of the pyramid.

Bulb. T.S. Man, *through the olive.* (p. same as the preceding.) The section has a rounded quadrangular outline, the dorsal corners being formed by the restiform bodies, the ventral ones by the *olives*, which are rendered prominent by the sinuous streak of grey substance which they contain. Between the latter on each side of the ventral fissure are the pyramids. On their free surface note the external arcuate fibres. Dorsally find the floor of the fourth ventricle, against which the grey matter has become applied. It forms two or three small projections ventralwards where the tenth and twelfth cranial nerves have their origin.

Cerebellum. Man. T.S. *Convolutions.* (p. the same as the last.) (*L*) The foliations of the grey matter have a core of white substance (stained dark). The grey substance exhibits two distinct layers—the outer, *molecular*, and the inner, *granular*. At the junction of the two (*H*) find *Purkinje's cells* (not well seen).

Cerebellum. Cat. T.S. *Convolutions.* (p. 8, s. 22 & 24, c. P, m. B.) (*L*) Recognise the granular layer which is brought out prominently by the hæmalum stain. (*H*) Examine the *Purkinje's cells*, the antler-shaped processes of which can

be traced some little way into the molecular layer. The spread of the branches is in a plane transversely to the length of the convolutions.

Pons Varolii. Man. T.S. (p. 23, s. Eosin, m. B.) Its mass is divisible into a larger ventral portion, in which there are large transverse bundles of fibres interspersed amongst the cut bundles of the pyramidal tracts. The dorsal portion is marked off below by the fillet, a well marked angular tract of fibres. Near the dorsal surface is the *aqueduct* of Fallopius, surrounded by grey substance (origin of the fourth nerve). Note the dorsal eminences formed by the *posterior corpora quadrigemina*.

Midbrain, *crura cerebri* and *corpora quadrigemina*. Man. T.S. (p. the same as the last.) The *tegmental* (dorsal) portion contains the *aqueduct* surrounded by a thick layer of grey matter (origin of the third nerve), and shows the prominences of the corpora quad. The *crusta* (pes) forms the crus proper on each side, and consists of distinct masses separated from the tegmentum by the *substantia nigra*, which is a broad band of grey matter. The crusta is composed of fibres cut transversely, the middle portion of which is the continuation of the pyramidal tract (long motor). Above the *substantia nigra* in the tegmentum, and placed laterally, is the fillet (sensory tract), whilst near the middle line on each side are the round masses of the red nucleus.

Cerebral cortex. Man. V.T.S. Convolution. (p. the same.) The grey matter is pink and the medullary is blue, and consists of axons proceeding to and from the grey matter. The position of the pyramidal cells can be made out.

Cerebrum. Man. V.T.S. Ascending frontal or parietal convolution. (p. Golgi, 27, s. 24, m. B., uncovered.) (*L*) Find

a successfully stained *pyramidal cell*. Note its shape and processes. (H) The chief dendritic process is apical which runs to the periphery, giving off short lateral branches and terminating fanwise near the periphery. Lateral processes come off the cell body itself. A thin axon courses centrally, and gives off collaterals. The cells of the *polymorphic* or fourth layer are small and have few dendrites and a fine peripheral axon. Fine vertical filaments unconnected with cells are also to be noted.

Neuroglia cells are scattered in the cortex, the body is small and emits numerous delicate branching processes.

MALE ORGANS OF GENERATION.

Testis and epididymis. Man. (p. 11, s. 22 & 24, c. P., m. B.)
The testis proper is enclosed in a thick fibrous capsule (tunica albuginea); within this is the simple tubular structure filled with cells. Dorsally will be found the epididymis, consisting of large tubules separated by much fibrous tissue, in which are blood vessels. (*H*) The cells in the tubules can be studied better in the next preparation. The canals of the epididymis are surrounded by plain muscle and contain two or three layers of cells, the innermost of which are columnar with long cilia.

Testis of Rat, for spermatogenesis. (p. 9, s. 22 & 24, c. P., m. B.)
(*H*) Find T.S. tubules that show sustentacular cells, the ends of which are expanded by spermatoblasts applied to their free ends; in them the heads of the spermatozoa can be seen. Note the flagella of the latter projecting into the lumen. The remaining cells are known as the spermatogenic cells, which vary in shape from spheroidal to squamous, and exhibit various nuclear figures. Between the tubules in the lymph spaces occasional narrow tapering columns of interstitial cells are met with.

Vas deferens. Dog. (p. 11, s. 22 & 24, c. P., m. B.) (*L*) and (*H*) An external coat of plain muscle, to which the mucosal surface, covered by ciliated epithelium like that of the epididymis, is loosely attached.

Prostrate gland. Dog. (p. 11, s. 22 & 24, c. P., m. B.) (*L*)
A lobulated true gland embedded in a fibro-muscular capsule. The racemose acina, with wide lumen, are lined by small cylindrical cells with distinct nuclei. (*H*) The cytoplasm is finely granular.

The short ducts are furnished by the same kind of epithelium. The urethra membranous portion, lined by transitional epithelium at its junction with the neck of the bladder, is frequently included in the section.

FEMALE ORGANS OF GENERATION.

Ovary. Rabbit, for germinal epithelium. (p. 16, s. 22 & 24, c. P., m. B.) (*L*) and (*H*) Upon the surface find the single layer of small ovoid cells resting upon the stroma of the organ. In the latter, a little below the surface, there is a zone of young ova. Originating in the surface layer they become included in the stroma, thereafter increasing in size. Large ones in Graafian follicles occur further in and tend to approach the surface as they enlarge. Rounded masses, corresponding to the former in size, or larger, and filled with blood or cellular contents, the Corpora lutea, should also be sought for. Find the broad ligament or attachment of the ovary. In it are contained the blood vessels, &c., going to the organ. (*H*) Examine the epithelium; the subjacent stroma has numerous oval nuclei. Trace, if possible, the inclusion of the germinal cells in the stroma and the formation of the Graafian follicle around them. In this the ovum is at first surrounded by a single layer of cells (discus proligerous); then by several layers, amongst which a cavity is produced by accumulation of fluid (liquour folliculi). Observe the thick cell wall of the ovum (zona radiata) and the appearance of the nucleus, which varies greatly with its maturation. The corpus luteum will, if just formed, namely, if the ovum which it contained has been recently evacuated, be full of blood, in which fibrin filaments may be seen; or its margin may be occupied by large cells, the blood clot being reduced to a central stellate mass, or, again, the latter may have disappeared and cells only be present.

Ovary. Rabbit, for corpus luteum. (p. 2 d, c. P., Weigert's fibrin stain m. B.) In this preparation examine the details already mentioned and the elements of the stroma.

Fallopian tubes. Cat. T.S. (p. 3, inj., s. 22 & 24, c. P., m. B.) (L) and (H) Externally a muscular coat (plain), to which internally a folded mucosa, covered with ciliated epithelium, is loosely attached.

Uterus. Rabbit or Cat. T.S. (p. 3, inj., s. 22 & 24, c. P., m. B.) (L) and (H) The vascular mucous lining is closely packed with long tubular glands (cubical and columnar spith) which have duct-like openings upon the surface. Externally to this is the circularly disposed plain muscle in many layers.

Vagina. T.S. Cat. (p. 3, inj., c. P., m. B.) (L) and (H) The surface epithelium is stratified squamous and rests upon connective tissue, in which small papillary elevations are perceptible. Mucous glands will be found in this layer, and externally plain muscle mingled with connective tissue.

29 *Mammary gland.* Human, non-lactating. (p. 11, s. 22 & 24, c. P., m. B.) (L) The glandular tissue is scanty and widely separated by rather dense connective tissue. The ducts are narrow.

Mammary gland. Cat. Lactating. (p. 11, s. 13 & 17, c. P., m. B.) The secreting structure occupies the whole gland, and the acini are polygonal through distension and mutual compression. The epithelium is closely packed along the walls, the ends of the cells projecting irregularly into the lumen. Note the fat stained black in the cells and in the contents of the lumen. Find the milk ducts and their expansions in the nipple. The nipple is covered with squamous epithelium, and on its sides small sebaceous glands occur. Small strands of non-striped muscle may also be made out in the connective tissue.

CHAPTER XVII.

SENSE ORGANS.

Olfactory epithelium. Guinea pig. (p. 3, s. 11, 22 & 24, c. P., m. B.) (*L*) The mucosa of the olfactory region is covered with many layers of cells, fusiform and columnar in shape and non-ciliated. Beneath this note the glandular masses (Bowman's glands) and the numerous nerves making their way to the surface. (*H*) In very thin sections it is possible to recognise the two kinds of cells. The olfactory cells are thin, with a swelling over the nucleus; the end which reaches the surface is provided with short bristle-like processes. The other cells are columnar near the surface, fusiform and irregular further in.

Isolated olfactory cells. (p. An exposure of the brown membrane of the turbinated bone of a rabbit for 24 hours to one-third alcohol, five minutes in 1^{p.c.} osmic acid, stain in 19 in bulk; dissociate and diffuse in glycerin jelly (after Stirling). The thin olfactory cells can easily be recognised from the columnar supporting cells. The latter are irregular and branched at their attached extremities.

Eye. V.T.S. Head of mammalian foetus, for the general structure and origin of its parts. (p. 16, s. 22 & 24, c. P., m. B.) (*L*) Find the cornea, the part nearest the cutaneous surface, and note its continuity with the external coat or sclerotic of the eye-ball. Within this, in front, is the voluminous lens, the fibrous nature of which is perceptible even with a low power; note their backward trend. On each side of the lens posteriorly find the ciliary bodies, or what represents them at this stage, a slight thickening, which trace into the thin choroid. The pigment will

probably not yet be developed, and this coat may be difficult of detection. The retina comes next as the inner covering of the eye, and may exhibit two distinct layers continuous with each other in front (line where the infolding has occurred) if the eye is young enough. The outer thinner portion, probably containing pigment, will form later the pigmentary layer of the retina. Internally to this is the retina proper, i.e., that portion which subsequently is alone connected with the optic nerve. Trace the optic nerve into connection with the retina and note its central artery. As it is not always possible to ensure a fœtus of the younger age, at which the simpler evolution of the eye-cup from the brain vesicle is best seen, this description is intended to apply equally to older preparations.

Corneo-sclerotic junction. Dog or Cat. V.S. (p. 8, s. 22 and 24, c. P., m. B.) (*L*) and (*H*) Externally the *cornea* is covered with stratified (conjunctival) epithelium, the innermost cells of which are columnar; beneath this is the corneal substance of dense fibrous tissue, amongst the layers of which spindle-shaped *corneal corpuscles* are disseminated. On the inner surface there is a homogenous membrane—*internal elastic lamina*—covered by a single layer of flat cells. The junction of cornea to sclerotic is indicated by the occurrence of the pigment and blood vessels of the sclerotic. Internally to this is the attachment (*Lig. annulare bulbi*) of the *choroid*, which is the pigmented and *vascular* coat of the eye. The choroid has three subdivisions:—The *Iris* in section hangs into the anterior chamber, and the surface turned towards the cornea is covered by a single layer of densely pigmented cells. Throughout its substance there are branched cells and blood vessels. Towards the free edge bundles of plain muscle are added (Sphincter). Beneath the epithelium of the inner surface there is a fibrous layer free of pigment. The *pectinate ligament* is the frayed

edge of the internal elastic lamina, and its fibres cross the angle of junction and penetrate into the iris. The ciliary portion of the choroid is pervaded by branching pigment cells; its inner surface is covered by a deeply pigmented layer, upon which rest clear columnar cells; these are continued to the retina. This inner layer is much folded and a thin homogeneous membrane is attached to its surface (suspensory ligament to choroid and inner limiting layer). The strands of the ciliary muscle (plain) will be observed radiating outwards from the corneo-sclerotic junction into the ciliary body. The union of the choroid and retina occurs further back; observe the angular bend of the surface at the *ora serrata*.

Cornea. Cat. V. & L.S. (s. Ranvier's gold method, c. P., m. B.)

(H) Examine these successively for the distribution of nerves, the superficial plexus of which is best seen and lies immediately beneath the conjunctival epithelium. In the L.S., besides an irregularly distributed plexus of nerves, observe the branching processes of the corneal corpuscles.

Lens fibres. Cod's eye. (Boiled in water, teased in the same, stained s. 19, m. F.) The band-like fibres seen on edge in clusters exhibit ridges. Seen isolated in side view they are smooth, with denticulated margins (whereby they interlock).

Optic papilla. Dog. V.S. (p. 11, 22 & 24, c. P., m. B.) **30**
Find the entrance of the optic nerve through the sclerotic (cribriform lamina) and its overflow laterally over the choroid, and the appearance of the retina immediately outside. A central section will show the central artery of the retina cut lengthways.

Retina of Cat, for general structure. (p. 8, s. 22 & 24, c. P., m. B.) The inner layer, i.e., that which lies nearest the vitreous humour, is smooth and bounded by the inner limiting membrane,

from which spring the fibres of Müller. These run outwards (invisible beyond the third layer) to the outer limiting layer, and form the sustentacular system of the organ. The nervous elements are next in order from the first layer outwards (2) fibrous layer of nerve fibres, (3) Ganglionic layer, nerve cells, (4) inner molecular layer, (5) inner nuclear, (6) outer molecular, (7) outer nuclear, (8) outer limiting, (9) rods and cones, (10) pigmentary layer. Layers (5) and (6) are stained and so stand out prominently. (II) Examine the different layers and observe that the cones are much less numerous than the rods.

Retina, Frog. Illuminated. (p. 8, s. 17, c. P., m. B.). (L) Recognise the outer or pigmentary layer, also the two nuclear layers (stained red), and the outer limiting layer, which separates the external nuclear from the layer of rods and cones. In the latter the rods are the prominent structures, particularly on account of their large outer segments, which are unstained, and between which prolongations from the pigment cells pass nearly to the limiting layer. The external part of the pigment cell contains less pigment granules, and the nucleus is well seen.

Retina, Frog. Killed after being kept 12 hours in *darkness*. (p. same as before.) The distribution of the pigment is the point of interest. Observe that it is retained in the body of the cell itself, very little of it occurring between the rods. It is now possible to find the cones; these are small spindle-shaped structures, which are placed at various distances from the outer limiting layer, with which they remain connected by a delicate process, and often project some way towards the pigmentary layer.

The Ear. *Cochlea.* Guinea pig. L.S. through the modiolus. The bulla being exposed and opened, the cochlea is removed,

the lower turn punctured. (p. 9 for one hour, transfer to half strength 14a until decalcified, then increasing alcohols, s. 22 and 24, c. C, clear in origanum oil, m. B.) (L) Find the cochlear tube in section and the osseous spiral lamina which projects into it. The latter has two lips separated by the sulcus spiralis. From the longer (tympanic) lip, the basilar membrane stretches across the tube to be attached to its outer side by the spiral ligament. Inwards from the upper (vestibular) lip or limbus the membrane of Reissner, one cell thick, stretches to the outer wall, where it becomes continuous with the epithelium of the spiral ligament, thus enclosing the triangular cochlear canal of the membranous labyrinth. That portion of the cochlear tube which lies outside the basilar membrane is the scala tympani (to fenestra rotunda), and that outside Reissner's membrane is the scala vestibuli (to fenestra ovalis). The lamina spiralis ossea contains the spiral ganglion and nerves passing to the organ of Corti. The membrana tectoria attached to the surface of the limbus is fusiform in section, with its free end curled up, and extends over Corti's organ. (II) The organ of Corti, with its inner and outer (rods) sustentacular cells (enclosing the spiral canal), reticular membrane, hair and Deiter's cells, then Hensen's cells on the external side forming a rounded mass, become continuous with the flatter epithelium lining the remainder of the canal. The stria vascularis, a thickening of the membranous wall, is placed between the spiral ligament and the attachment of Reissner's membrane. In this preparation a section of the Eustachian tube is often included. It consists of an incomplete tube of hyaline cartilage, lined by a thin mucosa, with a superficial covering of columnar ciliated epithelium.

Semi-circular Canals. L.S. Ampulla, Guinea pig. (p. osmic 1^{p.c.} 4 hours, then 14 (a), s. 22 & 24, c. P., m. B.). (L & II)

Find the ampullary expansion of the semi-circular canal, and recognise that it is lined with flat epithelium, lying close to the osseous walls. On the outer wall will be found the crista acoustica in T.S. On the latter the lining epithelium forms a cluster of larger cells, from which project hair-like processes into the cavity of the tube. Note that the crista is arranged with its length across the axis of the tube.

APPENDIX TO THE HISTOLOGICAL SECTION.

PRESERVING, FIXING AND HARDENING FLUIDS.

General Rules.—1. Fix as soon after death as possible. 2. The size of the piece of tissue to be treated is of the first importance and will vary with the density of the tissue and the penetrating power of the reagent used. 3. Not less than 20 volumes of fluid to one of the tissue are to be used, and the object should be suspended by a thread in the upper part of the reagent or laid on a bed of absorbent cotton so that the fluid may have ready access.

1. **Normal saline solution.** 0.6 p.c. NaCl (6g of dry NaCl are dissolved in 1,000^{cc} of distilled water). This fluid is used for the examination of fresh tissues, and delays changes in them for a short time; though not perfectly "indifferent," owing to its convenience is much used. Egg white is a useful substitute. Aqueous humour or iodised serum (blood-serum to which iodine crystals have been added) are sometimes used.

2. **Alcohol.** An indispensable reagent in histology.

(a) *Absolute alcohol* is chiefly used for final dehydration of tissues. Used alone it fixes and hardens epithelial structures well. 24 hours to several days according to the size and density of the tissue.

(b) *One-third alcohol* (Ranvier). "Alcool au tiers." 1 part 90 p.c alcohol and 2 parts water. Ranvier's original receipt is "Alcool à 36° de Cartier" (88.5 p.c. pure alcohol) 1 part, water 2 parts. Dissociates epithelial structures in 24 to 48 hours.

(c) *After-hardening.* With increasing strengths, starting from 70 p.c., several changes, at intervals of 24 hours, through 80 p.c. to 90 p.c. In the latter, tissues or sections may be kept stored for later use in well-stoppered bottles. Tissues fixed in chromium salts should either be washed in water before the alcohol treatment, or be kept in the dark until all colour has been washed out by changes of alcohol, 70 p.c., otherwise a green precipitate is apt to form. After corrosive fixing, see precautions indicated later. Prolonged after-hardening in strong alcohol (methylated spirit) for several weeks confers great firmness upon tissues and enables them to resist the strain of embedding more perfectly.

(d) *Methylated spirit* does well for nearly all purposes as strong alcohol. If methylated spirit loses its clearness, and turns at all milky on dilution with water, it is unfit for use, being surcharged with resins.

3. Corrosive sublimate. HgCl_2 . A saturated solution in water or normal saline. Fixation takes place rapidly in from five minutes to two hours, the time being determined by the density and size of the piece of tissue. As this reagent does not penetrate freely small pieces only can be fixed. They must not exceed 6^{mm} thick, and these will take two hours to fix. Thinner though wider pieces will take a shorter time.

Injection through the blood vessels is the best method, complete penetration being secured in a few minutes. The parts must then be cut up rapidly under running water.

After-treatment with increasing strengths of alcohol tinted sherry colour with iodine solution until discoloration ceases. The *Iodine* helps to remove uncombined corrosive sublimate which would otherwise form crystalline deposits and obscure the sections. Alcohol aids this removal, as corrosive is more soluble in it than in water (33 parts in 100 in alcohol, 25 in ether, 7 in water).

4. Alcoholic corrosive. 50^{cc} of 70^{p.c.} alcohol, 50^{cc} of saturated solution of HgCl_2 in 70^{p.c.} alcohol, 6 drops of HNO_3 . Only very small pieces 4^{mm} thick can be fixed in this. Time required 1 to 4 hours. Then increasing strengths of alcohol.

Note.—Whilst the aqueous solution is one of the best general reagents the alcoholic form is especially good for ganglia and glandular tissues such as liver, kidney and salivary glands. Tissues stain well after corrosive treatment.

5. Chromic acid. Solutions from 0·2 up to 1^{p.c.} in water have been used. This reagent is a bad penetrant, soon turns the tissues brittle, and is now seldom used alone. It fixes well. The following mixtures are used chiefly for epithelial and nuclear structures.

6. Chrom-acetic fluid (Flemming). Chromic acid 0·25^{p.c.}, acetic acid 0·1^{p.c.}, in water. Very small pieces of tissue take about two days, then increasing alcohols the weaker strengths being several times renewed, until discoloration by the escaping chromic acid ceases.

7. Chromo-formic fluid (Rabl). To 200^{cc} of an aqueous 0·33^{p.c.} solution of chromic acid add four or five drops of formic acid. Time and after-treatment the same as **6**.

8. Chromo-nitric fluid (Perenyi). To 3 parts of 0·5^{p.c.} chromic acid add 4 parts of 10^{p.c.} nitric acid and lastly 3 parts of strong alcohol. Time 4 to 8 hours, followed by the same after-treatment as **6**.

9. Chromo-aceto-osmic fluid (Flemming's fluid). A much used cytological reagent. There are two formulæ, the weak one is the more useful. Chromic acid 1^{p.c.} 25 parts, osmic acid 1^{p.c.} 10 parts, acetic acid

1 p.c. 10 parts, water 55 parts. Small pieces take from 2 to 24 hours, followed by thorough washing in water and after-hardening in alcohol.

10. **Platino-aceto-osmic fluid** (Hermann's solution). Platinic chloride 1 p.c. 15 parts, glacial acetic acid 1 part, osmic acid 2 p.c. 2 or 4 parts. This fluid does not produce "artificial" networks in protoplasm. Time and after-treatment same as 9.

11. **Müller's fluid.** Dissolve 25 g potassium bichromate and 10 g sodium sulphate in one litre of water. Change the fluid on the 2nd, 4th, 6th, and 14th days. Six to eight weeks are required to produce the necessary toughness. This is one of the best penetrants and a reliable reagent. After-treatment with alcohols in the dark until discoloration ceases.

12. **Müller and spirit.** 3 parts of Müller, 1 part of spirit (methylated). Let the mixture cool before use. After 3 days, change to bichromate of ammonia 2 p.c. solution. Hardening is sufficient in about three weeks. The after-treatment is the same as for Müller. A good general reagent. This mixture forms the first step in Hamilton's method for hardening large masses of brain. Keep from the light and use fresh.

13. **Osmic acid.** This reagent is an instantaneous fixer, and has been regarded as devoid of any distorting effect upon tissues. It penetrates so slowly that only very small pieces of tissue can be treated. As a fixing and hardening reagent it is used for nerves whose medullary sheaths it is desired to recognise. 1 p.c. solution in water 24 to 48 hours, followed by strong alcohol if sections are required. Cut in paraffin. Its vapour from a 2 p.c. solution has been employed for fixing glandular tissue (Langley). It is mostly used in conjunction with other agents, or upon sections of already fixed and hardened tissues to stain fat, which it turns black and for which 0.5 to 1 p.c. solutions are used, 12 to 24 hours.

14. **Bone-softening fluids.**

(a) Chromic acid 12 g, HNO_3 25 cc, water to 1000 cc for decalcifying bones, teeth, and hardening the soft parts at the same time. Followed by alcohol treatment the same as 11 in the dark.

(b) Picric and nitric (or sulphuric) acid. The former saturated in water containing 2 p.c. nitric acid. Chiefly useful for embryonic bones and teeth. As soon as the lime salts are removed, after-hardening by increasing alcohols is necessary. The picric acid should be completely removed by the changes of alcohol.

(c) It is best to fix and harden first by means of Müller or corrosive and subsequently to decalcify with 2^{p.c.} HNO₃ or 1^{p.c.} HCl. After-harden with alcohols.

15. Sulpho-picric Acid (Kleinenberg). To a saturated aqueous solution of picric acid add 2^{p.c.} H₂SO₄, let the pp settle for an hour, filter, and add three parts of water. The pieces must not be large, treat from 3 to 6 hours, followed by increasing alcohols, by which all colour should be removed. Tissues stain well afterwards. Good for young tissues.

16. (a) Formol (Formaline) is a saturated solution of formaldehyde in water, and contains 40^{p.c.} of the gas. This reagent penetrates well and hardens central nervous tissue rapidly. A 10^{p.c.} solution in water (formol 1 part, water 9 parts) is commonly employed for the first 24 to 48 hours, to be followed by 5^{p.c.} solution until the required density is acquired, when a 2½^{p.c.} solution may be used for subsequent preservation. Large masses of tissue are soon penetrated and may be cut by freezing in gum without impregnation.

(b) **Formol-Müller** (Orth quoted by Kahlden). (1 part formol, 50 parts Müller.) This requires to be fresh, as the mixture becomes turbid and deposits (even in the dark) after about four days. For rapid hardening of tissues at 35° C. in 3 to 6 hours. The pieces are then dipped into gum, frozen and cut or followed by thorough washing and after-treatment with alcohol.

STAINING.

17. Borax carmine (Grenacher). Carmine 3 g, borax 4 g, water 100^{cc.} Warm moderately until the carmine is dissolved. When cold add an equal volume of 70^{p.c.} alcohol; or the latter may be omitted. A good bulk stain, though rather slow in action, 48 hours to a week, or more. After-treat in acid alcohol, 1^{p.c.} HCl in 70^{p.c.} alcohol for 24 hours, this concentrates the stain on the nuclei and gives a redder tint.

18. Alum carmine. Boil 1 g carmine in 100^{cc.} of 5^{p.c.} potash alum for 20 minutes. Does not overstain and is not alkaline. The addition of 10^{p.c.} glacial acetic acid improves its penetrative power.

19. Picrocarmine, picrocarminate of ammonia (Ranvier). Carmine dissolved in ammonia is poured into a saturated solution of picric acid in water until saturation is reached, which is indicated by the appearance of a precipitate. Evaporate the mixture to one-fifth its bulk, in a drying chamber. When cool, filter, and evaporate the

filtrate to dryness. The dried residue has the colour of red ochre, and should dissolve completely in distilled water. Use a 1^{p.c.} solution or stronger; add thymol to keep it.

20. Hæmatoxylin. Kleinenberg's formula. Stock solutions.

1. Saturated solution of calcium chloride in 70^{p.c.} alcohol containing alum in excess; filter when wanted. 2. Saturated solution of alum in 70^{p.c.} alcohol. 3. Saturated solution of hæmatoxylin crystals in absolute alcohol. Add 1 part of No. 1 to 8 parts of No. 2, then a few drops of No. 3 until a moderately deep purple colour results. This keeps almost indefinitely without depositing. The reddish colour turns to the characteristic violet on the addition of water. It stains rapidly, and is especially useful for staining on the slide. Diluted with 3 or 5 volumes of No. 2 it stains well in bulk. Small pieces of tissue.

21. Heidenhain's Hæmatoxylin stain. A bulk stain. 1. A 0.5^{p.c.} solution of hæmatoxylin crystals in distilled water. 2. A 0.3^{p.c.} solution of neutral chromate of potassium in water. Small pieces of glands hardened in absolute alcohol are placed in Nos. 1 and 2 successively, in each for 12 to 24 hours, are then washed in water, treated in alcohol, and cut in paraffin. The colour is steel grey.

22. Hæmalum. Hæmatein can be purchased, and a moderately deep-coloured solution is made in a 10^{p.c.} solution of alum; or dissolve hæmatoxylin crystals in strong ammonia, dry in air, and make a solution as above. This is one of the best nuclear bulk stains. Requires four or more days, according to the density and size of the tissue treated. It does not overstain. Followed by increasing strengths of alcohol to the last of them, a small quantity of eosine can be added to give a ground stain before passing the tissue into cedar oil for paraffin embedding.

23. Weigert-Pal method, Bolton's modification (Jl. Anat. and Physiol., vol. xxxii., p. 264). For brain and spinal cord.

1. *Fixing and hardening.* The tissue as fresh as possible is placed in a large quantity of 5^{p.c.} formaldehyde (1 formol to 7 parts of water). Change occasionally for six weeks; may remain for six months or longer. The tissue may be cut at the end of a week, but the sections have a slight tendency to frill.

2. *Cutting.* Freeze, without previous soaking, in gum. Keep the sections in 5^{p.c.} formaldehyde until wanted.

3. *Mordanting.* Sections are placed in one of the following:—Ferric ammonium sulphate (iron alum) 2^{p.c.}, osmic acid 1^{p.c.} (for other mordants see original paper). The former yields ultimately a blue

violet and the latter a black colour. If treated with the iron alum they remain in it for 24 hours at the ordinary temperature, whilst in the case of the osmic acid they remain until of a fawn colour.

4. *Staining.* After mordanting wash in water and stain in Kultschitzki's hæmatoxylin (hæmatoxylin 1g dissolved in a little alcohol added to 100^{cc} of a 2^{p.c.} solution of acetic acid).

5. *Oxydizing.* Wash in water, place in 0.25^{p.c.} solution of potassium permanganate for five minutes.

6. *Decolourising.* Wash in water and place in Pal's decolouriser (oxalic acid 1g, solution of sodium sulphate 1g, distilled water 200^{cc}). In this they remain until the grey matter is decolourised. If this does not occur in five minutes repeat the processes 5 and 6. Finally rinse in water and pass through absolute alcohol, through toluene, or chloroform to xylol (Bolton), and mount in balsam. The great advantage is that No. 4 solution keeps a considerable time as compared with Weigert's formula.

24. **Eosin.** A strongly tinted or saturated solution in water or alcohol is employed according to the purpose for which it is required. Strong aqueous solution for staining blood films or sections on the slide. The alcoholic solution is used for imparting a ground stain in bulk when dehydrating before clearing for paraffin embedding.

25. **Spiller's** purple or fuchsine are used in strong aqueous solutions. These stain elastic fibres selectively.

26. **Methylene blue** (S. Meyer's). 0.5^{p.c.} to saturated solution in normal saline for staining nerve terminations in tissues. In time it also colours nuclei and the cement substance between epithelial cells. Free access of oxygen is required during the process, as colourless leuco-products are otherwise formed in the tissues. The stain is evanescent and must be fixed when at its best stage. A saturated solution of ammonium picrate in water is employed to fix the colour when it has developed to the required extent. Subsequent preservation is accomplished in glycerin, to which an equal volume of ammonium picrate has been added. This is Dogiel's method.

Bethe recommends Ehrlich's subcutaneous injections of successive doses of methylene blue in strong solution. Successful results can be obtained by staining very small pieces of the fresh tissue in a saturated solution, examining small fragments from time to time under the microscope to ascertain the result, and then fix first by 15 minutes' treatment in ammonium picrate saturated solution in water, and then, after *Bethe*, transfer to a mixture containing ammonium molybdate 1

part, distilled water 10 parts, chromic acid (2^{p.c.} solution) 10 parts, and 1 drop of hydrochloric acid, $\frac{1}{2}$ to 4 hours. This turns the blue into an insoluble compound, and at the same time hardens the tissue. $\frac{1}{2}$ ^{p.c.} osmic acid solution may be substituted for the chromic acid; fixation then takes longer, as much as 24 hours. Tissues are then washed, and may be stained in bulk in alum carmine, and are cut in paraffin (avoiding long exposure to alcohol).

27. Gram's method of staining bacteria and nuclear structures.

1. Stain for 2 to 5 minutes in a solution of methyl violet in 2·5 ^{p.c.} carbolic acid solution in water.

2. Transfer the preparation for 1 to 1·5 minutes into a solution of iodine 1, iodide of potassium 2, water 300 parts. In this they turn black.

3. Differentiation in alcohol, until the colour has disappeared and the preparation turns of a pale grey tint.

4. Mount in Canada balsam.

The feature of this process lies in the use of the iodine solution, which transforms the previous diffuse stain into a selective one, by acting as a mordant.

Bacteria, nuclei (partially), especially those in mitosis, plasma cells (Mastzellen), the horny layer of the epidermis and serous epithelium.

A ground stain may be imparted to the cytoplasm of cells by adding a little eosin to the last alcohol used in differentiating.

This method can be used for blood films.

28. Weigert's fibrin stain. Sections of tissue hardened in alcohol treat as follows:

1. Stain 5 to 10 minutes in saturated solution of gentian violet in anilin water (anilin oil 5^{cc} shaken up with water 100^{cc} and filtered until clear).

2. Wash in 0·6 ^{p.c.} NaCl solution.

3. Dry on the slide with filter paper.

4. Decolourise for 2 to 3 minutes in a solution of iodine in iodide of potassium (1 : 2 : 100).

5. Dry with filter paper.

6. Decolourise with anilin oil 1, xylol 2 parts.

7. Remove the anilin-xylol with xylol.

8. Mount in Canada balsam.

29. Beneke's modification of the above, for general purposes. The strength of the anilin decolourising solution is diminished by mixing 2 parts of the latter with 3 of xylol.

By means of this it is possible so to manage the stain as to colour dividing nuclei, connective tissue fibres (blue-violet to red-violet), elastic fibres (red), fibrillæ of bone and Sharpey's fibres, striated muscle and neuroglia of nervous tissue.

30. Carbol-Fuchsine. Fuchsine 1, in 100 parts of a 5^{p.c.} solution of phenol in water. To this add 10^{p.c.} alcohol.

31. Löffler's alkaline methylene blue. To a saturated alcoholic solution of methylene blue 30^{cc} add 1^{cc} of a 1^{p.c.} solution of potassium hydrate and 100^{cc} water.

32. Nitrate of silver. For staining endothelial outlines a 0.2^{p.c.} or weaker solution to 1^{p.c.} in distilled water is used. The surface to be treated is extended without stretching (pinned out on a cork ring with hedgehog bristles), is quickly rinsed with distilled water, and then flooded with the silver solution which is allowed to act for three or four minutes or longer, according to the depth of staining required. Both sides of a membrane may be stained. Rinse again with distilled water, and place the tissue in 70^{p.c.} alcohol and expose to sunlight.

For demonstrating *cell-spaces* in tendon or connective tissue, or Ranvier's crosses in nerves, exposure for 20 minutes to a 1^{p.c.} solution will be necessary (the time depending on the light). Wash in water as soon as the staining is complete and pass into balsam. For *blood-vessels*: wash out the blood-vessels with a 2^{p.c.} solution of nitrate of soda, follow this with an injection of a 0.2^{p.c.} solution of the silver salt, and inject without loss of time either 70^{p.c.} alcohol or a solution of gelatine (10 of dry best gelatine in 100^{cc} of distilled water). Expose to sunlight.

Golgi's chromate of silver process, for central nervous system, nerve terminations, and secretory channels in glands. Tissue hardened in Müller's fluid does well. A small piece of this, 4^{mm}, or about $\frac{1}{2}$ in. thick is placed in 0.75^{p.c.} solution of silver nitrate for 24 to 48 hours; sections are cut by hand or by the freezing method without impregnating but simple immersion in the gum for a few minutes so as to surround the preparation with gum on the plate of the microtome. Mount the sections uncovered in balsam on the slide or on cover-glasses, and in the latter case *when the balsam is dry* invert the preparation on to a slide upon three feet of wax or paper, and fix to the slide with a strip of gummed paper or a label with a circular hole cut in it. Rapid drying of the balsam is necessary, as the chromate of silver deposit soon turns granular.

Golgi's rapid method. The fresh tissue is placed in the following solution for three or four days: Potassium bichromate 3 g, 1^{p.c.} osmic acid 30^{cc}, distilled water 100^{cc}. For each piece of 4^{mm} cubed 30^{cc}

are required. The best temperature is 20° to 25° C., then rinse in distilled water and transfer to a solution of nitrate of silver, 0.5 to 0.7 p.c., for 24 hours to several days. The rapid process is best for young structures, before the meylne sheath has developed. (S. R. Cajal recommends the addition of formic acid, 1 to 2 drops to 300^{cc} of the silver solution, when dealing with cerebellum and cerebral cortex which are nearly fully grown.)

Double impregnation method (S. R. Cajal). After the treatment already mentioned, blot off the silver solution; the pieces of tissue are placed in bichromate of potassium 6 or 7 g, water 100^{cc}, osmic acid 1 p.c. 30 to 35^{cc} or less. In this they remain for two days. Blot off the surface fluid, and return to the silver solution for 24 hours.

33. Gold chloride. (*Ranvier's boiled gold. Traité technique*, page 826.) Gold chloride 1 p.c. solution in distilled water 4 parts, formic acid 1 part; boil and cool. Place small pieces of tissue in this for 20 minutes or longer. Wash and transfer to formic acid diluted with four volumes of water, and keep in the dark for 24 hours. Dissociate in glycerin. Good for end plates in muscle.

Lemon juice method. Ranvier, l.c., page 813. Place the tissue in freshly expressed juice (filter through flannel). Transfer to 1 p.c., 5 to 10 minutes, until it has become transparent. Transfer to 1 p.c. gold chloride for 20 minutes, then wash in distilled water; reduce in 50^{cc} distilled water with 2 drops of acetic acid, in the dark, for 24 hours.

Tartaric acid method. Stain the tissue in 1 p.c. gold chloride until it is penetrated, one-half to two hours, for cornea, rinse in water; reduce in nearly saturated solution of tartaric acid kept at 50° C. (embedding bath) until a greyish violet colour is produced: 20 minutes to one hour.

34. Morpurgo's method for isolating muscle fibres. Virchow Archiv., Vol. 10, p. 540.

1. Fix in *salicylic acid 2.5 p.c. in alcohol*, renew several times, after a week replace by

2. *Concentrated solution of salicylic acid in water*, which should gradually replace the alcoholic solution. After all the alcohol has been removed, then

3. Envelope the pieces in cotton wool, *boil* in the aq. solution for an hour in a water bath, and let the tissue remain in the cooled fluid for *two weeks*.

4. After this period the muscles may be removed with a spoon. They will be found practically free of fat and connective tissue, and only loosely attached, but in their original relationship. They can now be detached with a spatula from the bone, and be isolated by teasing or pressure. The fibres are coagulated and tough. By careful separation in dilute glycerine the fibres can be completely isolated and measured.

Injection of blood vessels with coloured gelatin masses.

As this is an operation which the student is ordinarily not required to perform himself, a sketch of the process will suffice. Access to the blood vascular system is gained by exposing the heart of an animal with the least injury to the surrounding parts, in order to guard against the escape of injection through accidentally injured blood vessels. The apex of the heart is cut off and the blood allowed to escape. A glass cannula or nozzle is secured in the aorta, and is connected with the injecting apparatus. A ligature is disposed around the ventricles ready for closure in order to control the venous outlet. In the case of a single organ the cannula is secured in the chief artery and bull-nosed artery forceps are used to control leakages and the venous channels. The injection apparatus is a brass syringe or an appliance acting under continuous air pressure. When all parts of the object appear injected the venous outlet is closed, the pressure is maintained a little longer and the aorta is clamped to confine the injection. During the injection avoid the introduction of air with the fluid, arrest leakage from injured blood vessels, and use the lowest pressure that will suffice to drive the fluid through the capillaries the occurrence of which can be recognised by the change of colour in the tongue, nose, eyes, &c. The gelatine mass is then set by immersing the object in cold alcohol, after which the parts required are cut into suitable pieces and hardened in spirit.

Blue gelatin mass. Take 25 parts of a saturated solution of soluble Berlin blue (Brücke's blue),¹ warm it and to it add slowly, with constant stirring, 1 part of the best French gelatin, which has been allowed to swell in distilled water, and has then been melted by heating in the water which it has imbibed. When thoroughly incorporated filter the mixture through flannel wrung out of hot water; it is then ready for use. Injected parts gain by being preserved at first in Müller's fluid or 2^{p.c.} bichromate of ammonia the colour of the mass is thereby greatly improved (Ranvier). After staining in bulk with borax carmine cut by freezing in paraffin.

¹ Can be obtained from Dr. Grübler, through Kauthack, 18, Berner's Street, London, W.

Carmine gelatin mass. Take 4^g of carmine and dissolve it in the least quantity of strong ammonia in a mortar, let it nearly dry up, much superfluous ammonia is thus got rid of, and rub it in 50^{cc} of distilled water. When completely dissolved filter and warm. Place 10^g of clear gelatin cut up small into 50^{cc} of distilled water. When the gelatin is completely swollen up heat it in the water-bath until it is dissolved. Add the gelatin to the carmine with constant stirring until incorporated, and then add drop by drop a 10^{p.c.} solution of acetic acid until the colour of the whole is changed to a brighter red, the transition is a very noticeable one; the mixture should have a distinct odour of acetic acid and have an acid reaction. The carmine is thrown out of solution, but no precipitate should be visible under the highest power. Strain through flannel which has been wrung out of hot water.

PART II.

CHEMICAL SECTION.

Students are required to bring the following:—One dozen test tubes, 19^{mm} ($\frac{3}{4}$ in.) in diameter; one packet of filter papers, 10^{cm} (4 in.) in diameter; two beakers, No. 2 size; two porcelain capsules, No. 3 size; three glass rods, 18^{cm} (7 in.) long; a test tube brush.

The following are provided for the student in his locker:—A test tube stand; tripod; retort and burette stand; wire gauze, 5 in.; mug, half-pint, with wires over the mouth; a thermometer, 100° C.; Bunsen burner.

The quantities to be used for each test are given in length of column in a test tube.

CARBOHYDRATES.

Those in italics occur in the organs or secretions.

Mono- Glucoses. ($C_6H_{12}O_6$)	Di- Saccharoses. ($C_{12}H_{22}O_{11}$)	Poly-saccharides Amyloses. ($C_6H_{10}O_5$) _n
<i>Dextrose. (Glu- cose or Grape Sugar).</i>	Saccharose { 1 mol. <i>Dextrose.</i> 1 mol. <i>Levulose.</i>	<i>Starch.</i> <i>Soluble Starch.</i>
<i>Galactose.</i>	<i>Maltose</i> ... 2 mols. <i>Dextrose.</i>	<i>Dextrins.</i>
<i>Levulose.</i>	<i>Lactose</i> ... { 1 mol. <i>Dextrose.</i> 1 mol. <i>Galactose.</i>	<i>Animal Gum.</i> <i>Glycogen.</i>
<i>Glycuronic Ac.</i> (occ. as Gly-ates).		<i>Cellulose.</i>

All optically active are dextrorotary excepting *Levulose*.

I.—GLUCOSES.

Dextrose. Dissolve a large pinch of common grape sugar in a tube full of warm water, and test as follows:—

1. *Trommer's test.* To 4^{cm} of the solution add 2 drops $CuSO_4$ solution, then $NaOH$ solution, until the hydrated oxide of Copper, which falls at first, is redissolved, giving a clear blue colour. Boil = a yellow *pp* of suboxide of copper forms = Reduction. (This test is performed in

the same way as the Biuret reaction for Proteids. In the latter, however, there is no boiling.)

Perform a control test with water. The hydrated oxide is not redissolved.

2. *Fehling's solution.* Take 4^{cm}, boil it, then pour down the side of the sloped tube a few drops of the sugar solution. If enough sugar is present an orange top stratum of suboxide will form in a few moments. If not heat again. Take 1^{cm} of the reduced fluid and add NH_3 until it is redissolved. Note the volumes required to do so (Pavy).
3. Add one-quarter volume saturated solution *Picric Acid* to 4^{cm} of the fluid, and then a few drops NaOH . Heat = a rich red port colour results.
4. *Moore's test.* To 2^{cm} of the fluid add an equal quantity of NaOH solution, boil = a yellow to deep brown colour results, depending upon the amount of sugar present. There is an odour of caramel, especially on adding weak H_2SO_4 .
5. *Phenyl-hydrazin test.* To a tube three-quarters full of the solution add one knife-point of phenyl-hydrazin and one of sodium acetate. Boil in the water-bath for thirty minutes or more. On cooling, or before, a yellow crystalline or amorphous *pp* of phenyl-glucosazone separates. Crystals fine yellow needles in feathery clusters. Examine them under the microscope (*H*).
6. *Barfoed's Reagent.* Performed in the same way as Fehling's test = reduction. Herein differs from milk sugar, maltose and dextrin, which do not reduce this reagent.
7. *Fermentation test* with yeast, see abnormal urine later.

II.—SACCHAROSES.

CANE SUGAR GROUP.

Cane Sugar. Apply the following tests to a solution of 2^{cm} crystals in a tube full of water.

1. Solutions do not reduce (Fehling, Trommer).
2. Easily inverted = *Heat with dilute H₂SO₄ to 100° C.*, very soon a reducing sugar is produced:—

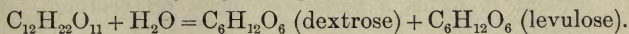

Levulose is the more strongly levorotary, therefore the mixture exhibits left-hand rotation to the extent of the difference between the two.

3. *Barfoed's Reagent* is not reduced by cane sugar.

Maltose is a reducing sugar.

Differs from dextrose because rotary power nearly three times as great—maltose, 150°; dextrose, 50° (10 p.c. solution at 20°). Its reducing power is one-third less. 60 parts dextrose reduce as much as 100 parts maltose. Maltose can be transformed into dextrose easily by acids and ferments, but dextrose not into maltose. Maltose must first be transformed into dextrose before its absorption into the blood. One molecule of maltose decomposes into two molecules of dextrose.

1. *Barfoed's Reagent* is not reduced.
2. *Phenyl-hydrazin test*, see dextrose. Requires several hours boiling. Yields fine yellow needles of phenyl-maltosazone, shorter, but in well-shaped crystals thicker than those of phenyl-glucosazone.

Lactose is a reducing sugar.

Less soluble in H₂O than dextrose. Rotary power same as dextrose. Insoluble in alcohol. *Non-fermentable by yeast*. Lactose must be transformed into dextrose before it can be assimilated. If injected into the veins it appears in the urine.

1. *Barfoed's Reagent* is not reduced.
2. *Phenyl-hydrazin reaction*. See Dextrose. Requires longer boiling. Yields fine and shorter needles than the other two sugars mentioned, usually in heavy clusters.

2

III.—AMYLOSES.

STARCH GROUP.

Starch. Occurs in nature as granules consisting of granulose in a skeleton of cellulose.

1. To a tube two-thirds full of cold water add a couple of pinches of starch, shake briskly, it does not dissolve. Boil, a dull solution results. If enough starch is present it forms a gelatinous mass on cooling. *Starch mucilage.*
2. To some of the solution add iodine solution = Blue colour. Iodide of starch. Heat the blue solution, the colour disappears to return on cooling.
3. To a little (1) diluted add a few drops of NaOH. Iodine does not give a blue colour in an alkaline reaction.

Transformations of Starch. Take as much powdered starch as can be heaped on a penny, place it in a beaker and rub it into a cream with a little cold water. Add this gradually to 50^{cc} water which is boiling briskly in a beaker and stir thoroughly until all the starch is swollen, which will take from five to six minutes. *Thick starch mucilage (A).*

Place a little of this in a tube. Dilute it and test with iodine and with Fehling. No reduction—absence of sugar.

As soon as the temperature of the original starch mucilage has fallen to 40° C. it thickens markedly, then add to it 5^{cc} of pancreatic extract, or of your own saliva¹, stir continually. In a few minutes the mucilage will turn quite fluid through the action of the ferment.

¹ Obtain your own saliva as follows:—Hold a tube against the lower lip to catch the saliva. Open your mouth slightly and breathe the vapour of acetic acid from the reagent bottle. At least 10^{cc} should be collected.

Take half a tubeful, boil it at once, and when cool dilute some of it and test with iodine, blue iodide, and with Fehling—no reduction. *Soluble starch* (B).

Make two-thirds of a beakerful of a fresh digestion with cleared mucilage provided for you, and which has been obtained by allowing some more dilute mucilage to settle until the unswelled grains and non-carbohydrate materials have deposited.

Prepare several tubes of weak iodine solution, by adding a few drops of the solution to a half tube of water in each case.

Test the digestion at frequent intervals by carrying a drop of it with the thermometer into one of the tubes containing iodine. Take specimens as follows, boiling each at once to arrest further ferment action:—

When iodine gives a red port colour—*erythro-dextrin* (C).

When iodine ceases to give this colour and Fehling is not reduced—*achro-dextrin* (D).

When Fehling gives a reaction—*maltose* (E).

Arrange the specimens behind their corresponding iodine reactions in the tube stand ready for the next process.

Precipitation of starch and its derivatives by neutral salts. Form the iodides or use those already obtained and saturate some of each with Am_2SO_4 , or MgSO_4 . A *pp* results. The *pp* occurs without the iodine, but more slowly. NaCl is inactive.

The crystalline carbohydrates dextrose, levulose, cane sugar. Lactose and maltose do not yield this *pp*. (R. A. Young, Jl. Physiology, Camb. and Lond., Vol. xxii., pg. 405.)

Commercial dextrin (British gum, made by heating starch to 200°C .).

Dissolve some of the fawn-coloured powder in water (note the smell).

Test with *iodine* and Barfoed's reagent.

Saturate a small quantity of the solution or the iodide with Am_2SO_4 .

Basic lead acetate gives *no pp.*

3 **Glycogen** (animal starch). A sufficiently pure aqueous solution is obtained by killing a rabbit which has been fed three hours before on carrots. The liver is at once removed, chopped fine, and thrown into actively boiling water, where it remains ten minutes. Proteids are removed by acidulating slightly with acetic acid and boiling two minutes longer. The fluid is then strained through mull muslin, cooled, and *neutralised* with sodium carbonate. It should *not reduce* Fehling. Note how much if any reduction occurs. Examine the solution provided for you as follows:—

1. The solution of glycogen is markedly *opalescent*.
2. Add weak iodine to a portion—*red port* colour. Effect of heating and cooling?
3. Saturate some or the iodide with Am_2SO_4 a flocculent *pp* results.
4. Boil some in a tube with dilute H_2SO_4 ($0.25^{\text{p.c.}}$). Test with Fehling. Reduction indicates the formation of a reducing sugar (dextrose).
5. Barfoed's reagent is not reduced.
6. Basic lead acetate *gives* a *pp*.

The lead acetate *must be basic*. To ensure this plumbic acetate is boiled with litharge for ten minutes, the filtrate will be basic lead acetate.

CHAPTER XIX.

FATS.

Saponification.

1. Take a little melted tallow, add 2 volumes of 10^{p.c.} NaOH, boil with constant agitation for five to ten minutes until the quantity of melted fat which comes to the surface when the tube is held at rest is much diminished. Add water, boil again, cool, run through a wet filter. The filtrate contains the soap which has been formed = saponification.
2. Neutralise 8^{cc} of the filtrate, warm, *saturate* with NaCl, the soap will fall in flocculi; slight warmth assists this separation.

Emulsification.

3. Place in one tube (*a*) some soap solution, and in another (*b*) the same quantity of water. To each add one-third volume of fresh neutral (litmus paper) olive oil and shake them briskly, place them side by side in the rack to stand for 15 minutes: note the difference in the two emulsions. Tube *a* will present a uniform and creamy emulsion.
4. To some *cod liver oil* add 1 volume carbonate of soda solution. Shake briskly, an emulsion results. Soap is formed by the union of the fatty acid in the oil with the alkali.

5. To a solution of *egg albumin* add 1 volume of olive oil. Shake, rest, a more or less perfect emulsion results, depending on the strength of the albumen solution. The mechanically separated fat is kept suspended by the viscosity of the proteid.

Acetone (dimethyl ketone) belongs to the acetic acid series. Perform the following test on a 2^{p.c.} solution of commercial acetone in water. Note its ethereal odour.

Legal's test. A few drops of an aqueous solution of sodium nitroprusside + KOH = red colour which rapidly disappears, and gives purple or violet red with acetic acid. See **Creatinin.**

Interest attaches to this substance owing to its appearance in the blood and urine in diabetes mellitus. It may occur temporarily in the breath, &c., with highly nitrogenous diet.

PROTEIDS.

Albumins and Globulins. *Native proteids.*

Egg white. (S.G. 1,045, Alkaline, contains 10^{p.c.} Proteids, one-twentieth of which is globulin, and nearly 1^{p.c.} salts.)

Break an egg, decant the white from the yolk into a porcelain capsule, cut into it repeatedly with scissors to break up the membranes, strain through wet linen.

Make the following solutions:

1. Measure 5^{cc} into a beaker and add water to 50^{cc}, mix thoroughly by stirring. The turbidity which results is due to the globulin which is thrown out of solution by the dilution of its saline solvent. Strain through mull muslin = solution egg albumin.

2. To another solution of the same strength, unstrained, gradually add with constant stirring small quantities of a 10^{p.c.} solution of common salt until solution of the globulin is effected. Note the approximate percentage of salt required to effect this solution. Strain = solution egg albumin and globulin.

Utilise both of these solutions to perform the following more characteristic reactions, taking about 8^{cc} for each test.

Colour reactions.

1. *Xanthoproteic reaction.* Add 2 drops of HNO₃, a *pp* forms, heat increases it and produces a yellowish tint. Cool, add NH₃, an orange colour results, which may constitute the whole change if the quantity of proteid present is insufficient to give a *pp* with acids or heat. (Due to nitro-derivatives, Salkowski.)

2. *Millon's reaction.* Add 5 or 6 drops of the reagent (acid nitrate of mercury) a white *pp* occurs which heating increases, and ultimately turns to a dull brick red. In weak solutions a red colour may be the only token of a reaction. (Tyrosine, Kühne.)
3. *Piotrowski's reaction.* Add 2 drops of CuSO_4 solution, then sufficient KOH or NaOH solution, until the white *pp* occasioned by the metallic salt is redissolved in the organic solution and a transparent bluish-violet coloration is produced. Perform a control test with water and observe that the *pp* of hydrated oxide of copper which takes place upon the addition of the alkali does not dissolve. This test is also known as the Biuret reaction, because of its resemblance to that obtained with urea.

Reaction with mineral acids. (H_2NO_3 , H_2SO_4 , HCl .)

- 4 Add 2 drops of HNO_3 a white *pp* results. Or by the contact method (Heller's test) pour HNO_3 into the tube to a depth of 2^{cm}, incline it and flow an equal quantity of the fluid quietly upon the acid, a cloud will form at their junction. If the solution be poor in proteid the cloud will disappear on agitating the fluids together.

Effects of metallic salts, &c.

5. Add 2 drops of acetic acid, then 2^{cc} or 3^{cc} of ferrocyanide of potassium, there is a white *pp*.
6. Add 2 drops of *acetic acid* and one-third volume of saturated solution of *picric acid*; a white *pp* results.
7. *Mercuric chloride.* A few drops produce a white *pp*.
A number of other metallic salts do the same.

Miscellaneous reagents.

8. *Absolute alcohol.* Take 5^{cc} of the solution, add an equal volume of alcohol, the proteid partly falls out of solution, not however completely.
9. *Coagulation by Ether.* Upon 2^{cm} in a tube pour an equal quantity of ether, a cloud forms at the junction. The fluid must be neutral.
10. *Tannin.* To 5^{cc} add an equal volume of a 10^{p.c.} solution of tannic acid; a white *pp* occurs.

Precipitation by neutral salts. MgSO_4 , $(\text{NH}_4)_2\text{SO}_4$ written Am_2SO_4 .

11. *Precipitation of globulins.* Half saturate 5^{cc} of No. 2 by adding an equal volume of saturated solution of Am_2SO_4 . Make the latter by dissolving in 5^{cc} of hot water as much of the salt as will dissolve, and whilst warm (40° C) add it to the warmed proteid solution. The white *pp* will not be a pronounced one owing to the small quantity of globulin present. Complete saturation with MgSO_4 has the same result.
12. *Precipitation of albumin.* Saturate completely with Am_2SO_4 . To ensure saturation warm the fluid to about 40° C. and add the salt until some of it remains undissolved at the bottom of the tube. As water takes up about 1 volume of the salt not more than 8^{cc} of the solution should be employed, in order that the process of saturation may not be too protracted. The cloud will be best seen above the undissolved salt.

Coagulation by heat.

13. Test both solutions with litmus paper and acidify both with dilute acetic acid (commercial acid of 33^{p.c.} to 16 volumes of water). Heat, it is not necessary to boil, and note the formation of a coagulum, the density of which will vary with the quantity of proteid present.

5 Determination of the temperature of coagulation.

Use a $\frac{1}{2}$ -pint tin mug as a water bath, with wires across its mouth to support the tubes. Fill nearly with water and introduce a thermometer.

Prepare 3 tubes with 10^{cc} of the solution in each tinted with litmus:

- (a) The original solution rendered neutral by cautious addition of dilute acetic acid.
- (b) Made acid with dilute acetic acid.
- (c) Made faintly alkaline by adding small quantities of carbonate of soda (4^{p.c.}) solution.

Label each on a piece of paper placed in the mouth of the tube. Raise the temperature of the fluids slowly, and as soon as 40° C. is reached watch carefully for any change in the transparency and note when opalescence occurs, then solidification, and later, at a higher temperature, coagulation, i.e., separation of flocculi. Repeat with solution No. 2, and observe that, owing to the presence of the globulin, coagulation commences at a lower temperature.

Globulins alone.

Myosin. Fresh meat is cleared of fat and tendons and is finely chopped up and washed in running water until free of colour. It is

then extracted with 10 p.c. chloride of sodium for 24 to 48 hours in a cool place, is strained through muslin, and a second time through a plug of tow placed at the bottom of a funnel.

A globulin may be obtained by the same method from pea meal, but the reactions are not so pronounced.

1. The solution of myosin is slightly opalescent.
2. Perform the reactions for proteids and note carefully any difference in the reactions where any occur.
3. Saturate 7 cc of the solution in a tube with $MgSO_4$, filter into another tube and test the filtrate for the presence of a coagulable proteid, by acidification and boiling, there will probably be none.
4. *Pour some of the solution by drops* into a tube nearly full of *water*. A cloud will form in the track of each. Explain how this occurs.

Albuminates or Derived albumins.

Alkali albumin. Form alkali albumin by adding drops of caustic alkali solution (NaOH or KOH) to 5 cm of pure egg white in a tube. The previously fluid albumin will soon turn into a clear jelly, adhering to the tube when inverted. Fill the tube with water and stir up the jelly with a glass rod until most of it is dissolved.

1. *Alkali albumin* is soluble in a weak alkali but is precipitated on neutralisation. Add litmus solution to a distinct tint and neutralise with dilute acetic acid. The fluid becomes turbid. On the further addition of acid the turbidity disappears. It reappears on neutralisation.
2. *Boil* some of the solution, it does not coagulate.
3. *Sulphur is liberated in the formation of alkali albumin.*
To 2 cm egg white add 3 volumes NaOH solution. Mix

thoroughly, warm for a few minutes, then heat to boiling. Add 3 drops acetate of lead solution, a black *pp* occurs of lead sulphide.

Acid albumin. Is less readily formed with strong acids. To some egg white solution (5 in 50) add slowly one-half a volume of acetic acid (B.P.), *agitate, then warm slowly to boiling.*

1. There is no *pp* on boiling.
2. *Neutralise some of the solution* (litmus) with a few drops of KOH diluted to one quarter with water, there is a *pp* of acid albumin. On further adding KOH the cloud disappears.
3. Boil some of the original solution briskly for a minute, add lead acetate solution, there is no black colour.

Albumoses.

The substances of interest in this class are physiologically derived from proteids by ferment action in the alimentary canal, and will be taken later with gastric and pancreatic digestion.

Compound Proteids.

This very important group contains:—

Hæmoglobin.	Proteid + Hæmatin.	Blood.
Gluco-proteid.	„ + Carbohydrate	(animal gum, Landwehr). Mucin of saliva.
Nuclein.	„ + Nucleic or Phosphoric Acid.	Constituent of nuclei.
Nucleo-proteid.	„ + Nuclein.	Chief constituents of cells. Mucin like subst. of bile.

These will be referred to later, as far as the scope of the work in class allows, under the respective substances in which they occur.

Tables for the rough separate recognition of proteids and carbohydrates in solutions.

I.—A solution of **proteids** and **carbohydrates**.

	Egg Albumin	Serum Albumin	Globulin	Acid Albumin	Alkali Albumin	Proteoses	Peptone
Xanthoproteic	+	+	+	+	+	+	+
Acetic acid and K_4FeCy_6	<i>pp.</i>	<i>pp.</i>	<i>pp.</i>	<i>pp.</i>	<i>pp.</i>	<i>pp.</i> *	—
Heat	Coag.	Coag.	Coag.	—	—	—	—

* Disappears on heating, returns on cooling.

II.—Coagulable proteids.

III.—Non-coagulable proteids.

	Egg A.	Ser. A.	Glob.
Excess H_2O ...	—	—	<i>pp.</i>
$MgSO_4$ to Sat ⁿ	—	—	<i>pp.</i>
Ether (in neutral reaction)	<i>pp.</i>	—	

	Acid	Alkali	Proteose	Pepton
Neutralisation ...	<i>pp.</i>	<i>pp.</i>	—	—
Biuret ...	Violet	Violet	Pink	Pink
HNO_3 ...	—	—	<i>pp.</i>	—

IV.—Carbohydrates.

	Starch	Dextrin	Glycogen	Dextrose	Maltose	Cane Sug.
Iodine ...	Blue	Red	Port	—	—	—
Basic acetate of lead		—	<i>pp.</i>	—	—	—
		Fehling's Sol.		Red ⁿ	Red ⁿ	—
		Barfoed's Reag ^t		Red ⁿ	—	—
			H_2SO_4 and boil ...			Dextrose

N.B.—To apply IV. in a mixture containing proteids acidulate with acetic acid, boil and filter. It is of no consequence if peptones remain in the solution. In performing the Biuret test employ one or two drops of $CuSO_4$ only to 3^{cm} of fluid.

SOME FOOD SUBSTANCES.

Milk. Contains water 87, solids 13, consisting of casein (ogen) 3, albumin 0.5, fat 3.6, sugar 5, salts 0.7. S.G. 1028 to 1034 which is raised by dilution with water.

1. Reaction—amphoteric.—Fresh milk reddens blue litmus and turns red litmus blue. Due to acid and alkaline phosphates. Test with litmus paper.
2. Boil 25°c milk in a beaker. It does not coagulate. A scum forms upon the surface which returns as often as it is removed. Due chiefly to caseinogen entangled in proteid drying on exposure to the air.
3. Add a few drops of dilute acetic acid to some milk in a tube, a floccular *pp* of *caseinogen and entangled fat* results.
4. Rennet (Extract of calf's stomach). Add a few drops to two-thirds of a tubeful of milk, mix, digest at 40° C. in the water-bath. It will curdle in five minutes. From this clot *Whey* exudes on standing.
5. To two-thirds of a tubeful of fresh milk add 3 or 4 drops of a saturated solution of ammonium oxalate; mix; add 5 drops of extract of rennet, digest at 40° C for at least half an hour. There will be no coagulum. Then add a few drops of a 2 p.c. solution of calcium chloride. The milk will rapidly coagulate.

6. Prove the fermentative nature of curdling by mixing the rennet with a little water and boiling it before adding it to the milk. The milk will not curdle because the ferment has been destroyed.
7. Proteids. Strained whey is provided for you. Acidulate some with acetic acid—no caseinogen—boil thoroughly there will be very little coagulum—lactalbumin—filter and test the filtrate for
8. Sugar in whey by means of Fehling solution.
9. Add ammonium oxalate solution to some whey, a light *pp* indicates *calcium salts*. The chief salts. Test also for P_2O_5 pg. 160.
10. Guaiacum test. To some fresh milk add a few drops of fresh tincture of guaiacum, agitate, add half a volume of peroxide of hydrogen, a blue colour due to oxygen liberated by proteids turning the resin blue.
11. Repeat 10 with boiled milk—the blue colour is not given—due to changes in the proteid.
12. Fat in milk. The milk globules have already been examined (Histology). To 2^{cm} milk add 2 or 3 vols. of ether, cork the tube, wrap it in a damp cloth or folds of blotting-paper to prevent heating by the hand, and shake thoroughly for 30 seconds—there will be no change. Add 1 or 2 drops of NaOH sol., shake again; the ether will now dissolve the fat and the milk will lose its opacity. Hand the tube to the laboratory attendant.

Estimation of cream. Whole milk is centrifuged for 5 minutes in a Watson-Laidlaw cream tester. The percentage is read off directly as solid cream in the graduated tubes of the instrument. There should be about 12 per cent. present.

Vogel's Lactoscope. Add milk from a burette by small quantities to 100 cc of water in a 200 cc flask until a sample 1 cm thick of the whole mixture held a short distance from the eye in a glass test cell just prevents you from seeing the outline of a candle flame placed 3 feet off. The percentage of cream is ascertained from the number of cc of milk used by consulting Vogel's table (Sanderson: Handbook Physiol. Laboratory, 1873, pg. 531).

7 **Flesh. Muscle.** Take one-quarter beakerful of lean minced beef and half fill the beaker with 10^{p.c.} solution NaCl. Extract in the water bath at 40° C. for 20 minutes with constant stirring. Strain through muslin.

1. Test the filtrate for proteids.

2. Test the reaction, is lactic acid present? Uffelmann, pg. 142.

3. Saturate some with MgSO₄, filter off the globulin and test the filtrate for albumin.

4. Free some of the extract from proteids by boiling and filtering, and test for phosphates, the most important salt, by adding half a volume of HNO₃ and a few drops of molybdate of ammonia—heat—a yellow *pp*—P₂O₅.

Coagulation of Myosinogen. (Halliburton: Essentials of Chem. Physiology, 1896.) An extract, which is provided for you, is obtained as follows:—The blood-vessels of a rabbit which has just been killed are washed out with normal saline through the aorta. The muscles are quickly removed, chopped up small and extracted with 5^{p.c.} solution MgSO₄ for 24 hours in a cool place.

5. Dilute some of the extract with 4 volumes of water, and keep at 40° C. in the water-bath. A clot of myosin will form.

6. To some of the extract add a few drops of 2^{p.c.} acetic acid (acetic acid B.P. 1, water 16) a stringy *pp* of myosinogen results.

Wheat Flour.

1. Make a thick paste of wheat flour, place it in a piece of muslin, knead in running water until all the starch is removed. Collect some of the washings in a beaker, and test for sugar and starch.
2. Examine the clot left on the muslin, an adhesive mass of gluten (Diabetic bread), test by the Xanthoproteic reaction.

Bread. Contains approximately proteids 7, carbohydrates 55, fats 1, salts 2^{p.c.}.

1. Macerate scrapings of crust in water and test the solution for sugar, starch, and dextrin.
2. Do the same with the crumb.

DIGESTION.

Saliva. See starch. Collect saliva as already directed, pg. 124.

1. To saliva add 2 volumes water, then a few drops of acetic acid. A white stringy *pp* of *mucin* falls.
2. To saliva add a drop of ferric chloride solution. A red colour results, which is discharged by HgCl_2 —*Potassium sulpho-cyanide*.

Gastric Digestion.

Arrange the following digestions at 40°C . in the water-bath, in tubes: examine 30 minutes afterwards:—

1. *Water* + a small flocculus of *Fibrin*.—No change.
2. A 0.2^{p.c.} solution HCl . + *Fibrin*.—The fibrin swells.
3. *Water* + a little *Pepsin* (Extract)¹ + *Fibrin*.—No effect.
4. *Dilute HCl* + *Pepsin* + *Fibrin*.—The fibrin is dissolved.

Whilst waiting, proceed with the following:—

Products of Gastric Digestion.

Fill a beaker one-third full of the fibrin which is provided for you and which has been swollen in 0.2^{p.c.} HCl , to it add another volume of dilute acid and raise the mixture and maintain it at 40°C ., then stir in 5^{cc} peptic extract (Benger's). In a few minutes the gelatinous mass will become fluid. Strain through filter paper to remove coarse impurities, and return it to the beaker and continue the digestion.

¹ Neutralised Liquour pepticus (Benger) or a glycerin extract.

1. Take a sample and *boil* it.—There should be no coagulable proteid.
2. *Neutralise* another portion carefully using litmus as an indicator.—There will be a *pp* of acid proteid.

Add some warmed dilute HCl to the digestion to fill the beaker, and test samples, as follows, from time to time.

As soon as test (2) gives markedly diminished results and the tests (3) and (4) are well marked, set two-thirds of a beakerful aside, *neutralise* and label it (A).

To the remainder add one volume warm dilute HCl, and continue the digestion.

3. HNO₃ a few drops.—A white *pp* which *disappears* on *heating* and *returns* on *cooling* (proto-proteose).
4. Two drops of acetic acid and a few of ferrocyanide of potassium solution.—A white *pp* which *disappears* with *heat* and *returns* on *cooling* (proto- and deutero-proteose).
5. Add one-quarter volume NaOH and one or two drops of CuSO₄ solution.—Biuret reaction. *Pink* indicates proteoses as well as pepton.

When test 5 is the only reaction given, then nothing but pepton is present. This stage will, however, not be reached during the time which is at the disposal of the class.

6. Saturate some of the fluid with Am₂SO₄ whilst boiling and first acidify by means of a little acetic acid, then neutralise with NaOH solution, boiling after each addition; filter and *test the filtrate* for pepton, by adding four volumes of NaOH solution and then a few drops of CuSO₄. Boiling in different reactions has the effect of precipitating the proteoses completely. The excess of alkali in the Biuret test is to set aside the effect of the Am₂SO₄ which would interfere with the reaction.

Proteoses. The following reactions, which may be regarded as the best marked class distinctions, are all that can be attempted here. Fluid (A) which has stood after neutralisation should be filtered through double paper, the filtrate will be free of acid proteid and nearly clear. It contains proteoses and pepton¹.

Primary proteoses (proto- and hetero-proteose)

1. Saturate a tubeful with NaCl crystals, a *pp* separates, consisting principally of primary proteoses—much of this *pp* is carried to the top with the froth—filter.

Secondary proteoses (deutero-proteose).

2. To the filtrate from (1) which is quite clear, add a few drops of acetic acid, a further *pp* will form, consisting mainly of deutero-proteose, but containing a little proto-proteose as well.

NOTE.—The primary proteoses are formed first and the secondary proteoses next. The relationship which these substances are supposed to bear to the parallel chains of cleavage products of the proteid molecule, known as the hemi- and anti-groups, may in brief be expressed as follows:—Proto-proteose is stated to be the first link in the hemi- and hetero-proteose the corresponding link in the anti-chain, whilst the next link in each is a deutero-proteose.

9 Recognition of free Hydrochloric and Lactic acids. Perform the following reactions with watery solutions of the acids, by adding them drop by drop to $\frac{1}{4}$ tubeful of the reagent:—

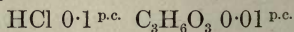

- | | | | |
|----------------------------|-----|------|--------------|
| 1. Congo red (Hösslin) | ... | Blue | — |
| 2. Carbol-iron (Uffelmann) | | — | Pale yellow. |

Carbol-iron test.—To 10 cc of a 4 p.c. solution of carbolic acid add 20 cc distilled water and 1 Liquor Ferri perchloridi B.P.

¹ What is the definition of a pepton?

Pancreatic Digestion.

The *Amylolytic* ferment action has already been studied under starch.

Proteolytic action.

Make an artificial digestive fluid by adding 2^{cc} Liqueur pancreaticus (Benger) to 100^{cc} of a 1^{p.c.} solution bi-carbonate of soda at 40° C. in a beaker. Add a few shreds of fibrin and observe that these gradually diminish in bulk without swelling (erosion). The whole process is much hastened by previously soaking the fibrin in the bi-carbonate of soda, but is slower than artificial gastric digestion.

Perform the same tests as in the case of gastric digestion, and note the absence of proto-proteoses. The digestion is to be pushed much further than in the former case. The fluid is to be filtered from coarse impurities when all the solid fibrin has disappeared, and if the changes languish diluted with bi-carbonate of soda solution. Note the persistent bitter taste of the solution—(Albumoses). After all traces of albumoses have disappeared, or before, withdraw any sediment which may form with a pipette and examine under the microscope for *leucin* small yellowish balls and *tyrosin* colourless acicular crystals.

Whilst the above is taking place:—

Take half a tubeful of milk, add an equal volume of 1^{p.c.} solution bi-carbonate of soda and 4 drops of pancreatic extract.—Digest.—Note the bitter taste that soon appears and which may be taken as an indication of the digestive change which the proteids of the milk are undergoing.

Steaptic action—fat splitting ferment. The demonstration of this action does not lend itself readily to class work.

BLOOD.

Composition of Blood (Approximate average, human).
Water 77^{p.c.}, solids 23^{p.c.}. Of the latter hæmoglobin 14
proteids 7·5, salts 1·5 (urea 0·02, glucose 0·12).

Colour. Arterial—scarlet; Venous—purple.

Reaction. Alkaline. Due to Na_2HPO_4 and sodium carbonate. Place a drop on red litmus paper moistened with normal saline, and after 15 seconds wash with the same. Observe the colour of the stain.

Specific gravity. 1035-1068. Estimate it by Roy's method (Lloyd-Jones). The following are required:—

- (a) A stock of standard solutions (SS) of glycerin and water of specific gravities varying from 1030 to 1080 by steps of 5 degrees.
- (b) Glass tubes drawn to capillary ends, of which the terminal 5^{mm} are bent at right angles.
- (c) A 3 drachm phial or an 8^{cc} tube.

Process:—Commencing with SS of a S.G. 1045 in the phial, fill the capillary tube for 2^{cm} with blood from your finger. Do not squeeze the finger in obtaining it. Plunge the capillary point into the fluid in the phial, holding the bent part horizontally, and expel a small drop. If the drop falls or rises, the S.G. of the SS

is less or greater than that of the blood. Change the SS accordingly, until the drop neither rises nor falls during the first moments after ejection.

The S.G. of blood varies. It is highest in the male sex and at birth; is lowest from the ages of 35 to 45 years. Falls with hunger, pregnancy, food and drink.

Proteids of Serum.

Blood serum. Contains approximately 7 p.c. proteids consisting of 4 parts serum-albumin and of 3 parts serum-globulin (para-globulin).

Sheep or ox blood is allowed to clot in the vessel into which it has been run from the animal in the slaughter house; on standing the clot contracts and squeezes out the serum. If any water be present in the vessel at the time the blood is run in the serum will be tinged with the colouring matter of the corpuscles.

Dilute 10^{cc} serum to 70^{cc} (= 1 p.c. proteid approximately) with water and repeat the reactions performed on egg albumin.

Difference between egg and serum albumin.

Serum albumin is more soluble in nitric acid. Egg is coagulated by ether in a neutral reaction, whilst serum is not.

Relative sensitiveness of some of the proteid reactions.

Dilute some of the above reputed 1 p.c. solution to 50^{cc} with normal saline = 0.1 p.c. solution (*a*); repeat this operation successively with 5^{cc} of (*a*) = 0.01 p.c. (*b*); 5^{cc} of (*b*) = 0.001 p.c. (*c*); 5^{cc} of (*c*) = 0.0001 p.c. (*d*); 5^{cc} of (*d*) = 0.00001 p.c. (*e*).

Take 5 tubes, number them from 1 to 5, place in each of them 2^{cm} of HNO₃. Do this by means of a pipette so as not to wet the sides of the tubes. Next, with the pipette pour two volumes of proteid solution (*e*) upon the acid in tube No. 5, being careful to avoid mechanical

mixture of the two fluids. In a similar manner add two volumes of (d) to tube No. 4, and so on with the remainder. Empty, rinse and blot off fluid from the pipette between each addition of proteid solution.

Note carefully the lapse of time by your watch between the moment of bringing the two fluids together and the appearance of a cloud at their plane of junction.

Test the solutions (c), (d), and (e) with tests 5 and 6 for proteids in the same way, being careful to use the same quantity of reagent in each case, and determine their relative sensitiveness. Construct a table of the results.

Demonstrate the presence of a globulin in serum.

To some serum which has been diluted with 2 volumes of water add an equal quantity of saturated solution of Am_2SO_4 , the globulins will be *ppd*. Filter and carefully scrape the residue off the filter with a knife, and mix it with some water, the *pp* will probably be re-dissolved, enough neutral salt being present to do so. If not, add a little 10^{p.c.} NaCl solution until it does.

Test the filtrate for serum albumin (a) by boiling, and (b) by saturating with Am_2SO_4 .

11 Proteids in blood plasma. *Coagulation experiments.*

Besides those already recognised in the serum, plasma contains fibrinogen.

(A) *Salted plasma.*

Obtained by mixing blood as it flows from the blood-vessels of an ox or sheep with half its volume of a saturated solution of NaSO_4 , and then centrifuging.

1. Dilute some with 10 volumes water in a tube and place it in the water-bath at 37° C. to hasten coagulation. In about twenty minutes the fluid will turn into a perfect but thin jelly. Note the quivering of the jelly when the vessel is slightly shaken. Let the clot rest until the next day, when it will be found to have shrunk considerably.
2. Heat some undiluted neutralised plasma slowly in the water-bath, and determine the temperature at which coagulation first appears. Fibrinogen coagulates at about 56° C.

(B) *Oxalated plasma.* (*Decalcified plasma.*)

To blood as it flows from the blood-vessels of an animal one quarter of its volume of a 1 p.c. solution of potassium oxalate in normal saline is added (Arthus and Pagès). The blood is then centrifuged.

To 8 cm of this plasma add 5 drops of a 2 p.c. solution of *calcium chloride*. Place in the water-bath at 37° C. Coagulation will take place.

Sugar in the blood. Boil some fresh serum which has been diluted with 2 volumes of water, and slightly acidulated with dilute acetic acid. Coagulate the proteids completely, which will take five minutes; filter off as much perfectly clear fluid as you can, and test a quarter tubeful of the filtrate by boiling it with about 8 drops of Fehling. If the reduction is not very well marked let the tube stand, and at the end of twenty minutes a distinct *pp* of sub-oxide will collect at the bottom, showing the presence of a reducing sugar.

12 Enumeration of the Red Blood Corpuscles.

Thoma-Zeiss Hæmacytometer.—This consists of:—

1. Dilution pipette, or mixer, having a bulb containing a glass bead for mixing. The stem is graduated from 0.1 to 1, and to 101 above the bulb.
2. Counting chamber, a cell with an outer rim, and a central platform, the latter ruled in squares; each square has a side of $\frac{1}{20}$ mm, and hence an area of $\frac{1}{400}$ mm² square. The film of fluid between the glasses is 0.1 mm thick when the chamber is covered, and consequently the portion over each square is $\frac{1}{4000}$ of a cubic millimetre. Groups of 16 squares are separated by additional lines.

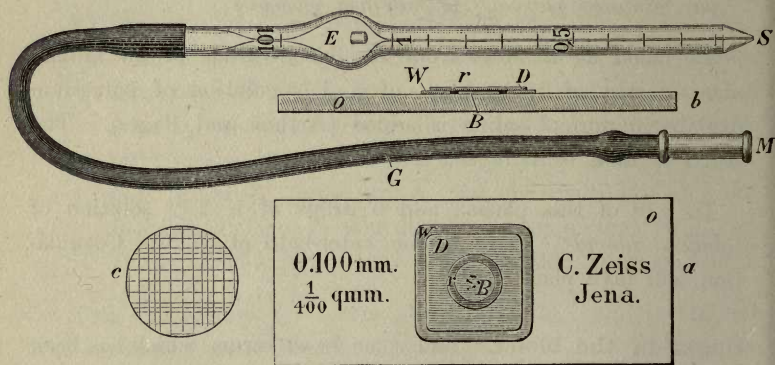

FIG. 15. Thoma-Zeiss Hæmacytometer. *a* and *b* the counting chamber, in which *W* is the outer rim upon which the cover *D* rests. *B* central platform, and *r* the circular trench which separates it from *D*. *c* divisions on *B* ($\times 30$). *S M* mixing pipette for red blood cells.

Process :—

1. Puncture the finger freely.
2. Draw blood up in the mixer to 0.5 or 1 on the stem of the pipette. Wipe the point dry.
3. Draw in 3% salt solution to the mark 101 above the bulb, and mix the fluids by shaking.

4. Expel the fluid that fills the stem and wipe the point.
5. Blow a small drop of the diluted blood on to the central platform of the counting chamber, and apply the cover.
On pressing the latter down
6. Newton's rings should be seen between the rim of the cell and the cover.
7. Let the preparation rest for two minutes, the blood cells settle on the floor of the chamber.
8. Count the cells in at least 16 squares. Cells astride the lines are to be counted on two sides of each square only.

Calculation :—

$$\frac{\text{Number of cells (200 ?)} \times 4000 \times 100}{\text{Number of squares (16 ?)}} = \text{R.B.C. in 1 cubic millimetre of blood.}$$

Oliver's Hæmacytometer (used in the darkened room).

(1) A graduated flattened tube, (2) an automatic blood measurer to which (3) a mixing pipette is adjustable for washing it out, (4) a candle (Christmas candle), (5) a bottle of Hayem's solution (see pg. 61).

Process :—(1) Dry the measurer by drawing darning thread through it with a needle. (2) Prick your finger and fill the measurer by touching the drop of blood. (3) Attach the mixer, filled with Hayem's fluid, to the measurer by means of the rubber tube and wash the blood thoroughly into the graduated tube. (4) Mix thoroughly by inverting three times. In withdrawing the thumb draw it against the edge to avoid loss of fluid. (5) Place the lighted candle ten feet off. (6) Grasp the tube by the flat sides framing it between the thumb and fore-finger, hold it close to the eye, and look through its long diameter at the flame. (7) Add small quantities of Hayem's fluid, repeating (4) until the eye can distinguish the first appearance of a transverse line of light. (8) Read the graduation touched by the upper edge of the column of mixture and calculate as follows :—100 degrees correspond to the assumed normal of 5,000,000 cells per cubic millimetre. Each degree above or below this indicates 50,000 cells above or below the normal.

The W.B.C. in a state of health do not affect the readings.

This instrument has been standardised by means of the Thoma-Zeiss instrument.

Enumeration of White Blood Cells.

Use the Thoma-Zeiss instrument with a *special pipette*.

Dilute the blood to 10 or 5 ^{p.c.} in the same manner as for the red cells but with 0.3 ^{p.c.} solution glacial acetic acid, and proceed as before. 1 ^{p.c.} dilution will answer if the white cells are very numerous, provided many fields of 16 squares are counted. 0.6 ^{p.c.} NaCl solution coloured with gentian violet may then be used as a diluent.

Enumeration of Blood Platelets. Use the same instrument and dilute the blood with Bizzozzero's fluid (methyl violet 1 in 5,000 of normal saline) to 0.5 ^{p.c.}

The operation must be carried out quickly, as the platelets tend to adhere to the glass surfaces and to each other. They must be carefully sought for. Film preparations *show* them best.

Estimation of Hæmoglobin. (Blood contains normally from 13 to 14 ^{p.c.})

Gower's Instrument is composed of:—

1. Standard colour tube of the tint of a 1 ^{p.c.} solution of normal blood.
2. Graduated tube for diluting blood.
3. Block for supporting these side by side.
4. A 20 cubic millimetre pipette.

Process :—

Place a drop of distilled water in (2).

Fill (4) up to the mark with blood, wipe the point, and expel the contents into (2).

Add distilled water to this drop by drop, with agitation, until a tint exactly matching that of the standard is obtained.

According to the dilution required so is the quantity of HbO_2 . If the desired tint is obtained when the fluid in the

graduated tube stands at 90, then there is present 90^{p.c.} of the normal quantity in the blood, e.g., of 14^{p.c.}

Should the fluid reach the graduation 120 then there is more by 20^{p.c.} than the normal amount.

Oliver's Hæmoglobinometer. (To be used in a darkened room.)

(1) Automatic blood measurer, (2) mixing pipette, (3) the blood cell and cover glass, the latter of low grade blue glass, (4) a set of standard colour grades, (5) riders, (6) camera tube, (7) light (Christmas candle), (8) bottle of antiseptic fluid, lancet, needle and thread.

Process:—(1) Dry the blood measurer by drawing darning thread through it with a needle. (2) Apply the point to the drop of blood exuding from a pricked finger; it will fill itself. There must be no break in the column of blood. Dry the ends with a finger tip. (3) Fill the mixing pipette with distilled water, and fit it on the measurer. (4) Expel the blood into the blood cell by pressing water through drop by drop. Stir with the handle of the measurer and use it as a guide for adding the last drops required to fill the cell exactly level with the edge. Do not fill to a convexity. (5) Apply the cover, a small bubble should form, then the cell has not been overfilled. (6) Place the blood cell by the side of the standard colour grades under the camera tube, so that they are seen through separate apertures at the bottom on looking down the tube. (7) Place the lighted candle at about 10^{cm} equidistantly from the blood cell and the standard. (8) Make the observation by looking through the tube for not more than 10 seconds at a time, and in order to resensitise the retina, if there is any fatigue, close the upper opening of the tube with your finger, and glance for a few moments through the green glass at the light before making another observation. Match the blood tint exactly with one of the blood standards. Physiological riders are supplied of nine degrees between standard grades. If the blood tint lies between two, superpose riders on the lighter tint until a match is obtained. To balance the glass of the rider a colourless slip is placed over the cover of the blood cell. A description of this instrument is given because it rests upon (1) the recognition of the irregular variation of the blood tint on dilution, and (2) upon the employment of the delicate colour discrimination method introduced by Mr. Lovibond, of the Tintometer Company, which admits of many applications. A power of acutely discriminating differences of tint is required in the observer.

13 Spectroscopical examination of the blood. Use a small direct vision spectroscope suitably supported. Keeping the red end to the left the spectrum is to be sharply

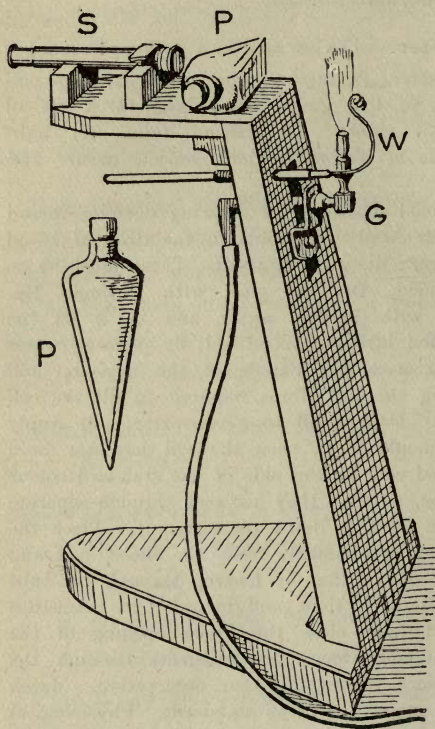

FIG. 16. Direct vision spectroscope **S** on a wooden stand. **P** wedge-shaped bottle for blood solutions. **G** gas. **W** platinum wire with a borax bead for the sodium line.

focussed by adjusting the draw-tube. The slit is to be reduced by means of the milled head at the other end of the instrument, short of seeing the horizontal lines caused by the irregularities of the jaws of the slit. Burn biborate of soda in the flame to get the Na line.

Draw a chart of the spectrum by marking the position of the sodium line and the limits of the colours by vertical lines, continuing them on the paper to serve as guides in plotting below each other the following absorption spectra. Examine the blood solutions in wedged-shaped bottles¹.

Solution of blood. Make a 2^{p.c.} solution of ox or sheep's blood in water. Or you may add one or two drops of your

¹Made for the author by the York Glass Company.

own blood to a wedgeful of water. Note in each case the influence of the quantity of the pigment upon the absorption bands by moving the wedge bottle across the slit of the instrument. This has the same effect as dilution.

SPECTRA OF HÆMOGLOBIN COMBINED WITH GASES OR ALONE.

1. **Oxyhæmoglobin**— HbO_2 . Determine the relationship of the two bands between D and E to the Na line and to the colours. These are respectively known as the α and β bands. Compare with (3) and (8).

NOTE :—Examine the line of junction of the closed fingers before a strong light, the single band of a thick solution of HbO_2 will be seen.

2. **Reduced or Gas-free Hæmoglobin**—Hb. Add a few drops of $(\text{NH}_4)_2\text{S}$ or of Stokes' fluid.¹ The bands of HbO_2 will gradually fuse into each other. This single band is less dark than the other two. Try and restore HbO_2 by shaking with air.

3. **Carbon-monoxide Hæmoglobin**— HbCO . Coal gas (4^{p.c.} CO) is passed for 20 minutes through blood solution. Note its cherry-red colour. The two bands closely resemble those of HbO_2 . Observe the relationship of the D band to that line. Add $(\text{NH}_4)_2\text{S}$ there is no result. This compound resists putrefaction for a long time.

4. **Neutral Met-Hæmoglobin**—Met-Hb. Add 2 or 3 drops of a 10^{p.c.} solution of ferricyanide of potassium to a bottleful of solution HbO_2 —mix. The colour turns of a brownish tint. A characteristic band appears in the red and another dim band can just be recognised to the green side of D.

¹ Ferrous sulphate 2g, tartaric acid 3g, mix and preserve dry for use. When required add 100 cc water, and add ammonia to slight alkalinity.

5. **Alkaline Met-Hæmoglobin.**—To (4) add 2 or 3 drops of strong ammonia. The colour turns ruby red. A band on the red side of and cut by D and another in the green.

A blood-stained rag is given to you. Examine by cutting out a small piece of the stain 0.5 sq. cm and steeping it in the least quantity of normal saline on a slide. Search for (1) red blood cells, (2) absorption bands (microspectroscope if the quantity is very small), (3) hæmin crystals.

DECOMPOSITION SPECTRA OF HÆMOGLOBIN.

6. **Acid Hæmatin.** To a bottleful of blood solution add ten drops of acetic acid. Slight warming hastens the change. The heat of the flame near the bottle on the spectroscopy stand will do this. Note the alteration in the colour—brown tint. *One band* well in the red is characteristic with some obscuration of the *green*.
7. **Alkaline Hæmatin.** To a bottleful of blood solution add ten drops of a 10^{p.c.} solution NaOH. Warm in a tube to hasten the change. *One broad band* to the red side of and cut by the D line. Hæmatin in ethereal solution gives a four-band spectrum.
8. **Reduced Hæmatin.** (Stokes' reduced hæmatin, hæmo-chromogen.) Treat (6) with a few drops of $(\text{NH}_4)_2\text{S}$. It changes to reduced hæmatin. *Two bands in the green*—the band nearer D is the darker of the two and persists longest with dilution.
9. **Hæmatoporphyrin** in acid solution. Add four drops of undiluted defibrinated blood to 3 cm strong H_2SO_4 in a tube, agitate. The solution must remain clear, and present a deep cherry-red colour (iron-free hæmatin). *Two bands*—a thin one to the red side of and touching D, and a broader one on the other side of and shading off towards D. The latter persists longest with dilution.

BILE.

Liver bile 2^{p.c.}, bladder bile 12^{p.c.} solids. The difference is due to concentration in the gall bladder and ducts, where also mucinous substances are added.

Use bile from the gall bladder of the ox, sheep, or pig.

1. Note its ropiness or viscosity. Due to *mucin* and *neucleo-albumin*. Add a few drops of dilute acetic acid a stringy *pp* falls. (A mixture of mucin and neucleo-albumin.)

2. *Proteids*. Dilute bile with 3 volumes of water, boil—no result.

3. *Bile salts*. Glyco-cholate and tauro-cholate of soda and salts of fellic acid.

a. Pettenkofer's reaction. To some bile add two-thirds volume of H_2SO_4 so slowly that the temperature does not rise above 60° C., then add 3 to 5 drops of cane sugar syrup (1 in 5), agitate, a *red* colour passing into *violet* results. The acid simultaneously produces *furfurol* from the cane sugar and liberates the *cholic acid*, which, reacting upon each other, yield the colour. The violet tint must be present.

This reaction is not specific in the urine as other substances give it also. (Udranszky mentions amongst others proteids, cholesterin, phenol, turpentine, salicylic acid, pyrogallol, and morphin.)

b. Strasburger's modification of the above test. Mix the bile-containing fluid with syrup, dip pieces of blotting paper into it. Dry, then touch with H_2SO_4 . After fifteen

seconds the stain appears violet by transmitted light. The paper may be placed between two glass slips and examined spectroscopically. *Two faint bands* to the blue side of D; one close to D, the other near the blue.

c. *Surface tension test* (Hay). Sprinkle a little flowers of sulphur on the surface of the fluid, it will sink. Make a control test with water and compare its behaviour with water to which a little bile has been added.

4. *Pigments*. Bili-rubin and bili-verdin are changed by oxidation.

Gmelin's reaction. On mixing the fluid with HNO_3 containing nitrous acid—let two pools of the fluids flow together on a plate—a play of colours occurs passing through *green*, blue, violet, red to fawn.

If the reaction be performed in a tube the colours will be produced in successive layers above each other.

5. *Cholesterin*:—Obtained from gall stones. Dissolve a small pinch of powdered gall stone in 3^{cm} of equal parts ether and alcohol, pass through a dry filter. Place 2 drops on a glass slide, cover, and let it evaporate slowly. Irregular cholesterin crystals will separate out. When regularly formed the crystals are rhombic plates with a corner broken out.

When dry flow under the cover a mixture of H_2SO_4 with a quarter volume of water, then a small quantity of iodide of potassium solution. (Salkowski's Practicum.) The cholesterin crystals colour brown, violet, or even blue, and are partially dissolved.

HEALTHY URINE.

Contains roughly 4^{p.c.} of solids, 2 parts of which are urae and 1 part NaCl.

Quantity in 24 hours about 1,500^{cc} or 52½ ounces.

Colour. Pale straw to a deeper tint. Three pigments are usually recognised. (1) *Urobilin*, (2) *Indican* = indoxyl sulphate of potassium, and (3) *Uroerythrin*. The first may be regarded as the normal pigment derived from the blood. The second a form of indigo derived from the alimentary canal, and the third as only occasionally present in recognisable quantity. The latter tinges the *pp* of urates in feverish conditions of a rose or brick red colour. A chromogen of unknown nature is also said to be present.

Test for Indican. To 7^{cm} urine add 5 drops of HCl, mix, then add nearly an equal volume of HNO₃. The colour will darken above the last acid to a red-brown—indigo red? A tendency to violet indicates indigo blue.

Odour.—Urinous.

Reaction.—Usually faintly acid. Due mainly to acid sodium phosphate. May become alkaline during the period of digestion, due to alkaline sodium phosphate from food. This alkalinity is transient. The acidity may be quantitatively stated in terms of a normal sodium carbonate solution if thought desirable. After urine has been

passed, it will change in reaction. According to temperature and circumstances, often in 24 hours it undergoes the *alkaline fermentation* by the micrococcus urea, which breaks up urea, yielding carbonate of ammonia in the solution. This change may occur in the bladder when a dirty catheter is employed to draw off urine. Such urine becomes turbid, smells of ammonia, a surface scum forms, and a heavy white *pp* of phosphates of Ca and Mg deposits.

Specific Gravity. 1020 average. Taken by means of a urinometer. This is a small hydrometer graduated for the purpose from 0 to 50, the last figures of the S.G. expressed in four figures.

Inorganic Constituents.

Water. Varies according to activity of skin; the S.G. indicates its proportion to total solids. A rough approximate estimation of the total solids for urines of ordinary densities can be made by the Christison-Tyson formula. The quantity of solids per 1,000 parts urine is obtained by multiplying the last two figures of the S.G. expressed in four figures of urine of 24 hours by 2.33. Not applicable to urines which contain sugar or albumin.

Chlorides. Chiefly of Na, are soluble, *do not deposit*. In 24 hours, 10—15^g. (Urea to chlorides, 2 : 1.)

Test.—Take one-quarter tube of urine; add 2 drops HNO₃ and half volume of AgNO₃ 4^{p.c.} solution = white *pp*; shake thoroughly, and let stand. Deposit normally about one-quarter volume of urine; the HNO₃ keeps phosphates in solution.

Increased by diet; diminished in fevers. Not clinically important.

Sulphates. In 24 hours, 1·5 to 3^g.

There are two classes (in proportion 10 : 1)—

- (a) Ordinary sulphates of K and Na derived from proteids of food.
- (b) Ethereal sulphates. The potassium sulphates of phenol, indoxyl, skatoxyl, derived from putrefactive processes in the alimentary canal.

Recognition :—

Class *A* gives a *pp* with barium chloride.

„ *B* „ „ „ „ „ „ after boiling with a mineral acid.

Phosphates. In 24 hours, 3·5^g P₂O₅.

Three kinds of salts :— Basic (or normal), M₃PO₄; monophosphates (neutral), M₂HPO₄; diphosphates (acid), MH₂PO₄.

Clinically they are of importance from two aspects :—

1. Reaction of urine. Acidity largely due to NaH₂PO₄, and alkalinity to Na₃PO₄.
2. *Solubility*. Affects the production of sediments and calculi.

(a) <i>Soluble phosphates</i> .—Na, K, NH ₃ do not deposit	}	in prop.
(b) <i>Insoluble phosphates</i> .—Lime and magnesia	}	3 : 1

The *earthy phosphates* (b) are *pp* in an *alkaline medium*, hence they appear as sediments in alkaline urine. In ammoniacal urine they form crystalline deposits as follows :—

1. Ammonio magnesian or triple phosphates. (a) Knife rest or coffin lid; (b) feathery, if quickly formed.
2. Stellar calcium phosphates and amorphous deposit.

On heating urine a turbidity or deposit of calcium phosphates may form, due to the transformation of the acid into the basic variety.

Recognition :—

1. Turbid urine clears on adding HNO_3 and heating = phosphates.
2. Two drops acetic acid and drops of uranium acetate—
 $pp = \text{P}_2\text{O}_5$ reaction.
3. Urine + half volume HNO_3 and not less than 2 volumes of molybdate of ammonia = yellow $pp = \text{P}_2\text{O}_5$ reaction.
4. Pp on adding NH_3 (or caustic alkali) = phosphates (earthy).

16 Volumetric estimation of P_2O_5 in Urine.

- (a) Standard solution uranium nitrate 35.5^g in 1 litre of distilled water. $1^{cc} = .005^g \text{P}_2\text{O}_5$.
- (b) Acid solution of sodium acetate. To 100_g sodium acetate add 100^{cc} acetic acid $33^{p.c.}$ and make up to 1 litre with water. To liberate all the P_2O_5 and to combine with the small quantity of free HNO_3 evolved which would dissolve part of the pp (Neubauer).
- (c) Solution of potassium ferrocyanide as *indicator*. It yields a brown colour with the uranium acetate.

Process :—

1. To 50^{cc} of the urine add 5^{cc} of (b) and maintain at 100°C .
2. In a burette place (a) and run it into the urine slowly, and test a drop of the urine from time to time with a drop of the indicator on a white plate.
3. Read off the number of cubic centimetres of the SS which used and calculate the amount of P_2O_5 as follows :—

$$\frac{\text{CC of SS used} \times 0.005 \times \text{CC of Urine in 24 hours}}{50} = \frac{\text{P}_2\text{O}_5 \text{ in 24 hours}}{\text{grammes.}}$$

Organic Constituents.

17

Urea average percentage 2^{p.c.} (Blood 0.02^{p.c.}) Quantity in 24 hours about 30^g depending on the flesh in the food. Occurs in animal fluids, not in muscle (creatin).

Properties :—

1. Crystallised slowly, forms prisms ; quickly, long needles.
2. It is freely soluble in water and absolute alcohol, but insoluble in ether and benzene.
3. On heating dry to 130° C. it melts, giving off NH₃ with the formation of biuret as follows:—

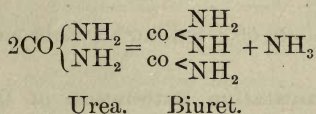

$3\text{CO}(\text{NH}_2)_2 = \text{C}_3\text{H}_3\text{N}_3\text{O}_3$ (cyanuric acid) + 3 NH₃. Cyanuric acid solidifies in the tube, and yields on further heating cyanic acid which volatilises, no residue being left if the urea is pure.

4. It combines with mineral acids, metallic oxides, and salts to form compounds in which the molecule of urea is united to one or more of the reagents. These form *pps.*

Recognition of the solid substance. Use commercial urea in crystals.

1. Place some crystals in a dry tube and heat, they melt (130° C.) with the odour of NH₃. Cool, add a few drops of water and apply the biuret reaction.
2. Dissolve a few crystals in a drop of water; place portions on glass slips. Add to one HNO₃ and to the other a saturated solution of oxalic acid. Each yields a crystalline mass with characteristic crystals of nitrate and oxalate of urea respectively. Examine the crystals.

3. *Schiff's test.* Place a crystal of urea in a porcelain capsule, pour upon it a drop of concentrated furfurool solution in water and add a drop of HCl, a play of colours changing through yellow, green, *blue* to *violet*, and in a few minutes to a *purple-violet*. The change is somewhat slow, the purple colour being the best marked. Old furfurool solutions colour red on the addition of HCl.

To a solution of the crystals apply the following tests:—

1. Add acetic acid and a few drops of a solution of mercuric nitrate—a white *pp*—(the basis of Liebig's volumetric method).
2. Add a solution of sodium hypobromite—effervescence occurs.

Quantitative Estimation of Urea.

Knop-Hüfner's process (or some modification as that now given).—Depends upon the decomposition of urea by a hypobromite or hypo-chlorite. Reaction:—

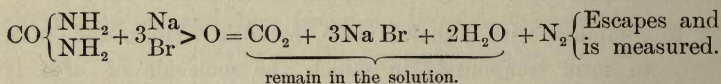

Theoretically 1^g urea yields 0.46666^g nitrogen. The volume of this at 0° C. and 760^{mm} Hg = 372.7^{cc}. Practically 354^{cc} are obtained at the ordinary temperature (18°C.) and pressure. If in a preliminary trial more than 2^{v.c.} is found to be present, the urine should be diluted.

Process. Do this first with a 2^{v.c.} solution of urea in water, then with urine.

1. Preparation of sodium hypobromite solution (Knop). Dissolve 100^g NaOH in 250^{cc} distilled water; when cool, add 25^{cc} of bromide (in the open air or a draught closet).

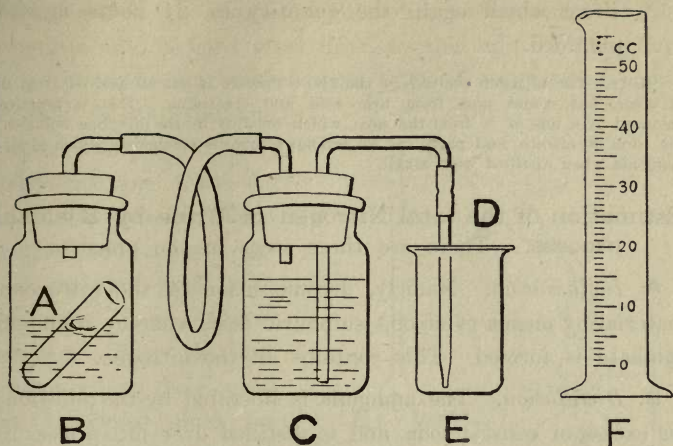

FIG. 17. Simple Urea Apparatus.

2. Apparatus¹ :—

Fill tube A up to the mark (5^{cc}) with urine (or urea solution), and place it in B. Into B place 25^{cc} hypobromite solution, push the stoppers firmly into B and C; the tube D will fill and water should drop into E. When this flow ceases empty E, replace it so that the point of D is near the bottom of E. Now tilt B so that urine and reagent mix thoroughly; the nitrogen froths out and expels an equal quantity of water from C. Allow B to cool four minutes, then measure H₂O in E with F = cc of nitrogen given off. Then since 1^g urea yields 354^{cc} nitrogen, the quantity per cent. is found thus :—

$$\frac{20 \times \text{cc N obtained from } 5^{\text{cc}} \text{ urine.}}{354} = \text{Urea per cent.}$$

¹The number of ureameters which have been devised is large. The majority have their gas vessels graduated in percentages of urea. The above apparatus, which can be easily constructed by anyone, is sufficiently accurate when the nature of the process is taken into account.

From which again the quantity in 24 hours is easily obtained.

NOTE.—The nitrogen evolved in the above process is not all derived from urea in urine, but comes also from uric acid and creatinine. This is practically balanced by a loss of N from the urea, which remains in the alkaline solution in the form of nitrate, and partly as an unknown organic compound which gives off ammonia when distilled with alkali.

Estimation of the total Nitrogen in Urine by Kjeldahl's process. There are three steps in the process:—

A. *Incineration.* Namely, decomposition of the nitrogenous material by means of strong sulphuric acid, whereby ammonium sulphate is formed. This contains all the nitrogen.

B. *Distillation.* The ammonia is liberated by the addition of an excess of caustic soda, and is distilled over into a measured quantity of standard acid, a part of which it will neutralise.

C. *Titration.* The unneutralised portion is measured with standard alkali, and thereby the quantity which has been neutralised by the ammonia becomes known. From this the quantity of nitrogen is readily calculated.

Reagents required:—

1. Sulphuric acid, strong pure, 15 g.
2. Potassium sulphate, dry, 10 g.
3. Sulphate of copper, dry, 0.5 g.
4. Caustic soda solution, 25^{p.c.}, boiled with zinc shavings to free it from nitrates.
5. $\frac{N}{10}$ NaOH solution. Dilute stock $\frac{N}{1}$ solution with 9 volumes of distilled water.
6. $\frac{N}{10}$ H₂SO₄. Dilute stock $\frac{N}{1}$ solution with 9 volumes of distilled water.
7. Methyl orange. 1 : 1000 solution.
8. Powdered talc. Half a teaspoonful.

Process:—A. *Incineration.* 10^{cc} of urine are measured from a burette into a hard glass flask, to this add 15^{cc} sulphuric acid, 10^g potassium sulphate and 0.5^g of sulphate of copper crystals. K₂SO₄ raises the boiling point, and CuSO₄ helps oxidation. Close the mouth with a loose balloon stopper, and support the flask on wire gauze with the neck in an inclined position. Raise the heat gradually and boil until the blackened fluid becomes quite clear (green from the CuSO₄). This step must be carried out in a draught chamber on account of the sulphurous fumes which are given off. When quite cool add slowly 50^{cc} distilled water. As this is attended by much heating cool again. Add a few drops of methyl orange and half a teaspoonful of talc. Next add caustic soda to liberate the ammonia, pouring it along the side of the vessel until the reaction is nearly alkaline, cool, render alkaline by a further addition of NaOH, and connect at once with the distilling apparatus, which has meanwhile been prepared.

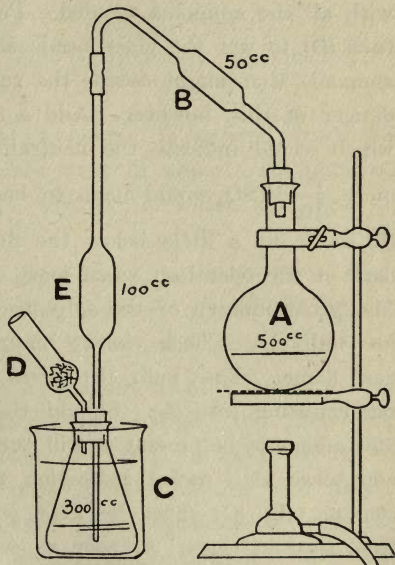

FIG. 18. Apparatus for Kjeldahl's Process.¹

A Hard Jena or Bohemian glass. B Bulb to prevent spurting over of alkali during distillation. C Erlenmeyer flask surrounded by a cooling vessel containing water. D Tube containing glass beads or broken glass. E To arrest regurgitation. E and B are made out of pipettes.

liberate the ammonia, pouring it along the side of the vessel until the reaction is nearly alkaline, cool, render alkaline by a further addition of NaOH, and connect at once with the distilling apparatus, which has meanwhile been prepared.

¹ I am indebted to my colleague Prof. Proctor's work, "Leather Industries," for the method of distillation without a condenser, and to his assistant, Dr. Guthrie, for the more recent modifications in the apparatus.

B. Distillation. Into the Erlenmeyer receiving flask (C) measure from a burette 80 cc of $\frac{N}{10}$ (decinormal) sulphuric acid. This is in excess of what will be required to combine with all the ammonia yielded. Pour this in through the side tube (D) to wet the glass beads as a precaution to catch any ammonia that might escape the sulphuric acid. There is little danger of this, however. Add a few drops of methyl orange, which would indicate the neutralisation of all the acid when more $\frac{N}{10}$ H_2SO_4 would have to be added. The delivery tube (E) must dip a little below the fluid in (C) during the first part of the operation, when most of the ammonia comes over. The great affinity of the sulphuric acid for ammonia renders loss unlikely. Check violent bumping in (A) by reducing the gas flame. The bulb (E) saves the contents of (C) from regurgitating into (A). Should the fluid regurgitate into (E) and ammonia be present, it will turn the methyl orange yellow and serve as a useful indication that there is still ammonia coming off. (C) must be kept cool by changing the water from time to time. As soon as (A) begins to bump vigorously the ammonia may be assumed to have been all expelled (twenty minutes).

The flask (A) should now be detached.

(C) *Titration.* Cool (C), wash out (D) into (C) with 10 cc of distilled water, and then titrate the uncombined acid in the latter with $\frac{N}{10}$ NaOH. The $\frac{N}{10}$ NaOH is run in from a burette until the methyl orange turns yellow, the last quantity required being added drop by drop.

Calculation:—

$$1 \text{ cc } \frac{N}{10} \text{ NaOH} = 1 \text{ cc } \frac{N}{10} \text{ H}_2\text{SO}_4 = 0.0017^g \text{ NH}_3 = 0.0014^g \text{ N.}$$

From the quantity of $\frac{N}{10}$ H_2SO_4 originally measured into the receiver (C) subtract the $cc \frac{N}{10}$ NaOH used to neutralise the uncombined acid, and multiply the difference by 0.0014, which will give the grammes of nitrogen contained in 10 cc of urine. The percentage will be obtained by multiplying by 10.

Creatinin. 1^g or over in 24 hours. Is derived from the fleshy part of food. It comes next in importance quantitatively after urea. Is freely soluble in water and has an alkaline reaction. 19

1. It *reduces copper oxide*, hence may be taken for small quantities of sugar. The reduced copper collects at the bottom of the tube. Try normal urine.
2. *Weyl's reaction.* Add to a quarter tube of urine a very dilute solution of sodium nitroprusside, and then drop by drop a dilute solution of NaOH, a ruby red colour appears which lasts only a few minutes and passes into a clear straw colour. Add some acetic acid, the ruby colour rapidly decolourises. Compare with the reaction for acetone.

Uric Acid. 0.5 a little more in 24 hours.

Properties:—

1. Its solubility is very low—1 to 14,000 in cold, and 1 to 1,800 in boiling water. Most important from a clinical point of view, as consequently it readily appears as a sediment in the urine.
2. It crystallises ordinarily in urine in the form of whetstone-shaped crystals, coloured brownish-red by entangled urinary pigment (uroerythrin). When crystallised pure it forms rhombic prisms.

3. Dissolves in KOH, potassium urate being formed, it is re-*pp* by the addition of 5^{p.c.} HCl as uric acid. This addition of HCl to urine causes it to separate out in the form (2).

*Tests*¹:—

1. *Murexide* test. To a few drops of urine add a little HNO₃ evaporate on a porcelain dish without charring, cool and add NH₃—a purple colour or with KHO a violet—murexide.
2. *Schiff's* test. Dissolve some uric acid crystals¹ provided for you in sodium carbonate solution, drop on a filter paper moistened with AgNO₃ a black stain of reduced silver results.
3. Solutions of uric acid or acid urates *reduce* alkaline copper solutions. Use potassium urate obtained by dissolving serpent's excrement in KOH. Part of the Cu₂O formed unites with any undecomposed uric acid to an insoluble *pp* of cuprous urate.
4. To some urine add 5^{p.c.} HCl, let it stand for 24 hours. Brown *whetstone-shaped* crystals separate out as a surface scum and as a deposit. Try the tests on these.

Urates. Uric acid is a dibasic acid (H₂U) and forms three kinds of salts.

- (a) Normal urates (M₂U). These do not occur in the body and are laboratory products only.
- (b) Acid or Bi-Urates (MHU) they occur as gouty concretions.
- (c) Quadriurates $\left\{ \begin{array}{l} \text{MHU} \\ \text{H}_2\text{U} \end{array} \right\}$ These according to Bence Jones and Sir W. Roberts are the physiological salts of uric acid.

They tend to break up in the presence of water into acid urates and a molecule of additional uric acid. This

¹ Serpent's excrement which consists of nearly pure urate of ammonia may be used with advantage for performing these tests.

is ordinarily hindered in urine by the presence of phosphates, chlorides and pigments. The conditions which accelerate the change, the converse retarding, are (1) acidity, (2) poverty of mineral salts, (3) little pigment, (4) a high percentage of uric acid.

Demonstration of Quadriurates. Place a slight scraping of serpent's excrement upon a glass slip, press it into a fine powder with the blade of a knife and shake off all that does not adhere to the glass. Cover dry and examine under a power of 300 diams., observe the small globular masses of quadriurate of ammonia which alone are present. Let water flow between the glasses and recognise the almost instantaneous appearance of a crop of short square-ended needles of uric acid, which grow into fine parallel sided colourless crystals or thin fusiform plates. Ammonium urate remains as granules.

Acid Urates are far more soluble (at least 10 times) than uric acid; nevertheless, they are the commonest *pps* in urine.

Their deposition is favoured by (1) an acid reaction, (2) low temperature, (3) little water, (4) ammonium urate occurs in alkaline urine.

A *pp* of urates in urine is coloured fawn to brick dust red, depending upon the quantity of pigment involved (uroerythrin).

These *pps* dissolve on heating, and so differ from phosphates which require an acid.

Oxalate of Lime. 1^g in 24 hours. Is kept in solution in the urine by acid sodium phosphate.

It appears as a sediment after eating rhubarb, cabbage, &c., as crystals which are regular octohedra, brilliant, and colourless.

Mucin. Normally present in small quantity, collects on standing as a faint cloud at the bottom of the vessel.

ABNORMAL URINE.

Colour. If very pale, probably due to unusually large quantity of water—polyuria. If high-coloured, suspect proteids; if red, brownish, chocolate, or deeper coloured, some form of blood pigment; if orange reddish, or darker, with a greenish tint at the top, bile pigments.

S.G. and quantity. Remember these are interdependent. A high S.G. with large quantity indicates sugar.

Albuminuria. Any of the following may occur, serum-albumin and globulin usually together. Their separate recognition is at present of no clinical importance. Blood pigments will give proteid reactions.

Tests:—Those for proteids generally.

1. Heller's contact method should be tried first. Remember that an old *iron spoon*, a *tallow candle*, and some *vinegar* will enable you to perform the recognition of a coagulable proteid under difficulties.

Quantitative Estimation.—By Esbach's Albuminometer. Albumin and globulin.

1. Reagent:—10^g picric acid and 20^g citric acid to 1 litre of water.
2. Urine must be acid, add acetic acid if required. S.G. must be lowered to 1008 by dilution. The process is most accurate when 4^g of albumin per litre are present. The temperature has a marked influence. The colder the urine the bulkier will the *pp* be.

3. Measuring tube.

Process.—Fill the measuring tube with urine to the mark U, add the reagent to R, cork, and invert 10 to 12 times (no shaking). Set the tube upright in a stand for 12 hours and read off the percentage from the graduations, which give it in grammes per litre.

The separate recognition of globulins and albumins is of no importance clinically. That globulin is present may be demonstrated:—

1. By dropping urine into a large quantity of water—a cloud forms.
2. Neutralise urine carefully, filter off any *pp* of phosphates, then add one-half its volume of a sat. solution Am_2SO_4 , the *pp* indicates globulin. Filter. Albumin can then be demonstrated in the usual way in the filtrate.

Albumosuria and peptonuria. See tests already given under the respective substances.

The most convenient method is to saturate some of the urine with NaCl, add drops of acetic acid, boil in a beaker, filter hot. The filtrate gives on cooling a *pp* of mixed albumoses. If there be no *pp*, a pink Biuret reaction shows pepton.

Hæmoglobinuria. Blood in urine may appear as HbO_2 , Met-Hb, Acid H-tin, Hæmatoporphyrin.

Recognise these by the tests already given and especially by the following:—

1. Heller's test. To the urine add one-eighth volume NaOH, boil; a *pp* of phosphates coloured red by hæmatin results.
2. Guaiacum test, pg. 137.

3. Search for blood corpuscles.

4. Spectroscope.

Mucin. Is increased in cystitis and may be derived from the vagina. Tests:—

1. Dilute the urine, if the S.G. is high to prevent the salts keeping the mucin in solution, with 2 volumes of water and add acetic acid *pp*.
2. If there be a heavy deposit in the urine collect some of it with a pipette, place in a tube and add drops of NaOH, the mucin will lose its viscosity and become fluid.

Pus. Donné's test. Collect some of the deposit with a pipette and add to it some NaOH solution. It thickens and the fluid moves sluggishly in the tube on shaking, alkali albumin being formed.

Cystinuria. The crystals of cystin are found in urine in rheumatism. It may occur as a constant constituent to the extent of 0.5% in 24 hours, but is usually abnormal.

1. It is insoluble in water.
2. The crystals are six-sided plates.

21 Glycosuria, sugar in urine, saccharine urine. A very small quantity may be normally present in urine. The quantity is large in diabetes mellitus. The appearance of more than a mere trace of a reducing substance is clinically important. The presence of dextrose is indicated by the usual tests.

Tests. Remove proteids as they interfere.

(a) *With Copper Salts.*

Trommer's test is the type. Make urine strongly alkaline with KOH (or NaOH) add, with care, by drops solution CuSO_4 (1 p.c.). On heating a *yellow or red pp of cuprous*

oxide (Cu_2O) occurs, which, if well marked and abundant, indicates either sugar or glycuronic acid. The latter is not very common, but should be remembered.

NOTE.—In this test if performed with H_2O , the hydrated copper oxide produced by the alkali on CuSO_4 is insoluble, and heated to 100°C . falls as a black *pp*. Ordinary urine differs from H_2O in keeping the hydrated oxide in solution, and yields a slight reaction due to uric acid, hippuric acid, creatinin, alcapton, albumin, nucleo albumin, bile pigments. These may veil the reaction due to the minute trace of sugar normally present. Fehling's solution and Barfoed's reagent give the same reaction.

(b) *Bismuth Salt*.—Nylander's test. To 10 volumes urine add 1 volume of the following solution: 2^g basic nitrate of bismuth, 4^g Rochelle salt, 100^{cc} of a solution containing 10·33^g NaOH. Boil 5 to 10 minutes. A black *pp* forms (said to show as little as ·04^{p.c.} sugar). Albumin gives it also, 6^{p.c.} a red brown *pp*, and 1·2^{p.c.} a black *pp*.

Pure peptone does not give the reaction (Le Nobel).

It is not reduced by uric acid, creatinin, alcapton.

(c) *Phenyl hydrazin test*.—Place a small quantity of the dry substance (knife point), *phenyl hydrazin hydrochlorate*, and two or three of *acetate of soda* in half a tube of urine. If they do not dissolve, add a little water. Boil 30 minutes, then cool. Yellow crystals deposit. Under the microscope they appear as yellow *needles*.

Quantitative Estimation.

Precautions.—Remove any proteids that may present by acidulating, boiling, and filtering.

In performing a volumetric estimation with Fehling or Pavy's modification it should be noted that the suboxide formed may be re-oxidised by the oxygen of the atmosphere and that in consequence a partial return of the blue colour may be occasioned even during the performance of the process.

It is therefore necessary to proceed quickly and to delay as little as possible over the earlier part of the operation, slowing towards the end. Three estimations should be performed. The first as rapidly as possible by running the sugar solution continuously into the *boiling* Fehling until discoloration is complete.

From this preliminary trial is ascertained approximately how much sugar solution is required to reduce all the copper. In the next run this amount less 2 or 3^{cc} into the Fehling, care being taken not to lower the temperature of the Fehling below boiling by a too rapid addition. With the third trial a close approximation should be attained.

Should the sugar solution be so strong that only a few cc of it reduces all the copper, then further dilution, to say 1 in 40, is necessary.

Fehling's solution. 10^{cc} = 0.05^g dextrose.

1. Dilute the urine with 19 volumes H₂O, and place it in a burette (= 1 in 20 solution).

2. Dilute 10^{cc} Fehling + 40^{cc} H₂O, and place in a porcelain capsule. Keep it boiling.

3. Run (1) into (2), until all Cu₂O is *pp* and the blue colour is gone. To determine this, tilt the capsule to utilise the white back ground.

4. Read off the number of cc, dilute urine used, then 20 : cc dilute urine used :: 1 : x = cc actual urine used.
 x contains .05^g sugar.

To find the percentage $\frac{100 \times .05}{x} = y$.

$\frac{y \times \text{cc urine in 24 hours}}{100} = \text{Quantity in 24 hours.}$

Pavy's modification of Fehling's process.

Principle:—Cuprous oxide is dissolved by NH_3 . A sufficient quantity of NH_3 is added to Fehling to dissolve the Cu_2O formed, the disappearance of the blue colour can thus be better seen. The end of the reaction is more distinct.

S.S. 120^{cc} Fehling + 400^{cc} NH_3 (0.88) + H_2O to 1 litre. 10^{cc} = 1^{cc} Fehling = 0.005^g sugar. The solution keeps well in properly stoppered bottles. It can be obtained in sealed tubes containing 10^{cc}.

Process:—

1. Place 10^{cc} Pavy-Fehling in a flask fitted with a good cork through which two tubes pass. The one is short and is joined to the nozzle of the burette by a rubber junction, the other is bent to an angle outside the cork and leads into the air.
2. The burette, as in the former case, contains a 1 in 20 dilution of the fluid under investigation.
3. Boil the standard solution, and whilst it boils run in the sugary fluid from the burette with the precautions mentioned. Note the disappearance of the colour, to assist which hold a piece of white paper or a white tile behind the flask.

Make a second and third estimation as before.

Fermentation Process. Important. Glucose ferments; Glycuronic acid does not. To perform the estimation with the greatest degree of accuracy, good hydrometers are required, and should be employed at the temperature for which they are graduated.

Process:—

1. Take S.G. of urine, filter it, and place 100^{cc} in a flask.
2. Add some yeast of the size of a pea, mix thoroughly.

3. Stand the mixture in a warm place for 24 to 48 hours.
To prevent evaporation, it is desirable to have a tube trapped with water, passing through the cork.
4. Filter quickly, take S.G. at the same temperature as before.
5. Multiply the difference in S.G. by 230, this gives the percentage. Example— $1.040 - 1.008 = .032 \times 230 = 7.36$ p.c.
Or each degree of difference = 1 grain per fluid ounce.
(Sir W. Roberts.)

Examine *Einhorn's Fermentation Saccharometer* and *Dr. G. Johnson's Picro-saccharometer*.

Acetone occurs in the urine at times and is often associated with glycosuria, pg. 128.

Bile in Urine. Icteric Urine. Note the colour—orange to greenish-brown, or even to dark porter colour.

Tests:—Perform the tests for pigments and bile acids, pg. 128. The test for acids often fails on account of their small quantity.

URINARY TEST TABLE.

	Albumin	Globulin	Proteose	Peptone	Phosphates	Urates	Blood	Bile	Sugar Dextrose	Pus	Mucus
1. $\bar{A}c.Ac. + Heat$...	Coag.	Coag.	<i>pp</i> (c)	Clear (c)
2. HNO_3 ...	Coag.	Coag.	(a) <i>pp</i>	(b) Xantho proteic.	Clear	(d) colours	<i>pp</i>
3. EXCESS H_2O	<i>pp</i>
4. $\bar{A}c.Ac. + K_4FeCy_6$...	<i>pp</i>	<i>pp</i>	(a) <i>pp</i>
5. FEHLING	<i>pp</i>
6. SULPHUR	(e) Sinks
7. TR. GUAIACUM AND OZONE }	Blue
8. KOH	Ropy	Thins

(a) Disappear on heating, restored on cooling.

(b) Complete Xanthoproteic by adding NH_3 .

(c) Heat only. The phosphates require acid as well.

(d) Impure HNO_3 .

(e) Surface tension test.

NOTE:—Before testing for Non-coagulable Proteids remove the Coagulable ones by $\bar{A}c. Ac.$, Heat, and filtration.

LIST OF REAGENTS.

Acid, Acetic, commercial, and 5^{p.c.} solution.

„ *Hydrochloric*, concentrated and 0·2^{p.c.} solution.

„ *Nitric*, (a) concentrated, and (b) containing nitrous acid.

„ *Sulphuric*, concentrated, 10^{p.c.} and $\frac{N}{1}$ solution.

Alcohol, absolute and methylated.

Ammonium Hydrate (S.G. 0·88).

„ *Molybdate*, 10^{p.c.} solution.

„ *Oxalate*, 10^{p.c.} solution.

„ *Sulphate*, crystals.

Barfoed's reagent, copper acetate 1, water 15. To 200^{cc} add 5^{cc} commercial acetic acid.

Barium chloride, 10^{p.c.} solution.

Calcium „ 2^{p.c.} solution.

Congo red.

Copper acetate, crystals.

„ *sulphate*, crystals and 4^{p.c.} solution.

Ether, methylated.

Fehling solution, (a) of pure CuSO_4 crystals, 36·44g distilled water 500^{cc}. (b) Rochelle salt (potassium sodium tartrate) 173g, sodium hydrate 60g, dissolve separately in distilled water, mix together, and make up to 500^{cc}. (a) and (b) combined in equal quantities for the standard solution, 10^{cc} of which = 50^{mg} of glucose.

Ferric chloride, 10^{p.c.} dilution of liquor fortior B.P.

Furfural.

Guaiacum resin.

Hydrogen peroxide.

Iodine solution. Iodine 1, potassium iodide 2, water 300 parts.

Lead acetate basic.

Litmus, solution and paper.

Magnesium sulphate, crystals.

Mercuric chloride, aqueous solution.

Methyl orange.

Millon's reagent. Dissolve mercury in an equal weight of concentrated nitric acid; heat to solution; add 2 volumes water; decant next day.

Phenol.

Phenyl hydrazin.

Picric acid saturated solution.

Potassium Ferricyanide, 10^{p.c.} solution.

„ *Ferrocyanide*, „ „

„ *Hydrate*, „ „

„ *Sulphate*.

Silver nitrate, 4^{p.c.} solution in distilled water.

Sodium acetate, crystals.

„ *carbonate*, 10^{p.c.} solution.

„ *chloride*, crystals and 10^{p.c.} solution.

„ *hydrate*, 10^{p.c.} and $\frac{N}{1}$ solution.

Sodium nitro-prusside.

Sulphur, flowers of.

Tannic Acid.

Uranium Nitrate.

PART III.

EXPERIMENTAL SECTION.

Students work in pairs, a sub-division of labour which materially facilitates the performance of the various experiments.

Each student is required to bring the following:—One pair of ordinary dissecting and one pair of fine pointed small scissors, cutting well at the points. One pair of ordinary dissecting forceps and one small fine pointed pair. They must grasp well at the points and be perfectly clean. A small scalpel. One metal and one glass seeker. Ordinary pins. Half a dozen S hooks. Some fine linen thread and fine sewing silk.

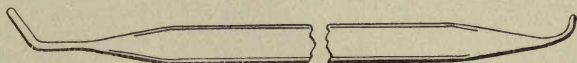

FIG. 19. Glass seeker, with ends differently bent.

Each work table is supplied with the following, which are placed on the shelf below it:—An induction machine. Two Leclanché cells (quart size). Three electrical keys (switch pattern). A porcelain bowl and plate. Wires for electrical connections. A stick for killing frogs. A duster. A bottle of normal saline.

Each table is provided, as occasion demands, with:—A recording cylinder. A general stand with a muscle chamber, frog heart recorder and time marker. A variable spring. Daniell cells.

NOTE.—The chapter on Electrical Considerations should be read carefully beforehand.

ELECTRICAL CONSIDERATIONS.

Electricity comes under consideration in Physiology as follows:—

1. As a convenient stimulus for muscles and nerves in the form of induction currents.
2. As a direct battery current for the production of polarisation in nerves and exceptionally in this form as a stimulus.
3. As a direct battery current for actuating mechanical contrivances, such as time markers, &c., the basis of which is the electromagnet.
4. The passage of a current through a conductor in the proximity of a magnetic needle causes the needle to move. This principle is made use of in the galvanometer and by means of it the currents yielded by living tissues can be recognised and measured.

*Remember:—*Electromotive force (E.M.F.) is the force which tends to move electricity from a point of higher to one of lower potential. The unit of E.M.F. is the volt, and is therefore the measure of electrical pressure. One volt will move a quantity of 1 coulomb of electricity through a resistance of 1 ohm in 1 second, thereby producing a current of 1 ampère. This relationship is expressed by the formula $C = \frac{E}{R}$

$$\text{Current (ampères)} = \frac{\text{Total E.M.F. (in volts)}}{\text{Total Resistance (in ohms)}}$$

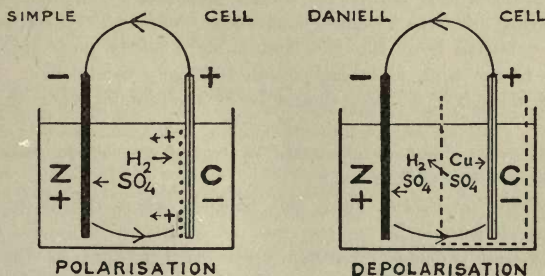

FIG. 20. The film of H, which produces polarisation, is shown as a row of dots on the C plate of the simple cell.

The galvanic cell consists of two plates or elements, commonly the one of zinc and the other of carbon or copper immersed in a sensitising fluid (10 p.c. H₂SO₄). The action of the cell depends upon the solvent action of the acid upon the zinc, zinc sulphate being formed. At the same time H is liberated. This transaction is pictured in the

diagram of the simple cell (Fig. 20). The immersed portion of the zinc is the positive plate, whilst the projecting part is the negative pole (Kathode).

The current flows from the zinc to the C plate in the fluid, and circulates from the positive pole (Anode) to the zinc through the *external* connection. The hydrogen which is liberated appears on the negative C element, where it forms a film which is not only non-conducting but is a strongly electro-positive as well. This has an important bearing upon the working of the cell, as there is an increased resistance offered to the passage of the current by the film of hydrogen bubbles on the negative plate, which, at the same time, exerts an electromotive force in a direction contrary to that of the cell, and both taken together ultimately render the cell inoperative. This is termed *polarisation*. A corresponding action takes place between metal terminals (Electrodes) and the animal tissues with which they may be in contact when a current passes through them.

Amalgamation of the zinc plate. Pure zinc is not attacked by the acid. Owing, however, to the presence of iron, arsenic, &c., local circuits on the surface of the zinc come into action and the metal is eaten into holes. To remedy this the zinc is amalgamated with mercury. The plate is first cleaned with 1 in 10 sulphuric acid in water until bubbles of gas are given off, and is then rubbed over with mercury, using a stiff nail brush for the purpose, so as to produce an even covering, and to remove superfluous mercury. The impurities are thus detached from the zinc and a more nearly pure zinc surface is offered to the acid, and local action is largely diminished. Singing, i.e., the formation of bubbles should be at a minimum when the circuit is open.

Galvanic cells differ in character in regard to voltage, constancy of action, and internal resistance.

The voltage or E.M.F. of a cell depends upon the nature of its constituent elements.

The internal resistance depends upon (a) the area of the plates, (b) the distance at which they are placed from each other, and (c) the resistance of the sensitising fluid.

The constancy of action depends upon the completeness with which polarisation is abolished.

The Daniell cell. This is the standard cell used for physiological work. The zinc, with its acid, is separated by a porous septum from the copper, which is placed in a saturated solution of copper sulphate (the depolarising agent). The hydrogen liberated unites with the

sulph-ion from the copper sulphate, and copper is deposited upon the copper plate. The action of this cell remains constant as long as there is copper sulphate present to be decomposed. A store of the salt is kept in the solution to make up for loss. Voltage 1·9, internal resistance 0·5 ohm approximately.

Leclanché cell. In this the acid is replaced by sal ammoniac, the solution of the zinc yields chloride of zinc and ammonia. Ammonia and hydrogen gas are liberated at the carbon. Depolarisation is effected by means of manganese dioxide, which is packed round the carbon plate mixed with granulated carbon. MnO_2 yields oxygen slowly, this combines with the hydrogen to form water. The hydrogen collects faster than it is removed, and the cell polarises. If the circuit be open for a short time, the cell depolarises; it is therefore most useful for open circuit work, i.e., work in which the circuit is closed for a brief time only. Voltage 1·5, internal resistance about 1 ohm.

This battery is mostly employed for actuating induction machines and time markers, and works well provided the period of close circuit is shorter than that of open circuit. Most "dry" cells are modified Leclanché cells.

Other cells used less frequently in physiological work.

The Grove cell. The zinc is placed in dilute sulphuric acid in the outer vessel, and platinum in a porous vessel which contains strong nitric acid (depolariser). The hydrogen liberated is oxidised to water, and nitrogen trioxide fumes are given off (the great disadvantage). Voltage 1·9, internal resistance may be as low as 0·1 ohm.

The bichromate or Grenet cell. A bottle-shaped receptacle, with a neck as long as the zinc plate. To the stopper two carbons and a central zinc plate are attached. The sensitising fluid is dilute sulphuric acid, as in the other batteries, whilst for depolarising 8 p.c. bichromate of potassium is added. A small quantity of mercurous sulphate in the solution helps to maintain the amalgamation. Both elements dip into the same fluid. From this the zinc can be withdrawn when the battery is not in use. The voltage may attain to over 2 volts, but soon drops and consequently the cell is only of use for short periods. The internal resistance is low. Disadvantage, frequent recharging is necessary, and creeping of the fluid destroys the connection of the carbon with its terminals.

Connections or leads. No. 18 cotton-covered wire. The ends must be bared of their covering and cleaned by scraping before being attached to the binding screws in order to secure good contact.

Never omit to examine the wires for fractures, especially if they are wound into spirals.

Keys. These are inserted into the circuit wherever it is desired to control the passage of a current.

The *Du Bois Reymond* key (Fig. 21, A) is one of the most efficient, and is of historical interest.

The *simple switch* depicted (Fig. 21, B) is quite as efficient and is less costly.

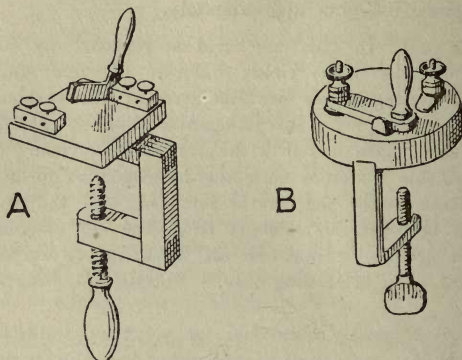
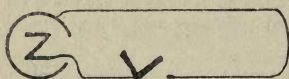

FIG. 21. A Du Bois Reymond, B Simple key.

Whatever the key, it can be used in one of two ways.

1.—As a **Make** and **Break** device it is inserted into the circuit so that when closed the circuit is completed, and when it is opened the circuit is broken. Always use it in this manner when in circuit with a Leclanché cell (Fig. 22).



MAKE AND BREAK

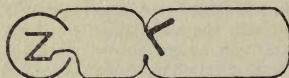

"SHORTING"

FIG. 22.

2.—For **short circuiting** ("shorting"). In this case the circuit is never broken, but the closure of the key is so arranged as to offer a path of less resistance to the current.

The current is not entirely diverted from the "longer" path, but practically so little passes that it comes to the same thing.

Remember that in a divided circuit the distribution of the current is proportioned inversely to the resistance of the respective paths. Less resistance more current; more resistance less current.

Commutator. (Fig. 23.) For the purpose of reversing the direction of a current. *Pohl's* instrument is the best.

The *rocker* consists of two portions joined across the middle line by the insulating piece R.

The *leading in* binding screws are attached to mercury cups, into which the middle arms of the rocker are placed. For the purpose of reversing, the cross wires are used, and the *leading out* connections are attached to the binding screws, and so to the cups on one side only. When the arms of the rocker dip into these, the positive pole remains on the same side; when the rocker is reversed the other *leading out* wire becomes positive.

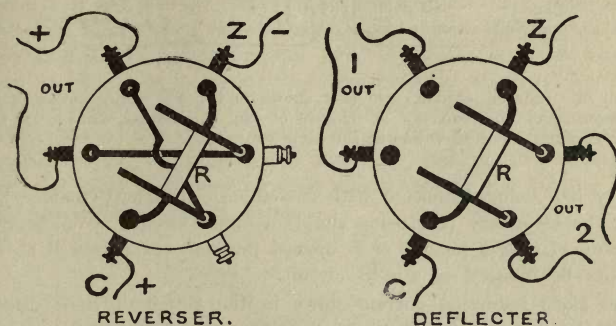

FIG. 23. Diagram of Pohl's commutator. The rocker R is shown in position for reversal of the current in the left-hand figure.

To use the Pohl as a *current deflector* the cross wires are removed, the connections of the two alternative circuits are made with opposite pairs of cups, and the rocker changes the path when it is moved from one set to the other.

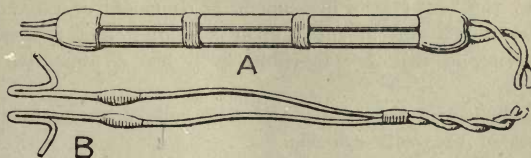

FIG. 24. Hand electrodes.

Hand electrodes:—Two stout copper wires are passed through glass tubes for insulation and rigidity. The ends of the latter are sealed with electric cement; the tubes are tied together and their ends are covered with marine glue, the free ends of the wire are shaped conveniently. The other ends are soldered to flexible wires which terminate in tags that will fit either screw-down or perforated terminals.

2 Induction machine. Du Bois Reymond's Inductorium.

Principle of action:—If portions of the wires forming two separate circuits be placed parallel to each other, as in the case of the planes of the two spirals or coils of the Inductorium (Fig. 25), the one wire,

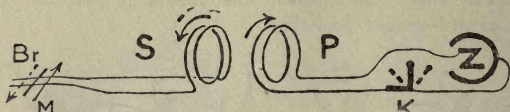

FIG. 25. Induced currents are only shown in S. The solid arrows indicate the direction of the currents at closure of key K. Dotted arrows at break. Similar currents occur in P and at the same time.

primary (P), being connected with a source of electricity (battery), the other, the secondary (S), being simply a closed circuit. Whenever the P circuit is closed (made) or is opened (broken) currents will at those moments be induced in the S circuit.

The *make* induction current flows in the S circuit in a direction *opposite* to that in the P circuit; whilst the *break* induction current flows in the *same* direction as the original battery current.

These induction currents are of very short duration.

Place the induction machine lengthways in front of you on the table with the interrupter turned to the right.

In the Du Bois Reymond type the wires are wound into two separate coils; the P coil which is supported by a wooden upright attached to the base of the instrument is composed of relatively thick wire, whilst the S coil mounted upon a sliding foot is composed of very thin wire, in this case invisible, as it has a protective covering of vulcanite.

The parallelism of the wire in the two coils is maintained so long as the axes of the coils coincide.

The successive turns of wire in each coil are also practically parallel to each other.

The P coil is provided with a core of soft iron wire which magnetises when a current passes in the surrounding wire an electromagnet being thus formed.

The electrical field produced by the coil is greatly intensified by this core, and the effect on the S coil is correspondingly increased.

The nearer the S coil is to the P coil, the more powerful will be the induction currents.

The E.M.F. of the currents in the secondary bears a direct relationship to the E.M.F. of the currents in the primary. Thus, if there are 200 turns in the P and 6,000 in the S, the E.M.F. of the induction currents will be approximately 30 times that of the inducing currents, independently of the influence exerted by the iron core.

Connect up the secondary circuit of the Inductorium. (Fig. 26 S.) It is well to do this in all cases first.

Fasten a key to the table close to the left-hand end of the machine as it now rests on the table, and connect the binding screws of the S coil with those of the key, by means of two wires, so that when the key is closed the S circuit is thereby also closed. *This is the short circuiting key in the secondary circuit.*

Now attach the long circuit wires, by means of which the connection is to be established, with the seat of stimulation, i.e., attach the hand electrodes by their metal tags to the binding screws which already hold the S wires.

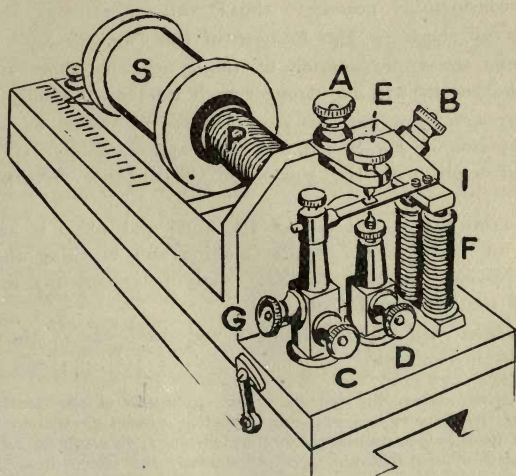

FIG. 26. Inductorium of du Bois Reymond.

Connect up the P coil for single induction currents. (Fig. 26.)

Place the Leclanché cell upon the table near the right hand end of the coil, and attach a key to the table close to.

Keep the key open. In making the connections always begin at the battery, and follow the direction the current will take.

Connect the **C** pole of the cell to the key by a wire, then wire the other side of the key to the top binding screw **A** of the **P** coil, wire **B** to the zinc pole of the cell.

Withdraw the **S** coil to 20 cm of the scale, and let one co-worker hold the electrodes against his wetted lip whilst the other makes the trials.

Make and break the P circuit with the key. Do this smartly, once or twice only, and after each trial push the **S** coil half a cm towards the **P** coil.

Let the co-worker indicate when he feels the "shock," and whether he does so at *closure* or at *opening*.

Note the position of the coil as soon as the *minimal break* shock is felt; it is perceived first.

Proceed with further trials until the *make* shock is also felt.

Read off the position of the **S** coil.

It is considerably nearer to the **P** coil.

The *break* shock is the *stronger* of the two.

Continue the approximation of the **S** coil by short steps to the **P** coil, the shocks will be stronger each time until finally unbearable.

The strength of a stimulus can therefore be varied by changing the relative position of the S coil. It may approximately be assumed to change inversely with the square of the distance between the two coils.

Next take the **S** coil out of the slide and place it end on, and close up to, the **P** coil. Whilst making and breaking the **P** circuit turn the **S** coil so that its axis shall be ultimately set at right angles to that of the **P** coil.

The shocks will rapidly diminish and disappear as the position of the **S** coil is changed.

Explanation.—When the battery current at *closure* of the circuit is rising in strength in the *primary*, an opposing *induction current* is thereby generated in the **P** coil itself, which retards the battery current from attaining its full strength as soon as it otherwise would, and consequently the effect upon the **S** coil is not so sudden a one.

On *breaking* the **P** circuit an *induction current* is likewise generated which has the *same direction* as the *disappearing battery current*, and consequently it retards change of the electrical condition but does not interfere much with the suddenness of the subsequent drop in potential, and therefore the effect upon the **S** coil is greater than at *closure*.

This opening extra current never reaches its full development, as it originates at the moment that the **P** circuit is being broken; to circulate at all it must needs fly across the air gap at the contact **E**, which rapidly increases and so quenches the flow.

It is well, also, to bear in mind that contacts are by no means of negligible duration, for they vary very much in different forms of instruments. This applies also to ordinary keys.

These are the salient features in the action of the Inductorium, but there are others, such as the influence of the electromagnet of the interrupter, &c., which cannot be considered here.

Demonstration of the break extra current as an illustration of one of the induction effects in the P coil (Fig. 27).

Remove the S coil from the Inductorium and set up as follows:—

First set up the Leclanché cell in circuit with the hand electrodes with a “shorting” key (1). Hold the electrodes against your tongue, and open and close the key—nothing will be felt. The E.M.F. of the current is not sufficient to produce a stimulus through the resistance offered by the skin.

Now add to the battery circuit the P coil (slip off the S coil and place it on one side) with shorting key (2), so that the P coil may be at will included or excluded from the circuit.

Keep key (2) closed, and repeat the trial as before, key (2) excludes the coil from the circuit and the result is the same (effect of “shorting”). Next open key (2), then on opening key (1) a shock is felt at break. This shock is due to the induction current which is generated in the coil by the fall of potential in the battery circuit. The fall is due to the easier path through key (1), being replaced by a path of greater resistance through the tongue, and consequently a feebler current flows through the P circuit, and this *drop* generates an induction current in the circuit, and the latter having a higher E.M.F., is able to pass through the tissues and to act as a stimulus.

The effect is largely due to the iron core of the coil, for if the S coil be substituted the effect will not be so great in spite of the fact that this coil presents in the larger number of its turns of wire, a condition favourable to the production of more powerful induction effects.

Interrupter shocks. Detach the wires from A and B and transfer them to the binding screws C and D. Adjust the top contact screw E so that it touches the spring lightly (Fig. 26b).

On closing the P circuit this spring oscillates, automatically opening and closing the P circuit, and a succession of induction currents are generated in the S coil.

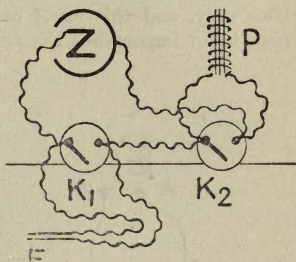

FIG. 27. Break extra current.

The rate of their occurrence depends upon the length of the spring.

Explanation:—The current from the battery flows up the pillar C, through the spring up through the top contact screw to the P coil, and thence round the electromagnet F and back by the base of D to the battery.

When the current flows round the circuit, F is magnetised and draws down the spring I, thus breaking the top contact.

Upon this the current stops flowing, the magnet ceases to act, the spring is released and again makes contact with E, and so the circuit is re-established and the cycle begins anew.

As the break shock is always the stronger of the two, it follows that if these shocks are passed through a tissue for some time that polarisation effects will be set up. Ordinarily they are employed for a short time only, and this effect can be disregarded. In cases in which this may be of importance the next arrangement must be made use of.

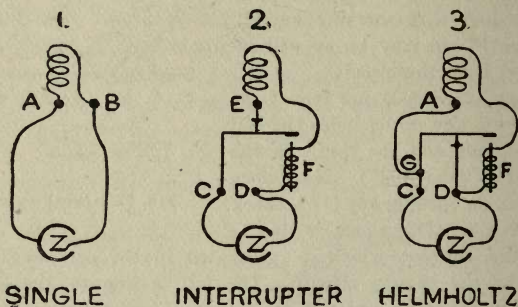

FIG. 28. Connections of the primary circuit (after Waller).

Helmholtz wire for the equalisation of the make and break shocks (Fig. 28). Leave the connections as for interrupter shocks and add a wire between G and A. Raise the top contact screw E clear of the spring, and turn up the screw on pillar D until it touches the under side of the spring when the latter is held depressed against the electromagnet. On closing the circuit the spring oscillates.

Explanation.—The P circuit is now closed at all stages of the oscillations of the spring.

When the current first enters it passes round the long path through the P coil and F is magnetised. The spring is now pulled down and makes a shorting contact at D. The current leaves the longer path for the shorter easier one C to D, and is practically excluded from P and F. The spring is released and flies back restoring the long circuit, and the cycle begins anew.

Both extra currents in the **P** circuit now gain their full development, and there is consequently retardation of the fall of potential at break.

The induction currents in the **S** circuit are now produced by fall and rise of the strength of the currents in the **P** coil, and not by make and break. The difference in the change is, on the one hand, not so great, and consequently the shocks are not so powerful; but on the other hand, owing to the fact that the circuit is never broken, the break extra current gains its full development, and there is consequently a retardation of the fall in potential, and the induced shock in the **S** coil approximates more nearly in strength to that at closure.

The difference is, however, not completely removed; the opening shock remains a little stronger.

DISSECTION OF THE FROG.

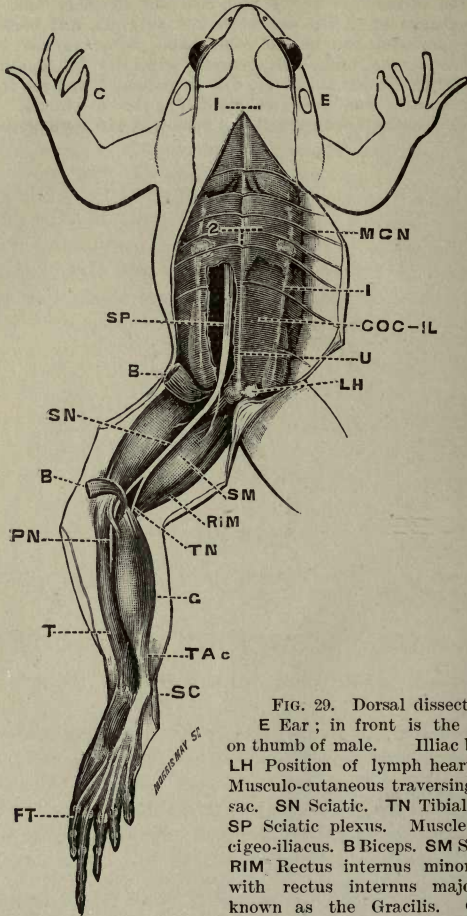

FIG. 29. Dorsal dissection of a frog.

E Ear; in front is the eye. C Callosity on thumb of male. Iliac bone. U Urostyle. LH Position of lymph heart. Nerves:—MCN Musculo-cutaneous traversing the dorsal lymph sac. SN Sciatic. TN Tibialis. PN Peroneal. SP Sciatic plexus. Muscles:—COC-IL Coc-cigeo-iliacus. B Biceps. SM Semi-membranosus. RIM Rectus internus minor, which together with rectus internus major (see Fig. 4) is known as the Gracilis. G Gastrocnemius,

note its tendinous slip over PN. T Tibialis. TA c Tendo achillis. SC Sessamoid cartilage. FT Flexor tendons in the foot.

DISSECTION OF THE FROG.

Pithing. Stun the frog by a sudden blow on the head with the stick provided. Pass the blunt edge of the knife over the dorsal surface of the head until the groove at the back of the occiput is felt. At this point and in the middle line plunge the knife transversely into the vertebral canal, so as to sever the cord (Fig. 29, 1).

Make the incision as narrow as possible, so as to miss the vertebral arteries, the division of which will cause much bleeding.

Pass a metal seeker upwards into the cranial cavity and turn it round freely, so as to disorganise the brain completely. *Decerebration.*

To complete the pithing, pass the seeker down the full length of the canal, so as to destroy the spinal cord.

The hind limbs will twitch violently whilst this is being done, but no sensation can be set up, as the brain has been destroyed. If bleeding is to be prevented, plug the aperture in both directions with pointed match ends.

Dorsal dissection. Lay the frog on the loaded frog plate, dorsal surface uppermost and with its legs extended.

Find the longitudinal groove in the skin in the middle of the thigh, which marks the position of the biceps muscle. Under this muscle lies the sciatic nerve.

Pinch up the skin with forceps, make an incision lengthways up the middle of the thigh to the iliac bone and along the whole of its inner edge. *Use scissors whenever you can.*

Next prolong the incision downwards to the middle of the foot. Pin the skin aside after severing the few attachments at thigh, knee, and heel.

Note the dorsal cutaneous nerves as the skin of the back is reflected. The skin has few adhesions to the subjacent parts, as extensive lymph sacs intervene.

Clear the narrow biceps carefully from its neighbours with scissors, the nerve will be found beneath it, crossed from without inwards by the sciatic artery.

The vein almost black in colour accompanies it in the lower part of its course, then leaves it above to run outwards. This vein after joining a transverse branch higher up, goes to form the renal-portal vein.

Clear the nerve carefully from its surroundings, lifting it with the glass seeker, and divide all restraining tissue around it with scissors.

Never hold the nerve itself with forceps, and do not pinch or pull it in any way. Remember that this is a living structure and very easily injured. It should be kept moist with normal saline and must on no account be allowed to dry.

Two branches of the nerve will have to be cut in the thigh—one nearly midway externally, and one higher up upon its mesial aspect. Observe that muscles twitch when this is done, owing to the mechanical stimulation of the nerve when it is being cut.

In severing the connective tissue where the nerve enters the abdominal cavity, keep the points of the scissors up and near the iliac bone, as the nerve lies more to the inner side.

Cut through the coccigeo-iliacus muscle along the bone.

Lift the end of the urostyle, clear it from the subjacent parts (contents of the abdominal cavity) sever it from the spinal column. The sciatic plexus of both sides are now in view. Cover this part up with a flap of the skin and proceed to clear the lower end of the nerve.

When the skin is used as a protective covering the outer surface must not be placed in contact with muscle or nerve, as its secretion is injurious to them.

Near the knee the sciatic divides into an outer peroneal branch which passes under a tendinous slip from the gastrocnemius muscle, and an inner tibial branch which turns under the latter muscle to be distributed to its under surface.

Note:—The frog is to be employed in its present condition for the performance of those experiments which can be carried out without recording. For recording purposes the nerve-muscle preparation requires to be completed as follows:—

The **Nerve-muscle preparation.** (Fig. 30.) Where the Tendo achillis passes round the heel it is thickened by a sessamoid cartilage.

Make a hole through the latter for the introduction of an **S** hook¹ by passing the point of the scissors through it towards the subjacent bone. Detach the tendon and sever it on the tarsal side.

Raise the gastrocnemius by means of the tendon and carefully avoid touching the muscle with forceps.

Clear the muscle up to the knee, and divide this joint transversely with scissors, which can be done without danger to the tibial nerve if the muscle be turned well out of the way.

Next clear the femur of all muscles excepting the gastrocnemius, and sever the bone near the hip joint.

Divide the spinal column just above the attachment of the nerves, and then mesially so as to leave a portion attached to each sciatic plexus.

Manipulate the nerve by means of this piece of bone and sever any restraining tissue.

Rapid preparation of a frog's limb. After stunning and pithing the frog, hold it horizontally by the hind limbs with the left hand; the fore part of the body will hang forming a sharp angle where the spine meets the iliac bones.

Pass one point of a pair of scissors through the skin under the middle of the spinal column, and divide the back. The fore end will then hang down, held by the skin on each side. Divide the latter the whole length of the abdominal cavity, and then cut away the abdominal contents, taking care in doing so not to injure the nerves.

Grasp the skin with a towel at its spinal end, and holding the spine with the fingers of the other hand strip the skin off like an inverted glove, completely denuding all the structures.

Now grasp the muscles of the thigh between the dried finger and thumb of the left hand so as to put the dorsal aspect on the stretch, and scratch through the aponeurotic tissue until the nerve is exposed completely from knee to sciatic opening, and complete the separation of the nerve and muscle as before.

Cut away all the muscles from the femur, divide the latter at its upper end, raise the limb by means of the foot so as to lift up the nerve, cut through all restraining tissue, pass one blade of the scissors through the sciatic opening, divide the coccegeo iliacus muscle and the iliac bone at both ends, lay the frog on its back, clear the nerves to the spine, and divide the latter as before.

Clear the gastrocnemius, insert the **S** hook and remove the leg as before.

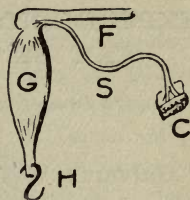

FIG. 30. **G** Gastrocnemius. **HS** hook through tendo achillis. **F** Femur. **S** Sciatic nerve with piece of spinal column **C** attached.

¹ Obtained through Messrs. Reynolds & Branson, Commercial Street, Leeds.

CHAPTER XXIX.

EXPERIMENTS ON NERVE AND MUSCLE WHICH CAN BE DONE WITHOUT RECORDING.

Contraction of the muscle is taken as the index of the excitation of the nerve.

Galvani's experiment. Raise the nerve upon the metal seeker and with the latter touch one of the pins which hold the skin down—a contraction of muscles will occur. *Contraction with metals.*

The pin and seeker form a galvanic couple, the current from which stimulates the nerves at the moment of contact and of separation. Repeat the experiment with "electric forceps."

A simple form of the latter consists of a copper and a zinc wire twisted round each other, the free ends of which are separated at one extremity (Fig. 30).

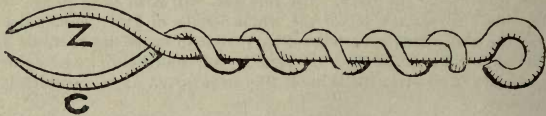

FIG. 31. Electric forceps.

Difference of make and break induction shocks. Use single induction shocks, slide the coil to 30^{cm} and find the minimal opening shock which will excite the nerve, as shown by the contraction of muscles.

The first evidence of this will be twitching of the toes.

Gradually move up the S coil until the induction current at closure also produces an effect, and note the distance in each case.

Weaker currents are required than were necessary in the trials upon your own tongue. The nerve is more excitable.

Rheoscopic limb. *Secondary contraction.* The nerve must be freshly prepared. Dissect the second limb of the frog upon which you have been performing the previous experiments, and cut the nerve near the vertebral column.

(a) Let the nerve fall upon its own muscle in such a manner as to touch it in two points, one of which is near the middle (equator) of the muscle and the other as far removed from it as possible.

A contraction will follow and will be repeated if the nerve is very sensitive when it is lifted off again. *Contraction without metals.*

If the muscle does not contract make an artificial cross section and let the second point of contact be the cross section. Defer this second part until (b) and (c) have been concluded. By that time the excitability of the end of the nerve may have disappeared and it will be necessary to cut off the dead portion.

(b) Place the rheoscopic nerve lengthways upon the first muscle and stimulate the latter with interrupter shocks. The rheoscope will respond to every contraction of the first limb.

(c) Lay the nerve lengthways upon the ventricle of the frog's heart, which is to be excised for the purpose and must be beating vigorously.

The cause in (a) is that the rheoscopic nerve connects two points of different potential, and the current which passes through the nerve stimulates it, and, secondarily, its own muscle.

In (b) and (c) the rheoscopic nerve lies along the path of the electrical wave which courses down the contracting muscle, and is thereby stimulated and its muscle contracts. The rheoscopic limb acts as a highly sensitive current detector, hence its name.

Transmission of nervous impulses takes place in both **4** directions in the same nerve. Carefully dissect off the muscles of the anterior surface of the leg, so as to include the distribution of the peroneal nerve.

Detach the latter as far up to its junction with the sciatic as you can, lifting the nerve by means of the muscle. The tendinous slip from the gastrocnemius will have to be severed.

Lifting the nerve by means of the muscle, so that neither of them touch the frog support, stimulate with interrupter shocks by the hand electrodes, and increase the strength of the current until the gastrocnemius contracts.

Great care must be taken that there is no chance of leakage of the current directly to the muscle or its nerve.

It is often difficult to convince oneself that leakage is not the cause. In case the doubt should exist, apply a ligature to the peroneal nerve as high up as possible, but clear of the other structures of the thigh, and stimulate again. If the ligature has been drawn sufficiently tight, nerve transmission will be excluded, and leakage will offer the only explanation of the phenomenon.

Another way of doing this experiment, which can be easily tried whilst both sciatics are at the disposal of the student at the time he is performing the experiments on secondary contraction, is as follows:—

Lay a couple of cm of the ends of the two sciatics parallel and in contact with each other upon a small block of paraffin, the latter being of such dimensions that it will leave between itself and the muscles on each side a space of 3 cm.

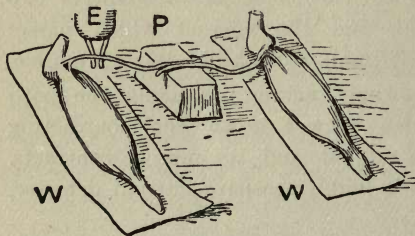

FIG. 32.

P paraffin block, W waxed paper, E electrodes.

Stimulate the nerve near one muscle. Lift the muscle A from the plate (to prevent leakage of current along the plate to the opposite muscle) and stimulate the nerve at S as far from the paraffin block as possible. If the nerves

are in a normal condition induction shocks of considerable strength will have to be applied before any effect is produced, and the limit of these must not overstep the strength at which leakage occurs.

Strength of interrupter shocks. Slide the **S** coil to 35^{cm} and note its position when the first manifestations of stimulation are apparent.

The distance of the **S** coil will be greater than with the single shocks. This is chiefly due to the quicker and more regular make and break of the **P** circuit, especially when using a Leclanché cell, which does not, under these circumstances, remain close circuited for so long a time, and in consequence the potential of the battery does not drop to any appreciable extent.

It is also due to the rapid repetition of shocks which, if applied singly, are ineffective.

Effect of stimulating different nerves. Stimulate the roots of the sciatic separately, near the spine, with interrupter shocks.

Also the peroneal and the tibial branches. Next the trunk of the sciatic with various strengths of current, and note the difference produced upon the class of muscle called into play, i.e., extensor and flexors.

Excitation of a muscle by various stimuli other than a nervous one.

(a) **Mechanical.** Strike the gastrocnemius smartly with the handle of a scalpel, the muscle will contract. The blow must be a sharp one.

(b) **Chemical.** Dissect out the sartorius muscle, hold it with forceps over a glass rod which has been dipped in ammonia so that the vapour may play on the muscle. The muscle will curl up in a continued contraction (contracture). Ammonia kills nerve without stimulating it.

Excitation of nerve by various forms of stimuli.

(a) **Mechanical.** Whenever a nerve is cut, a twitch of its muscle is evidence of its stimulation. In this manner when

the nerve is suddenly pulled or struck, it is thrown into action. Try these forms of stimuli last, upon a nerve which has been in use for some other experiment.

(b) **Thermal** stimuli. Heat a stout copper wire in a flame, and apply it suddenly when very hot to the nerve.

(c) **Chemical** stimuli. Apply a drop of saturated chloride of sodium to either the end or to some other part of a nerve, its muscle will commence twitching and will soon pass into a continued contraction (salt tetanus). The contractions are, however, not completely fused.

5 Changes in the excitability of a nerve when dying. Lay beneath the whole length of the sciatic nerve a strip of waxed paper, and keep it moist with normal saline.

Carefully raise the nerve with the glass seeker and explore it from end to end with minimal single induction shocks, the effect of which have been tested first in the middle of the nerve, and note if there be a difference of excitability at any point. There usually is at one or two points—find them.

Be guided in your estimation of this by change in the muscular effect evoked, such as increase, diminution, or absence of contraction.

Next cut the nerve at its spinal origin, and compare the excitability at the cut end with that at a point near the muscle. Repeat this from time to time. The cut end will presently exhibit a greater excitability, which will fail later until it is completely lost.

A dying nerve at first rises and then falls in excitability, finally losing it altogether. Remember that a nerve which is drying becomes more irritable for this reason.

Relative excitability of muscle and of nerve. Find the minimal shock which will evoke a muscle twitch through the

nerve, and then apply the same stimulus to the gastrocnemius directly. It will be ineffectual.

Approach the **S** coil until the stimulus is strong enough and note the difference in strength required.

From this experiment alone it is not permissible to conclude that muscle itself is directly stimulable, the participation of nerve endings in muscle not being excluded from the process.

See the experiment with Curara later.

Induction shocks have great power of overcoming resistance. Place a nerve-muscle preparation in a muscle chamber at one end of the room. Lay the nerve upon the platinum electrodes and connect one of its poles by means of a long wire to one of the terminals of the **S** coil of the inductorium. The latter is to be placed on a table at the furthest distance from the muscle-chamber which the room will allow, and is to be insulated on inverted porcelain basins.

Let your co-worker make and break the **P** circuit, or use interrupter shocks—the muscle does not contract—the insulation is sufficient to prevent the passage of the current.

If he now touches the unconnected terminal of the **S** coil with his finger the muscle will contract. His body by bridging the gap in the **S** circuit between the floor and the binding screw allows enough current to pass to stimulate the nerve.

This so-called *unipolar stimulation* is therefore due to defective insulation and is the reason for which the **S** circuit must always be provided with a shorting key, since the insertion in this circuit of an open break key is not enough to prevent induction currents from passing to the preparation, and especially so when strong currents are in use.

ARRANGEMENTS FOR RECORDING.

General arrangement of the work table. The typical method of distributing the apparatus upon the table is shown in Fig. 33. Battery to the right, inductorium in the centre near the edge of the table. **P** the key in the **P** circuit, **S** that in the **S** circuit. The recording cylinder and stand are conveniently placed to the left so that they may be easily accessible.

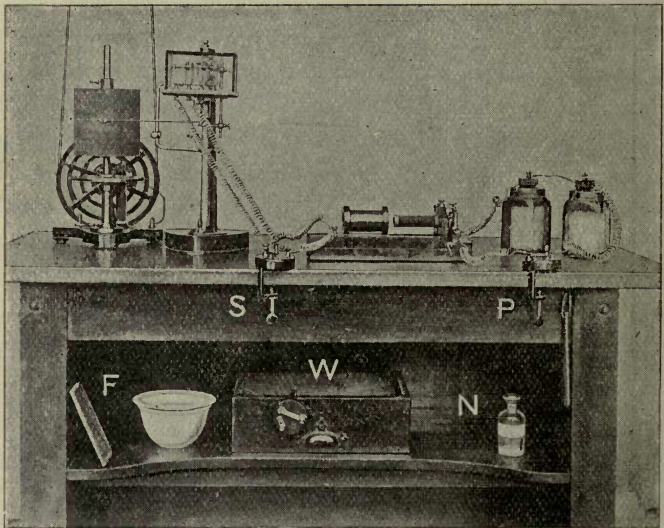

FIG. 33. Work table.

On the table shelf beneath to the left of **F** the leaded frog plate to its right the porcelain bowl covered with a plate in which the frog is placed until wanted. **W** is the drawer for wires, upon its edge the keys are supported when not in use. The inductorium is placed to the right of **W** when not in use. **N** normal saline, and to the right is suspended the stick for killing frogs or for coiling wires.

The Recording Cylinder (Fig. 34).

1. The **drum** (diameter 6 inches) can be adjusted for height on its axle, and is secured in position by tightening a thumb-screw. It can

be slipped off the axle for covering with paper and smoking the surface of the latter. The axle runs in double ball bearings at its lower end.

2. The **driving pulley D**, with various speeds (grooves for the driving cord), is carried on an axle which runs on ball bearings **C**, and transmits its motion to the driving disc on the drum axle by means of

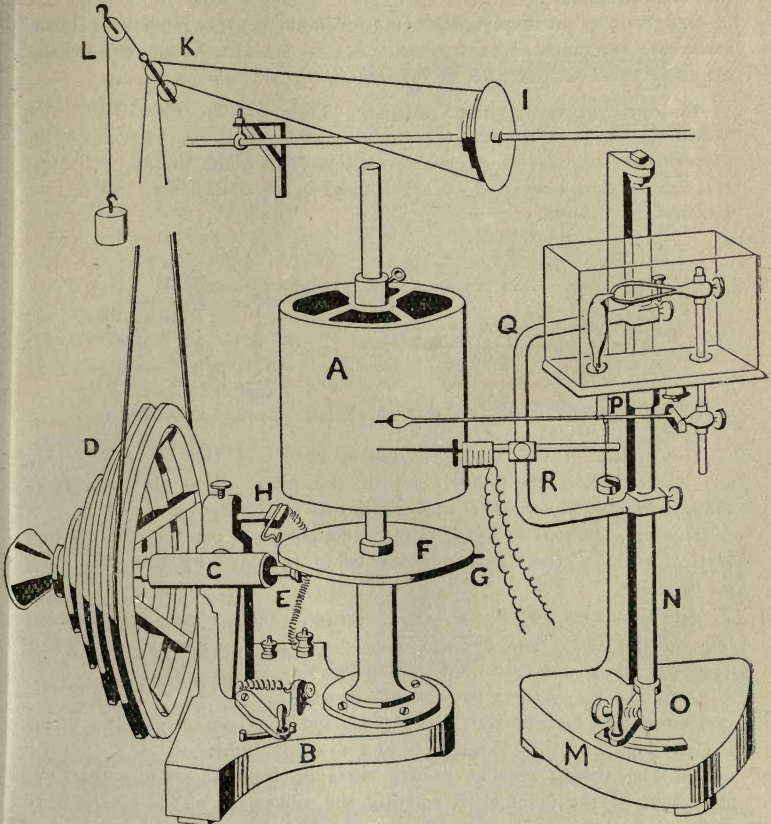

FIG. 34. Cylinder, general stand and driving cord.

a roller **E**. The bearings which support this axle are pivoted to an upright on the drum stand, and an arm **B** actuates the rocker in such a fashion as to start and stop the drum without arresting the movement of the driving pulley.

3. Automatic contact. A pin **G**, which projects from the edge of the drum disc, strikes against a wire **H** once in the revolution of the drum. This wire is so bent as to allow the pin to pass in either direction. In setting the contact it must be made as short as possible, so that the make and break shocks which are produced may be fused into one stimulus.

One contact in a revolution is sufficient for the purposes of these exercises, but another arrangement can be substituted which allows of single or successive stimuli at different intervals.

Recording arms and points. Thin wooden rods 2^{mm} thick armed at one end with an aluminium point **A** of the accompanying pattern, the actual end of which consists of a glass thread 1^{cm} long. Its end is glazed to perfect smoothness in a small flame, and is then attached by cement.

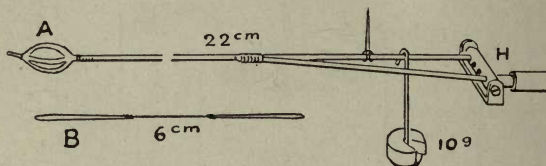

FIG. 35. H Hinge. A Writing point. B Silk double loop.

Two pieces of the wooden rod, one 22^{cm} and the other 8^{cm} long are inserted into the outer holes of the hinge piece of the muscle-chamber and held together with thread as in the figure.

This arrangement is light, strong, and possesses great horizontal and vertical rigidity, the necessary play being provided by the aluminium point.

Attachment of the muscle to the recorder. Tie a piece of silk thread (Fig. 35, B) (fine plaited roach line is best) into two loops each 2.5^{cm} long, the whole not to exceed 6^{cm} in length

Draw the knots tight to prevent stretching.

Fasten one end to the lever by placing one loop round the latter and passing the other through it and draw it tight.

Let the thread rest at such a distance from the hinge that the movement of the point shall magnify the movement of the muscle four or five times.

Pass the other end through the hole in the floor of the muscle-chamber and slip it over the hook on the tendon.

Covering the drum. Take a sheet of the ready cut glazed paper from the tin on the shelf of the varnishing table (Fig. 36) and lay it,

glazed surface down, on the table; wrap it evenly round the cylinder, and fasten it on tightly by means of the gummed edge after the manner of a newspaper wrapper.

Smoke the surface of the paper. A special chamber (Fig. 36), which prevents access of smoke to the room, is provided in the wall of the laboratory.

Take the spindle **A** from the chamber, mount the drum upon it, clamping screw to the right, and place in the chamber.

Uncover and light the wick (6 inch) of the lamp beneath the smoking chamber, adjust the flame so as to cause a uniform sheet of smoke to play upon the paper. Close the door **C** of the chamber, revolve the cylinder at about once a second. Inspect through the door from time to time, and extinguish the flame when the paper is uniformly covered with a deep brown covering of soot. The covering must not be thick on account of the resistance which it offers to the writing point. Therefore stop short of complete blacking.

Injury to the blacking on the cylinder when withdrawing it from the chamber is prevented by the guides.

The natural draught may be so great that it may be necessary to keep the aperture at **D** open. In case of a down draught there is a ring burner in **D**, by means of which the upward current can be ensured.

The chronogram. Though a time tracing may be inscribed by means of a point attached to a tuning fork or other oscillator, writing directly upon the recording surface, an electrically driven style is the

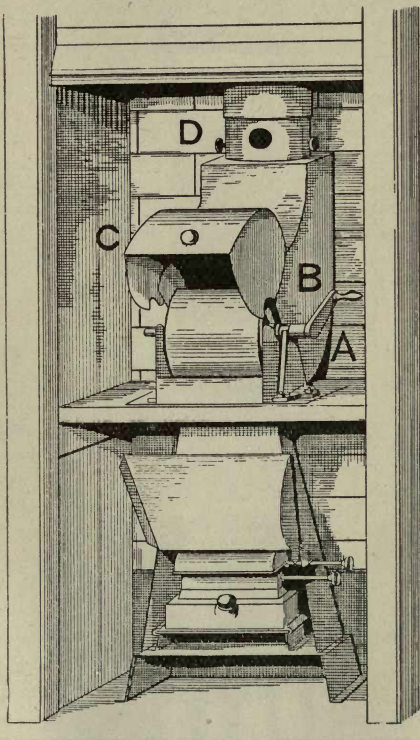

FIG. 36. Smoking chamber.

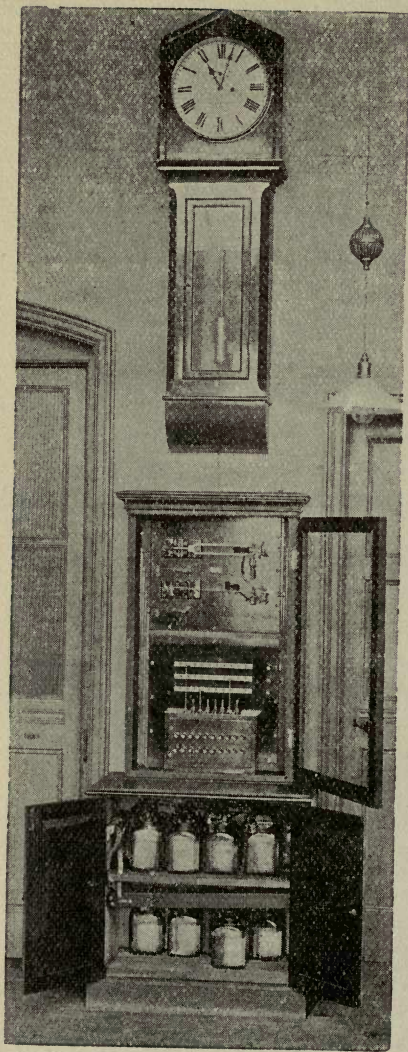

FIG. 37. Time distribution board as set up in the laboratory.

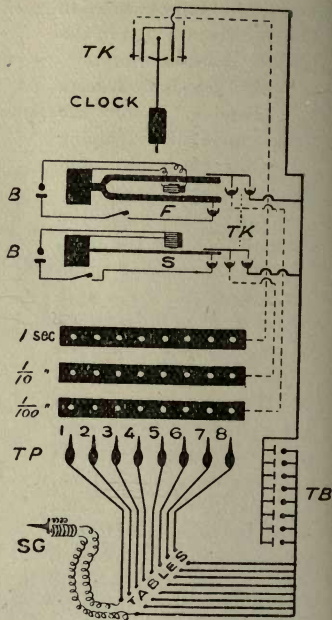

FIG. 38. F 96 a sec. tuning fork
S 10 a sec. spring, B; B their driving
batteries, TK keys carried by F and S
bridging the table circuits (mercury
cups) and dry contact in the clock.
TB main table circuit battery joined in
parallel as required, SG electric style,
TP plugs numbered to correspond
with the tables and by means of
which the style is placed in circuit
with TK of either clock, F or S.

most convenient. The apparatus consists of (1) the time giver and (2) the repeater, or style, which writes upon the recording surface.

For the purpose of supplying a number of workers simultaneously the following device is adopted in this laboratory:—

A time distribution board is placed against the wall, which consists of a clock, the pendulum of which beats seconds. In the case below are a tuning fork which oscillates 96 times and a spring oscillating 10 times a second.

Both the latter are kept in action by independent Leclanché batteries (one quart cell to each, two are available in case of need).

The clock, fork, and spring control a main table circuit, which consists of a battery of ten Leclanché cells, the leads of which branch to the tables, where they terminate in fixed binding screws.

A worker at any of the tables can, after connecting an electric style to the binding screws of his table, select any of the above time fractions by placing the plug which corresponds to his table number into the brass bar of the time board.

The accompanying diagram explains the method.

Electric style. *Chronograph.* This consists of an electro-magnet, to the armature of which a writing point is attached. The latter is drawn away from the magnet by means of a spring, the tension of which is overcome whenever the current passes through the coil. The core of the latter is made short and of electrolysed iron, so that it shall have no magnetic memory, i.e., will demagnetise the moment the current ceases to flow through it.

The form used is Smith's style, which possesses the great advantage of having a low resistance, its coils being wound in parallel and in having its armature placed at the end of a comparatively long arm. The result is that it possesses a quick response and the "lost time" is very short, even though comparatively small electrical power be employed.

Muscle chamber. (Fig. 34.) A wooden floor, with a glass cover, having a screw nut underneath for attachment to a bracket P on the pillar of the general stand.

A brass upright pierces the floor and carries within the chamber a clamp for holding the femur of a muscle preparation, and beneath a hinge-piece to which the writing arm is fixed. These are adjustable vertically and laterally. Care should always be taken to set the arm horizontally at the commencement of a record.

Inside the muscle chamber are also platinum and non-polarisable electrodes upon a horizontal bar, not shown in the figure.

General stand. (Fig. 34.) A heavy foot supports an upright, to which a stout pillar of steel N is pivoted between centres.

This pillar can be turned by means of an arm **O**, which moves against a ridge with a stop at its end above **M**. When setting writing points always bring the arm up to this stop. The points can then by moving **O** be removed from the writing surface, and can be returned to it without losing their setting.

The pillar carries a bracket **P** for the attachment of muscle chamber or frog-heart recorder, for which purpose the latter carry clamping screws. An extension piece is sometimes useful, which fixes to the bracket and the above for more convenient adjustment of points when very short writing arms are employed.

The side bar **Q**, a rod bent D shape is also carried by the pillar for use with time marker, &c. (See Figs. 34, 40.)

Fixing Tracings. The soot is fixed to the paper by means of resin (15 p.c.) dissolved in methylated spirit.

Free the paper from the cylinder, so as not to touch the smoked side, as follows:—Remove the cylinder from its axle, hold it with the left hand

horizontally and rest the clamping boss upon the edge of the table, place the thumb of the left hand on the overlap of the paper, and pass the point of a sharp knife under it along the line of junction, keeping the cutting edge turned away from the cylinder.

The detached end of the paper should fall clear of cylinder and table, still held by the left thumb. Raise the cylinder and paper over the table and lay the paper down, smoked surface uppermost.

Next fill in such written details as may be desirable concerning the manner of carrying out the experiment, date, name, &c., writing with a smooth point through the blacking.

Take your tracing to the *varnishing table*, place a pool of varnish one inch deep in the trough. Hold the paper by both ends, smoked surface uppermost, bring the hands together so as to form the paper

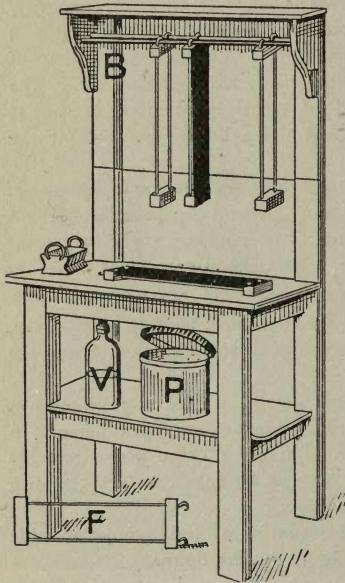

FIG. 39. Varnishing table. **P** paper. **V** varnish. **F** frame. **B** hanging rods.

into a loop, and dip its centre into the varnish. Guide it from end to end through the latter until the whole is saturated, and drain off the flowing varnish by holding the paper by one end and touch the blank side of the other against the edge of the trough. Transfer to the drying frame, and fasten with pins. Hang the frame by its hooks on the rods of the table. The tracing will be dry in about 15 minutes. When dry, cut out the portion which is to be preserved and paste it into your book on the blank page provided for it.

EXPERIMENTS ON MUSCLE (WITH RECORDS).

Extensibility and elasticity of muscle.

Required.—General stand with muscle chamber, drum, ten 10^s weights (split lead), nerveless muscle preparation.

Set up as follows:—Attach the muscle by its femur to the clamp, and fasten the tendon by a silk thread to the recording arm, clear of the aperture in the chamber floor. Place moist blotting paper on the inner side of the glass cover, and put the latter into position.

Adjust the writing arm horizontally and set the pillar arm against the stop; apply the writing point to the drum; this adjustment should always be made near the paper overlap.

Suspend the hook, to carry the weights, from the writing arm close to the muscle attachment.

Turn the cylinder by hand for 2 or 3^{cm} so as to write a short abscissa. Return to the starting point.

Next add successive weights; after each let the muscle attain its full extension, and then move the recording surface 7 or 8^{mm} onwards before adding the next weight.

The muscle will extend less with each additional weight.

When all the weights have been applied, proceed to remove them after the same fashion.

The muscle will shorten by elastic reaction, which towards the end is very slow in effecting complete restoration.

Extensibility of muscle increases during contraction.

Required.—General stand with muscle chamber, drum, inductorium, Leclanché cell, 2 keys, 7 ordinary and 2 thin wires, nerveless muscle preparation, ten 10^s weights.

Set up as follows:—Arrange for single shocks, connect the **S** circuit to the outer terminals of the muscle chamber and substitute the fine wires for the electrodes. Clamp the muscle into position and attach it to the writing arm, and make one of the thin wires fast to the femur, and the other to the tendon; the second wire must not constrain the muscle.

Choose single induction shocks to produce strong contractions.

Take only the break shocks, e.g., close the **S** key each time before closing the **P** circuit, and open the former again before the **P** circuit is opened. These evolutions should be performed in rapid succession, so as not to keep the **P** circuit closed for long (to ensure equal stimuli).

Apply a weight, let the muscle extend fully, turn the drum by hand some 7^{mm}, stimulate the muscle; it will draw an upstroke and will on relaxation be extended below the line from which it started. Turn the drum onwards for the same distance as before, add another weight and repeat the process until all the weights have been added.

Examine the tracing and compare the passive extension due to the application of the weight with that which accompanies relaxation after each contraction.

Single muscular (isotonic) contraction and latent 8 period, with direct excitation of the muscle.

Required:—Muscle chamber on stand, inductorium, electric style, 2 Leclanché cells, 3 keys, 10 wires (two of them fine). Drum to fastest speed. Muscle load 10g.

1. Set up for *single induction shocks* and include the drum contact in the **P** circuit. See that the contact is very slight, so that the make and break shocks may be fused into a single stimulus. Keep **S** key closed until the time of stimulation. Detach the platinum electrodes from their binding screws in the muscle chamber and substitute the fine wires for them.

2. Attach the *electric style* to the side bar of the stand and wire it to the table binding screws. Include a key in this circuit. Put the plug corresponding to your table number into the 96th seconds of the time-board, close the key, and ascertain that it works properly. The time record may be written directly beneath and simultaneously with the muscle curve if great exactitude is required. It is not necessary to do so in the present case, as the drum will revolve with a constant speed during the performance of the experiment, which only takes a short time to carry out. It may be inscribed immediately before or after the muscle tracing.

3. The *muscle preparation* is made as previously directed, but the nerve is cut off close to the muscle (*nerveless* muscle).

After fixing to the clamp, connecting the tendon to the writing point, and applying the load, hook one thin wire round the tendon and one round the femur. The former must not impede the movement of the muscle nor draw it to one side. The wire should be wound into a spiral.

4. *Mark the paper* overlap at the top by sweeping off some of the blacking with your finger. This is to act as a guide for the application of the writing points when the drum is revolving.

Set the latter so that the drum contact shall occur when the writing points are clear of the overlap by 10^{cm}.

5. *Adjust the writing points*:—Draw the stand clear of the drum, push the handle which rotates the pillar up to the stop, see that the muscle chamber is firmly fixed. Arrange the points of muscle and time recorders to write in the same plane and as near to each other as possible, draw the drum up to the stand until the recorders are in equal contact with

it. They must write on the same vertical line. Make these adjustments on the paper close to the overlap so as not to encroach on valuable space. Remove the points from contact with the paper by turning the pillar arm; the points will fall back into position when the arm is again brought up to the stop.

6. *Take a record.* Start the style by closing its key; start the drum, let it run round three times so that it may settle to its speed; open the S key, note if the muscle gives a good contraction, and if it does, apply the points to the paper the moment that the guide mark comes into view, and lift them off again on its next appearance. The record thus lasts for one revolution only.

Examine the curve:—The muscle, if unfatigued, will record an even sweep upwards to a summit and a symmetrical fall. The lever will not return at once to the line from which it originally started, but after the first symmetrical fall will exhibit a slower contraction remainder. This is not always a smooth descent, but frequently consists of several oscillations, the first of which falls below the abscissa to rise above it again. This may be repeated several times in very vigorous muscles. They disappear with fatigue. Should the upstroke of the curve show an indentation on its ascent or a double crest, the drum contact is at fault and should be reset, because the opening shock has been delayed through the length of the contact, and two separate stimulations are being produced.

7. *Measure the latent period.* Turn the style aside to prevent it writing, and replace the muscle lever in contact with the paper at the beginning of the tracing. Carry an abscissa beneath the whole length of the former. Lift the

point off again, bring the paper to the starting point and re-apply. Open the **S** key, close the others, and slowly turn the drum by hand until contact occurs; the muscle lever writes an upstroke. This is the moment in the tracing at which the stimulus was given. Turn off the muscle recorder, close **S** key. Next mark the exact position at which the recorder began to rise, and measure the interval by comparing it with the time tracing.

The latter consists of oscillations in which each down stroke of the style is a sharply defined descent. The intervals between these are 96th parts of a second; estimate fractions by the eye.

9 Tetanus. *Summation of muscular contractions.*

Required:—Drum, muscle chamber on stand, inductorium, variable spring, 2 Leclanché cells, 8 wires. Drum at a middle speed. Nerve muscle preparation, with indirect stimulation.

Set up:—**S** circuit as usual, **P** circuit with the variable spring in the position of the usual break key; it is to act as a mercury key.

1. First record two or three muscular contractions clear of each other, but on the same line, by making and breaking the **P** circuit. Do this by pressing the needle of the variable spring in and out of the mercury cup.

Next throw several stimuli in rapid succession into the nerve, moving the spring by hand as before; these will succeed each other irregularly, but will be sufficiently rapid to cause the contractions to follow each other, so that the muscle has not time to relax completely before the next stimulus reaches it.

2. The spring will now be caused to oscillate at its slowest speed (10 per sec.), sliding clamp placed furthest from the end, so as to give a number of stimuli at regular

intervals. As the spring will give only a limited number of contacts, let your co-worker manage it whilst you attend to the muscle record.

Keep the point off the drum until ready. Give the sign for the spring to be set in operation, and at once bring the point to bear upon the paper. Open **S** key and close it again as soon as about 10 contractions have occurred. When the curve has fallen, lift the point off the paper.

The contractions will follow with regularity, and the curves as they succeed each other will have the same height, but will be cut short in their descent. The second contraction of the series may be higher than the first, and the remainder will be of the same height as the second.

Take two more tracings, one with the clamp on the spring half way, and the other with the same at the end of its slide. Clamp firmly in position and re-adjust the needle each time.

The contractions occur more frequently at each shortening, and the third curve, and possibly the fourth may rise higher than before, the whole series being higher. *Summation.*

3. Substitute the interrupter for the spring, the stimuli will be more rapid and the curve will rise higher, be flat topped and free of signs of separate contractions—complete fusion of them having occurred.

It will not always be necessary to use the interrupter, as it depends upon the condition of the frog, as to whether so rapid a succession of stimuli will be necessary to produce complete tetanus.

Fatigue of Muscle.

10

Required.—Inductorium, muscle chamber and stand, two Leclanché cells, 2 keys and 5 wires. Drum at a speed to draw the muscle curve out to 2.5 cm, strong shocks. Nerveless muscle preparation.

Arrange the drum contact in the **P** circuit. Guide mark on paper, **S** key closed after ascertaining that the muscle responds. Load 10^g.

As the muscle (gastrocnemius) is capable of giving several hundred contractions, the gradual transformation of the muscle curve would be obscured by the number inscribed on the paper; therefore only record every 25th or 30th contraction.

Adjust the recorder point to write with an equable pressure, so that there is just enough play in the point to meet the inequalities of the paper when the pillar handle is against the stop. Start the drum.

After the usual few preliminary turns of the drum, open the **S** key and apply the writing point as the guide mark passes, and lift it off again just before the end of the revolution.

Count from this onwards 29 contractions, and inscribe the 30th, and continue so doing until the muscle is exhausted.

The curves will gradually lengthen, the chief change being the slowing of the relaxation of the muscle. The height will fall until final extinction of the contractions occur.

To obtain a second curve use the other limb of the frog.

11 Influence of the load on the work done by muscle.

This may be carried out under the following circumstances:—

1. As a load acting continuously and increased

(a) By the successive addition of separate weights,

(b) By rapid increase in the weight, by causing the muscle to pull against a strong spring (isometric method).

Required:—Inductorium, 2 Leclanché cells, 2 keys, 7 wires, and 2 fine, ten 10^g weights, muscle chamber with fine wires substituted for the platinum electrodes. Nerveless muscle preparation. The drum and **P** key are operated by hand.

By successive addition of separate weights. Adjust the muscle to record a maximal contraction. Take records of successive contractions, moving the drum by hand between each for 5^{mm}. After the movement from each contraction has subsided, turn the drum to a fresh place, half a cm from the preceding, add a 10 gramme weight, and as soon as the extension caused by this is complete move the drum another half cm, stimulate and note that the writing point on extension of the muscle falls below the point from which it started. Proceed in this manner until the muscle curves are extinguished. Compare the relative heights of the various contractions, and make an approximate calculation of the work done by the muscle, in gramme millimetres, by measuring the height of each contraction in millimetres, and multiplying in each case by the number of grammes lifted. The work will rise with increase of the weight up to a certain point, and will then fall.

Isometric method. Contraction performed under a rapidly and equably increasing load.

Required:—Drum, muscle chamber on stand, strong spring fixed to a bar held in a clamp upon the side bar as in Fig. 40, 1. Direct stimulation of the muscle by drum contact. Speed of drum to draw the muscle curve out to 4.5^{cm}. Inductarium, 2 Leclanché cells, 2 keys, 7 wires, and 2 fine.

In adjusting the muscle let it be under slight tension, so that there should be no slack to take up at the first moment of its contraction.

After the first contraction has been recorded, increase the tension by lowering the side bar 2 or 3^{mm}. Readjust the writing point to the original abscissa. Repeat the process after each contraction.

It will be found that, within narrow limits, the contraction will be increased by the magnification of the load, and by

further increase it is diminished. Usually the top of the curve is markedly flattened.

2. **As an afterload.** The experiment is fitted up in the same way as the last, with the exception that the spring is detached from the rod, and the latter is employed as a rest for the recorder, as in Fig. 40, 2. The muscle should be extended without stretching, so that the muscle may have no slack to take up at the beginning of its contraction.

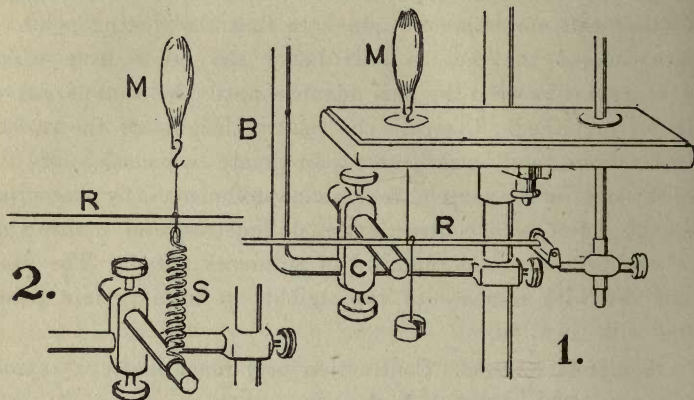

FIG. 40.

1. Arrangement for after-loading. R Muscle recorder. M Muscle. B Side bar
 C Clamp holding the supporting rod.
 2. For Isometric method. S Spring fastened to rod clamped to the side bar.

First load with 10 grammes, stimulate, and when the relaxation is over after the contraction turn the drum by hand for half a cm.

Load with an additional 10 grammes for each successive contraction until all have been added.

The curves as compared with those obtained in the last experiment are much less in height from the first, undergo less increase, and subside sooner.

The muscle is more extensible under increasing loads, and consequently there is more and more "slack" to take up after each increment of weight is added, hence the delay in raising the recorder.

Effect of heating and cooling on the character of the muscular contraction. 12

Required.—Frog-heart support on the general stand, heating cylinder with funnel, and two pieces of rubber tubing 25^{cm} long, vulcanite lid for the well of the cylinder; this has a radial cut in it, so that it can be applied after the muscle is fixed in position. Thermometer, tin can with spout for pouring water into the funnel, tin mug to receive the outflow from the cylinder. Inductorium, 2 keys, 2 Leclanché cells, 7 wires, 10^{cm} fine copper wire for attaching the femur. Drum contact in P circuit, and speed to draw the curve out to 3^{cm}, S wires attached as in the figure. Gastrocnemius with a third of the femur attached.

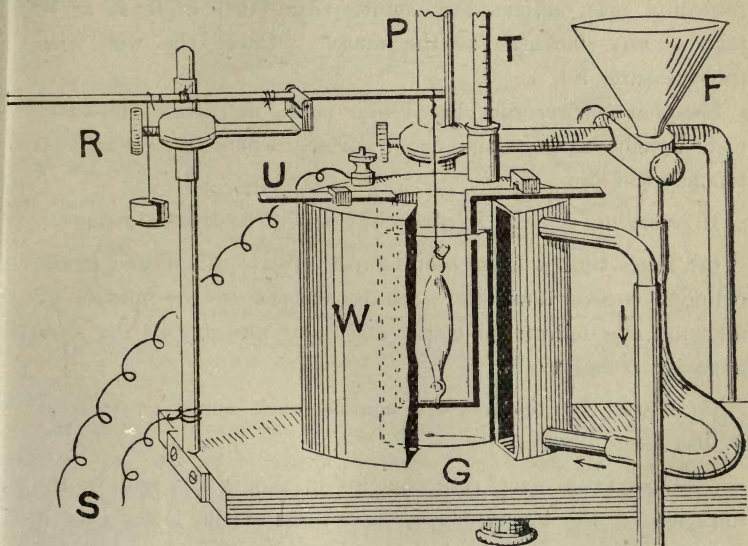

FIG. 41. W Water jacket (cylinder) upon G, the frog-heart support. F Funnel for inflow attached to the side bar of the general stand. T Thermometer. U Bent bar for attachment of muscle, detachable by a side twist.

The femur is connected to one side of the inverted recorder R by a fine copper wire, the writing point is at the other end. In the well above G is a glass cylinder for immersing the muscle in fluid. S Connections of S circuit for stimulating.

Remove U, place the cylinder in position on the frog-heart support (as shown in Fig. 41), with a little normal saline in the glass, to keep the muscle from drying.

Lay **U** on a plate and attach the muscle by its tendon to the hook, fasten the fine copper wire to the fragment of the femur by wrapping it firmly several times round the bone and then twisting the wire upon itself. Straighten the wire in line with the muscle, so that the latter may pull directly when attached to the recording arm (aluminium).

Then holding **U** by each end and the copper wire so as to keep the muscle in position, replace and fix **U** in the well of the cylinder. Secure the free end of the wire to the recording arm, adjust the counterpoise (10^8) at **R** so as to take up any slackness of the muscle. Cover the well with the vulcanite lid.

See that the recorder has a fine point, and that the latter rests lightly against the drum surface when the pillar arm touches the stop.

In carrying out the experiments attend to the following:—

(a) Each time a change of temperature is established in the cylinder ensure that the same is effected in the muscle by allowing one minute to elapse after the mercury in the thermometer comes to rest.

(b) Mark the temperature against each curve as soon as it has been drawn.

(c) Observe in each case changes in the height and in the duration of the muscle curve, and note in the latter case if the contraction or the relaxation is most affected.

(d) If the temperature of the muscle be too suddenly and largely changed, the muscle may pass into continued twitchings; these will pass off. The suddenness of the change acts as a stimulus.

1. Take a tracing at the temperature of the room as a control experiment.

2. Cool the muscle by filling the cylinder with water at the required temperature. Take successive tracings at 8° , 6° , 4° , and 2° C.

3. Warm the muscle, taking tracings at every 3° C rise, above 10° C. Inscribe these curves upon a portion of the recording surface immediately below the record of No. 2.

Curara experiment. *Direct excitability of muscle.*

13

Required:—No recording. Inductorium, 2 Leclanché cells, 2 keys, 3 ordinary and 2 thin wires, hand electrodes, waxed paper, narrow tape and a 1 p.c. solution of curara in water (filtered).

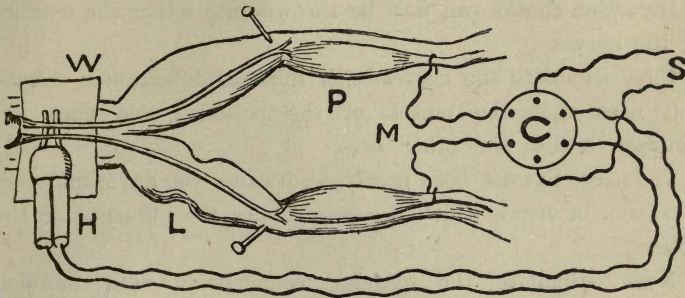

FIG. 42. P Poisoned limb. L Seat of ligature. W Waxed paper under the nerves. C Commutator, less cross wires; wired to S circuit, outleads M to muscle, H to hand electrodes.

Decerebrate the frog and plug the opening into the skull firmly to prevent bleeding. Having ligatured the middle of one thigh firmly with tape (unpoisoned limb), so as to stop the circulation, but not to crush the nerve, inject 5 drops of curara solution into the dorsal lymph sac, half or three-quarters of an hour before required. Wait until the poison has produced its effect, i.e., until reflexes excited in the poisoned limb are absent.

Expose both sciatic nerves throughout their whole lengths, and remove the urostyle; carefully introduce beneath both of them as high up near the spinal column as possible a piece

of waxed paper, upon this place the nerves on the hand electrodes.

Fix the knees with pins passed through the quadriceps tendon, and turn the feet out so that their movements may be well seen when the calf muscles contract.

Expose the calf muscles on both sides and attach the thin wires, one to each tendon.

Carry the connection of the hand electrodes and the thin wires to opposite sides of the commutator (less cross wires), wire the inleading terminals to the S circuit.

Induction shocks can now be thrown into either the muscles or the nerves.

First stimulate the nerves with minimal interrupter shocks, and note that the muscle of the poisoned side does not contract, whilst the other does.

The nerve has not been paralysed, because you are stimulating a portion of nerve which has been under the influence of the poison.

Next stimulate the muscles, commencing with minimal shocks and note which muscle contracts first; usually the unpoisoned one does (Rosenthal effect). This is due to the excitability of the nerve in the muscle.

Both muscles respond, hence they are not paralysed.

There remains the conclusion that the end plates of the nerves are the seat of the change.

14 Effect of Veratria upon muscle.

Required:—Recording and stimulating arrangements as for single contraction with direct stimulation of muscle.

Apply a ligature to one leg of the frog in the same manner as for the curara experiment, and inject 10 drops of 1/1000 solution of sulphate of veratria into the dorsal lymph sac. The full effect of the drug will take three-quarters of an hour to develop. When stimulated the poisoned limb will exhibit prolonged contractions.

Prepare both nerve muscle preparations and take successively records of the unpoisoned and poisoned muscles.

If the action of the drug is well developed, the muscular contraction will extend several times round the drum when the latter is at a speed which draws the normal contraction out to 5 cm.

EXPERIMENTS ON NERVES.

Rate of nerve conduction, e.g., *the velocity with which a nervous impulse travels along a nerve.*

Required:—Inductorium, 2 keys, 2 Leclanché cells, commutator less cross wires, double electrodes, electric style, and 12 wires. Muscle chamber, with fine writing point. Nerve muscle preparation, with nerve most carefully dissected and with piece of spinal column attached. Drum at very fast speed.

Set up the P circuit with 2 cells and in drum contact.

Wire the S circuit from S key to the inleading binding screws of a Pohl's commutator, less cross wires.

The two sets of outleading terminals of the Pohl are wired to the two sets of external terminals of the muscle-chamber.

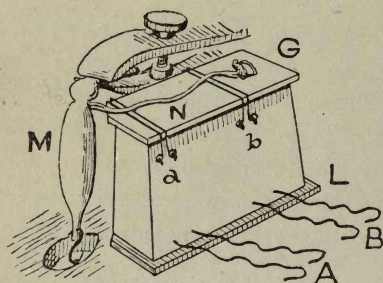

FIG. 43. M Muscle. N Nerve on G, glass-plate across this, a and b, pairs of wires at 2.5 cm interval ending in A, B, for attachment to binding screws of muscle chamber. L Lead plate.

From the latter remove the platinum and non-polarisable electrodes and in their stead attach the double electrodes Fig. 43, so that the two sets of wires shall be connected respectively with opposite sides of the commutator.

When the rocker lies one way it will lead the stimulating current into wires at a near the muscle, and when turned over it will establish connection with b farthest from the muscle.

Set up the style to write 96th seconds under the muscle curve.

Clamp the nerve muscle preparation into position and lay the nerve across the electrodes (2.5 cm.) as in the Figure. If very long dispose it in a curve, and its length can be subsequently measured.

All being ready and the stimulus to the nerve having been tested in both positions of the commutator,

Perform the experiment as follows:—

1. Keeping the **S** key closed—start the drum—apply the style to the paper, the rate should be such as to draw the 96th second trace interval to not less than 1 cm. Adjust the speed accordingly. Make this trial at the bottom of the paper.

2. Apply the muscle recorder and style to the paper overlap and adjust them to write above each other, lift them off. Mark the paper overlap.

Start the drum and inscribe an abscissa and time record during one revolution of the drum, being careful to remove the points before the next revolution begins.

Let the drum continue to revolve from this onwards until the experiment is complete.

3. Two successive muscle tracings will now be taken on immediately succeeding revolutions of the drum, the one as the result of stimulating at **a**, and the other at **b**. This is materially facilitated if your co-worker takes charge of the commutator, and turns it over the moment you give the signal that the first record is complete.

Lift off the points the moment the second record has been taken, and stop the drum.

Next measure the interval between the two muscular contractions. This interval is best measured about midway in the ascent of the curves where they are clear of each other.

Write a second abscissa through the position chosen, and measure the distance between them against the time tracing immediately below.

From this calculate the rate in metres per second as follows:—

The interval is estimated as lying between $1/8$ to a $1/10$ of a $1/96$ of a second time interval. Assume it to be $1/9$.

The nervous impulse has therefore taken $1/864$ of a second to travel 2.5 cm.

In 1 second the impulse would travel 864×2.5 cm = 2160 cm = 21.6 metres. A somewhat low estimate.

16 Rate of transmission of a nervous impulse, *measured by means of the pendulum myograph and the electrical method.*

Required:—Electric style fastened to the side bar of the general stand, muscle break, 2 commutators, inductorium, 2 keys, 4 Daniell cells, and 16 wires.

All the records are made in this experiment with one time marker, which is so connected to the time distribution board and the muscle break by means of a commutator that it can be thrown into line with either of these as required. The movement of the muscle consequent upon the stimulation of the nerve is recorded by the break of the circuit. This circuit whilst closed keeps the point of the style depressed, on breaking the point flies up, making a sharply defined upward stroke, which is more easily read than the muscle curve in the previous experiment.

Set up as follows (Fig. 44):—

1. *Stimulating circuit.* The board of the pendulum carries a projecting arm which, in swinging past, knocks open a closed key. This key is fixed to the floor of the instrument in such a position that the pendulum is travelling nearly at its maximum speed when it opens the key.

This key is included in the *P* circuit of the inductorium (2 cells). The *S* circuit is wired to the inleading terminals of the commutator (less cross wires). The opposite leading out pairs of terminals are wired respectively to the upper and lower terminals of the double electrodes of the muscle break. These electrodes are 2.5 cm apart.

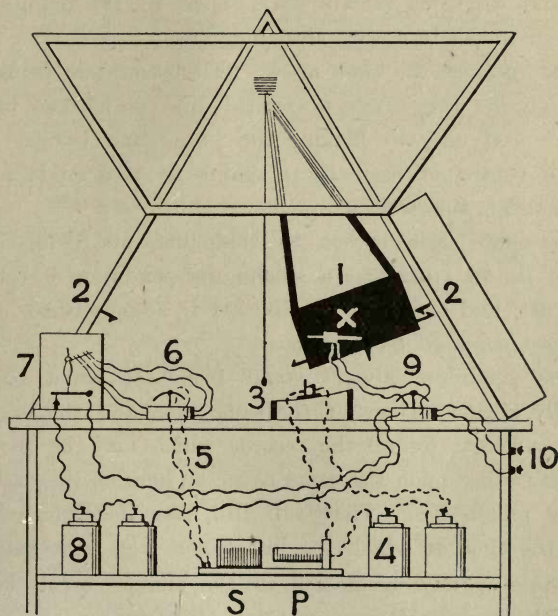

FIG. 44. 1 Pendulum. 2, 2, Catches. X Smoked paper and points to style. 3 Plummet for comparing inscriptions, hooked aside when not in use, to the right knock-open key in *P* circuit 4. *S* Circuit by 5 to Pohl 6, wired to double electrodes in muscle break 7. In latter, muscle is attached to key in circuit 8 to Pohl 9, which latter is wired to style X, and time board 10.

2. *Recording circuit.* Wire the electric style to the inleading terminals of a second commutator (less cross wires) and one pair of the outleading ones to the aluminium key of

the muscle break, including in this circuit 2 cells; the other outleading pair wire to the time board terminals on the right of the pendulum case.

See that all connections are perfect.

To the pendulum board, which is of wood, paper can be pinned. The latter is smoked on a drum and when cool is cut off and will then remain flat. Trim to the required size and fasten in position with drawing pins.

It next receives the time mark. The pendulum being held to the right by the catch, a vertical line is marked upon it at its left extremity by flicking the plum line (which hangs from the centre of oscillation) against it as a guide for the application of the writing points.

The electric style is set to this line, and whilst it is repeating its 96 vibrations a second the pendulum is released, swings past, and the time subdivision is accomplished. *Raise the writing point off the surface.*

As the pendulum always starts from the same point it practically always swings at the same rate, and the one time mark is sufficient for all the records which may be inscribed above each other upon the same paper as long as they all start from the plumb line. They will also have the same relationship to the time at which the knock-open key is actuated.

The style is now connected to the muscle break key by turning the rocker of commutator 9 (Fig. 44).

Close the aluminium key by adjusting the screw counterpoise; and see that the muscle is slightly stretched.

Set the style close above the time record, close the knock-open key, turn commutator 6 to the electrodes nearest the muscle, open the S key and release the pendulum.

Raise the point off the writing surface, return the pendulum to the right-hand catch, close the knock-open key and take

a second record, this time with commutator 6 turned to the more distant electrode.

Read off the difference between the two—this will give the time consumed by the nervous impulse in travelling from the one point of stimulation to the other. Calculate the rate in metres per second as before.

Electrotonus. *Electrotonic variation of nervous excitability.* 17

Required :—Inductorium for single induction shocks, two Daniell cells, Pohl's commutator, muscle chamber with non-polarisable and platinum electrodes, 11 wires, 3 keys. Nerve muscle preparation.

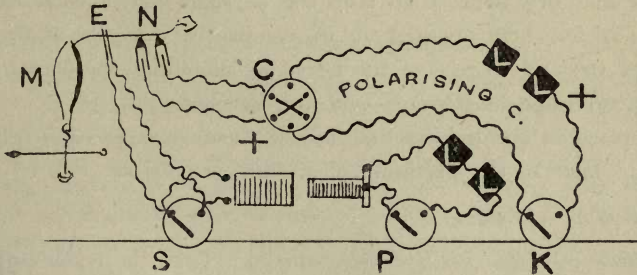

FIG. 45. Electrotonus. Position of keys, &c., on the table. Stimulating circuit P, S to E the platinum electrodes near the muscle M. Polarising key K. C commutator. N non-polarisable electrodes on nerve above E. L Leclanché cells.

Set up as follows (Fig. 45):—

(a) *The stimulating circuit.* Connect the S circuit to the binding screws of the platinum electrodes on the outside of the muscle chamber.

(b) *Polarising circuit.* Arrange as in the diagram. Connect the positive pole of the battery to the key (break) and wire the poles to the commutator C, and the pair of terminals nearest the muscle chamber to the terminals of the non-polarisable electrodes of the latter.

Examine Pohl's commutator, Fig. 23. Take care in attaching the wires to make good contacts, also that there is sufficient mercury in the cups of the commutator to cover the ends of the rocker arms and those of the binding screws that lead into the former.

Prepare non-polarisable electrodes:—Take a large teaspoonful of China clay (Kaolin) and work it into a stiff paste with a little normal saline. Perform the operation upon a clean plate, and with a clean porcelain or horn spatula, avoiding all contact with the fingers. Remove the glass tubes from their holders in the muscle chamber, wash them clean with warm water and dry them, then stop the bevelled end of each with the clay for 1 cm, pressing it in compactly with the spatula. Adapt the end to receive the nerve by moulding the clay into a central ridge lengthways over the bevelled end.

Replace in the holders and adjust them close to each other and as near to the platinum electrodes as possible.

Proceed as follows:—

Influence of the positive pole (anode). Turn the commutator rocker so that the positive pole leads to the non-polarising electrode nearest the muscle. Keep key **K** open.

2.—Find the minimal opening induction shock which will suffice to cause a muscular contraction.

3.—Close the polarising circuit and stimulate the nerve with the opening **S** shock—there should be no contraction. The production of the anelectrotonic condition (plus pole) has lowered the excitability of the nerve, and the stimulus is now insufficiently strong to excite it.

Influence of the negative pole (anode). Turn the commutator so as to substitute the minus for the plus pole.

Keep key **K** open.

Find the induction shock which is just too weak (subminimal) to stimulate the nerve.

Close the polarising circuit and stimulate—the muscle will contract. The influence of the kathode has raised the excitability of the nerve, so that the previously inefficient stimulus is now sufficient to excite it.

Instead of using induction shocks, the nerve may be continuously stimulated by applying a drop of strong salt solution to the nerve in the same position, producing "salt tetanus." A record can be taken, and the influence of the plus and minus poles is indicated by changes in the height of the contraction.

Pflügers Law. Polar excitation of nerve.

18

Required:—Rheocord, commutator, 1 key, 7 wires, and 4 or 5 cells (Leclanché or dry cells). Muscle chamber on stand and drum.

The Rheocord (Burdon Sanderson's pattern) consists of a platinum iridium wire of about 20 ohms resistance, arranged for compactness in zig-zag upon a board, and ending in screw-down terminals at each end. A movable block **B**, with terminal, is for the purpose of establishing contact at any point with the wire. The appliance is used in short circuit in this experiment, and in such a manner, see Fig. 46, as to vary the potential at the non-polarisable electrodes.

Owing to the large resistance of the nerve, 1cm of which is approximately equal to 80,000 ohms and non-polarisable electrodes 700 ohms each, very little actual current passes, and it becomes a question of polarity.

The copper leads are of insignificant resistance. When the rheocord is out of circuit (with block off), the potential at the clay electrodes is little less than that at the poles of the battery.

As soon as the rheocord is introduced, a great drop of potential occurs at the electrodes.

Set up the connections as shown in Fig. 46. Mark the position of the rocker of the commutator when the plus pole is at the non-polarisable electrode nearest the spine (descending current). On reversal the plus pole will be nearest the muscle (ascending current).

The potential at the electrodes on the nerve is varied by short-circuiting through the derivation circuit formed by the rheocord.

Three strengths of potential will be sought for in order to obtain the following result.

The following is given as an approximate guide:—

1. Weak:—One cell with the block of the rheocord close to the return terminal.

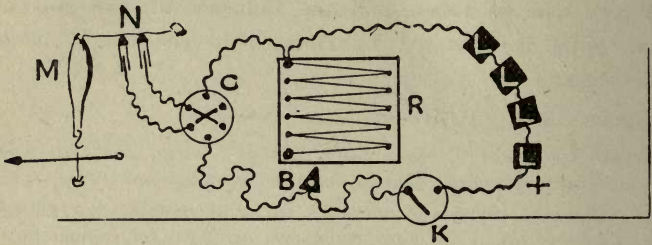

FIG. 46. Pflüger's Law. L Cells. K Key. B Movable block off R, short circuits when placed on rheocord wire R. C Commutator. N Non-polarisable electrodes on the nerve. M Muscle.

2. Medium:—One or two cells with the block on the second or third stretch of the wire from the return terminal.

3. Strong:—Three or four cells with the block off the rheocord.

Modify the current so as to obtain the following results:—

	Ascending current.		Descending current.	
	Make.	Break.	Make.	Break.
Weak ...	C	—	C	—
Medium ...	C	C	C	C
Strong ...	—	C	C	—

Explanation:—Excitation is either due to production of katelectrotonus or to disappearance of anelectrotonus.

The former is the more efficient stimulus.

With a weak current the kathode is alone operative. With a medium one both are operative as stimuli, whilst at the same time the anode is not powerful enough to block the excitation due to the katelectrotonic stimulus. With the strong ascending C, the anode blocks at make, but stimulates by its fall at break.

In the case of the strong descending, the kathode has nothing to block its action at make, but at break the fall of excitability on the disappearance of katelectrotonus is held to block the stimulus due to the fall of anelectrotonus.

ELECTRICAL MANIFESTATIONS IN MUSCLE
AND NERVE.

Demarcation and action currents.

Required:—Astatic galvanometer (permanently set up and adjusted on a stone shelf on the wall of the dark room). Non-polarisable electrodes on movable supports. Shunt or resistance. Block of paraffin. Inductorium and platinum electrodes on stand. Nerve muscle preparation.

Set up as follows:—Wire the non-polarisable electrodes to the shunt or resistance in short circuit and thence to the galvanometer. Observe the notice that if the north binding screw of the galvanometer be positive, the spot of light will be deflected to the left, and *vice-versa* (Fig. 47).

Support the nerve muscle on the block of paraffin and adjust the nerve across the platinum electrodes and connect the latter with the circuit of the S inductorium. The last should be placed not less than three feet from the galvanometer.

Light the lamp and place it so that the reflected spot of light shall be as brilliant as possible with the vertical wire in focus.

Test the electrodes to see if they yield a current. Place their points in contact, and close the circuit through the galvanometer. If they do, the spot of light will travel away from the middle of the scale to one side or the other. Note the amount of the deflection, and if it be more than a couple of cm, fresh electrodes must be prepared. If slight, note its amount and direction.

Place one electrode in contact with the centre of the surface of the muscle, and the other near the tendon. Close the

galvanometer circuit. Note, from the direction in which the spot moves, which of the two points of the muscle touched by the electrodes is positive to the other.

Now stimulate the nerve with interrupter shocks of just sufficient strength to tetanise the muscle, and observe that the previous deflection is diminished. The action current is opposed in direction to the demarcation current.

Next cut off the end of the muscle near the tendon, and apply the electrode to the artificial cross section; the deflection may be so great as to throw the spot off the scale. Bring it back by putting a plug into the shunt so that only a fraction, i.e., $1/10$, $1/100$, or $1/1,000$, passes to the galvanometer. The shunt makes a proportionate short circuit.

Again stimulate the nerve, the movement of the spot in the contrary direction will be more marked.

Currents in the frog's heart. Excise the entire heart, including the sinus, dispose the electrodes close to each other so that the heart may rest with its base upon one of them, and the apex on the other.

Close the galvanometer circuit between the beats and observe that there is a deflection (demarcation current), which undergoes a sudden diminution at each contraction (action current).

Current from the nerve. Remove the two sciatic nerves, cut them as long as possible, and arrange them across one electrode with both ends of each hanging down and touching the second electrode.

Close the galvanometer circuit and note the deflection. The longitudinal surfaces of the nerves are positive to their ends.

The cut end of a nerve is in a state of katelectrotonus, due to changes accompanying the death of the nerve.

Capillary electrometer (Fig. 47, 2). Repeat the previous experiment with this instrument instead of the galvanometer.

Requirements the same as before, and couple the wires from the electrodes to the terminals of the electrometer.

The latter is set up on a bracket on the wall of the dark room, and consists of a glass tube drawn to a fine

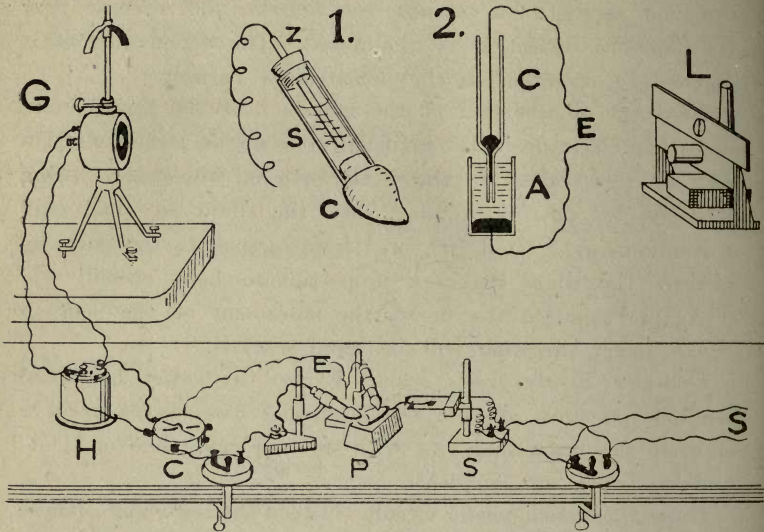

FIG. 47. G Galvanometer. L Lamp and scale. H Shunt. C Commutator with leading-in terminals in circuit, with E Non-polarisable electrodes. P Paraffin block supporting a muscle, the nerve of which rests on platinum electrodes S connected to S circuit of inductorium.

1. Non-polarisable electrode. C China clay point on glass tube S containing saturate zinc sulphate solution. Z Zinc rod (amalgamated) corkscrewed into place.

2. Diagram of capillary electrometer. C Glass tube with capillary end, containing mercury (black), dipping into 1 in 10 sulphuric acid A. E Wires of platinum in the electrometer, attached to "leading-off" electrodes. There is an arrangement for exerting pneumatic pressure on the mercury in C to adjust its position in the capillary. The mercury moves in the direction of the negative pole. The electrometer is substituted for the galvanometer and shunt in the first arrangement by attaching its wires to the commutator C.

capillary end, in which there is mercury, and which dips into a small trough containing 10 p.c. H_2SO_4 . There is a small pool of mercury in the latter also. The terminal wires dip into the mercury in each case.

The position of the thread of mercury in the capillary is controlled pneumatically by means of a small mercury pressure apparatus. The meniscus of the mercury is observed through a microscope with a power of 100 diameters.

The terminals of the electrometer are provided with a short-circuiting key, which is to be kept closed when the instrument is not in actual use.

The less the diameter and length of the capillary, so much the greater will be the sensitiveness of the instrument.

Only small electrical pressures may be exerted upon the mercury in the capillary, and an ordinary cell must on no account be placed in its circuit unless high resistances are included at the same time, as bubbles of H gas and crystals of mercury sulphate will separate with the current from a single Leclanché, thus rendering the capillary useless.

The movements of the meniscus are sudden and dead beat, and the mercury always moves away from the plus pole in proportion to the electrical pressure exerted.

The instrument is used as a pressure detector and not for measuring current, and the quickness of its response makes it the only means for detecting small and rapid variations in the electrical condition of animal tissues.

The condition and changes of potential already referred to in the previous exercise are readily confirmed by its aid.

ON THE CIRCULATORY SYSTEM.

Beat and sounds of the human heart.

Feel the apex beat. Place the points of the fingers of your hand upon the fifth intercostal space on the left of the sternum and feel the movements of the heart.

Count the rate of pulsation in the minute by your watch.

Note the character of the impulse and its variations with the respiration and the posture of the body—sitting, standing, and in the reclining position. Count the number to each respiration.

2. *Listen to the sounds of the heart with a stethoscope (binoral).* The phonendoscope is the best form of this instrument. It consists of a heavy metal disc excavated upon one side, over this a vulcanite diaphragm is fixed. Two rubber tubes are attached to the other side by short metal tubes, and their free ends by ear-pieces to each ear. One hand holds the instrument.

Seat yourself opposite the subject and hold the diaphragm against the surface of the chest, a little to the sternal side of the apex beat and clear of clothing, which must not be allowed to rub against the instrument.

Distinguish between the two sounds. The longer one corresponds to the ventricular systole, the sharp second sound to the closure of the aortic and pulmonary valves.

3. *Trace a cardiogram.* The cardiograph consists of two pneumatic tambours connected by an india-rubber tube.

The tambour for the heart is provided on its rubber membrane with an ebonite button, the capsule rests on the chest wall and is secured in position by an elastic girth.

The recording tambour carries a recorder for writing on a smoked surface.

The tube which connects the two is provided with a brass valve to regulate the air tension in the system.

Place the button of the heart tambour over the apex beat on the bared chest of the subject, who is seated on a chair.

Let the drum revolve at a medium speed, and apply the recorder to its surface and take half-a-dozen curves. Adjust to get a maximum tracing.

The curve will present four well-marked features:—

(a) A slow rise—the heart is distending—immediately followed by

(b) A rapid rise—the ventricular systole—which passes into

(c) An irregular plateau, at the end of which occurs the closure of the semi-lunar valves.

(d) A descent—the heart loses redundancy. Diastole.

Next repeat the cardiogram, together with a pulse tracing written below it. Use the sphygmographic tambour belonging to a Brondgest pantagraph, and adjust it to the wrist over the radial pulse. Fix into place with tapes. The wrist must be supported on a properly shaped pad in a slightly over-extended position. The arm must be unconstrained and the muscles relaxed. Adjust the pressure of the tambour button by means of the screw which regulates the tension of the spring until the maximal excursion of the recorder is produced.

Let both points write vertically beneath each other.

Inscribe a $1/10$ second trace below them.

Take a record for one revolution of the drum only at a time.

Note carefully the relative position of the dicrotic wave in the pulse curve to the end of the systolic plateau of the cardiogram, and estimate the time interval by which they are separated. This interval corresponds to the time which the pulse wave has taken to travel from the aortic valves to the wrist. Measure approximately this distance in centimetres by means of a tape measure, and from these data calculate the rate of propagation of the pulse wave per second.

The length of the pulse wave can be determined by multiplying its rate of propagation per second by the time which it takes to pass a given point, e.g., the time which it takes to pass the point at the wrist to which the sphygmograph has been applied.

21 The pulse tracing, with Dudgeon's sphygmograph.

Place the wrist of the subject in position upon the pad.

Mark the point over the radial where the pulse is most distinctly felt, and rest the button of the spring of the sphygmograph upon the chosen point, and secure in position with the tape.

Adjust the pressure of the button upon the artery by means of the eccentric until a maximal excursion of the recorder is obtained.

Wind up the clockwork, insert a strip of smoked paper between the guide wheels, and let the paper travel past the recording point as soon as the latter moves regularly.

Examine the tracing:—The first part of the curve is a main upstroke, devoid of secondary oscillations, upon the descent is the dicrotic wave, preceded by the corresponding notch.

The other features consist of secondary oscillations, which vary according to the tension of the arterial wall and the inertia of the instrument.

A *hard pulse* shows many of these, owing to the quick elastic reactions which accompany the greater state of tension.

A *soft pulse*, on the other hand, shows less height of curves, less acuteness in the angles, and a less number of secondary oscillations.

Blood Pressure. Estimate this by means of the sphygmometer (Hill & Barnard).

See that the column of fluid stands at zero. To adjust this, hold the instrument vertically, open the tap at the top, and press the rubber ampulla gently upon the surface of a table, supporting it with both hands to control your movement, and closing the tap the moment the fluid stands at zero.

(a) *Artery.* Press the ampulla upon the radial until the maximum pulsation of the column of fluid is obtained. The pressure will then be the same inside and outside the vessel, e.g., in the sphygmometer, and its magnitude is read off on the stem, which is graduated in terms of millimetres of mercury.

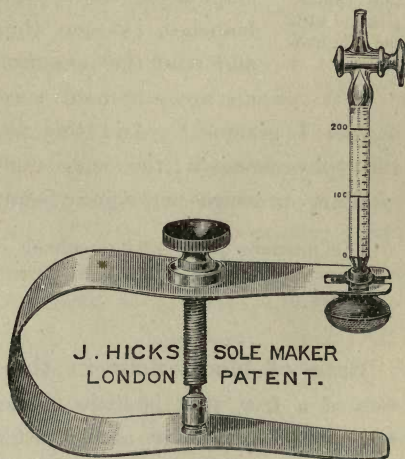

FIG. 48. Hill & Barnard's Sphygmometer.

(b) *Vein*; choose one of the large veins on the back of the hand, and find the positions of two valves in its course. Place the hand flat on a chair close to that upon which the subject is seated. Hold the sphygmometer upon the distal valve, and empty the vein above by pressing a finger along it heartward, and determine the pressure which must be exerted to prevent the vein from filling from the periphery. This will just balance the blood pressure.

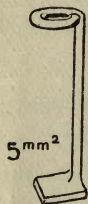

FIG. 49.
Glass Staff
for taking
the capillary
pressure with
the sphygmo-
meter.

Pressure in the capillaries. Lay the subject's hand palm down on the table, rest the square end of the little glass staff upon the skin at the root of the nail of the middle finger, and press upon the upper end of the staff with the ampulla of the sphygmometer until the skin just blanches, as seen through the end of the staff, and read the pressure. The end of the staff has an area of half a centimetre square and itself weighs 1 gramme.¹ Add this to the pressure indicated by the sphygmometer; the sum multiplied by four gives the capillary pressure per square centimetre.

The pressure of a vertical column of mercury one millimetre long and one quarter of a square centimetre in section, presses with a force of 1.359 g.

Rate of blood flow in the capillaries. Arrange the web of a frog that is little pigmented under the microscope under the high power, and adjust a chosen length of capillary across a space of the eye-piece micrometer, and determine its length.

¹ A column of mercury 760 mm long exerts a pressure of 1.033 kilo upon the square centimetre; e.g., one atmosphere.

Follow the movement of the corpuscles, and practice singling one of them out so as to follow its course from one end of the measured length of capillary to the other.

Adjust a 1/10 second record to write on a drum going at a moderate speed, place a spring key in circuit, so that the style vibrates when the latter is closed.

Depress the key at the moment a corpuscle enters the measured area, and release the key the moment that the passage is completed. From the record estimate the rate per second.

In carrying out the experiment the co-worker should take charge of the writing point, turning it on to the paper when you are ready and off again each time a record is completed.

The Frog heart.

22

Required :—Frog-heart recorder with parchment paper point tipped with a glass filament, general stand, inductorium arranged for interrupter shocks, light electrodes, 2 keys, and 7 wires.

After pithing the frog plug the opening to arrest bleeding

Lay the frog on its back on the frog plate, divide the skin along the middle line for the length of the sternum without opening the abdominal cavity. The sternum is then cut through transversely, leaving a little of the cartilage below undisturbed, and is then completely detached laterally and above, care being taken in doing so to avoid injury to the parts beneath.

A window is thus made over the heart without opening the pericardium or the abdominal cavity.

Next open the pericardium, raise the heart with the glass seeker and find the frenum on its dorsal aspect; this contains the small cardiac vein, divide it and turn up the heart. Note the sinus forming the entrance of the large veins into the right auricle.

Observe that contractions follow each other in the order of *sinus*, auricles, ventricle, and bulb. The ventricle becomes pale and rounded at the systole, each section of the heart diminishing in volume as it empties itself.

Record the movements by *Gaskell's* suspension method.

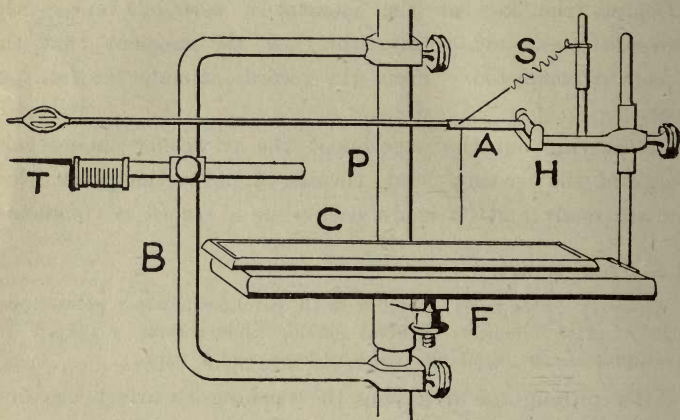

FIG. 50. Frog-heart recorder. **A** Aluminium rod, attached to the hinge **H** and the recording arm. The heart is connected to it by the hanging thread. **S** Counterpoising spring adjusted by the slider on the vertical rod. **F** Wooden base clamped to the bracket on the pillar **P** of the general stand. **C** Loaded cork frog plate. **B** Side bar carrying **T** an electric style.

A fine silk thread about 12^{cm} long, moistened with normal saline, has a single loop made upon it; this is slipped over the apex and is tied so as to include the smallest possible portion of the tip.

This can be done without much difficulty if the ligature be slowly tightened at first around the ventricle until it slips to the exact spot at which it is to be fastened, when it should be drawn tight suddenly. Secure with a second knot. Then place the frog with the frog plate upon the board of the

recorder. Attach the thread by slipping it between the end of the aluminium and the recording arm; friction will hold it firmly. Adjust the counterpoising spring so that the tension may be such as to give the maximal excursion to the lever; see that the latter is horizontal. Owing to the oblique position of the spring, the tension remains almost constant in all positions which the lever will assume. The heart may be stretched to a considerable extent. Drum at slowest speed, 3 or 4 contractions to a cm.

Take a record of the cardiac movements. The contractions will be marked by down strokes, and the tracing may show sinus, auricle, and ventricular contractions. The first is usually absent, and the distinctness of the auricular curve is much affected by the pericardial attachments, which vary a good deal in different frogs. It is necessary to look for and divide any restraining tissue if the movements appear hampered.

Stimulation of the crescent. Find at the sinus-auricular junction, the curved tendinous line of demarcation which has its convexity turned auriclewards. This is known as the crescent.

Use the light pair of electrodes made of thin copper wires, mounted on a cork transfixed by two pins by means of which they are to be fixed to the frog plate. The ends of the wires are to be placed so as to embrace the crescent, apply interrupter shocks and gradually increase their strength. Fairly strong shocks will be required. The heart will at first beat faster for a few beats and then become slowed, and if the stimulus be of sufficient strength, it will be arrested in diastole, i.e., the lever will rise to and remain at zero. If the stimulation be continued, the heart often begins to beat again (vagus escape).

The first few quicker beats are due to the vagus being a vago-sympathetic (Gaskell), and the accelerator fibres are

usually called into action first, the inhibitory fibres exhibiting some delay in manifesting their action. There is much variation in this; winter frogs show it most. The same result obtains if the trunk of the vagus or its cardiac branch be stimulated.

The performance of the latter operation is not considered suitable for these exercises, as the branch mentioned is very small and not easy of access. The dissection necessary to find this nerve is given in the appendix.

23 **Effect of atropine and muscarine on vagus action.**
Next having surrounded the base of the heart with small pieces of blotting paper, bathe its surface around the crescent with *tincture of atropine* by means of a glass rod. Only apply sufficient to wet the surface itself. In a few minutes repeat the stimulation at the crescent, there will be no response. The vagus is paralysed at its termination.

Muscarine. Bathe the heart as before with a dilute solution of muscarine. In a little time the heart will come to a standstill in diastole. This resembles forcible action of the vagus. If too much atropine has been used, the effect will not manifest itself.

Again bathe the heart with atropine, the heart will presently begin to beat again; this is taken to prove that the muscarine acted as a stimulant to the vagus.

Effect of heat and cold on the rate of the heart's contraction.

Cool some normal saline to 5° C. by means of ice; with a pipette flow it drop by drop on to the heart whilst the latter is recording its movements. The rate will be slowed. Let the heart recover its previous rate, then drop upon it water which has been heated to 35° C. The rate will be increased.

Stannius' ligature.¹ No. 1. Arrange the pithed frog to record by the suspension method, and pass a ligature under the aortæ, bring it round to the dorsal side of the heart, and tie a loop; apply this to the line of junction of auricles and sinus, and ascertain that it is placed in contact with the crescent, then draw it tight. The ventricle will stop beating. This arrest always lasts for a considerable time, and may be permanent. Failure is usually due to the ligature not having been placed upon the crescent. 24

Affix the light electrodes as for crescent stimulation only in this case, against the ventricle itself, and arrange to stimulate with single shocks. With a sufficient stimulus, the heart will respond with a single contraction at each stimulus.

Latent period. Place the drum contact in P circuit, drum at a moderately fast speed. Inscribe a 1/10 second time tracing on the paper. Bring the recording point into contact with the paper for one revolution of the drum only at a time. Mark the point at which the stimulus was thrown in. Measure the duration of the period, and compare it with that already obtained with striped muscle.

Cardiac tetanus. After concluding the last experiment, attempt to induce tetanus by stimulating the ventricle with interrupter shocks. Cut out the drum contact and connect the interrupter in the P circuit.

It will be found that the most rapid succession of stimuli will only yield an irregularly continued contraction, but so far incomplete that individual twiches are still represented upon the curve.

¹ Stannius' ligature. No. 2 is applied in a similar manner to the line of junction of the auricles with the ventricle. It is followed by a revival of the ventricular beats the auricles, however, remain at rest.

25 Effect of extract of Suprarenal Capsule on the flow through the blood vessels.

Required :—Glass aortic canula for the frog, connected by a rubber tube 15^{cm} long to a glass funnel; a 50^{cc} measure with a funnel and a retort stand.

Pith the frog and plug the opening.

After exposing the heart through a window in the sternum, introduce the canula into the left aorta and tie it in. Ligature the right hand one.

Incise the sinus so that the fluid may pass freely from the veins.

The frog is to be suspended by its head with threads attached to the ring of a retort stand, and with its legs hanging into the funnel in the mouth of the glass measure.

The funnel, with rubber tube attached and closed with a clip, is supported on another ring of the retort stand on a level with the frog's head. Fill it and the canula with normal saline and connect them, being careful to exclude air bubbles.

The saline solution is next caused to flow through the vascular system of the frog, and the quantity which passes collects in the measure.

The height of the fluid is read off at short intervals (1 to 3 minutes), and is recorded in a tabular form in your note-book.

After a constant rate of flow is established, in from 5 to 10 minutes, substitute suprarenal extract for the saline.

Detach the rubber tube from the canula, empty, and fill the funnel and tube with the extract; connect again to the canula and continue the observation.

A decrease will indicate obstruction to the flow due (Oliver and Schäfer) to contraction of the small arteries.

VISION.

Field of vision. *Perimeter*. The meridional rays represent an hemispherical surface in space.

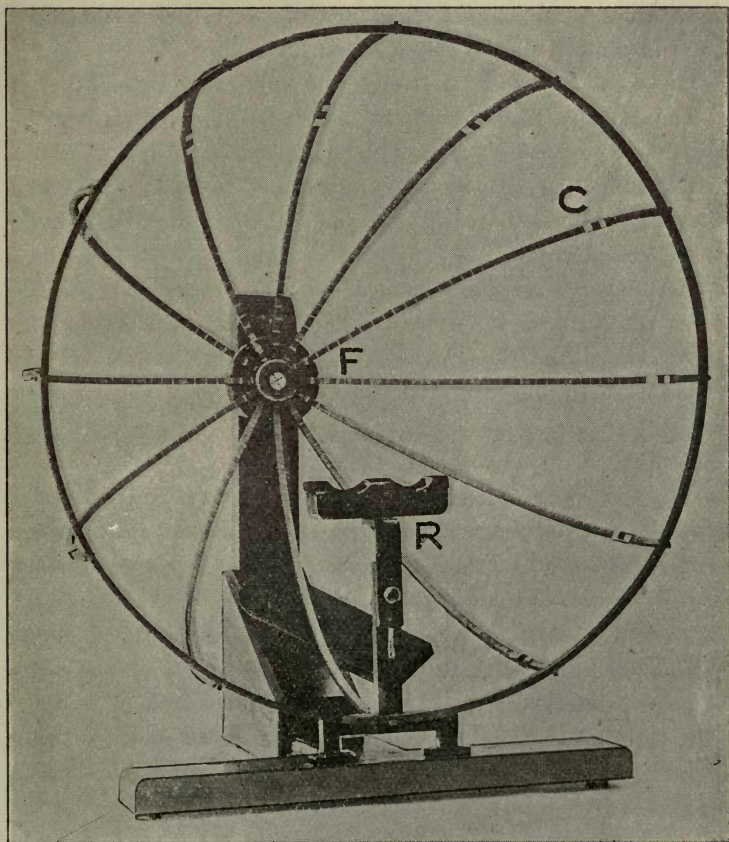

FIG. 51. Perimeter.

They are divided into degrees, and each carries a cursor **C** bearing a piece of white or coloured paper.

The operation is to be conducted with movable lights in a darkened room.

The subject throughout the observation looks directly with one eye at the point of fixation **F**, which is a mirror with cross lines. He knows that his eye is centred when the cross is centred in the reflection of his pupil.

His chin must rest on **R** (suitably adjusted for height).

The cursors are moved in succession from the equator towards **F** by the observer until just visible to the subject.

Determine successively the outlines of the fields of the two eyes for white, red, green, and blue and transfer the results to a printed chart.

Remember that the point of fixation corresponds to the fovea centralis of the retina. The retinal image of the field is reversed in all directions.

Compare the fields of the two eyes.

27 Examination of the interior of the eye. *The ophthalmoscope.*

Light entering the eye is reflected from the retina in the same direction as that from which it entered. You cannot, therefore, see into another person's eye without employing some artifice, because your head intercepts the light.

Artificial eye:—A round (pill) box of about 22^{mm} depth, blackened internally, in the lid of which is a lens with a principal focus of the same length as the depth of the box. The bottom of the box represents the retina; it has some printed matter upon it, and three small apertures through it, placed 1.5^{mm} from each other. The latter can be blocked at will with a piece of black card, so that the apertures appear as black dots when viewed from the front.

Set up the model in a darkened room with the lens towards you and on a level with your eye.

Direct method of using the ophthalmoscope. First, with the apertures closed, endeavour to look into the eye through the lens, moving your eye and a light in all directions to do so. You will not succeed.

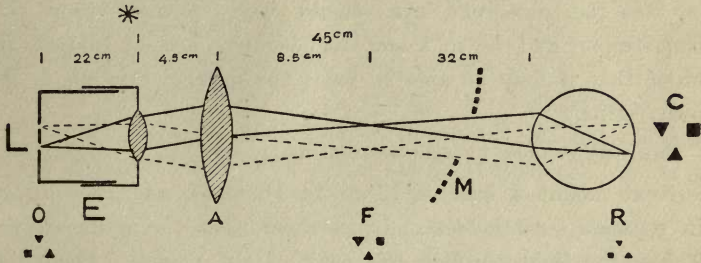

FIG. 52. E Eye model. L Light opposite the apertures in the fundus; the occluding card is not shown. * Lateral position of the light when the mirror M is in use. A Amplifying lens. R Is placed in line with the retina of the observer's eye. O Object, F and R (observer's retinal) real images. C Cerebral inversion of the last. M Position of the mirror; the central aperture of which is exaggerated.

Secondly place the light behind the model, open the apertures, and on looking into it you will see them and their edges distinctly, the apertures being now radiant points of light. Vision will be most distinct at a short distance from the model. This corresponds to the direct method of using the ophthalmoscope.

Now close the apertures, place the light on one side of the model and hold the mirror of the instrument in front of and close to your own eye, look through its central aperture and at a distance of about 7^{cm} direct light into the model. The fundus and the points previously visible because they emitted light are now seen because they reflect light in the required direction. The mirror enables you to get over the

difficulty produced by the interposition of your head in the path of entering rays. Is the image erect or inverted?

Again illuminate the eye from behind, with the apertures open, and hold a white screen in front of the model, so that the emergent rays shall fall upon it. Note that the light does not come to a focus at whatever distance the screen be held. The rays practically emerge parallel. In consequence of this the observer's eye should have normal vision (be emmetropic) and be in a state of negative accommodation, in order that it may be able to focus the parallel rays on to its own retina.

Indirect method of examination (Fig. 52).

Next mount a lens of 12 to 14 D. focus, and the mirror in separate cork holders. Level them with the artificial eye. Throw the light through the back of the model. Place the lens 4.5 to 5^{cm} in front of the latter and look at its interior. The apertures will be seen through the lens, but you will have to place yourself some distance away (40 to 50^{cm}) from the model in order to see them distinctly.

Then follow the behaviour of the light with the screen. A sharp image (inverted) of the apertures in the fundus will be formed at some 8 to 10^{cm} from the lens. The rays which form this image, on being traced beyond it, diverge into expanding cones, and these gaining access to your eye are brought to a focus upon your retina, and there form another image (erect). The latter is, however, interpreted as an inverted image by the brain, and appears projected at about 30^{cm} (12 inches) from the observer.

Close the apertures in the fundus, place the light on one side of the model, and adjust the mirror so as to illuminate the fundus; the black spots and the type will be seen inverted and enlarged.

The lens should be moved to and from the eye until the edge of the pupil falls beyond its margin; it should also be slightly inclined from the perpendicular in order to prevent the disturbance caused by reflections from its surface.

The two methods should be practised upon the eye of another person.

Accommodation. *Scheiner's experiment.* Prick two holes in a card near each other, so that they fall within the diameter of the pupil, hold the card close to the eye with the holes placed horizontally and look through them simultaneously at two pins stuck vertically into corks (which rest upon a table), the one at 60 cm and the other at 25 cm from the eye in the same line of vision.

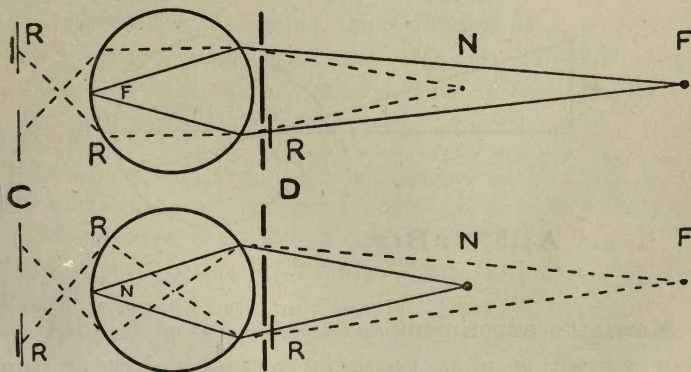

FIG. 53. N and F the near and far pins. • D the card with its two holes in each case. R the blocked aperture. C reversal by the brain. The course of the rays of light from the non-focussed object are represented by dotted lines.

First focus the distant pin, three images will appear. The central one is the single sharp image of the further pin.

Prove that the two side ones are separate images of the near pin, which are insufficiently converged to fall upon the same

part of the retina, as follows:—On blocking the right hand hole in the card, the left hand image will disappear.

The reversal by the brain is to be taken into account in determining upon which side of the retina the disappearance occurs, e.g., the side to which the image is referred in the field of vision.

Repeat the experiment, but on this occasion focus the near image. Three images will again appear, but on blocking the right hole in the card the image on that side disappears. This proves that the eye is over-accommodated for the distant pin, and that in consequence the rays must have crossed in front of the retina.

- 28 **Listing's diagrammatic eye.**¹ Make use of the rule of three formula given in the figure (Fig. 54) in the following calculations:—

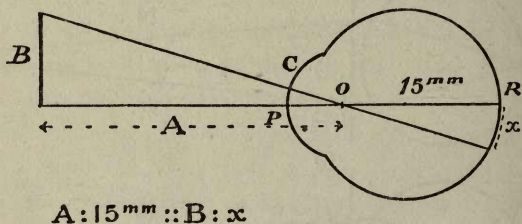

FIG. 54.

Marriott's experiment and measurement of the blind spot. Seat yourself at arm's length in front of a sheet of paper pinned to a wall (drawing board). Mark a spot straight

¹Accommodation and refraction of the eye. (Donders. New Sydenham Society, 1864.)—"For the ordinary eye we substitute one with a cornea, whose radius of curvature is only 5 mm, while behind this is merely vitreous or aqueous humour, without crystalline lens, and with a length of visual axis of 20 mm. In such an eye retinal images would have the same magnitude, the same distinctness, and the same position which they exhibit in the emmetropic eye, with its cornea of nearly 8 mm radius of curvature, its crystalline lens of a little more than 43 mm, focus distance, and its visual axis of a little more than 22 mm, and it can, therefore, really be substituted for this last."

before you and look at it fixedly with one eye (the disengaged eye being closed), then carry the point of a pencil outwards from the marked spot until it passes out of view; mark where this occurs.

Define the blind area in all directions; the beginning of the large vessels may be also noted.

Measure the diameter of the outline thus obtained, and the distance of the paper from the eye, and calculate the size of the retinal image from the reduced eye.

Discriminative power of the eye for detail. Place a card on which parallel lines 1 mm thick are ruled at intervals of 1 mm from each other upon a well illuminated wall, and measure the greatest distance at which you are able to recognise the lines distinctly from each other. By means of the reduced eye, determine their distance from each other in the retinal image. Compare the ascertained intervals with the distance which separates the outer segments of the cones from each other in the fovea centralis. (4μ).

Periodic stimulation of the retina with white light. The experiments are performed with discs of cardboard divided into differently proportioned white and black sectors, &c. The collaborator rotates the disc, whilst the observer stations himself facing, and at a distance of about 2.5 metres for a disc of 20 cm diameter. Or the observer looks at the reflection of the disc in a mirror at half the distance. He can then operate the discs himself.

1. White and black hemidisks. Rotate at a gradually increasing speed; just before the sensation becomes fused into a silver grey there is a marked period of flicker.

2. A sixth sector white. Rotate slowly at rather more than one turn a second; follow the retreating edge of the

black; a slight radial shadow will be seen within the white (Charpentier). Under very favourable conditions a second and even a third may be observed.

This effect is ascribed to the oscillatory response of the retina to the stimulus.

3. The spectrum top of Bentham. The white hemidisc is divided into four equal sectors; in each one of these a set of concentric lines is described, in the first sector near the periphery, in the second a quarter diameter nearer the centre, and so on for the remaining sectors.

Observe the colour effects produced on rotating the disc at a medium speed; the effect is reversed when the direction of rotation is changed.

The illumination should not be too brilliant. A slightly yellow light is frequently more efficient than white light in producing the effect.

THE CUTANEOUS SENSES.

The subject keeps his eyes closed and indicates to the observer the nature and intensity of the sensation produced. It is sufficient in the following exercises to detect a marked difference in any one sensation; the exact evaluation of the difference need not be attempted.

Tactile and pressure senses. Explore the lips, skin of the face, dorsum of the hand and forearm with von Frey's hair æsthesiometer.

For the least perceptible stimulus the human hair, and for less sensitive parts the horse hair, instrument is used.

A given length of each hair is capable of exerting a certain maximal pressure, which can be evaluated in grammes per square centimeter. For convenience the hair is placed within a sheath, by means of which the exposed length of hair can be varied, and with it the pressure which can be exerted.

The after sensation is frequently very marked, the sensation lasting some time after the stimulus is removed.

Minimal stimuli applied to the face produces tickling instead of a markedly tactile impression.

The tactile sensation passes into a feeling of pressure with an increase of the stimulus. The horse hair may even induce pain.

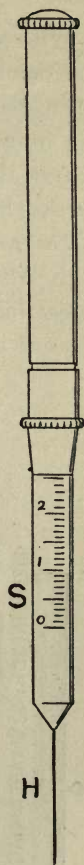

Fig. 55.
Æsthesio-
meter.
H Human
or horsehair
S Movable
sheath by
means of
which the
length of
hair ex-
posed may
be varied.

With a pair of dividers find the least distance at which the points can be distinguished as two separate impressions when they are applied simultaneously to the skin. Measure the intervals with a millimetre scale.

Test the tip of the tongue, the skin of the lips, forehead, cheeks, hand, forearm, and back of the neck.

The pain sense. Explore the skin of the hand and forearm with Aly's instrument, which consists of a long needle kept projecting from a sheath by means of a light spring. The pressure which is required to produce a feeling of pain is

read off in grammes upon the graduations on the sheath. The camel hair brush at the other end of the instrument is the common clinical means used to detect diminution of sensibility.

By arming the end of the needle with a small piece of cork it can be used for exploring the pressure sense.

Use the von Frey human hair for exploring the conjunctiva for the pain sense.

Hot and cold sense. Use Goldscheider's metal rods (1 cm thick by 9 long). Explore the back of the hand and forearm by touching the surface lightly with the tip of the rod.

First explore for spots, which at once respond by a feeling of cold.

The metal is usually cold enough at ordinary temperatures, and need not therefore be specially cooled.

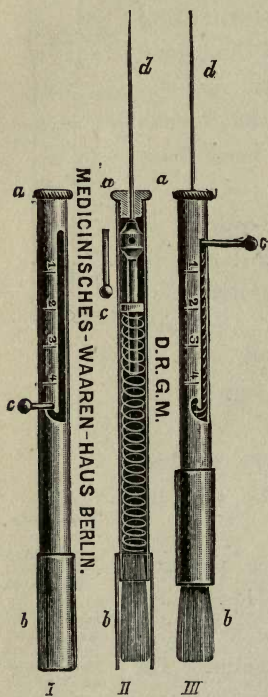

FIG. 56. Aly's Æsthesiometer.

With a rod heated in water at 70° C. explore for the hot spots.

In both cases mark the spots where the two senses are most acute, and those where a definite absence of both can be detected.

APPENDIX TO THE EXPERIMENTAL SECTION.

Dissection for exposing the Vagus nerve in the frog.

The pithed frog is laid upon its back on the frog plate, is freely incised mesially through skin and then sternum.

The edges of these are drawn widely apart and kept so with threads pinned to the plate. Restraining connective tissue is divided close to the bone, and the attachments of the pericardium are carefully removed around the heart.

A glass tube, 1.5 to 2^{cm} wide according to the size of the frog, is passed down the œsophagus as far as it will go; this stretches the neighbouring structures.

From the angle of the jaw a somewhat deeply situated and thin muscular band, composed of the petrohyal muscles, extends to the region of the heart (strictly speaking, to the hyoid cartilage).

The Vagus, dividing into its cardiac and laryngeal branches, lies beneath the lower edge of this muscle, and must be carefully sought for, as it is usually very small.

The petrohyals lie above the pronounced levator anguli scapulæ muscle that slants down and outwards to the upper limb.

The petrohyals are crossed by two distinct nerves.

One, the glossopharyngeal, sweeping in a curve from the angle of the jaw, passes upwards to disappear amongst the muscles of the floor of the mouth.

The other, the hypoglossal, usually piercing the levator anguli scapulæ curves inwards in the same direction as the first, to disappear nearer the middle line.

The Vagus must be carefully separated from the muscle for as long a distance as possible. A moistened thread is passed beneath it and is tied near the angle of the jaw. The nerve is cut between the jaw and the ligature, and it can then be raised clear of its surroundings for the application of the electrodes.

Du Bois Reymond's compensation method for the measurement of the electromotive force in muscle and nerve. Establish the connections as shown in the figure, with one gap of the metre bridge¹

¹Instead of the metre bridge, the zig-zag resistance, fig. 46, pg. 234, may be employed, as its wire is longer and thinner, and smaller differences can be more readily detected by its means. This wire is of about 20 ohms resistance and is divided into 10 parts, fractions of which can be measured with a foot rule. The portions in contact with the pulleys around which the wire is stretched must be omitted from the length measured.

open. Place the rider against the bridge wire a few cms from its extremity a and turn the commutator into the position in which the G deflection is smallest,

then move the rider J until a balance is obtained, e.g., the spot of light on the G scale stands at Zero. This will be very near the left end. This fraction a of the wire compared with its total length gives the E.M.F. of the tissue, &c., in terms of a Daniell (1.1 volt).

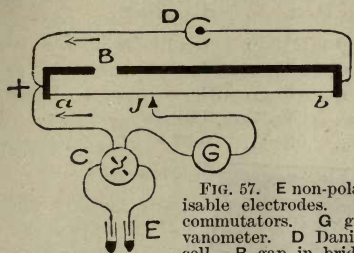

FIG. 57. E non-polarisable electrodes. C commutators. G galvanometer. D Daniell cell. B gap in bridge bar. J rider. a and b

on the bridge wire, the length of which is 1000 mm.

As 1000 is to aJ so is 1.1 (volts) to x = volts of the tissue.

Measurement of resistance with the bridge box. When c and d are in the same proportion as a and b there is no deflection of the galvanometer. This condition is sought for and is known as the zero method.

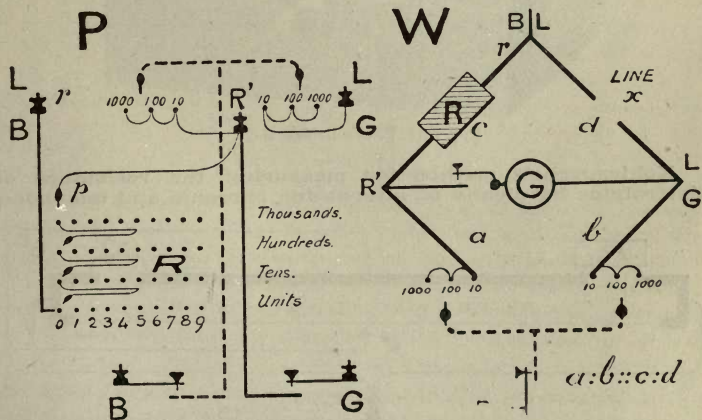

FIG. 58. Diagram of Paul's resistance box and Wheatstone's bridge. P Shows the connections of the terminals in the actual box and W the same transferred to the usual diagram of Wheatstone's bridge. B Battery. G Galvanometer. L Line or the points to which the unknown resistance X is to be connected. B Spring key which on closure leads to the proportional arms. r to R the variable resistance R arranged in four rows; the movable plugs p are connected for zero or no resistance in diagram P.

Measurements are made as follows:—*c* being found by trial.

As	<i>a</i>	is to	<i>b</i>	so is	<i>c</i>	to	<i>d</i>	ohms.
,,	10	,,	10	,,	3	,,	3	
,,	10	,,	100	,,	3	,,	30	
,,	10	,,	1000	,,	3	,,	300	
,,	100	,,	10	,,	3	,,	0.3	
,,	1000	,,	10	,,	3	,,	0.03	

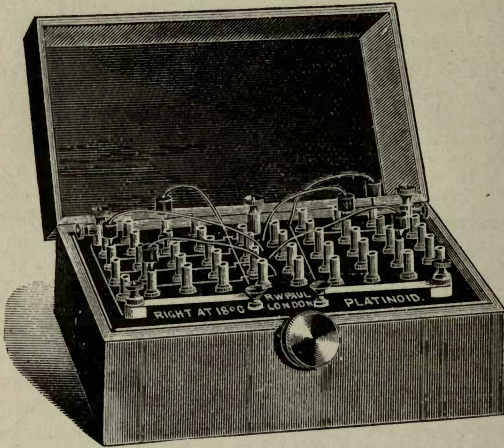

FIG. 59. Paul's Bridge Box.

Kohlrausche's method for measuring the resistance of electrolytes by means of alternating currents and telephone.

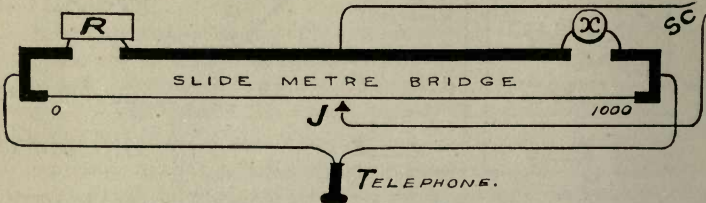

FIG. 60. Kohlrausche's Method.

Insert a variable resistance *R* (of bridge box) into one gap of the metre bridge, and the unknown resistance into another corresponding one at the other end. Connect the telephone to opposite ends of the bridge wire, and the wires from the *S* coil of an inductorium to the centre of the copper bars on one hand and the rider *J* on the other. Or the bridge box may be employed instead by substituting *SC* for the battery *B*, and the telephone for the galvanometer *G*.

Set J at 500, hold the telephone to your ear (two telephones are better), and adjust R until the sound fades to the lowest the resistance will permit, e.g., find the two resistances between which there is silence; then move J until two points are again found between which silence occurs.

Then, as the lengths of wire on each side of J are to each other, so is R to X .

The inductorium must be placed in an adjacent room so that it be not directly audible, and the S coil must be adjusted to give a well marked sound in the telephone. If two telephones are employed, one to each ear, a collaborator will be required to adjust the resistances.

Measurement of resistance of a galvanometer or cell by the half deflection method.

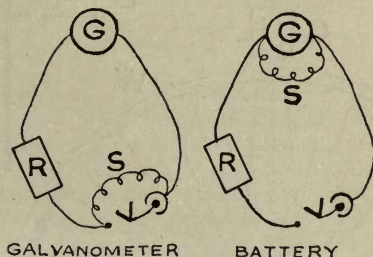

FIG. 61.

(a) *Galvanometer*:—Battery (1 Daniell) short-circuited on closure of key through the shunt wire S . R variable resistance. G the galvanometer. Vary S (No. 18 wire, 25 to 30 cm long, with G about 6000 ohms) until the deflection of the galvanometer is about 20 cm on the scale.

Then increase R until the deflection is reduced to one-half. The added resistance R will equal the resistance of the galvanometer.

(b) *Battery*:—Transfer the shunt wire S to the terminals of the galvanometer (No. 14 wire, a straight piece) and adjust to the same deflection as before. Increase R until half the deflection is obtained. R will represent the resistance of the battery.

It is best to take an odd number of batteries, 5 or 7 coupled end on, with an even number coupled in opposition—zinc to zinc, so that there will be E.M.F. only from one cell in the G circuit.

The total resistance divided by the number of cells gives the average resistance for one.

Power distribution for actuating *recording cylinders* in the Experimental Laboratory, Physiological Department, Yorkshire College.

A water motor (Chicago stop) is geared by means of a cord *M* to a 54-inch bicycle wheel *W*. *G* is a pressure gauge on the motor side of the tap *T*, which leads by a short branch from a 1½-inch main direct

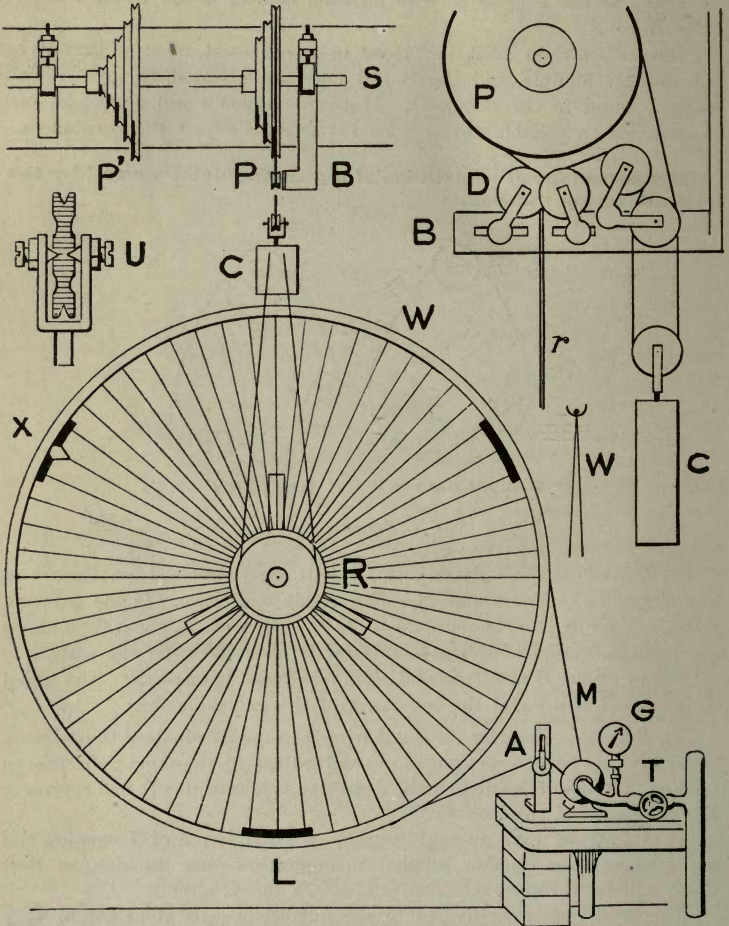

FIG. 62.

from the supply in the street. **A** adjustable pulley for regulating the tension of the cord. The wheel is set to run at one revolution a second for ordinary class purposes, and is geared to the shaft **S** by means of a cord which connects the reducing pulley **R** to the driving pulley **P**. The cord is guided in the required change of direction by a system of guide pulleys **D**, shown in side view in the right-hand figure. By means of these the cord is also taken to the counterpoise **C**, which maintains an equable tension. Cord **r** to cone **R** on the wheel; **W** marks the position of the latter in section.

The shaft **S** is of 1-inch steel tubing, carried on Bown's ball bearings at intervals of 30 inches. Upon it speed cones **P'** are threaded, one for each recording drum in the laboratory.

Each speed cone is 15 inches in diameter, and is built up of mahogany. It turns once in $1\frac{1}{2}$ seconds when **W** is making one turn a second. The cord connection to a drum is shown in Fig. 34 I, where the tension pulley **L** and guide **K**, immediately over each work table, are also seen.

As all the rolling parts are either borne upon centres **U** (a pulley shown in section), or in ball bearings, friction is reduced to a minimum; and as, furthermore, the wheel is loaded with lead **L**, and the cylinder cones on the tables are heavy (Fig. 34 D), these together form a system of fly wheels which produce great steadiness of running.

With a water pressure of 25 pounds at the motor, a very constant rate of movement is obtained, which is not appreciably affected by starting and stopping the drums.

Under a fortieth of a horse power is required to drive the whole apparatus in the laboratory.

The speed of **W** is ascertained by counting its revolutions by a watch, for which purpose a white mark **X** serves as a guide.

The wheel is fixed to the wall by a three-branched bracket, seen behind **R**, and is mounted upon it in the same way as the pedal of a bicycle on its crank.

Simplicity and economy in working are salient features of this arrangement.

INDEX.

	PAGE		PAGE
Acetone	128, 158	Blood flow	144
Adenoid tissue	36	,, Hayem's fluid	61
After-hardening	18	,, plasma	146
,, load, muscle	220	,, pressure... ..	243
Albumin, acid	134	,, serum	145
,, alkali	133	,, spectra	152
,, egg	128	,, sugar in... ..	147
,, serum	145	Bone, dry	39
,, estimation	170, 145	,, growing head	41
Albuminuria	170	,, shaft	42
Albumoses	134	,, softened	40
Albumosuria	171	Bread	139
Amalgamation, zinc	184	Bronchus	65
Amæboid motion	59	Brownian motion	12
Aorta	56		
Apparatus for Histology	4	Capillary electrometer	237
,, Chemistry	119	Carbohydrates	121
,, Experimental	181	,, table of tests	135
Artery and Vein	55	Carbol-iron test	142
,, ,, distended... ..	55	Cardiac tetanus	249
Auerbach's plexus... ..	73	Cardiogram	241
		Cartilage, elastic	38
Bacteria	12	,, hyaline	37
Balsam, mounting	13	,, white-fibro	38
Barfoed's test... ..	122	Caseinogen	136
Bichromate cell	185	Cerebellum	95
Bile	155	Chronogram	267
Blood	144	Circulation, frog	62
,, amphibian and human	57	Cochlea	104
,, cells, red	58	Commutator	186
,, ,, counting	30	Connective tissue	33
,, ,, white	59	Conus medullaris	94
,, coagulation	146	Cotton fibre	11
,, films	60	Cornea	103

	PAGE		PAGE
Corneo-sclerotic junction ...	102	Fermentation test	175
Corpora quadrigemina	96	Fibrin, structure	61
Cover-glass, application ...	11	Flesh	138
,, cleaning	7	Flour, wheat	139
Cream	137	Frog, dissection, dorsal ...	194
Creatinin	167	,, ,, ventral ...	16
Crura cerebri	96	,, heart	245
Curara experiment	223	,, ,, current	237
Cutaneous senses	259	Galvani's experiment	198
Cystin	172	Galvanic cell	183
Daniell cell	184	Ganglion, dorsal root	92
Decalcification	19	,, sympathetic	92
Demarcation current	236	General stand	209
Description of object	11	Glands, pancreas	77
Dextrin	125	,, parotid	76
Dextrose	121	,, submaxillary	77
Digestion, acids in	142	,, injected	77
,, gastric	140	Glisson's capsule	78
,, pancreatic	143	Glycogen	126
Drawing	8	,, in cells	79
Elastic tissue	35	Glycosuria	172
Electric style	209	Grove cell	185
Electrodes, hand	187	Guaiacum test... ..	137
,, non-polarisable ...	232	Hæmocytometer	148
Electrotonus	231	Hair, follicle	85
Embedding, celloidin	26	Hæmoglobin, crystals	62
,, gum	25	Hæmoglobinometer	151
,, paraffin	20	Hæmoglobinuria	171
Emulsification... ..	127	Hæmolymp gland	87
Endothelium	28	Hæmin crystals	62
Epithelium, ciliated	31	Hayem's fluid	61
,, chloroform	32	Heart, apex beat	240
,, isolated	31	,, frog	245
,, columnar	30	,, ,, atropine	248
Fallopian tubes	100	,, ,, crescent (vagus) ...	247
Fat	127	,, ,, heat and cold	248
,, in milk	137	,, ,, recorder	246
Fatty tissue	36	,, ,, latent period	249
Fehling's test	122	Helmholtz side wire	192

	PAGE		PAGE
Induction, current... ..	188	Measuring, microscopical ...	8
" " extra ...	191	Medulla oblongata (Bulb) ...	95
" " make and		Microscope, student's	5, 6
break	198	" care of	5, 6
Inductorium	188	Microtome, ether	25
Interrupter shocks	191	" horse shoe	23
" " strength of		" rocking	23
	189, 201	Midbrain	96
Intestine, fat absorption ...	73	Milk	136
" large	74	" globules	13
" small	73	Millon's test	130
" " injected ...	74	Mitosis	29
Irrigation... ..	12	Moore's test	122
Isometric contraction	219	Mucin	169
Isotonic " 	213	Muscle, cardiac	47
Keys, electrical	185	" chamber	205, 209
Kjeldahl, for nitrogen	164	" elasticity	212
Kidney	80	" excitation	223, 201
" injected	81	" extensibility	212
" isolated tubules ...	82	" fatigue	217
Labelling specimens	7	" heat and cold	221
Lactose	123	" latent period	213
Legal's test	128	" load on	218
Leclanché cell... ..	185	" non-striped	47
Lens, fibres	103	" spindles	50
Ligamentum nuchæ	35	" striped	48
Linen fibre	12	" tongue	63
Listing's reduced eye	256	" nerve preparation ...	196
Liver cells	78	Myograph... ..	205, 209, 229
" ducts	79	Myosin	132
" glycogen	79	Myosinogen	138
Lung, fetal	67	Nail	85
" injected	67	Nerve cells	54
" silvered... ..	66	" change in excitability	203
Lymph gland	36, 86	" excitation	201
" injected	86	" medullated	51
Mammary gland	100	" osmic, teased	51
Marrow	43	" " section	53
		" silvered	52
		" non-medullated	53

	PAGE		PAGE
Neuroglia... ..	97	Rennet	136
Newt's moult	13	Resistance, electrical ...	183, 263
Nervous impulse	199, 226	Respiratory system	65
		Retina	103
		,, illuminated	104
		,, periodic stimulation ...	257
Oesophagus	70	Rheoscopic limb	199
Olfactory epithelium	101	Rheocord	233
Ophthalmoscope	253		
Optic papilla	103	Saliva	140
Ovary	99	Saponification	127
Oxalate of lime	169	Scheiner's experiment	255
		Sections, cutting, celloidin ...	26
Pain sense	260	,, gum	25
Palate, soft	69	,, paraffin	20
Paradoxical contraction ...	200	,, flotation on water ...	13
Paraffin, mounting from ...	14, 15	Semi-circular canals	105
Parathyroid body	88	Serum proteids	145
Pendulum myograph	229	Sinus of Valsalva	56
Pflüger's law	233	Skin	84
Pettenkoffer's test... ..	155	Slides, to clean	7
Perimeter... ..	251	,, to finish off	7
Peyer's patch	74	Spermatogenesis	98
,, injected	74	Spleen	87
Phenol. hydrazin test	122	,, injected	88
Phosphoric acid	159, 137	Spinal cord	91
,, vol.	161	,, regional	94
Pons Varolii	96	Stannius' ligature	249
Piotrowski's test	130	Starch granules	12
Pituitary body	89	,, soluble	125
Polarisation	183	,, neutral salts on ...	125
Preserving by injection ...	17	,, digestion	125, 143
Prostrate	98	Staining on the slide	13
Proteids, reactions... ..	129	,, in bulk	19
,, table of tests	135	Stomach	70
Pulse tracing	242	Strassburg's test	155
		Sugar, cane	123
		Suprarenal body	89
		,, effect on vessels ...	250
Quadriurates	169		
		Temperature, coagulation ...	132
Reagents, chemistry	59		
Recording arms	206		
,, cylinder	205		
,, covering	206		

	PAGE		PAGE
Tendon	34	Urine, test table	177
Testis	98	,, salts	158
Tetanus	216	Urinary bladder	83
Thyroid	88	Unipolar stimulation	203
Time distribution board ...	208	Uterus	100
Tongue	68	Vagina	100
Tonsil	86	Vas deferens	98
Tooth, adult	44	Ventricle, structure	57
,, growing	45	Veratria, muscle	224
Touch	259	Vermiform appendix	74
Trachea	65	Wheatstone's bridge	263
Tracings, fixing	210	Whey	136
Urates	168	Wool fibre	12
Urea	161	Work table histological ...	7
,, estimation	162	,, ,, experimental ...	204
Ureter	82	Xanthoproteic reaction ...	129
Uric acid	167		
Urine	157		
,, abnormal	170		

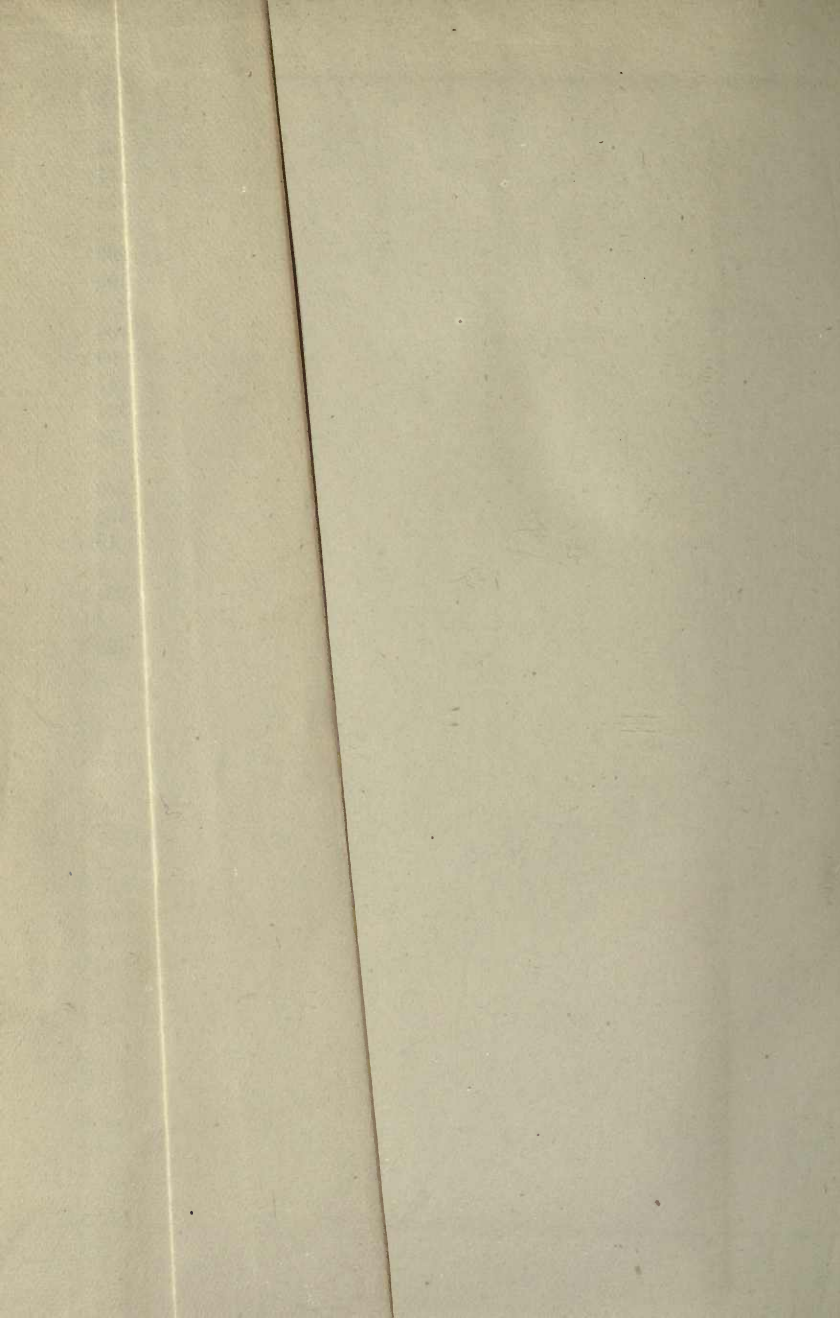

UNIVERSITY OF CALIFORNIA MEDICAL SCHOOL LIBRARY

THIS BOOK IS DUE ON THE LAST DATE
STAMPED BELOW

14 DAY

RETURNED
MAY 17 1964

MAY 14 1964

PRESENTED TO

*Library Med. Dept. University
of California, San Francisco,
Cal.*

BY

The Association of Medical Librarians

No. 366.

206

UNIVERSITY OF CALIFORNIA MEDICAL SCHOOL LIBRARY

